

Thermostate und Thermoschalter | *Thermostates and Thermoswitches* | *Thermostates et Thermocontacts*



Pkw Katalog | Passenger Cars Catalog | Catalogue voiture



4116.87D1

Typen-Nr.
Type no.
N° de type

Öffnungstemperatur
Opening temperature
Température d'ouverture

Dichtungsvariante
Gasket type
Variante de joint

Bauprinzip 3-Teller Thermostat | Design-Principle 3 Plate Thermostat | Explication du code article

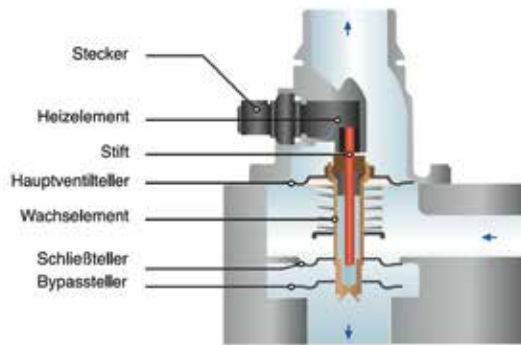

Funktionsweise Kühlwasserthermostat | Working Principle Cooling Water Thermostat | Principe Fonctionnement Thermostat de refroidissement

Warmlaufphase: Der Motor befindet sich nach dem Start in der Warmlaufphase. Der Thermostat ist geschlossen und das Wasser zirkuliert über den inneren Motorkreislauf.

Warm up period: The engine enters the warm-up as soon as it is started. The thermostat is closed and the water circulates through the inner engine circuit.

Phase de mise en action: Après le démarrage, le moteur se trouve en phase de mise en action. Le thermostat est fermé et l'eau circule via le circuit intérieur du moteur.

Regelbetrieb: Die Wassertemperatur erreicht die Öffnungstemperatur des Thermostaten. Eine kleine Menge des Volumenstromes wird über den Kühler geleitet.

Normal operation: The water temperature reaches the opening temperature of the thermostat. A small portion of the volumetric flow is fed through the radiator.

Fonction de régulation: La température de l'eau atteint la température d'ouverture du thermostat. Une petite quantité du débit volumétrique est dirigée via le radiateur.

Heißbetrieb: Der Bypass wird verschlossen. Der ganze Volumenstrom wird über den Kühler geleitet.

Full temperature operation: The bypass is sealed. The full volumetric flow is fed through the radiator.

Fonctionnement à chaud: Le by-pass est fermé. L'ensemble du débit volumétrique est dirigé via le radiateur.

Nachheizphase: Der Thermostat erreicht seinen maximalen Hub bei besonderen Betriebszuständen wie z.B. beim Nachheizen.

Reheating phase: Maximum thermostat displacement occurs under special operating conditions such as reheating.

Phase de post-chauffage: Le thermostat atteint sa température de réaction maximale lors d'états de fonctionnement particuliers, tels que le post-chauffage.

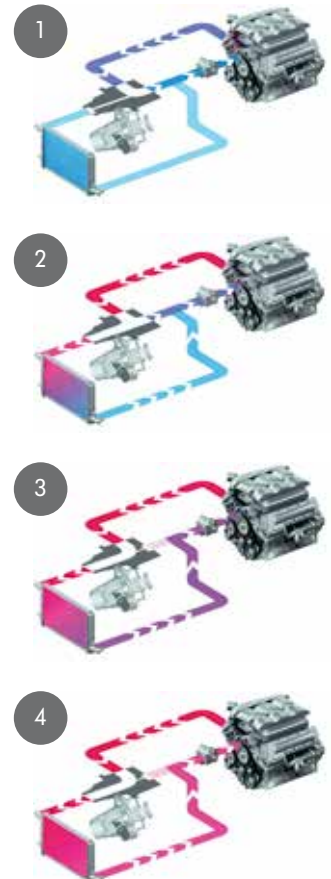

Inhaltsverzeichnis | Contents | Sommaire

Thermostate <i>Thermostats</i> <i>Thermostats</i>	1 - 218
Thermoschalter <i>Thennoswitches</i> <i>Thennocontacts</i>	220 - 282
Vergleichsliste <i>Cross references</i> <i>Liste de correspondances</i>	284 - 322
Dichtungszuordnungsliste <i>Listing of gaskets</i> <i>Liste de joints</i>	324 - 327
Typenersatzliste <i>Supersession list</i> <i>Liste des remplaçants</i>	328
Haupteinbaumaße <i>Main assembly dimensions</i> <i>Dimensions principales de montage</i>	329 - 340

Hersteller	Thermostat	Schalter	Hersteller	Thermostat	Schalter
ALFA ROMEO	2	220	MG	98	
AUDI	5	222	MINI	99	
AUTOBIANCHI	10	227	MITSUBISHI	100	
BMW	11		NISSAN	107	
CHEVROLET	20		OPEL	114	245
CHRYSLER	23		PEUGEOT	124	251
CITROËN	24	228	PIAGGIO	132	
DACIA	32	229	PLYMOUTH	133	
DAEWOO	35	230	PORSCHE	134	253
DAF	37		PROTON	136	
DAIHATSU	38		RENAULT	137	254
DODGE	41		ROLLS-ROYCE	155	
FIAT	42	231	ROVER	156	
FORD	51	238	SAAB	158	256
HONDA	59		SEAT	160	257
HYUNDAI	64		SKODA	165	261
INNOCENTI	66	239	SMART (MCC)	168	
IVECO	67		SSANGYONG	169	
JAGUAR		240	SUBARU	170	
JEEP	69		SUZUKI	174	
KIA	70		TALBOT	178	262
LADA	71	241	TOYOTA	179	
LANCIA	72	242	VAUXHALL	189	263
LANDROVER	75		VOLKSWAGEN	198	269
LEXUS	76		VOLVO	211	
LIGIER	77		WARTBURG	218	281
MAZDA	78		ZASTAVA		282
MERCEDES BENZ	82				

BorgWarner Thermal Systems ist ein führender Lieferant für Wärmemanagement-Systeme.

BorgWarner Thermal Systems is a leading supplier of components and systems for thermal management.

BorgWarner Morse TEC ist weltweit führend bei der Herstellung von Kettensystemen und -komponenten für Ventilgetriebe, Automatikgetriebe und Vierradantriebe.

BorgWarner Morse TEC is the global leader of automotive chain systems and components for engine timing, automatic transmission and four-wheel drive applications.

BorgWarner TorqTransfer Systems ist ein weltweit führender Hersteller von Drehmomentverteilungs- und -management-systemen für Fahrzeuge mit Vierradantrieb.

BorgWarner TorqTransfer Systems is a leading manufacturer of torque distribution and management systems for four-wheel drive vehicles.

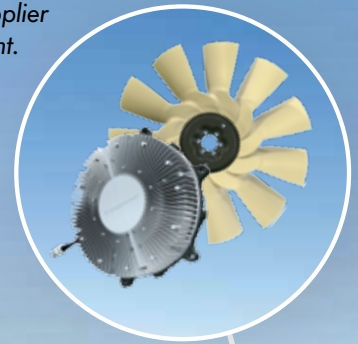

Innovationen für den Aftermarket. Vom Produktführer im Antriebsbereich.

In einem Punkt sind sich viele Automobilhersteller auf der ganzen Welt einig: Wenn sie die strengsten Abgasnormen erfüllen und Bestmarken beim Verbrauch erzielen wollen, wenn sie enorme Leistungsfähigkeit mit hoher Zuverlässigkeit verbinden wollen, dann führt an BorgWarner kein Weg vorbei. Als Produktführer im Antriebsbereich unterstützen wir die Automobilindustrie dabei, die Fahrzeuggeneration von morgen zu entwickeln. Auch im Aftermarket ist BorgWarner erste Wahl. Und dies nicht nur wegen der schon sprichwörtlichen Qualität unserer Produkte. Sondern auch wegen der Auswahl, Serviceleistungen und Schnelligkeit, die wir unseren Partnern im Ersatzteilgeschäft bieten.

Unsere Lösungen: Präzise, zuverlässig, wirtschaftlich.

Die BorgWarner Business Unit Emissions Systems ist ein weltweit führender Hersteller und Anbieter von modernsten Abgaskontrollsystemen, Zündungstechnik, Dieseltaktstarttechnologie, PTC-Innenraum-Zuheizern und Thermostaten für Personenkraftwagen und Nutzfahrzeuge auf der ganzen Welt. Mit der Wahler Produktpalette, die seit April 2014 zu BorgWarner gehört und in die Business Unit Emissions Systems integriert wurde, vergrößert sich das Portfolio um eine Vielzahl innovativer Lösungen für das Abgas- und Temperaturmanagement moderner Motoren. Wahler wird als Produktmarke im Aftermarket beibehalten.

BorgWarner Turbo Systems ist ein weltweit führender Hersteller von Aufladesystemen für Pkw und Nfz.

BorgWarner Turbo Systems is a leading manufacturer of turbochargers for passenger cars and commercial vehicle markets.

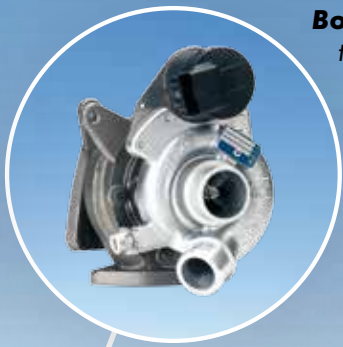

BorgWarner Emissions Systems ist weltweit führend bei der Konstruktion und Lieferung von Abgasrückführsystemen (AGR), Zündungstechnik, Dieselmotorkaltstarttechnologie, Innenraum-Zuheizern und Thermostaten.



BorgWarner Emissions Systems is a leading manufacturer in the design and supply of exhaust gas recirculation (EGR) systems, ignition technology, diesel cold-start technology, cabin heaters and thermostats.

BorgWarner Transmission Systems liefert High-Tech-Komponenten und Systeme für praktisch jeden Automatikgetriebe-Hersteller.



BorgWarner Transmission Systems supplies "shift quality" components and systems to virtually every automatic transmission manufacturer.

*Innovations for the aftermarket.
From the product leader in the field of drive technology.*

Many auto manufacturers all over the world agree on one thing: If they want their engines to meet the toughest emissions standards and break new ground in terms of fuel economy, if they want to combine excellent performance with a high level of reliability, then BorgWarner is the only choice. As product leader in the field of drive technology, we support the automotive industry in developing the vehicle generation of tomorrow. BorgWarner is also the perfect choice in the aftermarket. And not just because of the already legendary quality of our products. But also because of the selection, the range of services and the speed we offer our partners in the spare parts business.

*Our solutions:
precise, reliable, economical.*

BorgWarner's Emissions Systems business unit is a leading global manufacturer and supplier of the latest exhaust gas emissions control systems, ignition technology, diesel cold-start technology, PTC interior heaters and thermostats for passenger vehicles and commercial vehicles all over the world. And with the product range of Wahler, which was acquired by BorgWarner in April 2014 and has been integrated into the Emissions Systems business unit, the product portfolio has been further expanded with a multitude of innovative solutions for the exhaust gas and temperature management of modern engines. Wahler will retain its product brand in the aftermarket segment.

„Meine Wahl? Das Original.“
“My Choice? The Original.”



Thermostate und Thermoschalter

BorgWarner Emissions Systems liefert hochwertige Thermostate und Thermoschalter der Marke Wahler in Erstausrüsterqualität. Sie stehen für einwandfreie Funktion und hohe Zuverlässigkeit. Dank ihres optimalen Wärmemanagements sorgen sie für ein langes Motorleben. Vielfalt nach Maß – BorgWarner hat für alle gängigen Automobilmarken die geeigneten Ersatzteile!

Thermostates and Thermoswitches

BorgWarner Emissions Systems is a provider of Wahler brand thermostats and thermoswitches in OE quality. Our parts stand for proper functionality and outstanding reliability. Thanks to the optimum levels of heat management, they also ensure that engines live on, and on... Diversity made to measure – BorgWarner has the right parts for all current makes and models!

Erst-
ausrüster
Qualität

■ Vielfalt nach Maß

BorgWarner Emissions Systems hat für 62 Automobilmarken die geeigneten Ersatzteile der Marke Wahler!

■ BorgWarner weltweit

BorgWarner ist in allen wichtigen Märkten der Welt mit eigenen Niederlassungen bzw. einem dichten Vertriebsnetz vertreten. Nähere Infos erhalten Sie unter aftermarket.borgwarner.com

■ Service-Produkte inklusive

BorgWarner Emissions Systems kennt die Kundenbedürfnisse und liefert die Original-Thermostate der Marke Wahler immer zusammen mit der passenden Dichtung!

Top OEM-
quality

■ Variety made to measure

BorgWarner Emissions Systems offers suitable Wahler spare parts for 62 automobile brands!

■ BorgWarner worldwide

BorgWarner is represented in all the world's important markets with its own subsidiaries and a dense service network. For more information, visit aftermarket.borgwarner.com

■ Service products included

BorgWarner Emissions Systems knows its customers' needs and always supplies original Wahler thermostats together with the matching gasket!



Neben den Thermostaten umfasst das Produktportfolio auch AGR-Leitungen und AGR-Ventile. Für weitergehende Informationen fordern Sie bitte unseren Katalog Abgasrückführung an. Auf Wunsch erhalten Sie unsere drei Kataloge Thermostate und Thermoschalter für PKW, Thermostate und Thermoschalter für NFZ sowie Abgasrückführung auch in digitaler Form auf unserer Katalog-CD.

In addition to the thermostats listed in this catalog EGR-pipes and EGR-valves complete the product portfolio. Please ask the catalog Exhaust Gas Recirculation for further information. Our three catalogues Thermostates and Thermostitches Passenger Cars, Thermostates and Thermostitches Commercial Vehicles and Exhaust Gas Recirculation are also available in digital form on our catalog CD.

**aftermarket.borgwarner.com
oder Telefon +49 711 3152-0**



ALFA ROMEO
**Motor
Engine
Moteur**
**Ltr.
Ltr.
Ltr.**
**Jahr
Year
Année**
**Einschränkung
Restriction*
Restriction***
**Thermostat
Thermostat
Thermostat**
33

1.3	AR 30168, AR 30502, AR 30586, AR 30587	1.3	1983.06 - 1989.12		4003.86
1.5	AR 30508, AR 30588, AR 30146	1.5	1984.06 - 1989.12		4003.86

75

1.6	AR 06100	1.6	1985.05 - 1989.09		4160.83D
1.8	AR 06202	1.8	1985.05 - 1989.06		4160.83D
2.0	AR 06212	2.0	1985.05 - 1988.10		4160.83D

90

1.8	AR 06202	1.8	1984.10 - 1987.07		4160.83D
2.0 i.e.	AR 01713, AR 06212	2.0	1984.10 - 1987.07		4160.83D

145 (930)

1.6 i.e. 16V T.S.	AR 67601, AR 38201	1.6	1996.12 - 2001.01		410514.88D
1.8 i.e. 16V	AR 32201	1.8	1998.03 - 2001.01		410514.88D
1.9 JTD	AR 32302	1.9	1999.02 - 2001.01		410512.88D
1.9 TD	AR 33601, AR 67501	1.9	1994.10 - 1999.02	Ölkühlung	410692.71D
2.0 16V Quadrifoglio	AR 32301	2.0	1998.03 - 2001.01		410514.88D

146 (930)

1.6 i.e. 16V T.S.	AR 67601, AR 38201	1.6	1996.11 - 2001.01		410514.88D
1.8 i.e. 16V T.S.	AR 32201	1.8	1998.03 - 2001.01		410514.88D
1.9 JTD	AR 32302	1.9	1999.02 - 2001.01		410512.88D
1.9 TD	AR 33601, AR 67501	1.9	1994.12 - 1999.02	Ölkühlung	410692.71D
2.0 16V Quadrifoglio	AR 32301	2.0	1998.03 - 2001.01		410514.88D

147 (937)

1.6 16V T.SPARK (937AXB1A)	AR 32104	1.6	2001.01 - 2010.03		410514.88D
1.6 16V T.SPARK ECO (937AXA1A)	AR 37203	1.6	2001.01 - 2010.03		410590.88D
1.9 JTD	182 B9.000	1.9	2003.03 - 2010.03		410511.88D
1.9 JTD (937AXD1A)	937 A2.000	1.9	2001.04 - 2010.03		410511.88D
1.9 JTD 16V	192 A5.000	1.9	2002.11 - 2010.03		411773.88D ▲
1.9 JTD 16V	937 A4.000	1.9	2003.09 - 2004.09		411773.88D ▲
1.9 JTD 16V	192 B1.000	1.9	2004.10 - 2010.03		411773.88D ▲
1.9 JTDM 16V	937 A5.000	1.9	2005.07 - 2010.03		411773.88D ▲
1.9 JTDM 16V	937 A6.000	1.9	2008.06 - 2010.03		411773.88D ▲
1.9 JTDM 8V	937 A3.000	1.9	2005.07 - 2010.03		411773.88D ▲
2.0 16V T.SPARK (937AXC1_)	AR 32310	2.0	2001.01 - 2010.03		410514.88D

155 (167)

1.9 TD (167.A3)	AR 67501	1.9	1993.04 - 1997.12	Ölkühlung	410692.71D
-----------------	----------	-----	-------------------	-----------	------------

156 (932)

1.6 16V T.SPARK	AR 32102, AR 32103, AR 32104, AR 67601	1.6	1997.09 - 2006.05		410514.88D
1.8 16V T.SPARK	AR 32201, AR 32205	1.8	1997.09 - 2006.05		410514.88D
1.9 JTD	AR 32302	1.9	1997.09 - 2000.10		410512.88D
2.0 16V T.SPARK	AR 32301, AR 32310	2.0	1997.09 - 2002.03		410514.88D
2.0 Twin Spark	AR 32303	2.0	1997.11 - 2000.04		410514.88D
2.4 JTD	AR 32501	2.4	1997.09 - 2003.09		410512.88D



ALFA ROMEO

	Motor Engine Moteur	Ltr. Ltr. Ltr.	Jahr Year Année	Einschränkung Restriction* Restriction*	Thermostat Thermostat Thermostat
159					
1.8 MPI	939 A4.000	1.8	2007.03 - 2011.11		4431.105D
1.9 JTDM 16V	937 A8.000, 939 A2.000, 939 A8.000	1.9	2005.09 - 2011.11		410049.88D
1.9 JTDM 8V	937 A7.000, 939 A1.000, 939 A7.000	1.9	2005.09 - 2011.11		410049.88D
1.9 JTS	939 A6.000	1.9	2005.09 - 2011.11		411193.82D
2.2 JTS	939 A5.000	2.2	2005.09 - 2011.11		411193.82D
1750					
1750	AR 00548	1.8	1968.03 - 1972.10		4008.79D
ALFASUD					
1.3	AR 30184	1.3	1976.09 - 1981.12		4003.86
1.4	AR 30164, AR 30168	1.4	1978.05 - 1989.12		4003.86
1.5	AR 30124, AR 30128, AR 30146	1.5	1978.05 - 1987.12		4003.86
ALFETTA					
1.6	AR 01600	1.6	1975.01 - 1984.12		4008.79D
1.8	AR 01608, AR 01608 X	1.8	1974.01 - 1984.12		4008.79D
1.8	AR 01678	1.8	1979.10 - 1984.12		4008.79D
2.0	AR 01623, AR 01655, AR 01713, AR 10520	2.0	1977.03 - 1986.01		4008.79D
AR 6 / AR 8					
2.4 D	8140.61.200, 8144.61.200	2.4	1978.04 - 1985.12		4008.79D
2.4 D	8140.61.200, 8144.61.200	2.4	1986.01 - 1986.08		4151.79D
2.4 TD	8140.21.200 D.I.	2.4	1985.04 - 1985.12		4008.79D
2.4 TD	8140.21.200 D.I.	2.4	1986.01 - 1989.12		4151.79D
2.4 TD	8144.21.220	2.4	1986.09 - 1989.12		4151.79D
2.5 D	8144.67.220	2.5	1986.03 - 1989.12		4151.79D
ARNA					
1.2	AR 30500, AR 31000	1.2	1985.01 - 1986.12		4003.86
1.3 TI	AR 30168, AR 31010	1.3	1983.03 - 1986.12		4003.86
BRERA					
2.2 JTS	939 A5.000	2.2	2006.01 -		411193.82D
GIULIA					
1300 Super (115)	AR 00530	1.3	1974.01 - 1978.12		3067.83
1300 TI (105, 39)		1.3	1969.04 - 1975.07		3000.83
1600 Super (105, 14)	AR 00526	1.6	1964.06 - 1969.08		3067.83
GIULIETTA					
1.3	AR 01644	1.3	1977.10 - 1983.06		4160.83D
1.6	AR 01600	1.6	1977.10 - 1985.04		4160.83D
1.8	AR 01678	1.8	1979.04 - 1985.04		4160.83D
1.8 Turbo	AR 01354	1.8	1984.01 - 1985.12		4160.83D
2.0	AR 11671, AR 01655	2.0	1980.06 - 1985.04		4160.83D
2.0 Turbo	AR 01699	2.0	1983.07 - 1984.06		4160.83D

ALFA ROMEO

 Motor
Engine
Moteur

 Ltr.
Ltr.
Ltr.

 Jahr
Year
Année

 Einschränkung
Restriction*
Restriction*

 Thermostat
Thermostat
Thermostat

GIULIETTA (940)

1.4 BiFuel	198 A4.000	1.4	2011.12 -		410871.80D ▲
1.4 TB	198 A4.000, 940 A2.000, 940 A6.000, 940 B1.000, 940 B7.000, 940 B8.000, 955 A8.000	1.4	2010.04 -		410871.80D ▲

GT

1300 Junior (105)	AR 00530	1.3	1966.01 - 1977.12		3067.83
1600 (105, 115)	AR 00526 S, AR 00536	1.6	1963.03 - 1977.12		3067.83
A 1600 (105)	AR 10538	1.6	1965.01 - 1970.12		3067.83

GT (937)

1.8 TS	AR 32205	1.8	2003.11 - 2010.09		410514.88D
1.9 JTD	937 A5.000, 937 A6.000	1.9	2003.11 - 2010.09		411773.88D ▲

GTV (116)

2.0	AR 06212, AR 01655	2.0	1978.07 - 1986.01		4008.79D
-----	--------------------	-----	-------------------	--	----------

GTV (916)

1.8 16V	AR 32201	1.8	1998.05 - 2005.10		410514.88D
2.0 T.SPARK 16V	AR 32301, AR 32310	2.0	1995.06 - 2005.10		410514.88D

MITO (955)

0.9	312 A2.000	0.9	2011.07 -		410090.88D
1.3 JTDM	199 A3.000	1.3	2008.09 -		410048.88D
1.3 JTDM	199 B1.000	1.3	2009.10 -		411774.88D ▲
1.4	199 A6.000, 350 A1.000, 955 A1.000	1.4	2008.09 -		410090.88D
1.4	955 A6.000	1.4	2010.08 -		410871.80D ▲
1.4	955 A9.000	1.4	2011.05 -		410090.88D
1.4 TB	940 A2.000, 955 A2.000, 955 A7.000, 955 A8.000	1.4	2009.10 -		410871.80D ▲

MONTREAL

2.6	AR 10832	2.6	1972.12 - 1979.03		4008.79D
-----	----------	-----	-------------------	--	----------

SPIDER (105)

1750	AR 00548	1.8	1967.01 - 1971.12		4008.79D
------	----------	-----	-------------------	--	----------

SPIDER (115)

1600	AR 01563	1.6	1990.01 - 1993.12		4160.83D
------	----------	-----	-------------------	--	----------

SPIDER (916)

1.8 16V	AR 32201	1.8	1998.05 - 2005.04		410514.88D
2.0 T.SPARK 16V	AR 32301, AR 32310	2.0	1995.06 - 2005.04		410514.88D

SPIDER (939)

2.2 JTS	939 A5.000	2.2	2006.09 -		411193.82D
---------	------------	-----	-----------	--	------------

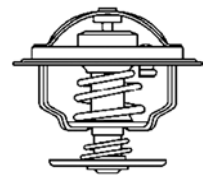

AUDI

	Motor Engine Moteur	Ltr. Ltr. Ltr.	Jahr Year Année	Einschränkung Restriction* Restriction*	Thermostat Thermostat Thermostat
80 (quattro)					
1.3	EP, ZA, ZF	1.3	1972.05 - 1978.07		4264.87D
1.3	FY, FZ	1.3	1978.09 - 1981.07		3091.92D
1.4	SE	1.4	1986.08 - 1988.07		4264.87D
1.5	YJ, ZB, ZC	1.5	1972.05 - 1975.08		4264.87D
1.6	ABB, ABM, DT, PP, RN, SA, WV, YN, YP, YT, YY	1.6	1975.09 - 1991.10		4264.87D
1.6 D	JK, CR	1.6	1980.08 - 1991.08		4253.87D
1.6 E	ADA	1.6	1993.06 - 1996.01		4264.87D
1.6 GLE	YZ	1.6	1979.01 - 1986.12		4264.87D
1.6 GT	XX	1.6	1973.09 - 1976.07		4264.87D
1.6 GTE	YS	1.6	1976.01 - 1978.07		4264.87D
1.6 TD	CY	1.6	1981.08 - 1986.05		4253.87D
1.6 TD	RA, SB	1.6	1986.09 - 1991.08		4253.87D
1.8	DS, JN, JV, NE, RU, SD, SF	1.8	1983.01 - 1990.08		4264.87D
1.8 E / GTE	DZ, PV	1.8	1984.08 - 1991.08		4264.87D
1.8 S	JN, NE, PM, SF	1.8	1986.09 - 1991.10		4264.87D
1.9 CD-5S	WN	1.9	1981.09 - 1983.07		4116.87D1
1.9 D	1Y	1.9	1989.08 - 1991.08		4253.87D
1.9 TD	AAZ, 1Z	1.9	1991.09 - 1994.12		4253.87D
1.9 TDI	1Z	1.9	1991.09 - 1996.01		4253.87D
2.0	JS, HP	2.0	1983.10 - 1984.09		4116.87D1
2.0	3A, AAD, ABT, ADW	2.0	1988.08 - 1996.01		4264.87D
2.0 E	3A, ABK	2.0	1988.08 - 1996.01		4264.87D
2.0 E 16V	6A, ACE	2.0	1990.03 - 1992.07		4264.87D
2.2	KK, KL, WE	2.2	1980.10 - 1984.07		4116.87D1
2.3	NG	2.3	1987.10 - 1989.07		4116.87D1
2.3 E	NG	2.3	1991.09 - 1996.01		4116.87D1
2.6	ABC, ACZ	2.6	1992.06 - 1996.01		4274.87D
2.8	AAH	2.8	1991.09 - 1996.01		4274.87D
RS2	ADU	2.2	1994.03 - 1995.05		4116.87D1
S2	ABY	2.2	1993.02 - 1995.07		4116.87D1
90 (quattro)					
1.6 TD	CY, RA, SB	1.6	1985.10 - 1991.09		4253.87D
2.0	HP, JS, PS, SK	2.0	1984.08 - 1991.09		4116.87D1
2.0	6A	2.0	1989.08 - 1990.07		4264.87D
2.0 20 V	NM	2.0	1988.08 - 1991.09		4116.87D1
2.2	HY, KV, KX	2.2	1984.10 - 1987.03		4116.87D1
2.2 E	JT, KV	2.2	1985.08 - 1987.03		4116.87D1
2.3 E	NG	2.3	1987.04 - 1991.09		4116.87D1
2.3 E 20V	7A	2.3	1988.06 - 1991.09		4116.87D1
100 1968 → 1983					
1.6	YM	1.6	1975.01 - 1976.07		4256.80D
1.6	YV	1.6	1976.08 - 1983.02		4264.87D
1.8	ZU, ZV, ZX, ZZ	1.8	1968.11 - 1976.07		4006.82D
1.9	WH, ZJ, ZP	1.9	1970.07 - 1982.07		4006.82D
2.0	WA	2.0	1976.06 - 1980.07		4006.82D
2.0 D	CN	2.0	1978.08 - 1983.02		4116.87D1
2.1	WE, WB, WC, WG	2.1	1977.03 - 1983.02		4088.80D
100 1982 → 1990 (quattro)					
1.8	4B, DR, DS, RS, JW, NP, PH, SH	1.8	1982.08 - 1990.11		4264.87D
1.9	WH	1.9	1982.08 - 1984.07		4116.87D1

AUDI
**Motor
Engine
Moteur**
**Ltr.
Ltr.
Ltr.**
**Jahr
Year
Année**
**Einschränkung
Restriction*
Restriction***
**Thermostat
Thermostat
Thermostat**

2.0	KP, RT, SL	2.0	1984.08 - 1990.11		4116.87D1
2.0 D	CN	2.0	1982.08 - 1990.11		4116.87D1
2.0 D Turbo	DE, NC	2.0	1982.08 - 1990.11		4116.87D1
2.0 E	KP, RT	2.0	1985.01 - 1990.11		4116.87D1
2.0 TD	DE, NC	2.0	1983.03 - 1990.11		4116.87D1
2.1	KF, WC	2.1	1982.08 - 1984.07		4116.87D1
2.2	HX, KF, KU, KZ, WU	2.2	1982.08 - 1990.11		4116.87D1
2.2 E	PX	2.2	1985.08 - 1986.07		4116.87D1
2.2 E Turbo	MC	2.2	1986.08 - 1990.11		4116.87D1
2.2 Turbo	MC	2.2	1986.08 - 1990.11		4116.87D1
2.3	AAR, NF	2.3	1986.08 - 1990.11		4116.87D1
2.3 E	AAR, NF	2.3	1986.08 - 1990.11		4116.87D1
2.4 D	3D	2.4	1989.08 - 1991.07		4116.87D1
2.5 TDI	1T	2.5	1990.01 - 1990.11		4116.87D1

100 1990 → 1994 (quattro)

2.0	AAE	2.0	1990.12 - 1994.06		4264.87D
2.0 E	AAD, AAE, ABK	2.0	1990.12 - 1994.06		4264.87D
2.0 E 16V	ACE	2.0	1992.01 - 1994.06		4264.87D
2.3 E	AAR	2.3	1990.12 - 1994.06		4116.87D1
2.4 D	AAS	2.4	1990.12 - 1994.06		4116.87D1
2.5 TDI	AAT, ABP	2.5	1990.12 - 1994.06		4116.87D1
2.6	ABC, ACZ	2.6	1992.03 - 1994.06		4274.87D
2.6 E	AAH, ACZ	2.6	1990.08 - 1994.06		4274.87D
2.8 E	AAH	2.8	1990.12 - 1994.06		4274.87D
S4 Turbo	AAN	2.2	1991.08 - 1994.06		4116.87D1
S4 V8	ABH	4.2	1992.10 - 1994.06		4274.87D
S4 V8	AEC	4.2	1994.03 - 1994.06		4274.87D

200 (quattro)

2.1 5 E	WC	2.1	1979.10 - 1984.07		4116.87D1
2.1 5 T	WJ	2.1	1979.10 - 1982.08		4088.87D
2.1 Turbo	JY, KG	2.1	1983.08 - 1988.01		4116.87D1
2.2	KU	2.2	1984.08 - 1985.07		4116.87D1
2.2 20V Turbo	3B	2.2	1989.03 - 1990.12		4116.87D1
2.2 Turbo	1B, 2B, MC	2.2	1988.02 - 1991.12		4116.87D1
2.3	NF	2.3	1986.11 - 1991.09		4116.87D1

A1 (8XA, 8X1)

1.6 TDI	CAYC	1.6	2010.05 - 2010.10	mit Gehäuse	410536.92D
1.6 TDI	CAYC	1.6	2010.05 - 2010.10	ohne Gehäuse	410537.92D
1.6 TDI	CAYC	1.6	2010.11 -		410845.92D
1.6 TDI	CAYB	1.6	2011.03 -		410845.92D
2.0 TDI	CFHB, CFHD	2.0	2011.09 -		410845.87D

A2

1.2 TDI	ANY	1.2	2001.03 - 2005.08		4264.87D
1.4	BBY, AUA	1.4	2000.02 - 2005.08	mit Gehäuse	410475.87D
1.4 TDI	ATL, BHC	1.4	2000.02 - 2005.08		4264.87D

A3 (8L)

1.6	AEH, AKL	1.6	1996.09 - 2003.05		3141.87D
1.8	AGN, APG	1.8	1996.09 - 2003.05		3141.87D
1.8 T	AGU, AJQ, APP, AQA, ARY, ARX, AUM, AUQ	1.8	1996.12 - 2003.05		3141.87D

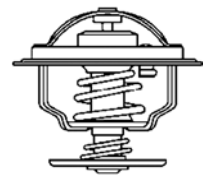

AUDI

	Motor Engine Moteur	Ltr. Ltr. Ltr.	Jahr Year Année	Einschränkung Restriction* Restriction*	Thermostat Thermostat Thermostat
1.9 TDI	AGR, AHF, ALH, ATD, ASV, ASZ, AXR	1.9	1996.09 - 2003.05		4264.87D
S3	AMK, APY	1.8	1999.03 - 2002.04		3141.87D
S3	BAM	1.8	2001.10 - 2003.05		3141.87D
A3 (8P)					
1.6	BGU, BSE, BSF, CCSA, CMXA	1.6	2003.05 - 2012.08		3141.87D
1.6	BSE	1.6	2008.09 -		3141.87D
1.6 TDI	CAYB, CAYC	1.6	2009.01 - 2010.05		410537.92D
1.6 TDI	CAYB, CAYC	1.6	2010.05 - 2012.08		410845.92D
1.9 TDI	BKC, BXE	1.9	2004.04 - 2010.05		4264.87D
1.9 TDI	BLS	1.9	2008.04 -		4820.87D
2.0 FSI	BVZ, BVY	2.0	2003.05 - 2008.06		411186.87D
2.0 TDI	AZV, BMN, BUY	2.0	2003.05 - 2008.06		3472.87D
2.0 TDI	BMM	2.0	2005.06 - 2008.06		4820.87D
2.0 TDI	CBAA, CBBB, CBAB	2.0	2008.04 - 2009.07		3472.87D
2.0 TDI	CFFA, CFFB, CFGB	2.0	2008.04 -		410845.87D
2.0 TDI 16V	CFFB, CLJA	2.0	2003.05 - 2012.08		410845.87D
2.0 TDI 16V	CBAB	2.0	2004.08 - 2012.08		3472.87D
2.0 TDI 16V	BKD	2.0	2004.08 - 2009.07		3472.87D
2.0 TFSI	AXX, BWA, BPY	2.0	2004.09 -		411187.87D
3.2 V6	BDB, BMJ, BUB	3.2	2003.07 - 2009.05		4455.80D
A4 (quattro)					
1.6	ADP, AHL, ALZ, ANA, ARM	1.6	1994.11 - 2001.09		3141.87D
1.8	ADR, AFY, APT, ARG, AVV	1.8	1995.01 - 2001.09		3141.87D
1.8 T	AEB, AJL, ANB, APU, ARK, AWT	1.8	1995.01 - 2001.09		3141.87D
1.9 DUO	AHU	1.9	1998.03 - 2001.09		4264.87D
1.9 TDI	1Z, AFF, AFN, AHU, AHH, AJM, ATJ, AVB, AVF, AVG, AWX, BKE, BRB	1.9	1995.01 - 2008.06		4264.87D
2.0 TDI	BNA, BRF, BRD, BVA, BVF, BVG	2.0	2004.11 - 2008.06		3472.87D
2.0 TDI	BPW, BRC	2.0	2004.11 - 2009.03		4264.87D
2.0 TDI 16V	BLB, BRE	2.0	2004.11 - 2008.06		3472.87D
2.0 TFSI	BGB, BPG, BPJ, BUL, BWE, BWT, BYK	2.0	2004.11 - 2008.06		411186.87D
2.0 TFSI 16V	BWE, BWT	2.0	2006.01 - 2009.03		411186.87D
2.4	AFM, AGA, AJG, ALF, AML, AMM, APS, APZ, ARJ, BDV	2.4	1995.07 - 2001.09	Chassis No. →8D-X-315 000	4274.87D
2.4	AFM, AGA, AJG, ALF, AML, AMM, APS, APZ, ARJ, BDV	2.4	1997.03 - 2005.12	Chassis No. 8D-X-315 001→	4274.92D
2.5 D	AKE	2.5	2000.10 - 2003.05		4274.87D
2.5 TDI	AFB, AKE, AKN, AYM, BAU, BCZ, BDG, BDH, BFC	2.5	1997.09 - 2006.05		4274.87D
2.6	ABC, ACZ	2.6	1995.01 - 2001.09		4274.87D
2.8	AAH, ACK, ALG, AMX, APR, AQD	2.8	1995.01 - 1997.07		4274.87D
2.8	ATX	2.8	1999.03 - 2000.09		4274.92D
3.0	ASN, AVK, BBJ	3.0	2000.11 - 2004.12		4814.92D
RS4	ASJ, AZR	2.7	2000.05 - 2001.09		4274.87D
S4	AGB, AZB	2.7	1997.09 - 2001.09		4274.87D
A4 (8K2, B8)					
2.0 TDI	CAGB, CAHB, CAGC	2.0	2007.11 - 2009.08		410396.82D
A6 (quattro)					
1.8	ADR, AFY, AJP, AQE, ARH	1.8	1995.12 - 2005.01		3141.87D
1.8 T	AEB, ANB, APU, ARK, AWT, AJL	1.8	1997.01 - 2005.01		3141.87D
1.9 TDI	1Z, AFN, AHU, AJM, AVF, AVG, AWX	1.9	1994.06 - 2005.01		4264.87D

AUDI
**Motor
Engine
Moteur**
**Ltr.
Ltr.
Ltr.**
**Jahr
Year
Année**
**Einschränkung
Restriction*
Restriction***
**Thermostat
Thermostat
Thermostat**

2.0	AAE, ABK, ADW	2.0	1994.06 - 1997.12		4264.87D
2.0 16V	ACE	2.0	1994.06 - 1997.12		4264.87D
2.0 TDI	BLB, BRE, BNA, BRF	2.0	2004.07 - 2008.10		3472.87D
2.0 TDI	CAHA, CAHB, CAGB	2.0	2008.10 - 2009.08		410396.82D
2.0 TFSI	BPJ, BYK	2.0	2005.06 - 2011.08		411186.87D
2.3	AAR	2.3	1994.06 - 1995.12		4116.87D1
2.4	AFM, AGA, AJG, ALF, ALW, AML, AMM, APC, APS, APZ, ARJ, ARN, ASM, BDV	2.4	1995.07 - 2005.01	Chassis No. →4B-X-160 000	4274.87D
2.4	AFM, AGA, AJG, ALF, ALW, AML, AMM, APC, APS, APZ, ARJ, ARN, ASM, BDV	2.4	1997.02 - 2005.01	Chassis No. 4B-X-160 001→	4274.92D
2.5 TDI	AAT, AEL	2.5	1994.06 - 1997.12		4116.87D1
2.5 TDI	AFB, AKE, AKN, AYM, BAU, BCZ, BDG, BDH, BFC, BND	2.5	1997.07 - 2005.01		4274.87D
2.7 T	AJK, ARE, AZA, BES	2.7	1997.12 - 2005.01		4274.87D
2.8	AAH, ACK, AEJ, AFC, AGE, ALG, AMX, APR, AQD	2.8	1994.06 - 2005.01		4274.87D
2.8	ATX, BBG	2.8	1999.07 - 2005.01		4274.92D
3.0	ASN, BBJ	3.0	2001.06 - 2006.05		4814.92D
4.2	ARS, ASG	4.2	1998.11 - 2005.01		4274.87D
RS6	BCY	4.2	2002.07 - 2005.01		4274.82D
S6	ANK, AQJ	4.2	1999.09 - 2005.01		4274.87D
S6 4.2	AEC	4.2	1994.06 - 1997.12		4274.87D
S6 Plus	AHK	4.2	1996.04 - 1997.12		4274.87D
S6 Turbo	AAN	2.2	1994.06 - 1997.12		4116.87D1

A8 (quattro)

2.5 TDI	AFB, AKE, AKN	2.5	1997.01 - 2002.09		4274.87D
2.8	AAH, AEJ, ACK, ALG, AMX, APR, AQD	2.8	1994.03 - 2002.09		4274.87D
3.0	ASN, BBJ	3.0	2003.07 - 2005.05		4814.92D
3.3 TDI	AKF	3.3	2000.06 - 2002.09		4274.87D
3.7	AEW, AKC, AKJ, AQG, BFL	3.7	1995.07 - 2002.09		4274.87D
4.2	ABZ, AEM, AKG, ARU, AQF, AUW, AUX	4.2	1994.03 - 2002.09		4274.87D
4.2	ARU, BFM	4.2	1999.02 - 2010.07		4274.82D
S 8	AHC, AKH	4.2	1996.07 - 1999.06		4274.87D
S 8	AQH, AVP	4.2	1999.06 - 2002.09		4274.82D

ALLROAD

2.5 TDI	AKE, BAU, BCZ	2.5	2000.05 - 2005.08		4274.87D
2.7 T	ARE, BES	2.7	2000.05 - 2005.08		4274.87D

CABRIOLET

1.8	ADR	1.8	1997.01 - 2000.08		3141.87D
1.9 TDI	1Z, AHU	1.9	1995.06 - 2000.08		4264.87D
2.0 16V	ACE	2.0	1995.06 - 1996.07		4264.87D
2.0 E	ABK	2.0	1993.01 - 1998.07		4264.87D
2.3 E	NG	2.3	1991.05 - 1994.07		4116.87D1
2.6	ABC, ACZ	2.6	1993.06 - 2000.08		4274.87D
2.8	AAH	2.8	1992.11 - 2000.08		4274.87D

COUPE (quattro)

1.6	YN	1.6	1980.07 - 1981.08		4264.87D
1.8	DD, DZ	1.8	1981.08 - 1991.07		4264.87D
1.8 GT	DS, DZ, JN, JV, NE, PV, SF	1.8	1982.09 - 1988.10		4264.87D

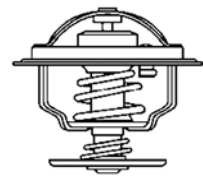

AUDI

	Motor Engine Moteur	Ltr. Ltr. Ltr.	Jahr Year Année	Einschränkung Restriction* Restriction*	Thermostat Thermostat Thermostat
1.9	WN	1.9	1980.08 - 1983.07		4116.87D1
2.0	JS ,HP, SK	2.0	1983.09 - 1988.04		4116.87D1
2.0	3A, ABK, AAD	2.0	1989.05 - 1996.12		4264.87D
2.0 16 V	6A. ACE	2.0	1992.01 - 1996.12		4264.87D
2.0 20 V	NM	2.0	1989.08 - 1991.07		4116.87D1
2.1 GT	KE, KL, WE	2.1	1981.01 - 1987.10		4116.87D1
2.2	JT, KV	2.2	1984.10 - 1991.07		4116.87D1
2.2 GT	HY, KV, KX	2.2	1981.07 - 1988.10		4116.87D1
2.3	NG	2.3	1987.01 - 1996.12		4116.87D1
2.3 20V	7A	2.3	1988.11 - 1996.12		4116.87D1
2.6	ABC	2.6	1992.08 - 1996.12		4274.87D
2.8	AAH	2.8	1991.08 - 1996.12		4274.87D
S2	3B, ABY	2.2	1990.09 - 1996.12		4116.87D1
QUATTRO					
2.1 20V Turbo	KW	2.1	1984.05 - 1987.07		4116.87D1
2.1 Turbo	GV, WR, WX	2.1	1980.07 - 1989.07		4116.87D1
2.2 20V Turbo	RR	2.2	1989.08 - 1991.07		4116.87D1
2.2 Turbo	1B, MB	2.2	1987.08 - 1989.07		4116.87D1
Q3 (8U)					
2.0 TDI	CFFA, CFFB, CLJA, CFGD	2.0	2011.09 -		410845.87D
Q5 (8R)					
2.0 TDI	CAHA, CGLA	2.0	2008.11 - 2009.08		410396.82D
TT (quattro)					
1.8 T	AJQ, AMU, APP, APX, ARY, ATC, AUM, AUQ, BAM, BVP, BVR	1.8	1998.01 - 2006.06		3141.87D
2.0 TDI	CBBB	2.0	2008.06 - 2009.07		3472.87D
2.0 TDI	CFGB	2.0	2008.06 -		410845.87D
2.0 TDI	CBBB	2.0	2009.08 -		410845.87D
2.0 TFSI	BWA, BPY	2.0	2006.08 - 2010.06		411187.87D
3.2 V6	BUB	3.2	2006.08 - 2010.06		4455.80D
3.2 VR6	BPF, BHE	3.2	2003.07 - 2006.06		4455.80D
V 8 (quattro)					
3.6	PT	3.6	1988.10 - 1994.02		4274.87D
4.2	ABH	4.2	1991.10 - 1994.02		4274.87D

AUTOBIANCHI

 Motor
Engine
Moteur

 Ltr.
Ltr.
Ltr.

 Jahr
Year
Année

 Einschränkung
Restriction*
Restriction*

 Thermostat
Thermostat
Thermostat

	Motor Engine Moteur	Ltr. Ltr. Ltr.	Jahr Year Année	Einschränkung Restriction* Restriction*	Thermostat Thermostat Thermostat
A 111					
1.4	Fiat BLC.000	1.4	1969.08 - 1972.11		3345.79
A 112					
0.9	A112A 5.000	0.9	1969.10 - 1972.12		3023.87D
1.0 Abarth	A112A1.000	1.0	1971.09 - 1972.12		3023.87D
Y 10					
1.0	156A2.000, 156A2.246, 156A3.000	1.0	1985.03 - 1995.10		3105.87D
1.0	156A.000	1.0	1985.03 - 1995.10		4091.82D
1.0 Turbo	156A1.000	1.0	1985.03 - 1995.10		4091.82D
1.1	156C.000	1.1	1989.06 - 1995.10		3105.87D
1.1 i.e.	156C.046	1.1	1990.09 - 1995.10		3105.87D
1.3 i.e. GT	146A5.046, 156B.000	1.3	1989.06 - 1995.10	Motor no. →3143798	3378.80
1.3 i.e. GT	146A5.046, 156B.000	1.3	1989.07 - 1995.10	Motor no. 3143798 →	3373.80D

BMW

	Motor Engine Moteur	Ltr. Ltr. Ltr.	Jahr Year Année	Einschränkung Restriction* Restriction*	Thermostat Thermostat Thermostat
02 (E6, E10)					
1502	M 10	1.6	1975.01 - 1977.07		3344.80
1600	M 10	1.6	1971.05 - 1973.04		3344.80
1600 Ti	M 10	1.6	1967.09 - 1969.11		3344.80
1600-2	M 10	1.6	1967.12 - 1971.12		3344.80
1602	M 10	1.6	1971.04 - 1975.07		3344.80
1802	M 10	1.8	1971.05 - 1975.07		3344.80
2002	M 10	2.0	1968.02 - 1975.07		3344.80
2002 Ti	M 10	2.0	1968.06 - 1972.04		3344.80
2002 Tii	M 10	2.0	1971.01 - 1975.07		3344.80
2002 Turbo	M10 B20 (Turbo)	2.0	1974.01 - 1975.07		3344.75
1500 / 1600 / 1800 / 2000					
1.6	M 10	1.6	1967.10 - 1969.05		3344.80
1500	M 10	1.5	1962.10 - 1966.07		3344.80
1500	M 10	1.6	1963.09 - 1966.07		3344.80
1600	M 10	1.6	1964.04 - 1968.04		3344.80
1800	0	1.8	1963.08 - 1969.09		3344.80
1800	M 10	1.8	1969.07 - 1971.09		3344.80
1800 Ti	0	1.8	1963.10 - 1968.04		3344.80
2000	M 10	2.0	1968.09 - 1972.07		3344.80
2000	M 10	1.8	1970.01 - 1972.11		3344.80
2000 Ti / Tilux	M 10	2.0	1966.01 - 1972.07		3344.80
2000 Tii	M 10	2.0	1969.12 - 1972.07		3344.80
2000 3.2 Coupe (E9)					
2.5 CS	M 30	2.5	1974.09 - 1976.03		4235.80D
2000 C/CA	M 10	2.0	1965.10 - 1970.06		3344.80
2000 CS	M 10	2.0	1965.10 - 1970.06		3344.80
2800 CS	M 30	2.8	1969.01 - 1971.04		4231.80D
3.0 CS	M 30	3.0	1971.05 - 1976.03		4235.80D
3.0 Csi	M 30	3.0	1971.07 - 1976.03		4235.80D
2500 3.3 (E3)					
2.8 L	M 30	2.8	1975.02 - 1977.04		4231.80D
2500	M 30	2.5	1968.10 - 1977.04		4235.80D
2800	M 30	2.8	1968.10 - 1975.07		4231.80D
3.0 L	M 30	3.0	1975.02 - 1977.04		4235.80D
3.0 S	M 30	3.0	1971.05 - 1977.04		4235.80D
3.0 Si	M 30	3.0	1971.07 - 1977.04		4235.80D
3.2 Li	0	3.2	1975.10 - 1977.04		4231.80D
3.3 L	M 30	3.3	1974.01 - 1976.09		4235.80D
1 Serie (E81, E87)					
116 i	N 45 B16 A	1.6	2003.11 - 2012.09		410793.95D
116 i	N 43 B16 A	1.6	2003.11 - 2012.09		411574.102D ▲
118 i	N 43 B20 A	2.0	2004.07 - 2012.09		411574.102D ▲
118 i	N 46 B20 B	2.0	2004.07 - 2012.09		4337.105D
120 i	N 43	2.0	2003.11 - 2012.09		411574.102D ▲
120 i	N 46	2.0	2003.11 - 2012.09		4337.105D
130 i	N 52	3.0	2005.09 - 2012.09		410086.97D0

BMW
**Motor
Engine
Moteur**
**Ltr.
Ltr.
Ltr.**
**Jahr
Year
Année**
**Einschränkung
Restriction*
Restriction***
**Thermostat
Thermostat
Thermostat**
1 Serie (E82, E88)

118 i	N 43 B20 A	2.0	2008.03 -		411574.102D ▲
120 i	N 43	2.0	2008.03 -		411574.102D ▲
120 i	N 46	2.0	2008.03 -		4337.105D
125 i	N 52	3.0	2007.10 -		410086.97D0
135 i	N 54	3.0	2007.10 -		410086.97D0
135 i	N 55	3.0	2007.10 -		410766.103D0 ▲
M	N 54	3.0	2011.04 - 2012.06		410086.97D0

3 Serie (E21)

315	M 10	1.6	1981.03 - 1984.03		3344.80
316	M 10	1.6	1975.08 - 1980.08		3344.80
316	M 10	1.8	1980.09 - 1982.08		3344.80
318	M 10	1.8	1975.08 - 1980.08		3344.80
318 i	M 10	1.8	1979.11 - 1982.08		3344.80
320	M 10	2.0	1975.08 - 1977.08		3344.80
320 /6	M 20	2.0	1977.09 - 1982.08		4232.80D
320 i	M 10	2.0	1975.06 - 1982.08		3344.80
323 i	M 20	2.3	1978.01 - 1982.08		4232.80D

3 Serie (E30)

315	M 10	1.6	1982.09 - 1991.12		3344.80
316	M 10	1.8	1982.09 - 1990.12		3344.80
316 i	M 10	1.8	1987.08 - 1988.08		3344.80
316 i	M 40	1.6	1987.09 - 1994.06		4236.88D
318 i	M 10	1.8	1982.09 - 1988.08		3344.80
318 i	M 40	1.8	1987.09 - 1994.06		4236.88D
318 i	M 40	1.8	1988.06 - 1992.02		4236.88D
318 is	M 42	1.8	1989.09 - 1991.08		4236.88D
320 i	M 20	2.0	1982.09 - 1985.12		4232.80D
320 i	M 20	2.0	1985.12 - 1991.12		4235.80D
320 i		2.0	1985.12 - 1990.06		4235.80D
320 i	M 20	2.0	1986.04 - 1993.10		4235.80D
323 i	M 20	2.3	1982.09 - 1986.08		4232.80D
324 d	M 21	2.4	1985.09 - 1991.08		4232.80D
324 td	M 21	2.4	1987.09 - 1993.06		4232.80D
325 e 2.7	M 20	2.7	1983.10 - 1988.12		4235.80D
325 i	M 20	2.5	1983.09 - 1993.10		4235.80D
325 i X	M 20	2.5	1986.03 - 1993.10		4235.80D

3 Serie (E36)

316 g	M 43	1.6	1994.03 - 2000.08		410792.95D
316 i	M 40	1.6	1990.09 - 1993.09		4236.92D
316 i	M 43	1.6	1993.07 - 2000.08		410792.95D
316 i	M 43	1.9	1998.12 - 2000.08		411573.105D ▲
318 i	M 40	1.8	1990.12 - 1993.10		4236.92D
318 i	M 43	1.8	1993.10 - 1999.10		410792.95D
318 is	M 42	1.8	1992.03 - 1998.02		4236.92D
318 tds	M 41	1.7	1995.01 - 2000.08		4237.88D
318 ti	M 42	1.8	1994.11 - 1995.08		4236.92D
320 i	M 52 B, M 50 B	2.0	1990.09 - 1992.09		4235.80D
320 i	M 52 B, M 50 B	2.0	1990.09 - 1999.04	Leitung Drosselklappe zum Zylinderkopf	7129.00D ▲
320 i	M 52 B, M 50 B	2.0	1992.09 - 1995.12		4236.88D

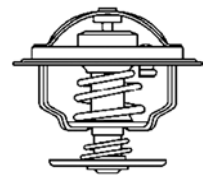

BMW

	Motor Engine Moteur	Ltr. Ltr. Ltr.	Jahr Year Année	Einschränkung Restriction* Restriction*	Thermostat Thermostat Thermostat
320 i	M 52 B, M 50 B	2.0	1995.12 - 1999.10		4236.92D
323 i	M 52	2.5	1995.03 - 1995.12		4236.88D
323 i	M 52	2.5	1995.12 - 1999.10		4236.92D
323 i 2.5	M52 B25 (Vanos)	2.5	1995.03 - 1995.12		4236.88D
323 i 2.5	M52 B25 (Vanos)	2.5	1995.12 - 1998.02		4236.92D
323 ti	M52 B25 (Vanos)	2.5	1997.08 - 2000.08		4236.92D
325 i	M 50	2.5	1990.09 - 1999.04	Leitung Drosselklappe zum Zylinderkopf	7129.00D ▲
325 i	M 50	2.5	1992.03 - 1995.12		4236.88D
325 i	M 50	2.5	1995.12 - 1999.04		4236.92D
325 td	M 51	2.5	1991.09 - 1998.02		4237.80D
325 tds	M 51	2.5	1993.05 - 1999.10		4237.80D
328 i	M 52	2.8	1995.01 - 1995.12		4236.88D
328 i	M 52	2.8	1995.12 - 1999.10		4236.92D
M3 3.0	S 50 B30	3.0	1992.10 - 1995.10		4621.80D
M3 3.0	S 50 B30	3.0	1992.10 - 1995.10	Leitung Drosselklappe zum Zylinderkopf	7129.00D ▲
M3 3.2	S 50 B32	3.2	1995.09 - 1999.04		4621.80D
3 Serie (E46)					
316 i	M 43	1.9	1998.09 - 2005.02		411573.105D ▲
316 i	N 42, N 46	1.8	2002.02 - 2005.02		4337.105D
316 i	N 45	1.6	2002.06 - 2005.02		410793.95D
316 ti	N 42, N 46	1.8	2001.06 - 2005.02		4337.105D
316 ti	N 40, N 45	1.6	2002.06 - 2005.02		410793.95D
318 i	M 43	1.9	1998.02 - 2001.09		411573.105D ▲
318 i	N 42	2.0	2001.09 - 2001.12		410793.95D
318 i	N 46	2.0	2001.09 - 2005.02		4337.105D
318 i	N 42	2.0	2001.12 - 2005.02		4337.105D
318 ti	N 42	2.0	2001.09 - 2001.12		410793.95D
318 ti	N 46	2.0	2001.09 - 2005.02		4337.105D
318 ti	N 42	2.0	2001.12 - 2005.02		4337.105D
320 i	M 52, M 54	2.0	1998.03 - 2005.02		4326.97D
323 i	M 52	2.5	1998.03 - 2000.09		4326.97D
325 i	M 54	2.5	2000.09 - 2005.02		4326.97D
325 ti	M 54	2.5	2001.06 - 2005.02		4326.97D
325 xi	M 54	2.5	2000.09 - 2005.02		4326.97D
328 i	M 52	2.8	1998.02 - 2000.06		4326.97D
330 i	M 54	3.0	2000.06 - 2005.04		4326.97D
330 xi	M 54	3.0	2000.06 - 2005.04		4326.97D
M3 3.2	S 54	3.2	2000.06 -		4621.80D
M3 CSL	S 54	3.2	2003.06 -		4621.80D
3 Serie (E90 / 91 / 92 / 93)					
316 i	N 45	1.6	2006.02 - 2011.12		410793.95D
316 i	N 43	1.6	2007.09 - 2012.05		411574.102D ▲
318 i	N 46	2.0	2007.06 - 2011.12		4337.105D
318 i	N 43	2.0	2007.09 - 2011.12		411574.102D ▲
320 i	N 46	2.0	2005.01 - 2007.08		4337.105D
320 i	N 43	2.0	2005.09 - 2011.12		411574.102D ▲
323 i	N 52	2.5	2005.01 - 2011.12		410086.97D0
325 i	N 51, N 53	3.0	2007.03 - 2011.12		410086.97D0
325 xi	N 52	2.5	2005.01 - 2011.12		410086.97D0
325 xi	N 53	3.0	2007.09 - 2011.12		410086.97D0
328 i	N 52	3.0	2005.07 - 2007.11		410086.97D0

BMW
**Motor
Engine
Moteur**
**Ltr.
Ltr.
Ltr.**
**Jahr
Year
Année**
**Einschränkung
Restriction*
Restriction***
**Thermostat
Thermostat
Thermostat**

330 i	N 52, N 53	3.0	2005.01 - 2011.12		410086.97D0
330 xi	N 52, N 53	3.0	2005.01 - 2011.12		410086.97D0
335 i	N 54	3.0	2006.09 - 2011.12		410086.97D0
335 i	N 55	3.0	2006.09 - 2011.12		410766.103D0 ▲
335 xi	N 54	3.0	2006.09 - 2011.12		410086.97D0
335 xi	N 55	3.0	2006.09 - 2011.12		410766.103D0 ▲

5 Serie (E12)

518	M 10	1.8	1974.07 - 1981.05		3344.80
518	M 10	2.0	1975.12 - 1977.08		3344.80
518 i	M 10	2.0	1977.08 - 1979.09		3344.80
520	M 10	2.0	1972.08 - 1977.08		3344.80
520 /6	M 20	2.0	1977.09 - 1981.05		4232.80D
520 i	M 10	2.0	1972.08 - 1977.05		3344.80
525	M 30	2.5	1973.08 - 1981.05		4235.80D
528	M 30	2.8	1975.01 - 1977.08		4231.80D
528 i	M 30	2.8	1977.04 - 1981.05		4231.80D
M 3.4	M30 B35 (Motronic,9.3:1)	3.5	1980.06 - 1981.08		4231.80D

5 Serie (E28)

518	M 10	1.8	1981.06 - 1984.08		3344.80
518 i	M 10	1.8	1981.09 - 1987.12		3344.80
520 i	M20 B20 L-Jetr.	2.0	1981.06 - 1987.12		4232.80D
520 i	M20 B20 K-Jetr.	2.0	1981.06 - 1987.12		4235.80D
524 d	M 21	2.4	1986.03 - 1987.12		4232.80D
524 td	M 21	2.4	1983.09 - 1987.12		4232.80D
525 e	M 20	2.7	1981.09 - 1985.09		4232.80D
525 e	M 20	2.7	1985.09 - 1987.12		4235.80D
525 i	M 20	2.5	1981.06 - 1985.09		4231.80D
525 i	M 20	2.5	1985.09 - 1987.12		4235.80D
528 i	M 30	2.8	1981.06 - 1985.09		4232.80D
528 i	M 30	2.8	1985.09 - 1987.12		4235.80D
535 i, M 535 i	M 30	3.4	1985.01 - 1985.09		4232.80D
535 i, M 535 i	M 30	3.4	1985.09 - 1987.12		4235.80D

5 Serie (E34)

518 g	M 43	1.8	1995.11 - 1996.06		410792.95D
518 i	M 43	1.8	1989.08 - 1997.01		410792.95D
518 i	M 40	1.8	1993.03 - 1994.09		4236.88D
520 i	M 20	2.0	1988.01 - 1991.08		4235.80D
520 i	M 50	2.0	1991.11 - 1992.09		4236.88D
520 i	M 50	2.0	1991.11 - 1997.01	Leitung Drosselklappe zum Zylinderkopf	7129.00D ▲
520 i	M 50	2.0	1992.09 - 1997.01		4236.92D
520 i 24V	M 50	2.0	1989.09 - 1992.09		4236.88D
520 i 24V	M 50	2.0	1989.09 - 1995.09	Leitung Drosselklappe zum Zylinderkopf	7129.00D ▲
520 i 24V	M 50	2.0	1992.09 - 1995.09		4236.92D
524 td	M 21	2.4	1988.03 - 1995.09		4232.80D
525 i	M 20	2.5	1988.01 - 1991.08		4235.80D
525 i	M 50	2.5	1991.11 - 1992.09		4236.88D
525 i	M 50	2.5	1991.11 - 1997.01	Leitung Drosselklappe zum Zylinderkopf	7129.00D ▲
525 i	M 50	2.5	1992.09 - 1997.01		4236.92D

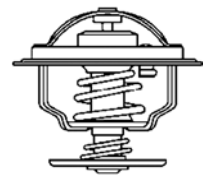
BMW

	Motor Engine Moteur	Ltr. Ltr. Ltr.	Jahr Year Année	Einschränkung Restriction* Restriction*	Thermostat Thermostat Thermostat
525 i 24V	M 50	2.5	1989.09 - 1995.09		4236.88D
525 i 24V	M 50	2.5	1989.09 - 1995.09	Leitung Drosselklappe zum Zylinderkopf	7129.00D ▲
525 ix	M 50	2.5	1992.02 - 1997.01		4236.88D
525 ix	M 50	2.5	1992.02 - 1997.01	Leitung Drosselklappe zum Zylinderkopf	7129.00D ▲
525 iX 24V	M 52	2.5	1991.10 - 1995.09		4236.88D
525 iX 24V	M 52	2.5	1991.10 - 1995.09	Leitung Drosselklappe zum Zylinderkopf	7129.00D ▲
525 td	M 51	2.5	1993.03 - 1997.01		4237.80D
525 tds	M 51	2.5	1991.09 - 1997.01		4237.80D
530 i	M 30	3.0	1988.01 - 1991.08		4235.80D
530 i V8	M 60	3.0	1992.09 - 1997.01	mit Katalysator	4516.85D
530 i V8	M 60	3.0	1992.09 - 1997.01	ohne Katalysator	4519.95D
535 i	M 30	3.4	1988.01 - 1995.09		4235.80D
540 i	M 60	4.0	1992.09 - 1997.01	mit Katalysator	4516.85D
540 i	M 60	4.0	1992.09 - 1997.01	ohne Katalysator	4519.95D
M 3.6	S 38 B36	3.5	1988.10 - 1992.05	Dichtring	120213
M 3.6	S 38 B36	3.5	1988.10 - 1992.05		4619.80
M 3.8	S 38 B38	3.8	1992.03 - 1997.01	Dichtring	120213
M 3.8	S 38 B38	3.8	1992.03 - 1997.01		4619.80
5 Serie (E39)					
520 i	M 52	2.0	1996.01 - 1998.09		4236.92D
520 i	M 52	2.0	1998.09 - 2004.05		4326.97D
520 i	M 54	2.2	2000.09 - 2004.05		4326.97D
523 i	M 52	2.5	1995.11 - 1998.09		4236.92D
523 i	M 52	2.5	1998.09 - 2000.09		4326.97D
525 i	M 54	2.5	2000.09 - 2004.05		4326.97D
525 td	M 51	2.5	1997.01 - 2003.06		4237.80D
525 tds	M 51	2.5	1996.01 - 2004.05		4237.80D
528 i	M 52	2.8	1995.11 - 1998.08		4236.92D
528 i	M 52	2.8	1998.08 - 2000.09		4326.97D
530 i	M 54	3.0	2000.09 - 2004.05		4326.97D
M 4.9	S 62 B50, S 38 B49	4.9	1998.10 - 2003.06	Dichtring	120213
M 4.9	S 62 B50, S 38 B49	4.9	1998.10 - 2003.06		4619.80
5 Serie (E60)					
520 i	M 54	2.2	2003.07 - 2010.03		4326.97D
520 i	N 43	2.0	2007.09 - 2010.03		411574.102D ▲
523 i	N 52	2.5	2005.07 - 2010.03		410086.97D0
525 i	M 54	2.5	2003.09 - 2010.03		4326.97D
525 i	N 52	2.5	2005.07 - 2010.03		410086.97D0
525 i	N 53	3.0	2007.01 - 2010.03		410086.97D0
525 xi	N 52	2.5	2005.07 - 2010.03		410086.97D0
525 xi	N 53	3.0	2007.01 - 2010.03		410086.97D0
530 i	M 54	3.0	2003.07 - 2010.03		4326.97D
530 i	N 52	3.0	2005.03 - 2010.03		410086.97D0
530 i	N 52	3.0	2007.01 - 2010.03		410086.97D0
530 xi	N 52	3.0	2005.07 - 2010.03		410086.97D0
530 xi	N 52	3.0	2007.01 - 2010.03		410086.97D0
540 i	N 62	4.0	2005.07 - 2010.03		4508.105D
540 i	N 54	3.0	2005.08 - 2010.03		4508.105D
545 i	N 62	4.4	2003.09 - 2010.03		4508.105D
550 i	N 62	4.8	2005.07 - 2010.03		4508.105D

BMW

 Motor
Engine
Moteur

 Ltr.
Ltr.
Ltr.

 Jahr
Year
Année

 Einschränkung
Restriction*
Restriction*

 Thermostat
Thermostat
Thermostat

5 Serie (E61)

520 i	N 43	2.0	2007.09 -		411574.102D ▲
523 i	N 52	2.5	2005.07 -		410086.97D0
525 i	M 54	2.5	2004.06 -		4326.97D
525 i	N 52	2.5	2005.07 -		410086.97D0
525 i	N 53	3.0	2007.01 -		410086.97D0
525 i	N 53	3.0	2008.09 -		410086.97D0
525 xi	N 52	2.5	2005.07 -		410086.97D0
525 xi	N 52	3.0	2007.01 -		410086.97D0
530 i	M 54	3.0	2004.06 -		4326.97D
530 i	N 52	3.0	2005.07 -		410086.97D0
530 i	N 52	3.0	2007.01 -		410086.97D0
530 xi	N 52	3.0	2005.07 -		410086.97D0
545 i	N 63	4.4	2004.06 -		4508.105D
550 i	N 62	4.8	2005.07 -		4508.105D

5 Serie (F10 / 11)

535 i	N 55	3.0	2010.03 -		410766.103D0 ▲
550 i	N 63	4.4	2010.03 -		4508.105D

5 GRAN TURISMO (F07)

535 i	N 55	3.0	2009.10 -		410766.103D0 ▲
550 i	N 63	4.4	2009.10 -		4508.105D

6 Serie (E24)

628 CSi	M 30	2.8	1979.09 - 1985.08		4231.80D
628 CSi	M 30	2.8	1985.08 - 1987.08		4235.80D
630 CS	M 30	3.0	1976.04 - 1979.08		4235.80D
633 CSi	M 30	3.2	1976.04 - 1984.08		4231.80D
635 CSi	M 30	3.4	1978.06 - 1985.07		4231.80D
635 CSi	M 30	3.4	1985.08 - 1990.09		4235.80D

6 Serie (E63)

630 i	N 52	3.0	2004.09 -		410086.97D0
645 Ci	N 62	4.4	2004.01 -		4508.105D
650 i	N 62	4.8	2005.07 -		4508.105D

6 Serie (E64)

630 i	N 52	3.0	2004.09 -		410086.97D0
645 Ci	N 62	4.4	2004.04 -		4508.105D
650 i	N 62	4.8	2005.07 -		4508.105D

6 Cabriolet (F12)

640 i	N 55	3.0	2011.03 -		410766.103D0 ▲
650 i	N 63	4.4	2011.03 -		4508.105D
M	S 63 B44 B	4.4	2012.01 -		4508.105D

6 Coupe (F13)

650 i	N 63	4.4	2010.11 -		4508.105D
-------	------	-----	-----------	--	-----------

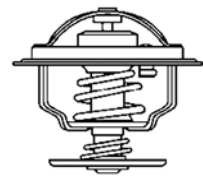

BMW

	Motor Engine Moteur	Ltr. Ltr. Ltr.	Jahr Year Année	Einschränkung Restriction* Restriction*	Thermostat Thermostat Thermostat
7 Serie (E23)					
728	M 30	2.8	1977.05 - 1979.08		4231.80D
728 i	M 30	2.8	1978.07 - 1986.08		4235.80D
730	M 30	3.0	1977.05 - 1979.08		4235.80D
733 i	M 30	3.2	1977.05 - 1979.09		4231.80D
735 i	M30 B35 (Motronic,9.3:1)	3.5	1979.09 - 1986.08	9,3:1	4231.80D
735 i	M30 B35 (Motronic,10:1), M30 B35 (Motronic,8:1,Kat.), M30 B34 (346KA)	3.4	1979.09 - 1986.08	8:1 / 10:1	4235.80D
745 i	M30 B32 (Turbo)	3.2	1980.04 - 1983.04		4231.80D
745 i	M 30	3.4	1983.05 - 1986.08		4231.80D
7 Serie (E32)					
730 i	M 30	3.0	1986.12 - 1994.09		4235.80D
730 i V8	M 60	3.0	1992.04 - 1994.09	mit Katalysator	4516.85D
730 i V8	M 60	3.0	1992.04 - 1994.09	ohne Katalysator	4519.95D
735 i	M 30	3.4	1986.09 - 1992.09		4235.80D
740 i V8	M 60	4.0	1992.04 - 1994.09	mit Katalysator	4516.85D
740 i V8	M 60	4.0	1992.04 - 1994.09	ohne Katalysator	4519.95D
750 i V12	M 70	5.0	1987.09 - 1994.09	70° Variante	4516.70D
750 i V12	M 70	5.0	1987.09 - 1994.09	85° Variante	4516.85D
7 Serie (E38)					
725 tds	M 51	2.5	1996.04 - 2001.11		4237.80D
728 i	M 52	2.8	1995.08 - 1998.09		4236.92D
728 i	M 52	2.8	1998.09 - 2001.11		4326.97D
730 i	M 60	3.0	1994.10 - 2001.11	mit Katalysator	4516.85D
730 i	M 60	3.0	1994.10 - 2001.11	ohne Katalysator	4519.95D
740 i	M 60	4.0	1994.10 - 2001.11	mit Katalysator	4516.85D
740 i	M 60	4.0	1994.10 - 2001.11	ohne Katalysator	4519.95D
750 i	M 73	5.4	1994.12 - 2001.11		4594.90D
7 Serie (E65, E66)					
730 i	M 54	3.0	2003.03 -		4326.97D
730 i	N 52	3.0	2005.03 -		410086.97D0
735 i	N 62	3.6	2001.11 -		4508.105D
735 i	N 62	4.0	2005.03 -		4508.105D
740 i	N 62	4.0	2005.07 -		4508.105D
745 i	N 62	4.4	2001.11 -		4508.105D
750 i	N 62	4.8	2005.07 -		4508.105D
760	N 73	6.0	2003.02 - 2005.08		4508.105D
760 i	N 73	6.0	2003.01 -		4508.105D
7 (F01, F02, F03, F04)					
750 i	N 63	4.4	2008.10 -		4508.105D
760 i	N 74	6.0	2009.09 -		4508.105D
ActiveHybrid	N 63	4.4	2010.10 -		4508.105D
8 Serie (E31)					
840 i	M 60	4.0	1993.02 - 1996.02	mit Katalysator	4516.85D
840 i	M 60	4.0	1993.02 - 1996.02	ohne Katalysator	4519.95D
850 Ci	M 73	5.4	1994.09 - 1999.12		4594.90D
850 CSi	M 70	5.6	1993.04 - 1999.12		4516.85D
850 i, Ci	M 70	5.0	1990.04 - 1994.10	70° Variante	4516.70D
850 i, Ci	M 70	5.0	1990.04 - 1994.10	85° Variante	4516.85D

BMW
**Motor
Engine
Moteur**
**Ltr.
Ltr.
Ltr.**
**Jahr
Year
Année**
**Einschränkung
Restriction*
Restriction***
**Thermostat
Thermostat
Thermostat**
M1

3.5	M 88	3.5	1979.05 - 1983.05		4231.80D
-----	------	-----	-------------------	--	----------

X1 (E84)

sDrive 18 i	N 46	2.0	2010.01 -		4337.105D
xDrive 25 i	N 52 B30 A	3.0	2009.10 -		410086.97D0
xDrive 28 i	N 52 B30 A	3.0	2009.10 -		410086.97D0

X3 (E83)

2.0 i	N 46	2.0	2005.07 -		4337.105D
2.5 i	M 54	2.5	2004.01 -		4326.97D
2.5 si	N 52	2.5	2006.09 -		410086.97D0
3.0 i xDrive	M 54	3.0	2004.01 -		4326.97D
3.0 si	N 52	3.0	2006.09 -		410086.97D0
xDrive 20 i	N 46	2.0	2008.09 -		4337.105D
xDrive 25 i	N 52	2.5	2008.09 -		410086.97D0
xDrive 30 i	N 52	3.0	2008.09 -		410086.97D0

X3 (F25)

xDrive 28 i	N 52	3.0	2011.04 -		410086.97D0
xDrive 35 i	N 55	3.0	2010.09 -		410766.103D0 ▲

X5 (E53)

3.0 i	M 54	3.0	2000.05 -		4326.97D
4.4 i	N 62	4.4	2003.12 -		4508.105D
4.8 is	N 62	4.8	2004.04 -		4508.105D

X5 (E70)

3.0 si	N 52	3.0	2007.02 - 2008.09		410087.97D0
4.8 i	N 62	4.8	2007.02 - 2008.09		4508.105D
M	S 63 B44 A	4.4	2009.09 -		4508.105D
xDrive 30 i	N 52	3.0	2008.09 - 2010.03		410087.97D0
xDrive 35 i	N 55	3.0	2010.09 -		410766.103D0 ▲
xDrive 48 i	N 62	4.8	2008.09 -		4508.105D
xDrive 50 i	N 63	4.4	2010.09 -		4508.105D

X6 (E71, E72)

35 i	N 54	3.0	2008.05 -		410087.97D0
50 i	N 63	4.4	2008.05 -		4508.105D
ActiveHybrid	N 63	4.4	2010.10 -		4508.105D
M	S 63 B44 A	4.4	2009.09 -		4508.105D
xDrive 35 i	N 54	3.0	2008.09 -		410087.97D0
xDrive 35 i	N 55	3.0	2008.09 -		410766.103D0 ▲
xDrive 35 i	N 55	3.0	2012.01 -		410766.103D0 ▲
xDrive 50 i	N 63	4.4	2008.09 -		4508.105D

Z1

2.5	M 20	2.5	1988.06 - 1991.06		4235.80D
-----	------	-----	-------------------	--	----------

BMW

	Motor Engine Moteur	Ltr. Ltr. Ltr.	Jahr Year Année	Einschränkung Restriction* Restriction*	Thermostat Thermostat Thermostat
Z3 (E36)					
1.8	M 43	1.8	1995.10 - 1998.10		410792.95D
1.9	M 43	1.9	1998.07 - 2003.01		411573.105D ▲
2.0	M 52	2.0	1999.04 - 2003.01		4326.97D
2.2	M 54	2.2	2000.08 - 2003.01		4326.97D
2.8	M 52	2.8	1997.04 - 1998.09		4236.92D
2.8	M 52	2.8	1998.09 - 2000.07		4326.97D
3.0	M 54	3.0	2000.06 - 2003.01		4326.97D
M 3.2	S 50	3.2	1997.03 - 2001.06		4621.80D
M 3.2	S 50	3.2	2000.04 - 2001.04		4621.80D
M 3.2	S 54	3.2	2001.06 - 2003.01		4621.80D
2.8	M 52	2.8	1997.07 - 1998.09		4236.92D
2.8	M 52	2.8	1998.09 - 2000.06		4326.97D
3.0	M 54	3.0	2000.06 - 2003.06		4326.97D
M	S 50	3.2	1998.02 - 2003.06		4621.80D
M	S 54	3.2	2001.06 - 2003.06		4621.80D
Z4 (E85, E86)					
2.0 i	N 46	2.0	2005.04 -		4337.105D
2.2 i	M 54	2.2	2003.10 -		4326.97D
2.5 i	M 54	2.5	2003.02 -		4326.97D
2.5 i	N 52	2.5	2006.01 -		410086.97D0
2.5 si	N 52	2.5	2006.01 -		410086.97D0
3.0 i	M 54	3.0	2003.02 -		4326.97D
3.0 si	N 52	3.0	2006.01 -		410086.97D0
M	S 54	3.2	2006.03 -		4621.80D
Z4 (E89)					
sDrive 23 i	N 52	2.5	2009.05 -		410086.97D0
sDrive 30 i	N 52	3.0	2009.05 -		410086.97D0
sDrive 35 i	N 54	3.0	2009.05 -		410086.97D0
sDrive 35 is	N 54	3.0	2010.09 -		410086.97D0
Z8 (E52)					
4.9	S 62 B50, S 38 B49	4.9	2000.06 - 2003.06	Dichtring	120213
4.9	S 62 B50, S 38 B49	4.9	2000.06 - 2003.06		4619.80

CHEVROLET

 Motor
Engine
Moteur

 Ltr.
Ltr.
Ltr.

 Jahr
Year
Année

 Einschränkung
Restriction*
Restriction*

 Thermostat
Thermostat
Thermostat

ASTRA

2.0	X 20 XEV	2.0	1999.03 - 2002.07		4183.92D
2.0 Dti	Y 20 DTH	2.0	2002.08 - 2011.12	Motor no. →17B49754	4198.92D
2.0 Dti	Y 20 DTH	2.0	2002.08 - 2011.12	Motor no. 2(2/5/6/8/B/H) 999999→	4428.92D
2.0 Dti	Y 20 DTH	2.0	2002.09 - 2011.12	Motor no. 17B49755→	4428.92D
2.0 Dti	Y 20 DTH	2.0	2002.09 - 2011.12	Motor no. 2(2/5/6/8/B/H) 999999→	4433.92D

AVEO (T250, T255)

1.2	F12S3, LQ5	1.2	2006.03 - 2007.12	SOHC	3017.87D2
1.2	LMU, B12D1	1.2	2008.01 -		410183.88D
1.2	F12S3	1.2	2008.10 -		3017.87D2
1.2 LPG	LMU, B12D1	1.2	2008.04 -		410183.88D
1.4	F14D3, L14	1.4	2006.03 - 2007.12		3017.87D2
1.4	A 14 XER, LDT, F14D4	1.4	2008.04 -		3017.87D2
1.4	F14D4	1.4	2008.09 -		3017.87D2
1.6	LXV, A16DMS	1.6	2006.01 -	2-teiliges Aluminiumgehäuse	3017.87D2

AVEO (T300)

1.6	F16D4	1.6	2011.03 -		411059.105D ▲
1.6	0	1.6	2012.12 -		4431.105D

CAPTIVA

2.4	Z 24 SED	2.4	2006.06 -		4189.87D
2.4	A 24 XE, LE5	2.4	2011.03 -		411193.82D
2.4 LPG	Z 24 SED	2.4	2007.01 -		4189.87D

CORSA Kombi

1.6	X 16 XE	1.6	1997.08 - 2002.07		4178.92D
-----	---------	-----	-------------------	--	-----------------

CORSA Pick-up

1.6		1.6	1994.08 - 2002.07		4178.92D
-----	--	-----	-------------------	--	-----------------

CRUZE (J300, J305, J308))

1.6		1.6	2012.12 -		4431.105D
1.6 T		1.6	2012.12 -		4431.105D
1.8	2H0, F18D4, LUW	1.8	2009.05 -		4431.105D
1.8 LPG	2H0, F18D4	1.8	2011.06 -		4431.105D

EPICA (KL1_)

2.0		2.0	2006.08 -		4183.92D
-----	--	-----	-----------	--	-----------------

EVANDA

2.0	X 20 SED	2.0	2005.03 -		4189.87D
-----	----------	-----	-----------	--	-----------------

HHR

2.4		2.4	2007.10 -		411193.82D
-----	--	-----	-----------	--	-------------------

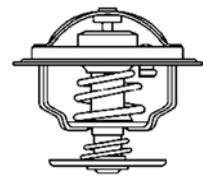

CHEVROLET

	Motor Engine Moteur	Ltr. Ltr. Ltr.	Jahr Year Année	Einschränkung Restriction* Restriction*	Thermostat Thermostat Thermostat
KALOS					
1.2	B12S1	1.2	2005.03 -		410183.88D
1.4	F14S3	1.4	2005.03 -		410183.88D
1.4 16V	F14D3	1.4	2005.03 -		3017.87D2
LACETTI (J200)					
1.4		1.4	2005.03 -	2-teiliges Aluminiumgehäuse	3017.87D2
1.4 16V	F14D3	1.4	2005.03 -	2-teiliges Aluminiumgehäuse	3017.87D2
1.6	F16D3	1.6	2005.03 -	2-teiliges Aluminiumgehäuse	3017.87D2
1.8	F18D3	1.8	2005.03 -	2-teiliges Aluminiumgehäuse	3017.87D2
1.8	T18SED	1.8	2005.03 -		4189.87D
MALIBU (V300)					
2.4	LE9	2.4	2012.01 -		411193.82D
MATIZ					
0.8	F8CV	0.8	2005.03 -		410183.82D
0.8 LPG	F8CV	0.8	2005.03 -		410183.82D
1.0	B10S, B10S1	1.0	2005.03 -		410183.82D
NUBIRA					
1.4	F14D3	1.4	2006.01 -		3017.87D2
1.6	F16D3	1.6	2005.03 -		3017.87D2
1.8	T18SED	1.8	2005.03 -		4189.87D
1.8	F18D3	1.8	2005.08 -		3017.87D2
OPTRA					
1.6	F16D3	1.6	2003.08 - 2008.12		3017.87D2
1.8	T18SED	1.8	2003.08 - 2008.12		4189.87D
2.0	X 20 SED	2.0	1999.06 - 2003.07		4189.87D
ORLANDO (J309)					
1.8	2H0, F18D4	1.8	2011.02 -		4431.105D
1.8 LPG	2H0	1.8	2011.06 -		4431.105D
REZZO					
2.0	T20SED	2.0	2005.03 -		4189.87D
SPARK					
0.8	F8CV	0.8	2000.09 - 2004.12		410183.82D
1.0	G 10 CV	1.0	2002.11 - 2004.12		410183.82D
TIGRA					
1.6	C 16 SE	1.6	1997.08 - 1999.12		4178.92D
VECTRA					
2.2	Z 22 YH	2.2	2005.01 - 2006.07		411193.82D

CHEVROLET

Motor
Engine
Moteur

Ltr.
Ltr.
Ltr.

Jahr
Year
Année

Einschränkung
Restriction*
Restriction*

Thermostat
Thermostat
Thermostat

VIVANT

1.6	A16DMS	1.6	2001.08 -		3017.92D2
2.0	X 20 SED	2.0	2000.08 -		4189.87D
2.0	T20SED	2.0	2005.01 -		4189.87D

ZAFIRA

2.2		2.2	2001.04 - 2004.07		411193.82D
2.2	Z 22 YH	2.2	2005.07 -		411193.82D

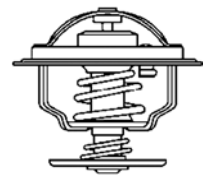

CHRYSLER

	Motor Engine Moteur	Ltr. Ltr. Ltr.	Jahr Year Année	Einschränkung Restriction* Restriction*	Thermostat Thermostat Thermostat
CROSSFIRE					
3.2	EGX	3.2	2003.07 - 2007.12		4281.87D
NEON					
1.6	EJD	1.6	2001.11 - 2006.12		410262.91D
1.8 16V	EBD	1.8	1997.09 - 1999.08		410262.91D
2.0 16V	420H, 420T, ECB, ECC, ECH	2.0	1994.05 - 2006.12		410262.91D
PT CRUISER					
1.6	EJD	1.6	2001.11 - 2010.12		410262.91D
2.0	ECC	2.0	2000.06 - 2010.12		410262.91D
2.4	EDZ	2.4	2000.06 - 2010.12		410262.91D
2.4 GT	EDV	2.4	2004.03 - 2008.03		410262.91D
GT 2.4	EDV	2.4	2003.08 - 2010.12		410262.91D
SEBRING					
2.0	ECC	2.0	2001.04 - 2007.06		410262.91D
2.4	EDZ	2.4	2001.04 - 2007.06		410262.91D
STRATUS					
2.0 16V	ECB	2.0	1995.12 -		410262.91D
2.0 LE	420X, C00	2.0	1996.06 - 2001.04		410262.91D
2.4 16 V	EDZ	2.4	1995.12 - 2001.04		410262.91D
2.5	625H	2.5	1996.04 - 2001.04		410180.82D
2.5 V6	EEB, H00	2.5	1995.12 - 2001.04		410180.82D
VOYAGER III (GS)					
2.5 TD	425 CLIRS, X, ENC	2.5	1995.01 - 2001.03		4158.80D
300 C (LX)					
3.0 CRD	M664	3.0	2005.09 - 2012.11		4630.87D ▲

CITROËN
**Motor
Engine
Moteur**
**Ltr.
Ltr.
Ltr.**
**Jahr
Year
Année**
**Einschränkung
Restriction*
Restriction***
**Thermostat
Thermostat
Thermostat**
AX

1.3 Sport	M4A	1.3	1987.04 - 1988.12		3136.88D50
1.4	K2A	1.4	1986.09 - 1992.07		3136.88D50
1.4 D	K9A (TUD3)	1.4	1991.06 - 1992.07		3136.88D50
1.4 GTi	KFY (TU3FJ2), KFZ (TU3FJ2)	1.4	1991.06 - 1996.12		3136.88D50
10	C1A, CDY (TU9M), CDZ (TU9M)	1.0	1986.07 - 1998.12		3136.88D50
10 E	C3A	1.0	1986.12 - 1988.12		3136.82D50
11	H1A, H1B, HAZ (TU1CP), HDZ (TU1M)	1.1	1986.12 - 1994.04		3136.88D50
14	K1F, K2B, K2A, KAY (TU3CP), KDY (TU3FM), KDZ (TU3M, Z), KDX (TU3M, Z), KDY (TU3M)	1.4	1987.01 - 1997.04		3136.88D50
14 D	K9A (TUD3), K9Y (TUD3Y)	1.4	1988.09 - 1992.06		4821.89D
15 D	VJY (TUD5), VJZ (TUD5)	1.5	1994.08 - 1997.12		4821.89D

BERLINGO

1.1 i	HDZ (TU1M)	1.1	1996.07 -		3136.88D50
1.1 i	HFX (TU1JP)	1.1	1996.07 -		410184.89D
1.4	KFW (TU3JP)	1.4	2002.11 - 2005.10		3463.89D
1.4 bivalent	KFW (TU3JP)	1.4	2002.11 -		3463.89D
1.4 GNC	KFW (TU3JP)	1.4	2002.11 -		3463.89D
1.4 Hybrid	KFW (TU3JP)	1.4	2005.05 -		3463.89D
1.4 i	KFX (TU3JP), KFW (TU3JP)	1.4	1996.07 -	Organisations no. →O 08210	3136.88D50
1.4 i	KFX (TU3JP), KFW (TU3JP)	1.4	1996.08 -	Organisations no. O 08211→	410184.89D
1.6	NFU (TU5JP4), NFR (TU5JP4B)	1.6	2008.04 -		410705.89D
1.6 16V	NFU (TU5JP4)	1.6	2000.10 - 2002.10		410184.89D
1.6 16V	NFU (TU5JP4)	1.6	2002.11 - 2005.08	Organisations no. →10527	3463.89D
1.6 16V	NFU (TU5JP4)	1.6	2005.08 -	Organisations no. 10528→	410705.89D
1.8 D	A9A (XUD7)	1.8	1996.07 - 1999.10		4446.83D
1.8 i	LFX (XU7JB)	1.8	1997.04 - 2002.10		3136.82D50
1.9 D	DW8, DW8B, XUD9A	1.9	1996.07 -		4446.83D
1.9 D 70	DW8, DW8B	1.9	1998.07 -		4446.83D
2.0 Hdi	RHY (DW10TD)	2.0	2002.11 - 2005.10		4446.83D
2.0 HDI 90	RHY (DW10TD)	2.0	1999.12 -		4446.83D

BX

1.6	B6E, B6D	1.6	1987.01 - 1992.01	82° Variante	3136.82D50
1.6	B6E, B6D	1.6	1987.01 - 1992.01	88° Variante	3136.88D50
1.9 DT TXD		1.9	1992.02 - 1994.12		4446.83D
1.9 GTi		1.9	1990.01 - 1994.06	82° Variante	3136.82D50
1.9 GTi		1.9	1990.01 - 1994.06	88° Variante	3136.88D50
1.9 RD		1.9	1987.01 - 1992.01	Organisations no. →O 5637	4147.80D
1.9 RD		1.9	1987.02 - 1992.01	Organisations no. O 5638→	4446.83D
11	H1A	1.1	1986.10 - 1992.06	82° Variante	3136.82D50
11	H1A	1.1	1986.10 - 1992.06	88° Variante	3136.88D50
11	HDZ (TU1M)	1.1	1988.10 - 1992.06	82° Variante	3136.82D50
11	HDZ (TU1M)	1.1	1988.10 - 1992.06	88° Variante	3136.88D50
14	150C	1.4	1986.01 - 1993.02	82° Variante	3136.82D50
14	150C	1.4	1986.01 - 1993.02	88° Variante	3136.88D50
14	K1H (TU3A), KDZ (TU3M, Z), KDY (TU3M)	1.4	1989.01 - 1989.12	82° Variante	3136.82D50

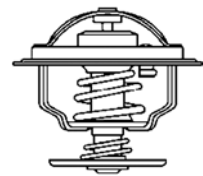

CITROËN

	Motor Engine Moteur	Ltr. Ltr. Ltr.	Jahr Year Année	Einschränkung Restriction* Restriction*	Thermostat Thermostat Thermostat
14	K1H (TU3A), KDZ (TU3M, Z), KDY (TU3M)	1.4	1989.01 - 1993.02	88° Variante	3136.88D50
14 E	150	1.4	1982.10 - 1993.03	82° Variante	3136.82D50
14 E	150	1.4	1982.10 - 1993.03	88° Variante	3136.88D50
15	B1E (XU51C)	1.5	1987.10 - 1992.05	82° Variante	3136.82D50
15	B1E (XU51C)	1.5	1987.10 - 1992.05	88° Variante	3136.88D50
16	171, 180, XU5	1.6	1982.10 - 1994.12	82° Variante	3136.82D50
16	171, 180, XU5	1.6	1982.10 - 1994.12	88° Variante	3136.88D50
16 E	BDY (XU5M), BDZ (XU5M)	1.6	1989.05 - 1993.02	82° Variante	3136.82D50
16 E	BDY (XU5M), BDZ (XU5M)	1.6	1989.05 - 1993.02	88° Variante	3136.88D50
18 D	XUD7	1.8	1985.10 - 1993.09	Organisations no. →O 5637	4147.80D
18 D	XUD7	1.8	1985.11 - 1993.09	Organisations no. O 5638→	4446.83D
19	159A, XU9	1.9	1986.07 - 1994.12	82° Variante	3136.82D50
19	159A, XU9	1.9	1986.07 - 1994.12	88° Variante	3136.88D50
19 D	XUD9	1.9	1983.09 - 1994.12	Organisations no. →O 5637	4147.80D
19 D	XUD9	1.9	1983.10 - 1994.12	Organisations no. O 5638→	4446.83D
19 E	D2F, XU9M	1.9	1988.06 - 1993.02		3136.82D50
19 GTi	D6A (XU9J2), DKZ (XU9JA)	1.9	1986.07 - 1993.02	82° Variante	3136.82D50
19 GTi	D6A (XU9J2), DKZ (XU9JA)	1.9	1986.07 - 1993.02	88° Variante	3136.88D50
19 GTi 16V	D6C (XU9J4), DFW (XU9J4)	1.9	1987.09 - 1988.12		3136.82D50
TRD Turbo	AJZ (XUD7TE), A8A (XUD7TE)	1.8	1988.03 - 1994.12	Organisations no. →O 5637	4147.80D
TRD Turbo	AJZ (XUD7TE), A8A (XUD7TE)	1.8	1988.04 - 1994.12	Organisations no. O 5638→	4446.83D
C 2					
1.1	HFX (TU1JP)	1.1	2003.09 -		410184.89D
1.4	KFV (TU3JP)	1.4	2003.09 -		410184.89D
1.4 16V	KFU (ET3J4)	1.4	2006.06 -		410705.89D
1.6	NFU (TU5JP4)	1.6	2003.09 -	Organisations no. →10401	410184.89D
1.6	NFU (TU5JP4)	1.6	2003.10 -	Organisations no. 10402→	410705.89D
1.6 VTS	NFS (TU5JP4S)	1.6 i	2005.01 -	Organisations no. →10401	410184.89D
1.6 VTS	NFS (TU5JP4S)	1.6 i	2005.02 -	Organisations no. 10402→	410705.89D
C 3					
1.1 i	HFX (TU1JP)	1.1	2002.02 -		410184.89D
1.4	KFV (TU3JP)	1.4	2003.05 -		410184.89D
1.4 16V	KFU (ET3J4)	1.4	2003.11 -	Organisations no. →10373	410184.89D
1.4 16V	KFU (ET3J4)	1.4	2003.12 -	Organisations no. 10374→	410705.89D
1.4 Hybrid	KFV (TU3JP)	1.4	2005.05 -		410184.89D
1.4 i	KFV (TU3JP), KFV (TU3A)	1.4	2002.02 -		410184.89D
1.4 i Bivalent	KFV (TU3JP)	1.4	2002.02 -		410184.89D
1.6	NFU (TU5JP4)	1.6	2003.05 -	Organisations no. →10401	410705.89D
1.6	NFU (TU5JP4)	1.6	2003.06 -	Organisations no. 10402→	410184.89D
1.6 16V	NFU (TU5JP4)	1.6	2002.02 -	Organisations no. →10401	410184.89D
1.6 16V	NFU (TU5JP4)	1.6	2002.03 -	Organisations no. 10402→	410705.89D

CITROËN	Motor Engine Moteur	Ltr. Ltr. Ltr.	Jahr Year Année	Einschränkung Restriction* Restriction*	Thermostat Thermostat Thermostat
C 4					
1.4 16V	KFU (ET3J4)	1.4	2004.11 -	Organisations no. →10436	3463.89D
1.4 16V	KFU (ET3J4)	1.4	2004.12 -	Organisations no. 10437→	410705.89D
1.6 16V	NFU (TU5JP4)	1.6	2004.11 -	Organisations no. →10436	3463.89D
1.6 16V	NFU (TU5JP4)	1.6	2004.12 -	Organisations no. 10437→	410705.89D
1.6 16V Bio-Flex	NFU (TU5JP4)	1.6	2007.07 -	Organisations no. →10436	3463.89D
1.6 16V Bio-Flex	NFU (TU5JP4)	1.6	2007.08 -	Organisations no. 10437→	410705.89D
1.6 Flex		1.6	2009.02 -		410705.89D
1.8 i 16V	6FY (EW7A)	1.8	2006.10 -	Organisations no. 11074→	3483.89D
2.0 16V	RFN (EW10J4), RFK (EW10J4S)	2.0	2004.11 -		3483.89D
2.0 i 16V	RFJ (EW10A)	2.0	2006.10 -	Organisations no. 11074→	3483.89D
C5 I (DC, DE)					
1.8 16V	6FZ (EW7J4)	1.8	2001.03 - 2004.08		3483.89D
2.0 16V	RFN (EW10J4)	2.0	2001.03 - 2004.08		3483.89D
2.0 16V HPi	RLZ (EW10D)	2.0	2001.03 - 2004.08		3483.89D
2.0 HDi	DW10TD, DW10ATED,	2.0	2001.03 - 2004.08		4446.83D
2.2 HDi	4HX (DW12TED4, FAP)	2.2	2001.03 - 2004.08		4446.83D
C 5 II (RC, RE)					
1.8 16V	6FY (EW7A), 6FZ (EW7J4)	1.8	2004.09 -	Organisations no. 10921→	3483.89D
2.0 16V	RFJ (EW10A)	2.0	2004.09 -		3483.89D
2.2 HDi	4HX (DW12TED4, FAP)	2.2	2004.09 -		4446.83D
C 5 III (RD, TD)					
1.8 16V	6FY (EW7A)	1.8	2008.02 -		3483.89D
2.0 16V	RFJ (EW10A)	2.0	2008.02 -		3483.89D
2.0 16V BioFlex	RFJ (EW10A)	2.0	2008.02 -		3483.89D
C 8					
2.0	RFN (EW10J4)	2.0	2002.07 -		3483.89D
2.0 16V	RFJ (EW10A)	2.0	2005.09 -		3483.89D
2.0 HDi	RHT (DW10ATED4), RHM (DW10AT- ED4), RHW (DW10ATED4)	2.0	2002.07 -		4446.83D
2.2	3FZ (EW12J4)	2.2	2002.07 -		3483.89D
2.2 HDi	4HW (DW12TED4)	2.2	2002.07 -		4446.83D
C 15					
1.0	XV8, TU9	1.0	1984.10 - 1997.12	Organisations no. →O 4195	3136.82D50
1.0	XV8, TU9	1.0	1984.11 - 1997.12	Organisations no. O 4196→	3136.88D50
1.0 E	TU9K	1.0	1992.11 - 1996.07	Organisations no. →O 4195	3136.82D50
1.0 E	TU9K	1.0	1992.12 - 1996.07	Organisations no. O 4196→	3136.88D50
1.1	109K, E1A, H1A	1.1	1984.10 - 1996.12	Organisations no. →O 4195	3136.82D50

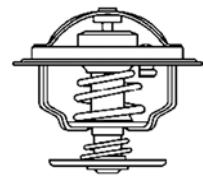

CITROËN

	Motor Engine Moteur	Ltr. Ltr. Ltr.	Jahr Year Année	Einschränkung Restriction* Restriction*	Thermostat Thermostat Thermostat
1.1	109K, E1A, H1A	1.1	1984.11 - 1996.12	Organisations no. O 4196→	3136.88D50
1.1 i	HDZ (TU1M)	1.1	1988.07 - 1996.12		3136.88D50
1.4	K1H (TU3A)	1.4	1987.07 - 1996.12	Organisations no. →O 4195	3136.82D50
1.4	K1H (TU3A)	1.4	1987.08 - 1996.12	Organisations no. O 4196→	3136.88D50
1.4 E	150D (XY7)	1.4	1987.05 - 1996.12	Organisations no. →O 4195	3136.82D50
1.4 E	150D (XY7)	1.4	1987.06 - 1996.12	Organisations no. O 4196→	3136.88D50
1.4 E	K3A	1.4	1987.07 - 1996.12		3136.88D50
1.4 i	KDY (TU3FM), KDY (TU3M)	1.4	1991.05 - 1996.12		3136.88D50
1.8 D	161A (XUD7)	1.8	1986.07 - 2000.12	Organisations no. →O 5653	4147.80D
1.8 D	161A (XUD7)	1.8	1986.08 - 2000.12	Organisations no. O 5654→	4446.83D
1.9 D	WJX (DW8B)	1.9	2000.12 - 2005.12		4446.83D
C 25					
1.8 E	169 (XM7T)	1.8	1987.07 - 1994.02		3061.82
1.9 DT		1.9	1991.10 - 1994.01		3431.80D
1.9 TD	M705	1.9	1992.04 - 1994.02		3431.80D
2.0	170C (XN1T)	2.0	1987.01 - 1994.03		3061.82
2.0 E	170B (XN1T), 170A (XN1T)	2.0	1981.09 - 1994.03		3061.82
2.5 D	CRD93L (U25-661)	2.5	1985.10 - 1994.02		3033.84D ▲
2.5 D Turbo	CRD93LS (U25-673)	2.5	1987.08 - 1994.02		3033.84D ▲
C-ELYSEE					
1.6 VTi 115	NFP (EC5)	1.6	2012.11 -		410705.89D
CX					
20	829 A5	2.0	1985.08 - 1986.08		3033.84D ▲
20 RE	829 A5	2.0	1985.08 - 1992.12		3033.84D ▲
2000	M20-616	2.0	1974.09 - 1979.05		3033.84D ▲
2000	829 A5	2.0	1979.06 - 1985.08		3033.84D ▲
22 TRS	J6T A500	2.2	1985.07 - 1992.12		3033.84D ▲
2200	M22-617	2.2	1974.09 - 1976.07		3033.84D ▲
2200	J6T A500	2.2	1981.06 - 1985.08		3033.84D ▲
2400	M23-623, M23-639	2.4	1976.08 - 1982.05		3033.84D ▲
2400 GTi	M23-622	2.4	1977.06 - 1983.06		3033.84D ▲
25 D	M25-660	2.5	1985.08 - 1992.12		3033.84D ▲
25 D Turbo	M25-648, M25-669	2.5	1983.04 - 1992.12		3033.84D ▲
25 GTi	M25-668	2.5	1986.05 - 1992.12		3033.84D ▲
25 GTi Turbo 2	M25-662, M25-667	2.5	1984.06 - 1992.12		3033.84D ▲
25 i	M25-668	2.5	1986.05 - 1992.12		3033.84D ▲
25 TRI	M25-659	2.5	1983.07 - 1992.12		3033.84D ▲
2500 D	M25-629	2.5	1978.02 - 1985.08		3033.84D ▲
2500 D Turbo	M25-648	2.5	1983.04 - 1986.12		3033.84D ▲
EVASION (22, U6)					
1.8		1.8	1996.02 - 1996.12	Organisations no. →O 07195	3136.88D50
1.8		1.8	1996.03 - 1996.12	Organisations no. O 07196→	3136.82D50
1.8	LFZ (XU7JP)	1.8	1997.05 - 2002.07		3136.88D50
1.9 TD	XUD9TF	1.9	1994.11 - 2002.07		4446.83D

CITROËN
**Motor
Engine
Moteur**
**Ltr.
Ltr.
Ltr.**
**Jahr
Year
Année**
**Einschränkung
Restriction*
Restriction***
**Thermostat
Thermostat
Thermostat**

2.0	RFU (XU10J2, C)	2.0	1994.06 - 2002.07	Organisations no. →O 07195	3136.88D50
2.0	RFU (XU10J2, C)	2.0	1994.07 - 2002.07	Organisations no. O 07196→	3136.82D50
2.0 16V	RFV (XU10J4R)	2.0	1998.05 - 2000.04		4450.83D
2.0 16V	RFN (EW10J4)	2.0	2000.05 - 2002.07		3463.89D
2.0 HDI	RHZ (DW10ATED)	2.0	1999.08 - 2002.07		4446.83D
2.0 HDI 16V	RHW (DW10ATED4)	2.0	1999.09 - 2002.07		4446.83D
2.0 Turbo C.T.	RGX (XU10J2TE)	2.0	1994.06 - 2002.07	Organisations no. →O 07195	3136.88D50
2.0 Turbo C.T.	RGX (XU10J2TE)	2.0	1994.07 - 2002.07	Organisations no. O 07196→	3136.82D50
2.1 TD	P8C (XUD11BTE)	2.1	1996.05 - 2002.07		4446.83D

JUMPER (230)

1.9 D	XUD9A, U	1.9	1994.02 - 2002.04		4446.83D
1.9 TD	DHX (XUD9TF, BTF)	1.9	1994.02 - 2002.04		4450.83D
2.0	RFW (XU10J2U)	2.0	1994.02 - 2002.04	Organisations no. →O 07195	3136.88D50
2.0	RFW (XU10J2U)	2.0	1994.03 - 2002.04	Organisations no. O 07196→	3136.82D50
2.0 HDI	RHV (DW10UTD)	2.0	2001.11 - 2002.04		4446.83D
2.5 D	T9A (DJ5)	2.5	1994.03 - 2002.04	Einbauseite Zylinderkopf	410058.84D
2.5 TD	T8A (DJ5T)	2.5	1994.03 - 2002.04	Einbauseite Zylinderkopf	410058.84D
2.5 TDi	THX (DJ5TED)	2.5	1996.12 - 2002.04	Einbauseite Zylinderkopf	410058.84D
2.8 HDi	8140.43S	2.8	2000.09 - 2002.04	82° Variante	4174.82D
2.8 HDi	8140.43S	2.8	2000.09 - 2002.04	88° Variante	4174.88D ▲

JUMPER (244)

2.0	XU10J2	2.0	2002.04 -		3136.82D50
2.0 bivalent	XU10J2	2.0	2003.02 -		3136.82D50
2.0 HDi	RHV (DW10TD), RHV (DW10UTD)	2.0	2002.04 -		4446.83D
2.0 i	RFH (EW10A)	2.0	2007.01 -		3483.89D
2.2 HDi	4HY (DW12UTED)	2.2	2002.02 - 2006.06		4446.83D
2.2 HDi 16V	4HY (DW12UTED)	2.2	2002.04 -		4446.83D
2.8 HDi	8140.43N, 8140.43S	2.8	2002.04 -	82° Variante	4174.82D
2.8 HDi	8140.43N, 8140.43S	2.8	2002.04 -	88° Variante	4174.88D ▲

JUMPER

2.2 HDi 100	4HV (P22DTE)	2.2	2006.04 -		3497.88D
2.2 HDi 110		2.2	2011.07 -		3497.88D
2.2 HDi 120	4HU (P22DTE)	2.2	2006.04 -		3497.88D
2.2 HDi 130		2.2	2011.07 -		3497.88D
2.2 HDi 150		2.2	2011.07 -		3497.88D
3.0 HDi 145	F1CE3481N	3.0	2010.07 -		410075.79D ▲
3.0 HDi 155	F1CE0481D (F30DT)	3.0	2010.07 -		410075.79D ▲
3.0 HDi 160	F1CE0481D (F30DT)	3.0	2006.09 -		410075.79D ▲
3.0 HDi 180		3.0	2011.07 -		410075.79D ▲

JUMPY

1.9 D	D9B (XUD9A, U)	1.9	1995.10 - 1998.08		4446.83D
1.9 D 70	DW8, DW8B	1.9	1998.04 -		4446.83D
1.9 DT		1.9	1995.10 - 2000.08		4446.83D
1.9 TD	D8B (XUD9TF), DHX (XUD9TF, BTF)	1.9	1995.10 -		4446.83D

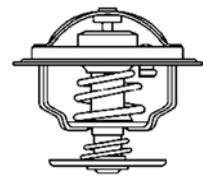

CITROËN

	Motor Engine Moteur	Ltr. Ltr. Ltr.	Jahr Year Année	Einschränkung Restriction* Restriction*	Thermostat Thermostat Thermostat
2.0	RFN (EW10J4)	2.0	2000.04 - 2006.12		3463.89D
2.0 HDi 110	RHZ (DW10ATED)	2.0	2000.03 -		4446.83D
2.0 HDi 95	RHX (DW10BTED)	2.0	1999.10 -		4446.83D
2.0 i	RFH (EW10A)	2.0	2007.01 -		3483.89D
2.0 i 16V		2.0	2000.03 -		3463.89D
LNA					
0.6	V06 644	0.6	1982.07 - 1985.04		3136.82D50
1.0	108C	1.0	1984.07 - 1986.10		3136.82D50
1.1	109, 5E	1.1	1982.07 - 1985.04		3136.82D50
NEMO					
1.4	KFT (TU3A), KFV (TU3A)	1.4	2008.02 -		410184.89D
SAXO					
1.0 X	CDZ (TU9M)	1.0	1996.05 - 2003.06		3136.88D50
1.1 X, SX	HDZ (TU1M)	1.1	1996.05 - 2003.09		3136.88D50
1.1 X, SX	HFX (TU1JP)	1.1	1996.05 - 2003.09		410184.89D
1.4 VTS	KFX (TU3JP), KFW (TU3JP)	1.4	1996.05 - 2003.06		3136.88D50
1.5 D	VJZ (TUD5)	1.5	1996.09 - 2004.04		4821.89D
1.6	NFZ (TU5JP)	1.6	1996.02 - 2003.06	66 kW, Organisations no. →08210	3136.88D50
1.6	NFX (TU5JP4)	1.6	1996.02 - 2004.04	88 kW	3136.88D50
1.6	NFZ (TU5JP)	1.6	1996.03 - 2003.06	66 kW, Organisations no. 08211→	410184.89D
1.6	NFT	1.6	2001.02 - 2004.04	Automatikgetriebe, 74 kW	3463.89D
1.6	NFT	1.6	2001.02 - 2004.04	Schaltgetriebe, 74 kW	410184.89D
1.6 VTL, VTR, VTS	NFZ (TU5JP), NFX (TU5JP4)	1.6 i	1996.05 - 2003.09		3136.88D50
VISA					
1.0	XV8	1.0	1984.09 - 1988.06		3136.82D50
11	109, 5, 109, 5F, 109K	1.1	1978.09 - 1991.03		3136.82D50
14	150D (XY7)	1.4	1984.07 - 1991.03		3136.82D50
14 GT	150B (XY8), 180A (XU5J), B6D	1.4	1982.03 - 1991.03		3136.82D50
16 GTI		1.6	1985.01 - 1986.06		3136.82D50
17 D	161A (XUD7)	1.7	1984.04 - 1991.03		4147.80D
II Super X	129, 5	1.2	1980.07 - 1982.06		3136.82D50
XANTIA (X1)					
1.6 i	BFZ (XU5JP)	1.6 i	1980.07 - 1998.01	82° Variante	3136.82D50
1.6 i	BFZ (XU5JP)	1.6 i	1980.07 - 1998.01	88° Variante	3136.88D50
1.8 i	LFX (XU7JB), LFZ (XU7JP)	1.8	1993.03 - 1998.01	82° Variante	3136.82D50
1.8 i	LFX (XU7JB), LFZ (XU7JP)	1.8	1993.03 - 1998.01	88° Variante	3136.88D50
1.8 i 16V	LFY (XU7JP4)	1.8	1995.06 - 1998.01		4450.83D
1.9 D	D9B (XUD9A, L) DJZ (XUD9Y)	1.9	1994.06 - 1998.01		4446.83D
1.9 SD	DHW (XUD9SD)	1.9	1996.02 - 1998.01		4446.83D
1.9 Turbo D	DHX (XUD9TF, BTF), DHY (XUD9TE, Y), D8B (XUD9TF)	1.9	1994.10 - 1998.01		4450.83D
2.0 i	RFX (XU10J2C)	2.0	1993.03 - 1998.01	82° Variante	3136.82D50
2.0 i	RFX (XU10J2C)	2.0	1993.03 - 1998.01	88° Variante	3136.88D50
2.0 i 16V	RFT (XU10J4, Z), RFV (XU10J4R), RFY (XU10J4, Z)	2.0	1993.03 - 1998.01		4450.89D
2.0 Turbo	RGX (XU10J2TE)	2.0	1995.06 - 1998.01		3136.82D50

CITROËN
**Motor
Engine
Moteur**
**Ltr.
Ltr.
Ltr.**
**Jahr
Year
Année**
**Einschränkung
Restriction*
Restriction***
**Thermostat
Thermostat
Thermostat**

2.1 Turbo D 12V	P8C (XUD11BTE)	2.1	1995.06 - 1998.01	Organisations no. →O 7189	4447.80D
2.1 Turbo D 12V	P8C (XUD11BTE)	2.1	1995.07 - 1998.01	Organisations no. O 7190→	4447.85D

XANTIA (X2)

1.8 i	LFX (XU7JB)	1.8	1998.01 - 2003.04		3136.82D50
1.8 i 16V	LFY (XU7JP4)	1.8	1998.01 - 2003.04		4450.83D
1.9 SD	DHW (XUD9SD)	1.9	1998.01 - 2003.04		4450.83D
1.9 Turbo D	DHX (XUD9TF, BTF), D8B (XUD9TF), DHY (XUD9TE, Y)	1.9	1998.01 - 2003.04		4450.83D
2.0 HDI 109	RHZ (DW10ATED)	2.0	1999.02 - 2003.04		4446.83D
2.0 HDI 90	RHY (DW10TD)	2.0	1999.03 - 2003.04		4446.83D
2.0 i	RFX (XU10J2C)	2.0	1998.01 - 2003.04	82° Variante	3136.82D50
2.0 i	RFX (XU10J2C)	2.0	1998.01 - 2003.04	88° Variante	3136.88D50
2.0 i 16V	RFV (XU10J4R)	2.0	1998.01 - 2003.04		4450.83D
2.0 Turbo	RGX (XU10J2TE)	2.0	1998.01 - 2003.04		3136.82D50
2.1 Turbo D 12V	P8C (XUD11BTE)	2.1	1998.01 - 1999.02		4447.85D

XM (Y3)

2.0		2.0	1989.05 - 1994.04	82° Variante	3136.82D50
2.0		2.0	1989.05 - 1994.04	88° Variante	3136.88D50
2.0 i	RFZ (XU10J2)	2.0	1989.05 - 1994.06	82° Variante	3136.82D50
2.0 i	RFZ (XU10J2)	2.0	1989.05 - 1994.06	88° Variante	3136.88D50
2.0 i	RDZ (XU10MZ), XU102C, RFZ (XU10J2)	2.0	1991.11 - 1994.04	82° Variante	3136.82D50
2.0 i	RDZ (XU10MZ), XU102C, RFZ (XU10J2)	2.0	1991.11 - 1994.04	88° Variante	3136.88D50
2.0 i Turbo	RGY (XU10J2TE, Z)	2.0	1992.09 - 1994.06	82° Variante	3136.82D50
2.0 i Turbo	RGY (XU10J2TE, Z)	2.0	1992.09 - 1994.06	88° Variante	3136.88D50
2.0 Turbo	RGY (XU10J2TE, Z)	2.0	1992.09 - 1994.04	82° Variante	3136.82D50
2.0 Turbo	RGY (XU10J2TE, Z)	2.0	1992.09 - 1994.04	88° Variante	3136.88D50
2.1 D 12V	P9A (XUD11A)	2.1	1989.05 - 1994.06	Organisations no. O 5167→	4447.85D
2.1 TD 12V	PJZ (XUD11ATE), P8A (XUD11ATE), P8C (XUD11BTE), PHZ (XUD11ATE)	2.1	1989.05 - 1994.04	Automatikgetriebe	4447.80D
2.1 TD 12V	PJZ (XUD11ATE), P8A (XUD11ATE), P8C (XUD11BTE), PHZ (XUD11ATE)	2.1	1989.05 - 1994.04	Schaltgetriebe	4447.85D

XM (Y4)

2.0 i 16V	RFV (XU10J4R)	2.0	1994.05 - 2000.10		4450.83D
2.0 Turbo	RGX (XU10J2TE)	2.0	1994.05 - 2000.10		3136.82D50
2.1 TD 12V	PJZ (XUD11ATE), P8A (XUD11ATE), P8C (XUD11BTE), PHZ (XUD11ATE)	2.1	1994.05 - 2000.10	Automatikgetriebe	4447.80D
2.1 TD 12V	PJZ (XUD11ATE), P8A (XUD11ATE), P8C (XUD11BTE), PHZ (XUD11ATE)	2.1	1994.05 - 2000.10	Schaltgetriebe	4447.85D
2.0 i 16V	RFV (XU10J4R)	2.0	1994.05 - 2000.10		4450.83D
2.0 Turbo	RGX (XU10J2TE), RGY (XU10J2TE, Z)	2.0	1994.05 - 2000.10		3136.82D50
2.1 D12	P9A (XUD11A)	2.1	1994.07 - 1996.06		4447.85D
2.1 TD 12V	PJZ (XUD11ATE), P8C (XUD11BTE), PHZ (XUD11ATE)	2.1	1994.05 - 2000.10	80° Variante	4447.80D
2.1 TD 12V	PJZ (XUD11ATE), P8C (XUD11BTE), PHZ (XUD11ATE)	2.1	1994.05 - 2000.10	85° Variante	4447.85D

XSARA

1.4 i	KFX (TU3JP), KFW (TU3JP)	1.4	1997.04 - 2005.08	Organisations no. →O 08210	3136.88D50
-------	--------------------------	-----	-------------------	-------------------------------	-------------------

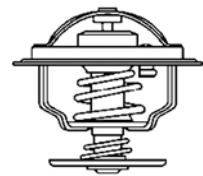

CITROËN

	Motor Engine Moteur	Ltr. Ltr. Ltr.	Jahr Year Année	Einschränkung Restriction* Restriction*	Thermostat Thermostat Thermostat
1.4 i	KFX (TU3JP), KFW (TU3JP)	1.4	1997.05 - 2005.08	Organisations no. O 08211→	410184.89D
1.5 D	VJZ (TUD5)	1.5	1997.04 - 2000.09		4821.89D
1.6 16V	NFU (TU5JP4)	1.6	2000.09 - 2005.08		3463.89D
1.6 i	NFZ (TU5JP)	1.6	1997.04 - 2000.09	Organisations no. →O 08210	3136.88D50
1.6 i	NFZ (TU5JP)	1.6 i	1997.05 - 2000.09	Organisations no. O 08211→	410184.89D
1.8 D	A9A (XUD7), 161A (XUD7)	1.8	1997.04 - 2000.09		4446.83D
1.8 i	LFX (XU7JB), LFZ (XU7JP)	1.8	1997.04 - 2000.09		3136.82D50
1.8 i 16V	LFY (XU7JP4)	1.8	1997.04 - 2000.09		4450.83D
1.8 TD		1.8	1997.10 - 2000.09		4446.83D
1.9 D	WJY (DW8B), WJZ (DW8), DHV (XUD9BSD), DJY (XUD9A)	1.9	1997.04 - 2005.08		4446.83D
1.9 SD	DHV (XUD9BSD)	1.9	1998.01 - 2000.09		4446.83D
1.9 TD	DHY (XUD9TE, Y)	1.9	1997.04 - 2000.09		4450.83D
2.0 16V	RFV (XU10J4R) RFS (XU10J4RS)	2.0	1997.04 - 2000.09		4450.83D
2.0 16V	RFN (EW10J4)	2.0	2000.09 - 2005.08		3483.89D
2.0 HDi 109	RHZ (DW10ATED)	2.0	2001.05 - 2005.08		4446.83D
2.0 HDi 90	RHY (DW10TD)	2.0	1999.02 - 2005.08		4446.83D
2.0 i 16V	RFS (XU10J4RS)	2.0	1998.02 - 2005.03		4450.83D
XSARA PICASSO (N68)					
1.6	NFV (TU5JP), NFZ (TU5JP)	1.6	1999.12 -		3463.89D
1.6 16V	NFU (TU5JP4)	1.6	2005.09 -	Organisations no. →1088678	3463.89D
1.6 16V	NFU (TU5JP4)	1.6	2005.10 -	Organisations no. 1088778→	410705.89D
1.8 16V	6FZ (EW7J4)	1.8	2000.02 -		3483.89D
1.8 SX		1.8	2000.06 - 2005.08		3483.89D
2.0 16V	RFN (EW10J4)	2.0	2003.01 -		3483.89D
2.0 HDi	RHY (DW10TD)	2.0	1999.12 -		4446.83D
ZX (N2)					
1.1	H1A, H1B, HDZ (TU1M)	1.1	1991.03 - 1997.06		3136.88D50
1.4	KDZ (TU3M, Z)	1.4	1991.03 - 1997.06		3136.88D50
1.4 i	KDZ (TU3M, Z), KFX (TU3JP), KDX (TU3M, Z), KDY (TU3M)	1.4	1991.03 - 1997.06		3136.88D50
1.6 i	BFZ (XU5JP), BDY (XU5M)	1.6 i	1991.03 - 1997.10	82° Variante	3136.82D50
1.6 i	BFZ (XU5JP), BDY (XU5M)	1.6 i	1991.03 - 1997.10	88° Variante	3136.88D50
1.8 D	161A (XUD7)	1.8	1993.06 - 1997.10		4446.83D
1.8 i	LFZ (XU7JP)	1.8	1992.07 - 1997.10	82° Variante	3136.82D50
1.8 i	LFZ (XU7JP)	1.8	1992.07 - 1997.10	88° Variante	3136.88D50
1.8 i 16V	LFY (XU7JP4)	1.8	1996.01 - 1998.02		4450.83D
1.9 D	D9B (XUD9A, U), DJY (XUD9A), DJZ (XUD9Y)	1.9	1991.03 - 1997.10		4446.83D
1.9 DT		1.9	1992.06 - 1997.10		4446.83D
1.9 i	DKZ (XU9JA)	1.9	1991.03 - 1997.06	Automatikgetriebe	3136.82D50
1.9 i	DKZ (XU9JA)	1.9	1991.03 - 1997.06	Schaltgetriebe	3136.88D50
1.9 TD	DHY (XUD9TE, Y)	1.9	1992.07 - 1997.10		4446.83D
2.0	RFX (XU10J2C)	2.0	1994.07 - 1997.10	Automatikgetriebe	3136.82D50
2.0	RFX (XU10J2C)	2.0	1994.07 - 1997.10	Schaltgetriebe	3136.88D50
2.0 i	RFX (XU10J2C)	2.0	1992.07 - 1997.06	82° Variante	3136.82D50
2.0 i	RFX (XU10J2C)	2.0	1992.07 - 1997.06	88° Variante	3136.88D50
2.0 i 16V	RFT (XU10J4, Z), RFY (XU10J4, Z)	2.0	1992.07 - 1997.06		4450.89D
2.0 i 16V	RFS (XU10J4RS)	2.0	1996.05 - 1997.06		4450.83D

DACIA

 Motor
Engine
Moteur

 Ltr.
Ltr.
Ltr.

 Jahr
Year
Année

 Einschränkung
Restriction*
Restriction*

 Thermostat
Thermostat
Thermostat

1300

1.3 810-02, -99 1.3 1972.12 - 1983.05 3029.89

1310

1.3 810-02, -99 1.3 1983.05 - 2004.07 3029.89

DOKKER

1.5 dCi K9K 612 1.5 2012.11 - 411442.83D ▲

DUSTER

1.5 dCi K9K 796, 892, 894, 896, 898 1.5 2010.04 - 411039.83D

 1.6 16V K4M 606, 696 1.6 2010.04 - Deckel
Thermostatgehäuse 126104 ▲

1.6 16V K4M 606, 696 1.6 2010.04 - 3466.89D

 1.6 16V LPG K4M 696 1.6 2011.04 - Deckel
Thermostatgehäuse 126104 ▲

1.6 16V LPG K4M 696 1.6 2011.04 - 3466.89D

LODGY

1.5 dCi 1.5 2010.06 - 411442.83D ▲

LOGAN (LS_)

1.2 16V D4F 732 1.2 2006.02 - 3166.89D

 1.4 K7J 710 1.4 2004.09 - Deckel
Thermostatgehäuse 126104 ▲

1.4 K7J 710 1.4 2004.09 - 3466.89D

 1.4 MPI LPG K7J 714, K7J 710 1.4 2006.06 - Deckel
Thermostatgehäuse 126104 ▲

1.4 MPI LPG K7J 714, K7J 710 1.4 2006.06 - 3466.89D

1.5 dCi K9K 790 1.5 2005.09 - 411043.89D

1.5 dCi K9K 792, K9K 796, K9K 892 1.5 2007.09 - 411039.83D

 1.6 K7M 710 1.6 2004.09 - Deckel
Thermostatgehäuse 126104 ▲

1.6 K7M 710 1.6 2004.09 - 3466.89D

 1.6 16V K4M 696, K4M 690 1.6 2006.02 - Deckel
Thermostatgehäuse 126104 ▲

1.6 16V K4M 696, K4M 690 1.6 2006.02 - 3466.89D

 1.6 16V Flexifuel K4M 696 1.6 2010.07 - Deckel
Thermostatgehäuse 126104 ▲

1.6 16V Flexifuel K4M 696 1.6 2010.07 - 3466.89D

 1.6 Bifuel K7M 718 1.6 2010.05 - Deckel
Thermostatgehäuse 126104 ▲

1.6 Bifuel K7M 718 1.6 2010.05 - 3466.89D

 1.6 MPI 85 K7M 800 1.6 2010.05 - Deckel
Thermostatgehäuse 126104 ▲

1.6 MPI 85 K7M 800 1.6 2010.05 - 3466.89D

LOGAN EXPRESS (FS_)

 1.4 K7J 710 1.4 2009.03 - Deckel
Thermostatgehäuse 126104 ▲

1.4 K7J 710 1.4 2009.03 - 3466.89D

1.5 dCi K9K 792, 796, 892 1.5 2009.03 - 411039.83D

 1.6 K7M 710 1.6 2009.03 - Deckel
Thermostatgehäuse 126104 ▲

1.6 K7M 710 1.6 2009.03 - 3466.89D

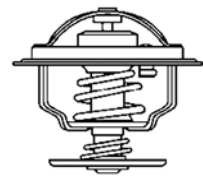

DACIA

	Motor Engine Moteur	Ltr. Ltr. Ltr.	Jahr Year Année	Einschränkung Restriction* Restriction*	Thermostat Thermostat Thermostat
1.6 MPI 85	K7M 800	1.6	2010.05 -	Deckel Thermostatgehäuse	126104 ▲
1.6 MPI 85	K7M 800	1.6	2010.05 -		3466.89D
LOGAN MCV (KS_)					
1.4	K7J 710	1.4	2007.02 -	Deckel Thermostatgehäuse	126104 ▲
1.4	K7J 710	1.4	2007.02 -		3466.89D
1.5 dCi	K9K 792, 796, 892	1.5	2007.02 -		411039.83D
1.6	K7M 710	1.6	2007.02 -	Deckel Thermostatgehäuse	126104 ▲
1.6	K7M 710	1.6	2007.02 -		3466.89D
1.6 16V	K4M 694, K4M 690, 694, 696	1.6	2007.02 -	Deckel Thermostatgehäuse	126104 ▲
1.6 16V	K4M 694, K4M 690, 694, 696	1.6	2007.02 -		3466.89D
1.6 Bifuel	K7M 710	1.6	2008.11 -	Deckel Thermostatgehäuse	126104 ▲
1.6 Bifuel	K7M 710	1.6	2008.11 -		3466.89D
1.6 MPI 85	K7M 800	1.6	2010.05 -	Deckel Thermostatgehäuse	126104 ▲
1.6 MPI 85	K7M 800	1.6	2010.05 -		3466.89D
LOGAN MCV II					
1.5 dCi	K9K 612	1.5	2013.02 -		411442.83D ▲
	K9K 612	1.5	2012.10 -		411442.83D ▲
LOGAN II					
1.5 dCi					
LOGAN Pick-up (US_)					
1.4	K7J 710	1.4	2009.01 -	Deckel Thermostatgehäuse	126104 ▲
1.4	K7J 710	1.4	2009.01 -		3466.89D
1.5 dCi	K9K 792, 796, 892	1.5	2008.03 -		411039.83D
1.6	K7M 710	1.6	2008.03 -	Deckel Thermostatgehäuse	126104 ▲
1.6	K7M 710	1.6	2008.03 -		3466.89D
1.6 Bifuel	K7M 800	1.6	2010.05 -	Deckel Thermostatgehäuse	126104 ▲
1.6 Bifuel	K7M 800	1.6	2010.05 -		3466.89D
1.6 MPI 85	K7M 800	1.6	2010.05 -	Deckel Thermostatgehäuse	126104 ▲
1.6 MPI 85	K7M 800	1.6	2010.05 -		3466.89D
PICK UP					
1.4		1.4	1989.09 - 2000.09	Deckel Thermostatgehäuse	126104 ▲
1.4		1.4	1989.09 - 2000.09		3466.89D
SANDERO					
1.2 16V	D4F 732	1.2	2008.11 -		3166.89D
1.2 16V LPG	D4F 732	1.2	2008.11 -		3166.89D
1.4	K7J 710	1.4	2008.06 -	Deckel Thermostatgehäuse	126104 ▲
1.4	K7J 710	1.4	2008.06 -		3466.89D
1.4 MPI LPG	K7J 714	1.4	2009.01 -	Deckel Thermostatgehäuse	126104 ▲

DACIA	Motor Engine Moteur	Ltr. Ltr. Ltr.	Jahr Year Année	Einschränkung Restriction* Restriction*	Thermostat Thermostat Thermostat
1.4 MPI LPG	K7J 714	1.4	2009.01 -		3466.89D
1.5 dCi	K9K 792, 796, 892	1.5	2008.11 -		411039.83D
1.6	K7M 710	1.6	2008.06 -	Deckel Thermostatgehäuse	126104 ▲
1.6	K7M 710	1.6	2008.06 -		3466.89D
1.6 16V	K4M 690	1.6	2011.07 -	Deckel Thermostatgehäuse	126104 ▲
1.6 16V	K4M 690	1.6	2011.07 -		3466.89D
1.6 16V Bifuel	K4M 696, K4M 694, K4M 690	1.6	2011.01 -	Deckel Thermostatgehäuse	126104 ▲
1.6 16V Bifuel	K4M 696, K4M 694, K4M 690	1.6	2011.01 -		3466.89D
1.6 MPI 85	K7M 800	1.6	2010.05 -	Deckel Thermostatgehäuse	126104 ▲
1.6 MPI 85	K7M 800	1.6	2010.05 -		3466.89D
SANDERO II					
1.2	D4F 732	1.2	2013.01 -		3166.89D
1.2 LPG	0	1.2	2013.01 -		3166.89D
1.5 dCi	K9K 612	1.5	2013.01 -		411442.83D ▲
SOLENZA					
1.4	K7J 710	1.4	2003.02 -	Deckel Thermostatgehäuse	26104 ▲
1.4	K7J 710	1.4	2003.02 -		3466.89D



DAEWOO

	Motor Engine Moteur	Ltr. Ltr. Ltr.	Jahr Year Année	Einschränkung Restriction* Restriction*	Thermostat Thermostat Thermostat
ESPERO (KLEJ)					
1.5 16V	A15MF	1.5	1993.10 - 1999.06		3017.92D2
1.8	C18LE	1.8	1995.02 - 1999.09		4180.82D
2.0	C20LE, C20LZ	2.0	1991.10 - 1999.06		4180.82D
EVANDA (KLAL)					
2.0	L88, X 20 SED	2.0	2002.08 -		4177.92D
KALOS (KLAS)					
1.2	F12S3, B12S1	1.2	2003.04 -		410183.88D
1.4	F14D3, F14S3	1.4	2003.05 - 2004.12		3017.87D2
1.4 16V	F14D3	1.4	2003.04 -		3017.87D2
KORANDO (KJ)					
2.9 D	MB-OM 662	2.9	1999.01 -		4176.85D
2.9 TD	MB-OM 601 29TD	2.9	1999.01 -		4176.85D
3.2	M 104.995	3.2	1999.01 -		4078.87D
LACETTI (KLAN)					
1.4	F14D3	1.4	2004.02 -		3017.87D2
1.6	F16D3	1.6	2004.02 -		3017.87D2
1.8	T18SED	1.8	2004.02 -		4189.87D
LANOS (KLAT)					
1.4	A14SMS	1.4	1997.05 -		3017.87D2
1.5	A15SMS	1.5	1997.10 - 1999.06	2-teiliges Aluminiumgehäuse	3017.87D2
1.5	A15SMS	1.5	1997.10 - 1999.06	2-teiliges Aluminiumgehäuse	3017.87D2
1.6 16V	A16DMS	1.6	1997.05 -		3017.87D2
LEGANZA (KLAV)					
1.8 CD	C18LE	1.8	1997.06 - 2003.07		4189.87D
2.0		2.0	2001.01 - 2002.12		4189.87D
2.0 16V	T20SED, X 20 SED	2.0	2000.07 - 2004.04		4189.87D
2.2 16V	T22SED	2.2	1999.04 - 2002.12		4189.87D
MATIZ (KLYA)					
0.8	F8CV	0.8	1998.09 -		410183.82D
1.0	B10S	1.0	2003.01 -		410183.82D
MUSSO (FJ)					
2.2 TD	MB OM 601	2.2	1999.09 -		4176.85D
2.3	M 111.970	2.3	1999.01 -		4276.87D
2.9 D	MB-OM 662	2.9	1999.01 - 1999.09		4176.85D
2.9 TD	MB-OM 601 29TD	2.9	1999.01 -		4176.85D
3.2	M 104.992	3.2	1999.01 -		4078.87D
NEXIA (KLETN)					
1.5	G15MF	1.5	1995.02 - 1997.08		3017.87D2
1.5 16V	A15MF	1.5	1995.02 - 1997.08		3017.92D2

DAEWOO

 Motor
Engine
Moteur

 Ltr.
Ltr.
Ltr.

 Jahr
Year
Année

 Einschränkung
Restriction*
Restriction*

 Thermostat
Thermostat
Thermostat

NUBIRA (KLAJ)

1.6 16V	A16DMS	1.6	1997.05 -		3017.87D2
1.8	C18LE	1.8	1997.07 - 1999.05		4180.82D
2.0 16V	T20SED, X 20 SED, Z20L	2.0	1997.05 -		4189.87D

NUBIRA (KLAN)

1.4	F14D3	1.4	2003.10 - 2004.12		3017.87D2
1.6	F16D3	1.6	2003.07 -		3017.87D2
1.8	C18LE, T18SED	1.8	2007.03 -		4189.87D

REXTON

2.9 TD	OM 662.983	2.9	2002.04 -		4176.85D
--------	------------	-----	-----------	--	----------

REZZO (KLAU)

1.6	A16DMS	1.6	2000.09 -		3017.87D2
1.8	A18DMS, F18D2, F18S2	1.8	2000.09 -		3017.87D2
2.0	T20SED, X 20 SED	2.0	2000.09 -		4189.87D

TICO (KLY3)

0.8	F8C, F8CV	0.8	1996.01 - 2000.12		410183.88D
-----	-----------	-----	-------------------	--	------------

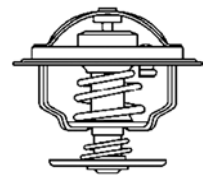
**DAF**

	Motor Engine Moteur	Ltr. Ltr. Ltr.	Jahr Year Année	Einschränkung Restriction* Restriction*	Thermostat Thermostat Thermostat
55					
1.1	DBB 110E	1.1	1967.10 - 1972.09		3029.83
1.1 MARATHON	110F	1.1	1971.12 - 1972.09		3029.83
66					
1.1	110E	1.1	1972.10 - 1975.08		3029.83
1.1 MARATHON	110G	1.1	1972.10 - 1975.08		3029.83
1.1 SL	110G	1.1	1972.10 - 1975.08		3029.83
1300 MARATHON	B13,0S	1.3	1973.09 - 1975.08		3029.83

DAIHATSU

 Motor
Engine
Moteur

 Ltr.
Ltr.
Ltr.

 Jahr
Year
Année

 Einschränkung
Restriction*
Restriction*

 Thermostat
Thermostat
Thermostat

APPLAUSE I (A101, A111)

1.6 16V	HD, HD-E	1.6	1989.06 - 1997.07		410182.84D
---------	----------	-----	-------------------	--	------------

APPLAUSE II

1.6 16V	HD-E	1.6	1997.07 - 2000.05		410182.84D
---------	------	-----	-------------------	--	------------

BEGO

1.3 DVVT	K3-VE	1.3	2005.11 -		410201.80D
----------	-------	-----	-----------	--	------------

1.5 DVVT	3SZ-VE	1.5	2005.11 -		410201.80D
----------	--------	-----	-----------	--	------------

CHARADE I (G10)

1.0	CB 20, CB 22	1.0	1977.10 - 1983.02		410183.82D
-----	--------------	-----	-------------------	--	------------

CHARADE II (G11, G30)

1.0	CB 22, CB 20	1.0	1983.10 - 1987.03		410183.82D
-----	--------------	-----	-------------------	--	------------

1.0 D	CL 10	1.0	1983.10 - 1987.03		4126.88
-------	-------	-----	-------------------	--	---------

1.0 TD	CL 60	1.0	1985.02 - 1987.03		4126.88
--------	-------	-----	-------------------	--	---------

1.0 Turbo	CB 60	1.0	1983.10 - 1987.03		410183.82D
-----------	-------	-----	-------------------	--	------------

CHARADE III (G100, G101, G102)

1.0	CB 23	1.0	1987.03 - 1992.12		410183.82D
-----	-------	-----	-------------------	--	------------

1.0	CB 90	1.0	1989.04 - 1992.12		410183.82D
-----	-------	-----	-------------------	--	------------

1.0 TD	CL, CL 61	1.0	1987.03 - 1992.12		4126.88
--------	-----------	-----	-------------------	--	---------

1.0 Turbo	CB 61	1.0	1987.03 - 1990.10		410183.82D
-----------	-------	-----	-------------------	--	------------

1.3	HC-C, HCE	1.3	1988.09 - 1993.02		410182.84D
-----	-----------	-----	-------------------	--	------------

1.3 i	HCE	1.3	1988.06 - 1993.01		410182.84D
-------	-----	-----	-------------------	--	------------

CHARADE IV (G200, G202, G203)

1.0	CB 22	1.0	1994.09 - 1996.03		410183.82D
-----	-------	-----	-------------------	--	------------

1.3	HC	1.3	1996.09 - 1999.11		410182.84D
-----	----	-----	-------------------	--	------------

1.3 16V	HCE	1.3	1996.05 - 1999.11		410182.84D
---------	-----	-----	-------------------	--	------------

1.3 i 16V	HC	1.3	1993.01 - 1999.11		410182.84D
-----------	----	-----	-------------------	--	------------

1.5 16V	HEE	1.5	1994.10 - 1999.11		410182.84D
---------	-----	-----	-------------------	--	------------

1.5 i 16V	HEE, HEEG	1.5	1994.07 - 1999.11		410182.84D
-----------	-----------	-----	-------------------	--	------------

1.6 GTi	HD-E	1.6	1993.03 - 1999.11		410182.84D
---------	------	-----	-------------------	--	------------

CHARADE (L2_)

1.0	EJ-VE	1.0	2003.03 -		410179.84D
-----	-------	-----	-----------	--	------------

CHARMANT (A)

1.3	4K	1.3	1981.11 - 1987.07		4103.82D
-----	----	-----	-------------------	--	----------

1.6	2T, 4A	1.6	1981.11 - 1987.07		3119.82
-----	--------	-----	-------------------	--	---------

COPEN

0.7	JB, JB-DET	0.7	2003.09 -		3478.82D
-----	------------	-----	-----------	--	----------

1.3	K3-VE	1.3	2006.03 -		410201.80D
-----	-------	-----	-----------	--	------------

CUORE I (L55, L60)

0.5	AB 30	0.5	1980.10 - 1985.09		3119.88
-----	-------	-----	-------------------	--	---------

0.6	AD 10	0.6	1982.08 - 1985.09		3119.88
-----	-------	-----	-------------------	--	---------

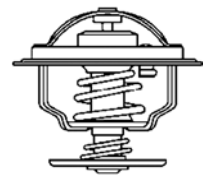

DAIHATSU

	Motor Engine Moteur	Ltr. Ltr. Ltr.	Jahr Year Année	Einschränkung Restriction* Restriction*	Thermostat Thermostat Thermostat
CUORE II (L80, L81)					
0.8	ED 10	0.8	1985.09 - 1990.12		3119.88
CUORE IV (L501)					
0.8	ED 20	0.8	1995.01 - 1996.11		3119.82D5
CUORE V (L5)					
0.8	ED 20	0.8	1996.11 - 1998.10		3119.82D5
CUORE VI (L7_)					
1.0 DVVT	EJ-VE	1.0	2000.10 - 2003.02		410179.84D
1.0 i	EJ-DE	1.0	1998.10 - 2003.05		410179.84D
CUORE VII (L251)					
1.0	EJ-VE	1.0	2003.05 -		410179.84D
CUORE VIII					
1.0	1KR-FE	1.0	2007.04 -		410201.80D
EXTOL (S22_, S23_)					
1.3	K3-VE	1.3	2000.07 - 2003.09		410201.80D
FEROZA (F300)					
1.6 16V	HDC	1.6	1988.10 -		4103.82D
1.6 i 16V	HD-E	1.6	1988.10 -		4103.82D
GRAN MOVE (G3)					
1.5 16V	HEEG	1.5	1996.10 - 1998.07		410182.84D
1.5 GX, GLX	HEEG	1.5	1996.10 - 1998.08		410182.84D
1.6	HDEP	1.6	1998.07 - 2002.07		410182.84D
1.6 16V	HDEP	1.6	1998.05 -		410182.84D
1.6 GX, GLX	HDEP	1.6	1998.06 - 2002.07		410182.84D
HIJET					
0.8	CD	0.8	1986.06 - 1989.12		410183.82D
1.0	CB, CB41	1.0	1986.06 - 1989.12		410183.82D
1.0 i	CB42	1.0	1994.07 - 1998.05		410183.82D
1.2 D	LDW12	1.2	1995.05 - 1998.03		4007.80D
1.4 D	LDW14	1.4	1998.03 - 1999.12		4007.80D
MATERIA (M4_)					
1.3	K3-VE	1.3	2006.10 -		410201.80D
1.5	3SZ-VE	1.5	2006.10 -		410201.80D
MOVE (L6, L9)					
0.8	ED 20	0.8	1996.10 -		3119.82D5
1.0 i	EJ-DE	1.0	1998.10 -		410179.84D
ROCKY (F7, F8)					
2.0	3Y	2.0	1985.02 - 1993.04		4103.82D

DAIHATSU

 Motor
Engine
Moteur

 Ltr.
Ltr.
Ltr.

 Jahr
Year
Année

 Einschränkung
Restriction*
Restriction*

 Thermostat
Thermostat
Thermostat

SIRION

1.0	EJ-DE	1.0	1998.04 - 2000.10		410179.84D
1.0	1KR-FE	1.0	2005.05 -		410179.84D
1.0 DVVT	1KR-FE	1.0	2005.04 -		410179.84D
1.0 i	EJ-DE, EJ-VE	1.0	1998.04 - 2005.01		410179.84D
1.3	K3-VE	1.3	2005.01 -		410201.80D
1.3 Sport	K3-VE2	1.3	2000.08 - 2005.03		410201.80D
1.5	3SZ-VE	1.5	2008.03 -		410201.80D

SPARCAR (S7_)

0.8	CD	0.8	1983.09 - 1986.05		410183.82D
1.0	CB	1.0	1983.09 - 1986.05		410183.82D

TERIOS (J1)

1.3	HE-EJ	1.3	1997.10 - 2000.10		410182.84D
1.3	K3-VE	1.3	2000.10 - 2005.10		410201.80D
1.3 DVVT	K3-VE	1.3	2005.11 -		410201.80D
1.5	3SZ-VE	1.5	2005.11 -		410201.80D
1.5 DVVT	3SZ-VE	1.5	2010.09 -		410201.80D

TREVIS

1.0	EJ-VE	1.0	2006.06 -		410179.84D
-----	-------	-----	-----------	--	------------

XENIA

1.5	3SZ-VE	1.5	2007.06 -		410201.80D
-----	--------	-----	-----------	--	------------

YRV (M2)

1.0	EJ-VE	1.0	2001.02 -		410179.84D
1.3	K3-VE	1.3	2001.02 -		410201.80D
1.3 GTi	K3-VET	1.3	2002.02 -		410201.80D

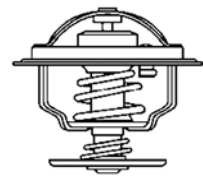

DODGE

	Motor Engine Moteur	Ltr. Ltr. Ltr.	Jahr Year Année	Einschränkung Restriction* Restriction*	Thermostat Thermostat Thermostat
CARAVAN					
2.5 TD	ENC	2.5	1995.01 - 2001.03		4158.80D
NEON					
2.0 16V	ECB	2.0	1994.05 - 1999.08		410262.91D
2.0 16V	ECC	2.0	1994.06 - 1999.08		410262.91D
2.0 16V	ECH	2.0	1999.08 -		410262.91D
STRATUS					
2.0 16V	ECB	2.0	1995.12 - 2001.04		410262.91D
2.4 16 V	EDZ	2.4	1995.12 - 2001.04		410262.91D
2.5 V6	EEB	2.5	1995.12 - 2001.04		410180.82D

FIAT
**Motor
Engine
Moteur**
**Ltr.
Ltr.
Ltr.**
**Jahr
Year
Année**
**Einschränkung
Restriction*
Restriction***
**Thermostat
Thermostat
Thermostat**
124 Spider

1500 Sport (BS) 124 AC.000 1.5 1966.01 - 1972.12 3023.87D

126

700 126 A2.000, 126 A2.048 0.7 1987.09 - 1996.06 3383.87

127

1.0 127 A.000, 127 A1.000 1.0 1977.01 - 1986.12 4091.82D

130

3.2 130 B.000 3.2 1971.10 - 1978.03 4033.82D

131

2.0 D 8144.65 2.0 1978.07 - 1984.08 4008.79D

2.5 D, Super Diesel (AF) 8144.61 2.5 1978.06 - 1984.12 4008.79D

132

2.0 D 8144.65 2.0 1978.07 - 1982.07 4008.79D

2.5 D 8144.61 2.5 1978.07 - 1982.07 4008.79D

500

0.9 199 B6.000, 312 A2.000, 312 A4.000 0.9 2009.09 - 410090.88D

1.3 D Multijet 199 B1.000 1.3 2009.09 - 411774.88D ▲

1.4 169 A3.000, 312 A1.000, 843 A1.000 1.4 2007.10 - 410090.88D

1.4 Abarth 312 A3.000 1.4 2008.08 - 410871.80D ▲

ARGENTA (132A)

2500 Diesel 8144.61 2.5 1981.06 - 1985.11 4008.79D

2500 Turbodiesel 8144.61.500.81 2.5 1983.07 - 1985.08 4008.79D

BARCETTA (183)

1.8 16V 183 A1.000, 183 A6.000 1.8 1995.04 - 2005.05 Chassis No. 20000→ 410514.88D

BRAVA, BRAVO (182)

1.2 16V 80 182 B2.000, 188 A5.000 1.2 1998.12 - 2002.12 3151.87D

1.4 182 A3.000, 182 A5.000, 1.4 1995.10 - 2001.10 ohne Klimaanlage 410515.88D

1.4 182 A3.000, 182 A5.000, 1.4 1995.10 - 2001.10 mit Klimaanlage 410516.88D

1.4 12V 182 A3.000 1.4 1995.10 - 1998.08 ohne Klimaanlage 410515.88D

1.4 12V 182 A3.000 1.4 1995.10 - 1998.08 mit Klimaanlage 410516.88D

1.6 182 B6.000 1.6 2000.09 - 2002.02 3163.88D

1.6 16V 182 A4.000, 182 A6.000 1.6 1995.10 - 1998.04 Gewinde 2x, Motor no. 9762821→ 3481.88D

1.6 16V 182 A4.000, 182 A6.000 1.6 1998.04 - 2001.10 Gewinde 1x, 3163.88D

1.6 16V 182 B6.000 1.6 1999.01 - 2002.12 3163.88D

1.9 D 160 A7.000 1.9 1995.10 - 2001.10 ohne Klimaanlage 3431.80D

1.9 JTD 105 182 B4.000 1.9 1998.12 - 2001.10 410512.88D

2.0 HGT 20V 182 A1.000, 182 B7.000 2.0 1995.10 - 1998.07 410513.88D

BRAVO (198)

1.4 192 B2.000 1.4 2007.04 - 3151.87D

1.4 16V 198 A7.000 1.4 2008.03 - 410871.80D ▲

FIAT

	Motor Engine Moteur	Ltr. Ltr. Ltr.	Jahr Year Année	Einschränkung Restriction* Restriction*	Thermostat Thermostat Thermostat
1.4 LPG	192 B2.000	1.4	2009.11 -		410090.88D
1.9 D Multijet	192 A1.000, 192 A8.000, 192 B4.000, 192 B5.000	1.9	2006.11 -		410511.88D
1.9 D Multijet	937 A5.000	1.9	2007.04 -		411773.88D ▲
CINQUECENTO (170)					
0.7	170 A.000	0.7	1991.12 - 1996.01		3485.87D
0.7 i	170 A.046	0.7	1994.07 - 1996.01		3484.87D
0.9 i.e. (170AC)	170 A1.046	0.9	1991.07 - 1993.12		410007.87D
0.9 i.e. S (170AF, 170CF)	1170 A1.000, 1170 A1.046	0.9	1991.07 - 1999.07		410007.87D
1.1 Sporting	176 B2.000	1.1	1994.10 - 1998.01		3105.87D
COUPE					
2.0 20V	182 A1.000, 182 B3.000	2.0	1996.08 - 1998.04		410513.88D
CROMA (154)					
2000 CHT	154 A1.000	2.0	1985.12 - 1992.09		4022.82D1
2000 i.e.	834 B.048	2.0	1986.03 - 1990.09		4022.82D1
2000 i.e.	834 B.000, 834 B.146	2.0	1987.03 - 1996.08		4022.82D1
2000 i.e.	154 C3.000, 154 C3.046	2.0	1987.03 - 1996.08		4022.82D1
2000 i.e. Turbo	154 A2.000, 154 C4.046, 834 C.146	2.0	1985.12 - 1996.08		4022.82D1
2500 D	8144.67	2.5	1985.12 - 1989.12		4151.79D
2500 TD	8144.91.2000	2.5	1985.12 - 1988.10		4008.79D
2500 TD	8144.91.2000	2.5	1988.11 - 1989.08		3103.79
2500 TD	8144.97, 8144.97 Y, 8144.97.2400	2.5	1989.05 - 1996.08		3116.82D
2500 TDE	8144.97 S	2.5	1991.12 - 1996.08		3116.82D
CROMA (194)					
1.8 16V	939 A4.000	1.8	2005.12 -		4431.105D
1.9 D Multijet	939 A1.000, 939 A2.000, 939 A7.000, 939 A8.000	1.9	2005.06 -		410049.88D
2.2 16V	194 A1.000	2.2	2005.06 -		411193.82D
DOBLÒ (119)					
1.2	223 A5.000	1.2	2001.03 -		3105.87D
1.3 D Multijet	223 A9.000	1.3	2005.10 -		410048.88D
1.3 JTD	199 A2.000	1.3	2005.05 -		410048.88D
1.4	350 A1.000	1.4	2005.05 -		410090.88D
1.6 16V	182 B6.000	1.6	2001.10 -		3163.88D
1.6 Natural Power	182 B6.000	1.6	2002.09 -		3163.88D
1.9 D Multijet	186 A9.000	1.9	2005.10 -		410589.88D
1.9 JTD	182 B9.000, 223 A7.000, 223 B1.000, 223 B2.000	1.9	2001.10 -		410589.88D
DOBLÒ (223)					
1.2 (223ZX1A)	223 A5.000	1.2	2001.03 -		3105.87D
1.3 D Multijet	199 A2.000	1.3	2005.05 - 2010.01		410048.88D
1.3 JTD 16V Multijet	223 A9.000	1.3	2006.08 -		410048.88D
1.4	350 A1.000	1.4	2005.10 -		410090.88D
1.6 16V	182 B6.000	1.6	2001.10 -		3163.88D
1.6 Natural Power	182 B6.000	1.6	2002.09 -		3163.88D
1.9 JTD	182 B9.000, 223 B1.000, 223 A7.000	1.9	2001.10 -		410589.88D

FIAT
**Motor
Engine
Moteur**
**Ltr.
Ltr.
Ltr.**
**Jahr
Year
Année**
**Einschränkung
Restriction*
Restriction***
**Thermostat
Thermostat
Thermostat**
DOBLO (263)

1.4	843 A1.000	1.4	2010.02 -		410090.88D
-----	------------	-----	-----------	--	------------

DUCATO (230)

1.9 D	D9B, DJY, D9B (XUD9A)	1.9	1998.04 - 2002.04		4446.83D
1.9 D	DJY, DHX	1.9	1998.04 - 2002.04		4446.83D
1.9 TD	DHX (XUD9TF, L)	1.9	1998.04 - 2002.04		4450.83D
2.0	RFW	2.0	1994.03 - 2002.04		3136.82D50
2.0 JTD	RHV (DW10)	2.0	2001.10 - 2002.04		4446.83D
2.5 D	8140.67	2.5	1994.03 - 2002.04	82° Variante	4174.82D
2.5 D	8140.67	2.5	1994.03 - 2002.04	88° Variante	4174.88D ▲
2.5 TD	8140.47	2.5	1994.06 - 2001.09	82° Variante	4174.82D
2.5 TD	8140.47	2.5	1994.06 - 2001.09	88° Variante	4174.88D ▲
2.5 TDI	8140.473, 8140.47R	2.5	1994.03 - 2002.04	82° Variante	4174.82D
2.5 TDI	8140.473, 8140.47R	2.5	1994.03 - 2002.04	88° Variante	4174.88D ▲
2.8 D	8140.63	2.8	1998.02 - 2002.04	82° Variante	4174.82D
2.8 D	8140.63	2.8	1998.02 - 2002.04	88° Variante	4174.88D ▲
2.8 IDTD	8140.43	2.8	1998.05 - 2001.09	79° Variante	4174.79D
2.8 IDTD	8140.43	2.8	1998.05 - 2001.09	82° Variante	4174.82D
2.8 IDTD	8140.43	2.8	1998.05 - 2001.09	88° Variante	4174.88D ▲
2.8 JTD	8140.43S	2.8	2000.11 - 2002.04	82° Variante	4174.82D
2.8 JTD	8140.43S	2.8	2000.11 - 2002.04	88° Variante	4174.88D ▲
2.8 JTD	8140.43S	2.8	2001.03 - 2002.04	82° Variante	4174.82D
2.8 JTD	8140.43S	2.8	2001.03 - 2002.04	88° Variante	4174.88D ▲
2.8 TD, TDI	8140.43, 8140.63	2.8	1998.05 - 2001.09	79° Variante	4174.79D
2.8 TD, TDI	8140.43, 8140.63	2.8	1998.05 - 2001.09	82° Variante	4174.82D
2.8 TD, TDI	8140.43, 8140.63	2.8	1998.05 - 2001.09	88° Variante	4174.88D ▲

DUCATO (244)

2.0	RFL	2.0	2002.04 -		3136.82D50
2.0 Bipower	RFL	2.0	2002.11 -		3136.82D50
2.0 JTD	RHV (DW10)	2.0	2002.04 - 2006.07		4446.83D
2.3 JTD	F1AE0481C	2.3	2002.04 - 2006.07		3171.82D
2.8 JTD, TD, TDS	8140.23, 8140.43	2.8	2002.04 - 2006.07	82° Variante	4174.82D
2.8 JTD, TD, TDS	8140.23, 8140.43	2.8	2002.04 - 2006.07	88° Variante	4174.88D ▲

DUCATO (250)

100 Multijet 2.2 D	4HV	2.2	2006.07 -		3497.88D
120 Multijet 2.3 D	F1AE0481D, F1AE3481D	2.3	2006.07 -		410937.82D ▲
130 Multijet 2.3 D	F1AE0481N, F1AE3481D	2.3	2007.01 -		410937.82D ▲
150 Multijet 3.0 D	F1CE3481N	3.0	2010.04 -		410075.79D ▲
160 Multijet 3.0 D	F1CE0481D, F1CE3481M	3.0	2006.07 -		410075.79D ▲
3.0 D Multijet	F1CE3481E	3.0	2011.06 -		410075.79D ▲

DUCATO (280)

1.8	169 B, XM7T	1.8	1982.01 - 1988.12		3061.82
1.9 D	149 B1.000	1.9	1987.02 - 1990.08		3431.80D
1.9 TD	280 A1.000	1.9	1989.03 - 1990.08		3431.80D
2.0	170 B, 170 D, XN 1T	2.0	1982.01 - 1990.08		3061.82
2.4 D	8144.61	2.4	1982.01 - 1990.08		4008.79D
2.5 D	CRD93L (U25-661), 8144.67	2.5	1982.01 - 1990.08	82° Variante	4174.82D
2.5 D	CRD93L (U25-661), 8144.67	2.5	1982.01 - 1990.08	88° Variante	4174.88D ▲
2.5 D	8140.61, 8144.61	2.5	1986.09 - 1990.05		4008.79D
2.5 TD	8144.21	2.5	1986.01 - 1990.08	82° Variante	4174.82D
2.5 TD	8144.21	2.5	1986.01 - 1990.08	88° Variante	4174.88D ▲

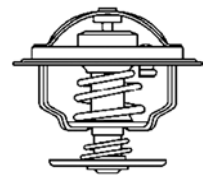
FIAT

	Motor Engine Moteur	Ltr. Ltr. Ltr.	Jahr Year Année	Einschränkung Restriction* Restriction*	Thermostat Thermostat Thermostat
DUCATO (290)					
1.9 D	149 B1.000	1.9	1990.07 - 1994.03		3431.80D
1.9 TD	280 A1.000	1.9	1989.03 - 1994.03		3431.80D
2.0	170 D	2.0	1990.06 - 1994.05		3061.82
2.5 D, TD	8140.27, 8144.67	2.5	1990.06 - 1994.03	82° Variante	4174.82D
2.5 D, TD	8140.27, 8144.67	2.5	1990.06 - 1994.03	88° Variante	4174.88D ▲
DUNA (146 B)					
1.7 DS	149 B3.000	1.7	1987.01 - 1991.12		3431.80D
60 1.1	146 A6.000	1.1	1987.01 - 1991.12		4091.82D
70 1.3	146 A5.000	1.3	1987.01 - 1991.12		4091.82D
ELBA					
1.3		1.3	1986.04 - 1993.12		4091.82D
1.5	149 C1.000	1.5	1992.01 - 1996.12		4091.82D
1.7 D	146 B2.000	1.7	1989.04 - 1996.12		3431.80D
FIORINO (127)					
1050	127 A.000	1.05	1980.01 - 1987.12		4091.82D
FIORINO (146 Uno)					
60 1.1	146 A9.000	1.1	1988.05 - 1993.12		4091.82D
60 1.7 D	146 B2.000, 149 B3.000	1.7	1988.05 - 2000.05		3431.80D
65 1.7 TD	146 D7.000	1.7	1997.01 - 2001.05	mit Klimaanlage	4246.80D
65 1.7 TD	146 D7.000	1.7	1997.01 - 2001.05	ohne Klimaanlage	4247.80D
70 1.3	146 A5.000	1.3	1988.01 - 1994.12		4091.82D
1.7 D	146 B2.000, 149 B3.000	1.7	1993.10 - 1999.10		3431.80D
1.7 TD	146 D7.000	1.7	1997.01 - 2001.05	Ölkühlung	410692.71D
1.7 TD	146 D7.000	1.7	1997.01 - 2001.05	mit Klimaanlage	4246.80D
1.7 TD	146 D7.000	1.7	1997.01 - 2001.05	ohne Klimaanlage	4247.80D
FIORINO (147)					
1.0	127 A.000, 156 A.000	1.0	1980.01 - 1988.04		4091.82D
1.1	146 A9.000	1.1	1986.11 - 1988.12		4091.82D
1.3	146 A5.000	1.3	1987.12 - 1993.08		4091.82D
1.3 D	127 A5.000	1.3	1982.03 - 1988.12		3355.80D
1.7 D	149 B2.000, 149 B3.000	1.7	1988.01 - 1993.10		3431.80D
FIORINO					
1.3 D Multijet	199 A2.000, 199 A9.000	1.3	2007.11 -		410048.88D
1.4	KFT, KfV	1.4	2007.11 -		3463.89D
1.4 Natural Power	350 A1.000	1.4	2009.10 -		410090.88D
IDEA					
1.2 16V	188 A5.000	1.2	2004.01 -		3151.87D
1.3 D Multijet	199 A3.000, 199 B1.000	1.3	2005.10 -		410048.88D
1.4	192 B2.000	1.4	2003.12 -		3151.87D
1.4	350 A1.000	1.4	2005.10 -		410090.88D
1.4 16V	843 A1.000	1.4	2004.01 -		3151.87D
1.4 LPG	350 A1.000	1.4	2009.03 -		410090.88D

FIAT
**Motor
Engine
Moteur**
**Ltr.
Ltr.
Ltr.**
**Jahr
Year
Année**
**Einschränkung
Restriction*
Restriction***
**Thermostat
Thermostat
Thermostat**

FIAT	Motor Engine Moteur	Ltr. Ltr. Ltr.	Jahr Year Année	Einschränkung Restriction* Restriction*	Thermostat Thermostat Thermostat
LINEA					
1.3 D Multijet	199 A3.000	1.3	2007.06 -		410048.88D
1.4	350 A1.000	1.4	2007.06 -		410090.88D
MAREA (185)					
1.2 16V	182 B2.000	1.2	1998.10 - 2002.05		3151.87D
1.4 80 12V	182 A3.000	1.4	1996.09 - 2002.05	ohne Klimaanlage	410515.88D
1.4 80 12V	182 A3.000	1.4	1996.09 - 2002.05	mit Klimaanlage	410516.88D
1.6	182 B6.000	1.6	2000.09 - 2002.08		3163.88D
1.6 100 16V	182 A4.000	1.6	1998.04 - 2002.05	Gewinde 1x	3163.88D
1.6 100 16V	182 A4.000	1.6	1996.09 - 1998.04	Gewinde 2x, Motor no. 9762821→	3481.88D
1.6 100 16V Bipower	186 A4.000, 185 A3.000	1.6	1999.04 - 2002.05	Gewinde 2x	3481.88D
1.9 JTD 105	182 B4.000	1.9	1999.04 - 2002.05		410512.88D
2.0 150 20V	182 A1.000, 185 A8.000	2.0	1996.09 - 2002.05		410513.88D
2.0 155 20V	182 B7.000	2.0	1999.04 - 2003.02		410513.88D
MULTIPLA (186)					
1.6	182 B6.000	1.6	2000.09 - 2010.06		3163.88D
1.6 100 16V	182 A4.000	1.6	1999.04 - 2010.06		3163.88D
1.6 16V	182 B6.000	1.6	2002.04 - 2010.06		3163.88D
1.6 16V Bipower	182 B6.000, 186 A4.000	1.6	1999.04 - 2010.06		3163.88D
1.6 16V Blupower	186 A3.000	1.6	1999.04 - 2010.06		3163.88D
1.9 JTD 105	182 B4.000	1.9	1999.04 - 2010.06		410512.88D
PALIO					
1.2	176 A8.000, 178 B5.000, 178 C4.066, 178 E2.000, 188 A4.000	1.2	1996.04 -		3105.87D
1.2	188 A5.000	1.2	2001.09 -		3151.87D
1.4	834 A1.000	1.4	2003.06 -		410090.88D
1.6 16V	178 B3.000	1.6	1996.04 - 2001.02	Gewinde 2x, Motor no. →60933	3481.88D
1.6 16V	178 B3.000	1.6	1996.05 - 2001.02	Gewinde 1x, Motor no. 60933→	3163.88D
1.6 16V	182 B6.000	1.6	2001.02 -	Motor no. 60933→	3163.88D
1.7 TD	176 A3.000, 176 A5.000	1.7	1996.04 - 2001.03	Ölkühlung	410692.71D
1.7 TD	176 A3.000, 176 A5.000	1.7	1996.04 - 2001.03	ohne Klimaanlage	4434.80D
1.7 TD	176 A3.000, 176 A5.000	1.7	1996.04 - 2001.03	mit Klimaanlage	4436.80D
PANDA					
750	156 A4.000	0.75	1986.01 - 1995.01		3105.87D
750	141 B.000	0.75	1986.01 - 1995.01		3361.87D
750	156 A4.048	0.75	1995.04 - 2003.10		3105.87D
900	146 A.000, 100 GL3.000	0.9	1980.10 - 1994.06		3361.87D
900	1170 A1.046	0.9	1992.04 - 1996.12		3361.87D
1000	141 C2.000, 156 A2.100, 156 A3.000, 156 A2.246	1.0	1985.01 - 1994.12		3105.87D
1000 i.e.	141 C2.000, 156 A2.246	1.0	1987.10 - 2004.02		3105.87D
1100	156 C.046, 187 A1.000, 176 B2.000	1.1	1991.05 - 2004.07		3105.87D
1300 D	156 A5.000	1.3	1986.04 - 1992.12		3373.80D
PANDA (169)					
1.1	187 A1.000	1.1	2003.09 -		3105.87D
1.2	188 A4.000	1.2	2003.09 -		3105.87D
1.2	169 A4.000	1.2	2010.09 -		410090.88D

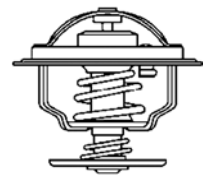
FIAT

	Motor Engine Moteur	Ltr. Ltr. Ltr.	Jahr Year Année	Einschränkung Restriction* Restriction*	Thermostat Thermostat Thermostat
1.2 Bi-Power	188 A4.000	1.2	2007.01 -		3105.87D
1.2 LPG	188 A4.000	1.2	2009.04 -		3105.87D
1.2 LPG	169 A4.000	1.2	2010.11 -		3105.87D
1.4	169 A3.000	1.4	2006.10 -		410090.88D
1.4 Bi-Power	350 A1.000	1.4	2010.09 -		410090.88D
1.4 Natural Power	350 A1.000	1.4	2010.01 -		410090.88D

PUNTO (176)

1.1	176 B2.000	1.1	1996.04 - 2000.02		3105.87D
1.2 16V	176 B9.000	1.2	1997.04 - 1999.09		3105.87D
1.4 GT Turbo	176 A4.000, 176 B6.000	1.4	1994.01 - 1996.09	Ölkühlung	410692.71D
1.7 D	176 B3.000	1.7	1994.04 - 2000.02		3300.80D
1.7 TD	176 A5.000	1.7	1994.01 - 2000.02	mit Klimaanlage	3301.80D
1.7 TD	176 A5.000	1.7	1994.01 - 2000.02	Motor no. →1897563, ohne Klimaanlage	3302.80D
1.7 TD	176 A3.000, 176 A5.000	1.7	1994.01 - 1999.09	Ölkühlung	410692.71D
1.7 TD	176 A3.000	1.7	1994.01 - 1999.09	Motor no. →1897563, ohne Klimaanlage	4434.80D
1.7 TD	176 A3.000	1.7	1994.01 - 1999.09	mit Klimaanlage	4436.80D
1.7 TD	176 B7.000	1.7	1996.09 - 1999.09	mit Klimaanlage	4436.80D
55 1.1	176 A6.000, 176 B2.000	1.1	1993.09 - 1999.09		3105.87D
60 1.2	176 A7.000, 176 B1.000, 176 B4.000	1.2	1994.01 - 2000.06		3105.87D
75 1.2	176 A8.000	1.2	1993.10 - 1999.09		3105.87D
85 16V 1.2	176 B9.000	1.2	1997.04 - 2000.06		3105.87D

PUNTO (188)

1.2 16V 80	188 A5.000	1.2	1999.09 -		3151.87D
1.2 60	188 A4.000	1.2	1999.09 - 2009.10		3105.87D
1.2 Natural Power	188 A4.000	1.2	2003.09 -		3105.87D
1.4	843 A1.000	1.4	2003.09 -		3151.87D
1.8 130 HGT	183 A1.000, 188 A6.000	1.8	1999.09 -		410514.88D
1.9 JTD	188 A7.000	1.9	2000.02 - 2009.10		410591.88D
1.9 JTD 80	188 A2.000	1.9	1999.09 -		410591.88D

PUNTO / GRANDE PUNTO (199)

0.9 Twinair Turbo	312 A2.000	0.9	2012.03 -		410090.88D
1.2	169 A4.000, 199 A4.000	1.2	2010.09 -		410090.88D
1.3 D Multijet	199 A2.000, 199 A3.000, 199 A9.000	1.3	2005.10 -		410048.88D
1.4	199 A7.000, 350 A1.000	1.4	2005.10 -		410090.88D
1.4 16V	199 A6.000	1.4	2005.10 -		410090.88D
1.4 16V	955 A6.000	1.4	2009.09 -		410871.80D ▲
1.4 LPG	350 A1.000	1.4	2008.08 -		410090.88D
1.4 Multi Air	955 A6.000	1.4	2012.03 -		410871.80D ▲
1.4 Natural Power	350 A1.000	1.4	2008.07 -		410090.88D
1.4 Turbo Multi Air	955 A2.000	1.4	2012.03 -		410871.80D ▲
1.9 D Multijet	199 A5.000, 939 A1.000, 939 A7.000	1.9	2005.10 -		410049.88D

PUNTO EVO (199)

1.2	169 A4.000, 199 A4.000	1.2	2009.10 - 2012.02		410090.88D
1.3 D Multijet	199 A2.000, 199 A9.000, 199 B2.000, 199 B4.000, 223 A9.000	1.3	2008.07 - 2012.02		410048.88D
1.4	199 A7.000, 350 A1.000	1.4	2009.07 - 2012.02		410090.88D
1.4 16V	955 A2.000, 955 A6.000	1.4	2009.10 - 2012.02		410871.80D ▲
1.4 LPG	350 A1.000	1.4	2009.06 - 2012.02		410090.88D
1.4 Natural Power	350 A1.000	1.4	2009.06 - 2012.02		410090.88D

FIAT
**Motor
Engine
Moteur**
**Ltr.
Ltr.
Ltr.**
**Jahr
Year
Année**
**Einschränkung
Restriction*
Restriction***
**Thermostat
Thermostat
Thermostat**
QUBO

1.3 D Multijet	199 A2.000	1.3	2008.02 -		410048.88D
1.4	KFT, KFV	1.4	2008.02 -		3463.89D
1.4 Natural Power	350 A1.000	1.4	2009.10 -		410090.88D

REGATA

60 Diesel 1.7	149 B3.000	1.7	1984.01 - 1989.12		3431.80D
65 Diesel 1.9	149 A1.000	1.9	1984.04 - 1989.07		3431.80D
80 Turbo Diesel 1.9	831 D1.000	1.9	1986.05 - 1989.07		3431.80D

RITMO I (138A)

60 1.0	127 A6.000	1.0	1978.09 - 1982.09		4091.82D
--------	------------	-----	-------------------	--	----------

RITMO II (138A)

60 Diesel 1.7	149 B3.000, 138 C.000	1.7	1985.05 - 1987.12		3431.80D
80 Turbo Diesel 1.9	831 D1.000	1.9	1985.12 - 1987.12		3431.80D

SCUDO (220)

1.9 D	D9B, WJZ (DW8)	1.9	1996.02 - 2006.12		4446.83D
1.9 TD	D8B, DHX (XUD9TF, L)	1.9	1996.02 - 2006.12		4446.83D
2.0	RFN (EW10J4)	2.0	2000.05 - 2006.12		3463.89D
2.0 16V	RFN (EW10J4)	2.0	2000.06 - 2006.12		3483.89D
2.0 JTD	RHX, RHZ	2.0	1999.12 - 2006.12		4446.83D
2.0 JTD 16V	RHW (DW10ATED4)	2.0	1999.05 - 2006.12		4446.83D

SEDICI

1.6 16V	M16A	1.6	2006.06 -		410229.82D
1.9 D Multijet	D19AA	1.9	2006.06 -		410049.88D

SEICENTO (187)

0.9	1170 A1.046	0.9	1998.01 - 2010.01		410007.87D
1.1	187 A1.000, 176 B2.000	1.1	1998.01 - 2010.01		3105.87D

SIENA

1.2	178 B5.000	1.2	1998.09 -		3105.87D
1.6 16V	178 B3.000	1.6	1998.09 -	Motor no. 60933→	3163.88D
1.7 TD	176 A3.000	1.7	2006.02 -	Ölkühlung	410692.71D

STILO

1.2 16V	188 A5.000	1.2	2002.02 - 2006.11		3151.87D
1.4 16V	192 B2.000, 843 A1.000	1.4	2004.01 - 2008.08		3151.87D
1.6 16V	182 B6.000	1.6	2001.10 - 2008.08		3163.88D
1.6 16V	192 B3.000	1.6	2005.05 - 2006.11		4357.92D
1.8 16V	192 A4.000	1.8	2001.10 - 2008.08		410514.88D
1.9 D	192 B5.000	1.9	2004.09 - 2008.08		410511.88D
1.9 D Multijet	192 A8.000, 192 A9.000	1.9	2005.09 - 2008.08		410511.88D
1.9 D Multijet	937 A5.000	1.9	2005.09 - 2008.08		411773.88D ▲
1.9 JTD	192 A1.000, 192 A3.000, 937 A7.000	1.9	2001.10 - 2008.08		410511.88D
1.9 JTD	192 A5.000, 192 B1.000, 937 A4.000	1.9	2003.09 - 2008.08		411773.88D ▲
1.9 JTD	192 B5.000	1.9	2004.09 - 2006.11		410511.88D
2.4 20V	192 A2.000	2.4	2001.10 - 2006.11		410994.88D

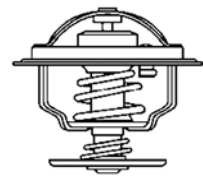
FIAT

	Motor Engine Moteur	Ltr. Ltr. Ltr.	Jahr Year Année	Einschränkung Restriction* Restriction*	Thermostat Thermostat Thermostat
STRADA (178E)					
1.2	178 B5.000, 188 A4.000	1.2	1999.06 -		3151.87D
1.2		1.2	2005.11 -		3105.87D
1.3 D Multijet	223 A9.000	1.3	2006.05 -		410048.88D
1.7 TD	176 A3.000	1.7	1999.06 -	Ölkühlung	410692.71D
1.7 TD	176 A3.000	1.7	1999.06 -	ohne Klimaanlage	4434.80D
1.7 TD	176 A3.000	1.7	1999.06 -	mit Klimaanlage	4436.80D
TALENTO (290)					
1.9 D	149 B1.000	1.9	1989.03 - 1994.03		3431.80D
2.0	170 B	2.0	1989.03 - 1994.03		3061.82
TEMPRA (159)					
1.4 i.e.	159 A2.000, 160 A1.046, 836 A4.000	1.4	1991.03 - 1996.08		3109.87D
1.6	159 A3.000	1.6	1990.03 - 1993.04		3109.87D
1.6 i.e.	159 A3.046	1.6	1990.06 - 1992.07		3109.87D
1.8	159 A4.000	1.8	1992.07 - 1993.06		3159.82D
1.8 i.e.	159 A4.000, 159 A4.046	1.8	1990.03 - 1996.08		3159.82D
1.8 i.e.	159 A4.000, 159 A4.046	1.8	1990.03 - 1996.08		410956.83D
1.8 i.e.	835 C2.000, 835 C4.000, 836 A5.000	1.8	1993.09 - 1996.08		3159.82D
1.9 D	160 A7.000, 149 A1.000	1.9	1991.07 - 1996.08		3431.80D
1.9 TD	160 A6.000, 160 B6.046, 160 D1.000	1.9	1990.05 - 1996.08	Ölkühlung	410692.71D
2.0 i.e	159 A6.046	2.0	1990.10 - 1996.08	Motor no. →1518014	3159.82D
2.0 i.e	159 A6.046	2.0	1990.11 - 1996.08	Motor no. 1518014→	410956.83D
TIPO (160)					
1.1	160 A3.000	1.1	1988.01 - 1991.10		3105.87D
1.4	160 A1.000	1.4	1987.07 - 1989.12		3109.87D
1.4 i.e.	160 A1.046, 836 A4.000	1.4	1989.05 - 1995.04		3109.87D
1.4 i.e.	159 A2.000	1.4	1989.05 - 1995.04	Motor no. →8742134	3109.87D
1.6	160 A2.000	1.6	1988.01 - 1991.10		3109.87D
1.6 i.e.	149 C2.046, 159 A3.046, 159 A3.048, 835 C1.000	1.6	1988.02 - 1995.04		3109.87D
1.6 SX DGT	159 A3.000	1.6	1989.05 - 1995.10	Motor no. →8742134	3109.87D
1.7 D	149 B4.000	1.7	1988.01 - 1995.10		3431.80D
1.8 i.e	836 A5.000	1.8	1993.03 - 1995.04	Motor no. →1509143	3159.82D
1.8 i.e.	159 A4.000	1.8	1990.10 - 1995.04		3159.82D
1.8 i.e.	159 A4.046	1.8	1990.10 - 1993.06	Motor no. →1517343	3159.82D
1.8 i.e.	835 C2.000, 835 C4.000	1.8	1993.04 - 1995.04		3159.82D
1.9 D	149 A1.000, 160 A7.000	1.9	1991.07 - 1996.08		3431.80D
1.9 TD	160 A6.000, 160 A6.046, 160 B6.046, 160 D1.000	1.9	1990.09 - 1995.04	Ölkühlung	410692.71D
2.0	159 A5.046, 159 A6.046	2.0	1990.10 - 1992.10		3159.82D
2.0 i.e.	159 A6.046	2.0	1990.03 - 1995.04	Motor no. →1518014	3159.82D
2.0 i.e.	159 A6.046	2.0	1990.04 - 1995.04	Motor no. 1518014→	410956.83D
ULYSSE (220)					
1.8	LFW	1.8	1997.05 - 2002.08		3136.82D50
1.8	LFW	1.8	1997.05 - 2002.08	88° Variante	3136.88D50
1.9 TD	DHX (XUD9TF, L)	1.9	1995.02 - 2002.08		4446.83D
2.0	RFU (XU10J2C)	2.0	1994.06 - 2002.08	82° Variante	3136.82D50
2.0	RFU (XU10J2C)	2.0	1994.06 - 2002.08	88° Variante	3136.88D50
2.0 16V	RFV	2.0	1998.05 - 2000.09		4450.83D
2.0 16V	RFN (EW10J4)	2.0	2000.09 - 2002.08		3463.89D

FIAT
**Motor
Engine
Moteur**
**Ltr.
Ltr.
Ltr.**
**Jahr
Year
Année**
**Einschränkung
Restriction*
Restriction***
**Thermostat
Thermostat
Thermostat**

2.0 JTD	RHZ	2.0	1999.10 - 2002.08		4446.83D
2.0 Turbo (220.AD5)	RGX (XU10J2CTE)	2.0	1994.06 - 2002.08		3136.82D50
2.1 TD	P8C	2.1	1996.03 - 1999.10		4446.83D

ULYSSE (179)

2.0	RFN (EW10J4)	2.0	2002.08 - 2011.06		3463.89D
2.0 JTD	RHM (DW10ATED4), RHW (DW10A-TED4)	2.0	2003.05 - 2006.08		4446.83D
2.2 JTD	4HW (DW12ATED4)	2.2	2002.08 - 2006.08		4446.83D

UNO (146A/E)

1.3 Super Diesel	127 A5.000	1.3	1983.06 - 1992.03		3355.80D
1.3 Super Diesel	146 B1.000	1.3	1983.06 - 1992.03		3373.80D
1.4 Turbo i.e.	146 A8.000, 146 A8.046	1.4	1989.12 - 1996.12	Ölkühlung	410692.71D
45 0.9	146 A.000, 146 A1.000	0.9	1983.03 - 1992.09		3360.87D
45 1.0	156 A2.048, 156 A2.100	1.0	1986.06 - 1993.12		3105.87D
45 i.e. 1.0	156 A2.246	1.0	1984.04 - 1995.10		3105.87D
50 1.1	146 A4.044, 156 C.046	1.1	1986.01 - 1993.12		3105.87D
50 i.e. 1.1	146 C3.000	1.1	1992.06 - 1993.12		3105.87D
55 1.0		1.0	1993.11 - 2000.08		3105.87D
60 1.1	160 A3.000	1.1	1989.04 - 1992.12		3105.87D
60 Diesel 1.7	146 B2.000, 149 B3.000	1.7	1986.07 - 1993.12	ohne Klimaanlage	3431.80D
70 i.e. 1.4	160 A1.046	1.4	1989.09 - 1993.12		3109.87D
70 TD 1.4	146 B.000, 146 B3.000	1.4	1986.10 - 1990.10		3431.80D

X 1/9 (128 AS)

1.5	138 AS.000, 138 BS.031	1.5	1978.11 - 1989.12		4033.82D
-----	------------------------	-----	-------------------	--	----------



FORD

	Motor Engine Moteur	Ltr. Ltr. Ltr.	Jahr Year Année	Einschränkung Restriction* Restriction*	Thermostat Thermostat Thermostat
B-MAX					
1.4		1.4	2012.10 -		4483.82D
1.6 Ti	IQJA	1.6	2012.10 -		4483.82D
CAPRI III					
1.3	J1E	1.3	1978.01 - 1985.06		3021.88D50
1.6	LCN	1.6	1978.01 - 1987.04		3021.88D50
2.0	NEN, OHC TL 20 H	2.0	1978.01 - 1985.12		3021.88D50
2.0	NYL	2.0	1978.01 - 1982.12	V6	4256.87D50
2.3 Super	YYN	2.3	1979.06 - 1985.12		4256.87D50
2.8 i Turbo	PYN	2.8	1982.01 - 1987.04		4256.87D50
2.8 Super Injection	PRN	2.8	1981.01 - 1987.04		4256.87D50
3.0	HYF	3.0	1978.01 - 1981.12		3004.88D1
C-MAX					
1.6	SHDA, HWDB, SHDB, HWDA, SHDC	1.6	2007.02 -		4483.82D
1.6 Ti	IQDB, IQDA, PNDA, XTDA	1.6	2010.12 -		4483.82D
1.8 TDCi	KKDA	1.8	2007.02 -		410131.88D
COUGAR					
2.0 16V	EDBB, EDBC, EDBD, EDDB	2.0	1998.08 - 2001.12		4270.88D
ECONOVAN					
1.4	UC	1.4	1986.03 - 1992.03		3119.88D3
ENDEAVOUR (25N_)					
2.5 TD	WL84	2.5	2003.05 -		4639.82D
ESCORT III / IV 1980 → 1990					
1.1	GLB, GMA, GPA, GSE, GSG	1.1	1981.03 - 1986.02		3021.88D50
1.3	JLA, JBA, JBB, JLB, JPA	1.3	1980.09 - 1990.10		3004.88D1
1.4	F6D, F6B, FUA, FUA, FUC	1.4	1985.10 - 1990.10		3021.88D50
1.4 i	F6D, F6B, FUC	1.4	1986.02 - 1990.07		3021.88D50
1.6	CHT 1600, LP1, LP2, LPA, LJB, LRB, LUA, LUC, LUG	1.6	1980.09 - 1990.07		3021.88D50
1.6 D	LTA, LTC	1.6	1984.02 - 1990.07		4256.87D50
1.6 i	L4B, LJB, LRA, LR1	1.6	1983.09 - 1990.05		3021.88D50
1.6 RS Turbo	LNA	1.6	1984.11 - 1985.12		3021.88D50
1.6 Turbo RS	LNB	1.6	1986.01 - 1990.07		3021.88D50
1.6 XR3i	LRA, LRB, LR1, LR2	1.6	1982.10 - 1990.07		3021.88D50
1.7 Turbo RS	0	1.7	1982.09 - 1986.02		3021.88D50
1.8 D	RTA, RTB	1.8	1988.07 - 1990.07		4256.87D50
RS 1600i	LUAE	1.6	1982.05 - 1985.12		3021.88D50
ESCORT V / VI / VII / Classic 1990 →					
1.3	J6A, J4B, JBD	1.3	1990.07 - 1999.02		3004.92D1
1.4	F4B, F6F, F6G, FUH	1.4	1993.08 - 1999.02		3021.88D50
1.4 i	F4B	1.4	1993.07 - 1995.01		3021.88D50
1.6	LJF, LUJ, LUK	1.6	1990.07 - 1992.12		3021.88D50
1.6 16V	L1E	1.6	1995.01 - 2000.07		4270.88D
1.6 16V XR3i	L1E, L1H	1.6	1992.12 - 1999.09		4270.88D
1.6 i 16V	L1E, L1K, L1H	1.6	1992.09 - 1999.02		4270.88D

FORD
**Motor
Engine
Moteur**
**Ltr.
Ltr.
Ltr.**
**Jahr
Year
Année**
**Einschränkung
Restriction*
Restriction***
**Thermostat
Thermostat
Thermostat**

1.8 16V	RDA, RKC	1.8	1992.02 - 1999.02		4270.88D
1.8 16V XR3i	RDA, RKC, RQB	1.8	1992.02 - 2000.08		4270.88D
1.8 D	RTH, RTF, RTE	1.8	1990.07 - 1999.02		4270.88D
1.8 i 16V	RDA, RQB	1.8	1992.09 - 1995.01		4270.88D
1.8 TD	RFS, RFD, RFK	1.8	1991.05 - 2000.07		410131.88D
1.8 Turbo D	RVA	1.8	1995.12 - 2001.06		4270.88D
1.8 XR3i 16V	RDA, RQB	1.8	1993.08 - 1995.01		4270.88D
RS 2000	N7A	2.0	1991.05 - 1998.10		3021.88D50

EVEREST (25N_)

2.5 TD	WL84	2.5	2003.05 -		4639.82D
--------	------	-----	-----------	--	----------

FIESTA II (FBD)

1.0	TKB, TLB	1.0	1983.09 - 1989.11		3004.88D1
1.1	GSF, GSH, GLC	1.1	1983.09 - 1989.02		3004.88D1
1.3	JPC	1.3	1983.09 - 1987.01		3021.88D50
1.4	F6C, F6A, FUB, FUBA, FUD	1.4	1983.09 - 1989.11		3021.88D50
1.6 D	LTB	1.6	1984.04 - 1989.02		4256.87D50
1.6 XR2	LUB, LUD	1.6	1984.03 - 1989.02		3021.88D50

FIESTA III (GFJ)

1.0	TLB	1.0	1989.03 - 1989.10		3004.88D1
1.0	TLB	1.0	1989.10 - 1995.12		3004.92D1
1.1	G6A, GUD, GUE	1.1	1989.03 - 1989.10		3004.88D1
1.1	G6A, GUD, GUE	1.1	1989.10 - 1995.12		3004.92D1
1.3	JBC	1.3	1989.03 - 1989.10		3004.88D1
1.3	JBC	1.3	1989.10 - 1992.12		3004.92D1
1.3	J6B	1.3	1991.05 - 1997.01		3004.92D1
1.4	F4A, F6E, FUG, FUJ	1.4	1989.03 - 1995.12		3021.88D50
1.6	LUH	1.6	1989.01 - 1994.01		3021.88D50
1.6 i 16V	L1G	1.6	1994.01 - 1995.12		4270.88D
1.6 Turbo	LHA	1.6	1990.03 - 1992.10		3021.88D50
1.6 XR2i	LJC, LJD	1.6	1989.03 - 1994.01	CVH	3021.88D50
1.8 16V	RDB	1.8	1992.02 - 1995.12		4270.88D
1.8 D	RTD, RTG, RTC	1.8	1989.03 - 1995.12		4270.88D
1.8 TD	RFL	1.8	1993.03 - 1995.12		4270.88D
1.8 XR2i 16V	RQC	1.8	1992.02 - 1995.12		4270.88D

FIESTA IV (JA_, JB_)

1.0 i	ZH10JRB	1.0	1997.02 - 2002.01		3004.92D1
1.25 i 16V	DHG, DHB, DHC, DHE, DHF, DHA, DHD	1.25	1995.08 - 2002.01		4457.82D
1.3 i	J4R, J4C, J4L, J4J, J4Q, J4T, JJA, JJE, JJM, JJC, JJJ, JJK	1.3	1995.08 - 2002.01		3004.88D1
1.4 i 16V	FHE, FHA	1.4	1996.04 - 2002.01		4457.82D
1.6 16V Sport	L1V, L1T	1.6	2000.02 - 2002.01		4457.82D
1.8 D	RTK, RTJ	1.8	1995.08 - 2000.04		4270.88D
1.8 DI	RTP, RTN, RTQ	1.8	2000.04 - 2002.01		410131.88D

FIESTA V (JH_, JD_)

1.0		1.0	2002.05 - 2008.03		3004.92D1
1.25 16V	FUJA, FUJB, M7JA, M7JB	1.25	2002.05 - 2004.03		4457.82D
1.25 16V	FUJA, FUJB, M7JA, M7JB	1.25	2004.03 -		4483.82D
1.4 16V	FXJB, FXJA	1.4	2001.11 - 2004.03		4457.82D

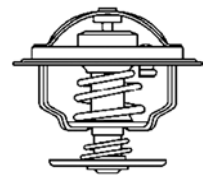

FORD

	Motor Engine Moteur	Ltr. Ltr. Ltr.	Jahr Year Année	Einschränkung Restriction* Restriction*	Thermostat Thermostat Thermostat
1.4 16V	FXJB, FXJA	1.4	2004.03 -		4483.82D
1.6 16V	FYJA, FYJB	1.6	2001.11 - 2004.03		4457.82D
1.6 16V	FYJA, FYJB	1.6	2004.03 -		4483.82D
FIESTA VI					
1.25	SNJA, SNJB, STJA, STJB	1.25	2008.10 -		4483.82D
1.4	RTJA, RTJB, SPJA, SPJC	1.4	2009.01 -		4483.82D
1.6		1.6	2008.10 -		4483.82D
1.6 Ti	HXJB, HXJA, IQJA, U5JA	1.6	2008.10 -		4483.82D
Fiesta COURIER (F3L, F5L)					
1.3	J6B	1.3	1991.09 - 1996.02		3004.88D1
1.8 D	RTD, RTG, RTC	1.8	1991.09 - 1996.02		4270.88D
1.8 TD		1.8	1993.07 - 1995.08		4270.88D
FIESTA Kasten (WFVT)					
1.0	TKA	1.0	1977.10 - 1986.11		3004.88D1
1.1	GL1, GLA	1.1	1977.10 - 1986.11		3004.88D1
FIESTA Kasten (FVD)					
1.0	TKB	1.0	1983.08 - 1989.11		3004.88D1
1.8 D	RTD, RTG, RTC	1.8	1989.03 - 1995.12		4270.88D
1.8 TD		1.8	1993.07 - 1995.08		4270.88D
FIESTA Courier (J5_, J3_)					
1.3	J4C	1.3	1996.02 -		3004.88D1
1.4 i	FHA	1.4	1996.04 - 1999.10		4457.82D
1.8 D	RTK	1.8	1996.02 -		410131.88D
1.8 DI	RTP, RTN	1.8	2000.09 -		410131.88D
FIESTA Kasten (JV_)					
1.8 D	RTK, RTJ	1.8	1998.05 -		410131.88D
1.8 TD	RTP, RTN, RTQ	1.8	2000.03 -		410131.88D
FIESTA Van					
1.25	SNJA, SNJB	1.25	2009.01 -		4483.82D
FOCUS (DAW, DBW, DFW, DNW)					
1.4 16V	FXDA, FXDD, FXDC, FXDB	1.4	1998.10 - 2003.09		4457.82D
1.4 16V	FXDA, FXDD, FXDC, FXDB	1.4	2003.09 - 2004.11		4483.82D
1.6 16V	FYDH, FYDA, FYDB, FYDD, FYDC	1.6	1998.10 - 2003.09		4457.82D
1.6 16V	FYDH, FYDA, FYDB, FYDD, FYDC	1.6	2003.09 - 2004.11		4483.82D
1.8 16V	EYDD, EYDC, EYDE, EYDL, EYDF, EYDG, EYDB, EYDJ, EYDI	1.8	1998.10 - 2004.11		4270.88D
1.8 BiFuel		1.8	2003.02 - 2005.01		4270.88D
1.8 DI / TDDi	BHDB, BHDA	1.8	1998.08 - 2004.11		410131.88D
1.8 TDCi	F9DA, F9DB, FFDA	1.8	2001.03 - 2004.11		410131.88D
1.8 Turbo DI / TDDi	BHDB, BHDA, C9DA, C9DB, C9DC	1.8	1998.10 - 2005.03		410131.88D
2.0 16V	EDDC, EDDB, EDDD, EDDF	2.0	1998.10 - 2004.11		4270.88D
RS	HMDA	2.0	2002.10 - 2004.11		4270.88D
ST 170	ALDA	2.0	2002.03 - 2004.11		4270.88D

FORD
**Motor
Engine
Moteur**
**Ltr.
Ltr.
Ltr.**
**Jahr
Year
Année**
**Einschränkung
Restriction*
Restriction***
**Thermostat
Thermostat
Thermostat**
FOCUS II

1.4	ASDB, ASDA	1.4	2004.11 -		4483.82D
1.6	SHDA, HWDB, SHDB, HWDA, SHDC, SIDA	1.6	2004.11 -		4483.82D
1.6 Ti	HXDB, HXDA	1.6	2004.11 - 2005.12	3 Anschlüsse	4825.98D
1.6 Ti	HXDB, HXDA	1.6	2006.01 -	2 Anschlüsse	410016.98D
1.8 TDCi	KKDA, KKDB	1.8	2004.11 -		410131.88D

FOCUS III

1.6	MUDA	1.6	2011.04 -		4483.82D
1.6 Ti	IQDB, PNDA, XTDA	1.6	2011.04 -		4483.82D

FOCUS C-MAX

1.6	HWDB, HWDA	1.6	2003.10 - 2007.03		4483.82D
1.6 Ti	SIDA, HXDA	1.6	2004.08 - 2006.12	3 Anschlüsse	4825.98D
1.6 Ti	SIDA, HXDA	1.6	2006.01 - 2007.03	2 Anschlüsse	410016.98D
1.8 TDCi	KKDA	1.8	2005.01 - 2007.03		410131.88D

FUSION

1.25	FUJA, FUJB	1.25	2004.08 -		4483.82D
1.4	FXJC, FXJB, FXJA, UTJA	1.4	2002.08 - 2004.03		4457.82D
1.4	FXJC, FXJB, FXJA, UTJA	1.4	2004.04 -		4483.82D
1.6	FYJA, FYJB	1.6	2002.08 - 2004.03		4457.82D
1.6	FYJA, FYJB	1.6	2004.04 -		4483.82D

GALAXY

1.8 TDCi	FFWA, QYWA	1.8	2006.05 -		410131.88D
1.9 TDI		1.9	1995.03 - 2006.05		4264.87D
2.0 i	NSE, ZVSA	2.0	1995.11 - 2006.05		3021.88D50
2.3	Y5B	2.3	1996.09 - 2000.04		3021.88D50
2.3 16V	Y5B, E5SA	2.3	1997.01 - 2006.05		3021.88D50
2.8 V6	AYL	2.8	2000.04 - 2006.05		4123.80D
2.8 i V6	AAA, AMY	2.8	1995.11 - 2000.04		4123.80D

GRAND C-MAX

1.6 Ti	IQDB, IQDA, PNDA	1.6	2010.12 -		4483.82D
--------	------------------	-----	-----------	--	----------

KA

1.3 TDCi	FD4	1.3	2010.11 -		411774.88D ▲
----------	-----	-----	-----------	--	--------------

KA (RB_)

1.0 i		1.0	1997.07 - 2008.11		3004.92D1
1.3 i	HCS Endura	1.3	1996.09 - 2008.11		3004.92D1
1.3 i	JJH, JJD, JJF, JJG, JJJ	1.3	1998.06 - 2008.11		3004.92D1

MAVERICK

2.0 16V	YF	2.0	2001.02 -		4270.88D
2.4 i	KA-24, KA24-E	2.4	1993.02 - 1996.08		4637.76D

ONDEO I (GBP, BNP)

1.6 i 16V	L1F, L1J	1.6	1993.02 - 1996.08		4270.88D
1.8 i 16V	RKA, RKB	1.8	1993.02 - 1996.08		4270.88D

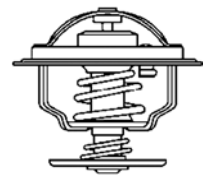

FORD

	Motor Engine Moteur	Ltr. Ltr. Ltr.	Jahr Year Année	Einschränkung Restriction* Restriction*	Thermostat Thermostat Thermostat
1.8 TD	RFM, RFN	1.8	1993.06 - 1996.08		4270.88D
2.0 i 16V	NGA	2.0	1993.01 - 1996.08		4270.88D
MONDEO II (BAP, BFP, BNP)					
1.6 i	L1J	1.6	1996.09 - 2000.11		4270.88D
1.6 i 16V	L1N, L1L, L1Q	1.6	1998.05 - 2000.11		4270.88D
1.8 i	RKK, RKJ, RKB, RKF, RKH	1.8	1996.09 - 2000.11		4270.88D
1.8 TD	RFN	1.8	1996.09 - 2000.11		4270.88D
2.0 i	NGA, NGB, NGD, NGC	2.0	1996.09 - 2000.11		4270.88D
MONDEO III (B4Y, B5Y, BWY)					
2.0 16V DI / TDDi / TDCi	SDBA, D5BA	2.0	2000.11 - 2007.08		3497.88D
2.0 16V TDDi / TDCi	HJBA, HJBB, D6BA, HJBC	2.0	2000.11 - 2007.08		3497.88D
2.0 TDCi	N7BA, FMBA	2.0	2001.10 - 2007.08		3497.88D
2.2 TDCi	QJBA, QJBB, QJBC, QJBD	2.2	2004.09 - 2007.08		3497.88D
MONDEO IV					
1.6 Ti	KGBA, PNBA, RHBA	1.6	2007.03 -		4483.82D
1.8 TDCi	FFBA, KHBA, QYBA	1.8	2007.03 -		410131.88D
ORION I / II (AFD, AFF)					
1.3	JPA	1.3	1983.07 - 1986.03		3021.88D50
1.3	JLA, JBB, JLB	1.3	1985.12 - 1990.07		3004.88D1
1.3	JPA	1.3	1986.11 - 1988.07		3004.88D1
1.4	F6D, F6B, FUA, FUAA, FUC	1.4	1985.12 - 1990.07		3021.88D50
1.6	LP1, LPA, LUC	1.6	1983.07 - 1990.07		3021.88D50
1.6 D	LTA, LTC	1.6	1984.02 - 1989.01		4256.87D50
1.6 i	L4B, LJB, LR1, LRA, LRB,	1.6	1983.07 - 1990.07		3021.88D50
1.8 D	RTA, RTB	1.8	1989.01 - 1990.07		4256.87D50
ORION III (GAL)					
1.3	J6A, J4B	1.3	1990.07 - 1993.12		3004.92D1
1.4	F6F, F6G, FUH	1.4	1990.07 - 1993.12		3021.88D50
1.6	LUJ, LUK	1.6	1990.07 - 1992.12		3021.88D50
1.6 i	LJF	1.6	1990.07 - 1992.09		3021.88D50
1.6 i 16V	L1E, L1K	1.6	1992.07 - 1993.12	Zetec	4270.88D
1.8 D	RTH, RTF, RTE	1.8	1990.11 - 1993.12		4270.88D
1.8 i 16V	RDA, RQB	1.8	1992.01 - 1993.12		4270.88D
1.8 TD	RFD, RFK	1.8	1992.03 - 1993.12		4270.88D
P 100					
1.6	LCR	1.6	1982.04 - 1987.09		3021.88D50
1.8 TD	RFA	1.8	1987.10 - 1992.12		4270.88D
2.0	NAE	2.0	1987.10 - 1992.12		3021.88D50
PROBE II (ECP)					
2.0 16V	FS	2.0	1993.10 - 1998.03		4639.82D
PUMA (EC)					
1.4 16V	FHD, FHF	1.4	1997.11 - 2000.10		4457.82D
1.6 16V	L1W	1.6	2000.08 - 2002.06		4457.82D
1.7 16V	MHB, MHA	1.7	1997.03 - 2002.06		4457.82D
ST 160		1.7	1999.06 - 2002.06		4457.82D

FORD
**Motor
Engine
Moteur**
**Ltr.
Ltr.
Ltr.**
**Jahr
Year
Année**
**Einschränkung
Restriction*
Restriction***
**Thermostat
Thermostat
Thermostat**
RANGER

2.5 D	WL	2.5	1999.10 - 2002.04		4639.82D
2.5 TD	WL-T	2.5	1999.10 - 2006.06		4639.82D
2.5 TDDi		2.5	2002.04 - 2005.09		4639.82D
2.9 D		2.9	1999.06 - 2002.02		4639.82D
2.2 TDCi	GBVAJPF, AJQJ, AJQW	2.2	2011.04 -		3497.88D
2.5 TDCi	WLAA	2.5	2006.05 -		4639.82D
3.0 TDCi	WEAT	3.0	2006.05 -		4639.82D
3.0 TDCi	SAFA	3.0	2011.04 -		3497.88D

SCORPIO I (GAE, GGE)

1.8	REC	1.8	1985.04 - 1992.02		3021.88D50
2.0		2.0	1985.04 - 1989.08	OHC	3021.88D50
2.0		2.0	1985.04 - 1993.03	DOHC	3100.88D
2.0 i		2.0	1985.10 - 1992.02	OHC	3021.88D50
2.0 i		2.0	1989.05 - 1994.09	DOHC	3100.88D
2.4 i	ARC, ARD	2.4	1986.09 - 1994.10		4270.88D
2.5 D	STR	2.5	1985.12 - 1994.12		4147.80D
2.5 TD	SCB, SFA, SFB	2.5	1988.06 - 1994.09		4147.80D
2.8 i	PRE	2.8	1985.04 - 1986.11		4256.87D50
2.9 24V	BOA	2.9	1993.08 - 1994.09		4270.88D
2.9 i	BRC, BRD, BRE, BRF	2.9	1986.09 - 1994.12		4270.88D
2.9 i 24V	BOA	2.9	1991.04 - 1994.09		4270.88D

SCORPIO II (GFR, GGR, GNR)

2.0 i		2.0	1994.10 - 1998.08	DOHC	3100.88D
2.0 i 16V		2.0	1994.10 - 1998.08	DOHC	3100.88D
2.3 i 16V	Y5A	2.3	1996.06 - 1998.08	DOHC	3100.88D
2.5 TD	SCC, VM	2.5	1994.10 - 1998.08		4158.80D
2.9 i	BRG	2.9	1995.02 - 1998.08		4270.88D
2.9 i 24V	BOB	2.9	1994.10 - 1998.08		4270.88D

SIERRA

1.3	JCT	1.3	1982.08 - 1986.12		3021.88D50
1.6		1.6	1982.08 - 1993.02		3021.88D50
1.6 i	L6B	1.6	1989.10 - 1993.02		3021.88D50
1.8	REB	1.8	1984.10 - 1989.09	48 mm Ø	3021.88D50
1.8 TD	RFA, RFB, RFL	1.8	1988.08 - 1993.02		4270.88D
2.0		2.0	1982.08 - 1993.02	OHC	3021.88D50
2.0	NYT	2.0	1982.08 - 1984.10	V6	4256.87D50
2.0		2.0	1987.01 - 1993.02	DOHC	3100.88D
2.0 16V Cosworth		2.0	1990.01 - 1993.02	OHC	3021.88D50
2.0 16V Cosworth		2.0	1990.01 - 1993.02	DOHC	3100.88D
2.0 i		2.0	1987.01 - 1993.02	OHC	3021.88D50
2.0 i		2.0	1987.01 - 1993.02	DOHC	3100.88D
2.0 i DOHC	N9E	2.0	1991.12 - 1993.02		3100.88D
2.0 RS Cosworth	N5B	2.0	1987.11 - 1990.01	OHC	3021.88D50
2.0 RS Cosworth	N5B	2.0	1987.11 - 1990.01	DOHC	3100.88D
2.3	YYT	2.3	1982.08 - 1986.12		4256.87D50
2.3 D	YTR, YTT	2.3	1987.01 - 1993.02		4147.80D
2.8	PRG	2.8	1987.01 - 1988.08		4256.87D50
2.8 i	PR5, PR6, PR8, PRG	2.8	1982.08 - 1993.02		4256.87D50
2.8 XR	PRT	2.8	1985.02 - 1986.12		4256.87D50
2.8 XR4i	PR5, PR6, PRT	2.8	1982.08 - 1986.12		4256.87D50
2.9	B4B, B4C	2.9	1988.08 - 1993.02		4270.88D

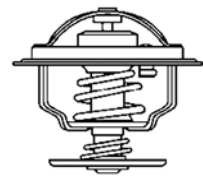

FORD

	Motor Engine Moteur	Ltr. Ltr. Ltr.	Jahr Year Année	Einschränkung Restriction* Restriction*	Thermostat Thermostat Thermostat
2.9 i	B4B, B4C	2.9	1988.08 - 1993.02		4270.88D
2.9 i XR	B4A, B4B, B4C	2.9	1988.08 - 1993.02		4270.88D
S-MAX					
1.8 TDCi	FFWA, QYWA	1.8	2006.05 -		410131.88D
TOURNEO CONNECT 1.8 16V	EYPC, EYPA, EYPD	1.8	2002.06 -		4270.88D
1.8 Di	BHPA, P7PA, P7PB, R2PA	1.8	2002.06 -		410131.88D
1.8 TDCi	RWPC, RWPA, RWPD	1.8	2006.08 -		410131.88D
1.8 Turbo Di	P9PB, P9PA, HCPB, RWPF, P9PC, R3PA, RWPE, HCPA, P9PD	1.8	2002.06 -		410131.88D
TRANSIT (E_ _)					
2.0		2.0	1991.09 - 1994.09	OHC	3021.88D50
2.0		2.0	1994.08 - 2000.03	DOHC	3100.88D
2.5 DI		2.5	1991.05 - 2000.03		4270.88D
2.5 TD		2.5	1991.05 - 2000.03		4270.88D
2.5 TDI		2.5	1994.06 - 2000.03		4270.88D
2.9 i	BRT	2.9	1991.01 - 1994.09		4270.88D
TRANSIT (F_ _)					
2.0 DI	ABFA, D3FA, F3FA	2.0	2000.08 - 2006.05		3497.88D
2.0 TDCi	FIFA	2.0	2002.08 - 2006.05		3497.88D
2.3 16V	E5FC, E5FA	2.3	2000.08 - 2006.05		3100.88D
2.4 DI	D2FA, D2FB, D2FE, D4FA, F4FA	2.4	2000.01 - 2006.05		3497.88D
2.4 TD	F4FA	2.4	2000.08 - 2003.08		3497.88D
2.4 TDCi	H9FA	2.4	2004.03 - 2006.05		3497.88D
2.4 TDdi	D4FA	2.4	2000.08 - 2003.08		3497.88D
2.4 TDE	DOFA, FXFA	2.4	2001.07 - 2006.05		3497.88D
TRANSIT (T_ _)					
1.6	LAT, L3C	1.6	1985.09 - 1992.09		3021.88D50
2.0	NAT, NAV	2.0	1985.09 - 1992.09	OHC	3021.88D50
2.5 D	4BA, 4CA, 4AB	2.5	1985.12 - 1992.09		4147.80D
2.5 DI	4BA, 4CA	2.5	1988.09 - 1992.09		4147.80D
TRANSIT (V_ _)					
1.6		1.6	1977.11 - 1986.10		3021.88D50
2.0	4RC	2.0	1977.11 - 1986.10	OHC / TL20	3021.88D50
2.4 D	4AA	2.4	1977.11 - 1986.10		3004.74
2.5 D		2.5	1983.10 - 1986.10		4147.80D
TRANSIT 2007 →					
2.2 TDCi		2.2	2006.04 -		3497.88D
2.4 TDCi		2.4	2006.04 -		3497.88D
3.2 TDCi		3.2	2007.09 -		3497.88D
TRANSIT Bus					
2.2 TDCi		2.2	2006.04 -		3497.88D
2.4 TDCi		2.4	2006.04 -		3497.88D
3.2 TDCi		3.2	2008.02 -		3497.88D

FORD
**Motor
Engine
Moteur**
**Ltr.
Ltr.
Ltr.**
**Jahr
Year
Année**
**Einschränkung
Restriction*
Restriction***
**Thermostat
Thermostat
Thermostat**
TRANSIT CONNECT

1.8 16V	EYPC, EYPA, EYPD	1.8	2002.06 -		4270.88D
1.8 Di	BHPA, P7PA, P7PB, R2PA	1.8	2002.06 -		410131.88D
1.8 TDCi		1.8	2002.06 -		410131.88D

TRANSIT TOURNEO

2.0	NSH	2.0	1994.11 - 2000.12		3100.88D
2.2 TDCi		2.2	2006.07 -		3497.88D
2.4 D	4HA	2.4	1994.08 - 2000.06		410131.88D
2.5 DI		2.5	1994.11 - 2000.12		410131.88D
2.5 TD		2.5	1994.11 - 2000.12		410131.88D



HONDA

	Motor Engine Moteur	Ltr. Ltr. Ltr.	Jahr Year Année	Einschränkung Restriction* Restriction*	Thermostat Thermostat Thermostat
ACCORD III (CA4, CA5)					
1.6	A16A1	1.6	1985.11 - 1989.12		3119.82
2.0 EX	A20A1, A20A2	2.0	1985.11 - 1989.12		3119.82
2.0 EXi	A20A3, A20A4	2.0	1985.11 - 1989.12		3119.82
ACCORD IV (CB, CC1)					
2.0 16V	F20A3, F20A2, F20A6	2.0	1990.01 - 1993.03		410224.78D
2.0 i 16V	F20A4, F20A7, F20A8	2.0	1990.01 - 1993.09		410224.78D
2.2	F22A6	2.2	1991.10 - 1994.12		410224.78D
2.2 i 16V	F20Z3, F22A3, F22A7, F22A8	2.2	1990.01 - 1993.12		410224.78D
ACCORD V (CC7, CD, CE, CF)					
1.9 i	F18A3	1.9	1996.02 - 1998.10		410224.78D
2.0	F20B3	2.0	1993.09 - 1997.12		410224.78D
2.0 i	F20Z1, F20Z2	2.0	1993.03 - 1998.10		410224.78D
2.0 i 16V	F20B3	2.0	1993.09 - 1998.02		410224.78D
2.2 i	F22B5	2.2	1993.09 - 1998.02		410224.78D
2.2 i VTEC	F22Z2	2.2	1996.02 - 1998.10		410224.78D
ACCORD VI (CG, CH, CK, CM)					
1.6	D16B6, D16B7	1.6	1998.10 - 2002.12		410224.78D
1.6 i	D16B6	1.6	1998.10 - 2002.12		410224.78D
1.8 i	F18B2	1.8	1998.10 - 2002.12		410224.78D
2.0	F20B6, F20B7	2.0	1999.11 - 2002.12		410224.78D
2.0 i	F20B6	2.0	1998.10 - 2001.01		410224.78D
2.0 i 16V	F20B7, F20B5	2.0	1998.02 - 2003.06		410224.78D
2.2 Type-R	H22A7	2.2	1999.02 - 2002.12		410224.78D
2.3	F23A1, F23Z5	2.3	2000.11 - 2003.06		410224.78D
2.3 16 V	F23A7	2.3	1998.02 -		410224.78D
2.4 Vtec	K24A2	2.4	2003.09 - 2005.09		410226.78D
ACCORD VII (CL, CM)					
2.0	K20A6	2.0	2003.02 -		410226.78D
2.4	K24A	2.4	2003.02 - 2008.07		410226.78D
2.4 i 16V	K24A3	2.4	2003.02 -		410226.78D
2.4 Vtec	K24A	2.4	2003.02 - 2008.07		410226.78D
ACCORD VIII (CU)					
2.0 i	R20A3	2.0	2008.07 -		410226.78D
ASCOT					
1.8		1.8	1995.04 - 1997.10		410224.78D
2.2 EX	F22A7, F22A8	2.2	1990.11 - 1996.10		410224.78D
AVANCIER					
2.3	F23A	2.3	1999.09 - 2003.09		410224.78D
CAPA					
1.5	D15B	1.5	1998.01 - 2002.09		410224.78D
1.5 16V	D15B	1.5	1998.04 - 2002.09		410224.78D

HONDA
**Motor
Engine
Moteur**
**Ltr.
Ltr.
Ltr.**
**Jahr
Year
Année**
**Einschränkung
Restriction*
Restriction***
**Thermostat
Thermostat
Thermostat**
CITY

1.2	L12A2, L12A3	1.2	2003.05 -		410224.78D
1.3	D13B4	1.3	1997.02 - 2003.09		410224.78D
1.3	L13A1	1.3	2001.09 - 2004.10	82° Variante	410224.82D
1.3	L13A1	1.3	2003.05 - 2005.09	78° Variante	410224.78D
1.3	L13A3	1.3	2005.10 -		410224.78D
1.4 i-V TEC	L13Z1	1.4	2008.09 -		410224.78D
1.5	D15B7, L15A1	1.5	1997.02 - 2005.09		410224.78D
1.5 Vtec	L15A4	1.5	2000.08 -	78° Variante	410224.78D
1.5 Vtec	L15AV	1.5	2000.08 -	82° Variante	410224.82D

CIVIC II

1.4 i 16V	D14A1	1.4	1988.01 - 1992.12		410224.78D
1.5 i 16V	D15B2	1.5	1988.01 - 1991.11		410224.78D
1.6	D16A, D16A7	1.6	1988.01 - 1992.12		410224.78D
1.6 i 16V	D16A6	1.6	1988.01 - 1995.02		410224.78D
1300	EN1	1.3	1979.09 - 1983.09		3119.82

CIVIC III

1.2	ZA2, D12B1	1.2	1984.01 - 1987.10		4269.78D
1.3	EV2	1.3	1983.10 - 1987.10		4269.78D
1.5	EW2	1.5	1983.10 - 1987.10		4269.78D
1.5 GT / GTI	EW3, EW4	1.5	1985.01 - 1987.10		4269.78D

CIVIC IV

1.2	D12B1	1.2	1988.01 - 1991.12		4269.78D
1.3	D13B1	1.3	1987.10 - 1989.12		4269.78D
1.3 16V	D13B2	1.3	1989.09 - 1991.09		4269.78D
1.4	D14A1	1.4	1987.10 - 1989.12		4269.78D
1.5	D15B1	1.5	1988.01 - 1989.12		4269.78D
1.5 i 16V	D15B2	1.5	1987.10 - 1991.09		4269.78D
1.6	D16Z5	1.6	1988.01 - 1989.12		4269.78D
1.6 16V	D16A, D16Z	1.6	1987.09 - 1991.09		4269.78D
1.6 i 16V Vtec	B16A1	1.6	1989.10 - 1991.09		4269.78D

CIVIC V

1.3	D13B2	1.3	1992.01 - 1992.12		410224.78D
1.3 16V	D13B2	1.3	1991.10 - 1995.11		410224.78D
1.5	D15B, D15Z	1.5	1992.01 - 1995.12		410224.78D
1.5 i	D15B7	1.5	1993.08 - 1995.11		410224.78D
1.5 i 16V	D15B, D15Z	1.5	1991.10 - 1995.11		410224.78D
1.6	D16A, D16Z	1.6	1992.01 - 1995.10		410224.78D
1.6 16V Vtec	D16Z6, D16Z7	1.6	1991.10 - 1995.11		410224.78D
1.6 i	D16Y7	1.6	1994.01 - 1995.11		410224.78D
1.6 i Vtec	B16A2, D16Y6, D16Z9	1.6	1994.01 - 1996.03		410224.78D
1.6 Vtec	B16A1	1.6	1991.10 - 1995.05		410224.78D
1.6 VTi	B16A2	1.6	1991.10 - 1995.11		410224.78D
1.6 VTi 16V	B16A2	1.6	1991.10 - 1995.11		410224.78D

CIVIC VI

1.4	D14A4, D14Z4	1.4	1995.11 - 2001.02		410224.78D
1.4 16V	D14A7, D14A8	1.4	1998.04 - 2001.02		410224.78D
1.4 i	D14A	1.4	1994.09 - 2001.02		410224.78D
1.5	D15Z3	1.5	1995.11 - 1996.12		410224.78D

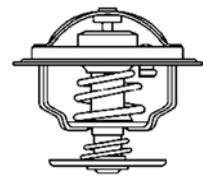

HONDA

	Motor Engine Moteur	Ltr. Ltr. Ltr.	Jahr Year Année	Einschränkung Restriction* Restriction*	Thermostat Thermostat Thermostat
1.5 16V	D15Z8	1.5	1997.01 - 2001.02		410224.78D
1.5 i	D15B2, D15Z6	1.5	1995.10 - 2001.03		410224.78D
1.5 i Vtec-E	D15Z3	1.5	1994.09 - 1997.01		410224.82D
1.6	D16Y2, D16Y7, D16W4	1.6	1995.10 - 2000.10		410224.78D
1.6 16V	D16B2, D16W4	1.6	1997.01 - 2001.02		410224.78D
1.6 i	D16Y3	1.6	1994.09 - 1997.01		410224.78D
1.6 i	D16Y5, D16Y7	1.6	1995.11 - 2001.02		410224.78D
1.6 i Vtec	B16A2, D16Y2, D16Y6, D16Y8, D16Z7	1.6	1994.09 - 2001.02		410224.78D
1.6 VTEC Type R		1.6	1997.08 - 2000.09		410224.78D
1.6 VTi	B16A2	1.6	1995.11 - 2001.02		410224.78D
1.7	D17A6	1.7	1997.11 - 2001.03		410224.78D
1.8 16V	B18C4	1.8	1997.01 - 2001.02		410224.78D
CIVIC VII					
1.3	LDA1	1.3	2004.01 - 2005.09		410224.78D
1.4	D14Z5	1.4	2000.11 - 2005.09		410224.78D
1.4 i	D14Z5, D14Z6	1.4	2001.02 - 2005.09		410224.78D
1.6	D16V1, R16A1	1.6	2001.02 - 2005.09		410224.78D
1.6 i	D16V1	1.6	2001.02 - 2005.12		410224.78D
1.7	D17A6	1.7	2001.02 - 2005.09		410224.78D
1.7 i	D17A8	1.7	2001.05 - 2005.12		410224.78D
1.7 i VTEC	D17A5, D17A9	1.7	2001.05 - 2005.12		410224.78D
2.0 i Sport	K20A3	2.0	2001.09 - 2005.09		410225.78D
2.0 Type-R	K20A2	2.0	2001.09 - 2005.09		410225.78D
CIVIC VIII					
1.3 Hybrid	LDA2	1.3	2006.01 - 2012.02		410224.82D
1.4	L13A7	1.4	2006.01 -		410224.82D
1.8	R18A1, R18A2	1.8	2005.09 - 2012.02		410224.78D
2.0	K20Z4	2.0	2006.12 -		410226.78D
Type R	K20Z4	2.0	2006.09 -		410226.78D
CONCERTO					
1.4	D14A1, D14A8	1.4	1989.08 - 1992.10		410224.78D
1.5 i 16V	D15B2	1.5	1989.08 - 1995.05		410224.78D
1.6	D16A9	1.6	1989.10 - 1992.10		410224.78D
1.6 16V	D16Z2	1.6	1989.08 - 1995.03		410224.78D
1.6 i 16V	D16A8, D16Z2	1.6	1989.08 - 1995.03		410224.78D
CR-V I (RD)					
2.0	B20Z1	2.0	1999.04 - 2002.02		410224.78D
2.0 16V	B20B, B20Z1	2.0	1995.10 - 2002.02		410224.78D
CR-V II					
2.0	K20A4, K20A5	2.0	2002.03 - 2006.09		410225.78D
2.4 Vtec	K24A1	2.4	2001.09 - 2006.09		410225.78D
CR-V III					
2.0 i	R20A2	2.0	2007.01 -		410224.78D
2.4	K24A1, K24Z1	2.4	2006.09 -		410226.78D
2.4 i-VTEC	K24Z4, K24Z1	2.4	2006.10 -		410226.78D

HONDA

 Motor
Engine
Moteur

 Ltr.
Ltr.
Ltr.

 Jahr
Year
Année

 Einschränkung
Restriction*
Restriction*

 Thermostat
Thermostat
Thermostat

CR-V IV (RE)

2.0		2.0	2012.01 -		410224.82D
2.4		2.4	2012.01 -		410226.78D

CR-Z (ZF1)

1.5 Hybrid	LEA1, LEA3	1.5	2010.06 -		410224.78D
------------	------------	-----	-----------	--	------------

CRX I (AF, AS)

1.3	EV2	1.3	1983.10 - 1987.10		410224.78D
1.5 i	EW3	1.5	1983.10 - 1986.11		410224.78D
1.6 i 16V	ZC1	1.6	1986.03 - 1987.10		410224.78D

CRX II (ED, EE)

1.4	D14A1	1.4	1990.01 - 1991.12		410224.78D
1.6 i 16V	D16A, D16Z	1.6	1987.10 - 1992.02		410224.78D
1.6 i 16V Vtec	B16A1	1.6	1989.10 - 1992.02		410224.78D

CRX III (EH, EG)

1.5	D15B7	1.5	1994.01 - 1998.04		410224.78D
1.6 ESi	D16Y8, D16Z6	1.6	1992.03 - 1998.12		410224.78D
1.6 i VTi	B16A2	1.6	1992.03 - 1998.12		410224.78D

DOMANI

1.4	B13B	1.4	1994.11 - 1997.12		410224.78D
1.5	D15B3	1.5	1992.10 - 2000.09		410224.78D
1.6	D16Z2	1.6	1988.11 - 1997.12		410224.78D
1.8	B18B6	1.8	1994.10 - 2000.09		410224.78D

FIT

1.3	L13A1	1.3	2003.05 -		410224.82D
1.5	L15A1, L15A2	1.5	2003.05 -		410224.82D

FR-V

1.7	D17A2	1.7	2004.08 -		410224.78D
1.8	R18A1	1.8	2007.01 -		410224.82D
2.0	K20A9	2.0	2005.02 -		410225.78D

HR-V (GH)

1.6 16V	D16W1, D16W5	1.6	1999.03 -		410224.78D
---------	--------------	-----	-----------	--	------------

INTEGRA

1.6	B16A	1.6	1989.09 - 1993.08		410224.78D
1.6 Vtec	B16A	1.6	1989.09 - 1993.08		410224.78D
1.8	F18A2	1.8	1989.09 - 1993.08		410224.78D
1.8 Type-R	B18C6	1.8	1997.11 - 2001.10		410224.78D
2.0	K20A3	2.0	2002.02 -		410225.78D
2.0 16V Type-R	K20Z1	2.0	2002.02 -		410224.78D

INSIGHT (ZE_)

1.3 Hybrid	LDA3	1.3	2009.04 -		410224.78D
------------	------	-----	-----------	--	------------

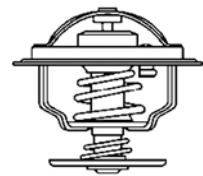

HONDA

	Motor Engine Moteur	Ltr. Ltr. Ltr.	Jahr Year Année	Einschränkung Restriction* Restriction*	Thermostat Thermostat Thermostat
JAZZ II					
1.2	L12A1	1.2	2002.03 - 2008.07		410224.82D
1.4	L13A1	1.4	2002.03 - 2008.07		410224.82D
JAZZ III					
1.2	L12B1	1.2	2008.07 -		410224.82D
1.4 i	L13Z1	1.4	2008.07 -		410224.82D
LEGEND I (HS, KA)					
2.5 i	C25A1, C25A2	2.5	1986.01 - 1988.06		4269.78D
2.7 i 24V	C27A1	2.7	1987.10 - 1990.12		4269.78D
LOGO (GA3)					
1.3	D13B7	1.3	1999.03 - 2002.03		410224.78D
PRELUDE I Coupe (SN)					
1.6	EL14, EL	1.6	1978.11 - 1982.10		3119.82
PRELUDE II (AB)					
1.8	ET2, ET3, ET4	1.8	1983.11 - 1987.04		3119.82
PRELUDE IV (BB)					
2.0 i 16V	F20A4	2.0	1992.02 - 1996.09		410224.78D
PRELUDE V (BB)					
2.0 16V	F20A4	2.0	1996.10 - 2000.10		410224.78D
QUINTET (SU)					
1.6 EX	EL	1.6	1980.02 - 1984.12		3119.82
SHUTTLE (RA)					
2.2 16V	F22B8	2.2	1994.10 - 1998.02		410224.78D
2.3 16V	F23A7	2.3	1997.10 - 2004.06		410224.78D
STEPWAGON					
2.0	K20A9	2.0	2000.10 - 2005.09		410224.78D
STREAM (RN)					
1.7 16V	D17A2	1.7	2001.05 -		410224.78D
2.0 16V	K20A1	2.0	2001.05 -		410225.78D
TORNEO					
1.6	D16B6	1.6	1999.10 - 2002.09		410224.78D
1.8	F18B	1.8	1999.10 - 2002.09		410224.78D
2.0	F20B, F20Z2	2.0	1994.04 - 2003.09		410224.78D
2.0 SiR	F20B4	2.0	1999.10 - 2003.09		410224.78D
2.0 VTS	F20B1	2.0	1998.01 - 2003.09		410224.78D

HYUNDAI
**Motor
Engine
Moteur**
**Ltr.
Ltr.
Ltr.**
**Jahr
Year
Année**
**Einschränkung
Restriction*
Restriction***
**Thermostat
Thermostat
Thermostat**
ACCENT (X-3)

1.3	G4EH	1.3	1994.10 - 2000.01		410351.88D
1.3 i 12V	G4EH	1.3	1994.10 - 2000.01		410351.88D
1.5 i 12V	G4EK	1.5	1994.10 - 2000.01		410351.88D
1.5 i 16V	G4ER	1.5	1995.10 - 2000.01		410348.82D

ACCENT (LC)

1.3	G4EA, G4EH	1.3	2000.04 - 2005.11		410351.88D
1.5	G4FK, G4EB, G4EC-G	1.5	1999.09 - 2005.11		410348.82D
1.6	G4ED-G	1.6	2002.12 - 2005.11		410348.82D

COUPE (RD)

1.6 16V	G4GR	1.6	1998.03 - 2002.04		410348.82D
1.6 i 16V	4G61	1.6	1996.12 - 2002.04		410348.82D
2.0 16V	G4DF, G4GF	2.0	1996.08 - 2002.04		410348.82D

COUPE (GK)

2.0	G4GC-G	2.0	2002.03 - 2009.08		410348.82D
-----	--------	-----	-------------------	--	------------

ELANTRA (XD)

1.6	G4ED-G	1.6	2000.06 - 2006.07		410348.82D
1.8	G4BB	1.8	2000.06 - 2006.07		410348.82D
2.0	G4GC, G4GC-G	2.0	2000.06 - 2006.07		410348.82D

GETZ (TB)

1.3, 1.3 i	G4EA	1.3	2002.09 - 2005.09		410351.88D
1.6	G4ED-G	1.6	2002.09 - 2005.09		410348.82D

LANTRA I (J-1)

1.5 i.e.	G15B, G4DJ	1.5	1990.10 - 1995.11		3119.82
1.6 i.e. 16V	G4CR	1.6	1990.10 - 1995.11		3119.82
1.8 i.e. 16V	G4CN	1.8	1990.10 - 1995.11		3119.82

LANTRA II (J-2)

1.6 16V	4G61	1.6	1995.11 - 2000.10		410348.82D
1.6 i	G4GR	1.6	1995.11 - 2000.10		410348.82D
1.8 16V	G4GM	1.8	1995.11 - 2000.10		410348.82D
1.9 D	DJY	1.9	1998.03 - 2000.10		4446.83D
2.0 16V	G4GF	2.0	1996.08 - 2000.10		410348.82D

MATRIX (FC)

1.6	G4ED-G	1.6	2001.06 - 2010.08		410348.82D
1.8	G4GB-G	1.8	2000.12 - 2010.08		410348.82D

PONY/EXCEL (X-2)

1.5 / 1.5 i	G15B, G4DJ	1.5	1989.10 - 1995.01		3119.82
-------------	------------	-----	-------------------	--	---------

SONATA II (Y-2)

2.0 i	G4CP-U	2.0	1991.01 - 1993.10		3119.82
2.0 i 16V	G4CP-D	2.0	1991.01 - 1993.10		3119.82

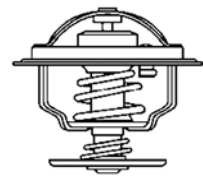
**HYUNDAI**

	Motor Engine Moteur	Ltr. Ltr. Ltr.	Jahr Year Année	Einschränkung Restriction* Restriction*	Thermostat Thermostat Thermostat
STELLAR (F31_, SF2_)					
1.6	G32B	1.6	1983.10 - 1991.12		3119.82
TRAJET (FO)					
2.0	G4JP-G, G4GC-G	2.0	2000.03 - 2008.07		410348.82D
2.0 CRDi	D4EA	2.0	2001.04 - 2008.07		410348.82D

INNOCENTI
**Motor
Engine
Moteur**
**Ltr.
Ltr.
Ltr.**
**Jahr
Year
Année**
**Einschränkung
Restriction*
Restriction***
**Thermostat
Thermostat
Thermostat**
MINI

0.55	Daihatsu-EB	0.55	1987.01 - 1991.12		3119.82
0.65		0.65	1984.01 - 1987.12		3119.82
0.65		0.65	1990.01 - 1995.01		3119.82
1.0		1.0	1974.05 - 1982.02		3044.80
1.0	BLM C 99 H	1.0	1974.05 - 1982.02		3044.80
1.0	BLM C 99 H	1.0	1985.10 - 1991.10		3044.80
1.3	BLM C 12 H	1.3	1976.08 - 1982.02		3044.80
1.3 De Tomaso	BLM C 12 HH	1.3	1976.08 - 1982.02		3044.80

IVECO

	Motor Engine Moteur	Ltr. Ltr. Ltr.	Jahr Year Année	Einschränkung Restriction* Restriction*	Thermostat Thermostat Thermostat
DAILY I					
30- 8	8140.61.200	2.5	1978.01 - 1989.12		4151.79D
35- 8	8140.61.200	2.5	1978.01 - 1989.12		4151.79D
35-10	8140.21.200	2.5	1985.01 - 1989.12	Motor no. 976562 →	4151.79D
40- 8	8140.61.200	2.5	1983.01 - 1989.06		4151.79D
40-10	8140.27 S	2.5	1985.01 - 1989.12		4174.79D
45-10	8140.21.200	2.5	1985.01 - 1989.12	Motor no. 976562 →	4151.79D
49-10	8140.21.200	2.5	1985.01 - 1989.12	Motor no. 976562 →	4151.79D
DAILY II					
30- 8	8140.07, 8140.63, 8140.67	2.5	1989.01 - 1998.08		4174.79D
30-10	8140.23.	2.8	1997.01 - 1999.05		4174.79D
35- 8	8140.07, 8140.63, 8140.67	2.5	1989.01 - 1998.08		4174.79D
35-10	8140.23, 8140.47, 8140.47, 8140.97	2.8	1989.01 - 1998.08		4174.79D
35-12	8140.43, 8140.47	2.8	1990.01 - 1999.05		4174.79D
40-10	8140.23, 8140.27	2.8	1990.01 - 1999.05		4174.79D
40-12	8140.43, 8140.47.2700	2.5	1990.10 - 1996.04		4174.79D
45-10	8140.23, 8140.27.2720	2.5	1989.01 - 1999.05		4174.79D
45-12	8140.43, 8140.47	2.8	1990.06 - 1999.05		4174.79D
49-10	8140.23, 8140.27, 8140.47	2.8	1989.01 - 1999.05		4174.79D
49-12	8140.43, 8140.47	2.8	1990.06 - 1999.05		4174.79D
59-12	8140.43, 8140.47	2.8	1991.05 - 1999.05		4174.79D
DAILY III					
29 L 9	8140.43, 8140.63.	2.8	1999.05 - 2006.04	79° Variante	4174.79D
29 L 9	8140.43, 8140.63.	2.8	2001.11 - 2006.04	82° Variante	4174.82D
29 L 9	8140.43, 8140.63.	2.8	2001.11 - 2006.04	88° Variante	4174.88D ▲
29 L 10	F1AE0481A	2.3	2002.09 -		3171.82D
29 L 11	8140.43	2.8	1999.05 -	82° Variante	4174.82D
29 L 11	8140.43	2.8	1999.05 -	88° Variante	4174.88D ▲
29 L 12	F1AE0481B	2.3	2002.09 -		3171.82D
29 L 13	8140.43S	2.8	2001.05 -	88° Variante	4174.79D
29 L 13	8140.43S	2.8	2001.05 -	82° Variante	4174.82D
29 L 13	8140.43S	2.8	2001.05 -	88° Variante	4174.88D ▲
29 L 14	F1AE0481M	2.3	2005.01 - 2006.04		3171.82D
35 C 9, 35 S 9	8140.43, 8140.63	2.8	1999.05 - 2006.04	79° Variante	4174.79D
35 C 9, 35 S 9	8140.43, 8140.63	2.8	1999.05 - 2006.04	82° Variante	4174.82D
35 C 9, 35 S 9	8140.43, 8140.63	2.8	1999.05 - 2006.04	88° Variante	4174.88D ▲
35 C 10, 35 S 10	F1AE0481A	2.3	2002.09 -		3171.82D
35 C 11, 35 S 11	8140.43C	2.8	1999.05 -	82° Variante	4174.82D
35 C 11, 35 S 11	8140.43C	2.8	1999.05 -	88° Variante	4174.88D ▲
35 C 12, 35 S 12	F1AE0481B	2.3	2002.09 -		3171.82D
35 C 13, 35 S 13	8140.43S	2.8	1999.05 -	79° Variante	4174.79D
35 C 13, 35 S 13	8140.43S	2.8	1999.05 -	82° Variante	4174.82D
35 C 13, 35 S 13	8140.43S	2.8	1999.05 -	88° Variante	4174.88D ▲
35 C 14	F1CE0481A	3.0	2004.09 - 2006.04		3169.79D
35 C 14, 35 S 14	F1AE0481M	2.3	2005.01 - 2006.04		3171.82D
35 C 15	8140.43N	2.8	2001.11 -	82° Variante	4174.82D
35 C 15	8140.43N	2.8	2001.11 -	88° Variante	4174.88D ▲
35 C 15, 35 S 15	8140.43N	2.8	2002.11 -	82° Variante	4174.82D
35 C 15, 35 S 15	8140.43N	2.8	2002.11 -	88° Variante	4174.88D ▲
35 C 17, 35 S 17	F1CE0481B	3.0	2005.01 - 2006.04		3169.79D
35 S 10	F1AE0481A	2.3	2002.09 -		3171.82D
40 C 13	8140.43S	2.8	1999.05 - 2006.04	82° Variante	4174.82D
40 C 13	8140.43S	2.8	1999.05 - 2006.04	88° Variante	4174.88D ▲

IVECO
**Motor
Engine
Moteur**
**Ltr.
Ltr.
Ltr.**
**Jahr
Year
Année**
**Einschränkung
Restriction*
Restriction***
**Thermostat
Thermostat
Thermostat**

40 C 14	F1CE0481A	3.0	2004.09 - 2006.04		3169.79D
40 C 14	F1AE0481M	2.3	2005.01 - 2006.04		3171.82D
40 C 15	8140.43N	2.8	2001.11 - 2006.04	82° Variante	4174.82D
40 C 15	8140.43N	2.8	2001.11 - 2006.04	88° Variante	4174.88D ▲
40 C 17, 40 S 17	F1CE0481B	3.0	2005.01 - 2006.04		3169.79D
50 C 11	8140.43C	2.8	1999.05 -	82° Variante	4174.82D
50 C 11	8140.43C	2.8	1999.05 -	88° Variante	4174.88D ▲
50 C 13	8140.43S	2.8	1999.05 -	79° Variante	4174.79D
50 C 13	8140.43S	2.8	1999.05 -	82° Variante	4174.82D
50 C 13	8140.43S	2.8	1999.05 -	88° Variante	4174.88D ▲
50 C 14	F1CE0481A	3.0	2004.09 - 2006.04		3169.79D
50 C 15	8140.43N	2.8	2001.01 - 2006.04	82° Variante	4174.82D
50 C 15	8140.43N	2.8	2001.01 - 2006.04	88° Variante	4174.88D ▲
50 C 17	F1CE0481B	3.0	2004.09 - 2006.04		3169.79D
65 C 14	F1C	3.0	2004.09 - 2006.04		3169.79D
65 C 14	F1A	3.0	2004.09 - 2006.04		3171.82D
65 C 15	8140.43N	2.8	2001.11 - 2006.04	82° Variante	4174.82D
65 C 15	8140.43N	2.8	2001.11 - 2006.04	88° Variante	4174.88D ▲
65 C 17	F1CE0481B	3.0	2004.09 - 2006.04		3169.79D

DAILY IV

29 L 10	F1AE0481FA	2.3	2006.05 -		410937.82D ▲
29 L 12	F1AE0481GA	2.3	2006.05 -		410937.82D ▲
29 L 14	F1AE0481HA	2.3	2006.05 -		410937.82D ▲
35 C 10, 35 S 10	F1AE0481FA	2.3	2006.05 -		410937.82D ▲
35 C 11, 35 S 11	F1AE0481FA	2.3	2007.07 -		410937.82D ▲
35 C 12, 35 S 12	F1AE0481GA	2.3	2006.05 -		410937.82D ▲
35 C 13, 35 S 13	F1AE0481GA	2.3	2007.07 -		410937.82D ▲
35 C 14, 35 S 14	F1AE0481HA	2.3	2006.05 -		410937.82D ▲
35 C 15	F1CE0481FA	3.0	2006.05 -		410081.79D
35 C 18, 35 S 18	F1CE0481HA	3.0	2006.05 -		410081.79D
40 C 10	F1AE0481FA	2.3	2006.05 -		410937.82D ▲
40 C 11	F1AE0481FA	2.3	2007.07 -		410937.82D ▲
40 C 12	F1AE0481GA	2.3	2006.05 -		410937.82D ▲
40 C 13	F1AE0481GA	2.3	2007.07 -		410937.82D ▲
40 C 15	F1CE0481FA	3.0	2006.05 -		410081.79D
40 C 18	F1CE0481HA	3.0	2006.05 -		410081.79D
45 C 15	F1CE0481FA	3.0	2006.05 -		410081.79D
45 C 18	F1CE0481HA	3.0	2006.05 -		410081.79D
50 C 15	F1CE0481FA	3.0	2006.05 -		410081.79D
50 C 18	F1CE0481HA	3.0	2006.05 -		410081.79D
60 C 15	F1CE0481FA	3.0	2006.05 -		410081.79D
60 C 18	F1CE0481HC	3.0	2006.05 -		410081.79D
65 C 15	F1CE0481FA	3.0	2006.05 -		410081.79D
65 C 18	F1CE0481HC	3.0	2006.05 -		410081.79D

MASSIF

3.0 HPI	F1CE0481FA	3.0	2008.10 -		3169.79D
3.0 HPT	F1CE0481HA	3.0	2008.10 -		3169.79D

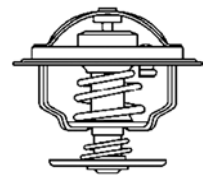

JEEP

	Motor Engine Moteur	Ltr. Ltr. Ltr.	Jahr Year Année	Einschränkung Restriction* Restriction*	Thermostat Thermostat Thermostat
CHEROKEE (XJ)					
2.1 D	J8S 742	2.0	1986.10 - 1992.09		4147.80D
2.1 TD	J8S	2.0	1984.10 - 2001.09		4147.80D
2.5	EPE	2.5	1995.10 - 2001.09		4158.80D
2.5 i	EPE, HX	2.5	1991.12 - 2001.09		3000.83
2.5 TD	ENC	2.5	1988.01 - 2001.09		4158.80D
4.0 i	ERH, MX	4.0	1988.01 - 2001.09		3000.83
CJ5 - CJ8					
2.1 D	J8S-800	2.0	1983.01 - 1987.12		4147.80D
COMMANDER (XK)					
3.0 CRD	EXL	3.0	2006.04 - 2010.12		4630.87D ▲
GRAND CHEROKEE I (Z)					
2.5 TD	M51, M52	2.5	1995.10 - 1999.04		4158.80D
4.0 i (Z)	S01	4.0	1995.10 - 1999.04		3000.83
4.0 i (ZJ)	MX	4.0	1991.09 - 1999.04		3000.83
4.0 i (ZJ)	ERH	4.0	1991.09 - 1999.04		3000.83
5.2 (Z)	Y01	5.2	1995.10 - 1999.04		3000.90
5.2 i (ZJ)	Y	5.2	1992.09 - 1999.04		3000.90
5.2 i (ZJ)	ELF	5.2	1992.01 - 1999.04		3000.90
5.9 i		5.9	1997.08 - 1999.04		3000.90
GRAND CHEROKEE II (WJ, WG)					
3.1 TD	EXA	3.1	1999.04 - 2001.12		4158.80D
GRAND CHEROKEE III (WH, WK)					
3.0 CRD	EXL	3.0	2005.06 - 2010.12		4630.87D ▲
WRANGLER I (YJ, SJ_)					
2.5	EPE	2.5	1988.01 - 1996.08		3000.83
4.0	ERH	4.0	1991.12 - 1996.08		3000.83
WRANGLER II (TJ)					
2.5	P00	2.5	1996.08 - 2007.04		3000.83
4.0	S01	4.0	1996.08 - 2007.04		3000.83

KIA
**Motor
Engine
Moteur**
**Ltr.
Ltr.
Ltr.**
**Jahr
Year
Année**
**Einschränkung
Restriction*
Restriction***
**Thermostat
Thermostat
Thermostat**
BESTA

2.2 D	R2	2.2	1996.02 -		3498.88D
-------	----	-----	-----------	--	----------

CARENS I (FC)

1.8 i	T8	1.8	2000.11 - 2002.07		410352.88D
-------	----	-----	-------------------	--	------------

CARENS II (FJ)

1.6	GA6D	1.6	2002.07 -		410352.88D
-----	------	-----	-----------	--	------------

1.8		1.8	2002.07 -		410352.88D
-----	--	-----	-----------	--	------------

CLARUS (K9A, GC)

1.8 i 16V	T8	1.8	1996.07 -		410352.88D
-----------	----	-----	-----------	--	------------

2.0 i 16V	FE (16V)	2.0	1996.07 -		3498.88D
-----------	----------	-----	-----------	--	----------

PRIDE

1.1 i	B1	1.1	1991.01 -		410352.82D
-------	----	-----	-----------	--	------------

1.3		1.3	1999.08 -		410352.82D
-----	--	-----	-----------	--	------------

1.3 16V	B3	1.3	1990.01 -		410352.82D
---------	----	-----	-----------	--	------------

1.3 i		1.3	1990.01 -		410352.82D
-------	--	-----	-----------	--	------------

RETONA (CE)

2.0 16V	FE (16V)	2.0	2000.05 -		3498.88D
---------	----------	-----	-----------	--	----------

2.0 TD	RF	2.0	1999.06 -		3468.88D
--------	----	-----	-----------	--	----------

RIO (DC_)

1.3		1.3	2000.08 - 2005.02		410352.88D
-----	--	-----	-------------------	--	------------

SEPHIA (FA)

1.5 i	B5	1.5	1996.02 - 1997.10		410352.82D
-------	----	-----	-------------------	--	------------

1.6 i	B6	1.6	1993.09 - 1997.10		410352.82D
-------	----	-----	-------------------	--	------------

1.8 i 16V	OK24N, OK26Y	1.8	1995.01 - 1997.10	82° Variante	410352.82D
-----------	--------------	-----	-------------------	--------------	------------

1.8 i 16V	OK24N, OK26Y	1.8	1995.01 - 1997.10	88° Variante	410352.88D
-----------	--------------	-----	-------------------	--------------	------------

SHUMA (FB)

1.5	OK280	1.5	1996.03 - 1998.12		410352.88D
-----	-------	-----	-------------------	--	------------

1.5 i 16V		1.5	1997.10 - 2001.10		410352.88D
-----------	--	-----	-------------------	--	------------

1.6	GA6D	1.6	2001.05 - 2004.08		410352.88D
-----	------	-----	-------------------	--	------------

1.8	T8	1.8	2003.04 - 2004.08		410352.88D
-----	----	-----	-------------------	--	------------

1.8 i 16V	T8	1.8	1997.10 - 2001.03		410352.88D
-----------	----	-----	-------------------	--	------------

SPORTAGE (K00)

2.0		2.0	2000.10 - 2003.08		3498.88D
-----	--	-----	-------------------	--	----------

2.0 i	FE (8V)	2.0	1994.04 - 1999.08		3498.88D
-------	---------	-----	-------------------	--	----------

2.0 i 16V	FE (16V)	2.0	1994.04 - 2003.08		3498.88D
-----------	----------	-----	-------------------	--	----------

2.0 TD	RF	2.0	1997.10 - 2003.08		3468.88D
--------	----	-----	-------------------	--	----------

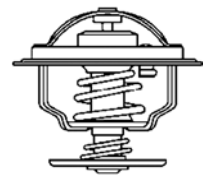

LADA

	Motor Engine Moteur	Ltr. Ltr. Ltr.	Jahr Year Année	Einschränkung Restriction* Restriction*	Thermostat Thermostat Thermostat
NIVA (2121)					
1900 Diesel	XUD9A	1.9	1993.01 -		4446.83D
1900 Diesel	XUD9SD	1.9	1999.01 -		4446.83D
NOVA					
1500	BA3 21083	1.5	1989.06 -		3333.87
SAMARA (2108, 2109)					
1100	BA3 21081	1.1	1988.02 - 1994.12		3333.87
1100	BA3 21081 (KAT)	1.1	1996.02 -		3333.87
1300	BA3 2108	1.3	1986.01 - 1994.12		3333.87
1300	BA3 2108 (KAT)	1.3	1991.09 -		3333.87
1300	BA3 21115	1.3	1996.02 -		3333.87
1500	BA3 21083	1.5	1988.01 -		3333.87
1500	BA3 21083 (KAT)	1.5	1991.09 -		3333.87
1500	BA3 2111	1.5	1995.02 -		3333.87
SAMARA FORMA					
1100	BA3 21081 (KAT)	1.1	1991.07 -		3333.87
1300	BA3 2108	1.3	1989.05 - 1997.07		3333.87
1300	BA3 21115	1.3	1996.02 -		3333.87
1500	BA3 21083 (KAT)	1.5	1991.07 -		3333.87
1500	BA3 21083	1.5	1991.09 -		3333.87
1500	BA3 2111	1.5	1994.11 -		3333.87

LANCIA

	Motor Engine Moteur	Ltr. Ltr. Ltr.	Jahr Year Année	Einschränkung Restriction* Restriction*	Thermostat Thermostat Thermostat
DEDRA (835)					
1.6 16V	182 A4.000	1.6	1996.01 - 1999.07		3163.88D
1.6 i.e.	835 A1.046, 835 C1.000	1.6	1989.08 - 1999.07		3109.82D
1.6 i.e.	835 A1.000	1.6	1989.08 - 1994.06		3109.87D
1.8 i.e.	836 A5.000	1.8	1994.07 - 1999.07		3159.82D
2.0 HF Integrale	835 A7.046	2.0	1990.11 - 1993.07	Motor no. →1517343	3159.82D
2.0 i.e.	835 A5.046	2.0	1989.09 - 1993.09		3159.82D
2.0 i.e.	835 A5.046	2.0	1993.09 - 1999.07		410956.83D
2.0 i.e. Turbo	835 A7.000, 835 A8.046	2.0	1991.04 - 1993.07	Motor no. →1518014	3159.82D
2.0 Turbo	835 A8.000	2.0	1990.11 - 1993.07	Motor no. →1517343	3159.82D
DELTA I (831AB0)					
1.6 GT i.e.	149 C2.000, 831 B7.000	1.6	1986.08 - 1988.08		4022.82D1
1.6 HF Turbo	831 B3.000, 831 B7.046	1.6	1986.08 - 1989.03		3159.82D
1.9 Turbo DS	831 D1.000	1.9	1986.10 - 1989.12		3431.80D
2.0 HF Integrale	831 B5.000, 831 C5.000, 831 C5.046	2.0	1986.11 - 1992.12		3159.82D
DELTA II (836)					
1.4 i.e.	836 A4.000, 160 A1.046	1.4	1994.10 - 1999.08		3109.87D
1.6 i.e.	835 C1.000	1.6	1993.06 - 1999.08		3109.87D
1.6 i.e.	182 A6.000	1.6	1996.03 - 1999.08	Motor no. 010785→	3163.88D
1.6 i.e. 16V	182 A4.000	1.6	1996.01 - 1999.08	Motor no. 010785→	3163.88D
1.8 i.e.	835 C2.000, 835 C4.000, 836 C4.000, 836 A6.000	1.8	1993.06 - 1999.08		3159.82D
1.9 TD	835 A4.000, 160 D1.000	1.9	1994.10 - 1999.08	Ölkühlung	410692.71D
DELTA III (844)					
1.4	198 A4.000	1.4	2008.09 -		410871.80D ▲
1.4 16V	198 A7.000	1.4	2010.07 -		410871.80D ▲
1.4 Bifuel	198 A4.000	1.4	2011.07 -		410871.80D ▲
KAPPA (838)					
2.0 20V	838 A1.000, 838 A6.000	2.0	1994.10 - 2001.10		410513.88D
2.4 20V	838 A2.000, 838 A2.027	2.4	1994.08 - 2001.10		410513.88D
LYBRA (839)					
1.6	182 B6.000	1.6	2000.10 - 2005.10		3163.88D
1.6 16V	182 A4.000	1.6	1999.07 - 2005.10		3163.88D
1.8 16V	839 A7.000, 839 A4.000	1.8	1999.07 - 2005.10		410514.88D
1.8 16V	839 A7.000, 839 A9.000, 839 A4.000	1.8	1999.07 - 2005.10		410514.88D
1.9 JTD	AR 32302	1.9	1999.07 - 2000.09		410512.88D
2.0 20V	182 B7.000	2.0	1999.07 - 2000.09		410513.88D
2.0 20V	185 A8.000	2.0	2000.09 - 2005.10		410994.88D
2.4 JTD	AR 32501, 839 A5.000	2.4	1999.07 - 2001.02		410512.88D
MUSA					
1.3 D Multijet	199 A3.000	1.2	2006.09 -		410048.88D
1.3 D Multijet	199 B1.000	1.2	2009.03 -		411774.88D ▲
1.4	843 A 1.000	1.4	2004.10 -		3151.87D
1.4	350 A1.000	1.4	2005.09 -		410090.88D
1.4 LPG	350 A1.000	1.4	2010.11 -		410090.88D

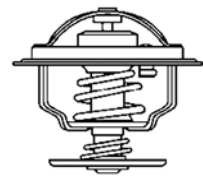

LANCIA

	Motor Engine Moteur	Ltr. Ltr. Ltr.	Jahr Year Année	Einschränkung Restriction* Restriction*	Thermostat Thermostat Thermostat
PHEDRA (179)					
2.0	RFN (EW10J4)	2.0	2002.09 - 2010.11		3483.89D
2.0 JTD	RHK (DW10UTED4), RHM (DW10ATED4), RHW (DW10ATED4)	2.0	2002.09 - 2010.11		4446.83D
2.2 JTD	4HW(DW12ATED4)	2.2	2002.09 - 2010.11		4446.83D
PRISMA (831AB0)					
2.0 i.e.	831 B4.000	2.0	1986.04 - 1989.12		4022.82D1
THEMA (834)					
2000 i.e. (834B)	834 B.000	2.0	1984.11 - 1988.09		4022.82D1
2500 Turbo D (834D)	8144.91	2.5	1984.11 - 1988.09		4151.79D
2500 Turbo DS (834AE), (834D)	8144.97	2.5	1987.03 - 1988.09		4151.79D
2500 Turbo DS (834AE), (834D)	8144.97	2.5	1988.10 - 1992.05		3103.79
2500 Turbo DS (834AM)	8144. 97S	2.5	1988.05 - 1992.07		3103.79
2500 Turbo DS (834FE, 834LE)	8144.97 Y	2.5	1992.05 - 1994.07		3116.82D
2850 V6 i.e. (834AD, 834CD, 834BD)	834 E.146	2.85	1988.06 - 1992.05		4122.87D
2850 V6 i.e. (834F)	834 E.000	2.85	1984.11 - 1988.09		4122.87D
THEESIS (841AX)					
2.0 Turbo	841 E.000	2.0	2002.07 - 2009.07		410994.88D
2.4	841 D.000	2.4	2002.07 - 2009.07		410994.88D
2.4 JTD	841 C.000	2.4	2002.07 - 2009.07		410511.88D
2.4 JTD	841 G.000, 841 N.000, 841 M.000	2.4	2003.05 - 2009.07		411773.88D ▲
Y (840A)					
1.1	176 B2.000	1.1	1995.11 - 2003.09		3105.87D
1.2	840 A3.000, 188 A4.000	1.2	1996.03 - 2003.09		3105.87D
1.2 16V	176 B9.000	1.2	1997.04 - 2003.09		3105.87D
1.2 16V	188 A5.000	1.2	2000.10 - 2003.09		3151.87D
1.4 12V	840 A4.000	1.4	1996.03 - 2003.09		410515.88D
1.4 12V	840 A2.000	1.4	1996.10 - 2003.09		410515.88D
Y10 (156)					
1.0 Fire	156 A2.000, 156 A2.100, 156 A2.246	1.0	1985.03 - 1992.02		3105.87D
1.0 Fire	156 A.000	1.0	1985.03 - 1989.07		4091.82D
1.0 Turbo	156 A1.000	1.0	1985.03 - 1989.02		4091.82D
1.1 Avenue	176 B2.000	1.1	1995.01 - 1995.12		3105.87D
1.1 i.e.	156 C.000	1.1	1989.08 - 1992.06		3105.87D
1.1 i.e. Fire	156 C.046	1.1	1989.07 - 1995.12		3105.87D
1.3 i.e. Fire	156 B.000, 146 A 5.046	1.3	1987.11 - 1995.12	Motor no. →3143798	3378.80
1.3 i.e. Fire	156 B.000, 146 A 5.046	1.3	1987.12 - 1995.12	Motor no. 3143798 →	3373.80D
YPSILON					
1.2	188 A4.000	1.2	2003.10 - 2011.12		3105.87D
1.2	188 A5.000	1.2	2003.10 - 2011.12		3151.87D
1.3 D Multijet	199 A2.000, 199 A3.000	1.2	2006.09 - 2011.12		410048.88D
1.3 JTD	188 A9.000	1.25	2003.10 - 2011.12		410048.88D
1.4	350 A1.000	1.4	2006.02 - 2011.12		410090.88D
1.4 16V	843 A 1.000	1.4	2003.10 - 2011.12		3151.87D
1.4 LPG	350 A1.000	1.4	2010.11 - 2011.12		410090.88D

LANCIA
**Motor
Engine
Moteur**
**Ltr.
Ltr.
Ltr.**
**Jahr
Year
Année**
**Einschränkung
Restriction*
Restriction***
**Thermostat
Thermostat
Thermostat**
ZETA (220)

2.0 16V	RFV (XU10J4R)	2.0	1998.05 - 2000.07		4450.83D
2.0 16V	RFN	2.0	2000.07 - 2002.09		3463.89D
2.0 JTD	RHW (DW10ATED4), RHZ (DW10A-TED)	2.0	1999.09 - 2002.09		4446.83D
2.0 Turbo	RGX (XU10J2TE)	2.0	1995.05 - 2002.09		3136.82D50
2.1 TD	P 8 C	2.1	1996.05 - 1999.09		4446.83D



LANDROVER

	Motor Engine Moteur	Ltr. Ltr. Ltr.	Jahr Year Année	Einschränkung Restriction* Restriction*	Thermostat Thermostat Thermostat
88/109					
2.3 4x4 (LR 88 OL, LR 109 OL)	11H	2.3	1963.09 - 1986.12		3004.82
2.3 4x4 (LR 88 OP, LR 109 OP)	11H	2.3	1963.09 - 1986.12		3004.82
2.3 D 4x4 (LR 88 DL, LR 109 DL)	23 J, 10 J	2.3	1963.09 - 1986.12		3004.82
2.3 D 4x4 (LR 88 DP, LR 109 DP)	23 J, 10 J	2.3	1963.09 - 1986.12		3004.82
DEFENDER (LD)					
2.5 90, 110 TDI	16 L, 23 L, 11 L	2.5	1990.09 - 1986.12		3004.82
DISCOVERY I (LJ, LG)					
2.5 TDI	19 L, 21 L, 17 L, 12 L	2.5	1989.10 - 1998.10		3004.82

LEXUS
**Motor
Engine
Moteur**
**Ltr.
Ltr.
Ltr.**
**Jahr
Year
Année**
**Einschränkung
Restriction*
Restriction***
**Thermostat
Thermostat
Thermostat**
ES (F1, F2)

300 3VZ-FE 3.0 1991.09 - 1997.12 4480.82D

ES (GSV4_, ACV4_)

3.5 GR-FE 3.5 2006.05 - 2012.06 4480.82D

ES (MCV_, VZV_)

3.0 1MZ-FE 3.0 1996.10 - 2001.07 4480.82D

GS (JZS147)

300 2JZ-GE 3.0 1993.03 - 1997.08 410231.82D

GS (UZS161, JZS160)

300 2JZ-GE 3.0 2000.10 - 2005.03 410231.82D

300 T3 2JZ-GE 3.0 1997.08 - 2000.10 410231.82D

400 1UZ-FE 4.0 1997.12 - 2000.11 4480.82D

IS I (JCE1_, GXE1_)

200 1G-FE 2.0 1999.04 - 2005.07 411545.82D ▲

300 2JZ-GE 3.0 2001.09 - 2005.07 410231.82D

IS II (GSE2_, ALE2_, USE2_)

200d 2AD-FTV 2.2 2010.07 - 4480.82D

220d 2AD-FHV 2.2 2005.10 - 4480.82D

IS SportCross

200 1G-FE 2.0 2002.10 - 2005.10 411545.82D ▲

300 2JZ-GE 3.0 2001.10 - 2005.10 410231.82D

LS (UCF10)

400 1UZ-FE 4.0 1989.12 - 1994.12 4480.82D

LS (UCF20)

400 1UZ-FE 4.0 1994.12 - 2000.10 4480.82D

RX (MHU3_, GSU3_, MCU3_)

3.3 3MZ-FE 3.3 2003.04 - 2008.12 4480.82D

300 1MZ-FE 3.0 2003.05 - 2008.12 4480.82D

350 2GR-FE 3.5 2006.02 - 2008.12 4480.82D

400h 3MZ-FE 3.3 2004.09 - 2008.12 4480.82D

RX (MCU15)

300 1MZ-FE 3.0 2000.07 - 2003.05 4480.82D

RX (GYL1_, GGL15, AGL10)

270 1AR-FE 2.7 2008.12 - 4480.82D

350 2GR-FE 3.5 2008.12 - 4480.82D

350h 2GR-FXE 3.5 2012.04 - 4480.82D

450h 2GR-FXE 3.5 2008.12 - 4480.82D

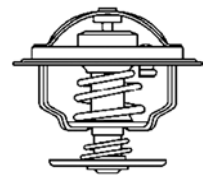
**LIGIER**

	Motor Engine Moteur	Ltr. Ltr. Ltr.	Jahr Year Année	Einschränkung Restriction* Restriction*	Thermostat Thermostat Thermostat
AMBRA					
0.5		0.5	1996.12 -		4007.80D
BE UP					
0.5		0.5	2002.08 -		4007.80D
NOVA					
500		0.5	2002.08 -	Lombardini	4007.80D
650		0.5	2002.08 -	Lombardini	4007.80D

MAZDA
**Motor
Engine
Moteur**
**Ltr.
Ltr.
Ltr.**
**Jahr
Year
Année**
**Einschränkung
Restriction*
Restriction***
**Thermostat
Thermostat
Thermostat**
2

1.25	FUJA	1.25	2003.04 -		4483.82D
1.3	ZJ-VE	1.3	2007.10 -		4639.82D
1.4	FXJA	1.4	2003.02 -		4483.82D
1.5	ZY-DE, ZY-VE	1.5	2003.04 -		4639.82D
1.6	FYJA	1.6	2003.02 -		4483.82D

3

1.6	Z6	1.6	2004.02 -		4639.82D
2.0	LF17	2.0	2004.02 - 2006.06		4639.82D
2.3	L3-VE	2.3	2004.03 - 2009.03		4639.82D
1.4	FXJA, ZJ-VE	1.4	2003.10 - 2009.06		4639.82D
1.6	B6ZE	1.6	2003.10 - 2009.06		4639.82D
2.0	LF17	2.0	2003.10 - 2009.06		4639.82D
2.3	L3-VE	2.3	2004.03 - 2009.03		4639.82D

5 (CR19)

2.0 CD	RF7J	2.0	2005.06 -		4639.82D
--------	------	-----	-----------	--	----------

6 (GG, GY)

2.0 DI	RF5C	2.0	2002.06 - 2007.08		4639.82D
--------	------	-----	-------------------	--	----------

121 I (DA)

1.1	B1, B116	1.1	1987.10 - 1990.10		3119.82D3
1.3	B3	1.3	1987.10 - 1990.11		3119.82D3

121 II (DB)

1.3 16V	B3 (16V)	1.3	1990.11 - 1996.03		3119.82D3
1.3 i 16V	B3 (16V)	1.3	1990.11 - 1996.03		3119.82D3

121 III (JASM, JBSM)

1.25	DHG, DHF	1.25	1996.03 - 2003.04	Motor no. →001201	4457.82D
1.25	DHG, DHF	1.25	1996.04 - 2003.04	Motor no. 001201→	4483.82D
1.3	J4R, J4T, JJM, JJK	1.3	1996.03 - 2003.04		3004.92D1
1.8 D	RTJ, RTK	1.8	1996.03 - 2003.04		4270.88D

323 I (FA)

1.0	P, PC	1.0	1977.06 - 1980.05		3119.82D3
1.3	T, TC	1.3	1977.01 - 1980.05		3119.82D3
1.4	U, UC	1.4	1978.05 - 1980.05		3119.82D3
1.5	D5	1.5	1982.04 - 1986.05		3119.82D3

323 II (BD)

1.1	E1	1.1	1980.11 - 1985.10		3119.82D3
1.3	E3	1.3	1980.11 - 1989.10		3119.82D3
1.5	E5	1.5	1980.11 - 1986.09		3119.82D3

323 III (BF, BW)

1.1	E1	1.1	1985.08 - 1990.04		3119.82D3
1.3	E3	1.3	1985.08 - 1990.04		3119.82D3
1.3 i	B3E	1.3	1985.09 - 1989.08		3119.82D3
1.4	B3	1.4	1987.04 - 1989.10		3119.82D3

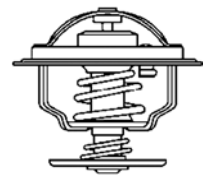

MAZDA

	Motor Engine Moteur	Ltr. Ltr. Ltr.	Jahr Year Année	Einschränkung Restriction* Restriction*	Thermostat Thermostat Thermostat
1.5	B5, B50, B53, E5	1.5	1985.08 - 1989.10		3119.82D3
1.5 i	E5E3	1.5	1985.08 - 1989.05		3119.82D3
1.5 i Turbo	E5E2	1.5	1985.08 - 1989.05		3119.82D3
1.6	B6 (SOHC), B65M, B6E, B68	1.6	1986.09 - 1995.10		3119.82D3
1.6 GT	B6 (SOHC)	1.6	1985.08 - 1989.10		3119.82D3
1.6 GT Turbo	B6T	1.6	1985.10 - 1993.08		3119.82D3
323 IV (BG)					
1.3	B3E, B383	1.3	1989.09 - 1994.07		3499.82D
1.3 16V	B3 (16V)	1.3	1989.09 - 1994.07		3499.82D
1.6	B6E	1.6	1989.09 - 1991.06		3499.82D
1.6 16V	B6	1.6	1989.08 - 1994.10		3499.82D
1.8	BPC	1.8	1991.01 - 1994.04		3499.82D
1.8 16V	BP52	1.8	1989.08 - 1994.07		3499.82D
1.8 16V	BP	1.8	1989.08 - 1994.07		3499.82D
1.8 16V GT	BP (DOHC)	1.8	1989.06 - 1994.07		3499.82D
1.8 16V Turbo	BP Turbo	1.8	1990.09 - 1994.07		3498.88D
323 V (BA)					
1.3 16V	B3 (16V)	1.3	1994.08 - 1995.08		3499.82D
1.3 16V	B3 (16V)	1.3	1995.08 - 1998.09		3498.88D
1.5 16V	Z5-DE	1.5	1994.07 - 1995.08		3499.82D
1.5 16V	Z5-DE	1.5	1995.08 - 1998.09		3498.88D
1.8 16V	BP-ZE	1.8	1994.08 - 1998.09		3498.88D
2.0 24V	KF	2.0	1994.08 - 1998.09		4639.82D
2.0 D	RF1G	2.0	1996.10 - 1998.09		4639.82D
323 VI (BJ)					
1.4	B3 (16V)	1.4	2001.01 - 2004.05		3498.88D
1.4 16V	B3 ME	1.4	1998.09 - 2001.01		3498.88D
1.5 16V	ZL06, ZL05	1.5	1998.09 - 2001.01		3498.88D
1.6	ZM	1.6	2001.01 - 2004.05		3498.88D
1.9 16V	FP55	1.9	1998.09 - 2004.05		4639.82D
2.0	FS	2.0	2000.02 - 2004.05		4639.82D
2.0 D	RF1G	2.0	1998.09 - 2004.05		4639.82D
2.0 DiTD	RF4F	2.0	2000.10 - 2002.10		4639.82D
2.0 TD	RF3F, RF4F	2.0	1998.09 - 2004.05		4639.82D
626 I (CB)					
1.6	H6, NA, N	1.6	1979.05 - 1982.05		3119.88D3
2.0	HE3, MA, M	2.0	1979.05 - 1982.05		3119.88D3
626 II (GC)					
1.6	F6	1.6	1982.11 - 1987.09		3119.88D3
2.0	FE (8V)	2.0	1983.03 - 1987.09		3119.88D3
626 III (GD, GV)	1.6 F6	1.6	1987.06 - 1992.05		3119.88D3
1.8	F8 (12V)	1.8	1987.09 - 1992.05		3119.88D3
2.0	FE (8V)	2.0	1987.09 - 1987.09	OHC	3119.88D3
2.0	FE (12V)	2.0	1987.09 - 1990.10	OHC	3119.88D3
2.0 12V	FE (12V)	2.0	1987.09 - 1992.05	OHC	3119.88D3
2.0 16V	FE (16V)	2.0	1987.06 - 1992.05		3119.88D3
2.0 D	RFG5	2.0	1994.11 - 1997.09		3468.88D
2.0 D Complex	RF-CX	2.0	1993.05 - 1996.11		3468.88D
2.2 12V	F2L1, F2	2.2	1987.11 - 1996.11		3498.88D

MAZDA
**Motor
Engine
Moteur**
**Ltr.
Ltr.
Ltr.**
**Jahr
Year
Année**
**Einschränkung
Restriction*
Restriction***
**Thermostat
Thermostat
Thermostat**
626 IV (GE)

1.8	FP	1.8	1991.08 - 1997.04		4639.82D
1.8 i	FP	1.8	1992.01 - 1997.04		4639.82D
2.0 D Comprex	RF OHC	2.0	1992.10 - 1997.04		3468.88D
2.0 i	FS	2.0	1991.08 - 1997.04		4639.82D
2.5 24V	KL	2.5	1992.01 - 1997.04		4639.82D

626 V (GF, GW)

1.8	FPY3	1.8	1997.05 - 1999.12		4639.82D
1.9	FP	1.9	1997.05 - 2000.01		4639.82D
2.0	FS	2.0	1997.05 - 2002.10		4639.82D
2.0 H.P.	FS2C	2.0	1998.02 - 2002.10		4639.82D
2.0 TD		2.0	2000.10 - 2002.10		4639.82D
2.0 Turbo DI	RF4F	2.0	1998.04 - 2002.10		4639.82D

929 II (HB, HV)

2.0	HEE, MA	2.0	1982.05 - 1987.12		3119.88D3
2.0	FE (8V)	2.0	1984.03 - 1987.07		3119.88D3
2.0 i	FE (8V)	2.0	1984.10 - 1987.07		3119.88D3
2.0 i Turbo	FET	2.0	1984.10 - 1987.07		3119.88D3

929 III (HC)

2.0	FEFA, FE (8V)	2.0	1987.06 - 1988.12		3119.88D3
2.2 12V	F21, F2E, F2	2.2	1988.01 - 1991.06		3119.88D3
2.2 i	F2-EGI	2.2	1987.05 - 1988.12		3119.88D3
3.0	JE	3.0	1987.06 - 1991.06		3119.88D3

B-SERIE (UF, UN)

2.0	FE (8V)	2.0	1985.01 - 1991.12		3499.88D
2.2	F2L8	2.2	1991.08 - 1996.12		3499.88D
2.2 D	R290	2.2	1985.01 - 1996.03		3468.88D
2.5 D		2.5	1996.02 - 1999.06		4639.82D
2.5 D	MD25NA, WLE7	2.5	1999.06 -		4639.82D
2.5 TD	MD25TI	2.5	1999.06 - 2006.07		4639.82D

BT-50 (CD, UN)

2.5	WLAA	2.5	2006.12 -		4639.82D
-----	------	-----	-----------	--	----------

DEMIO (DW)

1.3 16V	B3 ME	1.3	1998.08 -		3499.88D
1.3 i 16V	B3 (16V)	1.3	1998.08 - 2000.04		3499.88D
1.5 16V	B5 E	1.5	2000.04 -		3499.88D

E 1600, 2000

2200 D	R203, R207	2.2	1991.03 - 2003.05		3468.88D
E2000	FE18, FEV4	2.0	1984.11 - 2003.05		3499.88D
E2200 D	R2	2.2	1984.01 - 2003.05		3468.88D

MPV I (LV)

2.5 TD	WL-T	2.5	1996.05 - 1999.09		4639.82D
3.0 i V6	JE94	3.0	1995.03 - 1999.09		4639.82D

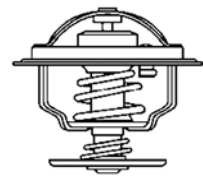

MAZDA

	Motor Engine Moteur	Ltr. Ltr. Ltr.	Jahr Year Année	Einschränkung Restriction* Restriction*	Thermostat Thermostat Thermostat
MPV II (LW)					
2.0	FS-DS	2.0	1999.09 - 2002.07		4639.82D
2.0 DI	RF5C	2.0	2002.07 - 2006.02		4639.82D
MX-3 (EC)					
1.6 i	B69, B6D	1.6	1991.07 -		3498.88D
1.8 i V6	K819, K838	1.8	1992.01 -		4639.82D
MX-5 I (NA)					
1.6	B64F	1.6	1990.05 -		3498.88D
1.8	BPF1, BP (DOHC)	1.8	1993.09 - 1998.04		3498.88D
MX-5 II (NB)					
1.6 16V	B6D	1.6	1998.05 - 2005.10		3498.88D
1.8	BPD	1.8	1998.01 - 2002.07		3498.88D
1.8 16V	BP-ZE, BPD	1.8	1998.05 - 2005.10		3498.88D
MX-6 (GE)					
2.0	FS	2.0	1992.02 - 1997.02		4639.82D
2.5 i 24V	KL	2.5	1994.08 - 1997.02		4639.82D
PREMACY (CP)					
1.9	FP	1.9	1999.07 - 2005.03		4639.82D
2.0	FS7G, FS7E, LFF7	2.0	2001.11 - 2005.03		4639.82D
2.0 TD	RF3F, RF4F	2.0	1999.10 - 2005.03		4639.82D
2.3 SVT		2.3	2005.02 - 2005.03		4639.82D
TRIBUTE (EP)					
2.0	YF	2.0	2000.03 - 2008.05		4270.88D
XEDOS 6					
1.6 16V	B6 (DOHC)	1.6	1994.06 - 1999.10		3498.88D
2.0 24V	KF	2.0	1993.08 - 2000.01		4639.82D
2.0 V6	KF1	2.0	1992.01 - 1999.10		4639.82D
2.3 24V	KJ -ZEM	2.3	1995.02 - 2000.01		4639.82D
2.5 24V	KL	2.5	1993.07 - 2000.07		4639.82D
2.5 V6	KL	2.5	2000.07 - 2002.09		4639.82D

MERCEDES-BENZ
**Motor
Engine
Moteur**
**Ltr.
Ltr.
Ltr.**
**Jahr
Year
Année**
**Einschränkung
Restriction*
Restriction***
**Thermostat
Thermostat
Thermostat**
114 Serie /8 (W114)

230.6	M 180.954	2.3	1968.01 - 1976.11		4078.79D
250	M 114.920	2.5	1968.01 - 1972.08		4078.79D
250 2.8	M 130.923	2.8	1972.06 - 1976.11		4078.79D
250 C	M 114.920	2.5	1969.04 - 1972.06		4078.79D
250 C 2.8	M 130.923	2.8	1972.06 - 1976.11		4078.79D
250 CE	M 114.980	2.5	1969.04 - 1972.04		4078.79D
280	M 110.921	2.7	1972.06 - 1976.11		4078.79D
280 C	M 110.921	2.7	1972.06 - 1977.02		4078.79D
280 CE	M 110.981	2.7	1972.06 - 1977.01		4078.79D
280 E	M 110.981	2.7	1972.06 - 1976.11		4078.79D

115 Serie /8 (W115)

200	M 115.923, M 115.926	2.0	1968.01 - 1977.01		4078.79D
200 D	OM 615.913	2.0	1968.01 - 1977.01		4049.80D1
220	M 115.920, M 115.924	2.2	1968.01 - 1973.07		4078.79D
220 D	OM 615.912	2.2	1968.01 - 1977.01		4049.80D1
230.4	M 115.951	2.3	1973.08 - 1976.12		4078.79D
240 D	OM 616.916	2.4	1973.08 - 1977.01		4117.80D
240 D 3.0	OM 617.910	3.0	1974.08 - 1976.11		4049.80D1

123 Serie

200	M 115.938 / M 115.939/M 102.920 / M 102.939	2.0	1976.02 - 1985.11		4078.87D
200 D	OM 615.940	2.0	1976.07 - 1985.11	Motor no. →142197 Schaltgetriebe	4117.80D
200 D	OM 615.940	2.0	1976.07 - 1985.11	Motor no. →004748 Automatikgetriebe	4117.80D
200 D	OM 615.940	2.0	1976.10 - 1985.11	Motor no. 142198→ Schaltgetriebe	4049.80D1
200 D	OM 615.940	2.0	1976.10 - 1985.11	Motor no. 004749→ Automatikgetriebe	4049.80D1
220 D	OM 615.941	2.0	1976.07 - 1985.11	Motor no. →004748 Automatikgetriebe	4117.80D
220 D	OM 615.941	2.0	1976.07 - 1985.11	Motor no. →142197 Schaltgetriebe	4117.80D
220 D	OM 615.941	2.0	1976.10 - 1985.11	Motor no. 004749→ Automatikgetriebe	4049.80D1
220 D	OM 615.941	2.0	1976.10 - 1985.11	Motor no. 142198→ Schaltgetriebe	4049.80D1
230	M 102.980 / M 115.954	2.3	1976.02 - 1985.12		4078.87D
240 D	OM 616.912	2.0	1976.02 - 1985.11	Motor no. →027798 Automatikgetriebe	4117.80D
240 D	OM 616.912	2.0	1976.02 - 1985.11	Motor no. →086378 Schaltgetriebe	4117.80D
240 D	OM 616.912	2.0	1976.10 - 1985.11	Motor no. 086379→ Schaltgetriebe	4049.80D1
240 D	OM 616.912	2.0	1976.10 - 1985.11	Motor no. 027799→ Automatikgetriebe	4049.80D1
250	M 123.921	2.5	1976.02 - 1985.07		4078.87D
280 E	M 110.923, M 110.984/M110.988	2.7	1976.02 - 1985.11		4078.87D
300 C Turbo-D	OM 617.952	3.0	1981.09 - 1985.07		4049.80D1
300 D	OM 617.912	2.0	1976.02 - 1985.11	Motor no. →067785 Automatikgetriebe	4117.80D
300 D	OM 617.912	2.0	1976.02 - 1985.11	Motor no. →073575 Schaltgetriebe	4117.80D
300 D	OM 617.912	2.0	1976.10 - 1985.11	Motor no. 067786→ Automatikgetriebe	4049.80D1

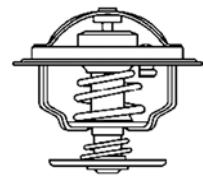
MERCEDES-BENZ

	Motor Engine Moteur	Ltr. Ltr. Ltr.	Jahr Year Année	Einschränkung Restriction* Restriction*	Thermostat Thermostat Thermostat
300 D	OM 617.912	2.0	1976.10 - 1985.11	Motor no. 073576 → Schaltgetriebe	4049.80D1
300 T Turbo-D	OM 617.952	3.0	1980.10 - 1985.11		4049.80D1
300 Turbo-D	OM 617.952	3.0	1981.08 - 1985.07		4049.80D1
124 Serie					
200	M 102.922	2.0	1985.12 - 1990.05		4078.87D
200 D	OM 601.912	2.0	1984.12 - 1993.06		4176.85D
200 E	M 102.922/M 102.962/M 102.963	2.0	1988.09 - 1993.05		4078.87D
200 E	M 111.940	2.0	1992.10 - 1993.06		4275.87D
220 E	M 111.960	2.2	1992.10 - 1993.06		4275.87D
230 E	M 102.982	2.3	1984.12 - 1993.06		4078.87D
250 D	OM 602.912	2.5	1985.04 - 1993.06		4176.85D
250 TD Turbo	OM 602.962	2.5	1988.03 - 1993.07		4176.80D
250 Turbo-D	OM 602.962	2.5	1988.09 - 1993.06		4176.80D
260 E	M 103.940	2.6	1985.09 - 1992.08		4078.87D
280 E	M 104.942	2.8	1992.10 - 1993.06		4078.87D
300 CE	M 103.983	3.0	1987.03 - 1993.05		4078.87D
300 CE-24	M 104.980	3.0	1989.09 - 1993.06		4078.87D
300 D	OM 603.912/OM 603.913	3.0	1984.12 - 1993.06		4176.85D
300 E	M 103.980/M 103.983/M 103.985	3.0	1985.01 - 1993.06		4078.87D
300 E-24	M 104.980	3.0	1988.09 - 1992.08		4078.87D
300 T D	OM 603.912	3.0	1986.09 - 1993.06		4176.85D
300 TD T	OM 603.960	3.0	1992.06 - 1993.05		4176.85D
300 TE	M 103.983/M 103.985	3.0	1986.01 - 1993.06		4078.87D
300 TE	M 104.980	3.0	1989.09 - 1992.08		4078.87D
300 Turbo-D	OM 603.960, OM 603.963	3.0	1986.09 - 1993.06		4176.80D
320 E	M 104.992	3.2	1992.10 - 1993.06		4078.87D
400 E 4.2	M 119.975	4.2	1992.10 - 1993.06	Motor no. →020770	4137.80D
400 E 4.2	M 119.975	4.2	1992.11 - 1993.06	Motor no. 020771 →	4278.80D
500 E	M 119.974	5.0	1991.01 - 1993.06	Motor no. →010204	4137.80D
500 E	M 119.974	5.0	1991.02 - 1993.06	Motor no. 010205 →	4278.80D
190 (201)					
2.0	M 102.921/M 102.924	2.0	1982.10 - 1990.05		4078.87D
2.3	M 102.985	2.3	1987.09 - 1988.09		4078.87D
2.3 E	M 102.985	2.3	1982.10 - 1988.09		4078.87D
2.6	M 103.942	2.6	1982.10 - 1988.09		4078.87D
D 2.0	OM 601.911	2.0	1983.08 - 1993.08		4176.85D
D 2.5	OM 602.911	2.5	1985.04 - 1993.08		4176.85D
E 1.8	M 102.910	1.8	1990.04 - 1993.08		4078.87D
E 2.0	M 102.961	2.0	1982.10 - 1993.06		4078.87D
E 2.0	M 102.961, M 102.962	2.0	1982.10 - 1993.08		4078.87D
E 2.3	M 102.985	2.3	1986.09 - 1993.08		4078.87D
E 2.3-16	M 102.983	2.3	1984.04 - 1988.08		4078.87D
E 2.5-16	M 102.990/M 102.991	2.5	1988.09 - 1993.08		4078.87D
E 2.6	M 103.942	2.6	1986.09 - 1993.08		4078.87D
E Evolution II 2.5	M 102.992	2.5	1990.05 - 1993.08		4078.87D
Turbo-D 2.5	OM 602.961	2.5	1988.02 - 1993.08		4176.80D
A-Klasse (W168)					
A 140	M 166.940/M 166.960	1.4	1997.07 - 2004.08		411576.87D ▲
A 160	M 166.960	1.6	1997.07 - 2004.08		411576.87D ▲
A 190	M 166.990	1.9	1999.03 - 2004.08		411576.87D ▲
A 210	M 166.995	2.1	2002.03 - 2004.08		411576.87D ▲

MERCEDES-BENZ

 Motor
Engine
Moteur

 Ltr.
Ltr.
Ltr.

 Jahr
Year
Année

 Einschränkung
Restriction*
Restriction*

 Thermostat
Thermostat
Thermostat

A-Klasse (W169)

A 150	M 266.920	1.5	2004.09 - 2012.06		411577.80D ▲
A 160	M 266.920	1.5	2009.04 - 2012.06		411577.80D ▲
A 170	M 266.940	1.7	2004.09 - 2012.06		411577.80D ▲
A 180	M 266.940	1.7	2009.04 - 2012.06		411577.80D ▲
A 200	M 266.960	2.0	2004.09 - 2012.06		411577.80D ▲

B-Klasse (W245)

B 150	M 266.920	1.5	2005.03 - 2011.11		411577.80D ▲
B 160	M 266.920	1.5	2009.04 - 2011.11		411577.80D ▲
B 170	M 266.940	1.7	2005.03 - 2011.11		411577.80D ▲
B 170 NGT	M 266.960	2.0	2008.04 - 2011.11		411577.80D ▲
B 180	M 266.940	1.7	2009.04 - 2011.11		411577.80D ▲
B 180 NGT	M 266.960	2.0	2008.04 - 2011.11		411577.80D ▲
B 200	M 266.960	2.0	2005.03 - 2011.11		411577.80D ▲

C-Klasse (202)

C 180	M 111.921, M 111.920/M 111.952	1.8	1993.03 - 2001.03	mit Klimaanlage	4275.87D
C 180	M 111.921, M 111.920/M 111.952	1.8	1993.03 - 2001.03	ohne Klimaanlage	4276.87D
C 200	M 111.941, M 111.945	2.0	1994.01 - 2001.03	mit Klimaanlage	4275.87D
C 200	M 111.941, M 111.945	2.0	1994.01 - 2001.03	ohne Klimaanlage	4276.87D
C 200 D	OM 601.913	2.0	1993.03 - 2000.05		4176.85D
C 200 D	OM 604.915	2.0	1996.10 - 2001.03	ohne Gehäuse	4176.85D
C 200 D	OM 604.915	2.0	1996.10 - 2001.03	mit Gehäuse	4280.85D
C 200 Kompressor	M 111.944/M 111.956	2.0	1995.10 - 2001.03		4275.87D
C 220	M 111.961	2.2	1993.03 - 2000.05	mit Klimaanlage	4275.87D
C 220	M 111.961	2.2	1993.03 - 2000.05	ohne Klimaanlage	4276.87D
C 220 D	OM 604.910	2.2	1993.08 - 2000.05	ohne Gehäuse	4176.85D
C 220 D	OM 604.910	2.2	1993.08 - 2000.05	mit Gehäuse	4280.85D
C 230	M 111.974	2.3	1996.06 - 1998.06	mit Klimaanlage	4275.87D
C 230	M 111.974	2.3	1996.06 - 1998.06	ohne Klimaanlage	4276.87D
C 230 Kompressor	M 111.975	2.3	1995.10 - 2000.09		4275.87D
C 240	M 112.910/M 112.915	2.4	1997.06 - 2001.03		4281.87D
C 250 D	OM 605.910	2.5	1993.05 - 2000.05		4176.85D
C 250 Turbo-D	OM 605.960	2.5	1995.10 - 2001.03	ohne Gehäuse	4176.80D
C 250 Turbo-D	OM 605.960	2.5	1995.10 - 2001.03	mit Gehäuse	4280.80D
C 280	M 104.941	2.8	1993.05 - 2000.05		4078.87D
C 280	M 112.920	2.8	1997.06 - 2001.03		4281.87D
C 36 AMG	M 104.941 (AMG 3.6)	3.6	1994.05 - 2000.05		4078.87D
C 43 AMG	M 113.944	4.3	1997.08 - 2001.03		4281.87D

C-Klasse (203)

C 160	M 271.911	1.6	2009.02 - 2011.06		3457.90D
C 160 Kompressor	M 271.921	1.8	2002.05 - 2008.05		3457.90D
C 180	M 111.951	2.0	2000.10 - 2002.05	Motor no. 32199684 →	4414.87D
C 180 Kompressor	M 271.946	1.8	2002.05 - 2011.06		3457.90D
C 200 CDI	OM 646.962	2.1	2001.02 - 2008.05	ohne Gewinde	410174.92D
C 200 CDI	OM 646.962	2.1	2001.02 - 2008.05	mit Gewinde	411434.92D ▲
C 200 CGI Kompressor	M 271.942	1.8	2003.03 - 2008.05		3457.90D
C 200 Kompressor	M 111.955	2.0	2000.05 - 2002.05	Motor no. 32199737 →	4414.87D
C 200 Kompressor	M 271.940/M 271.955	1.8	2002.05 - 2011.06		3457.90D
C 220 CDI	OM 646.963	2.1	2004.02 - 2011.06	ohne Gewinde	410174.92D
C 220 CDI	OM 646.963	2.1	2004.02 - 2011.06	mit Gewinde	411434.92D ▲

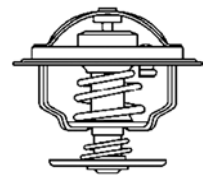
MERCEDES-BENZ

	Motor Engine Moteur	Ltr. Ltr. Ltr.	Jahr Year Année	Einschränkung Restriction* Restriction*	Thermostat Thermostat Thermostat
C 230	M 272.920	2.5	2005.03 - 2011.06	Motor no. 30058377→	4834.100D
C 230 Kompressor	M 111.981	2.3	2001.03 - 2002.05	Motor no. 32200308→	4414.87D
C 230 Kompressor	M 271.948	1.8	2002.05 - 2008.05		3457.90D
C 240	M 112.912/M 112.916	2.6	2000.05 - 2007.08		4281.87D
C 280	M 272.940/M 272.941	3.0	2005.01 - 2007.08	Motor no. 30058377→	4834.100D
C 32 AMG Kompressor	M 112.961	3.2	2001.02 - 2008.05		4298.87D
C 320	M 112.946/M 112.953	3.2	2000.05 - 2008.05		4281.87D
C 320 CDI	OM 642.910	3.0	2005.01 - 2007.08	Europa Ausführung	4490.87D
C 350	M 272.960, M 272.970	3.5	2005.03 - 2011.06	Motor no. 30058377→	4834.100D
C 55 AMG	M 113.988	5.4	2004.02 - 2007.08		4281.87D
C-Klasse (204)					
C 180	M 271.820	1.8	2011.06 -		410389.103D ▲
C 180 CGI	M 271.820	1.8	2007.01 -		410389.103D ▲
C 180 Kompressor	M 271.910/M 271.952	1.6	2007.01 -		3457.90D
C 200	M 271.820	1.8	2011.05 -		410389.103D ▲
C 200 CDI	OM 646.811, OM 646.812	2.1	2007.01 -	ohne Gewinde	410174.92D
C 200 CDI	OM 646.811, OM 646.812	2.1	2007.01 -	mit Gewinde	411434.92D ▲
C 200 CGI	M 271.820, M 271.860	1.8	2007.01 -		410389.103D ▲
C 200 Kompressor	M 271.950	1.8	2007.01 -		3457.90D
C 220 CDI	OM 646.811	2.1	2007.01 -	ohne Gewinde	410174.92D
C 220 CDI	OM 646.811	2.1	2007.01 -	mit Gewinde	411434.92D ▲
C 230	M 272.911/M 272.921	2.5	2007.01 -		4834.100D
C 250	M 271.860	1.8	2011.06 -		410389.103D ▲
C 250 CGI	M 271.860	1.8	2009.07 -		410389.103D ▲
C 280	M 272.947/M 272.948	3.0	2007.01 -		4834.100D
C 300	M 272.947/M 272.948	3.0	2007.07 -		4834.100D
C 320 CDI	OM 642.960/OM 642.961	3.0	2007.01 -	elektrisch	4835.87D
C 320 CDI	OM 642.961	3.0	2007.07 -	thermisch	4490.87D
C 350	M 272.961/M 272.971	3.5	2007.01 -		4834.100D
C 350 CDI	OM 642.960/OM 642.961	3.0	2009.07 -	thermisch	4490.87D
C 350 CDI	OM 642.960/OM 642.961	3.0	2009.07 -	elektrisch	4835.87D
C 350 CGI	M 272.982	3.5	2008.09 -		4834.100D
CLK (208)					
200	M 111.941, M 111.945	2.0	1997.06 - 2002.06	mit Klimaanlage	4275.87D
200	M 111.941, M 111.945	2.0	1997.06 - 2002.06	ohne Klimaanlage	4276.87D
200 Kompressor	M 111.944/M 111.956	2.0	1997.06 - 2002.06		4275.87D
230 Kompressor	M 111.975, M 111.973/M 111.982	2.3	1997.06 - 2002.06		4275.87D
320	M 112.940	3.2	1997.06 - 2002.06		4281.87D
430	M 113.943	4.3	1998.07 - 2002.06		4281.87D
55 AMG	M 113.981, M 113.984	5.4	1999.08 - 2002.06		4281.87D
CLK (209)					
200 CGI	M 271.942	1.8	2003.07 - 2009.05		3457.90D
200 Kompressor	M 271.940/M 271.955	1.8	2002.09 - 2009.05		3457.90D
220 CDI	OM 646.966	2.1	2005.01 - 2009.05	ohne Gewinde	410174.92D
220 CDI	OM 646.966	2.1	2005.01 - 2009.05	mit Gewinde	411434.92D ▲
240	M 112.912	2.6	2002.06 - 2009.05		4281.87D
280	M 272.940	3.0	2005.03 - 2009.05	Motor no. 30058377→	4834.100D
320	M 112.955	3.2	2002.06 - 2009.05		4281.87D
320 CDI	OM 642.910	3.0	2005.01 - 2009.05	thermisch	4490.87D

MERCEDES-BENZ

 Motor
Engine
Moteur

 Ltr.
Ltr.
Ltr.

 Jahr
Year
Année

 Einschränkung
Restriction*
Restriction*

 Thermostat
Thermostat
Thermostat

320 CDI	OM 642.910	3.0	2005.01 - 2009.05	elektrisch	4835.87D
350	M 272.960	3.5	2005.03 - 2009.05	Motor no. 30058377→	4834.100D
500	M 113.968	5.0	2002.06 - 2009.05		4281.87D
500	M 273.965	5.5	2006.06 - 2009.05		4833.100D
55 AMG	M 113.987	5.4	2002.09 - 2009.05		4281.87D
CLK 200 CGI	M 271.942	1.8	2003.07 - 2010.03		3457.90D
CLK 200 Kompressor	M 271.940/M 271.955	1.8	2003.02 - 2010.03		3457.90D
CLK 240	M 112.912	2.6	2003.02 - 2010.03		4281.87D
CLK 280	M 272.940	3.0	2005.03 - 2010.03	Motor no. 30058377→	4834.100D
CLK 320	M 112.955	3.2	2003.02 - 2010.03		4281.87D
CLK 320 CDI	OM 642.910	3.0	2005.03 - 2010.03	thermisch	4490.87D
CLK 320 CDI	OM 642.910	3.0	2005.03 - 2010.03	elektrisch	4835.87D
CLK 350	M 272.960	3.5	2005.03 - 2010.03	Motor no. 30058377→	4834.100D
CLK 500	M 113.968	5.0	2003.02 - 2010.03		4281.87D
CLK 500	M 273.967	5.5	2006.06 - 2010.03		4829.100D ▲
CLK 55 AMG	M 113.987	5.4	2003.02 - 2010.03		4281.87D
CLS (C219)					
CLS 280	M 272.943	3.0	2008.07 - 2010.12		4834.100D
CLS 300	M 272.943	3.0	2009.04 - 2010.12		4834.100D
CLS 320 CDI	OM 642.920	3.0	2005.01 - 2010.12	thermisch	4490.87D
CLS 320 CDI	OM 642.920	3.0	2005.01 - 2010.12	elektrisch	4835.87D
CLS 350	M 272.964	3.5	2005.03 - 2010.12	Motor no. 30000484→	4834.100D
CLS 350	M 272.985	3.5	2006.04 - 2010.12		4834.100D
CLS 350 CDI	OM 642.920	3.0	2009.04 - 2010.12	thermisch	4490.87D
CLS 350 CDI	OM 642.920	3.0	2009.04 - 2010.12	elektrisch	4835.87D
CLS 350 CGI	M 272.985	3.5	2009.04 - 2010.12		4834.100D
CLS 500	M 113.967	5.0	2004.10 - 2010.12		4281.87D
CLS 500	M 273.960	5.5	2006.04 - 2010.12		4829.100D ▲
E-Klasse (124)					
E 200	M 111.940	2.0	1993.06 - 1998.03		4275.87D
E 200 D	OM 601.912	2.0	1993.06 - 1995.06		4176.80D
E 220	M 111.960	2.2	1993.06 - 1998.03		4275.87D
E 250 D	OM 605.911	2.5	1993.06 - 1996.06		4176.85D
E 250 Turbo D	OM 602.962	2.5	1993.06 - 1996.06		4176.80D
E 280	M 104.942	2.8	1993.06 - 1996.06		4078.87D
E 300	M 103.985	3.0	1993.06 - 1996.06		4078.87D
E 300 D	OM 606.910	3.0	1993.06 - 1996.06		4176.80D
E 300 TE-24	M 104.980	3.0	1993.06 - 1996.06		4078.87D
E 300 Turbo-D	OM 603.963	3.0	1993.06 - 1995.06		4176.80D
E 300 Turbo-D	OM 603.960	3.0	1993.06 - 1995.06		4176.85D
E 320	M 104.992, M 104.995	3.2	1993.06 - 1998.03		4078.87D
E 36 AMG	M 104.992 (AMG 3.6)	3.6	1993.06 - 1998.03		4078.87D
E 420	M 119.975	4.2	1993.06 - 1995.06	Motor no. 020771→	4278.80D
E 420	M 119.975	4.2	1993.07 - 1995.06	Motor no. →020770	4137.80D
E 500	M 119.974	5.0	1993.06 - 1995.06	Motor no. 010205→	4278.80D
E 500	M 119.974	5.0	1993.07 - 1995.06	Motor no. →010204	4137.80D
E-KLASSE (207)					
E 200 CGI	M 271.820, M 271.860	1.8	2010.01 -		410389.103D ▲
E 250 CGI	M 271.860	1.8	2009.01 -		410389.103D ▲

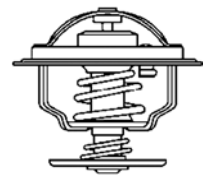
MERCEDES-BENZ

	Motor Engine Moteur	Ltr. Ltr. Ltr.	Jahr Year Année	Einschränkung Restriction* Restriction*	Thermostat Thermostat Thermostat
E 350 CGI	M 272.982, M 272.984	3.5	2009.01 -		4834.100D
E 500	M 273.966	5.5	2009.01 -		4833.100D
E-Klasse (210)					
E 200	M 111.942	2.0	1995.06 - 2000.08		4276.87D
E 200 D	OM 604.917	2.0	1996.01 - 2002.03	ohne Gehäuse	4176.85D
E 200 D	OM 604.917	2.0	1996.01 - 2002.03	mit Gehäuse	4280.85D
E 200 Kompressor	M 111.947/M 111.957	2.0	1997.06 - 2003.03		4275.87D
E 220 D	OM 604.912	2.2	1995.06 - 2002.03	ohne Gehäuse	4176.85D
E 220 D	OM 604.912	2.2	1995.06 - 2002.03	mit Gehäuse	4280.85D
E 230	M 111.970	2.3	1995.06 - 1997.06		4276.87D
E 240	M 112.911/M 112.914	2.4	1997.06 - 2003.03		4281.87D
E 250 D	OM 605.912	2.5	1995.06 - 1999.07		4176.85D
E 250 Turbo-D	OM 605.962	2.5	1997.06 - 1999.07	ohne Gehäuse	4176.80D
E 250 Turbo-D	OM 605.962	2.5	1997.06 - 1999.07	mit Gehäuse	4280.80D
E 280	M 104.945	2.8	1996.01 - 1997.06		4078.87D
E 280	M 112.921	2.8	1996.12 - 2003.03		4281.87D
E 290 Turbo-D	OM 602.982	2.9	1996.03 - 1999.07	ohne Gehäuse	4176.85D
E 290 Turbo-D	OM 602.982	2.9	1996.03 - 1999.07	mit Gehäuse	4280.85D
E 300 D	OM 606.912	3.0	1995.06 - 1997.06		4176.85D
E 300 Turbo-D	OM 606.962	3.0	1996.12 - 1999.07	ohne Gehäuse	4176.80D
E 300 Turbo-D	OM 606.962	3.0	1996.12 - 1999.07	mit Gehäuse	4280.80D
E 320	M 104.995	3.2	1995.06 - 1997.06		4078.87D
E 320	M 112.941	3.2	1997.06 - 2003.03		4281.87D
E 420	M 119.985	4.2	1996.01 - 1997.06		4278.80D
E 430	M 113.940	4.3	1997.06 - 2003.03		4281.87D
E 50 AMG	M 119.985 (AMG 5.0)	5.0	1996.02 - 1997.08		4278.80D
E 55 AMG	M 113.980	5.4	1997.08 - 2003.03		4281.87D
E-Klasse (211)					
3.5 4-matic	M 272.972	3.5	2004.08 - 2006.08		4834.100D
350 CGI	M 272.985	3.5	2006.05 - 2009.07		4834.100D
E 200 CDI	OM 646.951	2.1	2002.07 - 2008.12	ohne Gewinde	410174.92D
E 200 CDI	OM 646.951	2.1	2002.07 - 2008.12	mit Gewinde	411434.92D ▲
E 200 CDI	OM 646.820	2.1	2006.04 - 2008.12	ohne Gewinde	410174.92D
E 200 CDI	OM 646.821	2.1	2006.04 - 2009.07	ohne Gewinde	410174.92D
E 200 CDI	OM 646.820	2.1	2006.04 - 2008.12	mit Gewinde	411434.92D ▲
E 200 CDI	OM 646.821	2.1	2006.04 - 2009.07	mit Gewinde	411434.92D ▲
E 200 CGI	M 271.946	1.8	2002.11 - 2008.12		3457.90D
E 200 Kompressor	M 271.941/M 271.956	1.8	2002.11 - 2009.07		3457.90D
E 200 NGT	M 271.941	1.8	2004.03 - 2009.07		3457.90D
E 220 CDI	OM 646.821/OM 646.961	2.1	2002.03 - 2009.07	ohne Gewinde	410174.92D
E 220 CDI	OM 646.821/OM 646.961	2.1	2002.03 - 2009.07	mit Gewinde	411434.92D ▲
E 230	M 272.922	2.5	2007.05 - 2009.07		4834.100D
E 240	M 112.913, M 112.917	2.6	2002.03 - 2009.07		4281.87D
E 270 CDI	OM 647.961	2.7	2002.03 - 2009.07	ohne Gewinde	410174.92D
E 270 CDI	OM 647.961	2.7	2002.03 - 2009.07	mit Gewinde	411434.92D ▲
E 280	M 272.943	3.0	2005.03 - 2009.07		4834.100D
E 280 CDI	OM 648.961	3.2	2004.05 - 2008.12	ohne Gewinde	410174.92D
E 280 CDI	OM 648.961	3.2	2004.05 - 2008.12	mit Gewinde	411434.92D ▲
E 280 CDI	OM 642.920	3.0	2005.03 - 2009.07	thermisch, Europa Ausführung	4490.87D
E 280 CDI	OM 642.920	3.0	2005.03 - 2009.07	elektrisch, Japan, USA	4835.87D
E 280 T CDI	OM 648.961	3.2	2004.05 - 2009.07	ohne Gewinde	410174.92D
E 280 T CDI	OM 648.961	3.2	2004.05 - 2009.07	mit Gewinde	411434.92D ▲
E 300 BLUETEC	OM 642.920	3.0	2007.09 - 2008.12	thermisch	4490.87D

MERCEDES-BENZ
**Motor
Engine
Moteur**
**Ltr.
Ltr.
Ltr.**
**Jahr
Year
Année**
**Einschränkung
Restriction*
Restriction***
**Thermostat
Thermostat
Thermostat**

E 300 BLUETEC	OM 642.920	3.0	2007.09 - 2008.12	elektrisch	4835.87D
E 320	M 112.949, M 112.954	3.2	2002.03 - 2009.07		4281.87D
E 320 CDI	OM 648.961	3.2	2003.03 - 2009.07	ohne Gewinde	410174.92D
E 320 CDI	OM 648.961	3.2	2003.03 - 2009.07	mit Gewinde	411434.92D ▲
E 320 CDI	OM 642.910	3.0	2005.03 - 2008.12	thermisch, Europa Ausführung	4490.87D
E 320 CDI	OM 642.910	3.0	2005.03 - 2008.12	elektrisch, Japan, USA	4835.87D
E 350	M 272.964, M 272.967, M 272.972	3.5	2004.08 - 2009.07		4834.100D
E 350 CGI	M 272.985	3.5	2007.09 - 2008.12		4834.100D
E 400 CDI	OM 628.961	4.0	2003.02 - 2008.12		4309.92D
E 500	M 113.967, M 113.969	5.0	2002.03 - 2009.07		4281.87D
E 500	M 273.960, M 273.962	5.5	2006.04 - 2009.07		4829.100D ▲

E-Klasse (212)

E 200 CGI	M 271.820, M 271.860	1.8	2009.08 -		410389.103D ▲
E 200 NGT	M 271.958	1.8	2011.03 -		3457.90D
E 250 CGI	M 271.860	1.8	2009.01 -		410389.103D ▲
E 300	M 272.952	3.0	2009.01 -		4834.100D
E 300 CDI	OM 642.850	3.0	2009.11 -		4490.87D
E 350	M 272.977, M 272.980	3.5	2009.01 -		4834.100D
E 350 BlueTEC	OM 642.850	3.0	2009.01 -		4490.87D
E 350 CDI	OM 642.850, OM 642.856	3.0	2009.01 -		4490.87D
E 350 CGI	M 272.982, M 272.983	3.5	2009.01 -		4834.100D
E 500	M 273.970, M 273.971	5.5	2009.01 -		4833.100D

G-Klasse (460)

230 G	M 115.973	2.3	1979.03 - 1993.07		4078.87D
230 GE	M 102.979, M 102.981, M 102.987, M 102.989	2.3	1982.04 - 1992.08		4078.87D
240 GD	OM 616.936	2.4	1979.03 - 1987.08		4117.80D
250 GD	OM 602.930	2.5	1987.10 - 1992.12		4176.85D
280 GE	M 110.994	2.7	1979.11 - 1989.08		4078.87D
300 GD	OM 603.912	3.0	1979.03 - 1993.07		4176.85D
300 GD	OM 617.931	3.0	1979.12 - 1991.12		4049.80D

G-Klasse (461)

230 GE	M 102.979, M 102.996, M 102.997	2.3	1993.06 -		4078.87D
250 GD	OM 602.939	2.5	1990.02 -		4176.85D
290 GD / G 290 D	OM 602.942	2.9	1992.04 -		4176.85D
G 280 CDI	OM 642.884	3.0	2009.04 -		4490.87D
G 290 TD	OM 602.983	2.9	1997.07 -		4176.85D
G 300 CDI	OM 642.884	3.0	2010.04 -		4490.87D

G-Klasse (463)

230 GE	M 102.989	2.3	1990.06 - 1993.06		4078.87D
300 GD	OM 603.931	3.0	1989.09 - 1997.09		4176.85D
300 GE	M 103.987	3.0	1989.09 - 1997.09		4078.87D
320 GE	M 104.996	3.2	1994.09 - 1997.11		4078.87D
350 G Turbo-D	OM 603.972	3.4	1991.09 - 1997.09		4176.80D
350 Turbo GD	OM 603.972	3.4	1991.09 -		4176.80D
G 300 TD	OM 606.964	3.0	1996.08 -	ohne Gehäuse	4176.80D
G 300 TD	OM 606.964	3.0	1996.08 -	mit Gehäuse	4280.80D
G 320	M 104.996	3.2	1994.09 - 1997.12		4078.87D
G 320	M 112.945	3.2	1997.07 -		4281.87D
G 320 CDI	OM 642.970	3.0	2006.09 -		4490.87D

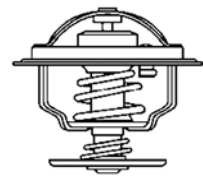
MERCEDES-BENZ

	Motor Engine Moteur	Ltr. Ltr. Ltr.	Jahr Year Année	Einschränkung Restriction* Restriction*	Thermostat Thermostat Thermostat
G 400 CDI	OM 628.962	4.0	2000.12 -		4309.92D
G 500	M 113.962	5.0	1998.04 -		4281.87D
G 500	M 273.963	5.5	2009.12 -		4833.100D
G 500 E	M 117.965	5.0	1993.09 -		4137.80D
G 55 AMG	M 113.982, M 113.993	5.4	1999.04 -		4281.87D
GLK-Klasse (X204)					
280	M 272.948	3.0	2008.06 - 2009.06		4834.100D
300	M 272.948	3.0	2009.07 - 2011.04		4834.100D
320 CDI	OM 642.961	3.0	2008.06 -	thermisch	4490.87D
320 CDI	OM 642.961	3.0	2008.06 -	elektrischgesteuert	4835.87D
350	M 272.971, M 272.991	3.5	2008.06 - 2011.04		4834.100D
GL-Klasse (X164)					
GL 320 CDI	OM 642.940	3.0	2006.09 - 2009.05		4490.87D
GL 350 CDI	OM 642.822, OM 642.940	3.0	2009.05 -		4490.87D
GL 350 CDI BlueTEC	OM 642.820	3.0	2009.12 -		4490.87D
GL 450	M 273.923	4.7	2006.09 -		4833.100D
GL 500	M 273.963	5.5	2006.09 -		4833.100D
MB 100 (631)					
D	OM 616	2.4	1988.02 - 1996.02		4049.80D1
M-Klasse (163)					
ML 230	M 111.977	2.3	1998.02 - 2005.06		4275.87D
ML 320	M 112.942	3.2	1998.02 - 2002.08		4281.87D
ML 350	M 112.970	3.7	2002.08 - 2005.06		4281.87D
ML 400 CDI	OM 628.963	4.0	2001.09 - 2005.06		4309.92D
ML 430	M 113.942	4.3	1998.02 - 2005.06		4281.87D
ML 500	M 113.964, M 113.965	5.0	2001.09 - 2005.06		4281.87D
ML 55 AMG	M 113.981	5.4	2000.02 - 2005.06		4281.87D
M-Klasse (164)					
ML 280 CDI	OM 642.940	3.0	2005.07 - 2009.07		4490.87D
ML 300 CDI	OM 642.940	3.0	2009.07 -		4490.87D
ML 300 CDI	OM 642.820	3.0	2010.02 -		4490.87D
ML 320 CDI	OM 642.940	3.0	2005.07 - 2009.07		4490.87D
ML 350	M 272.967	3.5	2005.07 -		4834.100D
ML 350 CDI	OM 642.940	3.0	2009.07 -		4490.87D
ML 350 CDI BLUETEC SCR	OM 642.820	3.0	2009.09 -		4490.87D
ML 500	M 113.964	5.0	2005.07 -		4281.87D
ML 500	M 273.963	5.5	2007.12 -		4834.100D
Pullmann (100)					
600	M 100.982, M 100.980	6.3	1964.09 - 1979.01		4078.79D
R-Klasse (251)					
R 280	M 272.945	3.0	2007.01 -		4834.100D
R 280 CDI	OM 642.870, OM 642.950	3.0	2006.05 -		4490.87D
R 300	M 272.945	3.0	2009.07 -		4834.100D
R 300 CDI	OM 642.870, OM 642.950	3.0	2006.01 -		4490.87D
R 300 CDI	OM 642.950	3.0	2009.07 -		4490.87D
R 320 CDI	OM 642.870, OM 642.950,	3.0	2006.01 -		4490.87D
R 350	M 272.967	3.5	2006.01 -		4834.100D

MERCEDES-BENZ

 Motor
Engine
Moteur

 Ltr.
Ltr.
Ltr.

 Jahr
Year
Année

 Einschränkung
Restriction*
Restriction*

 Thermostat
Thermostat
Thermostat

R 350 CDI	OM 642.870, OM 642.950	3.0	2006.01 -		4490.87D
R 350 CDI	OM 642.950	3.0	2009.07 -		4490.87D
R 500	M 113.971	5.0	2006.01 -		4281.87D
R 500	M 273.963	5.5	2007.01 -		4833.100D

S-Klasse (108/109)

250 S	M 108.920	2.5	1966.01 - 1969.12		4078.87D
250 SE	M 129.980	2.5	1966.01 - 1967.12		4078.87D
280 S	M 130.920	2.8	1967.10 - 1972.07		4078.87D
280 SE, SEL	M 130.980	2.8	1968.01 - 1972.08		4078.87D
280 SE, SEL 3.5	M 116.980	3.5	1971.03 - 1972.08		4078.87D
300 SEL	M 130.981	2.7	1968.01 - 1972.08		4078.87D
300 SEL 3.5	M 116.981	3.5	1970.01 - 1972.07		4064.75D
300 SEL 6.3	M 100.981	6.3	1968.03 - 1972.08		4078.79D

S-Klasse (116)

280 S	M 110.922	2.7	1972.08 - 1980.07		4078.87D
280 SE, SEL	M 110.983, M 110.985	2.7	1972.08 - 1980.07		4078.87D
350 SE, SEL	M 116.983, M 116.985	3.5	1972.08 - 1976.02		4064.75D
450 SE, SEL	M 117.983, M 117.985, M 117.986	4.5	1973.01 - 1980.04		4064.75D
450 SEL 6.9	M 100.985	6.8	1975.07 - 1980.03		4078.87D

S-Klasse (126)

260 SE	M 103.941	2.6	1985.09 - 1991.06		4078.87D
280 S	M 110.926, M 110.924	2.7	1979.12 - 1985.07		4078.87D
280 SE, SEL	M 110.987, M 110.989	2.7	1979.10 - 1985.07		4078.87D
3.8	M 116.960	3.8	1980.08 - 1984.08		4064.75D
300 SE, SEL	M 103.981	3.0	1985.09 - 1991.06		4078.87D
380 SE, SEL	M 116.963	3.8	1979.12 - 1981.08		4064.75D
380 SE, SEL	M 116.963	3.8	1981.09 - 1985.08		4233.84D
380 SE, SEL	M 116.961	3.8	1985.12 - 1986.12		4137.80D
380 SEC	M 116.963	3.8	1981.10 - 1985.07		4233.84D
420 SE, , SEC, SEL	M 116.965	4.2	1985.10 - 1991.06		4137.80D
500 SE, SEL	M 117.961, M 117.963	5.0	1979.12 - 1981.08		4064.75D
500 SE, SEL	M 117.961, M 117.963	5.0	1981.09 - 1985.08		4233.84D
500 SE, SEL	M 117.965	5.0	1985.09 - 1991.06		4137.80D
500 SEC	M 117.963	5.0	1981.10 - 1985.08		4233.84D
500 SEC	M 117.965	5.0	1985.09 - 1991.06		4137.80D
560 SE, SEL	M 117.968	5.5	1985.10 - 1991.06		4137.80D
560 SEC	M 117.968	5.5	1985.10 - 1991.06		4137.80D

S-Klasse (140)

300 SE 2.8	M 104.944	2.8	1993.01 - 1998.10		4078.87D
300 SE, SEL / S 320	M 104.990, M 104.994	3.2	1991.03 - 1998.10		4078.87D
400 SE, SEL / S 420	M 119.971	4.2	1991.02 - 1998.10	Motor no. →026750	4137.80D
400 SE, SEL / S 420	M 119.971	4.2	1991.03 - 1998.10	Motor no. 026751→	4278.80D
500 SE, SEL	M 119.970	5.0	1991.02 - 1998.10	Motor no. →056885	4137.80D
500 SE, SEL	M 119.970	5.0	1991.03 - 1998.10	Motor no. 056885→	4278.80D
600 SE, SEL	M 120.982, M 120.980	6.0	1991.04 - 1992.12		4517.87D
S 280	M 104.944	2.8	1993.02 - 1998.10		4078.87D
S 300 Turbo-D	OM 606.961	3.0	1996.05 - 1998.10	ohne Gehäuse	4176.80D
S 300 Turbo-D	OM 606.961	3.0	1996.05 - 1998.10	mit Gehäuse	4280.80D
S 320	M 104.990	3.2	1995.10 - 1998.08		4078.87D
S 350 Turbo-D	OM 603.971	3.4	1993.01 - 1998.10	ohne Gehäuse	4176.80D
S 350 Turbo-D	OM 603.971	3.4	1993.01 - 1998.10	mit Gehäuse	4280.80D

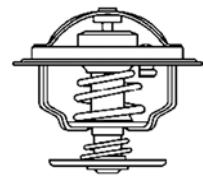
MERCEDES-BENZ

	Motor Engine Moteur	Ltr. Ltr. Ltr.	Jahr Year Année	Einschränkung Restriction* Restriction*	Thermostat Thermostat Thermostat
S 420	M 119.971	4.2	1993.01 - 1998.10	Motor no. →056885	4137.80D
S 420	M 119.971	4.2	1993.02 - 1998.10	Motor no. 026751→	4278.80D
S 500	M 119.970	5.0	1993.01 - 1998.10	Motor no. →056885	4137.80D
S 500	M 119.980	5.0	1993.01 - 1998.10		4278.80D
S 500	M 119.970	5.0	1993.02 - 1998.10	Motor no. 056886→	4278.80D
S 600	M 120.982, M 120.980	6.0	1993.01 - 1998.10		4517.87D
SEC/CL 420	M 119.971	4.2	1994.10 - 1999.02	Motor no. →026750	4137.80D
SEC/CL 420	M 119.981	4.2	1994.10 - 1999.02		4278.80D
SEC/CL 420	M 119.971	4.2	1994.11 - 1999.02	Motor no. 026751→	4278.80D
SEC/CL 500	M 119.970	5.0	1992.10 - 1999.02	Motor no. →056885	4137.80D
SEC/CL 500	M 119.970	5.0	1992.11 - 1999.02	Motor no. 056886→	4278.80D
SEC/CL 600	M 120.982, M 120.980	6.0	1992.09 - 1999.02		4517.87D
S-Klasse (215)					
CL 500	M 113.960	5.0	1999.03 - 2006.03		4281.87D
CL 55 AMG	M 113.986	5.4	1999.10 - 2006.03		4281.87D
S-Klasse (220)					
S 280	M 112.922, M 112.944	2.8	1998.10 - 2005.08		4281.87D
S 320 CDI	OM 648.960	3.2	2002.09 - 2005.08	ohne Gewinde	410174.92D
S 320 CDI	OM 648.960	3.2	2002.09 - 2005.08	mit Gewinde	411434.92D ▲
S 350	M 112.972, M 112.975	3.7	2002.09 - 2005.08		4281.87D
S 400 CDI	OM 628.960	4.0	2000.06 - 2005.08		4309.92D
S 430	M 113.941, M 113.948	4.3	1998.10 - 2005.08		4281.87D
S 500	M 113.960, M 113.966	5.0	1998.10 - 2005.08		4281.87D
S 55 AMG	M 113.986	5.4	1999.04 - 2005.08		4281.87D
S-Klasse (W221)					
S 320 CDI	OM 642.930, OM 642.932	3.0	2005.10 - 2009.06	thermisch	4490.87D
S 320 CDI	OM 642.930, OM 642.932	3.0	2005.12 - 2009.06	elektrisch	4835.87D
S 350	M 272.965, M 272.975	3.5	2005.10 -		4834.100D
S 350 CDI	OM 642.930	3.0	2009.06 -	thermisch	4490.87D
S 350 CDI	OM 642.930	3.0	2009.06 -	elektrisch	4835.87D
S 400 Hybrid	M 272.974	3.5	2009.01 -		4834.100D
S 450	M 273.922, M 273.924	4.7	2005.12 -		4833.100D
S 500	M 273.961, M 273.968	5.5	2005.10 -		4833.100D
S-Klasse Coupe (C216)					
CL 500	M 273.961, M 273.968	5.5	2006.06 -		4833.100D
SL (107)					
280 SL	M 110.986, M 110.990, M 110.982	2.7	1974.08 - 1985.07		4078.87D
300 SL	M 103.982	3.0	1985.09 - 1989.08		4078.87D
350 SL	M 116.982, M 116.984	3.5	1971.05 - 1980.02		4064.75D
380 SL	M 116.960, M 116.962	3.8	1980.09 - 1981.08		4064.75D
420 SL	M 116.964	4.2	1986.01 - 1989.08		4137.80D
450 SL	M 117.982, M 117.985	4.5	1972.10 - 1980.10		4064.75D
450 SLC 5.0	M 117.960	5.0	1978.06 - 1980.02		4278.80D
500 SL	M 117.960, M 117.964	5.0	1980.05 - 1985.12		4278.80D
SL (129)					
280	M 104.943	2.8	1993.08 - 2001.10		4078.87D
280	M 112.923, M 112.925	2.8	1998.05 - 2001.10		4281.87D
300 SL	M 103.984	3.0	1989.03 - 1993.08		4078.87D

MERCEDES-BENZ

 Motor
Engine
Moteur

 Ltr.
Ltr.
Ltr.

 Jahr
Year
Année

 Einschränkung
Restriction*
Restriction*

 Thermostat
Thermostat
Thermostat

300 SL-24	M 104.981	3.0	1989.03 - 1993.07		4078.87D
320	M 104.991	3.2	1993.09 - 2001.10		4078.87D
320	M 112.943	3.2	1998.05 - 2001.10		4281.87D
500	M 113.961	5.0	1998.05 - 2001.10		4281.87D
500 SL	M 119.960, M 119.972	5.0	1989.09 - 1992.08		4137.80D
500 SL	M 119.972	5.0	1989.09 - 2001.10	Motor no. →013777	4137.80D
500 SL	M 119.972	5.0	1989.10 - 2001.10	Motor no. 013778→	4278.80D
55 AMG	M 113.985	5.4	2000.03 - 2001.10		4281.87D
60 AMG	M 122.981	6.0	1997.05 - 2001.10		4517.87D
600	M 120.980, M 120.981, M 120.983	6.0	1992.07 - 2001.10		4517.87D
SL (230)					
280	M 272.949	3.0	2008.03 - 2012.01		4834.100D
300	M 272.949	3.0	2009.04 - 2012.01		4834.100D
350	M 112.973	3.7	2003.03 - 2012.01		4281.87D
350	M 272.966, M 272.968	3.5	2006.03 - 2012.01		4834.100D
500	M 113.963	5.0	2001.10 - 2012.01		4281.87D
500	M 273.965	5.5	2006.03 - 2012.01		4833.100D
SLK (170)					
200	M 111.946	2.0	1996.09 - 2000.03		4275.87D
200 Kompressor	M 111.943, M 111.958	2.0	1996.10 - 2004.04		4275.87D
230 Kompressor	M 111.973, M 111.983	2.3	1996.09 - 2004.04		4275.87D
32 AMG Kompressor	M 112.960	3.2	2001.03 - 2004.04		4298.87D
320	M 112.947	3.2	2000.03 - 2004.04		4281.87D
SLK (171)					
200 Kompressor	M 271.944, M 271.954	1.8	2004.03 - 2011.02		3457.90D
280	M 272.942	3.0	2005.03 - 2011.02	Motor no. 30058377→	4834.100D
300	M 272.942	3.0	2009.04 - 2011.02		4834.100D
350	M 272.963	3.5	2005.03 - 2011.02	Motor no. 30000484→	4834.100D
350	M 272.969	3.5	2008.01 - 2011.02		4834.100D
SLK (R172)					
200	M 271.860, M 271.861	1.8	2011.02 -		410389.103D ▲
250	M 271.860, M 271.861	1.8	2011.02 -		410389.103D ▲
SPRINTER 2-t (901, 902)					
208 CDI	OM 611.987	2.1	2000.04 - 2006.05	ohne Gewinde	410171.87D
208 CDI	OM 611.987	2.1	2000.04 - 2006.05	mit Gewinde	411433.87D ▲
208 D	OM 601.943	2.3	1995.01 - 2000.04	ohne Gehäuse	4176.85D
208 D	OM 601.943	2.3	1995.01 - 2000.04	mit Gehäuse	4280.85D
210 D	OM 602.980	2.9	1997.01 - 2000.04	ohne Gehäuse	4176.85D
210 D	OM 602.980	2.9	1997.01 - 2000.04	mit Gehäuse	4280.85D
211 CDI	OM 611.981	2.1	2000.04 - 2006.05	ohne Gewinde	410171.87D
211 CDI	OM 611.981	2.1	2000.04 - 2006.05	mit Gewinde	411433.87D ▲
212 D	OM 602.980	2.9	1995.02 - 2000.04	ohne Gehäuse	4176.85D
212 D	OM 602.980	2.9	1995.02 - 2000.04	mit Gehäuse	4280.85D
213 CDI	OM 611.981	2.1	2000.04 - 2006.05	ohne Gewinde	410171.87D
213 CDI	OM 611.981	2.1	2000.04 - 2006.05	mit Gewinde	411433.87D ▲
214	M 111.979, M 111.984	2.3	1995.02 - 2006.05		4275.87D
214 NGT	M 111.984	2.3	2000.04 - 2006.05		4275.87D
216 CDI	OM 612.981	2.7	2000.04 - 2006.05	ohne Gewinde	410171.87D
216 CDI	OM 612.981	2.7	2000.04 - 2006.05	mit Gewinde	411433.87D ▲

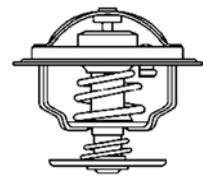
MERCEDES-BENZ

	Motor Engine Moteur	Ltr. Ltr. Ltr.	Jahr Year Année	Einschränkung Restriction* Restriction*	Thermostat Thermostat Thermostat
SPRINTER 3-t (903)					
2.3 D	OM 601.943	2.3	1997.06 - 1999.12	ohne Gehäuse	4176.85D
2.3 D	OM 601.943	2.3	1997.06 - 1999.12	mit Gehäuse	4280.85D
2.9 TDi	OM 602.980	2.9	1997.01 - 1999.12	ohne Gehäuse	4176.85D
2.9 TDi	OM 602.980	2.9	1997.01 - 1999.12	mit Gehäuse	4280.85D
308 CDI	OM 611.987	2.1	2000.04 - 2006.05	ohne Gewinde	410171.87D
308 CDI	OM 611.987	2.1	2000.04 - 2006.05	mit Gewinde	411433.87D ▲
308 D	OM 601.943	2.3	1995.02 - 2000.04	ohne Gehäuse	4176.85D
308 D	OM 601.943	2.3	1995.02 - 2000.04	mit Gehäuse	4280.85D
308 D 2.3	OM 601.943	2.3	1995.02 - 2000.04	ohne Gehäuse	4176.85D
308 D 2.3	OM 601.943	2.3	1995.02 - 2000.04	mit Gehäuse	4280.85D
310 D	OM 602.980	2.9	1997.05 - 2002.08	ohne Gehäuse	4176.85D
310 D	OM 602.980	2.9	1997.05 - 2002.08	mit Gehäuse	4280.85D
310 D 2.9	OM 602.980	2.9	1995.02 - 2000.04	ohne Gehäuse	4176.85D
310 D 2.9	OM 602.980	2.9	1995.02 - 2000.04	mit Gehäuse	4280.85D
311 CDI	OM 611.981	2.1	2000.04 - 2006.05	ohne Gewinde	410171.87D
311 CDI	OM 611.981	2.1	2000.04 - 2006.05	mit Gewinde	411433.87D ▲
312 D 2.9	OM 602.980	2.9	1995.02 - 2002.08	ohne Gehäuse	4176.85D
312 D 2.9	OM 602.980	2.9	1995.02 - 2002.08	mit Gehäuse	4280.85D
313 CDI	OM 611.981	2.1	2000.04 - 2006.05	ohne Gewinde	410171.87D
313 CDI	OM 611.981	2.1	2000.04 - 2006.05	mit Gewinde	411433.87D ▲
314	M 111.979, M 111.984	2.3	1995.02 - 2006.05		4275.87D
314 NGT	M 111.984	2.3	2000.04 - 2006.05		4275.87D
316 CDI	OM 612.981	2.7	2000.04 - 2006.05	ohne Gewinde	410171.87D
316 CDI	OM 612.981	2.7	2000.04 - 2006.05	mit Gewinde	411433.87D ▲
SPRINTER 4-t (904)					
2.3 D	OM 601.943	2.3	1997.06 - 1999.12	ohne Gehäuse	4176.85D
2.3 D	OM 601.943	2.3	1997.06 - 1999.12	mit Gehäuse	4280.85D
408 CDI	OM 611.987	2.1	2000.04 - 2006.05	ohne Gewinde	410171.87D
408 CDI	OM 611.987	2.1	2000.04 - 2006.05	mit Gewinde	411433.87D ▲
408 D	OM 601.943	2.3	1996.02 - 2006.05	ohne Gehäuse	4176.85D
408 D	OM 601.943	2.3	1996.02 - 2006.05	mit Gehäuse	4280.85D
410 D	OM 602.980	2.9	1996.02 - 2006.05	ohne Gehäuse	4176.85D
410 D	OM 602.980	2.9	1996.02 - 2006.05	mit Gehäuse	4280.85D
411 CDI	OM 611.981	2.1	2000.04 - 2006.05	ohne Gewinde	410171.87D
411 CDI	OM 611.981	2.1	2000.04 - 2006.05	mit Gewinde	411433.87D ▲
412 D	OM 602.980	2.9	1996.02 - 2006.05	ohne Gehäuse	4176.85D
412 D	OM 602.980	2.9	1996.02 - 2006.05	mit Gehäuse	4280.85D
413 CDI	OM 611.981	2.1	2000.04 - 2006.05	ohne Gewinde	410171.87D
413 CDI	OM 611.981	2.1	2000.04 - 2006.05	mit Gewinde	411433.87D ▲
414	M 111.979	2.3	1996.02 - 2006.05		4275.87D
416 CDI	OM 612.981	2.7	2000.04 - 2006.05	ohne Gewinde	410171.87D
416 CDI	OM 612.981	2.7	2000.04 - 2006.05	mit Gewinde	411433.87D ▲
SPRINTER 3,5-t (906)					
309 CDI	OM 646.984	2.1	2006.06 -	ohne Gewinde	410171.87D
309 CDI	OM 646.984	2.1	2006.06 -	mit Gewinde	411433.87D ▲
311 CDI	OM 646.985	2.1	2006.06 -	ohne Gewinde	410171.87D
311 CDI	OM 646.985	2.1	2006.06 -	mit Gewinde	411433.87D ▲
313 CDI	OM 646.986	2.1	2006.06 -	ohne Gewinde	410171.87D
313 CDI	OM 646.986	2.1	2006.06 -	mit Gewinde	411433.87D ▲
315 CDI	OM 646.990, OM 646.989	2.1	2006.06 -	ohne Gewinde	410171.87D
315 CDI	OM 646.990, OM 646.989	2.1	2006.06 -	mit Gewinde	411433.87D ▲
316	M 271.951	1.8	2008.09 -		3457.90D
316 NGT	M 271.951	1.8	2008.09 -		3457.90D

MERCEDES-BENZ
**Motor
Engine
Moteur**
**Ltr.
Ltr.
Ltr.**
**Jahr
Year
Année**
**Einschränkung
Restriction*
Restriction***
**Thermostat
Thermostat
Thermostat**

318 CDI	OM 642.992, OM 642.993	3.0	2006.06 -		410055.87D ▲
318 CDI	OM 642.896	3.0	2006.06 -		4490.87D
319 CDI / BlueTEC	OM 642.992	3.0	2009.03 -		410055.87D ▲
319 CDI / BlueTEC	OM 642.896, OM 642.898	3.0	2009.03 -		4490.87D
324	M 272.979	3.5	2006.06 -		4833.100D

SPRINTER 3-t (906)

209 CDI	OM 646.984	2.1	2006.06 -	ohne Gewinde	410171.87D
209 CDI	OM 646.984	2.1	2006.06 -	mit Gewinde	411433.87D ▲
211 CDI	OM 646.985	2.1	2006.06 -	ohne Gewinde	410171.87D
211 CDI	OM 646.985	2.1	2006.06 -	mit Gewinde	411433.87D ▲
213 CDI	OM 646.986	2.1	2006.06 -	ohne Gewinde	410171.87D
213 CDI	OM 646.986	2.1	2006.06 -	mit Gewinde	411433.87D ▲
215 CDI	OM 646.990, OM 646.989	2.1	2006.06 -	ohne Gewinde	410171.87D
215 CDI	OM 646.990, OM 646.989	2.1	2006.06 -	mit Gewinde	411433.87D ▲
216	M 271.951	1.8	2008.09 -		3457.90D
218 CDI	OM 642.992, OM 642.993	3.0	2006.06 -		410055.87D ▲
218 CDI	OM 642.896	3.0	2006.06 -		4490.87D
219 CDI / BlueTEC	OM 642.992	3.0	2009.03 -		410055.87D ▲
219 CDI / BlueTEC	OM 642.896	3.0	2009.03 -		4490.87D
224	M 272.979	3.5	2006.06 -		4833.100D

SPRINTER 4,6 (906)

413 CDI	OM 646.986	2.1	2006.06 -	ohne Gewinde	410171.87D
413 CDI	OM 646.986	2.1	2006.06 -	mit Gewinde	411433.87D ▲
415 CDI	OM 646.990, OM 646.989	2.1	2006.06 -	ohne Gewinde	410171.87D
415 CDI	OM 646.990, OM 646.989	2.1	2006.06 -	mit Gewinde	411433.87D ▲
418 CDI	OM 642.992, OM 642.993	3.0	2006.06 -		410055.87D ▲
418 CDI	OM 642.896	3.0	2006.06 -		4490.87D
419 CDI	OM 642.992	3.0	2009.03 -		410055.87D ▲
419 CDI	OM 642.896, OM 642.898	3.0	2009.03 -		4490.87D
424	M 272.979	3.5	2006.06 -		4833.100D

SPRINTER 5-t (906)

509 CDI	OM 646.984	2.1	2006.06 -	ohne Gewinde	410171.87D
509 CDI	OM 646.984	2.1	2006.06 -	mit Gewinde	411433.87D ▲
511 CDI	OM 646.985	2.1	2006.06 -	ohne Gewinde	410171.87D
511 CDI	OM 646.985	2.1	2006.06 -	mit Gewinde	411433.87D ▲
513 CDI	OM 646.986	2.1	2006.06 -	ohne Gewinde	410171.87D
513 CDI	OM 646.986	2.1	2006.06 -	mit Gewinde	411433.87D ▲
515 CDI	OM 646.990, OM 646.989	2.1	2006.06 -	ohne Gewinde	410171.87D
515 CDI	OM 646.990, OM 646.989	2.1	2006.06 -	mit Gewinde	411433.87D ▲
516	M 271.951	1.8	2008.09 -		3457.90D
516 NGT	M 271.951	1.8	2008.09 -		3457.90D
518 CDI	OM 642.992, OM 642.993	3.0	2006.06 -		410055.87D ▲
518 CDI	OM 642.896	3.0	2006.06 -		4490.87D
519 CDI / BlueTEC	OM 642.898, OM 642.992, OM 642.896	3.0	2009.03 -		410055.87D ▲
519 CDI / BlueTEC	OM 642.896, OM 642.898	3.0	2009.03 -		4490.87D
524	M 272.979	3.5	2006.06 -		4833.100D

SPRINTER (905)

616 CDI	OM 612.981	2.7	2001.04 - 2006.05	ohne Gewinde	410171.87D
616 CDI	OM 612.981	2.7	2001.04 - 2006.05	mit Gewinde	411433.87D ▲

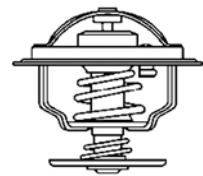
MERCEDES-BENZ

	Motor Engine Moteur	Ltr. Ltr. Ltr.	Jahr Year Année	Einschränkung Restriction* Restriction*	Thermostat Thermostat Thermostat
T1 (601, 602)					
207 D 2.4	OM 616.917, OM 616.934	2.4	1977.12 - 1989.10		4049.80D
207 D 2.4	OM 616.937, OM 616.939	2.4	1977.12 - 1990.01		4049.80D1
208 2.3	M 115.972, M 115.955	2.3	1977.05 - 1982.12		4078.87D
208 D 2.3	OM 601.940	2.3	1987.10 - 1996.02	ohne Gehäuse	4176.85D
208 D 2.3	OM 601.940	2.3	1987.10 - 1996.02	mit Gehäuse	4280.85D
209 D 2.9	OM 617.913	3.0	1982.12 - 1990.01		4049.80D1
210 2.3	M 102.942, M 102.945, M 102.946	2.3	1977.04 - 1996.02		4078.87D
210 2.3	M 115.955	2.3	1977.04 - 1989.10		4078.87D
210 D 2.8	OM 602.940	2.9	1987.10 - 1996.02		4176.85D
210 D 2.9	OM 602.940	2.9	1988.11 - 1996.02		4176.85D
307 D 2.4	OM 616.917	2.4	1977.01 - 1990.12		4117.80D
307 D 2.4	OM 616.937, OM 616.939	2.4	1977.04 - 1990.01		4049.80D1
308 D 2.3	OM 601.940	2.3	1988.11 - 1996.02	ohne Gehäuse	4176.85D
308 D 2.3	OM 601.940	2.3	1988.11 - 1996.02	mit Gehäuse	4280.85D
309 D 3.0	OM 617.913	3.0	1982.10 - 1990.01		4049.80D1
310 D 2.9	OM 602.940	2.9	1989.06 - 1996.02		4176.85D
T1 / TN					
407 D	OM 616.913, OM 616.939	2.4	1981.07 - 1989.01		4049.80D1
408 D	OM 601.940	2.3	1988.11 - 1995.06	ohne Gehäuse	4176.85D
408 D	OM 601.940	2.3	1988.11 - 1995.06	mit Gehäuse	4280.85D
409 D	OM 617.913	3.0	1982.04 - 1989.01		4049.80D1
410	M 102.942, M 102.945	2.3	1982.08 - 1995.06		4078.87D
410 D	OM 602.940	2.9	1988.11 - 1995.06		4176.85D
T2					
L 405 D	OM 615	2.2	1972.01 - 1980.12		4078.79D
L 406 DG	OM 615.910	2.2	1968.01 - 1974.12		4078.79D
L 407 D	OM 616.910	2.4	1975.01 - 1988.12		4078.79D
L 407 D	OM 616.917	2.4	1975.01 - 1988.12		4117.80D
L 408 DG	OM 314.948	3.8	1970.01 - 1974.12		4083.83D50
L 408 G	M 115.1	2.0	1968.01 - 1972.12		4078.87D
L 408 G	M 115.921, M 115.928	2.2	1972.08 - 1974.12		4105.83D
L 409	M 115.952	2.3	1975.01 - 1982.08		4105.83D
L 410	M 102.943	2.3	1982.08 - 1988.12		4078.87D
L 508 DG	OM 314.946, OM 314.948	3.8	1970.01 - 1988.12		4083.83D50
L 608 D	OM 314.946, OM 314.948, OM 314.961, OM 314.963, OM 314.967	3.8	1970.01 - 1988.12		4083.83D50
L 613 D	OM 353.966, OM 353.963	5.7	1977.04 - 1988.12		4083.83D50
L 911	OM 352.906, OM 352.911, OM 352.989	5.7	1972.01 - 1983.07		4083.83D50
LF 408 G	M 115.927, M 115.929	2.2	1972.08 - 1974.12		4105.83D
LF 409 G	M 115.952, M 115.971, M 115.970	2.3	1975.01 - 1982.08		4105.83D
LK 408 G, LK 409	M 115.952	2.3	1975.01 - 1982.08		4105.83D
LK 408 G, LK 409	M 102.943	2.3	1982.08 - 1983.09		4078.87D
LK 911	OM 352.911	5.7	1972.01 - 1983.07		4083.83D50
LKO 508 DG	OM 314.946, OM 314.948, OM 314.961, OM 314.963, OM 314.959, OM 314.962	3.8	1972.06 - 1988.06		4083.83D50
LS 911	OM 352.911	5.7	1972.01 - 1983.07		4083.83D50
T2 / LN1					
507 D	OM 616.914	2.4	1986.04 - 1989.04		4049.80D1
508 D	OM 601.941	2.3	1989.03 - 1994.12		4176.85D
510	M 102.946	2.3	1986.04 - 1994.12		4078.87D
609 D	OM 364.906	4.0	1986.04 - 1994.12		4105.83D

MERCEDES-BENZ
**Motor
Engine
Moteur**
**Ltr.
Ltr.
Ltr.**
**Jahr
Year
Année**
**Einschränkung
Restriction*
Restriction***
**Thermostat
Thermostat
Thermostat**

609 D	OM 364.919	4.0	1986.04 - 1994.12		4105.83D
609 D	OM 354.902	4.0	1994.06 - 1994.12		4105.83D
611 D	OM 354.901	4.0	1994.06 - 1994.12		4105.83D
611 D	OM 354.902	4.0	1994.06 - 1994.12		4105.83D
709 D	OM 364.906	4.0	1986.04 - 1994.12		4105.83D
709 D	OM 364.906, OM 364.912, OM 364.921	4.0	1986.04 - 1994.12		4105.83D
711 D	OM 364.957, OM 354.902, OM 354.903	4.0	1986.04 - 1994.12		4105.83D
711 D	OM 364.950, OM 364.952	4.0	1986.04 - 1994.12		4105.83D
714 D	OM 354.923	4.0	1994.06 - 1994.12		4105.83D
809 D	OM 364.906, OM 364.911, OM 364.920, OM 364.921	4.0	1986.04 - 1994.12		4105.83D
811 D	OM 354.901, OM 354.903, OM 364.950, OM 364.952, OM 364.958	4.0	1986.04 - 1994.12		4105.83D
814 D	OM 354.924, OM 354.925	4.0	1987.11 - 1994.12		4105.83D
814 D	OM 364.981, OM 364.984, OM 364.986, OM 364.987	4.0	1987.11 - 1994.12		4105.83D
O 609 D	OM 364.913	4.0	1987.07 - 1992.12		4105.83D
O 611 D	OM 364.952, OM 364.954	4.0	1987.07 - 1992.12		4105.83D
O 614 D	OM 364.980, OM 364.981	4.0	1987.07 - 1992.12		4105.83D

VANEO (414)

1.4	M 166.940	1.4	2002.06 - 2005.07		411576.87D ▲
1.6	M 166.961	1.6	2002.02 - 2005.07		411576.87D ▲
1.9	M 166.991	1.9	2002.02 - 2005.07		411576.87D ▲

VARIO

512 D	OM 602.984	2.9	1996.09 -		4176.85D
612 D	OM 602.985, OM 602.984	2.9	1996.09 -		4176.85D
613 D, 614 D	OM 904.908, OM 904.917	4.2	1996.09 -		4105.83D
615 D, 616 D	OM 900.918, OM 904.923	4.2	1998.09 -		4105.83D
618 D	OM 900.919, OM 904.964	4.2	2006.09 -		4105.83D
810 DT	OM 904.904	4.2	1996.09 -		4105.83D
812 D	OM 602.985, OM 602.984	2.9	1996.09 -		4176.85D
813 D, 814 D	OM 900.917, OM 904.908	4.2	1996.09 -		4105.83D
814 DT	OM 904.908	4.2	1996.09 -		4105.83D
815 D, 816 D	OM 900.918, OM 904.923	4.2	1996.09 -		4105.83D
816 DT	OM 904.923	4.2	1996.09 -		4105.83D
818 D	OM 900.919, OM 904.964	4.2	2006.09 -		4105.83D
O 810	OM 904.904	4.2	1996.09 -		4105.83D
O 812	OM 602.985, OM 602.984	2.9	1996.09 -		4176.85D
O 814	OM 904.908	4.2	1996.09 -		4105.83D
O 815	OM 904.923	4.2	1996.09 -		4105.83D

VIANO (639)

3.0	M 112.951	3.2	2003.09 -		4281.87D
3.2	M 112.951	3.2	2003.09 -		4281.87D
3.5	M 272.979	3.5	2007.09 -		4833.100D
3.7	M 112.976	3.7	2004.06 -		4281.87D
CDI 2.0	OM 646.982	2.1	2003.09 -	ohne Gewinde	410171.87D
CDI 2.0	OM 646.982	2.1	2003.09 -	mit Gewinde	411433.87D ▲
CDI 2.2	OM 646.982	2.1	2003.09 -	ohne Gewinde	410171.87D
CDI 2.2	OM 646.982	2.1	2003.09 -	mit Gewinde	411433.87D ▲
CDI 3.0	OM 642.990	3.0	2006.03 -		4832.87D ▲

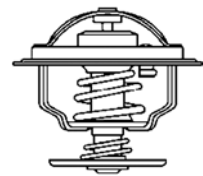
MERCEDES-BENZ

	Motor Engine Moteur	Ltr. Ltr. Ltr.	Jahr Year Année	Einschränkung Restriction* Restriction*	Thermostat Thermostat Thermostat
VITO (638)					
108 CDI 2.2	OM 611A (60 KW CDI)	2.2	1999.03 - 2003.07	ohne Gewinde	410171.87D
108 CDI 2.2	OM 611A (60 KW CDI)	2.1	1999.03 - 2003.07	ohne Gewinde	410171.87D
108 CDI 2.2	OM 611A (60 KW CDI)	2.2	1999.03 - 2003.07	mit Gewinde	411433.87D ▲
108 CDI 2.2	OM 611A (60 KW CDI)	2.1	1999.03 - 2003.07	mit Gewinde	411433.87D ▲
110 CDI 2.2	OM 611LA (75 KW CDI)	2.1	1999.03 - 2003.07	ohne Gewinde	410171.87D
110 CDI 2.2	OM 611LA (75 KW CDI)	2.2	1999.03 - 2003.07	ohne Gewinde	410171.87D
110 CDI 2.2	OM 611LA (75 KW CDI)	2.2	1999.03 - 2003.07	mit Gewinde	411433.87D ▲
110 CDI 2.2	OM 611LA (75 KW CDI)	2.1	1999.03 - 2003.07	mit Gewinde	411433.87D ▲
112 CDI 2.2	OM 611.980	2.2	1999.03 - 2003.07	ohne Gewinde	410171.87D
112 CDI 2.2	OM 611.980	2.2	1999.03 - 2003.07	mit Gewinde	411433.87D ▲
113 2.0	M 111.948, M 111.950	2.0	1996.02 - 2003.07		4279.87D
114 2.3	M 111.978	2.3	1996.12 - 2003.07		4279.87D
VITO (639)					
109 CDI	OM 646.980, OM 646.981, OM 646.983	2.1	2006.09 -	ohne Gewinde	410171.87D
109 CDI	OM 646.980, OM 646.981, OM 646.983	2.1	2006.09 -	mit Gewinde	411433.87D ▲
111 CDI	OM 646.982	2.1	2003.09 -	ohne Gewinde	410171.87D
111 CDI	OM 646.982	2.1	2003.09 -	mit Gewinde	411433.87D ▲
115 CDI	OM 646.982	2.1	2003.09 -	ohne Gewinde	410171.87D
115 CDI	OM 646.982	2.1	2003.09 -	mit Gewinde	411433.87D ▲
119	M 112.951	3.2	2003.09 -		4281.87D
120 CDI	OM 642.990	3.0	2006.07 -		4832.87D ▲
122	M 112.951	3.2	2003.09 -		4281.87D
123	M 112.976	3.7	2004.06 - 2008.07		4281.87D
126	M 272.978	3.5	2007.09 -		4833.100D
V-Klasse (638)					
V 200	M 111.948, M 111.950	2.0	1997.02 - 2003.07		4279.87D
V 200 CDI	OM 611.980	2.2	1999.03 - 2003.07	ohne Gewinde	410171.87D
V 200 CDI	OM 611.980	2.2	1999.03 - 2003.07	mit Gewinde	411433.87D ▲
V 220 CDI	OM 611.980	2.2	1999.03 - 2003.07	ohne Gewinde	410171.87D
V 220 CDI	OM 611.980	2.2	1999.03 - 2003.07	mit Gewinde	411433.87D ▲
V 230	M 111.978	2.3	1996.10 - 2003.07		4279.87D
V 280	M 104.900	2.8	1997.08 - 2003.07		4123.80D

MG	Motor Engine Moteur	Ltr. Ltr. Ltr.	Jahr Year Année	Einschränkung Restriction* Restriction*	Thermostat Thermostat Thermostat
EXPRESS					
1.4	14 K4F	1.4	2003.03 - 2005.05		410808.88D
1.8	18 K4F	1.8	2003.03 - 2005.05		410808.88D
MG TF					
115	16 K4F	1.6	2002.03 -		410808.88D
120	18 K4F	1.8	2002.03 -		410808.88D
135	18 K4F	1.8	2002.03 -		410808.88D
160	18 K4K	1.8	2002.03 -		410808.88D
MG ZR					
105	14 K4F	1.4	2001.06 - 2005.04		410808.88D
120	18 K4F	1.8	2001.06 - 2005.04		410808.88D
160	18 K4K	1.8	2001.06 - 2005.04		410808.88D
MG ZS Hatchback					
120	18 K4F	1.8	2001.07 - 2005.10		410808.88D
MG ZT					
1.8 16V	18 K4F	1.8	2003.01 - 2005.07		410808.88D
1.8 T 16V	18 K4G	1.8	2003.01 - 2005.07		410806.88D
MG ZT- T					
1.8 16V	18 K4F	1.8	2003.01 - 2005.07		410808.88D
1.8 T 16V	18 K4G	1.8	2003.01 - 2005.07		410806.88D
MGB Cabriolet					
1.8		1.8	1966.01 - 1980.12		3004.82
MGB GT					
1.8		1.8	1966.01 - 1980.11		3004.82
MGF (RD)					
1.6	16 K4F	1.6	2000.02 - 2002.03		410808.88D
1.8 i 16V	18 K4F	1.8	1995.03 - 2002.03		410808.88D
1.8 i VVC	18 K4K	1.8	1995.03 - 2002.03		410808.88D



MINI

	Motor Engine Moteur	Ltr. Ltr. Ltr.	Jahr Year Année	Einschränkung Restriction* Restriction*	Thermostat Thermostat Thermostat
MINI (R50, R53)					
1.4		1.4	2003.04 - 2006.09		410263.91D
Cooper	W10 B16 A	1.6	2001.06 - 2006.09		410263.91D
Cooper S	W11 B16 A	1.6	2002.03 - 2006.09		410263.91D
One	W10 B16 A	1.6	2001.06 - 2006.09		410263.91D
One D	1ND-TV	1.4	2003.06 - 2006.09		410231.82D
Works	W11 B16 A	1.6	2003.11 - 2006.09		410263.91D
MINI Cabriolet (R52)					
Cooper	W10 B16 A	1.6	2004.07 - 2007.11		410263.91D
Cooper S	W11 B16 A	1.6	2004.07 - 2007.11		410263.91D
John Cooper Works	W11 B16 A	1.6	2004.07 - 2007.11		410263.91D
One	W10 B16 A	1.6	2004.07 - 2007.11		410263.91D

MITSUBISHI

 Motor
Engine
Moteur

 Ltr.
Ltr.
Ltr.

 Jahr
Year
Année

 Einschränkung
Restriction*
Restriction*

 Thermostat
Thermostat
Thermostat

CARISMA (DA_)

1.6	4G92	1.6	1995.07 - 2006.06		4637.82D
1.8	4G93	1.8	1995.07 - 2005.06		4637.82D
1.8 16V	4G93	1.8	1995.07 - 2006.06		4637.82D
1.8 16V GDI	4G93 (GDI)	1.8	1997.09 - 2006.06		4637.82D
1.8 GDI	4G93 (GDI)	1.8	2000.10 - 2006.06		4637.82D
1.9 DI-D	F9Q1, F9Q2	1.9	2000.09 - 2006.06		3470.89D50
1.9 TD	F8QT	1.9	1996.10 - 2000.09		3470.89D50

COLT I (A15_A)

1.2	4G11	1.2	1978.12 - 1984.01		3119.82D4
1.4	4G12	1.4	1979.05 - 1984.01		3119.82D4
1.4 Turbo	4G12 T	1.4	1981.09 - 1984.01		3119.82D4

COLT II (C1_A)

1.2	4G16	1.2	1984.02 - 1988.04		3119.88D4
1.3	G13B	1.3	1985.06 - 1988.04		3119.88D4
1.5	4G15	1.5	1984.09 - 1988.04		3119.82D4
1.5	G15B	1.5	1985.09 - 1988.04		3119.82D4
1.6 Turbo ECi	4G32 T, C	1.6	1984.02 - 1988.04		3119.88D4
1.6 Turbo ECi	G32BT	1.6	1986.07 - 1988.04		3119.88D4

COLT III (C5_A)

1.3	4G13 (8V)	1.3	1988.04 - 1990.12		3119.82D4
1.3 12V	4G13 (12V)	1.3	1988.04 - 1992.05		3119.82D4
1.5	4G15 (12V)	1.5	1990.07 - 1992.05		3119.82D4
1.6 GTi 16V	4G61	1.6	1988.04 - 1990.05		3119.82D4
1.8 Diesel	4D65	1.8	1988.04 - 1992.05		3119.82D4
1.8 GTi 16V	4G67	1.8	1990.06 - 1992.05		3119.82D4

COLT IV (CA_A)

1.3 12V	4G13 (12V)	1.3	1992.04 - 1996.04		3119.82D4
1.6	4G92	1.6	1993.08 - 1996.04		4637.82D
1.6 16V	4G92	1.6	1992.04 - 1996.04		4637.82D
1.8 GTi 16V	4G93	1.8	1992.04 - 1996.04		4637.82D

COLT LANCER (A7_)

1.2	4G36	1.2	1978.01 - 1979.09		3119.82D4
1.4	4G33	1.4	1978.01 - 1979.09		3119.82D4
1.6	4G32 GS	1.6	1978.01 - 1979.09		3119.82D4

COLT V (CJ_, CP)

1.3	4G19	1.3	2002.08 - 2003.09		4637.82D
1300	4G13 (12V)	1.3	1996.05 - 2000.09		4637.82D
1500	4G15 (16V)	1.5	1995.11 - 2003.09		4637.76D
1600	4G92	1.6	1996.05 - 2003.09		4637.82D

COLT VI (Z_)

1.5	4G15T	1.5	2005.03 - 2012.06		4637.82D
-----	-------	-----	-------------------	--	----------

COLT CZC Cabriolet (RG)

1.5	4A91	1.5	2006.05 - 2009.07		4637.82D
1.5 Turbo	4G15T	1.5	2006.05 - 2009.07		4637.82D

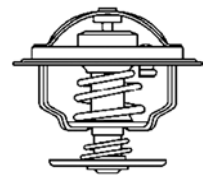

MITSUBISHI

	Motor Engine Moteur	Ltr. Ltr. Ltr.	Jahr Year Année	Einschränkung Restriction* Restriction*	Thermostat Thermostat Thermostat
CORDIA (A21_)					
1.6	4G32	1.6	1982.10 - 1986.12		3119.82D4
1.6 Turbo	4G32 T	1.6	1982.10 - 1985.05		3119.82D4
1.8	4G37	1.8	1986.10 - 1986.12		3119.82D4
1.8 Turbo ECi	4G62 T	1.8	1984.10 - 1986.12		3119.82D4
ECLIPSE I (D2_A)					
2.0 i 16V	4G63 (DOHC 16V)	2.0	1991.04 - 1995.11		3119.82D4
ECLIPSE II (D3_A)					
2.0 Turbo	4G63 T (DOHC 16V)	2.0	1994.04 - 1999.04		4637.82D
2000 GT 16V		2.0	1995.12 - 1999.04		4637.82D
ECLIPSE III (D5_A)					
2.4	4G64 (SOHC 16V)	2.4	1999.05 - 2005.03		4637.82D
2.4 RS	4G64 (SOHC 16V)	2.4	1999.05 - 2005.03		4637.82D
3.0	6G72 (DOHC 24V)	3.0	1999.05 - 2005.03		410180.82D
FTO Coupe (DE_A)					
1.8	4G93	1.8	1994.09 - 2001.07		4637.82D
GALANT II (A16_)					
1.6	4G32	1.6	1980.09 - 1984.05		3119.82D4
2.0	4G63 (SOHC 8V)	2.0	1980.09 - 1984.05		3119.82D4
2.0 Turbo	4G63 T (ECI)	2.0	1982.05 - 1984.05		3119.82D4
GALANT III (E1_A)					
1.6 GLX	4G32	1.6	1984.06 - 1990.04		3119.82D4
1.8 Turbo-D (E14A)	4D65 T	1.8	1984.06 - 1990.04		4038.81D
2.0 GLS	4G63 (SOHC 8V)	2.0	1984.06 - 1990.04		3119.82D4
2.0 GLS	G63B	2.0	1985.06 - 1990.04		3119.82D4
2.0 Turbo ECi (E15A)	4G63 T (SOHC 8V)	2.0	1984.06 - 1990.04		3119.88D4
2.4 GLS (E16A)	G64B	2.4	1985.07 - 1990.04		3119.88D4
GALANT IV (E3_A)					
1.6	4G32, 4G37	1.6	1987.11 - 1992.10		3119.82D4
1.8 Turbo-D (E34A)	4D65 T	1.8	1987.12 - 1992.10		3119.82D4
2.0	4G63 (SOHC 8V)	2.0	1987.11 - 1992.10		3119.82D4
2.0 GTi 16V	4G63 (DOHC 16V)	2.0	1987.11 - 1992.12		3119.82D4
GALANT V (E5_A, E7_A, E8_A)					
1.8	4G93 (GDI)	1.8	1992.11 - 1996.08		4637.82D
1.8	4G93	1.8	1994.02 - 1996.08		4637.82D
2.0	4G63 (SOHC 8V)	2.0	1992.11 - 1996.08		4637.82D
2.0 GLSTD	4D68 T	2.0	1992.11 - 1996.08		4637.82D
2.0 V6-24	6A12	2.0	1992.11 - 1996.08		4637.82D
2.5	6G73	2.5	1992.11 - 1996.09		410180.82D
2.5 V6-24	6G73	2.5	1992.11 - 1996.08		410180.82D
GALANT VI (EA_)					
1.8 GDi	4G93 (GDI)	1.8	1997.11 - 2001.10		4637.82D
2.0	4G63 (SOHC 16V)	2.0	1996.09 - 2004.10		4637.82D

MITSUBISHI

 Motor
Engine
Moteur

 Ltr.
Ltr.
Ltr.

 Jahr
Year
Année

 Einschränkung
Restriction*
Restriction*

 Thermostat
Thermostat
Thermostat

2.0 GDi	4G94 (GDI)	2.0	1999.10 - 2004.10		4637.82D
2.0 TDI	4D68 (SOHC), 4D68 T	2.0	1996.09 - 2004.10		4637.82D
2.4	4G69	2.4	2003.10 - 2004.10		4637.82D
2.4 GDI	4G64 (GDI)	2.4	1999.02 - 2004.10		4637.82D
2.5 Type S		2.5	1999.10 - 2004.10		4637.82D
2.5 V6 24V	6A13, 6A13TT	2.5	1996.09 - 2004.10		4637.82D

GALANT

2.0 GDi G	4G94 (GDI)	2.0	2003.10 -		4637.82D
2.4	4G69	2.4	2003.10 -		4637.82D
2.4 GDi Sport	4G69	2.4	2003.10 -		4637.82D

GRANDIS

2.0 DI-D	BSY, BWC	2.0	2005.09 -		3472.87D
2.4	4G69	2.4	2004.04 -		4637.82D

L 200 (K__T)

2.0	4G63 (SOHC 8V)	2.0	1996.06 - 2007.12		4637.82D
2.4	4G64 (SOHC 16V)	2.4	1996.06 - 2007.12		4637.82D
2.4 i	4G64 (SOHC 16V)	2.4	1996.10 - 2006.12		4637.82D
2.5 D	4D56	2.5	1986.10 - 2007.12		4638.76D
2.5 TD	4D56 TD	2.5	1990.09 - 2007.12	55 mm Ø	4637.82D
2.5 TD	4D56 TD	2.5	1990.09 - 2007.12	54 mm Ø	4638.82D

L 200 (KB_T, KA_T)

2.4 CNG	4G64 (SOHC 16V)	2.4	2010.04 -		4637.82D
2.4 i	4G64 (SOHC 16V)	2.4	2005.11 -		4637.82D

L 300 (LO3_P/G, LO_2P)

1.6	4G32	1.6	1980.05 - 1987.02		3119.82D4
2.3 D	4D55	2.3	1983.04 - 1986.10		4038.81D
2.5 D	4D56 (8V)	2.5	1986.11 - 1994.04		4638.82D

L 300 (P0_W, P1_W, P1_T, P2_W)

1.6 (P02V, P12V)	4G32	1.6	1986.11 - 1994.05		3119.82D4
2.0	4G63 (SOHC 8V)	2.0	1986.11 -		3119.82D4
2.0	4G63 (DOHC 16V)	2.0	1994.07 - 2000.04		4637.82D
2.0 (P03V, P13V)	G63B	2.0	1986.11 - 1994.05		3119.82D4
2.0 (P03V, P13V)	G63B	2.0	1994.06 -		4637.82D
2.4 (P04W, P14V, P04V)	4G64 (12V)	2.4	1990.11 -		3119.82D4
2.5 D	4D56 (8V)	2.5	1986.11 - 2006.02		4638.82D
2.5 TD	4D56 T	2.5	1988.11 - 2003.05	76° Variante	4638.76D
2.5 TD	4D56 T	2.5	1991.11 - 2003.05	82° Variante	4638.82D

L 400 / Space Gear (PA, PB, PC, PD)

2.0	4G63 (DOHC 16V)	2.0	1995.09 - 2002.10		4637.82D
2.0	4G63 (SOHC 8V)	2.0	1996.06 - 2001.03		4637.82D
2.0 16V	4G63 (DOHC 16V)	2.0	1995.05 - 2000.05		4637.82D
2.4	4G64 (SOHC 16V)	2.4	1995.05 - 2002.10		4637.82D
2.4 i	4G64 (SOHC 16V)	2.4	1995.05 - 2000.05		4637.82D
2.5 TD	4D56 TD	2.5	1995.05 - 2000.05		4638.82D
2500 TD	4D56 T	2.5	1995.05 - 2005.06	55 mm Ø	4637.82D
2500 TD	4D56 T	2.5	1996.09 - 2005.06	54 mm Ø	4638.82D

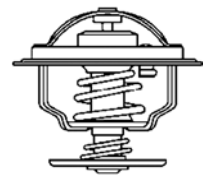
MITSUBISHI

	Motor Engine Moteur	Ltr. Ltr. Ltr.	Jahr Year Année	Einschränkung Restriction* Restriction*	Thermostat Thermostat Thermostat
LANCER I / F II (A17_)					
1.2	4G11, 4G12	1.2	1979.09 - 1984.01		3119.82D4
1.4	4G12	1.4	1983.03 - 1984.01		3119.82D4
1.4 Turbo	4G12 T	1.4	1983.03 - 1984.01		3119.82D4
1.6	4G32 GS	1.6	1979.09 - 1983.02		3119.82D4
2.0 Turbo ECi	4G32 T (ECi)	2.0	1981.03 - 1983.02		3119.82D4
LANCER III (C1, C3, C6)					
1.2	4G16	1.2	1983.01 - 1988.04		3119.82D4
1.3	G13B	1.3	1988.05 - 1990.06		3119.88D4
1.3	4G13 (12V)	1.3	1990.07 - 1992.08		3119.88D4
1.5	4G15	1.5	1983.11 - 1990.12	82° Variante	3119.82D4
1.5	G15B	1.5	1985.06 - 1988.04	82° Variante	3119.82D4
1.5	G15B	1.5	1985.09 - 1989.08	88° Variante	3119.88D4
1.5	4G15 (12V)	1.5	1989.08 - 1992.08	88° Variante	3119.88D4
1.5 12V	4G15 (12V)	1.5	1990.09 - 1991.12		3119.82D4
1.8	4G37	1.8	1987.01 - 1992.06		3119.82D4
1.8	G37B	1.8	1987.01 - 1989.08		3119.88D4
1.8 D	4D65	1.8	1983.01 - 1992.06		3119.88D4
LANCER IV (C6, C7)					
1.2	4G16	1.2	1988.05 - 1992.08		3119.82D4
1.3	G13B, 4G13 (8V)	1.3	1988.05 - 1992.05		3119.82D4
1.3 12V	4G13 (12V)	1.3	1990.07 - 1994.05		3119.82D4
1.5	4G15	1.5	1988.04 - 1992.05		3119.82D4
1.5 12V	4G15 (12V)	1.5	1989.05 - 1992.05		3119.82D4
1.6	4G92	1.6	1992.06 - 1993.11		4637.76D
1.6 16V	4G92	1.6	1992.06 - 1994.05		3119.82D4
1.6 GLX	4G61	1.6	1989.08 - 1992.08		3119.82D4
1.6 GTi	4G61	1.6	1988.05 - 1990.05		3119.82D4
1.8	4G37	1.8	1989.09 - 1992.06		3119.82D4
1.8 Diesel	4D65	1.8	1988.04 - 1992.05		3119.82D4
1.8 GTi	4G37	1.8	1992.06 - 1993.07		3119.82D4
1.8 GTi 16V	4G67	1.8	1989.11 - 1993.12		3119.82D4
2.0 D	4D68	2.0	1992.06 - 1993.07		4637.76D
LANCER V (CB, CD)					
1.3	4G13 (12V)	1.3	1992.06 - 1996.12		3119.88D4
1.5	4G15 (12V)	1.5	1992.09 - 1996.07		3119.88D4
1.6	4G92	1.6	1994.02 - 1996.12		4637.82D
1.6 16V	4G92	1.6	1992.06 - 2003.10	76° Variante	4637.76D
1.6 16V	4G92	1.6	1992.12 - 2003.10	82° Variante	4637.82D
1.8	4G93	1.8	1995.03 - 2003.10		4637.82D
1.8 16V	4G93	1.8	1992.06 - 1993.12		4637.82D
1.8 i	4G93	1.8	1995.03 - 2003.10		4637.82D
2.0 D	4D68	2.0	1992.12 - 2003.10		4637.76D
2.0 D	4D68 T	2.0	1995.03 - 2003.10		4637.82D
2.0 Diesel	4D68	2.0	1992.06 - 1996.12		4637.82D
2.0 EVO I (CD9A)	4G63 Turbo	2.0	1992.10 - 1993.12		4637.82D
2.0 EVO II (CE9A)	4G63 Turbo	2.0	1994.01 - 1995.07		4637.82D
2.0 EVO III (CE9A)	4G63 Turbo	2.0	1995.08 - 1996.07		4637.82D
LANCER VI (CJ-CP_)					
1.3 12V	4G13 (12V)	1.3	1995.12 - 2003.08		4637.82D
1.5 16V	4G15 (16V)	1.5	1995.12 - 2003.08		4637.76D

MITSUBISHI

 Motor
Engine
Moteur

 Ltr.
Ltr.
Ltr.

 Jahr
Year
Année

 Einschränkung
Restriction*
Restriction*

 Thermostat
Thermostat
Thermostat

1.6 16V	4G92	1.6	1995.12 - 2003.08		4637.82D
1.8	4G93	1.8	1995.09 - 2003.08		4637.76D
1.8 16V	4G93T	1.8	1995.09 - 2003.08		4637.76D
2.0 16V EVO	4G63 Turbo	2.0	1996.08 - 2003.08		4637.82D
LANCER (CS)					
2.0	4G63 (DOHC 16V)	2.0	2003.09 - 2007.12		4637.82D
LANCER (CY/Z_A)					
2.0 DI-D	BKD, BWC	2.0	2008.01 -		3472.87D
MIRAGE					
1.2	4G16	1.2	1983.10 - 1988.01		3119.82D4
1.3	4G13 (12V)	1.3	1991.12 - 2003.07		4637.82D
1.5	4G15 (12V)	1.5	1991.12 - 1999.08		4637.82D
1.6	4G92	1.6	1991.12 - 2003.07		4637.82D
1.6		1.6	1995.09 - 1999.08		4637.82D
1.8	6A11	1.8	1991.12 - 2002.08		4637.82D
1.8	4G93	1.8	2001.08 - 2003.07		4637.82D
LANCER SPORTBACK (CX_A)					
2.0 DI-D	BKD, BWC	2.0	2008.06 -		3472.87D
OUTLANDER I (CU_)					
2.0	4G63 (DOHC 16V)	2.0	2003.05 - 2006.10		4637.82D
2.0	4G63 T (DOHC 16V)	2.0	2004.04 - 2006.10		4637.82D
2.4	4G64 (SOHC 16V), 4G69	2.4	2003.05 - 2006.10		4637.82D
2.4 GDI	4G64 (GDI)	2.4	2005.01 - 2006.12		4637.82D
2.4 HDD	4G69	2.4	2003.07 - 2006.09		4637.82D
OUTLANDER II (CW_W)					
2.0 DI-D	BSY	2.0	2006.12 -		3478.82D
3.0	6B31	3.0	2006.11 -		410180.82D
PAJERO I (L04_G, L14_G)					
2.5 TD	4D56 T	2.5	1986.05 - 1991.12		4638.76D
2.6	4G54	2.6	1983.01 - 1990.11		3119.88D4
3.0 V6	6G72 (SOHC 12V)	3.0	1988.11 - 1990.11		3119.88D4
PAJERO II (V2_W, V3_W, V4_W)					
1.8 GDI	4G93 (GDI)	1.8	1998.06 - 2000.04		4637.82D
2.4	4G64 (12V)	2.4	1991.04 - 2000.04		3119.88D4
2.5 TD	4D56 TD	2.5	1990.12 - 2000.04		4637.82D
2.8 TD	4M40-T	2.8	1994.06 - 1999.10		4637.76D
3.0 V6	6G72 (SOHC 12V)	3.0	1990.12 - 1995.12		3119.88D4
3.0 V6 24V	6G72 (SOHC 24V)	3.0	1994.06 - 2000.04		410180.82D
3.5 V6 24V	6G74 (DOHC 24V), 6G74 (SOHC 24V)	3.5	1994.06 - 1999.10		410180.82D

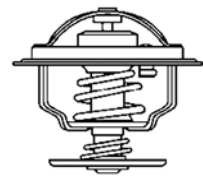
MITSUBISHI

	Motor Engine Moteur	Ltr. Ltr. Ltr.	Jahr Year Année	Einschränkung Restriction* Restriction*	Thermostat Thermostat Thermostat
PAJERO III (V6_W, V7_W)					
2.5 TDi	4D56 T	2.5	2000.04 - 2006.12		4637.82D
3.2 DI-D	4M41	3.2	2000.04 - 2006.12		4637.76D
3.5 V6 GDI	6G74 (DOHC 24V), 6G74 (SOHC 24V)	3.5	2000.04 - 2006.12		410180.82D
PAJERO IV (V8_W, V9_W)					
3.8 V6	6G75	3.8	2007.02 - 2008.07		410180.82D
PAJERO CLASSIC (V2_W)					
2.5 TD	4D56 T	2.5	2002.07 -		4637.82D
3.2 DI-D	4M41	3.2	2005.05 -		4637.76D
PAJERO PININ (H6_W, H7_W)					
1.8	4G93	1.8	2001.11 - 2007.06		4637.82D
1.8 GDI	4G93 (GDI)	1.8	1999.10 - 2007.06		4637.82D
2.0 GDI	4G94 (GDI)	2.0	2000.10 - 2007.06		4637.82D
PAJERO SPORT (K90)					
2.5 TD	4D56 T	2.5	1997.11 - 2008.01		4637.82D
PROUDIA / DIGNITY					
3.5	6G74 (DOHC 24V)	3.5	1999.10 - 2001.05		410180.82D
4.5	8A80	5.0	1999.10 - 2001.05		410180.82D
SANTAMO					
2.0 16V	4G63 (DOHC 16V)	2.0	1999.05 - 2004.12		4637.82D
SAPPORO I (A12_)					
1.6	4G32	1.6	1978.04 - 1980.07		3119.82D4
2.0	4G52	2.0	1978.04 - 1980.07		3119.82D4
SAPPORO II (A16_A)					
1.6	4G32	1.6	1980.08 - 1984.09		3119.82D4
2.0	4G63 (SOHC 8V)	2.0	1980.08 - 1984.09		3119.82D4
2.0	4G63 (SOHC 8V)	2.0	1980.08 - 1983.08		3119.82D4
2.0 Turbo ECi	4G63 T (ECi)	2.0	1982.08 - 1983.08		3119.82D4
SAPPORO III (E16A)					
2.4	4G64 (8V)	2.4	1987.06 - 1990.08		3119.82D4
SIGMA (F0_W, F1_A, F2_A)					
3.0	6G72 (SOHC 12V)	3.0	1992.06 - 1996.10		410180.82D
3.0 V6	6G72 (SOHC 12V)	3.0	1990.12 - 1996.07		410180.82D
3.0 V6	6G72 (DOHC 24V)	3.0	1990.12 - 1996.07		410180.82D
SPACE RUNNER (N1_W, N2_W)					
1.8	4G93	1.8	1991.10 - 1999.08		4637.82D
2.0 16V	4G63 (DOHC 16V)	2.0	1997.06 - 1999.08		4637.82D
2.0 TD	4D68 T	2.0	1992.10 - 1999.08		4637.82D

MITSUBISHI

 Motor
Engine
Moteur

 Ltr.
Ltr.
Ltr.

 Jahr
Year
Année

 Einschränkung
Restriction*
Restriction*

 Thermostat
Thermostat
Thermostat

SPACE RUNNER (N6_W)

2.0	4G63 (DOHC 16V)	2.0	1999.08 - 2002.08		4637.82D
2.4 GDI	4G64 (GDI)	2.4	1999.08 - 2002.08		4637.82D

SPACE STAR (DG_A)

1.6	4G92	1.6	2001.04 - 2004.12		4637.82D
1.8 GDI	4G93 (GDI)	1.8	1998.06 - 2004.12		4637.82D
1.8 MPI	4G93	1.8	2002.10 - 2004.12		4637.82D
1.9 DI-D	F9Q1	1.9	2001.02 - 2004.12		3470.89D50
1.9 DI-D	F9Q2	1.9	2002.10 - 2004.12		3470.89D50

SPACE WAGON (D0_V/W)

1.8	4G37	1.8	1983.01 - 1988.12		3119.82D4
2.0	4G63 (SOHC 8V)	2.0	1985.03 - 1991.04		3119.82D4
2.0	G63B	2.0	1985.06 - 1988.05		3119.82D4

SPACE WAGON (N3_W, N4_W)

1.8	4G93	1.8	1991.10 - 1998.10		4637.82D
2.0	4G63 (SOHC 8V)	2.0	1991.05 - 1997.10		4637.82D
2.0	4G63 (DOHC 16V)	2.0	1992.10 - 1998.10		4637.82D
2.0 TD	4D68 T	2.0	1992.10 - 1998.10		4637.82D
2.4 i	4G64 (SOHC 16V)	2.4	1992.10 - 1998.10		4637.82D

SPACE WAGON (N9_W, N8_W)

2.0 GDI	4G63 (SOHC 16V)	2.0	1998.10 - 2004.12		4637.82D
2.4 GDI	4G64 (GDI)	2.4	1998.10 - 2004.12		4637.82D

STARION (A18_A)

2.0 Turbo	4G63 T (ECI)	2.0	1982.06 - 1985.12		3119.82D4
2.0 Turbo	4G63 T, C	2.0	1985.05 - 1987.08		3119.82D4
2.6 Turbo ECi	G54B T, C	2.6	1987.09 - 1990.06		3119.82D4

TREDIA (A21_)

1.4 GLX	4G12	1.4	1982.10 - 1985.08		3119.82D4
1.6 GLS	4G32	1.6	1982.09 - 1987.10		3119.82D4
1.6 Turbo	4G32 T	1.6	1982.09 - 1985.05		3119.82D4



NISSAN

	Motor Engine Moteur	Ltr. Ltr. Ltr.	Jahr Year Année	Einschränkung Restriction* Restriction*	Thermostat Thermostat Thermostat
100 NX (B13)					
1.6	GA16DS	1.6	1990.03 - 1994.10		4634.76
1.6 SR	GA16DE	1.6	1993.09 - 1994.10		3478.82D
2.0	SR20DE	2.0	1990.10 - 1994.10		4635.76
2.0 GTI	SR20DE	2.0	1991.03 - 1994.10		4635.76
200 SX (S13)					
1.8	CA18DE	1.8	1988.09 - 1994.03		3118.82D1
1.8 Turbo	CA18DET	1.8	1988.07 - 1993.11		3118.82D1
1.8 Turbo	CA18DT	1.8	1992.01 - 1994.09		3118.82D1
2.0 i 16V	SR20DE	2.0	1988.07 - 1993.11		4635.76
200 SX (S14)					
2.0 i 16V	SR20DE	2.0	1993.10 - 1999.12		4635.76
2.0 i 16V Turbo	SR20DET	2.0	1993.10 - 1999.12		4635.76
280 ZX,ZXT (HGS130)					
2.8	L28E	2.8	1978.10 - 1984.02		3118.88D1
2.8	L28ET	2.8	1983.01 - 1984.02		3118.88D1
AD Wagon					
1.5	QG15DE	1.5	1999.05 - 2004.08		3478.82D
1.6	GA16DS	1.6	1990.10 - 1999.04		3478.82D
1.6	GA16DE	1.6	1999.05 - 2004.08		3478.82D
1.8	QG18DE	1.8	1999.05 - 2004.08		3478.82D
ALMERA I (N15)					
1.4	GA14DE	1.4	1995.09 - 2000.07		3478.82D
1.5	GA15DE	1.5	1995.07 - 2000.05		3478.82D
1.6	GA16DE	1.6	1995.07 - 2000.07		3478.82D
2.0 D	CD20	2.0	1995.11 - 2000.07		410176.82D0
2.0 GTi	SR20DE	2.0	1996.07 - 2000.03		4635.76
ALMERA II (N16)					
1.5	QG15DE	1.5	2000.03 -		3478.82D
1.5 dCi	K9K 722	1.5	2003.01 -		411043.89D
1.6	GA16DE, QG16DE	1.6	2000.07 - 2003.02		3478.82D
1.8	QG18DE	1.8	2000.01 -		3478.82D
ALMERA TINO (V10)					
1.8	QG18DE	1.8	2000.08 -		3478.82D
2.0	SR20DE	2.0	2000.08 -		3478.82D
BLUEBIRD (910)					
1.6	L16	1.6	1980.01 - 1983.11		3118.88D1
1.8	L18S, L18T	1.8	1980.01 - 1984.05		3118.88D1
1.9 i	Z20E	1.9	1982.01 - 1984.05		3118.88D1
2.0	L20B	2.0	1981.05 - 1985.03		3118.82D1
2.0 D	LD20	2.0	1980.01 - 1984.05		4022.82D
2.0 i	Z20E	2.0	1982.01 - 1983.12		3118.88D1

NISSAN
**Motor
Engine
Moteur**
**Ltr.
Ltr.
Ltr.**
**Jahr
Year
Année**
**Einschränkung
Restriction*
Restriction***
**Thermostat
Thermostat
Thermostat**
BLUEBIRD (T72 , T12)

1.6	CA16S	1.6	1986.03 - 1991.06		3118.88D1
1.8		1.8	1986.05 - 1992.11		3118.88D1
1.8 i 16V	CA18D	1.8	1989.02 - 1990.12		3118.88D1
1.8 Turbo	CA18T	1.8	1985.12 - 1992.11		3118.88D1
2.0	CA20S	2.0	1985.12 - 1990.02		3118.82D1
2.0 D	LD20	2.0	1986.03 - 1990.12		4022.82D
2.0 i	CA20E	2.0	1985.12 - 1990.12		3118.88D1

BLUEBIRD (U11)

1.6	CA16S	1.6	1985.12 - 1990.02		3118.82D1
1.8	CA18N, CA18S	1.8	1983.11 - 1990.04		3118.82D1
1.8 Turbo	CA18ET, CA18T	1.8	1984.04 - 1990.05	82° Variante	3118.82D1
1.8 Turbo	CA18ET, CA18T	1.8	1984.04 - 1990.05	88° Variante	3118.88D1
2.0	CA20S	2.0	1985.12 - 1990.09		3118.88D1
2.0 D	LD20	2.0	1984.04 - 1990.12		4022.82D
2.0 i	CA20E	2.0	1984.04 - 1990.12		3118.88D1

CHERRY (E10, N10)

1.0	A10	1.0	1970.09 - 1981.07		3118.82D1
1.0	A10S	1.0	1978.08 - 1981.07		3044.90D1
1.0	E10	1.0	1981.08 - 1982.05		3044.90D1
1.2	A12	1.2	1978.08 - 1981.07		3118.82D1
1.3	E13	1.3	1981.08 - 1983.12		3118.82D1
1.4	A14, A14S	1.4	1978.08 - 1981.07		3118.82D1
1.4 i.e.	A14S	1.4	1980.08 - 1981.07		3118.82D1
1.5	E15	1.5	1981.08 - 1982.12		3118.82D1

CHERRY III (N12)

1.0	E10	1.0	1982.05 - 1986.05		3044.90D1
1.3	E13	1.3	1982.05 - 1986.10		3118.82D1
1.5	E15S	1.5	1983.11 - 1986.10		3118.82D1
1.5 ET Turbo	E15ET	1.5	1983.01 - 1985.12		3118.82D1
1.6	E16	1.6	1984.05 - 1986.07		3118.82D1
1.7 D	CD17	1.7	1982.10 - 1986.12		3118.82D1

CUBE (Z11)

1.5	QG15DE	1.5	2003.01 - 2005.09		3478.82D
-----	--------	-----	-------------------	--	----------

CUBE (Z12)

1.5 dCi		1.5	2010.03 -		411442.83D ▲
1.6 16V	HR16DE	1.6	2010.03 -		411241.82D

INTERSTAR (X70)

dCi 80	F9Q 772	1.9	2002.07 -		410517.83D
--------	---------	-----	-----------	--	------------

JUKE

1.5 dCi		1.5	2010.06 -		411442.83D ▲
1.6	HR16DE	1.6	2010.06 -		411241.82D
1.6 DIG-T	MR16DDT	1.6	2010.06 -		411241.82D

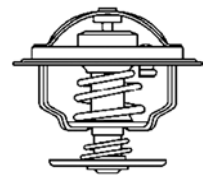

NISSAN

	Motor Engine Moteur	Ltr. Ltr. Ltr.	Jahr Year Année	Einschränkung Restriction* Restriction*	Thermostat Thermostat Thermostat
KUBISTAR					
1.2	D7F 764	1.2	2003.08 -		3174.89D
1.2 16V	D4F 712	1.2	2006.04 -		3166.89D
1.5 dCi	K9K 722	1.5	2003.08 -	mit Rußpartikelfilter	411039.83D
1.5 dCi	K9K 704, K9K 710	1.5	2003.08 -		411043.89D
1.5 dCi	K9K 722	1.5	2003.08 -	ohne Rußpartikelfilter	411043.89D
1.5 dCi 70	K9K 700	1.5	2006.04 -		411043.89D
1.5 dCi 85	K9K 276	1.5	2006.04 -	Katalysatorart	411039.83D
1.5 dCi 85	K9K 276	1.5	2006.04 -	Katalysatorart	411043.89D
1.6 16V	K4M 752	1.6	2003.08 -	Deckel Thermostatgehäuse	126104 ▲
1.6 16V	K4M 752	1.6	2003.08 -		3466.89D
LAUREL (JC32)					
2.4	L24S, L24E	2.4	1985.01 - 1987.12		3118.82D1
2.8 D	LD28, RD28	2.8	1985.01 - 1989.12		4022.82D
LUCINO					
1.3	GA13DE	1.3	1996.11 - 2000.01		3478.82D
1.4	GA14DE	1.4	1991.09 - 2000.01		3478.82D
1.5	GA15DE	1.5	1997.11 - 2000.01		3478.82D
1.6	GA16DS	1.6	1991.09 - 1992.10		3478.82D
1.6	GA16DE	1.6	1992.10 - 2000.01		3478.82D
2.0 D	CD20	2.0	1997.11 - 2000.01		410176.82D0
MICRA I (K10)					
1.0	MA10S	1.0	1982.12 - 1991.05		3044.90D1
1.2	MA12S	1.2	1986.07 - 1992.07		3044.90D1
MICRA II (K11)					
1.0 i 16V	CG10DE	1.0	1992.08 - 2003.02		3004.82
1.3 i 16V	CG13DE	1.3	1992.08 - 2000.09		3004.82
1.4 i 16V	CGA3DE	1.4	2000.09 - 2003.02		3004.82
1.5 D	TD15	1.5	1998.02 - 2003.02		4821.89D
MICRA III (K12)					
1.0 16V	CG10DE	1.0	2003.01 - 2010.06		410488.88D
1.2 16V	CR12DE, CG12DE	1.2	2003.01 - 2010.06		410488.88D
1.4 16V	CR14DE	1.4	2003.01 - 2010.06		410488.88D
1.5 dCi	K9K 276, K9K 704, K9K 708	1.5	2003.01 - 2006.12		411040.83D
1.5 dCi	K9K 276, K9K 704, K9K 708	1.5	2006.12 - 2010.06		411442.83D ▲
1.6 160 SR	HR16DE	1.6	2005.08 -		411241.82D
160 SR	HR16DE	1.6	2005.05 - 2010.06		411241.82D
MICRA IV (K13)					
1.2	HR12DE	1.2	2010.05 -		411241.82D
1.2 DIG	HR12DDR	1.2	2011.04 -		411241.82D
NOTE (E11)					
1.4	CR14DE	1.4	2006.03 -		410488.88D
1.5 dCi	K9K 276, K9K 700	1.5	2006.03 - 2006.12		411040.83D
1.5 dCi	K9K 276, K9K 700	1.5	2006.12 -		411442.83D ▲
1.5 dCi	K9K 292	1.5	2008.07 -		411442.83D ▲
1.6	HR16DE	1.6	2006.03 -		411241.82D

NISSAN

 Motor
Engine
Moteur

 Ltr.
Ltr.
Ltr.

 Jahr
Year
Année

 Einschränkung
Restriction*
Restriction*

 Thermostat
Thermostat
Thermostat

NV 200

1.5 dCi		1.5	2011.04 -		411442.83D ▲
1.6 16V	HR16DE	1.6	2010.02 -		411241.82D

PATROL (160)

2.8	L28	2.8	1980.07 - 1988.08		3118.88D1
-----	-----	-----	-------------------	--	-----------

PATROL (260)

2.8	L28	2.8	1986.05 - 1990.06		3118.88D1
-----	-----	-----	-------------------	--	-----------

PICK UP (720)

1.8	L18	1.8	1983.01 - 1986.03		3118.88D1
2.2	Z22	2.2	1983.04 - 1986.03		3118.82D1

PICK UP (D21)

2.0	Z20	2.0	1985.09 - 1991.08		3118.82D1
2.4 i 12V	KA24E	2.4	1992.04 - 1998.02		4635.76

PICK UP (D22)

2.4 i	KA24DE, KA24E	2.4	1998.02 -		4635.76
-------	---------------	-----	-----------	--	---------

PRAIRIE (M10, NM10)

1.5 S	E15S	1.5	1984.01 - 1987.12		3118.82D1
1.8 SGL (M10)	CA18S	1.8	1983.07 - 1987.10		3118.82D1
2.0	CA20S	2.0	1986.06 - 1988.09		3118.88D1

PRAIRIE PRO (M11)

2.0	CA20E	2.0	1989.03 - 1990.08		3118.88D1
2.0 i	CA20E	2.0	1988.10 - 1992.12		3118.88D1
2.4 i	KA24E	2.4	1992.04 - 1994.07		4635.76

PRIMASTAR

1.9 dCi	F9Q 760	1.9	2002.07 - 2006.08		410517.83D
2.0	F4R 722, F4R 720	2.0	2001.03 -	Deckel Thermostatgehäuse	126104 ▲
2.0	F4R 722, F4R 720	2.0	2001.03 -		3466.89D
dCi 80	F9Q 762	1.9	2001.03 -		410517.83D
dCi 90	M9R 782	2.0	2006.09 -		411476.83D ▲
dCi 100	F9Q 760	1.9	2001.03 -		410517.83D
dCi 120	M9R 780	2.0	2006.09 -		411476.83D ▲

PRIMERA (P10, WP10)

1.6	GA16DE, GA16DS	1.6	1990.06 - 1996.01		3478.82D
1.6 i	GA16DE, GA16DS	1.6	1990.06 - 1998.03		3478.82D
2.0	SR20DE	2.0	1990.06 - 1998.01		4635.76
2.0 16V	SR20DI	2.0	1990.06 - 1996.06		4635.76
2.0 D	CD20	2.0	1990.07 - 1996.01		410176.88D0
2.0 GT	SR20DE	2.0	1990.06 - 1996.01		4635.76
2.0 i	SR20DE SR20DI	2.0	1990.07 - 1998.03		4635.76

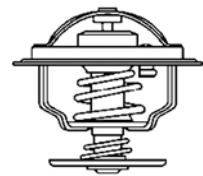

NISSAN

	Motor Engine Moteur	Ltr. Ltr. Ltr.	Jahr Year Année	Einschränkung Restriction* Restriction*	Thermostat Thermostat Thermostat
PRIMERA (P11, WP11)					
1.6 16V	QG16DE	1.6	1996.06 - 2002.07		3478.82D
1.6 16V	GA16DE	1.6	1996.09 - 2002.07		3478.82D
1.8	QG18DD	1.8	1996.06 - 1999.05		3478.82D
1.8 16V	QG18DE	1.8	1999.08 - 2002.07		3478.82D
2.0	SR20VE	2.0	1996.06 - 1999.05		4635.76
2.0 16V	SR20DE	2.0	1996.06 - 2002.07		4635.76
2.0 TD	CD20T	2.0	1996.09 - 2002.07		410176.82D0
PRIMERA (P12, WP12)					
1.6	QG16DE	1.6	2002.01 -		3478.82D
1.8	QG18DE	1.8	2002.03 -		3478.82D
1.9 dCi		1.9	2002.08 -		410538.89D
PULSAR					
1.6	GA16DE	1.6	1992.10 - 2000.05		3478.82D
1.8	QG18DE	1.8	1995.07 - 2000.05		3478.82D
QASHQAI (J10, JJ10)					
1.5 dCi		1.5	2008.07 - 2009.07		411040.83D
1.5 dCi		1.5	2009.08 - 2010.01		411042.89D
1.5 dCi		1.5	2010.02 -		411442.83D ▲
1.6	HR16DE	1.6	2007.02 -		411241.82D
2.0	MR20DE	2.0	2007.02 -		411241.82D
2.0 dCi	M1D, M9R	2.0	2007.02 -		411475.89D ▲
SERENA (C23M)					
1.6	GA16DE	1.6	1994.10 - 2000.08		3478.82D
1.6 16V	GA16DE	1.6	1993.02 - 2001.09		3478.82D
2.0 16V	SR20DE	2.0	1992.11 - 2001.09		4635.76
2.0 D	LD20	2.0	1992.11 - 2001.09		410176.82D0
2.3 D	LD23	2.3	1995.01 - 2001.09		410176.82D0
SERENA (C24)					
2.0	SR20DE	2.0	2000.09 -		4635.76
SILVIA (S12)					
1.8	CA18ET	1.8	1986.07 - 1988.04		3118.88D1
2.0 GP	FJ20E	2.0	1984.04 - 1988.09		3118.82D1
STANZA (T11)					
1.6	CA16S	1.6	1981.08 - 1985.12		3118.82D1
1.8	CA18S, CA18	1.8	1981.08 - 1985.12		3118.82D1
SUNNY I (B11)					
1.3	E13	1.3	1982.03 - 1990.08		3118.82D1
1.5	E15, E15S	1.5	1982.03 - 1986.10		3118.82D1
1.6	E16, E16S	1.6	1984.05 - 1988.10		3118.82D1
1.7 D	CD17	1.7	1982.03 - 1986.10		3118.82D1

NISSAN
**Motor
Engine
Moteur**
**Ltr.
Ltr.
Ltr.**
**Jahr
Year
Année**
**Einschränkung
Restriction*
Restriction***
**Thermostat
Thermostat
Thermostat**
SUNNY II (B12, N13)

1.0	E10S	1.0	1986.07 - 1990.09		4272.90D
1.3	E13S	1.3	1986.06 - 1991.10		3118.82D1
1.4	GA14S	1.4	1988.10 - 1991.08		4634.76
1.5	E15S	1.5	1986.06 - 1988.10		3118.82D1
1.6	E16S, GA16DE, GA16S	1.6	1986.07 - 1988.10		3118.82D1
1.6		1.6	1988.10 - 1990.09		3118.82D1
1.6 GTI 16V	CA16D	1.6	1987.02 - 1989.05		3118.88D1
1.6 i	E16i	1.6	1986.06 - 1990.10		3118.82D1
1.6 i 12V	GA16i	1.6	1986.06 - 1991.06		4634.76
1.7 D	CD17	1.7	1986.01 - 1991.06		3118.82D1
1.8 GTI 16V	CA18D	1.8	1989.01 - 1991.06		3118.88D1

SUNNY III (N14, Y10)

1.4	GA14DS	1.4	1990.10 - 1995.06		4634.76
1.4 i	GA14DE , GA14DS	1.4	1990.10 - 1995.05		4634.76
1.4 i 16V	GA14DE	1.4	1990.10 - 1995.06		3478.82D
1.5	QG15DE	1.5	1995.07 - 2000.03		3478.82D
1.6	GA16DEL	1.6	1992.01 - 1995.06		4634.76
1.6	GA16DE	1.6	1995.07 - 2000.03		3478.82D
1.6	QG16DE	1.6	2000.04 - 2003.09		3478.82D
1.6 16V	GA16DS	1.6	1990.11 - 1995.05		4634.76
1.6 i	GA16DE, GA16DEL, GA16DS	1.6	1990.10 - 2000.03		4634.76
1.6 i 16V	GA16DE, GA16DS	1.6	1990.10 - 2000.03		3478.82D
1.7 D	CD17	1.7	1990.11 - 2000.03		3118.82D1
1.8	QG18DE	1.8	2000.04 - 2003.09		3478.82D
2.0 D	CD20	2.0	1990.10 - 2000.03		410176.88D0
2.0 GTI-R	SR20DET	2.0	1990.10 - 1995.05		4635.76
2.0 i 16V	SR20DE	2.0	1990.10 - 1995.05		4635.76

TERRANO I (WD21)

2.7 TD	TD27T	2.7	1989.02 - 1996.02		4022.82D
--------	-------	-----	-------------------	--	----------

TERRANO II (R20)

2.4	KA24E	2.4	1996.05 - 2002.01		4635.76
2.4 i 12V	KA24E	2.4	1993.02 - 1996.06		4635.76
2.7 TD	TD27T	2.7	1993.02 - 2002.01		4022.82D

TIIDA (C11X, SC11X)

1.5	HR15DE	1.5	2004.05 - 2007.02		411241.82D
1.5 dCi	K9K 728	1.5	2007.09 -		411442.83D ▲
1.6	HR16DE	1.6	2007.09 -		411241.82D

URVAN (E23)

2.0	Z20	2.0	1982.12 - 1988.11		3118.82D1
-----	-----	-----	-------------------	--	-----------

URVAN (E24)

2.0	Z20	2.0	1987.05 - 1997.05		3118.82D1
-----	-----	-----	-------------------	--	-----------

VANETTE (KC120)

1.5	A15	1.5	1983.01 - 1987.12		3118.82D1
-----	-----	-----	-------------------	--	-----------

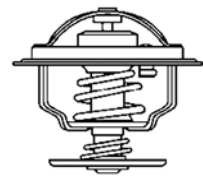

NISSAN

	Motor Engine Moteur	Ltr. Ltr. Ltr.	Jahr Year Année	Einschränkung Restriction* Restriction*	Thermostat Thermostat Thermostat
VANETTE (C22)					
1.2		1.2	1982.07 - 1984.10		3118.82D1
1.5	A15S	1.5	1981.07 - 1995.12		3118.82D1
1.5	A15	1.5	1982.07 - 1987.06		3118.82D1
VANETTE (HC 23)					
1.6 i	GA16DE	1.6	1995.01 -		3478.82D
VERSA					
1.6 Flex	HR16DE	1.6	2011.01 -		411241.82D
X-TRAIL (T31)					
2.0	MR20DE	2.0	2007.03 -		411241.82D
2.0 dCi	M9R 760	2.0	2007.06 -		411475.89D ▲

OPEL
**Motor
Engine
Moteur**
**Ltr.
Ltr.
Ltr.**
**Jahr
Year
Année**
**Einschränkung
Restriction*
Restriction***
**Thermostat
Thermostat
Thermostat**
AGILA (A)

1.0	Z 10 XEP	1.0	2003.08 - 2007.12		411579.92D ▲
1.0 12V	Z 10 XE	1.0	2000.09 - 2007.12		411579.92D ▲
1.2 16V	Z 12 XE	1.2	2000.09 - 2007.12		411579.92D ▲
1.2 16V Twinport	Z 12 XEP	1.2	2004.07 - 2007.12		411579.92D ▲
1.3 CDTI	Z 13 DT	1.3	2003.08 - 2007.12		410588.88D

AGILA (B)

1.3 CDTI	D13A, Z 13 DTJ	1.3	2008.04 -		410588.88D
----------	----------------	-----	-----------	--	------------

ANTARA

2.4	Z 24 XE, Z 24 XED	2.4	2006.05 -		4189.87D
2.4	A 24 XE	2.4	2010.12 -		411193.82D

ARENA

1.9 D	F8Q 606	1.9	1998.03 - 2001.08	Chassis No. →C 004093	3470.89D50
1.9 D	F8Q 600	1.9	1998.03 - 2001.08	Chassis No. →C 019063	410530.89D
1.9 D	F8Q 600	1.9	1998.04 - 2001.08	Chassis No. C 019064→	3470.89D50
1.9 D	F8Q 606	1.9	1998.04 - 2001.08	Chassis No. 004094→, →C 015185	410530.89D
1.9 D	F8Q 606	1.9	1998.05 - 2001.08	Chassis No. C 015186→	3470.89D50
2.5 D	S8U 780, S8U 782, S8U 758	2.5	1998.03 - 2001.08		4151.76D

ASCONA C

1.3 N	13 N	1.3	1981.09 - 1986.08		3017.92D2
1.3 S	13 S	1.3	1981.09 - 1988.08		3017.92D2
1.6	16 N	1.6	1981.09 - 1988.08		4164.92D
1.6	16 SV	1.6	1986.09 - 1988.08		3017.92D2
1.6 D	16 DA, 16 D	1.6	1982.03 - 1988.08		4115.92D
1.6 i	C 16 NZ, C 16 LZ	1.6	1986.09 - 1988.08		3017.92D2
1.6 i	E 16 NZ, E 16 LZ	1.6	1987.09 - 1988.08		3017.92D2
1.6 S	16 SH	1.6	1981.09 - 1986.08		4164.92D
1.8	E 18 NV	1.8	1987.09 - 1988.08		4164.92D
1.8 E	S 18 NV, C 18 NE	1.8	1985.01 - 1986.08		4115.92D
1.8 i	18 E	1.8	1982.09 - 1986.08		4115.92D
2.0 i	20 NE, 20 SEH	2.0	1986.09 - 1988.08		4144.92D
2.0 i	C 20 NE, C 20 NEF	2.0	1986.09 - 1988.08		4144.92D

ASTRA F

1.4	14 NV, 14 SE	1.4	1991.09 - 1998.09		3017.92D2
1.4 i	C 14 NZ, X 14 NZ	1.4	1991.09 - 1999.01		3017.92D2
1.4 i 16V	X 14 XE	1.4	1996.01 - 2001.03		4178.92D
1.4 Si	C 14 SE	1.4	1992.03 - 2001.03		3017.92D2
1.6	16 NZR	1.6	1995.09 - 1998.09		3017.92D2
1.6	16 LZ2	1.6	1995.09 - 1998.09	ohne Klimaanlage	4168.92D
1.6 i	C 16 NZ, X 16 SZR	1.6	1991.09 - 1998.09		3017.92D2
1.6 i	X 16 SZ, X 16 SZR	1.6	1993.02 - 1996.08		3017.92D2
1.6 i 16V	X 16 XEL	1.6	1994.08 - 1998.09		4178.92D
1.6 Si	C 16 SE	1.6	1992.03 - 1994.12		3017.92D2
1.7 D	17D, 17 DR	1.7	1991.12 - 1999.01		4115.92D

OPEL

	Motor Engine Moteur	Ltr. Ltr. Ltr.	Jahr Year Année	Einschränkung Restriction* Restriction*	Thermostat Thermostat Thermostat
1.7 TD	X 17 DTL	1.7	1994.08 - 1999.01		4115.92D
1.7 TDS	17 DT (TC4EE1), X 17 DT (TC4EE1)	1.7	1991.11 - 1998.09	Motor no. →731418	3468.88D
1.7 TDS	17 DT (TC4EE1), X 17 DT (TC4EE1)	1.7	1991.12 - 1998.09	Motor no. 731419→	3467.85D
1.8	18 SE	1.8	1991.11 - 1993.07	ohne Gehäuse	4115.92D
1.8	18 SE	1.8	1991.11 - 1993.07	mit Gehäuse	4164.92D
1.8 i	C 18 NZ	1.8	1991.09 - 1998.09		4168.92D
1.8 i 16V	C 18 XE, C 18 XEL, X 18 XE	1.8	1993.06 - 2001.03	Chassis No. →01458051	4177.92D
1.8 i 16V	C 18 XE, C 18 XEL, X 18 XE	1.8	1993.07 - 2001.03	Chassis No. 01458052→	4183.92D
2.0 GSI 16V	C 20 XE	2.0	1991.09 - 1998.01		4164.92D
2.0 i	C 20 NE	2.0	1991.09 - 1998.09		4168.92D
2.0 i 16V	C 20 XE	2.0	1993.03 - 1998.01		4164.92D
2.0 i 16V	X 20 XEV	2.0	1995.02 - 1998.09		4183.92D

ASTRA F Classic

1.2 i	X 12 XE	1.2	1998.03 - 2000.08		4459.92D
1.4	Z 14 XEP	1.4	2003.09 - 2005.01		4459.92D
1.4 i	X 14 NZ	1.4	1998.01 - 2005.01		3017.92D2
1.4 i	X 14 XE	1.4	1998.03 - 2000.08		4242.92D
1.6 i	X 16 SZR	1.6	1998.01 - 2005.01		3017.92D2
1.6 i 16V	X 16 XEL	1.6	1998.01 - 2005.01		4208.92D
2.0 Di	X 20 DTL	2.0	1998.03 - 2000.08		4198.92D
2.0 i	X 20 XER, X 20 XEV	2.0	1998.03 - 2000.08		4183.92D

ASTRA G

1.2 16V	X 12 XE, Z 12 XE	1.2	1998.02 - 2005.01		4459.92D
1.4	Z 14 XEP	1.4	2007.09 - 2009.12		4459.92D
1.4 16V	X 14 XE	1.4	1998.02 - 2005.01		4208.92D
1.4 16V	Z 14 XE	1.4	1998.02 - 2005.01		4242.92D
1.6	X 16 SZR, Z 16 SE	1.6	1998.02 - 2005.01		3017.92D2
1.6	Z 16 YNG	1.6	2002.06 - 2004.03		4242.92D
1.6	Z 16 XEP	1.6	2002.12 - 2009.12		4431.105D
1.6 16V	C 16 SEL, X 16 XEL	1.6	1998.02 - 2005.01		4208.92D
1.6 16V	Z 16 XE	1.6	1998.02 - 2005.01		4242.92D
1.6 16V	Z 16 XEP	1.6	2000.03 - 2005.05		4431.105D
1.6 CNG	Z 16 YNG	1.6	2003.03 - 2004.07		4242.92D
1.7 TD	X 17 DTL	1.7	1998.02 - 2005.04		4115.92D
1.8	Z 18 XEL	1.8	2003.02 - 2004.01		411578.92D ▲
1.8 16V	Z 18 XE, X 18 XE1	1.8	1998.02 - 2005.10		411578.92D ▲
2.0 16V	C 20 SEL, X 20 XEV	2.0	1998.02 - 2005.01		4183.92D
2.0 16V OPC	X 20 XER	2.0	1999.11 - 2002.09		4183.92D
2.0 16V Turbo	Z 20 LET	2.0	2000.09 - 2005.10		4183.92D
2.0 DI	X 20 DTL, Y 20 DTL	2.0	1998.02 - 2005.04		4198.92D
2.0 DTI 16V	Y 20 DTH	2.0	1999.08 - 2005.01	Motor no. →17B49754	4198.92D
2.0 DTI 16V	Y 20 DTH	2.0	1999.09 - 2005.01	Motor no. 17B49755→, 2(2/5/6/8/B/H)999999	4428.92D
2.0 DTI 16V	Y 20 DTH	2.0	1999.10 - 2005.01	Motor no. 2(2/5/6/8/B/H) 999999→	4433.92D
2.0 OPC	Z 20 LET	2.0	2002.03 - 2005.10		4183.92D
2.2 16V	Z 22 SE	2.2	2000.09 - 2005.10		411193.82D
2.2 DTI	Y 22 DTR	2.2	2002.09 - 2005.10		4433.92D

OPEL
**Motor
Engine
Moteur**
**Ltr.
Ltr.
Ltr.**
**Jahr
Year
Année**
**Einschränkung
Restriction*
Restriction***
**Thermostat
Thermostat
Thermostat**
ASTRA H

1.2	Z 12 XEP	1.2	2005.08 -		4459.92D
1.3 CDTI	Z 13 DTH	1.3	2005.08 -		410048.88D
1.4	Z 14 XEL, Z 14 XEP	1.4	2004.04 -		4459.92D
1.4 LPG	Z 14 XEP	1.4	2009.08 -		4459.92D
1.6	A 16 XER, Z 16 XE1, Z 16 XEP, Z 16 XER	1.6	2004.03 -		4431.105D
1.6 Turbo	Z 16 LET	1.6	2007.02 -		4357.92D
1.8	Z 18 XE	1.8	2004.03 -		411578.92D ▲
1.8	A 18 XER, Z 18 XER	1.8	2005.08 -		4431.105D
1.9 CDTI	Z 19 DT, Z 19 DTH, Z 19 DTL	1.9	2004.06 -		410049.88D
1.9 CDTI 16V	Z 19 DTJ	1.9	2004.04 -		410049.88D
2.0 Turbo	Z 20 LEH, Z 20 LEL, Z 20 LER	2.0	2004.03 -		4183.92D

ASTRA J

1.3 CDTI	A 13 DTE	1.3	2009.12 -		411774.88D ▲
1.6	A 16 XER	1.6	2009.12 -		411059.105D ▲
1.6 Turbo	A 16 LET	1.6	2009.12 -		411059.105D ▲

ASTRA GTC J

1.6	A 16 LET	1.6	2011.10 -		411059.105D ▲
1.8	A 18 XER	1.8	2011.10 -		411059.105D ▲

CALIBRA A

2.0 i	C 20 NE	2.0	1990.06 - 1997.07		4144.92D
2.0 i 16V	C 20 XE	2.0	1990.06 - 1994.02		4164.92D
2.0 i 16V	X 20 XEV	2.0	1994.02 - 1997.07		4183.92D
2.0 i Turbo	C 20 LET	2.0	1992.03 - 1997.07		4164.92D
2.5 i V6	X 25 XE, C 25 XE	2.5	1993.04 - 1997.07		4175.92D

COMBO

1.2	C 12 NZ, X 12 SZ	1.2	1994.07 - 2001.10		3017.92D2
1.3 CDTI 16V	Y 13 DT, Z 13 DT, Z 13 DTJ	1.3	2004.10 -		410588.88D
1.4	C 14 NZ, C 14 SE, X 14 SZ	1.4	1994.07 - 2001.10		3017.92D2
1.4	Z 14 XEP	1.4	2004.10 -		4459.92D
1.4 16V	X 14 XE	1.4	1999.08 - 2001.10		4178.92D
1.4 16V	Z 14 XEP	1.4	2005.08 -		4459.92D
1.6	Z 16 SE	1.6	2001.10 -		3017.92D2
1.6 CNG	Z 16 YNG	1.6	2005.04 -		4242.92D
1.6 CNG 16V	Z 16 YNG	1.6	2005.04 -		4242.92D
1.7 D	17 D (4EE1), X 17 D (4EE1)	1.7	1994.07 - 2001.10	Motor no. →334922	3467.85D

COMBO (X12)

1.3 CDTI	A 13 FD	1.3	2012.02 -		411774.88D ▲
----------	---------	-----	-----------	--	--------------

CORSA A

1.0	10 S	1.0	1982.09 - 1993.03		3017.92D2
1.2	12 S, 12 ST, E 12 GV, 12 NC	1.2	1982.09 - 1990.08		3017.92D2
1.2 i	C 12 NZ	1.2	1989.09 - 1993.03		3017.92D2
1.2 N	E 12 GV, 12 NC, 12 NV	1.2	1985.01 - 1993.03		3017.92D2
1.2 S	12 S, 12 ST	1.2	1982.09 - 1993.03		3017.92D2
1.3	13 S, 13 SB	1.3	1982.09 - 1993.03		3017.92D2
1.3	13 NB, C 13 N	1.3	1985.09 - 1989.10		3017.92D2
1.3 i	C 13 N	1.3	1986.09 - 1990.09		3017.92D2

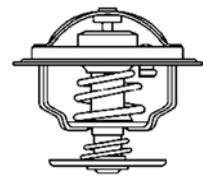
OPEL

	Motor Engine Moteur	Ltr. Ltr. Ltr.	Jahr Year Année	Einschränkung Restriction* Restriction*	Thermostat Thermostat Thermostat
1.3 S	13 SB	1.3	1982.09 - 1989.10		3017.92D2
1.4 i	C 14 NZ	1.4	1985.01 - 1993.03		3017.92D2
1.4 S	14 NV	1.4	1989.09 - 1993.03		3017.92D2
1.4 Si	C 14 SE	1.4	1991.09 - 1993.03		3017.92D2
1.5 D	15 D (4EC1)	1.5	1987.06 - 1993.03		3468.88D
1.5 TD	15 DT (T4EC1)	1.5	1987.10 - 1993.03		3468.88D
1.6 GSI	C 16 NZ, C 16 SE, C 16 SEI, E 16 SE	1.6	1988.05 - 1993.03		3017.92D2

CORSA B

1.0 i 12V	X 10 XE	1.0	1996.11 - 2000.09		4459.92D
1.2 i	12 NZ, C 12 NZ, X 12 SZ	1.2	1993.03 - 2000.09		3017.92D2
1.2 i 16V	X 12 XE	1.2	1998.03 - 2000.09		4459.92D
1.3	13 NB	1.3	1996.01 - 2002.12		3017.92D2
1.4	C 14 SE	1.4	1993.04 - 1994.08		3017.92D2
1.4 i	C 14 NZ, X 14 SZ	1.4	1993.03 - 2000.09		3017.92D2
1.4 i 16V	C 14 SEL X 14 XE	1.4	1994.09 - 2000.09		4178.92D
1.4 Si	C 14 SE	1.4	1993.03 - 2000.09		3017.92D2
1.5 D	15 D (4EC1)	1.5	1993.03 - 2000.09	Motor no. →544012	3468.88D
1.5 D	15 D (4EC1)	1.5	1993.04 - 2000.09	Motor no. 544013 →	3467.85D
1.5 TD	X 15 DT (T4EC1), 15 DT (T4EC1)	1.5	1993.03 - 2000.09	Motor no. →544012	3468.88D
1.5 TD	X 15 DT (T4EC1), 15 DT (T4EC1)	1.5	1993.04 - 2000.09	Motor no. 544013 →	3467.85D
1.6 GSI 16V	C 16 XE	1.6	1993.03 - 2000.09		4178.92D
1.6 i 16V	C 16 SEL, X 16 XE	1.6	1994.09 - 2000.09		4178.92D
1.7 D	17 D (4EE1), X 17 D (4EE1)	1.7	1996.02 - 2000.09	Motor no. →334922	3467.85D

CORSA C

1.0	Z 10 XE, Z 10 XEP	1.0	2000.09 - 2009.12		4459.92D
1.2	Z 12 XE, Z 12 XEP	1.2	2000.09 - 2009.12		4459.92D
1.2 16V	Z 12 XE	1.2	2000.09 -		4459.92D
1.2 Twinport	Z 12 XEP	1.2	2004.07 - 2009.12		4459.92D
1.3 CDTI	Z 13 DT	1.3	2003.06 - 2009.12		410588.88D
1.3 CDTI 16V	Z 13 DT	1.3	2005.08 -		410588.88D
1.4	Z 14 XE Z 14 XEP	1.4	2000.09 - 2009.12		4242.92D
1.4 Twinport	Z 14 XEP	1.4	2003.06 - 2009.12		4459.92D
1.6	Z 16 YNG	1.6	2005.08 - 2006.07		4242.92D
1.8	Z 18 XE	1.8	2000.09 - 2009.12		411578.92D ▲

CORSA D

1.0	A 10 XEP, Z 10 XEP	1.0	2006.07 -		4459.92D
1.2	Z 12 XEP	1.2	2006.07 -		4459.92D
1.2 LPG	Z 12 XEP	1.2	2009.09 -		4459.92D
1.3 CDTI	13 DTJ	1.3	2006.07 -		410048.88D
1.3 CDTI	A 13 DTC	1.3	2006.07 -		411774.88D ▲
1.3 CDTI	A 13 DTR, Z 13 DTE	1.3	2010.06 -		411774.88D ▲
1.4	Z 14 XEP	1.4	2006.07 -		4459.92D
1.4 LPG	Z 14 XEP	1.4	2006.07 -		4459.92D
1.6 Turbo	A 16 LEL, A 16 LER, A 16 LES, Z 16 LEL, Z 16 LER	1.6	2007.02 -		4357.92D

FRONTERA A

2.0 i	C 20 NE, X 20 SE	2.0	1992.03 - 1998.10		4144.92D
2.2 i	X 22 XE	2.2	1995.03 - 1998.10		4177.92D
2.3 TD	23 DTR	2.3	1992.03 - 1998.10		4255.92D
2.4 i	C 24 NE	2.4	1992.03 - 1998.10		4255.92D
2.5 TDS	25TDS (VM41B)	2.5	1996.09 - 1998.10		4158.80D

OPEL
**Motor
Engine
Moteur**
**Ltr.
Ltr.
Ltr.**
**Jahr
Year
Année**
**Einschränkung
Restriction*
Restriction***
**Thermostat
Thermostat
Thermostat**
FRONTERA B

2.2 DTI	X 22 DTH, Y 22 DTH	2.2	1998.10 - 2002.09		4207.92D
2.2 i	X 22 SE, Y 22 SE	2.2	1998.10 -		4194.92D

GT

2.0	LNf, Z 20 NHH	2.0	2007.06 -		411193.82D
-----	---------------	-----	-----------	--	------------

INSIGNIA

1.6	A 16 XER	1.6	2008.07 -	Chassis No. →91999999	4431.105D
1.6	A 16 XER	1.6	2008.08 -	Chassis No. A1000001→	411059.105D ▲
1.6 Turbo	A 16 LET	1.6	2008.07 -		4357.92D
1.8	A 18 XER	1.8	2008.07 -	Chassis No. →91999999	4431.105D
1.8	A 18 XER	1.8	2008.08 -	Chassis No. A1000001→	411059.105D ▲
2.0 Turbo	A 20 NFT	2.0	2011.09 -		411193.82D

KADETT E

1.2	12 SC	1.2	1984.09 - 1986.07		3017.92D2
1.3 i	C 13 N	1.3	1985.09 - 1991.08		3017.92D2
1.3 N	13 N	1.3	1984.09 - 1991.08		3017.92D2
1.3 S	13 S	1.3	1984.09 - 1993.02		3017.92D2
1.4 i	C 14 NZ	1.4	1990.01 - 1994.07		3017.92D2
1.4 S	14 NV, C 14 SE	1.4	1989.07 - 1991.08		3017.92D2
1.5 TD	15 DT (T4EC1)	1.5	1988.07 - 1991.08		3468.88D
1.6	16 SV, E 16 SE	1.6	1986.09 - 1991.12		3017.92D2
1.6 D	16 D, 16 DA	1.6	1984.08 - 1989.12		4115.92D
1.6 i	16 SV, C 16 LZ, C 16 NZ, E 16 NZ	1.6	1989.07 - 1994.07		3017.92D2
1.6 S	16 SH	1.6	1984.09 - 1986.08		4115.92D
1.6 S	16 SV	1.6	1986.09 - 1991.08		3017.92D2
1.7 D	17 D, 17 DR	1.7	1988.08 - 1994.07		4115.92D
1.8	18 SE	1.8	1986.01 - 1990.08		4164.92D
1.8	18 E	1.8	1987.09 - 1990.08		4115.92D
1.8 E	C 18 NE	1.8	1985.10 - 1986.08		4115.92D
1.8 GSI	18 E	1.8	1984.09 - 1986.08		4115.92D
1.8 i	C 18 NT	1.8	1984.08 - 1992.09		4115.92D
1.8 i	18 E	1.8	1984.09 - 1986.08		4164.92D
1.8 i	18 SV, C 18 NZ	1.8	1985.06 - 1991.08		4144.92D
1.8 S	E 18 NV, S 18 NV	1.8	1987.09 - 1991.08		4164.92D
2.0 GSI	20 NE, 20 SEH, C 20 NE	2.0	1986.09 - 1991.08		4164.92D
2.0 GSI 16V	20 XE, 20 XEJ, C 20 XE	2.0	1987.12 - 1991.08		4164.92D
2.0 i	20 NE, 20 SE, C 20 NE	2.0	1986.10 - 1993.02		4164.92D

MANTA B

1.2 N	12 N	1.2	1976.08 - 1983.07		3017.87D50
1.2 S	12 S	1.2	1975.09 - 1979.02		3017.87D50
1.3 N	13 N	1.3	1979.03 - 1980.12		3017.92D50
1.3 S	13 S	1.3	1979.08 - 1986.08		3017.92D50
1.6 N	16 N	1.6	1975.09 - 1980.12	Motor no. →16N-622327	3054.92D50
1.6 N	16 N	1.6	1975.10 - 1980.12	Motor no. 16N-622328→	3017.92D2
1.6 S	16 S	1.6	1975.09 - 1981.12	Motor no. →16S-687305	3054.92D50

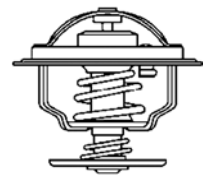
OPEL

	Motor Engine Moteur	Ltr. Ltr. Ltr.	Jahr Year Année	Einschränkung Restriction* Restriction*	Thermostat Thermostat Thermostat
1.6 S	16 S	1.6	1975.10 - 1981.12	Motor no. 16S-687306→	3017.92D2
1.8 S	18 S	1.8	1982.07 - 1987.08		4115.92D
1.9 E	19 E	1.9	1975.09 - 1977.08		4255.82D
1.9 N	19 N	1.9	1976.08 - 1981.12	Motor no. →19N-517783	3054.92D50
1.9 N	19 N	1.9	1976.09 - 1981.12	Motor no. 19N-517784→	3017.92D2
1.9 S	19 S	1.9	1975.09 - 1980.12		3054.87D50
2.0	20 N	2.0	1977.08 - 1980.12	Motor no. →20N-190247	3054.92D50
2.0	20 N	2.0	1977.09 - 1980.12	Motor no. 20N-190248→	3017.92D2
2.0 E	20 E	2.0	1977.08 - 1988.08		4255.87D
2.0 S	20 S	2.0	1977.08 - 1984.08	Motor no. →20S-602835	3054.92D50
2.0 S	20 S	2.0	1977.09 - 1984.08	Motor no. 0S-602836→	3017.92D2
MERIVA					
1.3 CDTI	Y 13 DT, Z 13 DT, Z 13 DTJ	1.3	2003.09 - 2010.05		410588.88D
1.4 16V Twinport	Z 14 XEP	1.4	2004.07 - 2010.05		4459.92D
1.4 16V Twinport LPG	Z 14 XEP	1.4	2004.07 - 2010.05		4459.92D
1.6	Z 16 SE	1.6	2003.05 - 2010.05		3017.92D2
1.6	Z 16 XEP	1.6	2006.01 - 2010.05		4431.105D
1.6 16V	Z 16 XE	1.6	2003.05 - 2006.01		4242.92D
1.6 Turbo	Z 16 LET	1.6	2005.09 - 2010.05		4357.92D
1.8	Z 18 XE	1.8	2003.05 - 2010.05		411578.92D ▲
MERIVA B					
1.3 CDTI	A 13 DTC, A 13 DTE	1.3	2010.06 -		411774.88D ▲
MOKKA					
1.6	A 16 XER	1.6	2012.06 -		411059.105D ▲
MONZA A					
2.0 E	H 20 E	2.0	1983.03 - 1984.10		4255.87D
2.2 E	22 E	2.2	1984.11 - 1986.08		4255.92D
2.5 E	25 E, H 25 E	2.5	1981.05 - 1986.08		4255.92D
2.8	28 H	2.8	1978.02 - 1981.04		3054.92D50
3.0	30 H	3.0	1978.04 - 1982.07		4255.92D
3.0 GSE	30 E, C 30 LE	3.0	1978.02 - 1986.08		4255.92D
MOVANO					
1.9 DTI	F9Q 770	1.9	2000.09 - 2001.10	Chassis No. C000140→	3470.89D50
1.9 DTI	F9Q 772, F9Q 774	1.9	2001.10 -		410517.83D
2.5 D	S8U 772, S8U 770	2.5	1998.07 - 2000.09		4174.79D
2.8 DTI	S9W 702, S9W 700	2.8	1998.07 - 2001.10		4174.79D
OMEGA A					
1.8	18 SEH, E 18 NVR	1.8	1986.09 - 1994.03		4144.92D
1.8 N	18 NV	1.8	1986.09 - 1987.08		4144.92D
1.8 S	18 SV	1.8	1986.09 - 1994.03		4144.92D
2.0	20 SE, C 20 NEF, C 20 NEJ	2.0	1986.09 - 1994.03		4144.92D
2.0 i	C 20 NE, C 20 NEJ	2.0	1986.09 - 1994.03		4144.92D

OPEL
**Motor
Engine
Moteur**
**Ltr.
Ltr.
Ltr.**
**Jahr
Year
Année**
**Einschränkung
Restriction*
Restriction***
**Thermostat
Thermostat
Thermostat**

2.3 D	23 YD	2.3	1986.09 - 1994.03		4255.92D
2.3 TD	23 YDT	2.3	1986.09 - 1988.08		4255.92D
2.3 TD Interc.	23 DTR	2.3	1988.08 - 1994.03		4255.92D
2.4 i	C 24 NE	2.4	1988.09 - 1994.03		4255.92D
2.6 i	C 26 NE	2.6	1990.09 - 1994.03		4255.92D
3.0	30 NE, C 30 NE	3.0	1987.03 - 1994.03		4255.92D
3.0 (3000)	30 NE, C 30 LE, C 30 NE	3.0	1987.03 - 1994.03		4255.92D
3.0 24V	C 30 SEJ	3.0	1989.09 - 1994.03		4255.92D
3.0 24V (3000)	C 30 SE, C 30 SEJ	3.0	1989.09 - 1994.03		4255.92D

OMEGA B

2.0	X 20 SE	2.0	1994.03 - 1999.09		4144.92D
2.0 16V	X 20 XEV	2.0	1994.03 - 1999.09		4183.92D
2.0 DTI 16V	X 20 DTH	2.0	1997.09 - 2000.09		4188.92D
2.2 16V	Y 22 XE, Z 22 XE	2.2	1999.09 - 2003.07		4183.92D
2.2 DTI 16V	Y 22 DTH	2.2	2000.09 - 2003.07		4188.92D
2.5 TD	25 DT, X 25 TD, X 25 DT	2.5	1994.04 - 2003.07		4237.80D
2.5 V6	X 25 XE	2.5	1994.03 - 2000.09		4175.92D
2.6 V6	Y 26 SE	2.6	2000.09 - 2003.07	Motor no. → 11 999 999, Hersteller WAHLER	4175.92D
3.0 V6	X 30 XE	3.0	1994.04 - 2001.02		4175.92D
3.2 V6	Y 32 SE	3.2	2001.02 - 2003.07	Motor no. → 11 999 999, Hersteller WAHLER	4175.92D

REKORD E

1.7	17 N	1.7	1977.09 - 1982.10	Motor no. → 17N-440978	3054.87D50
1.7	17 N	1.7	1977.10 - 1982.10	Motor no. 17N-440979→	3021.88D50
1.8	18 N	1.8	1982.11 - 1986.08		4115.92D
1.8 E	C 18 NV	1.8	1985.05 - 1986.08		4115.92D
1.8 S	18 S	1.8	1982.11 - 1986.08		4115.92D
1.9	19 N	1.9	1977.09 - 1982.10	Motor no. → 19N-517783	3054.87D50
1.9	19 N	1.9	1977.10 - 1982.10	Motor no. 19N-517784→	3021.88D50
2.0	20 N	2.0	1977.09 - 1982.10	Motor no. → 20N-190247	3054.87D50
2.0	20 N	2.0	1977.10 - 1982.10	Motor no. 20N-190248→	3021.88D50
2.0 D	20 D	2.0	1977.09 - 1982.10		4255.92D
2.0 E	20 E	2.0	1977.09 - 1984.10		4255.87D
2.0 S	20 S	2.0	1977.08 - 1986.08	Motor no. → 20S-602835	3054.87D50
2.0 S	20 S	2.0	1977.09 - 1986.08	Motor no. 20S-602836→	3021.88D50
2.1 D	21 D	2.1	1977.09 - 1978.07		4255.92D
2.2 D	23 D	2.2	1978.08 - 1986.08		4255.92D
2.2 E	22 E	2.2	1984.11 - 1986.08		4255.92D
2.2 TD	23 TD	2.2	1984.06 - 1986.08		4255.92D
2.3 D	23 D	2.3	1982.11 - 1986.08		4255.92D

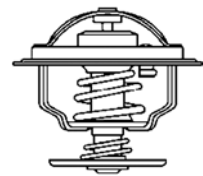

OPEL

	Motor Engine Moteur	Ltr. Ltr. Ltr.	Jahr Year Année	Einschränkung Restriction* Restriction*	Thermostat Thermostat Thermostat
SENATOR					
2.0 E	H 20 E	2.0	1983.03 - 1984.10		4255.87D
2.2 E	22 E	2.2	1984.11 - 1987.08		4255.87D
2.2 TD	23 TD	2.2	1984.11 - 1987.08		4255.92D
2.5	25 S	2.5	1978.05 - 1980.12		3054.92D50
2.5 E	25 E, H 25 E	2.5	1983.01 - 1987.08		4255.87D
2.5 i	25 NE	2.5	1990.09 - 1993.09		4255.92D
2.6 i	C 26 NE	2.6	1990.09 - 1993.09		4255.92D
2.8	28 H	2.8	1978.02 - 1981.04		3054.92D50
3.0	30 H, 30 NE, C 30 LE	3.0	1978.04 - 1993.09		4255.92D
3.0 24V	C 30 SE	3.0	1989.09 - 1993.09		4255.92D
3.0 E	30 E	3.0	1978.02 - 1986.12		4255.92D
3.0 i	C 30 NE	3.0	1988.01 - 1993.09		4255.92D
SIGNUM					
1.8	Z 18 XER	1.8	2005.09 -		4431.105D
1.9 CDTI	Z 19 DT, Z 19 DTH	1.9	2004.04 -		410049.88D
2.0 DTI	Y 20 DTH	2.0	2003.05 -		4297.92D
2.0 Turbo	Z 20 NET	2.0	2003.05 -		411193.82D
2.2 direct	Z 22 YH	2.2	2003.05 -		411193.82D
2.2 DTI	Y 22 DTR	2.2	2003.05 -		4297.92D
SINTRA					
2.2 i 16V	X 22 XE	2.2	1996.11 - 1999.04		4183.92D
3.0 i 24V	X 30 XE	3.0	1996.11 - 1999.04		4175.92D
SPEEDSTER					
2.0	Z 20 LET	2.0	2003.10 - 2006.08		4183.92D
2.0 Turbo	Z 20 LET	2.0	2003.04 -		4183.92D
2.2	Z 22 SE	2.2	2000.09 -		411193.82D
TIGRA					
1.4 16V	X 14 XE	1.4	1994.07 - 2000.12		4178.92D
1.6 16V	C 16 SEL, X 16 XE	1.6	1994.07 - 1998.08		4178.92D
TIGRA TwinTop					
1.3 CDTI	Z 13 DT	1.3	2004.06 -		410588.88D
1.4	Z 14 XEP	1.4	2004.06 -		4459.92D
1.8	Z 18 XE	1.8	2004.06 -		411578.92D ▲
VECTRA A					
1.4 S	14 NV	1.4	1988.04 - 1992.06		3017.92D2
1.6	16 SV, C 16 LZ2, E 16 NZ	1.6	1988.08 - 1994.06		3017.92D2
1.6 i	C 16 NZ, E 16 NZ, X 16 SZ	1.6	1988.09 - 1995.11		3017.92D2
1.6 i	C 16 NZ2	1.6	1988.09 - 1995.11		4144.82D
1.6 i	16 LZ2	1.6	1993.09 - 1995.11	ohne Klimaanlage	4168.92D
1.6 i	16 LZ2	1.6	1993.09 - 1995.11	ohne Klimaanlage	4168.92D
1.6 S	16 SV	1.6	1988.09 - 1993.05		3017.92D2
1.7 D	17 D, 17 DR	1.7	1988.09 - 1995.11		4115.92D
1.7 TD	17 DT (TC4EE1), X 17 DT (TC4EE1)	1.7	1990.03 - 1995.11	Motor no. →731418	3468.88D
1.7 TD	17 DT (TC4EE1), X 17 DT (TC4EE1)	1.7	1990.04 - 1995.11	Motor no. 731419 →	3467.85D
1.8 i	18 SV, C 18 NZ	1.8	1988.09 - 1995.11		4144.92D
1.8 S	18 SV, E 18 NVR	1.8	1988.09 - 1990.10		4144.92D

OPEL
**Motor
Engine
Moteur**
**Ltr.
Ltr.
Ltr.**
**Jahr
Year
Année**
**Einschränkung
Restriction*
Restriction***
**Thermostat
Thermostat
Thermostat**

2.0	C 20 NEF	2.0	1988.04 - 1989.09		4144.92D
2.0	C 20 XE	2.0	1989.08 - 1995.08		4164.92D
2.0 i	20 NE, 20 SEH, C 20 NE	2.0	1988.09 - 1995.11		4144.92D
2.0 i 16V	20 XEJ, C 20 XE, X 20 XEV	2.0	1989.02 - 1995.11		4164.92D
2.0 i 16V	X 20 XEV	2.0	1994.06 - 1995.11		4183.92D
2.0 i GT	20 SEH	2.0	1988.09 - 1995.11		4144.92D
2.0 i Turbo	C 20 LET	2.0	1994.06 - 1995.11		4164.92D
2.5 CD	C 25 XE	2.5	1992.08 - 1995.08		4175.92D
2.5 V6	C 25 XE	2.5	1993.02 - 1995.11		4175.92D
2000 16V	20 XEJ	2.0	1989.01 - 1990.10		4164.92D
2000/GT 16V	20 XEJ, C 20 XE	2.0	1989.01 - 1995.11		4164.92D

VECTRA B

1.6 GL	16 SV	1.6	1995.09 - 1996.08		3017.92D2
1.6 i	X 16 SZR	1.6	1995.10 - 2003.07		3017.92D2
1.6 i	16 LZ2	1.6	1995.10 - 2003.07		4144.82D
1.6 i 16V	X 16 XEL	1.6	1995.10 - 2002.07		4178.92D
1.6 i 16V	Z 16 XE, Y 16 XE	1.6	1995.10 - 2002.07		4242.92D
1.7 TD	X 17 DT (TC4EE1)	1.7	1995.10 - 1998.12		3467.85D
1.8 i 16V	Z 18 XE, Z 18 XEL, X 18 XE1	1.8	1995.10 - 2003.07		411578.92D ▲
1.8 i 16V	X 18 XE	1.8	1995.10 - 2000.09		4183.92D
2.0 DI 16V	X 20 DTL	2.0	1996.11 - 2002.04		4188.92D
2.0 DTI 16V	Y 20 DTH, X 20 DTH	2.0	1997.06 - 2003.07		4201.92D
2.0 i 16V	X 20 XEV, C 20 SEL	2.0	1995.10 - 2000.09		4183.92D
2.2 DTI 16V	Y 22 DTR	2.2	2000.09 - 2003.07		4201.92D
2.2 i 16V	Z 22 SE	2.2	2000.09 - 2003.07		411193.82D
2.5 i V6	X 25 XE	2.5	1995.10 - 2000.09		4175.92D
2.6 i V6	Y 26 SE	2.6	2000.09 - 2003.07	Motor no. →11162841 / →17080724, Hersteller WAHLER	4175.92D
2.6 i V6	Y 26 SE	2.6	2000.09 - 2003.07		4175.92D
i 500 2.5	X 25 XE	2.5	1998.05 - 2000.09		4175.92D

VECTRA C

1.6	Z 16 XE	1.6	2005.08 -		4242.92D
1.6	Z 16 XEP	1.6	2006.01 -		4431.105D
1.6 16V	Z 16 XE	1.6	2004.06 -		4242.92D
1.8	Z 18 XE, Z 18 XEL	1.8	2002.04 -		411578.92D ▲
1.8	Z 18 XER	1.8	2006.01 -		4431.105D
1.8 16V	Z 18 XE, Z 18 XEL	1.8	2002.04 -		411578.92D ▲
1.9 CDTI	Z 19 DT, Z 19 DTH	1.9	2004.04 -		410049.88D
1.9 CDTI	Z 19 DTL	1.9	2005.10 -		410049.88D
2.0 16V Turbo	Z 20 NET	2.0	2003.03 -		411193.82D
2.0 DTI	Y 20 DTH	2.0	2003.10 -		4297.92D
2.0 DTI 16V	Y 20 DTH	2.0	2002.04 -		4297.92D
2.0 Turbo	Z 20 NET	2.0	2003.10 -		411193.82D
2.2 16V	Z 22 SE	2.2	2002.04 -		411193.82D
2.2 direct	Z 22 YH	2.2	2003.10 -		411193.82D
2.2 DTI	Y 22 DTR	2.2	2003.10 -		4297.92D
2.2 DTI 16V	Y 22 DTR	2.2	2002.04 - 2004.12		4297.92D

OPEL

	Motor Engine Moteur	Ltr. Ltr. Ltr.	Jahr Year Année	Einschränkung Restriction* Restriction*	Thermostat Thermostat Thermostat
VIVARO					
1.9 DI	F9Q 762, F9Q 774	1.9	2001.08 -	Chassis No. →1V699999 →1Y799999	410517.89D
1.9 DI	F9Q 762, F9Q 774	1.9	2001.09 -	Chassis No. 2V600001→ 2Y700001→	410517.83D
1.9 DTI	F9Q 760	1.9	2001.08 -		410517.83D
2.0 16V	F4R 720	2.0	2001.08 - 2007.06	Deckel Thermostatgehäuse	126104 ▲
2.0 16V	F4R 720	2.0	2001.08 - 2007.06		3466.89D
2.0 CDTI	M9R 630, M9R 692, M9R 780, M9R 782, M9R 786, M9R 784, M9R 788	2.0	2006.08 -		411476.83D ▲
2.0 ECOTEC	F4R 820	2.0	2006.08 -		3466.89D
ZAFIRA A					
1.6	Z 16 YNG	1.6	2002.09 - 2005.06		4242.92D
1.6 16V	X 16 XEL	1.6	1999.04 - 2005.06		4208.92D
1.6 16V	Z 16 XE	1.6	1999.04 - 2005.06		4242.92D
1.6 CNG	Z 16 YNG	1.6	2001.09 - 2005.06		4242.92D
1.8	Z 18 XEL	1.8	2003.02 - 2005.06		411578.92D ▲
1.8 16V	X 18 XE1, Z 18 XE	1.8	1999.04 - 2005.06		411578.92D ▲
2.0 DI 16V	X 20 DTL	2.0	1999.10 - 2005.06		4198.92D
2.0 DTI 16V	Y 20 DTH	2.0	2000.09 - 2005.06	Motor no. →17B49754	4198.92D
2.0 DTI 16V	Y 20 DTH	2.0	2000.10 - 2005.06	Motor no. 17B49755→, → 2(2/5/6/8/B/H) 999999	4428.92D
2.0 DTI 16V	Y 20 DTH	2.0	2000.11 - 2005.06	Motor no. 3(2/5/6/8/B/H) 999999 →	4433.92D
2.0 OPC	Z 20 LET, Z 20 LER	2.0	2001.09 - 2005.06		4183.92D
2.2 16V	Z 22 SE	2.2	2000.09 - 2005.06		411193.82D
2.2 DTI 16V	Y 22 DTR	2.2	2002.01 - 2005.06		4433.92D
ZAFIRA B					
1.6	A 16 XER, Z 16 XE1, Z 16 XER, Z 16 XEP	1.6	2005.07 -		4431.105D
1.6 CNG	Z 16 YNG	1.6	2006.01 -		4242.92D
1.6 CNG Turbo	A 16 XNT, Z 16 XNT	1.6	2009.02 -		4357.92D
1.8	Z 18 XER, A 18 XER	1.8	2005.07 -		4431.105D
1.9 CDTI	Z 19 DT, Z 19 DTH, Z 19 DTL	1.9	2005.07 -		410049.88D
2.0	Z 20 LEH, Z 20 LER	2.0	2005.07 -		4183.92D
2.2	Z 22 YH	2.2	2005.07 -		411193.82D
ZAFIRA C					
1.6 CNG	A 16 XNT	1.6	2011.10 -		411059.105D ▲
1.8	A 18 XEL, A 18 XER	1.8	2011.10 -		411059.105D ▲

PEUGEOT
**Motor
Engine
Moteur**
**Ltr.
Ltr.
Ltr.**
**Jahr
Year
Année**
**Einschränkung
Restriction*
Restriction***
**Thermostat
Thermostat
Thermostat**
104

0.9	108 (XV3), 108 (XV5)	0.9	1972.10 - 1983.10		3136.88D50
1.0	108C (XV8)	1.0	1983.09 - 1988.06		3136.82D50
1.1	109 (XW3), 109F (XW7), 121 (XW3S), XW3S	1.1	1976.07 - 1988.06		3136.82D50
1.2	129 (XZ5)	1.2	1979.08 - 1983.06		3136.82D50
1.4	150 (XY6B)	1.4	1979.08 - 1984.06		3136.82D50

106 I

1.0	CDZ (TU9M), TU9, CDY (TU9M)	1.0	1991.09 - 1996.04		3136.88D50
1.1	HDZ (TU1M)	1.1	1991.09 - 1996.04		3136.88D50
1.3	TU2J2	1.3	1993.10 - 1996.04		3136.82D50
1.4	K5A (TU3), KDX (TU3MC), KDY (TU3M), KFZ (TU3J2, Z)	1.4	1991.08 - 1996.03		3136.88D50
1.4 D	K9Y (TUD3Y)	1.4	1992.09 - 1996.04		4821.89D
1.5 D	VJY (TUD5)	1.5	1994.06 - 1996.04		4821.89D
1.6	NFY (TU5J2), NFZ (TU5JP)	1.6	1993.06 - 1996.04		3136.88D50

106 II

1.0 i	CDY (TU9M), CDZ (TU9M)	1.0	1996.05 -		3136.88D50
1.1 i	HDZ (TU1M)	1.1	1996.05 -		3136.88D50
1.1 i	HFX (TU1JP)	1.1	1996.05 -		410184.89D
1.4 i	KFX (TU3JP), KFW (TU3JP)	1.4	1996.05 -	Organisations no. →O 08210	3136.88D50
1.4 i	KFX (TU3JP), KFW (TU3JP)	1.4	1996.06 -	Organisations no. O 08211→	410184.89D
1.5 D	VJX (TUD5), VJY (TUD5)	1.5	1996.05 -		4821.89D
1.6 i	NFW (TU5J2), NFY (TU5J2)	1.6	1996.05 -		3136.88D50
1.6 i	NFZ (TU5JP)	1.6	1996.05 -	Organisations no. →O 08210	3136.88D50
1.6 S16	NFX (TU5J4)	1.6	1996.05 -		3136.88D50

205 I

1.0	108C (XV8)	1.0	1983.02 - 1987.10		3136.82D50
1.1	109F (XW7), 109N (XW7),	1.1	1983.02 - 1994.12		3136.82D50
1.1	HDZ (TU1M)	1.1	1989.10 - 1994.12		3136.88D50
1.4	150 (XY6B), 150B (XY8), 150D (XY7), 150G (XY7), 150H (XY8)	1.4	1983.02 - 1989.05		3136.82D50
1.4 CJ	K1D (TU3A), KAY (TU3CP), KDZ (TU3M), KDY (TU3M)	1.4	1989.01 - 1994.12		3136.88D50
1.6	B1A (XU51C), B1E (XU51C), BAZ (XU5CP)	1.6	1986.08 - 1987.10		3136.82D50
1.6	BDY (XU5M3Z)	1.6	1992.08 - 1994.12		3136.88D50
1.6 CTI / GTI	180A (XU5J), 180Z (XU5J)	1.6	1984.12 - 1987.10	82° Variante	3136.82D50
1.6 CTI / GTI	180A (XU5J), 180Z (XU5J)	1.6	1984.12 - 1987.10	88° Variante	3136.88D50
1.7 Diesel	161A (XUD7)	1.7	1983.08 - 1987.10		4147.80D
1.9 CTI	DFZ (XU9J1)	1.9	1987.10 - 1990.12		3136.82D50

205 II

1.0	TU9	1.0	1987.10 - 1998.09		3136.88D50
1.1	109N (XW7)	1.1	1987.10 - 1990.10		3136.82D50
1.1	H1B (TU1), HDZ (TU1M)	1.1	1987.10 - 1998.09		3136.88D50
1.3 Rallye	TU24	1.3	1987.10 - 1990.10		3136.88D50
1.4	150 (XY6B), 150B (XY8), 150H (XY8), 150D (XY7), 150G (XY7)	1.4	1987.01 - 1989.05		3136.82D50
1.4	K2B (TU3S)	1.4	1987.06 - 1989.12	82° Variante	3136.82D50

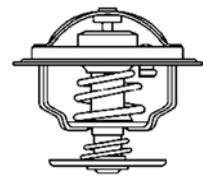

PEUGEOT

	Motor Engine Moteur	Ltr. Ltr. Ltr.	Jahr Year Année	Einschränkung Restriction* Restriction*	Thermostat Thermostat Thermostat
1.4	K2B (TU3S)	1.4	1987.06 - 1989.12	88° Variante	3136.88D50
1.4	K1D (TU3A), KAY (TU3CP), KFX (TU-3JP), KDZ (TU3M), KDY (TU3M)	1.4	1987.08 - 1998.09		3136.88D50
1.6	B1A (XU51C), B1E (XU51C), BAZ (XU5CP), BDY (XU5M2Z), BDY (XU5M3Z)	1.6	1987.10 - 1998.09	82° Variante	3136.82D50
1.6	B1A (XU51C), B1E (XU51C), BAZ (XU5CP), BDY (XU5M2Z), BDY (XU5M3Z)	1.6	1987.10 - 1998.09	88° Variante	3136.88D50
1.6 GTI	180A (XU5J), 180Z (XU5J)	1.6	1987.10 - 1989.12	82° Variante	3136.82D50
1.6 GTI	180A (XU5J), 180Z (XU5J)	1.6	1987.10 - 1989.12	88° Variante	3136.88D50
1.7 Diesel	161A (XUD7)	1.7	1987.07 - 1998.09		4147.80D
1.7 TD	A8B (XUD7TE)	1.7	1990.01 - 1992.05		4147.80D
1.7 TD	A8B (XUD7TE)	1.7	1992.06 - 1998.09		4446.83D
1.8 XDT	XUD7T	1.8	1990.08 - 1997.05		4147.80D
1.9 Diesel	DJZ (XUD9Y), XUD9	1.9	1987.08 - 1992.05		4147.80D
1.9 Diesel	DJZ (XUD9Y), XUD9	1.9	1992.06 - 1998.09		4446.83D
1.9 GTI	D2A (XU92C), D6B (XU9JA), DFZ (XU9J1), DKZ (XU9JAZ)	1.9	1987.10 - 1994.07	82° Variante	3136.82D50
1.9 GTI	D2A (XU92C), D6B (XU9JA), DFZ (XU9J1), DKZ (XU9JAZ)	1.9	1987.10 - 1994.07	88° Variante	3136.88D50
205 Kasten					
1.1	H1B (TU1)	1.1	1983.02 - 1987.07	82° Variante	3136.82D50
1.1	H1B (TU1)	1.1	1987.08 - 1990.07	88° Variante	3136.88D50
1.4		1.4	1983.02 - 1987.07		3136.82D50
1.7 Diesel	161A (XUD7)	1.7	1994.03 -		4446.83D
1.8 D	A9A (XUD7)	1.8	1983.02 - 1990.07		4147.80D
206					
1.1	HFX (TU1JP)	1.1	1998.08 -		3463.89D
1.1 i	HFZ (TU1JP), HFX (TU1JP)	1.1	1998.09 -		3463.89D
1.4	KFV (TU3A), KFW (TU3JP)	1.4	2002.07 -		3463.89D
1.4 16V	KFU (ET3J4)	1.4	2003.10 -	Organisations no. →10373	3463.89D
1.4 16V	KFU (ET3J4)	1.4	2003.11 -	Organisations no. 10374→	410705.89D
1.4 i	KFX (TU3JP), KFW (TU3JP)	1.4	1998.09 -		3463.89D
1.4 LPG	KFV (TU3JP)	1.4	2006.05 - 2007.09	Organisations no. →10373	3463.89D
1.4 LPG	KFV (TU3JP)	1.4	2006.06 - 2007.09	Organisations no. 10374→	410705.89D
1.6 16V	NFU (TU5JP4)	1.6	2000.09 -	Organisations no. →10401	3463.89D
1.6 16V	NFU (TU5JP4)	1.6	2000.10 -	Organisations no. 10402→	410705.89D
1.6 i	NFZ (TU5JP)	1.6	1998.09 - 2000.12		3463.89D
1.9 D	WJZ (DW8)	1.9	1998.09 - 2007.05		4446.83D
2.0 16V	RFN (EW10J4)	2.0	2002.07 -		3483.89D
2.0 HDi	RHY (DW10TD)	2.0	2002.07 -		4446.83D
2.0 HDI 90	RHY (DW10TD)	2.0	1999.12 -		4446.83D
2.0 RC	RFK (EW10J4S)	2.0	2003.07 -		3483.89D
2.0 S16	RFN (EW10J4), RFR (DEW10J4)	2.0	1999.04 -		3483.89D
206 +					
1.1	HFX (TU1A), HFX (TU1JP), TU1AE5	1.1	2009.01 -		3463.89D
1.4 i	KFV (TU3A), KFT (TU3A), KFW (TU3A)	1.4	2009.01 -		3463.89D

PEUGEOT
**Motor
Engine
Moteur**
**Ltr.
Ltr.
Ltr.**
**Jahr
Year
Année**
**Einschränkung
Restriction*
Restriction***
**Thermostat
Thermostat
Thermostat**
207

1.4 16V	KFU (ET3J4)	1.4	2006.02 -		410705.89D
1.6	N6A (TU5JP4)	1.6	2008.08 -		410705.89D
1.6 16V	NFU (TU5JP4)	1.6	2006.02 -		410705.89D

305

1.3	118 (XL5)	1.3	1977.11 - 1986.08	82° Variante	3061.82
1.3	118 (XL5)	1.3	1977.11 - 1986.08	88° Variante	3061.88
1.5	117 (XR5S), 142 (XR5), 142 (XR5A)	1.5	1979.11 - 1990.07		3136.82D50
1.5 Diesel	149 (XID)	1.5	1977.11 - 1982.09		4147.80D
1.6	B1A (XU51C), BAZ (XU5CP)	1.6	1982.10 - 1988.12		3136.82D50
1.6	171 (XU5S)	1.6	1982.10 - 1988.06	82° Variante	3136.82D50
1.6	171 (XU5S)	1.6	1982.10 - 1988.06	88° Variante	3136.88D50
1.9	159 (XU9S), DFZ (XU9J1)	1.9	1982.10 - 1987.10		3136.82D50
1.9 D	D9A (XUD9), 162 (XUD9)	1.9	1982.10 - 1988.07		4147.80D
1.9 Diesel	D9A (XUD9), 162 (XUD9)	1.9	1982.10 - 1988.12		4147.80D

306

1.1	HDZ (TU1M)	1.1	1993.05 - 2001.05		3136.88D50
1.4	KDX (TU3MC), KFX (TU3JP), KFW (TU3JP)	1.4	1993.05 - 2002.04	Organisations no. →O 08210	3136.88D50
1.4	KDX (TU3MC), KFX (TU3JP), KFW (TU3JP)	1.4	1993.06 - 2002.04	Organisations no. O 08211→	410184.89D
1.6	NFZ (TU5JP)	1.6	1993.05 - 2000.10	Organisations no. →O 08210	3136.88D50
1.6	NFZ (TU5JP)	1.6	1993.06 - 2000.10	Organisations no. O 08211→	410184.89D
1.6	NFT	1.6	2000.10 - 2002.04		3463.89D
1.8	LFZ (XU7JP)	1.8	1995.10 - 1996.07		3136.88D50
1.8	LFZ (XU7JP)	1.8	1996.08 - 2001.05		3136.82D50
1.8 16V	LFY (XU7JP4)	1.8	1997.03 - 2002.04		4450.83D
1.8 D	161 (XUD7), A9A (XUD7)	1.8	1993.04 - 2001.05		4446.83D
1.9 D	XUD9, XUD9TE	1.9	1993.04 - 2002.04		4446.83D
1.9 D	WJY (DW8B), WJZ (DW8)	1.9	1998.09 - 2002.04		4446.83D
1.9 DT	DHY (XUD9TE)	1.9	1993.05 - 2001.05		4450.83D
1.9 SLD	DJY (XUD9A), DJZ (XUD9Y)	1.9	1994.06 - 2001.05		4446.83D
1.9 SRDT	DHY (XUD9TE)	1.9	1994.06 - 2001.05		4446.83D
1.9 STD	XUD9	1.9	1994.02 - 1995.10		4446.83D
1.9 TD	DHY (XUD9TE)	1.9	1997.02 - 2002.04		4450.83D
2.0	RFX (XU10J2)	2.0	1994.03 - 2002.04	Automatikgetriebe	3136.82D50
2.0	RFX (XU10J2)	2.0	1994.03 - 2002.04	Schaltgetriebe	3136.88D50
2.0	RFV (XU10J4R)	2.0	1997.03 - 2002.04		4450.83D
2.0 16V	RFV (XU10J4R)	2.0	1997.03 - 2002.04		4450.83D
2.0 HDI 90	RHY (DW10TD)	2.0	1999.06 - 2002.04		4446.83D
2.0 S16	RFT (XU10J4), RFY (XU10J4Z)	2.0	1993.05 - 2001.05		4450.89D
2.0 S16	RFS (XU10J4RS)	2.0	1996.03 - 2001.05		4450.83D
2.0 XSi	RFX (XU10J2)	2.0	1993.05 - 2001.05	Automatikgetriebe	3136.82D50
2.0 XSi	RFX (XU10J2)	2.0	1993.05 - 2001.05	Schaltgetriebe	3136.88D50

307

1.4	KFW (TU3JP)	1.4	2000.08 - 2003.09		3463.89D
1.4 16V	KFU (ET3J4)	1.4	2003.11 -	Organisations no. →10436	3463.89D
1.4 16V	KFU (ET3J4)	1.4	2003.12 -	Organisations no. 10437→	410705.89D

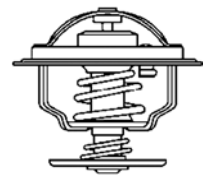

PEUGEOT

	Motor Engine Moteur	Ltr. Ltr. Ltr.	Jahr Year Année	Einschränkung Restriction* Restriction*	Thermostat Thermostat Thermostat
1.6 16V	NFU (TU5JP4)	1.6	2000.08 -	Organisations no. →10436	3463.89D
1.6 16V	NFU (TU5JP4)	1.6	2000.09 -	Organisations no. 10437→	410705.89D
1.6 BioFlex	NFU (TU5JP4)	1.6	2007.09 -		3463.89D
2.0	RFN (EW10J4)	2.0	2002.03 -		3483.89D
2.0 16V	RFK (EW10J4S), RFN (EW10J4)	2.0	2000.08 -		3483.89D
2.0 HDi 110	RHS (DW10ATED)	2.0	2000.08 -		4446.83D
2.0 HDi 90	RHY (DW10TD)	2.0	2000.08 -		4446.83D
309					
1.1	H1B (TU1), HDZ (TU1M)	1.1	1989.09 - 1993.12		3136.88D50
1.4	K1D (TU3A), K2B (TU3S), KDY (TU3M), KDZ (TU3M)	1.4	1989.03 - 1993.12		3136.88D50
1.6	XU5CP, XU5J, XU5M, XU5M2Z, XU5M3Z, XU51C. XU52C	1.6	1985.10 - 1993.12	82° Variante	3136.82D50
1.6	XU5CP, XU5J, XU5M, XU5M2Z, XU5M3Z, XU51C. XU52C	1.6	1985.10 - 1993.12	88° Variante	3136.88D50
1.8 Diesel	161A (XUD7)	1.8	1989.07 - 1992.05		4147.80D
1.8 Diesel	161A (XUD7)	1.8	1992.06 - 1993.12		4446.83D
1.8 TD	A8B (XUD7TE)	1.8	1989.08 - 1992.05		4147.80D
1.8 TD	A8B (XUD7TE)	1.8	1992.06 - 1993.12		4446.83D
1.9	XU9J, XU9M, XU9S,	1.9	1985.10 - 1993.12	88° Variante	3136.82D50
1.9	XU9J, XU9M, XU9S,	1.9	1985.10 - 1993.12	82° Variante	3136.82D50
1.9 D	D9A (XUD9), 162 (XUD9)	1.9	1986.06 - 1989.07		4147.80D
1.9 Diesel	D9A (XUD9), DJZ (XUD9Y), 162 (XUD9)	1.9	1989.07 - 1992.05		4147.80D
1.9 Diesel	D9A (XUD9), DJZ (XUD9Y), 162 (XUD9)	1.9	1992.06 - 1993.12		4446.83D
1.9 GTI	D6B (XU9JA), DKZ (XU9JAZ)	1.9	1986.10 - 1993.12	82° Variante	3136.82D50
1.9 GTI	D6B (XU9JA), DKZ (XU9JAZ)	1.9	1986.10 - 1993.12	88° Variante	3136.88D50
405 I					
1.4	K5A (TU3)	1.4	1987.01 - 1992.07		3136.88D50
1.6	XU5CP, XU51C, XU52C, XU52K, XU5M, XU5M2Z, XU5M3Z	1.6	1987.07 - 1992.12	82° Variante	3136.82D50
1.6	XU5CP, XU51C, XU52C, XU52K, XU5M, XU5M2Z, XU5M3Z	1.6	1987.07 - 1992.12	88° Variante	3136.88D50
1.8 D	A8A (XUD7TE)	1.8	1987.10 -		4147.80D
1.8 D	A8A (XUD7TE)	1.8	1991.05 - 1992.07		4446.83D
1.8 DT	A8A (XUD7TE)	1.8	1990.05 -		4147.80D
1.8 DT	A8A (XUD7TE)	1.8	1991.05 - 1992.07		4446.83D
1.8 TD	A8A (XUD7TE), AJZ (XUD7TEY)	1.8	1991.05 -		4147.80D
1.8 TD	A8A (XUD7TE), AJZ (XUD7TEY)	1.8	1991.05 - 1992.08		4446.83D
1.8 Turbo Diesel	A8A (XUD7TE), AJZ (XUD7TEY)	1.8	1988.03 -		4147.80D
1.8 Turbo Diesel	A8A (XUD7TE), AJZ (XUD7TEY)	1.8	1991.05 - 1992.12		4446.83D
1.9	XU92C, XU9J4, XU9M, XU9J1, XU9JAZ	1.9	1987.07 - 1993.12	82° Variante	3136.82D50
1.9	XU92C, XU9J4, XU9M, XU9J1, XU9JAZ	1.9	1987.07 - 1993.12	88° Variante	3136.88D50
1.9 D	DJY (XUD9A), D9B (XUD9A), DJZ (XUD9Y)	1.9	1988.10 - 1992.08		4147.80D
1.9 Diesel	D9B (XUD9A), DJZ (XUD9Y)	1.9	1988.03 - 1992.12		4147.80D

PEUGEOT
**Motor
Engine
Moteur**
**Ltr.
Ltr.
Ltr.**
**Jahr
Year
Année**
**Einschränkung
Restriction*
Restriction***
**Thermostat
Thermostat
Thermostat**

405 II					
1.4	KDX (TU3MC)	1.4	1992.08 - 1996.10		3136.88D50
1.6	BFZ (XU5JP), BDY (XU5M2Z), BDZ (XU5M), BDY (XU5M3Z)	1.6	1992.08 - 1996.10	Automatikgetriebe	3136.82D50
1.6	BFZ (XU5JP), BDY (XU5M2Z), BDZ (XU5M), BDY (XU5M3Z)	1.6	1992.08 - 1996.10	Schaltgetriebe	3136.88D50
1.8	LFZ (XU7JP)	1.8	1992.08 - 1996.10	Automatikgetriebe	3136.82D50
1.8	LFZ (XU7JP)	1.8	1992.08 - 1996.10	Schaltgetriebe	3136.88D50
1.9 D	DJY (XUD9A), DJZ (XUD9Y)	1.9	1992.08 - 1996.10		4446.83D
1.9 D	XUD9	1.9	1993.09 - 1995.12		4446.83D
1.9 TD	DHY (XUD9TE)	1.9	1992.08 - 1996.10		4446.83D
2.0	RFX (XU10J2)	2.0	1992.08 - 1996.10	Automatikgetriebe	3136.82D50
2.0	RFX (XU10J2)	2.0	1992.08 - 1996.10	Schaltgetriebe	3136.88D50
2.0 16V	RFT (XU10J4)	2.0	1994.06 - 1995.10		4450.89D
2.0 MI-16	RFY (XU10J4Z)	2.0	1992.08 - 1995.10		4450.89D
2.0 T 16 X4	RGZ (XU10J4TE, Z)	2.0	1992.08 - 1995.10		4450.89D
406					
1.6	BFZ (XU5JP)	1.6	1995.11 - 2004.05		3136.82D50
1.8	LFX (XU7JB), LFZ (XU7JP)	1.8	1996.10 - 2004.10		3136.82D50
1.8 16V	LFY (XU7JP4)	1.8	1995.11 - 2000.10		4450.83D
1.8 16V	6FZ (EW7J4)	1.8	2000.10 - 2004.10		3483.89D
1.9 D	DHW (XUD9SD)	1.9	1996.10 - 2004.10		4446.83D
1.9 TD	DHY (XUD9TE), DHX (XUD9TE)	1.9	1996.01 - 2004.10		4446.83D
2.0 16V	RFV (XU10J4R)	2.0	1995.11 - 2004.12		4450.83D
2.0 16V	RFR (DEW10J4)	2.0	1999.01 - 2000.10		3483.89D
2.0 16V	RFN (EW10J4)	2.0	2000.08 - 2004.12		3483.89D
2.0 16V HPi	RLZ (EW10D)	2.0	2001.05 - 2004.10		3483.89D
2.0 HDI 110	RHS (DW10ATED), RHZ (DW10ATED)	2.0	1998.06 - 2004.10		4446.83D
2.0 HDI 90	RHY (DW10TD)	2.0	1999.02 - 2004.10		4446.83D
2.0 Turbo	RGX (XU10J2TE)	2.0	1996.04 - 2004.10		3136.82D50
2.1 TD 12V	P8C (XUD11BTE)	2.1	1996.01 - 2004.10	80° Variante	4447.80D
2.1 TD 12V	P8C (XUD11BTE)	2.1	1996.01 - 2004.10	85° Variante	4447.85D
2.2	3FZ (EW12J4)	2.2	2000.07 - 2004.12		3483.89D
2.2 HDi	4HX (DW12TED4, FAP)	2.2	2000.03 - 2004.12		4446.83D
407					
1.8	6FZ (EW7J4)	1.8	2004.05 -		3483.89D
2.0	RFN (EW10J4)	2.0	2004.05 -		3483.89D
2.2	3FZ (EW12J4)	2.2	2004.05 -		3483.89D
2.2 16V	3FY (EW12J4)	2.2	2005.09 -		3483.89D
504					
1.6	XC7P	1.6	1980.01 - 1987.06		3053.75
1.8	XM	1.8	1968.07 - 1989.12		3053.75
1.8 Injection	KF6, KF5	1.8	1968.07 - 1971.02		3053.75
1.9 D	XD4x88	1.9	1973.03 - 1989.12		3053.75
2.0	106 (XN1), 107 (XN2)	2.0	1971.03 - 1986.06	82° Variante	3061.82
2.0	106 (XN1), 107 (XN2)	2.0	1971.03 - 1986.06	88° Variante	3061.88
2.0	XN1	2.0	1971.04 - 1986.07		3053.75
2.0 TI	107 (XN2)	2.0	1971.01 - 1983.06		3061.82
2.1 D	XD4x90	2.1	1971.02 - 1986.07	75° Variante	3053.75
2.1 D	XD4x90	2.1	1971.02 - 1986.07	85° Variante	3053.85
2.3 D	134 (XD2)	2.3	1975.07 - 1989.12		3053.75
2.7	140 (ZMJ)	2.7	1977.10 - 1984.08		4122.87D

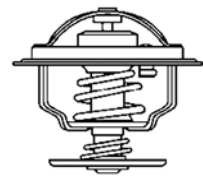

PEUGEOT

	Motor Engine Moteur	Ltr. Ltr. Ltr.	Jahr Year Année	Einschränkung Restriction* Restriction*	Thermostat Thermostat Thermostat
505					
1.8	105 (XM7)	1.8	1981.06 - 1985.10	82° Variante	3061.82
1.8	105 (XM7)	1.8	1981.06 - 1985.10	88° Variante	3061.88
2.0	106 (XN1), 106E (XN1A)	2.0	1980.11 - 1985.12	82° Variante	3061.82
2.0	106 (XN1), 106E (XN1A)	2.0	1980.11 - 1985.12	88° Variante	3061.88
2.0 TI, STI	829 (ZEJ)	2.0	1979.08 - 1986.10		4122.87D
2.2	851 (ZDJ), 851X (ZDJL)	2.2	1981.05 - 1984.10		4122.87D
2.2 GTI	851B (ZDJL)	2.2	1983.08 - 1993.12		4122.87D
2.3 Diesel	147 (XD2S)	2.3	1982.04 - 1986.06		3053.75
2.3 Turbo Diesel	147 (XD2S)	2.3	1980.09 - 1986.06		3053.75
2.5 Diesel	155 (XD3)	2.5	1981.06 - 1993.12		4147.80D
2.5 Turbo Diesel	152A (XD3T), 152B (XD3TE)	2.5	1983.10 - 1993.12		4147.80D
2.8 GTI V6	154X (ZN3J)	2.8	1986.06 - 1993.12		4122.87D
604					
2.3 TD	147 (XD2S)	2.3	1979.09 - 1983.05		3053.75
2.5 TD	152A (XD3T)	2.5	1983.08 - 1986.12		4147.80D
2.7 SL	112 (ZM)	2.7	1977.08 - 1983.05	82° Variante	3061.82
2.7 SL	112 (ZM)	2.7	1977.08 - 1983.05	88° Variante	3061.88
2.7 TI, STI	140 (ZMJ)	2.7	1977.08 - 1983.05	82° Variante	3061.82
2.7 TI, STI	140 (ZMJ)	2.7	1977.08 - 1983.05	88° Variante	3061.88
2.8 GTI	154A (ZMJK)	2.8	1983.09 - 1987.07		4122.87D
605					
2.0	R5A (XU102C), RFZ (XU10J2Z)	2.0	1989.06 - 1999.09	82° Variante	3136.82D50
2.0	R5A (XU102C), RFZ (XU10J2Z)	2.0	1989.06 - 1999.09	88° Variante	3136.88D50
2.0 16V	RFV (XU10J4R)	2.0	1994.07 - 1999.09		4450.83D
2.0 Turbo	RGY (XU10J2TE), RGX (XU10J2TE)	2.0	1991.07 - 1999.09	82° Variante	3136.82D50
2.0 Turbo	RGY (XU10J2TE), RGX (XU10J2TE)	2.0	1991.07 - 1999.09	88° Variante	3136.88D50
2.1 D	P9A (XUD11A)	2.1	1991.01 - 1995.07		4447.85D
2.1 TD 12V	P8C (XUD11BTE)	2.1	1994.08 - 1999.09	Automatikgetriebe	4447.80D
2.1 TD 12V	P8C (XUD11BTE)	2.1	1994.08 - 1999.09	Schaltgetriebe	4447.85D
2.1 Turbo Diesel	PHZ (XUD11ATE)	2.1	1989.06 - 1999.09	Automatikgetriebe	4447.80D
2.1 Turbo Diesel	PHZ (XUD11ATE)	2.1	1989.06 - 1999.09	Schaltgetriebe	4447.85D
607					
2.0	RFN (EW10J4)	2.0	2000.02 -		3483.89D
2.0 HDI	RHS (DW10ATED), RHZ (DW10ATED)	2.0	2000.05 -		4446.83D
2.2 16V	3FY (EW12J4), 3FZ (EW12J4)	2.2	2000.02 -		3483.89D
2.2 HDI	4HX (DW12TED4, FAP)	2.2	2000.02 -		4446.83D
806					
1.8	LFW (XU7JP)	1.8	1995.07 - 2002.08	Organisations no. →O 07195	3136.88D50
1.8	LFW (XU7JP)	1.8	1995.08 - 2002.08	Organisations no. →O 07196	3136.82D50
1.9 TD	DHX (XUD9TE), DHY (XUD9TE)	1.9	1995.07 - 2002.08		4446.83D
2.0	RFU (XU10J2)	2.0	1994.06 - 2002.08	Organisations no. →O 07195	3136.88D50
2.0	RFU (XU10J2)	2.0	1994.07 - 2002.08	Organisations no. O 07196→	3136.82D50
2.0 16V	RFV (XU10J4R)	2.0	1998.05 - 2000.09		4450.83D
2.0 16V	RFN (EW10J4)	2.0	2000.09 - 2002.08		3463.89D
2.0 HDI	RHZ (DW10ATED)	2.0	1999.08 - 2002.08		4446.83D

PEUGEOT
**Motor
Engine
Moteur**
**Ltr.
Ltr.
Ltr.**
**Jahr
Year
Année**
**Einschränkung
Restriction*
Restriction***
**Thermostat
Thermostat
Thermostat**

2.0 HDI 16V	RHW (DW10ATED4)	2.0	1999.08 - 2002.08		4446.83D
2.0 Turbo	RGX (XU10J2TE)	2.0	1994.06 - 2002.08		3136.82D50
2.1 td 12V	P8C (XUD11BTE)	2.1	1996.06 - 1999.08		4446.83D

807

2.0	RFN (EW10J4)	2.0	2002.06 -		3483.89D
2.0 16V	RFJ (EW10A)	2.0	2005.09 -		3483.89D
2.0 HDi	DW10ATED4	2.0	2002.06 -		4446.83D
2.2	3FZ (EW12J4)	2.2	2002.06 -		3483.89D
2.2 HDi	4HX (DW12TED4, FAP)	2.2	2002.06 -		4446.83D

1007

1.4	KFV (TU3JP)	1.4	2005.04 -		410184.89D
1.4 16V	KFU (ET3J4)	1.4	2005.10 -		410705.89D
1.6 16V	NFU (TU5JP4)	1.6	2005.04 -	Organisations no. →10401	410184.89D
1.6 16V	NFU (TU5JP4)	1.6	2005.05 -	Organisations no. 10402→	410705.89D

BIPPER (AA_)

1.4	KFV (TU3A)	1.4	2008.02 -		3463.89D
-----	------------	-----	-----------	--	----------

BOXER (230)

1.9 D	D9B (XUD9AU), DJY (XUD9A)	1.9	1994.03 - 2002.04		4446.83D
1.9 DT	XUD9TE	1.9	1996.03 - 1998.09		4450.83D
1.9 TD	D8C (XUD9UTF), DHY (XUD9TE)	1.9	1994.03 - 2002.04		4450.83D
2.0 HDI	RHV (DW10UTD)	2.0	2001.08 - 2002.04		4446.83D
2.0 i	RFW (XU10J2)	2.0	1994.03 - 2002.04		3136.82D50
2.5 D	T9A (DJ5)	2.5	1994.03 - 2002.04	Einbauseite Zylinderkopf	410058.84D
2.5 TD	T8A (DJ5T)	2.5	1994.03 - 2002.04	Einbauseite Zylinderkopf	410058.84D
2.5 TDI	THX (DJ5TED)	2.5	1997.01 - 2002.04	Einbauseite Zylinderkopf	410058.84D
2.8 HDI	8140.43S (F28DTCR)	2.8	2000.11 - 2002.04	82° Variante Serie	4174.82D
2.8 HDI	8140.43S (F28DTCR)	2.8	2000.11 - 2002.04	88° Variante	4174.88D ▲

BOXER (244)

2.0	RFL (XU10J2U)	2.0	2002.04 -	82° Variante	3136.82D50
2.0	RFL (XU10J2U)	2.0	2002.04 -	88° Variante	3136.88D50
2.0 HDi	RHV (DW10TD), RHV (DW10UTD)	2.0	2002.04 -		4446.83D
2.2 HDi	4HY (DW12UTED)	2.2	2002.04 -		4446.83D
2.8 HDi	8140.43N, 8140.43S (F28DTCR)	2.8	2002.04 -	82° Variante Serie	4174.82D
2.8 HDi	8140.43N, 8140.43S (F28DTCR)	2.8	2002.04 -	88° Variante	4174.88D ▲

BOXER

2.2 HDi 100	4HV (P22DTE)	2.2	2006.04 -		3497.88D
2.2 HDi 120	4HU (P22DTE)	2.2	2006.04 -		3497.88D
2.2 HDi 130		2.2	2011.03 -		3497.88D
2.2 HDi 150		2.2	2011.03 -		3497.88D
2.3 HDi		2.3	2007.02 -		3171.82D
3.0 HDi		3.0	2006.07 -		410075.79D ▲
3.0 HDi 145		3.0	2010.04 -		410075.79D ▲
3.0 HDi 160	F1CE0481D (FG30DT)	3.0	2006.04 -		410075.79D ▲
3.0 HDi 175		3.0	2011.03 -		410075.79D ▲

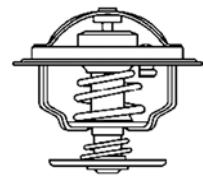

PEUGEOT

	Motor Engine Moteur	Ltr. Ltr. Ltr.	Jahr Year Année	Einschränkung Restriction* Restriction*	Thermostat Thermostat Thermostat
EXPERT					
1.9 D	XUD9TE	1.9	1995.10 - 1998.05		4446.83D
1.9 D	D9B (XUD9AU), WJY (DW8B), WJZ (DW8)	1.9	1996.02 - 2003.11		4446.83D
1.9 D 70	WJY (DW8B), WJZ (DW8)	1.9	1998.12 -		4446.83D
1.9 TD	D8B (XUD9TE), DHX (XUD9TE)	1.9	1996.02 -		4446.83D
2.0	RFN (EW10J4)	2.0	2000.07 -		3483.89D
2.0 HDI	DW10ATED	2.0	2000.07 -		4446.83D
EXPERT Tepee (VF3V_)					
2.0 16V	RFJ (EW10A), RFH (EW10A)	2.0	2007.01 -		3483.89D
J5 (280)					
1.8	169B (XM7T)	1.8	1983.01 - 1988.11	82° Variante	3061.82
1.8	169B (XM7T)	1.8	1983.01 - 1988.11	88° Variante	3061.88
2.0	170 (XN1T), 170B (XN1T)	2.0	1981.09 - 1990.09	82° Variante	3061.82
2.0	170 (XN1T), 170B (XN1T)	2.0	1981.09 - 1990.09	88° Variante	3061.88
2.5 D	CRD93 (U25, 661)	2.5	1981.09 - 1990.09		3033.84D ▲
J5 (290)					
2.0	170D (XN1TACP)	2.0	1990.10 - 1994.02	82° Variante	3061.82
2.0	170D (XN1TACP)	2.0	1990.10 - 1994.02	88° Variante	3061.88
2.5 D	CRD93 (U25, 661)	2.5	1990.10 - 1994.03		3033.84D ▲
2.5 TD	CRD93LS (U25, 673)	2.5	1990.10 - 1994.03		3033.84D ▲
J9					
1.6	XC7P	1.6	1980.03 - 1987.06		3053.75
2.0	XN1P	2.0	1980.03 - 1987.06		3053.75
2.1 D	XDPX90	2.1	1980.03 - 1987.06		3053.75
2.3 D	XD2PX94	2.3	1980.03 - 1982.07		3053.75
2.5 D	XD3P	2.5	1982.07 - 1987.06		4147.80D
PARTNER					
1.1	HDZ (TU1M)	1.1	1996.06 -		3136.88D50
1.1	HFX (TU1JP)	1.1	1996.06 -		410184.89D
1.4	KFX (TU3JP), TU32, KFW (TU3JP)	1.4	1996.06 -	Organisations no. →O 08210	3136.88D50
1.4	KFX (TU3JP), TU32, KFW (TU3JP)	1.4	1996.07 -	Organisations no. O 08211→	410184.89D
1.4 BiFuel	KFW (TU3JP)	1.4	2003.04 -		3463.89D
1.6	NFR (TU5JP4B), NFU (TU5JP4)	1.6	2008.04 -		410705.89D
1.6 16V	NFU (TU5JP4)	1.6	2001.07 -		410184.89D
1.6 Flex	NFU (TU5JP4)	1.6	2008.09 -		410705.89D
1.8	LFX (XU7JB)	1.8	1997.03 - 2000.08		3136.82D50
1.8 D	A9A (XUD7)	1.8	1996.06 - 1998.02		4446.83D
1.9 D	DJY (XUD9A), WJY (DW8B), WJZ (DW8)	1.9	1996.05 -		4446.83D
2.0 HDi	RHY (DW10TD)	2.0	2000.02 -		4446.83D
PARTNER Tepee					
1.6	NFR (TU5JP4B), NFU (TU5JP4)	1.6	2008.04 -		410705.89D
1.6 Flex	TU5JP	1.6	2008.09 -		410705.89D

PIAGGIO

Motor
Engine
Moteur

Ltr.
Ltr.
Ltr.

Jahr
Year
Année

Einschränkung
Restriction*
Restriction*

Thermostat
Thermostat
Thermostat

PORTER

0.5 D	Lombardini	0.5	2008.06 -		4007.80D
1.2 D	LDW1204	1.2	1995.05 -		4007.80D
1.4 D	LDW1404	1.4	1998.04 -		4007.80D

QUARGO

0.7 D	LDW702	0.7	2004.01 -		4007.80D
-------	--------	-----	-----------	--	----------

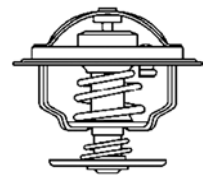
**PLYMOUTH**

	Motor Engine Moteur	Ltr. Ltr. Ltr.	Jahr Year Année	Einschränkung Restriction* Restriction*	Thermostat Thermostat Thermostat
NEON					
2.0 16V	ECB, ECC		1994.05 - 1999.08		410262.91D
2.0 16V	ECH		1999.09 -		410262.91D
VOYAGER					
2.5 TD	ENC		1995.01 - 2001.03		4158.80D

PORSCHE
**Motor
Engine
Moteur**
**Ltr.
Ltr.
Ltr.**
**Jahr
Year
Année**
**Einschränkung
Restriction*
Restriction***
**Thermostat
Thermostat
Thermostat**
911 (996, 997)

3.4 Carrera	M 96	3.4	1997.09 - 2005.08	71° Variante	4249.71D ▲
3.4 Carrera	M 96	3.4	1997.09 - 2005.08	83° Variante Serie	4249.83D
3.4 Carrera 4	M 96	3.4	1997.09 - 2005.08	71° Variante	4249.71D ▲
3.4 Carrera 4	M 96	3.4	1997.09 - 2005.08	83° Variante Serie	4249.83D
3.6	M 96.03	3.6	2001.12 - 2005.08	71° Variante	4249.71D ▲
3.6	M 96.03	3.6	2001.12 - 2005.08	83° Variante Serie	4249.83D
3.6 Carrera	M 96.03, M 96.05	3.6	2001.10 -	71° Variante	4249.71D ▲
3.6 Carrera	M 96.03, M 96.05	3.6	2001.10 -	83° Variante Serie	4249.83D
3.6 Carrera 4	M 96.03, M 96.05	3.6	2001.10 -	71° Variante	4249.71D ▲
3.6 Carrera 4	M 96.03, M 96.05	3.6	2001.10 -	83° Variante Serie	4249.83D
3.6 Carrera 4 S	M 96.03	3.6	2002.06 - 2005.08	71° Variante	4249.71D ▲
3.6 Carrera 4 S	M 96.03	3.6	2002.06 - 2005.08	83° Variante Serie	4249.83D
3.6 Carrera S	M 96.03	3.6	2002.06 - 2005.08	71° Variante	4249.71D ▲
3.6 Carrera S	M 96.03	3.6	2002.06 - 2005.08	83° Variante Serie	4249.83D
3.6 GT2	M 96.70	3.6	2001.04 - 2005.08	71° Variante	4249.71D ▲
3.6 GT2	M 96.70	3.6	2001.04 - 2005.08	83° Variante Serie	4249.83D
3.6 GT3	M 96.76, M 96.79	3.6	1999.03 - 2005.08	71° Variante	4249.71D ▲
3.6 GT3	M 96.76, M 96.79	3.6	1999.03 - 2005.08	83° Variante Serie	4249.83D
3.6 Turbo 4	M 96.70	3.6	2000.06 - 2005.08	71° Variante	4249.71D ▲
3.6 Turbo 4	M 96.70	3.6	2000.06 - 2005.08	83° Variante Serie	4249.83D
3.6 Turbo 4 S	M 96.70	3.6	2003.02 - 2005.08	71° Variante	4249.71D ▲
3.6 Turbo 4 S	M 96.70	3.6	2003.02 - 2005.08	83° Variante Serie	4249.83D
3.8 Carrera 4 S	M 97.01, M 97.01S	3.8	2004.07 -	71° Variante	4249.71D ▲
3.8 Carrera 4 S	M 97.01, M 97.01S	3.8	2004.07 -	83° Variante Serie	4249.83D
3.8 Carrera S	M 97.01, M 97.01S	3.8	2004.07 -	71° Variante	4249.71D ▲
3.8 Carrera S	M 97.01, M 97.01S	3.8	2004.07 -	83° Variante Serie	4249.83D

924

2.0	XJ, XK	2.0	1975.11 - 1989.08		4006.82D
2.0 Carrera GT	M 31.50	2.0	1980.06 - 1986.10		4256.83D60
2.0 Turbo	M 31.01, M 31.03	2.0	1978.11 - 1986.10		4006.82D
2.5 S	M 44.01, M 44.03, M 44.07, M 44.08, M 44.09, M 44.10	2.5	1981.10 - 1988.07		4256.83D60

928

4.5	M 28.10, M 28.09, M 28.01, M 28.02	4.5	1977.09 - 1982.08		4161.83
4.7 S	M 28.11, M 28.12, M 28.21, M 28.22	4.7	1979.09 - 1986.07		4161.83
5.0 GT	M 28.47	5.0	1989.01 - 1991.07		4161.83
5.0 S	M 28.45, M 28.46	5.0	1985.09 - 1986.12		4161.83
5.0 S 4	M 28.41, M 28.42	5.0	1986.08 - 1991.07		4161.83
5.0 S, S 4	M 28.41, M 28.42	5.0	1986.08 - 1991.07		4161.83
5.4 GTS	M 28.49, M 28.50	5.4	1991.08 - 1995.11		4161.83

944

2.5	M 44.01, M 44.02, M 44.03, M 44.04, M 44.05, M 44.06, M 44.07, M 44.08, M 44.09, M 44.10	2.5	1981.06 - 1990.12		4256.83D60
2.5 S	M 44.40	2.5	1986.08 - 1988.07		4256.83D60
2.5 Turbo	M 44.50, M 44.51, M 44.52	2.5	1985.08 - 1991.07		4256.83D60
2.7	M 44.12, M 44.11	2.7	1988.11 - 1989.08		4256.83D60
3.0 S 2	M 44.41	3.0	1988.12 - 1991.07		4256.83D60

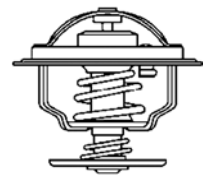

PORSCHE

	Motor Engine Moteur	Ltr. Ltr. Ltr.	Jahr Year Année	Einschränkung Restriction* Restriction*	Thermostat Thermostat Thermostat
968					
3.0	M 44.43, M 44.44	3.0	1991.06 - 1995.11		4256.83D60
3.0 Turbo S		3.0	1993.03 - 1995.11		4256.83D60
BOXSTER (986)					
2.5	M 96.20	2.5	1996.09 - 1999.08	71° Variante	4249.71D ▲
2.5	M 96.20	2.5	1996.09 - 1999.08	83° Variante Serie	4249.83D
2.7	M 96.22, M 96.23	2.7	1999.08 - 2004.12	71° Variante	4249.71D ▲
2.7	M 96.22, M 96.23	2.7	1999.08 - 2004.12	83° Variante Serie	4249.83D
S 3.2	M 96.21, M 96.24	3.2	1999.08 - 2004.12	71° Variante	4249.71D ▲
S 3.2	M 96.21, M 96.24	3.2	1999.08 - 2004.12	83° Variante Serie	4249.83D
BOXSTER (987)					
2.7	M 96.25	2.7	2004.11 -	71° Variante	4249.71D ▲
2.7	M 96.25	2.7	2004.11 -	83° Variante Serie	4249.83D
S 3.2	M 96.26	3.2	2004.11 -	71° Variante	4249.71D ▲
S 3.2	M 96.26	3.2	2004.11 -	83° Variante Serie	4249.83D
CAYENNE					
3.2	M02.2Y	3.2	2003.10 -		4455.80D

PROTON

 Motor
Engine
Moteur

 Ltr.
Ltr.
Ltr.

 Jahr
Year
Année

 Einschränkung
Restriction*
Restriction*

 Thermostat
Thermostat
Thermostat

PERSONA 300

313 i	G 13 B	1.3	1996.03 -		4637.82D
315 GLi/GLSi	4 G 15 M	1.5	1996.03 -		3119.88D4
315 GLSi	G 15 B	1.5	1996.09 -		4637.82D
316	4 G 92	1.6	1996.03 -		4637.82D
318 16V GTI	4 G 93 (DOHC)	1.8	1996.03 -		4637.82D

PERSONA 400

1.2		1.2	2005.10 -		3166.89D
413		1.3	1994.01 -		4637.82D
413 GLSi	4 G 13	1.3	1994.01 -		4637.82D
415 GLi/GLSi	4 G 15	1.5	1994.01 -		4637.82D
416 GLXi	4 G 92	1.6	1994.01 -		4637.82D
416 i	4 G 92	1.6	1995.12 -		4637.82D
418	4 G 93 (DOHC)	1.8	1996.05 -		4637.82D
418	4 G 93 (DOHC)	1.8	1996.05 -		4637.82D

WIRA

1.3	4 G 13	1.3	2000.08 -		3119.88D4
1.5	4 G 15 M	1.5	2000.08 -		3119.88D4

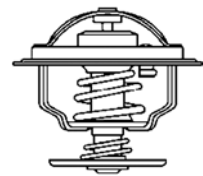

RENAULT

	Motor Engine Moteur	Ltr. Ltr. Ltr.	Jahr Year Année	Einschränkung Restriction* Restriction*	Thermostat Thermostat Thermostat
4					
0.8	800 01, 800 705, 839 706, B1B 707	0.8	1962.10 - 1989.07		3029.86
1.0	689 710, C1C 708	1.0	1985.12 - 1993.12		3029.86
1.1	C1E, 688 711, 688 712	1.1	1976.10 - 1989.07		3029.86
5					
0.8	800 710	0.8	1972.10 - 1984.12		3029.83
1.0	689 710	1.0	1972.01 - 1985.12		3029.83
1.1	C1E 726, 688 713	1.1	1980.09 - 1985.12		3029.83
1.3	810 719, 810 725, 810 726, 810 729	1.3	1975.09 - 1984.09		3029.83
1.4	847 712, 847 725, C2J 713	1.4	1982.01 - 1985.12		3029.83
1.4 Alpine A5	840 725	1.4	1977.09 - 1981.09		3029.83
1.4 Alpine Turbo	840 726, C6J 750	1.4	1981.10 - 1985.01		3029.83
1.4 Turbo	840 730	1.4	1980.06 - 1985.01		3029.83
5 SUPER (B/C/S40)					
1.0	C1C 700	1.0	1984.10 - 1988.10		3029.86
1.1	C1E	1.1	1984.10 - 1996.12		3029.86
1.2	C1G	1.2	1987.01 - 1996.12		3029.86
1.4	C1J, C2J, C3J	1.4	1984.10 - 1990.08		3029.86
1.4 Turbo	C1J 782, C1J 784, C1J 788	1.4	1985.04 - 1990.08		3029.86
1.4 Turbo GT	840 730	1.4	1985.01 - 1991.05		3029.86
1.6 D	F8M 720, F8M 730	1.6	1984.10 - 1996.12		3470.89D50
1.7	F2N 742, F2N 740, F3N 716 , F3N 717	1.7	1986.10 - 1995.03		3470.89D50
1.7 i	F3N 722, F3N 702	1.7	1986.10 - 1991.08		3470.89D50
6					
0.8	800.02	0.8	1969.10 - 1980.04		3029.83
1.1	688.10	1.1	1970.08 - 1987.04		3029.83
9					
1.1	C1E 715, C1E 720	1.1	1981.09 - 1987.05		3029.86
1.2	C1G 700, C1G 710	1.2	1985.09 - 1988.12		3029.86
1.4	C1J, C2J	1.4	1981.12 - 1988.12		3029.86
1.4 Turbo	C1J 764, C1J 760	1.4	1984.04 - 1989.12		3029.83
1.6 D	F8M 730, F8M 700, F8M 720	1.6	1982.10 - 1988.12		3136.82D50
1.7	F2N, FN3	1.7	1984.09 - 1988.12		3470.89D50
11					
1.1	C1E 715, C1E 720	1.1	1983.03 - 1986.06		3029.86
1.2	C1G 700, C1G 710	1.2	1984.10 - 1988.12		3029.86
1.4	C1J, C2J	1.4	1983.03 - 1988.12		3029.86
1.4 Turbo	C1J 764, C1J 760, C1J 770, C1J 782	1.4	1984.04 - 1988.12		3029.86
1.6 D	F8M 730, F8M 700, F8M 720	1.6	1983.08 - 1988.12		3136.82D50
1.7	F2N, F3N	1.7	1983.10 - 1988.12		3470.89D50
12					
1.3	810	1.3	1972.08 - 1980.08		3029.89
1.4	C1J 791	1.4	1976.08 - 1979.05		3029.89
1.6	821.20, 807.20	1.6	1970.08 - 1974.12		3029.78

RENAULT

 Motor
Engine
Moteur

 Ltr.
Ltr.
Ltr.

 Jahr
Year
Année

 Einschränkung
Restriction*
Restriction*

 Thermostat
Thermostat
Thermostat

14

1.2	129	1.2	1976.05 - 1983.12		3136.82D50
1.4	150, X5J	1.4	1979.09 - 1983.12		3136.82D50

15

1.3	810.05	1.3	1972.03 - 1980.10		3029.83
1.6	807.10	1.6	1972.03 - 1980.10		3029.86

16

1.5		1.5	1965.09 - 1975.10		3029.86
1.6	807, 821, 843.04, 807, 807.05	1.6	1968.09 - 1980.08		3029.86

17

1.6	807.10, 844.12	1.6	1972.03 - 1980.10		3029.86
-----	----------------	-----	-------------------	--	---------

18

1.4	847 720, 847 722	1.4	1978.04 - 1986.07		3029.86
1.6	841, A2M, A6M	1.6	1978.04 - 1986.07		3029.86
1.6 Turbo	807 727, A5L 718, A5L 717	1.6	1980.10 - 1986.07		3029.86
1.6 Turbo Inj.	A7L 752	1.6	1982.09 - 1986.07		3029.78
2.0	J6R 714, J6R 716	2.0	1983.05 - 1986.12		4122.87D
2.1 Diesel	852 710, J8S 711	2.1	1979.05 - 1986.07		4147.80D
2.1 TD	J8S 712	2.1	1981.11 - 1986.07		4147.80D
2.2 i	J7T 718	2.2	1984.06 - 1986.07		4122.87D

19

1.2	C1G 730	1.2	1988.01 - 1995.12		3029.86
1.2	E7F 730	1.2	1992.05 - 1994.09		3469.91D
1.4	C1J, C2J, C3J	1.4	1988.07 - 1995.12		3029.86
1.4	E6J, E7J	1.4	1990.09 - 1995.12		3469.91D
1.6	K4M 734	1.6	1997.10 - 1999.06	Deckel Thermostatgehäuse	126104 ▲
1.6	K4M 734	1.6	1997.10 - 1999.06		3466.89D
1.6	K4M 744	1.6	1998.07 - 2001.06	Deckel Thermostatgehäuse, Motor no. →011212	126104 ▲
1.6	K4M 744	1.6	1998.07 - 2001.06	Motor no. →011212	3466.89D
1.7	F3N	1.7	1988.07 - 1995.12		3470.89D50
1.8	F3P	1.8	1992.04 - 1995.12		3470.89D50
1.8 16V	F7P 704	1.8	1989.06 - 1995.12		3470.89D50
1.9 D	F8Q 706, F8Q 742	1.9	1988.09 - 1995.12		3470.89D50
1.9 D	F8Q 744	1.9	1992.05 - 1995.11		4147.80D
1.9 DT	F8Q 610	1.9	1990.09 - 1992.04		3470.89D50
1.9 DT	F8Q 740	1.9	1990.09 - 1992.04		4147.80D
1.9 dT	F8Q 744	1.9	1992.04 - 1995.12		4147.80D
1.9 TD	F8Q 740	1.9	1990.09 - 1992.04		3470.89D50

19 Cabriolet

1.7	F2N, F3N	1.7	1991.07 - 1993.09		3470.89D50
1.8	F3P	1.8	1992.04 - 1996.06		3470.89D50
1.8 16V	F7P 704	1.8	1991.07 - 1996.06		3470.89D50



RENAULT

	Motor Engine Moteur	Ltr. Ltr. Ltr.	Jahr Year Année	Einschränkung Restriction* Restriction*	Thermostat Thermostat Thermostat
19 Kasten					
1.2	C1G 730	1.2	1988.01 - 1995.12		3029.86
1.4	E6J 700	1.4	1988.01 - 1995.12		3469.91D
1.9 D	F8Q 706, F8Q 742	1.9	1988.01 - 1995.12		3470.89D50
1.9 dT	F8Q 740	1.9	1992.03 - 1995.12		4147.80D
20					
1.6	843 720, 843 721	1.6	1975.10 - 1983.12		3053.85
2.0	829	2.0	1977.10 - 1983.12		4122.87D
2.1 Diesel	852	2.1	1980.10 - 1983.12		4147.80D
2.1 TD	J8S 702	2.1	1982.01 - 1983.12		4147.80D
2.2	851 700	2.2	1980.10 - 1983.12		4122.87D
21					
1.4	C2J 770	1.4	1989.09 - 1993.10		3029.86
1.7	F2N, F3N	1.7	1986.03 - 1994.06		3470.89D50
1.9 D	F8Q 710	1.9	1989.08 - 1994.08		3136.82D50
2.2	J7T 754, J7T 755	2.2	1986.06 - 1994.06		3029.89
21 Kasten					
1.7	F2N 710	1.7	1986.06 - 1995.04		3470.89D50
1.9 D	F8Q 710	1.9	1986.06 - 1994.08		3136.82D50
21					
2.1 D	J8S 600, J8S 740, J8S 740, J8S 784	2.1	1986.03 - 1994.08		4147.80D
2.0	J6R, J7R	2.0	1986.03 - 1994.06		3029.89
2.0 Turbo	J7R 752, J7R 756	2.0	1987.04 - 1993.10		3029.89
2.1 Turbo-D	J8S 788, J8S 786, J8S 714	2.1	1986.03 - 1994.06		4147.80D
25					
2.0	J6R J7R	2.0	1984.04 - 1993.12		4122.87D
2.0 12V	J7R 721, J7R 720, J7R 726	2.0	1988.06 - 1993.12		4122.87D
2.1 Diesel	J8S 706, J8S 736	2.1	1984.04 - 1992.12		4147.80D
2.1 Turbo-D	J8S 708, J8S 738	2.1	1984.04 - 1992.12		4147.80D
2.2	J7T	2.2	1984.04 - 1989.12		4122.87D
2.4 V6 Turbo	Z7U 702	2.4	1984.10 - 1990.05		4122.87D
2.5 V6 Turbo	Z7U 700	2.5	1990.01 - 1992.12		4122.87D
2.7 V6 Injection	Z7V 711, Z7V 709, Z7V 708	2.7	1984.04 - 1989.08		4122.87D
2.8 V6	Z7W 700	2.8	1987.06 - 1990.02		4122.87D
2.8 V6 Injection	Z7W 702, Z7W 706, Z7W 707, Z7W 709	2.8	1986.06 - 1992.12		4122.87D
30					
2.1 Turbo-D	J8S 702	2.1	1982.02 - 1986.03		4147.80D
2.6	112, 140, 144	2.6	1975.02 - 1984.01		4122.87D
AVANTIME					
2.0 16V Turbo	F4R 760, F4R 761	2.0	2001.11 - 2003.05		3466.89D
B					
70	8140.61.235	2.4	1983.01 - 1990.12		4151.79D
90	8140.21.235 IDS, 8140.27.2530 IDS	2.4	1986.04 - 1992.01		4151.76D

RENAULT
**Motor
Engine
Moteur**
**Ltr.
Ltr.
Ltr.**
**Jahr
Year
Année**
**Einschränkung
Restriction*
Restriction***
**Thermostat
Thermostat
Thermostat**

CLIO I					
1.1	C1E 700	1.1	1991.01 - 1998.09		3029.86
1.2	E7F	1.2	1990.05 - 1998.09		3469.91D
1.2	C3G 720	1.2	1994.06 - 1998.02		3029.89
1.2	D7F 730	1.2	1996.01 - 1998.09		3174.89D
1.4	E7J	1.4	1991.01 - 1998.09		3469.91D
1.7	F2N 770	1.7	1991.01 - 1993.12		3470.89D50
1.8	F3P	1.8	1991.01 - 1998.09		3470.89D50
1.8 16V	F7P 722	1.8	1991.01 - 1996.03		3470.89D50
1.8 Rsi	F3P 712, F3P 758	1.8	1993.01 - 1998.09		3470.89D50
1.9 D	F8Q 678, F8Q 730, F8Q 732	1.9	1991.01 - 1998.09		3470.89D50
Williams	F7R 700	2.0	1994.01 - 1998.09		3470.89D50
CLIO II					
1.1	D7F 720, D7F 726, D7F 746	1.1	1998.09 -		3166.89D
1.2	D7F	1.2	1998.09 - 2009.06		3166.89D
1.2 16V	D4F	1.2	2001.06 -		3166.89D
1.4	E7J 780	1.4	1998.09 - 2005.05	Deckel Thermostatgehäuse	126104 ▲
1.4	E7J 780	1.4	1998.09 - 2005.05		3466.89D
1.4 16V	K4J 711, K4J 712, K4J 713	1.4	1999.10 -	Deckel Thermostatgehäuse	126104 ▲
1.4 16V	K4J 710	1.4	1999.10 -	Deckel Thermostatgehäuse, Motor no. →011212	126104 ▲
1.4 16V	K4J 711, K4J 712, K4J 713	1.4	1999.10 -		3466.89D
1.4 16V	K4J 710	1.4	1999.10 -	Motor no. →011212	3466.89D
1.5 dCi	K9K 700, K9K 702, K9K 704, K9K 710	1.5	2001.06 -		411043.89D
1.5 dCi	K9K 714, K9K 716, K9K 718, K9K 740	1.5	2003.11 -		411039.83D
1.6	K4M 746, K7M 744, K7M 745	1.6	1998.09 -	Deckel Thermostatgehäuse	126104 ▲
1.6	K4M 746, K7M 744, K7M 745	1.6	1998.09 -		3466.89D
1.6 16V	K4M 743, K4M 748, K4M 740, K4M 742, K4M 708, K4M 745	1.6	1998.09 -	Deckel Thermostatgehäuse	126104 ▲
1.6 16V	K4M 744	1.6	1998.09 -	Deckel Thermostatgehäuse, Motor no. →011212	126104 ▲
1.6 16V	K4M 743, K4M 748, K4M 740, K4M 742, K4M 708, K4M 745	1.6	1998.09 -		3466.89D
1.6 16V	K4M 744	1.6	1998.09 -	Motor no. →011212	3466.89D
1.9 D	F8Q 630	1.9	1998.09 - 2005.05		3470.89D50
1.9 D	F8Q 662	1.9	1999.03 - 2000.01		410530.89D
1.9 D	F8Q 632	1.9	2000.02 - 2000.11		410518.89D
1.9 D	F8Q 632	1.9	2000.11 - 2001.05		410530.89D
1.9 dTi	F9Q 780	1.9	1999.12 - 2000.05		410518.89D
1.9 dTi	F9Q 780	1.9	2000.06 - 2005.05		3470.89D50
2.0 16V Sport	F4R 730, F4R 738	2.0	2000.02 -		3466.89D
CLIO III					
1.2	D7F 766	1.2	2005.05 - 2009.06		3166.89D
1.2 16V	D4F 740, D4F 742, D4F 784	1.2	2005.06 -		3166.89D
1.5 dCi	K9K 750	1.5	2005.05 -		411475.89D ▲
1.5 dCi	K9K 714, K9K 764, K9K 766, K9K 768	1.5	2005.06 -	4 polig	411040.83D
1.5 dCi	K9K 772	1.5	2005.06 -		411042.89D
1.5 dCi	K9K 770	1.5	2010.08 -	2 polig	411442.83D ▲
2.0 16V	M4R 700, M4R 701	2.0	2006.09 -		411241.82D

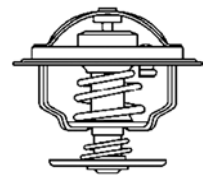

RENAULT

	Motor Engine Moteur	Ltr. Ltr. Ltr.	Jahr Year Année	Einschränkung Restriction* Restriction*	Thermostat Thermostat Thermostat
CLIO IV					
1.2 16V	D4F 740	1.2	2012.11 -		3166.89D
CLIO Grandtour (KR0/1_)					
1.2 16V	D4F 740, D4F 784	1.2	2008.02 -		3166.89D
1.5 dCi	K9K 714, K9K 768	1.5	2008.02 - 2010.01	4 polig	411040.83D
1.5 dCi	K9K 764, K9K 766	1.5	2008.02 -	4 polig	411040.83D
1.5 dCi	K9K 772	1.5	2008.02 -		411042.89D
1.5 dCi	K9K 764, K9K 766, K9K 770	1.5	2008.02 -	2 polig	411442.83D ▲
1.5 dCi	K9K 714, K9K 768	1.5	2010.01 -	2 polig	411442.83D ▲
1.5 dCi	K9K 752	1.5	2010.02 -		411477.89D ▲
DUSTER					
1.6 16V	K4M 616, K4M 690, K4M 718	1.6	2011.01 -	Deckel Thermostatgehäuse	126104 ▲
1.6 16V	K4M 616, K4M 690, K4M 718	1.6	2011.01 -		3466.89D
1.6 Flex	K4M 690	1.6	2011.10 -	Deckel Thermostatgehäuse	126104 ▲
1.6 Flex	K4M 690	1.6	2011.10 -		3466.89D
ESPACE I					
2.0	J6R 234, J6R 236, J6R 734	2.0	1984.07 - 1990.12		4122.87D
2.0 i	J7R 760	2.0	1988.03 - 1992.12		4122.87D
2.1 TD	J8S 774, J8S 240	2.1	1984.10 - 1990.12		4147.80D
2.2	J7T 770	2.2	1986.07 - 1990.12		4122.87D
ESPACE II					
2.0	J7R 768	2.0	1991.01 - 1996.10		3029.89
2.1 TD	J8S 776, J8S 772, J8S 778, J8S 610, J8S 612	2.1	1991.01 - 1996.10		4147.80D
2.2	J7T 772, J7T 776, J7T 773	2.2	1991.01 - 1996.12		3029.89
2.8 V6	Z7W 717, Z7W 712, Z7W 713	2.8	1991.01 - 1996.10		4122.87D
ESPACE III					
1.9 dTi	F9Q 722	1.9	1999.02 - 2000.05	mit Gehäuse	410518.89D
1.9 dTi	F9Q 722	1.9	2000.06 - 2001.03	ohne Gehäuse	3470.89D50
1.9 dTi	F9Q 722	1.9	2000.06 - 2001.03	mit Gehäuse	410518.89D
1.9 dTi	F9Q 722	1.9	2001.03 - 2002.10	mit Gehäuse	410517.89D
2.0	F3R 769, F3R 728, F3R 742, F3R 729, F3R 768, F4R 701, F4R 700	2.0	1996.11 - 2002.10		3470.89D50
2.0 16V	F4R 701, F4R 700	2.0	1998.10 - 2002.10		3466.89D
2.2 12V TD	G8T 716, G8T 714, G8T 760	2.2	1996.11 - 2000.10		4446.83D
2.2 D	G8T 716	2.2	1997.11 - 2000.01		4446.83D
3.0	Z7X 775	3.0	1996.11 - 1998.10		4449.84D
ESPACE IV					
1.9 dCi	F9Q 820	1.9	2002.11 -		410517.89D
2.0	F4R	2.0	2002.11 -		3466.89D
2.0 dCi	M9R	2.0	2006.01 -		411475.89D ▲
2.0 Turbo (JK0B, JK0N)	F4R 796, F4R 795, F4R 794, F4R 797	2.0	2002.11 -		3466.89D
FLUENCE (L30_)					
1.5 dCi	K9K 830, K9K 834, K9K 836, K9K 837	1.5	2010.02 -	2 polig	411442.83D ▲

RENAULT
**Motor
Engine
Moteur**
**Ltr.
Ltr.
Ltr.**
**Jahr
Year
Année**
**Einschränkung
Restriction*
Restriction***
**Thermostat
Thermostat
Thermostat**
FUEGO

1.4	847 720	1.4	1980.02 - 1985.10		3029.86
1.6	A2M 723	1.6	1983.04 - 1985.10		3029.86
1.6 TS/GTS	843 723, A6M 725, A6M 726, 843 724	1.6	1980.10 - 1985.10		3029.86
1.6 Turbo	A5L 750	1.6	1983.08 - 1985.10		3029.86
2.0 TX/GTX	J6R 713, J6R 726, J6R 715, J6R 710, J6R 712, 829 710	2.0	1980.10 - 1985.10		4122.87D
2.1 TD	J8S 712	2.1	1982.08 - 1985.10		4147.80D

GRAND SCÉNIC III (JZ0/1_)

1.4 16V	H4J 700	1.4	2009.02 -		411241.82D
1.5 dCi	K9K 832	1.5	2009.02 -	4 polig	411040.83D
1.5 dCi	K9K 830, K9K 836, K9K 837, K9K 636	1.5	2009.04 -	4 polig	411040.83D
1.5 dCi	K9K 830, K9K 836, K9K 837, K9K 636	1.5	2009.04 -	2 polig	411442.83D ▲
1.5 dCi	K9K 846	1.5	2010.11 -	2 polig	411442.83D ▲
2.0 16V	M4R 711	2.0	2009.02 -		411241.82D

KANGOO (KC0/1_)

1.2	D7F 710, D7F 744, D7F 722, D7F 720, D7F 726, D7F 746	1.2	1997.08 - 1998.06		3174.89D
1.2	D7F 710, D7F 744, D7F 722, D7F 720, D7F 726, D7F 746	1.2	1998.07 -		3166.89D
1.2 16V	D4F 714, D4F 716, D4F 712	1.2	2001.06 -		3166.89D
1.4	E7J 634, 635, 780	1.4	1997.08 -	Deckel Thermostatgehäuse	126104 ▲
1.4	K7J 700	1.4	1997.08 -	Deckel Thermostatgehäuse	126104 ▲
1.4	K7J 700	1.4	1997.08 -		3466.89D
1.4	E7J 634, 635, 780	1.4	1997.08 -		3466.89D
1.5 dCi	K9K 702, K9K 704, K9K 700	1.5	2001.12 -		411043.89D
1.5 dCi	K9K 714, K9K 718	1.5	2005.06 -		411039.83D
1.6	K7M 746	1.6	1999.09 - 2001.06	Deckel Thermostatgehäuse	126104 ▲
1.6	K7M 746	1.6	1999.09 - 2001.06		3466.89D
1.6 16V	K4M 750, K4M 753, K4M 752	1.6	2001.06 -	Deckel Thermostatgehäuse	126104 ▲
1.6 16V	K4M 750, K4M 753, K4M 752	1.6	2001.06 -		3466.89D
1.6 Flex	K4M 730	1.6	2007.01 -	Deckel Thermostatgehäuse	126104 ▲
1.6 Flex	K4M 730	1.6	2007.01 -		3466.89D
1.9 dCi	F9Q 782	1.9	2001.10 -	Motor no. →001211	410518.89D
1.9 dCi	F9Q 782	1.9	2001.11 -	Motor no. 001211→	410517.89D
1.9 dCi	F9Q 790	1.9	2003.10 -		410517.89D
1.9 dTi	F9Q 780	1.9	2000.02 - 2000.05		410518.89D
1.9 dTi	F9Q 780	1.9	2000.06 -		3470.89D50
1.9 RXED	F8Q 632	1.9	1999.09 - 2000.05		410518.89D
1.9 RXED	F8Q 632	1.9	2000.06 - 2000.11		3470.89D50
D 55 1.9	F8Q 662	1.9	1997.08 - 1998.01		3470.89D50
D 55 1.9	F8Q 662	1.9	1998.02 - 2000.05		410530.89D
D 55 1.9	F8Q 662	1.9	2000.06 -		3470.89D50
D 65 1.9	F8Q 632, F8Q 630	1.9	1997.08 - 2000.05		410518.89D
D 65 1.9	F8Q 632, F8Q 630	1.9	2000.06 - 2000.11		3470.89D50
D 65 1.9	F8Q 632, F8Q 630	1.9	2000.11 -		410517.89D

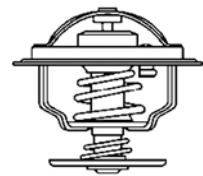

RENAULT

	Motor Engine Moteur	Ltr. Ltr. Ltr.	Jahr Year Année	Einschränkung Restriction* Restriction*	Thermostat Thermostat Thermostat
KANGOO (KW0/1_)					
1.5 dCi	K9K 802, K9K 806, K9K 804, K9K 808	1.5	2008.02 -	4 polig	411040.83D
1.5 dCi	K9K 802, K9K 806, K9K 804, K9K 808	1.5	2008.02 -	2 polig	411442.83D ▲
1.5 dCi	K9K 800	1.5	2008.02 -		411477.89D ▲
1.6	K7M 750	1.6	2008.02 -	Deckel Thermostatgehäuse	126104 ▲
1.6	K7M 750	1.6	2008.02 -		3466.89D
KANGOO Express (FC0/1_)					
1.2	D7F	1.2	1997.08 - 1998.06		3174.89D
1.2	D7F	1.2	1998.07 -		3166.89D
1.2 16V	D4F 714, D4F 712, D4F 730	1.2	2001.10 -		3166.89D
1.2 BiFuel	D7F 710, D7F 744	1.2	1998.07 - 2001.07		3166.89D
1.4	E7J 634, K7J 701, E7J 635, E7J 780	1.4	1997.08 -	Deckel Thermostatgehäuse	126104 ▲
1.4	E7J 634, K7J 701, E7J 635, E7J 780	1.4	1997.08 -		3466.89D
1.5 dCi	K9K 702, K9K 704, K9K 700, K9K 710	1.5	2001.12 -		411043.89D
1.5 dCi	K9K 714, K9K 718	1.5	2005.06 -		411039.83D
1.6 16V	K4M 750, K4M 752	1.6	2001.10 -	Deckel Thermostatgehäuse	126104 ▲
1.6 16V	K4M 750, K4M 752	1.6	2001.10 -		3466.89D
1.6 16V bivalent	K4M 850	1.6	2005.06 -		3466.89D
1.9 D	F8Q 632	1.9	1999.09 - 2000.05		410518.89D
1.9 D	F8Q 632	1.9	2000.06 - 2000.11		3470.89D50
1.9 D	F8Q 632	1.9	2000.12 - 2003.06		411042.89D
1.9 dCi	F9Q 782	1.9	2001.10 -	Motor no. →001211	410518.89D
1.9 dCi	F9Q 782	1.9	2001.11 -	Motor no. 001211→	410517.89D
1.9 dCi	F9Q 790	1.9	2003.07 -		410517.89D
1.9 dTi	F9Q 780	1.9	2000.02 - 2000.05		410518.89D
1.9 dTi	F9Q 780	1.9	2000.06 -		3470.89D50
D 55 1.9	F8Q 662	1.9	1997.08 - 1998.01		3470.89D50
D 55 1.9	F8Q 662	1.9	1998.02 - 2000.05		410530.89D
D 55 1.9	F8Q 662	1.9	2000.06 -		3470.89D50
D 65 1.9	F8Q 632	1.9	1997.08 -		410517.89D
D 65 1.9	F8Q 630	1.9	1997.08 - 2000.05		410518.89D
D 65 1.9	F8Q 630	1.9	2000.06 - 2000.11		3470.89D50
D 65 1.9	F8Q 630	1.9	2000.11 -		410517.89D
KANGOO Express (FW0/1_)					
1.5 dCi	K9K 806	1.5	2008.02 -	4 polig	411040.83D
1.5 dCi	K9K 806	1.5	2008.02 -	2 polig	411442.83D ▲
1.5 dCi	K9K 800	1.5	2008.02 -		411477.89D ▲
1.5 dCi 75	K9K 800	1.5	2010.09 -		411477.89D ▲
1.5 dCi 85	K9K 802, K9K 800	1.5	2008.02 -	4 polig	411040.83D
1.5 dCi 85	K9K 802, K9K 800	1.5	2008.02 -	2 polig	411442.83D ▲
1.5 dCi 90	K9K 808	1.5	2009.06 -	4 polig	411040.83D
1.5 dCi 90	K9K 808	1.5	2009.06 -	2 polig	411442.83D ▲
1.5 dCi 110	K9K 804	1.5	2010.09 -		411477.89D ▲
1.60	K7M 750	1.6	2008.02 -		3466.89D
MASCOTT					
90	8140.63	2.8	1999.01 - 2001.12		4174.79D
90	8140.43	2.8	2000.01 - 2004.06		4151.76D
110	8140.43	2.8	1999.01 - 2004.06		4151.76D
130	8140.43	2.8	1999.01 - 2004.06		4151.76D

RENAULT
**Motor
Engine
Moteur**
**Ltr.
Ltr.
Ltr.**
**Jahr
Year
Année**
**Einschränkung
Restriction*
Restriction***
**Thermostat
Thermostat
Thermostat**

140	8140.43	2.8	2001.01 - 2004.06		4151.76D
150	8140.43	2.8	2001.10 - 2004.06		4174.79D
KOLEOS (HY_)					
2.0 dCi	M9R	2.0	2008.09 -		411475.89D ▲
LAGUNA I (B56_, 556_)					
1.6 16V	K4M 720	1.6	1997.11 - 2001.03	Deckel Thermostatgehäuse	126104 ▲
1.6 16V	K4M 720	1.6	1997.11 - 2001.03		3466.89D
1.8	F3P	1.8	1993.11 - 2001.03		3470.89D50
1.8 16V	F4P 760	1.8	1998.04 - 2001.03		3466.89D
1.9 dCi	F9Q 718	1.9	1999.09 - 2001.03		3470.89D50
1.9 dTi	F9Q 717, F9Q 716, F9Q 710	1.9	1997.10 - 2001.03		3470.89D50
2.0	F3R 722, F3R 723	2.0	1993.11 - 2001.03		3136.82D50
2.0	F3R 611, F3R 768	2.0	1995.06 - 2001.03		3470.89D50
2.0	N7Q 700, N7Q 704	2.0	1995.06 - 2001.02		4272.90D
2.0	F4R 780	2.0	1999.09 - 2001.02		3466.89D
2.0 16V	N7Q 700, N7Q 704	2.0	1995.06 - 2001.03		4272.90D
2.0 16V	F4R 780	2.0	1999.09 - 2001.03		3466.89D
2.2 D	G8T 706, G8T 752, G8T 794, G8T 790	2.2	1993.11 - 2001.03		4446.83D
2.2 dT	G8T 760	2.2	1996.03 - 2001.03		4446.83D
3.0	Z7X 765, Z7X 760	3.0	1993.11 - 2001.03		4449.84D
LAGUNA I Grandtour (K56_)					
1.6 16V	K4M 720	1.6	1997.11 - 2001.03	Deckel Thermostatgehäuse	126104 ▲
1.6 16V	K4M 720	1.6	1997.11 - 2001.03		3466.89D
1.8	F3P	1.8	1995.09 - 2001.03		3470.89D50
1.8 16V	F4P 760	1.8	1998.04 - 2001.03		3466.89D
1.9 dCi	F9Q 718	1.9	2000.06 - 2001.03		3470.89D50
1.9 dTi	F9Q 717, F9Q 716, F9Q 710	1.9	2000.06 - 2001.03		3470.89D50
2.0	F3R 722, F3R 723, F3R 768	2.0	1995.09 - 2001.03		3470.89D50
2.0 16V	N7Q 700, N7Q 704	2.0	1995.09 - 2001.03		4272.90D
2.0 16V	F4R 780	2.0	1999.09 - 2001.03		3466.89D
2.2 D	G8T 706, G8T 752, G8T 794, G8T 790	2.2	1995.09 - 2001.03		4446.83D
2.2 dT	G8T 760	2.2	1996.03 - 2001.03		4446.83D
3.0	Z7X 765	3.0	1996.02 - 2001.03		4449.84D
LAGUNA II (BG / KG)					
1.6 16V	K4M 710	1.6	2001.03 -	Deckel Thermostatgehäuse, Motor no. →030626	126104 ▲
1.6 16V	K4M 710	1.6	2001.03 -	Motor no. →030626	3466.89D
1.6 16V	K4M 714, K4M 716	1.6	2005.02 -	Deckel Thermostatgehäuse	126104 ▲
1.6 16V	K4M 714, K4M 716	1.6	2005.02 -		3466.89D
1.6 FlexFuel	K4M 718	1.6	2001.06 - 2003.10	Deckel Thermostatgehäuse	126104 ▲
1.6 FlexFuel	K4M 718	1.6	2001.06 - 2003.10		3466.89D
1.6 LPG	K4M 714	1.6	2001.03 - 2005.05	Deckel Thermostatgehäuse	126104 ▲
1.6 LPG	K4M 714	1.6	2001.03 - 2005.05		3466.89D
1.8 16V	F4P 774, F4P 773, F4P 771	1.8	2001.03 -		3466.89D

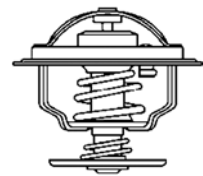

RENAULT

	Motor Engine Moteur	Ltr. Ltr. Ltr.	Jahr Year Année	Einschränkung Restriction* Restriction*	Thermostat Thermostat Thermostat
1.8 16V	F4P 774, F4P 773, F4P 771	1.8	2001.03 -		3466.89D
1.8 16V	F4P 770, F4P 772, F4P 775	1.8	2001.03 -		3466.89D
1.9 dCi	F9Q 670, F9Q 718, F9Q 750, F9Q 754, F9Q 756	1.9	2001.03 -	Motor no. →010608	3470.89D50
1.9 dCi	F9Q 670, F9Q 718, F9Q 750, F9Q 754, F9Q 756	1.9	2001.04 -	Motor no. 010608→	410517.89D
1.9 dCi	F9Q 664, F9Q 752, F9Q 758, F9Q 759	1.9	2004.03 -		410517.89D
2.0	F4R 713	2.0	2002.09 - 2005.05		3466.89D
2.0 16V	F4R	2.0	2002.08 -		3466.89D
2.0 16V DIE	F5R 701, F5R 700	2.0	2001.04 -		3466.89D
2.0 16V Turbo	F4R 764, F4R 787, F4R 786, F4R 765	2.0	2003.01 -		3466.89D
2.0 dCi	M9R 740, M9R 760	2.0	2005.08 -		411475.89D ▲
LAGUNA III (BT0 / KT0)					
1.5 dCi	K9K 780	1.5	2007.10 -	4 polig	411040.83D
1.5 dCi	K9K 780	1.5	2007.10 -	2 polig	411442.83D ▲
2.0 16V	M4R 704, M4R 726	2.0	2007.10 -		411241.82D
2.0 16V Turbo	F4R 811	2.0	2007.10 -		3466.89D
2.0 dCi	M9R	2.0	2007.10 -		411475.89D ▲
2.0 GT	F4R 800	2.0	2008.03 -		3466.89D
LATITUDE (L70_)					
2.0 dCi		2.0	2011.02 -		411475.89D ▲
2.0 dCi 150	M9R 824, M9R 846	2.0	2011.02 -		411475.89D ▲
2.0 dCi 175	M9R 804, M9R 844, M9R 817	2.0	2011.05 -		411475.89D ▲
LAGUNA Coupe (DT0/1)	F4Rt 811, F4R 811	2.0	2008.09 -		3466.89D
2.0 16V Turbo					
2.0 dCi	M9R	2.0	2008.09 -		411475.89D ▲
2.0 dCi GT	M9R 820, M9R 816	2.0	2008.03 -		411475.89D ▲
2.0 GT	F4Rt 800	2.0	2008.09 -		3466.89D
LOGAN (LS / KS)					
1.0 Hi-Flex		1.0	2007.07 -		3166.89D
1.4	K7J 710	1.4	2004.09 -	Deckel Thermostatgehäuse	126104 ▲
1.4	K7J 710	1.4	2004.09 -		3466.89D
1.5 dCi	K9K 792, K9K 796	1.5	2007.04 -		411039.83D
1.6	K7M 710	1.6	2004.09 -	Deckel Thermostatgehäuse	126104 ▲
1.6	K7M 710	1.6	2004.09 -		3466.89D
1.6	K4M 690, K4M 697	1.6	2007.04 -	Deckel Thermostatgehäuse	126104 ▲
1.6	K4M 690, K4M 697	1.6	2007.04 -		3466.89D
MASTER II					
1.9 dCi 80	F9Q 772, F9Q 774	1.9	2001.11 -		410517.83D
1.9 dTI	F9Q 770	1.9	2000.09 -		3470.89D50
2.5 D	S8U 770	2.5	1998.07 - 2001.01		4174.79D
2.8 dTI	S9W 702	2.8	1998.07 - 2001.10		4174.79D
MEGANE I (BA)					
1.4 16V	K4J 714, K4J 750	1.4	1999.03 - 2003.08	Deckel Thermostatgehäuse	126104 ▲
1.4 16V	K4J 714, K4J 750	1.4	1999.03 - 2003.08		3466.89D

RENAULT
**Motor
Engine
Moteur**
**Ltr.
Ltr.
Ltr.**
**Jahr
Year
Année**
**Einschränkung
Restriction*
Restriction***
**Thermostat
Thermostat
Thermostat**

1.4 e	E7J 626, E7J 764	1.4	1996.01 - 2003.08	Deckel T hermostatgehäuse	126104 ▲
1.4 e	E7J 626, E7J 764	1.4	1996.01 - 2003.08		3466.89D
1.4 Eco	E7J 624	1.4	1996.01 - 1999.03	Deckel Thermostatgehäuse	126104 ▲
1.4 Eco	E7J 624	1.4	1996.01 - 1999.03		3466.89D
1.6	K7M 704	1.6	2000.02 - 2000.09	Deckel Thermostatgehäuse	126104 ▲
1.6	K7M 704	1.6	2000.02 - 2000.09		3466.89D
1.6 16V	K4M 708	1.6	1999.03 - 2003.08	Deckel Thermostatgehäuse	126104 ▲
1.6 16V	K4M 704, K4M 700, K4M 708, K4M 701	1.6	1999.03 - 2003.08		3466.89D
1.6 e	K7M 702, K7M 703, K7M 790	1.6	1996.01 - 1999.03	Deckel Thermostatgehäuse	126104 ▲
1.6 e	K7M 702, K7M 703, K7M 790	1.6	1996.01 - 1999.03		3466.89D
1.6 i	K7M 720	1.6	1996.01 - 1999.03	Deckel Thermostatgehäuse	126104 ▲
1.6 i	K7M 720	1.6	1996.01 - 1999.03		3466.89D
1.6 LPG	K7M 702	1.6	1995.08 - 1999.03		3466.89D
1.6 LPG	K4M 704	1.6	2000.10 - 2002.08	Deckel Thermostatgehäuse	126104 ▲
1.6 LPG	K4M 704	1.6	2000.10 - 2002.08		3466.89D
1.8 16V	F4P 722, F4P 720	1.8	2001.01 - 2003.08		3466.89D
1.9 D	F8Q 784	1.9	1996.04 - 1998.01		3470.89D50
1.9 D	F8Q 784	1.9	1998.02 - 2001.02		410530.89D
1.9 D Eco	F8Q 620, F8Q 624	1.9	1996.01 - 1998.01		3470.89D50
1.9 D Eco	F8Q 620, F8Q 624	1.9	1998.02 - 2000.05		410530.89D
1.9 D Eco	F8Q 620, F8Q 624	1.9	2000.06 - 2003.08		3470.89D50
1.9 DCi	F9Q 738	1.9	2000.05 - 2003.08		410518.89D
1.9 DCi	F9Q 738	1.9	2000.06 - 2003.08		3470.89D50
1.9 DCi	F9Q 738	1.9	2000.12 - 2003.08		410517.89D
1.9 DCi	F9Q 733	1.9	2001.02 - 2003.08		410517.89D
1.9 DCi	F9Q 732	1.9	2001.02 - 2003.08	Motor no. 001212→	410517.89D
1.9 DCi	F9Q 732	1.9	2001.02 - 2003.08	Motor no. →001210	410518.89D
1.9 dT	F8Q 786, F8Q 784	1.9	1996.01 - 1998.01		3470.89D50
1.9 dT	F8Q 786, F8Q 784	1.9	1998.02 - 2000.05		410530.89D
1.9 dT	F8Q 786, F8Q 784	1.9	2000.06 - 2003.08		3470.89D50
1.9 dTi	F9Q 731 / 736	1.9	1997.03 - 2000.05		410518.89D
1.9 dTi	F9Q 730/734	1.9	1997.03 - 2000.05		410530.89D
1.9 DTi	0	1.9	2000.02 - 2000.05		410530.89D
1.9 dTi	F9Q 731/736	1.9	2000.06 - 2000.12		3470.89D50
1.9 dTi	F9Q 730/731/734/736	1.9	2000.06 - 2001.02		3470.89D50
1.9 DTi	0	1.9	2000.06 - 2000.09		3470.89D50
1.9 dTi	F9Q 731/736	1.9	2000.12 - 2001.02		410517.89D
1.9 dTi	F9Q 744	1.9	2001.02 - 2003.08		410517.89D
1.9 TDI	F8Q 784	1.9	1996.09 - 1998.01		3470.89D50
1.9 TDI	F8Q 784	1.9	1998.02 - 2000.05		410530.89D
1.9 TDI	F8Q 784	1.9	2000.06 - 2003.08		3470.89D50
2.0 16V	F7R 710, F7R 714	2.0	1996.07 - 2003.08		3470.89D50
2.0 i	F3R 751, F3R 750	2.0	1996.01 - 1998.01		3470.89D50
2.0 i	F3R 751, F3R 750	2.0	1998.02 - 2000.05		410530.89D
2.0 i	F3R 751, F3R 750	2.0	2000.06 - 2003.08		3470.89D50

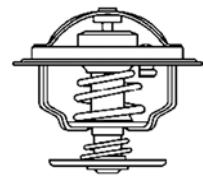

RENAULT

	Motor Engine Moteur	Ltr. Ltr. Ltr.	Jahr Year Année	Einschränkung Restriction* Restriction*	Thermostat Thermostat Thermostat
MEGANE I Cabriolet (EA)					
1.4 16V	K4J 714, K4J 750	1.4	1999.03 - 2003.08	Deckel Thermostatgehäuse	126104 ▲
1.4 16V	K4J 714, K4J 750	1.4	1999.03 - 2003.08		3466.89D
1.6 16V	K4M 700, K4M 708, K4M 701	1.6	1999.03 - 2003.08	Deckel Thermostatgehäuse	126104 ▲
1.6 16V	K4M 700, K4M 708, K4M 701	1.6	1999.03 - 2003.08		3466.89D
1.6 e	K7M 702, K7M 703	1.6	1996.10 - 1999.03	Deckel Thermostatgehäuse	126104 ▲
1.6 e	K7M 702, K7M 703	1.6	1996.10 - 1999.03		3466.89D
2.0	F3R 750	2.0	1997.04 - 1998.01		3470.89D50
2.0	F3R 750	2.0	1998.02 - 2000.05		410530.89D
2.0	F3R 750	2.0	2000.06 - 2003.08		3470.89D50
2.0 16V	F7R 710, F7R 714	2.0	1996.10 - 1999.11		3470.89D50
2.0 16V	F4R 746, F4R 770	2.0	2002.01 - 2003.08		3466.89D
2.0 16V IDE	F5R 740	2.0	1999.11 - 2003.08		3466.89D
2.0 i	F3R 791, F3R 796	2.0	1999.03 - 2003.08		3470.89D50
MEGANE I Classic (LA)					
1.4	E7J 626, E7J 764	1.4	1996.09 - 2003.08	Deckel Thermostatgehäuse	126104 ▲
1.4	E7J 626, E7J 764	1.4	1996.09 - 2003.08		3466.89D
1.4 16V	K4J 714, K4J 750	1.4	1999.03 - 2003.08	Deckel Thermostatgehäuse	126104 ▲
1.4 16V	K4J 714, K4J 750	1.4	1999.03 - 2003.08		3466.89D
1.6 16V	K4M 708	1.6	1999.03 - 2003.08	Deckel Thermostatgehäuse	126104 ▲
1.6 16V	K4M 700, K4M 708, K4M 701	1.6	1999.03 - 2003.08		3466.89D
1.6 e	K7M 702, K7M 703, K7M 790	1.6	1996.09 - 1999.03	Deckel Thermostatgehäuse	126104 ▲
1.6 e	K7M 702, K7M 703, K7M 790	1.6	1996.09 - 1999.03		3466.89D
1.6 i	K7M 720	1.6	1996.09 - 1999.03	Deckel Thermostatgehäuse	126104 ▲
1.6 i	K7M 720	1.6	1996.09 - 1999.03		3466.89D
1.8 16V	F4P 722, F4P 720	1.8	2001.01 - 2003.08		3466.89D
1.9 D	F8Q 620, F8Q 624	1.9	1996.09 - 1998.01		3470.89D50
1.9 D	F8Q 620, F8Q 624	1.9	1998.02 - 2000.05		410530.89D
1.9 D	F8Q 620, F8Q 624	1.9	2000.06 - 2003.08		3470.89D50
1.9 dCi	F9Q 732	1.9	2001.02 - 2003.08	Motor no. 001211→	410517.89D
1.9 dCi	F9Q 733, F9Q 738	1.9	2001.02 - 2003.08		410517.89D
1.9 dCi	F9Q 732	1.9	2001.02 - 2003.08	Motor no. →001210	410518.89D
1.9 dT	F8Q 786, F8Q 784	1.9	1996.09 - 1998.01		3470.89D50
1.9 dT	F8Q 786, F8Q 784	1.9	1998.02 - 2000.05		410530.89D
1.9 dT	F8Q 786, F8Q 784	1.9	2000.06 - 2003.08		3470.89D50
1.9 dTi	F9Q 731 / 736	1.9	1997.03 - 2000.12		3470.89D50
1.9 dTi	F9Q 731 / 736	1.9	1997.03 - 2000.05		410518.89D
1.9 dTi	F9Q 730 / 734	1.9	1997.03 - 2000.05		410530.89D
1.9 dTi	F9Q 730 / 731 / 734 / 736	1.9	2000.06 - 2001.02		3470.89D50
1.9 dTi	F9Q 731 / 736	1.9	2000.12 - 2001.02		410517.89D
1.9 dTi	F9Q 744	1.9	2001.02 - 2003.08		410517.89D
1.9 TDI	F8Q 784	1.9	1996.09 - 1998.01		3470.89D50
1.9 TDI	F8Q 784	1.9	1998.02 - 2000.05		410530.89D
1.9 TDI	F8Q 784	1.9	2000.06 - 2003.08		3470.89D50
2.0 i	F3R 791, F3R 751, F3R 797, F3R 798, F3R 796, F3R 752, F3R 750	2.0	1996.09 - 2003.08		3470.89D50

RENAULT
**Motor
Engine
Moteur**
**Ltr.
Ltr.
Ltr.**
**Jahr
Year
Année**
**Einschränkung
Restriction*
Restriction***
**Thermostat
Thermostat
Thermostat**
MEGANE I Coach (DA0/1_)

1.4 16V	K4J 714, K4J 750	1.4	1999.03 - 2003.08	Deckel Thermostatgehäuse	126104 ▲
1.4 16V	K4J 714, K4J 750	1.4	1999.03 - 2003.08		3466.89D
1.6 16V	K4M 700, K4M 708, K4M 701	1.6	1999.03 - 2003.08	Deckel Thermostatgehäuse	126104 ▲
1.6 16V	K4M 700, K4M 708, K4M 701	1.6	1999.03 - 2003.08		3466.89D
1.6 e	K7M 702, K7M 703	1.6	1996.03 - 1999.03	Deckel Thermostatgehäuse	126104 ▲
1.6 e	K7M 702, K7M 703	1.6	1996.03 - 1999.03		3466.89D
1.9 dCi	F9Q 732, F9Q 733	1.9	2001.02 - 2003.08		3470.89D50
1.9 dCi	F9Q 732, F9Q 733	1.9	2001.02 - 2003.08		410517.89D
1.9 dCi	F9Q 732, F9Q 733	1.9	2001.02 - 2003.08		410518.89D
1.9 dTi	F9Q 731 / 736	1.9	1997.03 - 2000.12		3470.89D50
1.9 dTi	F9Q 731 / 736	1.9	1997.03 - 2000.05		410518.89D
1.9 dTi	F9Q 734	1.9	1997.03 - 2000.05		410530.89D
1.9 dTi	F9Q 731 / 734 / 736	1.9	2000.06 - 2001.02		3470.89D50
1.9 dTi	F9Q 731 / 736	1.9	2000.12 - 2001.02		410517.89D
2.0 16V	F4R 746	2.0	2002.01 - 2003.08		3466.89D
2.0 16V (DA0H)	F7R 710, F7R 714	2.0	1996.03 - 1999.11		3470.89D50
2.0 16V DIE	F5R 740	2.0	1999.11 - 2003.08		3466.89D
2.0 i	F3R 791, F3R 796	2.0	1999.03 - 2003.08		3470.89D50
2.0 i (DA0G)	F3R 751, F3R 750	2.0	1998.01 - 2003.08		3470.89D50
2.0 i (DA0G)	F3R 751, F3R 750	2.0	1998.02 - 2000.05		410530.89D
2.0 i (DA0G)	F3R 751, F3R 750	2.0	2000.06 - 2003.08		3470.89D50

MEGANE I Grandtour (KA0/1_)

1.4 16V	K4J 714, K4J 750	1.4	1999.03 - 2003.08	Deckel Thermostatgehäuse	126104 ▲
1.4 16V	K4J 714, K4J 750	1.4	1999.03 - 2003.08		3466.89D
1.4 e	E7J 626	1.4	1999.03 - 2003.08	Deckel Thermostatgehäuse	126104 ▲
1.4 e	E7J 626	1.4	1999.03 - 2003.08		3466.89D
1.6 16V	K4M 708	1.6	1999.03 - 2003.08	Deckel Thermostatgehäuse	126104 ▲
1.6 16V	K4M 704, K4M 700, K4M 708, K4M 701	1.6	1999.03 - 2003.08		3466.89D
1.6 e	K7M 702, K7M 703	1.6	1999.03 - 2003.08	Deckel Thermostatgehäuse	126104 ▲
1.6 e	K7M 702, K7M 703	1.6	1999.03 - 2003.08		3466.89D
1.8 16V	F4P 722, F4P 720	1.8	2001.01 - 2003.08		3466.89D
1.9 D	F8Q 622	1.9	1999.04 - 2000.05		410518.89D
1.9 D	F8Q 790	1.9	2000.05 - 2003.08		410530.89D
1.9 D	F8Q 622, F8Q 790	1.9	2000.06 - 2003.08		3470.89D50
1.9 dCi	F9Q 738	1.9	2001.02 - 2003.08		3470.89D50
1.9 dCi	F9Q 732	1.9	2001.02 - 2003.08		410517.89D
1.9 dCi	F9Q 738	1.9	2001.02 - 2003.08		410518.89D
1.9 dTi (KA0N)	F9Q 731, F9Q 736	1.9	1999.03 - 2000.05		410518.89D
1.9 dTi (KA0N)	F9Q 731, F9Q 736	1.9	2000.06 - 2001.02		3470.89D50
1.9 dTi (KA1U)	F9Q 744	1.9	2001.02 - 2003.08		410517.89D

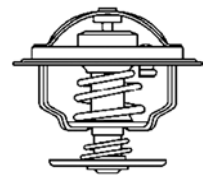

RENAULT

	Motor Engine Moteur	Ltr. Ltr. Ltr.	Jahr Year Année	Einschränkung Restriction* Restriction*	Thermostat Thermostat Thermostat
MEGANE II (BM, CM)					
1.4 16V	K4J 740	1.4	2002.11 -	Deckel Thermostatgehäuse	126104 ▲
1.4 16V	K4J 740	1.4	2002.11 -		3466.89D
1.4 16V	K4J 730, K4J 732	1.4	2003.10 -	Deckel Thermostatgehäuse, Motor no. →050117	126104 ▲
1.4 16V	K4J 730, K4J 732	1.4	2003.10 -	Motor no. →050117	3466.89D
1.5 dCi	K9K 722	1.5	2002.11 -		411477.89D ▲
1.5 dCi	K9K 724, K9K 729, K9K 732, K9K 734	1.5	2003.10 -	4 polig	411040.83D
1.5 dCi	K9K 728	1.5	2003.10 -		411042.89D
1.6	K4M 788	1.6	2005.06 -		3466.89D
1.6 16V	K4M 760	1.6	2002.11 -	Deckel Thermostatgehäuse, Motor no. →050117	126104 ▲
1.6 16V	K4M 760	1.6	2002.11 -	Motor no. →050117	3466.89D
1.6 Flex-Fuel	K4M 788	1.6	2007.01 -		3466.89D
1.9 dCi	F9Q 800	1.9	2002.11 -		410538.89D
1.9 dCi	F9Q 803, F9Q 804, F9Q 816, F9Q 818	1.9	2002.11 - 2006.09		410538.89D
2.0	F4R 774	2.0	2006.08 -		3466.89D
2.0 16V	F4R 770	2.0	2002.11 -		3466.89D
2.0 16V Turbo	F4R 776	2.0	2004.05 -		3466.89D
2.0 dCi	M9R 722, M9R 700, M9R 724	2.0	2005.09 -		411475.89D ▲
2.0 Renault Sport	F4R 774, F4Rt 774	2.0	2004.05 -		3466.89D
MEGANE II (EM)					
1.5 dCi	K9K 732	1.5	2006.03 -	4 polig	411040.83D
1.5 dCi	K9K 732	1.5	2006.03 -	2 polig	411442.83D ▲
1.5 dCi	K9K 734	1.5	2007.01 -	4 polig	411040.83D
1.5 dCi	K9K 734	1.5	2007.01 -	2 polig	411442.83D ▲
1.6	K4M 760, K4M 761	1.6	2003.09 -	Deckel Thermostatgehäuse, Motor no. →050117	126104 ▲
1.6	K4M 760, K4M 761	1.6	2003.09 -	Motor no. →050117	3466.89D
1.9 dCi	F9Q 803	1.9	2003.09 - 2006.09		410538.89D
1.9 dCi	F9Q 800	1.9	2003.09 -		410538.89D
2.0	F4R 770	2.0	2003.09 - 2007.02		3466.89D
2.0 16V Turbo	F4R 776	2.0	2004.05 -		3466.89D
2.0 dCi	M9R 722, M9R 700	2.0	2005.09 -		411475.89D ▲
MEGANE II Grandtour (KM0/1_)					
1.4	K4J 740	1.4	2003.08 -	Deckel Thermostatgehäuse	126104 ▲
1.4	K4J 730	1.4	2003.08 -	Deckel Thermostatgehäuse, Motor no. →050117	126104 ▲
1.4	K4J 740	1.4	2003.08 -		3466.89D
1.4	K4J 730	1.4	2003.08 -	Motor no. →050117	3466.89D
1.5 dCi	K9K 722	1.5	2003.08 -		411477.89D ▲
1.5 dCi	K9K 724, K9K 729, K9K 732, K9K 734	1.5	2004.02 -	4 polig	411040.83D
1.5 dCi	K9K 728	1.5	2004.02 -		411042.89D
1.6	K4M 760, K4M 761	1.6	2005.01 -	Deckel Thermostatgehäuse	126104 ▲
1.6	K4M 760, K4M 761	1.6	2005.01 -		3466.89D
1.6 16V Hi-Flex	K4M 762	1.6	2008.02 -		3466.89D
1.9 dCi	F9Q 800	1.9	2003.08 -		410538.89D

RENAULT
**Motor
Engine
Moteur**
**Ltr.
Ltr.
Ltr.**
**Jahr
Year
Année**
**Einschränkung
Restriction*
Restriction***
**Thermostat
Thermostat
Thermostat**

1.9 dCi	F9Q 803, F9Q 804, F9Q 808, F9Q 818	1.9	2005.05 - 2006.09		410538.89D
2.0	F4R 770	2.0	2003.08 -		3466.89D
2.0 dCi	M9R 722, M9R 700	2.0	2005.09 -		411475.89D ▲
MEGANE II Stufenheck (LM)					
1.4	K4J 740, K4J 730	1.4	2003.09 -	Deckel Thermostatgehäuse, Motor no. →050117	126104 ▲
1.4	K4J 732	1.4	2003.09 - 2005.01		3466.89D
1.4	K4J 740, K4J 730	1.4	2003.09 -	Motor no. →050117	3466.89D
1.5 dCi	K9K 722	1.5	2003.09 -		411477.89D ▲
1.5 dCi	K9K 724, K9K 729, K9K 732, K9K 734	1.5	2004.02 -	4 polig	411040.83D
1.5 dCi	K9K 729	1.5	2004.02 -		411042.89D
1.6	K4M 760, K4M 761	1.6	2003.09 -	Deckel Thermostatgehäuse, Motor no. →050117	126104 ▲
1.6	K4M 760, K4M 761	1.6	2003.09 -	Motor no. →050117	3466.89D
1.6	K4M 762, K4M 768	1.6	2003.09 -		3466.89D
1.9 dCi	F9Q 800	1.9	2003.09 -		410538.89D
1.9 dCi	F9Q 803	1.9	2005.05 - 2006.09		410538.89D
2.0	F4R 770	2.0	2003.09 -		3466.89D
2.0 dCi	M9R 722, M9R 700	2.0	2005.09 -		411475.89D ▲

MEGANE Scenic (JA0/1)

1.4 i	E7J 764	1.4	1997.01 - 1999.09	Deckel Thermostatgehäuse	126104 ▲
1.4 i	E7J 764	1.4	1997.01 - 1999.09		3466.89D
1.6 16V	K4M 704, K4M 700, K4M 708, K4M 701	1.6	1998.04 - 1999.10	Deckel Thermostatgehäuse	126104 ▲
1.6 16V	K4M 704, K4M 700, K4M 708, K4M 701	1.6	1998.04 - 1999.10		3466.89D
1.6 e	K7M 702, K7M 703	1.6	1996.10 - 1999.10	Deckel Thermostatgehäuse	126104 ▲
1.6 e	K7M 702, K7M 703	1.6	1996.10 - 1999.10		3466.89D
1.6 i	K7M 720	1.6	1997.01 - 1999.09	Deckel Thermostatgehäuse	126104 ▲
1.6 i	K7M 720	1.6	1997.01 - 1999.09		3466.89D
1.9 D	F8Q 790	1.9	1997.03 - 1999.09		3470.89D50
1.9 D	F8Q 790	1.9	1997.03 - 1999.09		410518.89D
1.9 dT	F8Q 786, F8Q 784	1.9	1997.01 - 1998.01		3470.89D50
1.9 dT	F8Q 786, F8Q 784	1.9	1998.02 - 1999.09		410530.89D
1.9 dTi	F9Q 730, F9Q 734	1.9	1997.04 - 1998.01		3470.89D50
1.9 dTi	F9Q 730, F9Q 734	1.9	1998.02 - 1999.09		410530.89D
2.0 i	F3R 751, F3R 750, F3R 796	2.0	1997.01 - 1999.09		3470.89D50
2.0 RXE	F3R 750	2.0	1997.05 - 1999.10		3470.89D50

**MEGANE III (BZ0_), (DZ0/1_),
(KZ0/1)**

1.4 TCe	H4J 700	1.4	2009.04 -		411241.82D
1.5 dCi	K9K	1.5	2008.11 -	4 polig	411040.83D
1.5 dCi	K9K	1.5	2008.11 -	2 polig	411442.83D ▲
1.5 dCi	K9K 836, K9K 846	1.5	2009.02 -		411477.89D ▲
1.5 dCi	K9K 834	1.5	2009.05 -	2 polig	411442.83D ▲
2.0 CVT	M4R	2.0	2009.05 -		411241.82D

MESSENGER

B 110	8140.23.2565	2.8	1996.09 - 1999.06		4151.76D
-------	--------------	-----	-------------------	--	----------

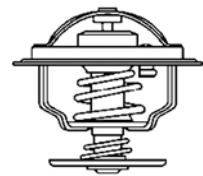

RENAULT

	Motor Engine Moteur	Ltr. Ltr. Ltr.	Jahr Year Année	Einschränkung Restriction* Restriction*	Thermostat Thermostat Thermostat
B 110	8140.23.2565	2.8	1996.09 - 1999.06		4174.79D
B 120	8140.43.2585, 8140.47.2530 IDR, 8140.47.2585	2.8	1991.10 - 1999.06		4151.76D
B 120	8140.43.2585, 8140.47.2530 IDR, 8140.47.2585	2.8	1991.10 - 1999.06		4174.79D
B 80	8140.07.2530 ID, 8140.07.2585, 8140.67.2585	2.5	1990.09 - 1999.06		4174.79D

MODUS (F/JP0)

1.2	D4F 740	1.2	2004.12 -		3166.89D
1.2 16V	D4F 740, D4F 784	1.2	2007.05 -		3166.89D
1.5 dCi	K9K 750, K9K 752	1.5	2004.09 -		411477.89D ▲
1.5 dCi	K9K 764, K9K 766, K9K 768	1.5	2004.12 -	4 polig	411040.83D
1.5 dCi	K9K 760	1.5	2004.12 -		411042.89D
1.5 dCi	K9K 764, K9K 766, K9K 768	1.5	2004.12 -	2 polig	411442.83D ▲
1.5 dCi	K9K 772	1.5	2007.05 - 2010.10		411042.89D
1.5 dCi	K9K 772	1.5	2011.11 -		411481.89D ▲
1.5 dCi 75	K9K 770	1.5	2010.10 -	2 polig	411442.83D ▲
1.5 dCi 90	K9K 750	1.5	2010.10 -		411477.89D ▲

RAPID Kasten (F40, G40)

1.0	C1C 706	1.0	1986.02 - 1992.05		3029.89
1.1	C1E	1.1	1985.07 - 1995.04		3029.89
1.2	C1G 726	1.2	1991.09 - 1993.08		3029.86
1.2	C3G 712, C3G 710	1.2	1991.09 - 1998.03		3029.89
1.4	C1J, C2J, C3J	1.4	1985.07 - 1998.08		3029.89
1.4	E7J	1.4	1991.09 - 1998.03		3469.91D
1.6 D	F8M	1.6	1986.03 - 1998.08		3470.89D50
1.9 D	F8Q	1.9	1991.09 - 1998.03		3470.89D50

SAFRANE I

2.5 dT	S8U 763, S8U 762	2.5	1992.12 - 1996.07		3116.82D
3.0 Biturbo	Z7X 726	3.0	1993.02 - 1996.07		4449.84D
3.0 V6	Z7X 721, Z7X 723, Z7X 753, Z7X 722	3.0	1992.12 - 1996.07		4449.84D

SAFRANE II

2.0 16V	N7Q 710, N7Q 711	2.0	1996.07 - 2000.12		4272.90D
2.2 dT	G8T 740	2.2	1996.07 - 2000.12		4446.83D
2.5 20V	N7U 700, N7U 701	2.5	1996.07 - 2000.12		4272.90D
3.0 V6	Z7X 755	3.0	1996.07 - 2000.12		4449.84D

SCÉNIC I (JA)

1.4 16V	K4J 714, K4J 750	1.4	1999.09 - 2003.08	Deckel Thermostatgehäuse	126104 ▲
1.4 16V	K4J 714, K4J 750	1.4	1999.09 - 2003.08		3466.89D
1.6	K4M	1.6	1999.09 - 2003.09	Deckel Thermostatgehäuse	126104 ▲
1.6	K4M	1.6	1999.09 - 2003.09		3466.89D
1.8	F4P 722	1.8	2000.07 - 2001.04		3466.89D
1.8 16V	F4P 722, F4P 720	1.8	2001.01 - 2003.08		3466.89D
1.9 D	F8Q 790	1.9	1999.09 - 2000.05		410530.89D
1.9 D	F8Q 790	1.9	2000.06 - 2001.03		3470.89D50
1.9 dCi	F9Q 733	1.9	1999.09 - 2003.08		410517.89D
1.9 dCi	F9Q 732	1.9	1999.09 - 2000.05		410518.89D
1.9 dCi	F9Q 732	1.9	2000.06 - 2000.12		3470.89D50
1.9 dCi	F9Q 740	1.9	2000.11 - 2003.08		410517.89D

RENAULT
**Motor
Engine
Moteur**
**Ltr.
Ltr.
Ltr.**
**Jahr
Year
Année**
**Einschränkung
Restriction*
Restriction***
**Thermostat
Thermostat
Thermostat**

1.9 dCi	F9Q 732	1.9	2000.12 - 2003.08		410517.89D
1.9 dTi	F9Q 731, F9Q 736	1.9	1999.09 - 2000.12		3470.89D50
1.9 dTi	F9Q 731, F9Q 736	1.9	1999.09 - 2000.12		410517.89D
1.9 dTi	F9Q 731, F9Q 736	1.9	1999.09 - 2000.05		410518.89D
1.9 dTi	F9Q 734	1.9	1999.09 - 2000.05		410530.89D
1.9 dTi	F9Q 734, F9Q 731, F9Q 736	1.9	2000.06 -		3470.89D50
1.9 dTi	F9Q 731, F9Q 736	1.9	2000.12 -		410517.89D
1.9 dTi	F9Q 744	1.9	2001.02 - 2003.08		410517.89D
2.0 16V	F4R 741, F4R 740, F4R 744	2.0	1999.09 - 2003.08		3466.89D
2.0 16V	F4R 741, F4R 740, F4R 746	2.0	2000.07 - 2003.08		3466.89D
2.0 16V RX4	F4R 746, F4R 744	2.0	2000.06 - 2003.08		3466.89D

SCÉNIC II (JM)

1.4	K4J 730	1.4	2003.06 -	Deckel Thermostatgehäuse, Motor no. →050117	126104 ▲
1.4	K4J 740, K4J 770	1.4	2003.06 -	Deckel Thermostatgehäuse	126104 ▲
1.4	K4J 730	1.4	2003.06 -	Motor no. →050117	3466.89D
1.4	K4J 740, K4J 770	1.4	2003.06 -		3466.89D
1.5 dCi	K9K 722	1.5	2003.06 -		411477.89D ▲
1.5 dCi	K9K 724, K9K 729, K9K 732, K9K 734	1.5	2003.11 -	4 polig	411040.83D
1.5 dCi	K9K 728	1.5	2003.11 -		411042.89D
1.6	K4M 761, K4M 782	1.6	2003.06 -	Deckel Thermostatgehäuse, Motor no. →050117	126104 ▲
1.6	K4M 761, K4M 782	1.6	2003.06 -	Motor no. →050117	3466.89D
1.6	K4M 788	1.6	2006.06 -		3466.89D
1.9 D	F9Q J 803, F9Q 812	1.9	2006.06 -		410538.89D
1.9 dCi	F9Q 812	1.9	2003.06 -		410538.89D
1.9 dCi	F9Q 804	1.9	2005.05 -		410538.89D
2.0	F4R 770	2.0	2003.06 -		3466.89D
2.0 16V Turbo	F4R 776	2.0	2004.05 -		3466.89D
2.0 dCi	M9R 721, M9R 722, M9R 700	2.0	2005.09 -		411475.89D ▲

SCÉNIC III (JZ)

1.4 16V	H4J 700	1.4	2009.02 -		411241.82D
1.5 dCi	K9K 636, K9K 830, K9K 832, K9K 836, K9K 837	1.5	2009.02 -	4 polig	411040.83D
1.5 dCi	K9K 636, K9K 830, K9K 832, K9K 836, K9K 837	1.5	2009.02 -	2 polig	411442.83D ▲
1.5 dCi	K9K 846	1.5	2010.11 -	2 polig	411442.83D ▲
2.0 16V	M4R 711, M4R 710	2.0	2009.02 -		411241.82D

GRAND SCÉNIC

1.5 dCi	K9K 728	1.5	2004.04 -		411042.89D
1.6	K4M 761, K4M 782	1.6	2004.04 -	Deckel Thermostatgehäuse, Motor no. →050117	126104 ▲
1.6	K4M 761, K4M 782	1.6	2004.04 -	Motor no. →050117	3466.89D
1.6	K4M 788	1.6	2006.06 -		3466.89D
1.9 dCi	F9Q E 804, F9Q 812	1.9	2004.04 -		410538.89D
2.0	F4R 770, F4R 776	2.0	2004.04 -		3466.89D
2.0 dCi	M9R 721, M9R 722, M9R 700	2.0	2005.09 -		411475.89D ▲

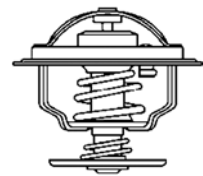

RENAULT

	Motor Engine Moteur	Ltr. Ltr. Ltr.	Jahr Year Année	Einschränkung Restriction* Restriction*	Thermostat Thermostat Thermostat
SPORT SPIDER					
2.0	F7R 710	2.0	1995.12 - 1996.08		3470.89D50
2.0 16V	F7R 710	2.0	1995.03 - 1999.10		3470.89D50
THALIA I (LB0/1/2_)					
1.2 16V	D4F 712	1.2	2002.04 -		3166.89D
1.4	K7J 700	1.4	2000.08 -	Deckel Thermostatgehäuse	126104 ▲
1.4	K7J 700	1.4	2000.08 -		3466.89D
1.4 16V	K4J 712	1.4	2000.08 -	Deckel Thermostatgehäuse	126104 ▲
1.4 16V	K4J 712	1.4	2000.08 -		3466.89D
1.5 dCi	K9K 700, K9K 702	1.5	2001.06 -		411043.89D
1.5 dCi	K9K 740	1.5	2005.06 -		411039.83D
1.6 16V	K4M 740	1.6	2002.04 -	Deckel Thermostatgehäuse	126104 ▲
1.6 16V	K4M 740	1.6	2002.04 -		3466.89D
1.6 Flex	K4M 743	1.6	2004.11 - 2009.02	Deckel Thermostatgehäuse	126104 ▲
1.6 Flex	K4M 743	1.6	2004.11 - 2009.02		3466.89D
1.9 D	F8Q 630	1.9	1998.02 - 2000.05		410530.89D
1.9 D	F8Q 630	1.9	2000.06 - 2001.05		3470.89D50
THALIA II (LU1/2_)					
1.2 16V	D4F 728	1.2	2008.09 -		3166.89D
1.5 dCi	K9K 718, K9K 740	1.5	2008.09 -		411039.83D
1.5 dCi	K9K 700	1.5	2009.01 -		411043.89D
1.6 16V	K4M 744	1.6	2009.01 -	Deckel Thermostatgehäuse, Motor no. →011212	126104 ▲
1.6 16V	K4M 745	1.6	2009.01 -	Deckel Thermostatgehäuse	126104 ▲
1.6 16V	K4M 744	1.6	2009.01 -	Motor no. →011212	3466.89D
1.6 16V	K4M 745	1.6	2009.01 -		3466.89D
TRAFIC (P6, T1, T3, T4, T5, T6, T7)					
1.4	847 701, 847 700, C1J 700	1.4	1980.03 - 1989.04		3029.86
1.6	A1M 705, A1M 707, A1M 708, 841 705	1.6	1983.01 - 1986.06		3053.85
1.7	F1N 722, F1N 724	1.7	1986.06 - 1989.04		3029.86
2.0	J5R 722, J5R 716, J5R 726, 829 721, 829 720	2.0	1980.03 - 1989.04		4122.87D
2.1 D	852 720, 852 750	2.1	1980.03 - 1989.04		4147.80D
2.5 D	8140.61.240, S8U 722, S8U 720	2.5	1980.03 - 1989.04		4008.79D
TRAFIC (PX, TX)					
1.4	C1J 700	1.4	1989.05 - 1991.06		3029.86
1.7	F1N 720, F1N 722, F1N 724	1.7	1989.03 - 1994.08		3470.89D50
1.9 D	F8Q 606	1.9	1997.06 - 1998.01		3470.89D50
1.9 D	F8Q 606	1.9	1998.02 - 2000.05		410530.89D
1.9 D	F8Q 606	1.9	2000.06 - 2001.03		3470.89D50
2.0	J5R 716, J5R 726	2.0	1989.05 - 1997.10		4122.87D
2.1 D	852 750, 852 720, J8S 758, J8S 620	2.1	1989.05 - 1994.06		4147.80D
2.2	J7T 600, J7T 780	2.2	1989.05 - 1997.10		4122.87D
2.5 D	8140.61	2.5	1989.05 - 2001.03		4151.76D
2.5 D	8140.67	2.5	1989.05 - 2001.03		4174.79D

RENAULT
**Motor
Engine
Moteur**
**Ltr.
Ltr.
Ltr.**
**Jahr
Year
Année**
**Einschränkung
Restriction*
Restriction***
**Thermostat
Thermostat
Thermostat**

2.5 D	S8U720, S8U722	2.5	1989.05 - 2001.03		4174.79D
2.5 D	S8U 780, S8U 758	2.5	1994.09 - 2001.03		4151.76D

TRAFIC (FL, JL, EL)

1.9 dCi	F9Q 762	1.9	2001.04 - 2003.07		410517.83D
1.9 dCi 80	F9Q 760, F9Q 762	1.9	2001.03 -		410517.83D
1.9 dCi 100	F9Q 760	1.9	2001.03 -		410517.83D
2.0	F4R 722, F4R 720	2.0	2001.03 -		3466.89D
2.0 16V	F4R 820	2.0	2006.08 -		3466.89D
2.0 dCi 90	M9R 782, M9R 780	2.0	2006.08 -		411476.83D ▲
2.0 dCi 115	M9R	2.0	2006.08 -		411476.83D ▲

TWINGO I (C06_)

1.2	C3G 702, C3G 700	1.2	1993.03 - 1996.10		3029.89
1.2	D7F	1.2	1996.05 - 1998.06		3174.89D
1.2	D7F	1.2	1998.07 -		3166.89D
1.2 16V	D4F 702, D4F 708	1.2	2001.01 -		3166.89D
1.2 LPG	D7F 708, D7F 702	1.2	2003.10 -		3166.89D

TWINGO II (CN0_)

1.2	D7F 800	1.2	2007.03 -		3166.89D
1.2 16V	D4F 764, D4F 772	1.2	2007.03 -		3166.89D
1.2 TCe 100	D4F 780, D4F 782	1.2	2011.02 -		3166.89D
1.2 Turbo	D4F 780, D4F 782	1.2	2007.03 -		3166.89D
1.5 dCi	K9K 718, K9K 740	1.5	2007.03 -	4 polig	411040.83D
1.5 dCi	K9K 718, K9K 740	1.5	2007.03 -	2 polig	411442.83D ▲
1.5 dCi 75	K9K 820	1.5	2010.10 -	2 polig	411442.83D ▲
1.5 dCi 90	K9K 820, K9K 830	1.5	2010.10 -	2 polig	411442.83D ▲

TWINGO I Kasten (S06_)

1.2	C3G 702, C3G 700	1.2	1993.03 - 1996.05		3029.86
1.2	D7F 700, D7F 702, D7F 704, D7F 706, D7F 701, D7F 703	1.2	1996.05 - 1998.06		3174.89D
1.2	D7F 700, D7F 702, D7F 704, D7F 706, D7F 701, D7F 703	1.2	1998.07 -		3166.89D

VEL SATIS (BJ0)

2.0 16V Turbo	F4R 762, F4R 763, F4R 766, F4R 767	2.0	2002.06 -		3466.89D
2.0 dCi	M9R 762, M9R 763, M9R 760	2.0	2005.08 -		411475.89D ▲
2.0 Turbo	F4R 867	2.0	2005.04 -		3466.89D

WIND (E4M_)

1.2	D4F 782	1.2	2010.07 -		3166.89D
1.2 TCe 100	D4F 780	1.2	2011.02 -		3166.89D

**ROLLS-ROYCE**

	Motor Engine Moteur	Ltr. Ltr. Ltr.	Jahr Year Année	Einschränkung Restriction* Restriction*	Thermostat Thermostat Thermostat
GHOST					
6.6 V12	N74 B66 A	6.6	2008.08 -		4508.105D
PHANTOM					
6.75	N73 B68 A	6.75	2002.08 -		4508.105D
PHANTOM Coupe					
6.75 V12	N73 B68 A	6.75	2007.01 -		4508.105D
PHANTOM DROPHEAD COUPE					
6.75 V12	N73 B68 A	6.75	2006.03 -		4508.105D
WRAITH Coupe					
6.6 V12		6.6	2013.07 -		4508.105D

ROVER

 Motor
Engine
Moteur

 Ltr.
Ltr.
Ltr.

 Jahr
Year
Année

 Einschränkung
Restriction*
Restriction*

 Thermostat
Thermostat
Thermostat

25 (RF)

1.4 16V	14 K4F	1.4	1999.10 - 2005.05		410808.88D
1.6 16V	16 K4F	1.6	1999.10 - 2005.05		410808.88D
1.8 16V	18 K4F, 18 K4K	1.8	1999.10 - 2005.05		410808.88D

45 (RT)

1.4	14 K4F	1.4	2000.02 - 2005.05		410808.88D
1.6	16 K4F	1.6	2000.02 - 2005.05		410808.88D
1.8	18 K4F	1.8	2000.02 - 2005.05		410808.88D
2.0 V6	20 K4F	2.0	2000.02 - 2005.05		410808.88D

75 (RJ)

1.8	K 1.8	1.8	1999.02 - 2005.05		410808.88D
1.8 Turbo	18 K4G	1.8	2003.05 - 2005.05		410806.88D
2.0 V6	20 K4F	2.0	1999.02 - 2005.05		410808.88D

100 Cabriolet (XP)

111	11 K2D	1.1	1994.04 - 1997.10		410808.88D
114	14 K2D, 14 K2A, 14 K4F	1.4	1994.04 - 1998.10		410808.88D

100 / METRO (XP)

111	11 K2D, 11 K2A	1.1	1990.03 - 1998.12		410808.88D
114	14 K2D, 14 K2A, 14 K4F	1.4	1990.03 - 1998.12		410808.88D
114 D	TUD 3	1.4	1992.10 - 1994.12		4821.89D
114 GTI 16V	14 K4C, 14 K4D, 14 K4F	1.4	1990.03 - 1998.12		410808.88D
114 GTI/GT 16V KAT	14 K4C, 14 K4D	1.4	1990.03 - 1998.12		410808.88D
115 D	TUD 5	1.5	1994.12 - 1998.12		4821.89D

200 (XH)

213 S	EV 2	1.3	1985.09 - 1989.09		4269.78D
-------	------	-----	-------------------	--	----------

200 (RF)

1.4	14 K4D	1.4	1996.01 - 1997.12		410808.88D
211	11 K2D	1.1	1998.01 - 2000.03		410808.88D
214 i	14 K2F	1.4	1995.11 - 2000.03		410808.88D
214 Si	14 K4F	1.4	1995.11 - 2000.03		410808.88D
216 Si	16 K4F	1.6	1995.11 - 2000.03		410808.88D
218 K Vi	18 K4K	1.8	1995.11 - 2000.03		410808.88D

200 (XW)

214	14 K2D, 14 K2A	1.4	1993.09 - 1995.10		410808.88D
214 GSi/Si	14 K4C, 14 K4F	1.4	1990.01 - 1995.10		410808.88D
214 Si/Gsi	14 K4C, 14 K4D	1.4	1989.10 - 1995.10		410808.88D
216	D 16 A7, D 16 A8, D 16 Z2	1.6	1992.10 - 1999.06		4269.78D
216 GTi	D 16 A8	1.6	1992.10 - 1995.10		410224.82D
216 GTi	D 16 A9	1.6	1992.10 - 1995.10		410224.82D
218 TD	XUD 7TE	1.8	1991.09 - 1995.10		4147.80D

400 (RT, XW)

1.6 i	D 16 A8, D 16 Z2	1.6	1994.05 - 1996.02		410224.82D
1.8 i	18 K4K	1.8	1996.06 - 1998.11		410808.88D
1.8 TD	XUD 7TE	1.8	1993.09 - 1998.11		4147.80D

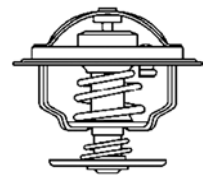

ROVER

	Motor Engine Moteur	Ltr. Ltr. Ltr.	Jahr Year Année	Einschränkung Restriction* Restriction*	Thermostat Thermostat Thermostat
414	14 K2F, 14 K4C, 14 K4D, 14 K4F	1.4	1990.04 - 2000.03		410808.88D
416	D 16 A7, D 16 Z2	1.6	1990.04 - 1995.04		4269.78D
416	16 K4F	1.6	1995.05 - 2000.03		410808.88D
416 GTI/GTE	D 16 A8, D 16 A9	1.6	1992.10 - 1995.04		410224.82D
418 D		1.9	1991.09 - 1995.04		4147.80D
418 TD	XUD 7TE	1.8	1991.09 - 1995.04		4147.80D
600 (RH)					
618 i	F 18 A3	1.9	1996.03 - 1999.02		4269.78D
620 i	F 20 Z2	2.0	1993.08 - 1996.06		4269.78D
620 i	F 20 Z1	2.0	1993.08 - 1999.02		4269.78D
623 i	H 23 A3	2.3	1993.08 - 1999.02		4269.78D
800 (XS)					
820 16 V	20 HD	2.0	1986.10 - 1988.10		3004.82
820 i	20 HD	2.0	1988.10 - 1991.12		3004.82
820 SI	20 HD M 16	2.0	1988.10 - 1991.12		3004.82
825 D	425 SL1RR, 492 4 SHIRG	2.5	1990.01 - 1999.02		4158.80D
CABRIOLET (XW)					
214 1.4	14 K4C, 14 K4D	1.4	1990.04 - 1999.11		410808.88D
214 1.4i 16V	14 K4F	1.4	1993.01 - 1999.11		410808.88D
216 1.6i 16V	16 K4F	1.6	1996.01 - 1999.11		410808.88D
COUPE					
1.6 16 V	16 K4F	1.6	1996.03 - 1999.11		410808.88D
1.8 16 V	18 K4K	1.8	1996.03 - 1999.11		410808.88D
MINI					
1000	99 HD 81	1.0	1992.01 - 1993.06		3004.82
1300	12 A2A, 12 A2B	1.3	1991.01 - 2000.11		3004.82
1300	12 A2D, 12 A2E, 12 A2L	1.3	1992.01 - 2000.11		3004.82
MINI Cabriolet (XN)					
1300	12 A2E	1.3	1992.09 - 1995.04		3004.82
MONTEGO Estate (XE)					
2.0 GTI/LXI	20 H	2.0	1990.12 - 1993.12		3004.82

SAAB
**Motor
Engine
Moteur**
**Ltr.
Ltr.
Ltr.**
**Jahr
Year
Année**
**Einschränkung
Restriction*
Restriction***
**Thermostat
Thermostat
Thermostat**
90

2.0 B 20 I 2.0 1984.08 - 1987.08 4154.82D

95

1.5 V4 Ford V4 1.5 1965.10 - 1978.12 3021.88D50

96

1.5 V4 Ford V4 1.5 1965.10 - 1980.08 3021.88D50

99

1.7 1.7 1968.08 - 1971.05 4022.82D

1.85 1.85 1970.10 - 1974.05 4022.82D

1.85 i 1.85 1971.10 - 1972.09 4022.82D

2.0 B20T, B 20 P 2.0 1972.10 - 1984.01 4022.88D

2.0 B 20 I, B 20 C 2.0 1974.09 - 1984.12 4022.88D

2.0 EMS B201, B 20 I 2.0 1972.04 - 1978.12 4022.88D

2.0 i BI 20 2.0 1981.01 - 1984.12 4022.88D

2.0 Turbo 2.0 1977.10 - 1980.06 4022.88D

9-3 (YS3D)

2.0 i B204I 2.0 1998.02 - 2003.08 4154.88D

2.0 Turbo B204E, B204R, B205E, B205L, B204L, B205R 2.0 1998.02 - 2003.08 4154.88D

2.2 TiD X 22 DTH, D223L 2.2 1998.02 - 2002.09 4193.92D

2.3 B235R 2.3 1999.09 - 2002.01 4154.88D

2.3 i B234I 2.3 1998.02 - 2003.08 4154.88D

2.3 Turbo B235R 2.3 1998.10 - 2003.08 4154.88D

9-3 (YS3F)

1.8 i Z 18 XE 1.8 2004.01 - 411578.92D ▲

1.8 T B207E 1.8 2002.09 - 411193.82D

1.8 T BioPower B207E, B207L 1.8 2007.01 - 411193.82D

1.9 TiD Z 19 DT, Z 19 DTH, Z 19 DTJ 1.9 2004.09 - 410049.88D

1.9 TTiD A 19 DTR, Z 19 DTR 1.9 2007.12 - 410049.88D

2.0 2.0 2006.04 - 2007.09 411193.82D

2.0 T A 20 NFT, B207E, B207G, B207L, B207M, B207R 2.0 2002.09 - 411193.82D

2.0 T BioPower A 20 NFT, B207H, B207L, B207M, B207R 2.0 2002.09 - 411193.82D

2.0 Turbo B207R 2.0 2008.01 - 411193.82D

2.0 Turbo Performance 2.0 2004.04 - 411193.82D

2.2 TiD D223L 2.2 2002.09 - 4297.92D

2.8 Turbo V6 B284L, LP9 2.8 2005.03 - 411193.82D

9-3X

1.9 TTiD Z 19 DTR, A 19 DTR 1.9 2009.02 - 410049.88D

2.0 T B207R 2.0 2009.02 - 411193.82D

2.0 T BioPower A 20 NFT, B207R 2.0 2009.02 - 411193.82D

9-5 (YS3E)

1.9 TiD Z 19 DTH, Z 19 DTR 1.9 2006.01 - 410049.88D

2.0 T B204R, B205E, B205F, B205L 2.0 1997.09 - 4154.88D

2.0 T BioPower A 20 NFT, B205E 2.0 2005.01 - 411193.82D

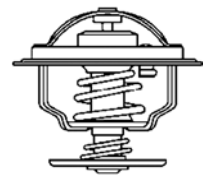

SAAB

	Motor Engine Moteur	Ltr. Ltr. Ltr.	Jahr Year Année	Einschränkung Restriction* Restriction*	Thermostat Thermostat Thermostat
2.0 Turbo	B205E	2.0	1998.10 -		4154.88D
2.2 TiD	D223L	2.2	2002.03 -		4297.92D
2.3 T	B235E	2.3	1997.09 -		4154.88D
2.3 T BioPower	B235E, B235R	2.3	2006.11 -		4154.88D
2.3 Turbo	B235E, B235L, B235R	2.3	1999.10 -		4154.88D
9-5 (YS3G)					
1.6 Turbo	A 16 LET	1.6	2010.05 -		4357.92D
2.0 T BioPower	A 20 NFT	2.0	2010.05 -		411193.82D
2.0 Turbo	A 20 NHT	2.0	2010.05 -		411193.82D
900 I					
2.0	B201	2.0	1978.06 - 1989.09		4022.88D
2.0	B202I, B202S, B202S	2.0	1987.10 - 1993.10		4154.82D
2.0 -16	B202I, B202S, B202XI	2.0	1986.01 - 1994.06		4154.82D
2.0 16v	B202I	2.0	1990.04 - 1990.12		4154.82D
2.0 8V Turbo	B201L	2.0	1988.01 - 1990.12		4022.82D
2.0 c	B201XC, B 20, B20T, BT 20	2.0	1978.09 - 1988.12		4022.88D
2.0 EMS	BI 20	2.0	1978.09 - 1980.12		4022.82D
2.0 i	BI 20, B201, B201XI	2.0	1980.11 - 1990.08		4022.88D
2.0 S Turbo-16	B202S	2.0	1991.07 - 1994.06		4154.82D
2.0 T8	B201L	2.0	1986.10 - 1989.09		4022.88D
2.0 Turbo	B201S, BSI 20, B201XL	2.0	1978.09 - 1985.07		4022.82D
2.0 Turbo-16	B202L, B202XL	2.0	1984.02 - 1994.06		4154.82D
2.1 -16	B212I	2.1	1990.08 - 1994.06		4154.82D
2.1 16 S	B212I	2.1	1989.10 - 1992.07	82° Variante	4154.82D
2.1 16 S	B212I	2.1	1989.10 - 1992.07	88° Variante	4154.88D
900 II					
2.0 -16 Turbo	B204L	2.0	1993.07 - 1998.02		4154.88D
2.0 i	B204I, B206I	2.0	1993.07 - 1994.07		4154.88D
2.3 -16	B234I	2.3	1993.07 - 1998.02		4154.88D
2.5 -24 V6	B258I	2.5	1993.07 - 1998.02		4175.92D
9000					
2.0		2.0	1988.10 - 1990.08		4154.82D
2.0 -16	B202I, B202XI, B204I, B204S, B204E	2.0	1985.12 - 1998.12		4154.82D
2.0 -16 Turbo	B202, B202L, B202XL, B204S, B204E, B202S	2.0	1984.09 - 1998.12		4154.82D
2.0 16v	B202L	2.0	1989.09 - 1990.01		4154.82D
2.0 T16		2.0	1989.06 - 1990.10		4154.88D
2.3	B234I, B234R	2.3	1989.10 - 1993.12		4154.82D
2.3 -16	B234I	2.3	1989.08 - 1998.12		4154.82D
2.3 -16 Aero CS	B234R	2.3	1993.02 - 1998.12		4154.82D
2.3 -16 Eco Power	B234E	2.3	1993.09 - 1998.12		4154.82D
2.3 -16 Turbo	B234L	2.3	1990.07 - 1998.12		4154.82D
2.3 -16 Turbo	B234L	2.3	1990.09 - 1998.12		4154.82D
3.0 -24 V6	B308I	3.0	1994.07 - 1998.12		4175.92D

SEAT
**Motor
Engine
Moteur**
**Ltr.
Ltr.
Ltr.**
**Jahr
Year
Année**
**Einschränkung
Restriction*
Restriction***
**Thermostat
Thermostat
Thermostat**
131

1.5		1.5	1982.03 - 1985.01		3345.79
2.4 Diesel	8144.61	2.4	1978.06 - 1986.12		4008.79D

ALHAMBRA

1.8 T 20V	AWC, AJH	1.8	1997.10 - 2010.03		3141.87D
1.9 TDI	ANU, 1Z, AHU, ARL, BTB, ASZ,AVG, AFN, BVK, AUY	1.9	1996.04 - 2010.03		4264.87D
2.0 i	ATM, ADY	2.0	1996.04 - 2010.03		4264.87D
2.0 TDI	BRT	2.0	2005.11 - 2010.03		4264.87D
2.8 V6	AYL, AUE	2.8	2000.06 - 2010.03		4123.80D

ALHAMBRA (710)

2.0 TDI	CFFA, CFFB, CFFE, CFGB	2.0	2010.06 -		410845.87D
---------	------------------------	-----	-----------	--	------------

ALTEA (5P1)

1.4 16V	CGGB, BXW	1.4	2006.05 -	mit Gehäuse	410475.87D
1.6	BGU, CCSA, BSF, CMXA, BSE	1.6	2004.03 -		3141.87D
1.6 LPG	CHGA	1.6	2009.09 -		3141.87D
1.6 TDI	CAYC	1.6	2009.10 - 2010.07	mit Gehäuse	410536.92D
1.6 TDI	CAYC	1.6	2009.10 - 2010.07	ohne Gehäuse	410537.92D
1.6 TDI	CAYC	1.6	2010.08 -		410845.92D
1.6 TDI	CAYB	1.6	2010.11 -		410845.92D
1.9 TDI	BJB, BKC, BXE, BXF	1.9	2004.04 -		4264.87D
1.9 TDI	BLS	1.9	2004.04 -		4820.87D
2.0 FSI	BVY, BVZ	2.0	2004.05 - 2009.03		411186.87D
2.0 TDI	AZV, BMN	2.0	2004.03 - 2009.05		3472.87D
2.0 TDI	BMM	2.0	2005.11 -		4820.87D
2.0 TDI	CEGA	2.0	2006.03 - 2009.07		3472.87D
2.0 TDI 16V	BKD	2.0	2004.03 -		3472.87D
2.0 TDI 16V	CFHC	2.0	2004.03 -		410845.87D
2.0 TFSI	BWA	2.0	2006.04 - 2009.05		411187.87D

ALTEA XL (5P5, 5P8)

1.4 16V	CGGB, BXW	1.4	2006.10 -	mit Gehäuse	410475.87D
1.6	CCSA, BSF, CMXA, BSE	1.6	2006.10 -		3141.87D
1.6 LPG	CHGA	1.6	2009.09 -		3141.87D
1.6 Multifuel	CCSA	1.6	2006.10 -		3141.87D
1.6 TDI	CAYC	1.6	2009.10 - 2010.07	mit Gehäuse	410536.92D
1.6 TDI	CAYC	1.6	2009.10 - 2010.07	ohne Gehäuse	410537.92D
1.6 TDI	CAYC	1.6	2010.08 -		410845.92D
1.6 TDI	CAYB	1.6	2010.11 -		410845.92D
1.9 TDI	BKC, BXE, BXF	1.9	2006.10 -		4264.87D
1.9 TDI	BLS	1.9	2006.10 -		4820.87D
2.0 TDI	BMM	2.0	2006.10 -		4820.87D
2.0 TDI	AZV, BMN	2.0	2006.11 -		3472.87D
2.0 TDI	CFJA	2.0	2007.06 -		410845.87D
2.0 TDI 16V	BKD	2.0	2006.10 -		3472.87D
2.0 TDI 16V	CFHC	2.0	2006.10 -		410845.87D
2.0 TFSI	BWA	2.0	2007.06 - 2009.05		411187.87D

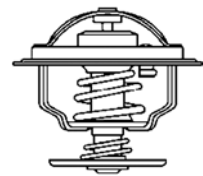
SEAT

	Motor Engine Moteur	Ltr. Ltr. Ltr.	Jahr Year Année	Einschränkung Restriction* Restriction*	Thermostat Thermostat Thermostat
AROSA					
1.0	AER, ANV, ALD, ALL, AUC	1.0	1997.05 - 2004.06	mit Gehäuse	410989.87D
1.4	AEX, AKV, ANW, AKK, APQ, AUD	1.4	1997.05 - 2004.06	mit Gehäuse	410989.87D
1.4 16V	AFK, AUB, AQQ	1.4	2000.01 - 2004.06	mit Gehäuse	410989.87D
1.4 TDI	AMF	1.4	2000.01 - 2004.06		4264.87D
1.7 SDI	AKU	1.7	1997.08 - 2004.06		4264.87D
CORDOBA (6K2/C2, 6K5)					
1.0	AAU	1.0	1993.02 - 1996.06		4264.84D
1.0	ANV, ALD, AUC	1.0	1999.06 - 2002.10	mit Gehäuse	410989.87D
1.0 16V	AST, AVZ	1.0	2000.05 - 2002.10	mit Gehäuse	410989.87D
1.0 i	AER	1.0	1996.09 - 1999.06	mit Gehäuse	410989.87D
1.3	2G, AAV	1.3	1993.02 - 1994.08		4264.84D
1.4	ANW, AKK, ANX, AUD, AUB, AQQ	1.4	1997.12 - 2002.12	mit Gehäuse	410989.87D
1.4 16V	APE, AUA, AUB, AQQ	1.4	1999.06 - 2002.12	mit Gehäuse	410989.87D
1.4 i	AEX, AKV, APQ	1.4	1994.06 - 1999.06	mit Gehäuse	410989.87D
1.4 i	ABD	1.4	1994.06 - 1999.06		4264.84D
1.4 i 16V	AFH	1.4	1996.09 - 1999.06	mit Gehäuse	410989.87D
1.6	AEH, AKL, APF, AUR	1.6	1999.06 - 2002.12		3141.87D
1.6	ALM	1.6	1999.06 - 2002.12	mit Gehäuse	410989.87D
1.6 i	AEE, ALM	1.6	1993.02 - 1999.06	mit Gehäuse	410989.87D
1.6 i	1F, ABU, AFT	1.6	1993.02 - 1999.10		4264.87D
1.6 i	AKL	1.6	1996.07 - 1999.10		3141.87D
1.7 SDI	AKU	1.7	1997.07 - 1999.06		4264.87D
1.8 i	ACC, ADZ, ABS	1.8	1993.02 - 1999.06		4264.87D
1.8 i 16V	ADL	1.8	1993.10 - 1996.08		4264.87D
1.8 T 20V Cupra	AYP, AQX	1.8	2000.07 - 2002.10		3141.87D
1.9 D	1Y	1.9	1993.02 - 1996.08		4253.87D
1.9 SDI	AEY, AQM, AGP	1.9	1996.08 - 2002.12		4264.84D
1.9 TD	AAZ	1.9	1993.02 - 1996.08		4253.87D
1.9 TDI	1Z, AHU, AFN, AGR, ALH, ASV	1.9	1996.08 - 2002.12		4264.87D
2.0 i	2E, AGG	2.0	1993.02 - 1999.06		4264.87D
2.0 i 16V	ABF	2.0	1996.08 - 1999.06		4264.84D
CORDOBA (6L2)					
1.2 12V	BXV	1.2	2006.05 - 2009.11	mit Gehäuse	410475.87D
1.4 16V	BBZ, AUB, BBY, BKY, BXW	1.4	2002.09 - 2009.11	mit Gehäuse	410475.87D
1.4 TDI	AMF, BMS, BNM, BNV	1.4	2002.10 - 2009.11		4264.87D
1.6	BAH	1.6	2003.04 - 2009.11	mit Gehäuse	410475.80D
1.9 SDI	ASY	1.9	2002.09 - 2009.11		4264.87D
1.9 TDI	AXR, ATD, BLT, ASZ	1.9	2002.09 - 2009.11		4264.87D
1.9 TDI	BMT	1.9	2002.09 - 2009.11		4820.87D
2.0	AZL, BBX	2.0	2002.09 - 2009.11		3141.87D
EXEO					
2.0 TDI	CAGA, CAHA,, CAGC, CGLB, CJCA, CJCC,	2.0	2008.12 - 2009.08		410396.82D
2.0 TFSI	BWE	2.0	2009.03 -		411186.87D

SEAT
**Motor
Engine
Moteur**
**Ltr.
Ltr.
Ltr.**
**Jahr
Year
Année**
**Einschränkung
Restriction*
Restriction***
**Thermostat
Thermostat
Thermostat**
IBIZA I (021A)

0.9	146 A 000, 09 NCA	0.9	1990.08 - 1993.05		3361.87D
1.2	021 A 1000	1.2	1984.11 - 1993.12		4256.87D50
1.2 i	021 C.1000	1.2	1989.01 - 1993.05		4256.87D50
1.5	021 A 2000	1.5	1984.11 - 1993.05		4256.87D50
1.5 i	021 B.2000, 021 C.2000, 021 D.2000	1.5	1986.10 - 1993.05		4256.87D50
1.7	021 A.3000, 021 B.3000	1.7	1991.01 - 1993.05		4256.87D50

IBIZA II (6K1)

1.0	AAU	1.0	1993.03 - 1996.09		4264.84D
1.0 i	AER	1.0	1996.09 - 1999.08	mit Gehäuse	410989.87D
1.3 i	2G, AAV	1.3	1993.03 - 1999.08		4264.84D
1.4 i	AEX, AKV, APQ	1.4	1993.09 - 1999.08	mit Gehäuse	410989.87D
1.4 i	ABD	1.4	1993.09 - 1999.08		4264.84D
1.4 i 16V	AFH	1.4	1997.06 - 1999.08	mit Gehäuse	410989.87D
1.6 i	AEE, ALM	1.6	1993.03 - 1999.08	mit Gehäuse	410989.87D
1.6 i	1F, ABU, AFT	1.6	1993.03 - 1999.08		4264.84D
1.8 i	ACC, ADZ, ABS	1.8	1993.03 - 1999.08		4264.87D
1.8 i 16V	ADL	1.8	1993.11 - 1996.08		4264.87D
1.9 D	1Y	1.9	1993.04 - 1996.08		4253.87D
1.9 SDI	AEY	1.9	1996.08 - 1999.08		4264.84D
1.9 TD	AAZ	1.9	1993.03 - 1996.08		4253.87D
1.9 TDI	1Z, AFN, AHU	1.9	1996.08 - 1999.08		4253.87D
2.0 i	2E, AGG	2.0	1993.03 - 1999.08		4264.87D
2.0 i 16V	ABF	2.0	1996.08 - 1999.08		4264.84D

IBIZA III (6K1)

1.0	ANV, ALD, AUC	1.0	1999.08 - 2002.02	mit Gehäuse	410989.87D
1.0 16V	AST, AVZ	1.0	1999.10 - 2002.02	mit Gehäuse	410989.87D
1.4	ANW, AKK, AUD	1.4	1999.08 - 2002.02	mit Gehäuse	410989.87D
1.4 16V	AUB, AQQ, APE, AUA	1.4	1999.08 - 2002.02	mit Gehäuse	410989.87D
1.6	AEH, AKL, APF, AUR	1.6	1999.08 - 2002.02		3141.87D
1.6	ALM	1.6	1999.08 - 2002.02	mit Gehäuse	410989.87D
1.8 T 20V Cupra	AYP, AQX	1.8	2000.07 - 2002.02		3141.87D
1.9 SDI	AQM, AGP	1.9	1999.08 - 2002.02		4264.87D
1.9 TDI	AGR, ALH, ASV	1.9	1999.08 - 2002.02		4264.87D

IBIZA IV (6L1)

1.4 16V	AUB, BBY, BBZ, BKY, BXW	1.4	2002.02 - 2009.11	mit Gehäuse	410475.87D
1.4 TDI	AMF, BMS, BNM, BNV	1.4	2002.05 - 2005.12		4264.87D
1.6	BAH	1.6	2003.02 - 2009.11	mit Gehäuse	410475.80D
1.8 T Cupra R	BBU, BLZ	1.8	2004.01 - 2008.02		3141.87D
1.8 T FR	BKV, BJX	1.8	2003.12 - 2008.05		3141.87D
1.9 SDI	ASY, ASZ, BLT	1.9	2002.02 - 2005.12		4264.87D
1.9 TDI	AXR, ASZ, ATD, BLT	1.9	2002.02 - 2009.11		4264.87D
1.9 TDI	BMT	1.9	2002.02 - 2009.11		4820.87D
1.9 TDI Cupra R	BPX, BUK	1.9	2004.03 - 2008.02		4264.87D
2.0	AZL, BBX	2.0	2002.04 - 2009.11		3141.87D

IBIZA V (6J1, 6J5)

1.4	CGGB, BXW	1.4	2008.03 -	mit Gehäuse	410475.87D
1.4 TDI	BMS	1.4	2008.07 -		4264.87D
1.6 TDI	CAYB, CAYC, CLNA	1.6	2009.05 - 2010.05	mit Gehäuse	410536.92D
1.6 TDI	CAYB, CAYC, CLNA	1.6	2009.05 - 2010.05	ohne Gehäuse	410537.92D
1.6 TDI	CAYB, CAYC, CLNA	1.6	2010.06 -		410845.92D

SEAT

	Motor Engine Moteur	Ltr. Ltr. Ltr.	Jahr Year Année	Einschränkung Restriction* Restriction*	Thermostat Thermostat Thermostat
1.9 TDI	BLS, BXJ	1.9	2008.03 - 2010.06		4820.87D
2.0 TDI	CFHD	2.0	2010.01 -		410845.87D
IBIZA V ST (6J8)					
1.4	CGGB	1.4	2010.03 -	mit Gehäuse	410475.87D
1.6 TDI	CAYB, CAYC, CLNA	1.6	2010.03 - 2010.05	mit Gehäuse	410536.92D
1.6 TDI	CAYB, CAYC, CLNA	1.6	2010.03 - 2010.05	ohne Gehäuse	410537.92D
1.6 TDI	CAYB, CAYC, CLNA	1.6	2010.06 -		410845.92D
INCA					
1.4 16V	AUA	1.4	2000.04 - 2003.06	mit Gehäuse	410989.87D
1.4 i	AEX, AKV, APQ, AUD	1.4	1995.11 - 2003.06	mit Gehäuse	410989.87D
1.6 i	1F	1.6	1995.11 - 1998.05		4253.87D
1.6 i	AEE, ALM	1.6	1997.06 - 2000.09	mit Gehäuse	410989.87D
1.7 D	AHB	1.7	1996.09 - 2003.06		4264.87D
1.9 D	1Y	1.9	1995.11 - 2003.06		4264.87D
1.9 SDI	AYQ, AEY	1.9	1995.11 - 2003.06		4253.87D
1.9 TDI	ALH	1.9	1996.09 - 2003.06		4253.87D
LEON (1M1) 2006<--					
1.4 16V	AHW, AXP, BCA, APE, AUA	1.4	1999.11 - 2006.06	mit Gehäuse	410989.87D
1.6	AKL, APF, AEH, BGU	1.6	1999.11 - 2006.06		3141.87D
1.6 16 V	AUS, ATN, BCB, AZD	1.6	2000.09 - 2006.06	mit Gehäuse	410989.87D
1.8 20V / T	AGN, APG, AJQ, ARY, APP, AUQ	1.8	1999.11 - 2006.06		3141.87D
1.8 T Cupra R	AMK, BAM	1.8	2002.02 - 2006.06		3141.87D
1.9 SDI	AQM	1.9	1999.11 - 2006.06		4264.87D
1.9 TDI	AGR, ALH, AHF, ASV, ARL, ASZ, AXR	1.9	1999.11 - 2006.06		4264.87D
2.3 VR5	AQN	2.3	2000.09 - 2003.11		4123.80D
2.8	BDE	2.8	2002.05 - 2004.06		4123.80D
2.8 Cupra 4	AUE	2.8	2001.02 - 2006.06		4123.80D
LEON (1P1) 2006→					
1.4 16V	CGGB, BXW	1.4	2006.06 -	mit Gehäuse	410475.87D
1.6	BSE, BSF, CCSA	1.6	2005.07 -		3141.87D
1.6 LPG	CHGA	1.6	2009.12 -		3141.87D
1.6 TDI	CAYC	1.6	2010.02 - 2010.07	mit Gehäuse	410536.92D
1.6 TDI	CAYC	1.6	2010.02 - 2010.07	ohne Gehäuse	410537.92D
1.6 TDI	CAYC	1.6	2010.08 -		410845.92D
1.9 TDI	ASV, BXE, BKC, BXF	1.9	2005.07 -		4264.87D
1.9 TDI	BLS	1.9	2005.07 -		4820.87D
2.0 FSI	BVY, BVZ	2.0	2005.07 - 2010.05		411186.87D
2.0 TDI	AZV, BMN	2.0	2005.07 -		3472.87D
2.0 TDI	BMM	2.0	2005.10 -		4820.87D
2.0 TDI	CFJA	2.0	2006.05 -		410845.87D
2.0 TDI 16V	BKD	2.0	2005.07 -		3472.87D
2.0 TDI 16V	CFHC	2.0	2005.07 -		410845.87D
2.0 TFSI	BWA, BWA1	2.0	2005.05 - 2009.03		411187.87D
MALAGA					
1.2	021 A 1000	1.2	1984.11 - 1993.12		4256.87D50
1.2 i	021 C.1000	1.2	1989.12 - 1993.12		4256.87D50
1.5	021 A 2000	1.5	1985.05 - 1993.12		4256.87D50
1.5 i	021 A 2000, 021 B.2000, 021 C.2000, 021 D.2000	1.5	1986.10 - 1993.12		4256.87D50

SEAT
**Motor
Engine
Moteur**
**Ltr.
Ltr.
Ltr.**
**Jahr
Year
Année**
**Einschränkung
Restriction*
Restriction***
**Thermostat
Thermostat
Thermostat**
MARBELLA

0.8	08 NCA	0.8	1986.08 - 1993.12		3361.87D
0.9	08 NCB	0.9	1987.01 - 1998.10		3361.87D
0.9	100 GL 7000, 09 NCA	0.9	1987.01 - 1996.11		3361.87D

PANDA (141A)

0.9	100 GL 3000	0.9	1980.10 - 1986.12		3361.87D
-----	-------------	-----	-------------------	--	----------

RONDA

1.2	021 A 1000, 124 B6.000	1.2	1983.08 - 1986.12		4256.87D50
1.5	021 A 2000	1.5	1984.09 - 1986.12		4256.87D50
1.6	138 AR6.000, 022 A 000	1.6	1983.08 - 1985.09		4256.87D50

TERRA

0.9	09 NCA, 09 NCB	0.9	1987.01 - 1996.12		3361.87D
1.3 D	MN	1.3	1990.03 - 1994.12		4264.84D
1.4 D	1 W	1.4	1990.10 - 1995.12		4264.84D

TOLEDO I

1.6 i	EZ, ABN, 1F, AFT	1.6	1991.05 - 1999.03		4264.87D
1.8 16V	KR, PL	1.8	1991.05 - 1999.03		4264.87D
1.8 GT	KR	1.8	1991.05 - 1992.11		4264.87D
1.8 i	ACC, ADZ, ABS, RP	1.8	1991.05 - 1996.12		4264.87D
1.9 D	1Y	1.9	1991.05 - 1999.03		4264.87D
1.9 TD	AAZ	1.9	1991.05 - 1999.03		4264.87D
1.9 TDI	1Z, AHU, AFN	1.9	1995.08 - 1999.03		4264.87D
2.0 i	2E, AGG	2.0	1991.05 - 1999.03		4264.87D
2.0 i 16V	ABF	2.0	1993.11 - 1999.03		4264.84D

TOLEDO II

1.4 16V	AHW, AXP, BCA, APE, AUA	1.4	1999.07 - 2006.05	mit Gehäuse	410989.87D
1.6	AKL, APF, AEH	1.6	1999.04 - 2000.09		3141.87D
1.6 16V	AUS, BCB, AZD	1.6	2000.09 - 2006.05	mit Gehäuse	410989.87D
1.8	AJQ, AMK, ARY, BAM	1.8	2001.05 - 2005.10		3141.87D
1.8 20V	AGN, APG	1.8	1999.04 - 2006.05		3141.87D
1.8 20VT	APP, AUQ	1.8	2001.05 - 2006.05		3141.87D
1.9 SDI	AQM	1.9	1999.11 - 2004.06		4264.87D
1.9 TDI	AGR, ALH, AHF, ASV, ARL, ASZ, AXR	1.9	1999.04 - 2006.05		4264.87D
2.3 V5	AGZ	2.3	1999.05 - 2001.05	Chassis No. 1M-Y 000 001→	4123.80D
2.3 V5 20V	AQN	2.3	2001.05 - 2006.05		4123.80D
2.8	AUE, BDE	2.8	2000.10 - 2004.04		4123.80D

TOLEDO III

1.6	BGU, CCSA, BSF, BSE	1.6	2004.10 - 2009.05		3141.87D
1.9 TDI	BJB, BKC, BXE	1.9	2004.10 - 2009.05		4264.87D
1.9 TDI	BLS	1.9	2004.10 - 2009.05		4820.87D
2.0 FSI	BVY, BVZ	2.0	2004.10 - 2009.05		411186.87D
2.0 TDI	AZV	2.0	2004.09 - 2009.05		3472.87D
2.0 TDI	BMM	2.0	2005.11 - 2009.05		4820.87D
2.0 TDI	BMN	2.0	2006.01 - 2009.05		3472.87D
2.0 TDI 16V	BKD	2.0	2004.04 - 2009.05		3472.87D
2.0 TFSI	BWA	2.0	2005.11 - 2009.05		411187.87D

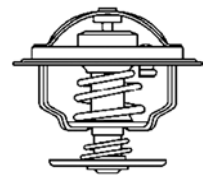
SKODA

	Motor Engine Moteur	Ltr. Ltr. Ltr.	Jahr Year Année	Einschränkung Restriction* Restriction*	Thermostat Thermostat Thermostat
100					
1.0	OHV	1.0	1970.01 - 1977.12		3029.83
105, 120					
1.0 105	742,10	1.0	1976.08 - 1990.12		3032.80
1.2 120	742.12	1.2	1976.08 - 1990.12		3032.80
110					
1.1	OHV	1.1	1969.12 - 1982.03		3029.83
130					
G, GL, L (S135, S136)	742,13, 135, 8	1.3	1985.02 - 1991.10		3032.80
FABIA (6Y2, 6Y3, 6Y5)					
1.4	BUD	1.4	2006.02 - 2006.10	mit Gehäuse	410475.87D
1.4 16V	BBY, BKY, AUA, BBZ, AUB, BUD	1.4	2006.04 - 2008.03	mit Gehäuse	410475.87D
1.4 TDI	AMF, BNM, BNV	1.4	2003.04 - 2008.03		4264.87D
1.9 SDI	ASY	1.9	1999.11 - 2008.03		4264.87D
1.9 TDI	AXR, ATD	1.9	2000.01 - 2008.03		4264.87D
1.9 TDI RS	BLT, ASZ	1.9	2003.06 - 2008.03		4264.87D
2.0	AZL	2.0	1999.12 - 2008.03		3141.87D
FABIA					
1.4	CGGB, BXW	1.4	2007.01 -	mit Gehäuse	410475.87D
1.4 TDI	BMS, BNV, BNM	1.4	2007.01 -		4264.87D
1.6 TDI	CAYA, CAYB, CAYC	1.6	2010.04 - 2010.05	mit Gehäuse	410536.92D
1.6 TDI	CAYA, CAYB, CAYC	1.6	2010.04 - 2010.05	ohne Gehäuse	410537.92D
1.6 TDI	CAYA, CAYB, CAYC	1.6	2010.06 -		410845.92D
1.9 TDI	BSW	1.9	2007.04 -		4264.87D
1.9 TDI	BLS	1.9	2007.04 -		4820.87D
FABIA Praktik					
1.4 TDI	BNM	1.4	2005.10 - 2007.12		4264.87D
1.9 SDI	ASY	1.9	2001.07 - 2007.12		4264.87D
FAVORIT					
1.3	135B, 136B	1.3	1991.09 - 1997.06	80° Variante	3032.80
1.3	135B, 136B	1.3	1991.09 - 1997.06	88° Variante	3032.88
1.3 (135 E)	781.135, 781.135 E	1.3	1989.05 - 1997.06	80° Variante	3032.80
1.3 (135), (135 E)	781.135, 781.135 E	1.3	1989.05 - 1997.06	88° Variante	3032.88
1.3 (136)	OHC, 136 B, 136 L	1.3	1990.10 - 1995.06		3032.80
FELICIA I					
1.3	135B, 135 L, 136B,	1.3	1994.10 - 1996.01		3032.88
1.6	AEE, EA111	1.6	1995.08 - 2002.04	mit Gehäuse	410989.87D
1.9 D	AEF	1.9	1995.10 - 2002.04		4253.87D
FELICIA II					
1.6	AEE	1.6	1996.09 - 2004.09	mit Gehäuse	410989.87D
1.9 D	AEF	1.9	1998.01 - 2001.06		4253.87D

SKODA
**Motor
Engine
Moteur**
**Ltr.
Ltr.
Ltr.**
**Jahr
Year
Année**
**Einschränkung
Restriction*
Restriction***
**Thermostat
Thermostat
Thermostat**
OCTAVIA (1U)

1.4 16V	AXP, BCA	1.4	2000.08 - 2010.12	mit Gehäuse	410989.87D
1.6	AEH, AKL	1.6	1997.02 - 2007.12		3141.87D
1.8	AGN	1.8	1996.09 - 2000.07		3141.87D
1.8 20V	AGN	1.8	1998.07 - 2000.07		3141.87D
1.8 T	ARX, ARZ, AGU, AUM	1.8	1997.08 - 2010.12		3141.87D
1.9 SDI	AQM, AGP	1.9	1997.06 - 2003.12		4264.87D
1.9 TDI	AGR, AHF, ALH, ASV, ASZ, ATD, AXR	1.9	1996.09 - 2010.12		4264.87D
2.0	APK, AZH, AZJ, AQY, AEG	2.0	1999.04 - 2007.05		3141.87D
RS 1.8 T	AUQ	1.8	2001.05 - 2006.01		3141.87D

OCTAVIA (1Z)

1.4	BCA, BUD, CGGA	1.4	2004.05 -	mit Gehäuse	410475.87D
1.6	AEH, AKL, BGU, BSF, BSE, CCSA, CMXA,	1.6	2004.06 -		3141.87D
1.6 LPG	CHGA	1.6	2009.08 -		3141.87D
1.6 MultiFuel	CCSA, CMXA	1.6	2008.01 -		3141.87D
1.6 TDI	CAYC	1.6	2009.06 - 2010.05	mit Gehäuse	410536.92D
1.6 TDI	CAYC	1.6	2009.06 - 2010.05	ohne Gehäuse	410537.92D
1.6 TDI	CAYC	1.6	2010.05 -		410845.92D
1.9 TDI	BJB, BKC, BXE	1.9	2004.06 - 2010.12		4264.87D
1.9 TDI	BLS	1.9	2004.06 - 2010.12		4820.87D
2.0 FSI	BVY, BVZ	2.0	2004.11 -		411186.87D
2.0 RS	BWA, CCZA	2.0	2005.10 -		411187.87D
2.0 TDI	AZV	2.0	2004.02 - 2010.05		3472.87D
2.0 TDI	BMM	2.0	2005.11 -		4820.87D
2.0 TDI	CLCA, CFHF	2.0	2010.03 -		410845.87D
2.0 TDI 16V	AZV, BKD	2.0	2004.02 -		3472.87D
2.0 TDI 16V	CFHC, CLCB	2.0	2004.02 -		410845.87D
2.0 TDI RS	CEGA	2.0	2006.04 - 2009.07		3472.87D
2.0 TDI RS	BMN	2.0	2006.04 -		3472.87D

PRAKTIK

1.4	CGGB, BXW	1.4	2007.03 -	mit Gehäuse	410475.87D
1.4 TDI	BMS, BNM, BNV	1.4	2007.03 - 2010.03		4264.87D

RAPID (120G, 130G, 135G)

1.2 (120G)		1.2	1983.02 - 1990.12		3032.80
1.3 (130G)		1.3	1985.03 - 1991.10		3032.80
1.3 S	135, 8	1.3	1984.09 - 1990.12		3032.80

ROOMSTER (5J)

1.4	CGGB, BXW	1.4	2006.09 -	mit Gehäuse	410475.87D
1.4 TDI	BMS, BNM, BNV	1.4	2006.07 - 2010.03		4264.87D
1.6 TDI	CAYB, CAYC	1.6	2010.03 -	mit Gehäuse	410536.92D
1.6 TDI	CAYB, CAYC	1.6	2010.03 -	ohne Gehäuse	410537.92D
1.6 TDI	CAYB, CAYC	1.6	2010.06 -		410845.92D
1.9 TDI	AXR, BSW	1.9	2006.03 - 2010.03		4264.87D
1.9 TDI	BLS	1.9	2006.09 - 2010.03		4820.87D

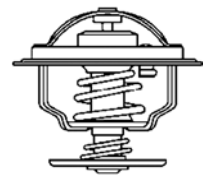

SKODA

	Motor Engine Moteur	Ltr. Ltr. Ltr.	Jahr Year Année	Einschränkung Restriction* Restriction*	Thermostat Thermostat Thermostat
SUPERB (3U4)					
1.8 T	AWT	1.8	2001.12 - 2008.03		3141.87D
1.9 TDI	AVB, AWX, AVF, BPZ, BSV	1.9	2001.12 - 2008.03		4264.87D
2.0	AZM	2.0	2001.12 - 2008.03		3141.87D
2.0 TDI	BSS	2.0	2005.10 - 2008.03		4264.87D
2.5 TDI	AYM, BDG	2.5	2001.12 - 2003.08		4274.87D
2.8 V6	AMX	2.8	2001.12 - 2008.03		4274.92D
SUPERB (3T4, 3T5)					
1.6 TDI	CAYC	1.6	2010.09 -		410845.92D
1.9 TDI	BXE	1.9	2008.03 -		4264.87D
1.9 TDI	BLS	1.9	2008.03 -		4820.87D
2.0 TDI	BMP	2.0	2008.03 -		4820.87D
2.0 TDI	CBBB	2.0	2008.07 - 2009.07		3472.87D
2.0 TDI	CFGB	2.0	2008.07 -		410845.87D
2.0 TDI 16V	BKD	2.0	2009.01 -		3472.87D
2.0 TDI 16V	CFFB, CLJA	2.0	2009.01 -		410845.87D
YETI					
1.6 TDI	CAYC	1.6	2010.11 -		410845.92D
2.0 TDI	CFHA, CFHC, CFHF, CFJA, CLCA, CLCB	2.0	2009.05 -		410845.87D

SMART (MCC)

 Motor
Engine
Moteur

 Ltr.
Ltr.
Ltr.

 Jahr
Year
Année

 Einschränkung
Restriction*
Restriction*

 Thermostat
Thermostat
Thermostat

CABRIO (450)

0.6	M 160 E6AL B03, M 160 E6AL B05, M 160.920	0.6	2000.03 - 2004.01		3142.90D
0.7	M 160.910	0.7	2003.01 - 2004.01		3142.90D
0.8 CDI	OM 660 DE 8LA, OM 660.940	0.8	2001.03 - 2004.01		3146.90D

CITY-COUPE (450)

0.8 CDI	OM 660 DE 8LA, OM 660.940	0.8	2001.03 - 2004.01		3146.90D
0.6	M 160 E6AL B03, M 160 E6AL B04, M 160 E6AL B05, M 160.920	0.6	1998.07 - 2004.01		3142.90D
0.7	M 160.910	0.7	2003.01 - 2004.01		3142.90D

CROSSBLADE (450)

0.6	M 160.920	0.6	2002.06 - 2003.12		3142.90D
-----	-----------	-----	-------------------	--	-----------------

FORTWO (450)

0.7	M 160.910	0.7	2004.01 - 2007.01		3142.90D
0.8 CDI	OM 660 DE 8LA, OM 660.940, OM 660.950	0.8	1999.11 - 2007.01		3146.90D

ROADSTER (452)

0.7	M 160.921, M 160.922	0.7	2003.04 - 2005.11		3142.90D
0.7 Brabus	M 160.923	0.7	2003.12 - 2005.11		3142.90D

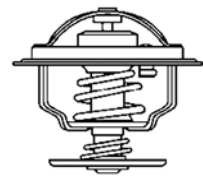

SSANGYONG

	Motor Engine Moteur	Ltr. Ltr. Ltr.	Jahr Year Année	Einschränkung Restriction* Restriction*	Thermostat Thermostat Thermostat
KORANDO (KJ)					
2.3 D	OM 601.940	2.3	1996.12 -	ohne Gehäuse	4176.85D
2.3 D	OM 601.940	2.3	1996.12 -	mit Gehäuse	4280.85D
2.9 D	MB-OM 662	2.9	1996.12 -	ohne Gehäuse	4176.85D
2.9 D	MB-OM 662	2.9	1996.12 -	mit Gehäuse	4280.85D
2.9 TD		2.9	1998.04 -	ohne Gehäuse	4176.85D
2.9 TD		2.9	1998.04 -	mit Gehäuse	4280.85D
3.2	M 104.995	3.2	1996.12 -		4078.87D
KORANDO Cabrio (KJ)					
2.9 D	MB-OM 662	2.9	1997.11 -	ohne Gehäuse	4176.85D
2.9 D	MB-OM 662	2.9	1997.11 -	mit Gehäuse	4280.85D
2.9 TD		2.9	1998.04 -	ohne Gehäuse	4176.85D
2.9 TD		2.9	1998.04 -	mit Gehäuse	4280.85D
MUSSO (FJ)					
2.3	M 111.970	2.3	1996.10 -		4276.87D
2.3 D	OM 601.940	2.3	1995.10 -	ohne Gehäuse	4176.85D
2.3 D	OM 601.940	2.3	1995.10 -	mit Gehäuse	4280.85D
2.9 D	MB-OM 662	2.9	1996.03 -	ohne Gehäuse	4176.85D
2.9 D	MB-OM 662	2.9	1996.03 -	mit Gehäuse	4280.85D
2.9 TD		2.9	1998.04 -	ohne Gehäuse	4176.85D
2.9 TD		2.9	1998.04 -	mit Gehäuse	4280.85D
3.2	M 104.992	3.2	1996.06 -		4078.87D
MUSSO SPORTS					
2.9 D		2.9	2004.08 -	ohne Gehäuse	4176.85D
2.9 D		2.9	2004.08 -	mit Gehäuse	4280.85D
REXTON					
2.9 TD		2.9	2002.04 -	ohne Gehäuse	4176.85D
2.9 TD		2.9	2002.04 -	mit Gehäuse	4280.85D

SUBARU
**Motor
Engine
Moteur**
**Ltr.
Ltr.
Ltr.**
**Jahr
Year
Année**
**Einschränkung
Restriction*
Restriction***
**Thermostat
Thermostat
Thermostat**
FORESTER (SF, SG)

2.0	EJ20	2.0	1997.08 - 2002.09		410230.78D
2.0	EJ204	2.0	2005.09 -		410230.78D
2.0 S Turbo	EJ20	2.0	1998.06 - 2001.04		410230.78D
2.0 S Turbo	EJ205	2.0	2001.04 - 2002.09		410230.78D
2.5	EJ25D	2.5	1997.07 - 2002.05		410230.78D
2.5	EJ25	2.5	2002.11 - 2005.08		410230.78D
2.5	EJ255	2.5	2005.01 -		410230.78D
2.5 Turbo		2.5	1998.09 - 2002.05		410230.78D

FORESTER (SH, SJ)

2.0	EJ20, EJ204	2.0	2008.01 -		411716.88D ▲
2.0	FB 20	2.0	2010.01 -		411716.88D ▲
2.0 D		2.0	2008.09 -		411715.84D ▲
2.5	EJ255	2.5	2008.06 -	78° Variante	410230.78D
2.5	EJ255	2.5	2008.06 -	84° Variante	411715.84D ▲
2.5	EJ25	2.5	2009.01 -	78° Variante	410230.78D
2.5	EJ25	2.5	2009.01 -	84° Variante	411715.84D ▲

IMPREZA (GC, GF, GFC)

1.5		1.5	1994.11 - 2000.09		410230.78D
1.6	EJ161, EJ16E	1.6	1993.01 - 2000.12		410230.78D
1.6 i	EJ161, EJ16E	1.6	1992.08 - 2000.12		410230.78D
1.8	EJ18	1.8	1993.01 - 1995.10		410230.78D
1.8 i	EJ18, EJ18E	1.8	1992.08 - 2000.12		410230.78D
2.0	EJ20, EJ20E, EJ201, EJ205P	2.0	1995.12 - 2000.12		410230.78D
2.0 i	EJ20, EJ20E, EJ201	2.0	1995.10 - 2000.12		410230.78D
2.0 i 16V	EJ20	2.0	1998.06 - 2000.12		410230.78D
2.0 i Turbo	EJ20 (Turbo)	2.0	1994.03 - 2000.12		410230.78D
2.0 Turbo	EJ20G	2.0	1992.10 - 2000.12		410230.78D
2.0 Turbo GT	EJ20 (Turbo), EJ205	2.0	1994.03 - 2000.12		410230.78D
2.2	EJ22, EJ22E	2.2	1995.11 - 2000.09		410230.78D
2.2 i	EJ22E	2.2	1998.09 - 2000.09		410230.78D

IMPREZA (GD, GG)

1.5	EL15	1.5	2001.06 - 2005.08		410230.78D
1.6	EJ16, EJ161	1.6	2000.12 - 2006.09		410230.78D
2.0	EJ20	2.0	2000.12 -		410230.78D
2.0	EJ205P	2.0	2005.10 -		410230.78D
2.0 i	EJ20, EJ201, EJ204, EJ205	2.0	2000.12 - 2007.12		410230.78D
2.0 i R	EJ20, EJ204	2.0	2005.09 -		410230.78D
2.0 Turbo	EJ205	2.0	2000.12 -		410230.78D
2.0 WRX STi	EJ207	2.0	2001.11 - 2005.09		410230.78D
2.0 WRX STi	EJ208	2.0	2005.10 -		410230.78D
2.0 WRX Turbo	EJ205	2.0	2000.12 -		410230.78D
2.2	EJ22E	2.2	2001.06 - 2005.08		410230.78D
2.5	EJ25, EJ251	2.5	2001.03 - 2005.09		410230.78D
2.5	EJ255, EJ257	2.5	2005.09 -		410230.78D
2.5 i	EJ251	2.5	2002.12 - 2005.09		410230.78D
2.5 i	EJ255	2.5	2005.09 -		410230.78D
2.5 STi	EJ257	2.5	2005.09 -		410230.78D



SUBARU

	Motor Engine Moteur	Ltr. Ltr. Ltr.	Jahr Year Année	Einschränkung Restriction* Restriction*	Thermostat Thermostat Thermostat
IMPREZA (GR, GH, G3)					
1.5	EL15	1.5	2008.02 -		411716.88D ▲
2.0	EJ204	2.0	2007.12 -		411716.88D ▲
2.0 D		2.0	2009.01 -		411715.84D ▲
2.0 i	EJ204	2.0	2008.01 -		411716.88D ▲
2.5	EJ255	2.5	2008.01 -		410230.78D
2.5	EJ257	2.5	2008.01 -	78° Variante	410230.78D
2.5	EJ257	2.5	2008.01 -	84° Variante	411715.84D ▲
2.5 STi	EJ257	2.5	2011.01 -		410230.78D
2.5 STi CS400	EJ257	2.5	2010.04 -		410230.78D
JUSTY I (KAD)					
1000	EF10	1.0	1984.11 - 1995.10		410183.82D
1200	EF12	1.2	1986.10 - 1995.10		410183.82D
JUSTY II (JMA, MS)					
1.3	EF13	1.3	1995.10 - 2003.11		410229.82D
1.3	G13BB	1.3	2001.04 - 2003.11		410229.82D
JUSTY III (G3X)					
1.3	M13A	1.3	2003.09 -		410229.82D
1.5	M15A	1.5	2003.09 -		410229.82D
LEGACY I (BC, BJF)					
1800	EJ18 SPI	1.8	1989.01 - 1994.07		410230.78D
2.0	EJ20E	2.0	1991.08 - 1993.12		410230.78D
2000	EJ20 EMPI	2.0	1991.08 - 1994.07		410230.78D
2000 Turbo	EJ20-GN	2.0	1992.05 - 1994.07		410230.78D
2200	EJ22 EMPI	2.2	1989.01 - 1994.07		410230.78D
LEGACY II (BD, BG)					
1.8	EJ18E	1.8	1996.05 - 1998.09		410230.78D
2.0 i	EJ20, EJ20 EMPI, EJ20E	2.0	1994.09 - 1999.03		410230.78D
2.2	EJ22	2.2	1994.07 - 1998.11		410230.78D
2.2 i	EJ22 EMPI	2.2	1994.02 - 1999.03		410230.78D
2.5	EJ25D	2.5	1996.01 - 1999.12		410230.78D
2.5 i	EJ25D	2.5	1996.06 - 1999.03		410230.78D
LEGACY III (BE, BH)					
2.0	EJ20, EJ205P, EJ206	2.0	1998.12 - 2003.08		410230.78D
2.5	EJ25	2.5	1998.10 - 2003.08		410230.78D
3.0 H6	EZ30	3.0	2000.08 - 2003.08		410230.78D
LEGACY IV					
2.0	EJ20	2.0	2003.09 -		410230.78D
2.0 D		2.0	2008.02 -		411715.84D ▲
2.0 R	EJ204	2.0	2007.09 -		411716.88D ▲
2.5	EJ25	2.5	2003.09 -		411743.82D ▲
2.5 i	EJ25	2.5	2007.09 -		411743.82D ▲
3.0 R	EZ30	3.0	2003.09 -		411743.82D ▲

SUBARU

 Motor
Engine
Moteur

 Ltr.
Ltr.
Ltr.

 Jahr
Year
Année

 Einschränkung
Restriction*
Restriction*

 Thermostat
Thermostat
Thermostat

LEGACY V

2.0 D		2.0	2009.09 -		411715.84D ▲
2.0 i	EJ204	2.0	2009.09 -		411716.88D ▲
2.5 GT	EJ255	2.5	2010.07 -		411715.84D ▲
2.5 i	EJ253	2.5	2009.09 -		411716.88D ▲

LEONE I

1300	EA65	1.3	1979.03 - 1984.10		3118.82D1
1600	EA71	1.6	1979.03 - 1984.10		3118.82D1
1800	EA81	1.8	1980.09 - 1984.10		3118.82D1

LEONE II

1.6	EA71	1.6	1985.06 - 1990.07		3118.82D1
1.8	EA81, EA82	1.8	1985.06 - 1989.07		3118.82D1
1.8 Turbo	EA82	1.8	1985.06 - 1986.07		3118.82D1
1300	EA65	1.3	1984.11 - 1991.09		3118.82D1
1600	EA71	1.6	1984.11 - 1994.12		3118.82D1
1800	EA82	1.8	1984.11 - 1992.02		3118.82D1
1800 Turbo	EA82	1.8	1984.11 - 1990.12		3118.82D1

LIBERO Bus (E10, E12)

1.0	EF10	1.0	1983.01 - 1987.12		410183.82D
1.2	EF12	1.2	1986.08 - 2000.02		410183.82D
1.2 i	EF12	1.2	1991.08 - 2000.02		410183.82D

OUTBACK (BE, BH)

2.5	EJ25	2.5	2000.10 - 2003.08		410230.78D
3.0 H6	EZ30	3.0	2000.10 - 2003.08		410230.78D

OUTBACK (BL, BP)

2.0	EJ20	2.0	2003.09 - 2005.10		410230.78D
2.0 D		2.0	2008.09 - 2009.09		411715.84D ▲
2.5	EJ25D	2.5	2003.11 - 2009.09		411743.82D ▲
2.5	EJ251	2.5	2008.09 - 2009.09		411743.82D ▲
3.0	EZ30	3.0	2003.11 - 2009.09		411743.82D ▲

OUTBACK (BM, BR)

2.0 D		2.0	2009.09 -		411715.84D ▲
2.5 i	EJ253	2.5	2009.09 -		411716.88D ▲
3.6	EZ36D	3.6	2009.09 -		411743.82D ▲

REX III

0.7	EN07E	0.7	1990.07 - 1992.03		410183.82D
-----	-------	-----	-------------------	--	------------

SVX (CX)

3.3		3.3	1994.02 - 1997.12		410230.78D
3.3 i 24V	EG33 DOHC	3.3	1992.09 - 1997.12		410230.78D

TRIBECA (B9)

3.0	EZ30	3.0	2005.01 -		411743.82D ▲
3.6	EZ36D	3.6	2007.09 -		411743.82D ▲

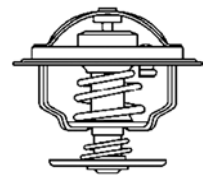
**SUBARU**

	Motor Engine Moteur	Ltr. Ltr. Ltr.	Jahr Year Année	Einschränkung Restriction* Restriction*	Thermostat Thermostat Thermostat
VIVIO					
660	EN07E	0.7	1992.03 - 1995.10		410183.82D
0.7	EN07E	0.7	1992.08 - 1998.12		410183.82D
XT Coupe (XT)					
1.8 Turbo	EA82	1.8	1985.11 - 1990.07		3118.82D1
XV					
2.0 D		2.0	2012.03 -		411715.84D ▲

SUZUKI
**Motor
Engine
Moteur**
**Ltr.
Ltr.
Ltr.**
**Jahr
Year
Année**
**Einschränkung
Restriction*
Restriction***
**Thermostat
Thermostat
Thermostat**
ALTO I (SS80)

0.8 F8A, F8B 0.8 1982.06 - 1985.12 410183.82D

ALTO II (EC)

0.8 F8B 0.8 1986.01 - 1993.11 410183.82D

ALTO III (EF)

1.0 G10BB 1.0 1994.09 - 2002.06 410183.82D

1.3 G13BB 1.3 1998.10 - 2000.09 410183.82D

ALTO IV (FF)

1.1 F10DN, F10D 1.1 2002.06 - 2008.12 410183.88D

APV (GD)

1.5 G15A 1.5 2005.06 - 410183.82D

BALENO (EG)

1.3 G13BA 1.3 1996.09 - 2002.05 410183.88D

1.3 16V G13BB 1.3 1997.03 - 2002.05 410183.88D

1.3 i 16V G13BB 1.3 1995.07 - 2002.05 410183.88D

1.6 i 16V G16B 1.6 1995.07 - 2002.05 410183.88D

1.8 GTX J18A 1.8 1996.03 - 2002.05 410229.82D

1.8 i J18A 1.8 1996.03 - 2002.05 410229.82D

1.8 i 16V J18A 1.8 1996.08 - 2002.05 410229.82D

1.9 TD 1.9 1998.04 - 2002.05 4446.83D

CAPPUCINO (EA)

0.7 F6A 0.7 1992.02 - 1995.08 410183.82D

CARRY Kasten (FD)

1.3 G13BB 1.3 1999.03 - 410183.82D

1.3 16V G13BB 1.3 2000.03 - 410183.88D

CARRY Kasten (ST90V)

0.8 F8A 0.8 1980.11 - 1985.10 3119.82

GRAND VITARA I (FT, GT)

1.6 G16B 1.6 1998.03 - 2003.07 410183.88D

1.6 G16B 1.6 2000.02 - 2002.09 410228.82D

2.0 J20A 2.0 1998.03 - 2005.08 410229.82D

2.0 HDI 110 RHZ 2.0 2001.07 - 2005.09 4446.83D

2.0 HDI 110 16V RHW 2.0 2001.07 - 2005.09 4446.83D

2.0 TD RF 2.0 1998.03 - 2003.07 3468.88D

2.0 TD RFM 2.0 2000.04 - 2005.09 4446.83D

2.5 V6 24V H 25 A 2.5 1998.04 - 2003.07 4639.82D

2.7 H 27 A 2.7 2001.06 - 2006.08 4639.82D

GRAND VITARA II (JT)

1.6 M16A 1.6 2005.04 - 410229.82D

1.9 DDiS F9QB 1.9 2005.10 - 410538.89D

2.0 J20A 2.0 2005.10 - 410229.82D

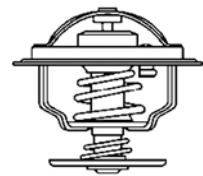

SUZUKI

	Motor Engine Moteur	Ltr. Ltr. Ltr.	Jahr Year Année	Einschränkung Restriction* Restriction*	Thermostat Thermostat Thermostat
2.4	J24B	2.4	2009.01 -		410229.82D
2.7	H 27 A	2.7	2005.09 - 2006.12		4639.82D
IGNIS (FH)					
1.3	M13A	1.3	2000.10 - 2003.09		410229.82D
1.3 DDiS	Z13DT	1.3	2003.09 -		410588.88D
1.5	M15A	1.5	2003.09 -		410229.82D
JIMNY (FJ)					
1.3 16V	G13BB	1.3	1998.09 - 2000.08		410183.88D
1.3 16V	M13A	1.3	2001.02 -		410229.82D
1.5 DDiS	K9K 266	1.5	2005.08 - 2007.06		411043.89D
1.5 DDiS	K9K 266	1.5	2007.07 -		411477.89D ▲
KEI					
1.3	G13BA	1.3	1998.09 -		410183.88D
KIZASHI (FR)					
2.4	J24B	2.4	2010.10 -		410229.82D
LIANA (ER)					
1.3	M13A	1.3	2001.07 - 2007.12		410229.82D
1.5	M15A	1.5	2004.04 - 2007.11		410229.82D
1.6	M16A	1.6	2001.07 - 2007.12		410229.82D
1.6 i	M16A	1.6	2002.04 - 2007.12		410229.82D
2.3		2.3	2004.04 - 2007.11		410229.82D
LJ 80					
0.8	F8A	0.8	1980.01 - 1984.01		410228.82D
SAMURAI (SJ)					
1.0	F10A	1.0	1988.11 - 2004.12		410228.82D
1.3	G13A	1.3	1988.11 - 2004.12		3119.82
1.3	G13BA	1.3	2000.01 - 2004.12		410183.88D
1.9 D		1.9	2000.09 - 2004.12		410517.89D
1.9 TD	XUD9	1.9	1998.11 - 2004.12		4446.83D
SJ 410					
1.0	F10A	1.0	1981.09 - 1988.12		3119.82
SJ 413					
1.3	G13A	1.3	1984.09 - 1990.08		3119.82
SPLASH					
1.3 CDTI	D13A, Z 13 DTJ	1.3	2008.01 -		410588.88D
SUPER CARRY Bus (ED)					
1.0	F10A	1.0	1985.10 - 1999.03		3119.82

SUZUKI
**Motor
Engine
Moteur**
**Ltr.
Ltr.
Ltr.**
**Jahr
Year
Année**
**Einschränkung
Restriction*
Restriction***
**Thermostat
Thermostat
Thermostat**
SWIFT I

1.0	G10A, G10	1.0	1983.10 - 1989.03		410183.82D
1.0 Turbo	G10T	1.0	1985.02 - 1989.12		410183.82D
1.3	G13A	1.3	1984.10 - 1989.03		410183.82D
1.3 GTi / GXi	G13B	1.3	1985.08 - 1989.03		410183.82D

SWIFT II

1.0	G10A	1.0	1989.03 - 2001.05		410183.82D
1.0 i	G10A	1.0	1989.03 - 2001.05		410183.82D
1.3	G13A, G13BA, G13BB	1.3	1989.03 - 2003.12		410183.88D
1.3 GTi	G13B	1.3	1989.03 - 2001.05		410183.82D
1.6	G16B	1.6	1989.03 - 1996.10		410183.82D
1.6 i	G16B	1.6	1990.01 - 2001.05		410183.82D

SWIFT III

1.3	M13A	1.3	2005.02 -		410229.82D
1.3 DDiS	D 13A, Z 13 DT, Z 13 DTJ	1.3	2005.08 -		410588.88D
1.5	M15A	1.5	2005.02 -		410229.82D
1.6	M16A	1.6	2006.05 -		410229.82D

SWIFT IV (FZ, NZ)

1.3 DDiS	D13A	1.3	2010.10 -		410588.88D
1.6	M16A	1.6	2012.01 -		410229.82D

SWIFT Cabriolet (SF413)

1.3 i	G13BA	1.3	1991.09 - 1996.10		410183.82D
-------	-------	-----	-------------------	--	------------

SX4 (GY)

1.5	M15A	1.5	2006.06 -		410229.82D
1.5 VVT	M15A	1.5	2010.07 -		410229.82D
1.6	M16A	1.6	2007.10 -		410229.82D
1.6 VVT	M16A	1.6	2006.06 -		410229.82D
1.9 DDiS	D19AA	1.9	2006.06 -		410049.88D
2.0	J20A	2.0	2006.06 -		410229.82D

SX4 S-Cross

1.6		1.6	2013.08 -		410229.82D
-----	--	-----	-----------	--	------------

VITARA (ET, TA)

1.6	G16A (8V)	1.6	1988.07 - 1998.03		410228.82D
1.6 i 16V	G16B	1.6	1990.07 - 1999.03		410183.88D
1.9 D	XUD9A, XUD9SD	1.9	1995.01 - 1998.03		4446.83D
2.0 16V	J20A	2.0	1996.12 - 1999.03		410229.82D
2.0 HDI	RHP (DW10TD)	2.0	2003.12 - 2005.12		4446.83D
2.0 TD	RF	2.0	1994.12 - 1998.03		3468.88D
2.0 TD Intercooler	RF	2.0	1995.12 - 1998.03		3468.88D
2.0 V6 24V	H 20 A	2.0	1994.12 - 1998.03		4639.82D
2.5 V6 24V	H 25 A	2.5	1995.12 - 1998.03		4639.82D
HDI	RHP (DW10TD)	2.0	2003.12 - 2005.12		4446.83D

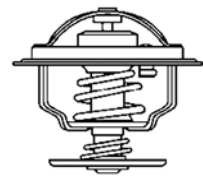

SUZUKI

	Motor Engine Moteur	Ltr. Ltr. Ltr.	Jahr Year Année	Einschränkung Restriction* Restriction*	Thermostat Thermostat Thermostat
WAGON					
1.0	K10A	1.0	1998.02 - 2000.05		410183.82D
1.0	G10A	1.0	2003.07 - 2005.08	Fahrgestellnummer →685G062128	410183.88D
1.0	Z 10 XEP	1.0	2004.06 - 2005.08		410183.82D
1.2	K12A	1.2	1998.02 - 2000.05		410183.82D
1.2	Z 12 XEP	1.2	2004.06 - 2005.08		410183.82D
1.3	G13BB	1.3	2000.05 -		410183.88D
1.3	M13A	1.3	2001.08 -		410229.82D
1.3 DDiS	Z13DT	1.3	2003.09 -		410588.88D
X-90 (EL)					
1.6 i 16V	G16B	1.6	1995.09 - 1997.12		410228.82D

TALBOT

 Motor
Engine
Moteur

 Ltr.
Ltr.
Ltr.

 Jahr
Year
Année

 Einschränkung
Restriction*
Restriction*

 Thermostat
Thermostat
Thermostat

1307-1510

1510 1.6	6J2A	1.6	1981.07 - 1982.06		4026.89
----------	------	-----	-------------------	--	----------------

EXPRESS

1.8	XM7T	1.8	1981.07 - 1990.10	82° Variante	3061.82
1.8	XM7T	1.8	1981.07 - 1990.10	88° Variante	3061.88
1.9 D	XUD9A	1.9	1987.07 - 1990.10		4147.80D
2.0	XN1TA	2.0	1982.07 - 1994.10	82° Variante	3061.82
2.0	XN1TA	2.0	1982.07 - 1994.10	88° Variante	3061.88
2.5 D	CRD93	2.5	1982.07 - 1994.10		3033.84D ▲
2.5 TD	CRD93LS	2.5	1987.06 - 1994.10		3033.84D ▲

HORIZON

1.1	E1B	1.1	1979.01 - 1984.09		4026.89
1.3	2G1-BTC	1.3	1978.09 - 1986.06		4026.89
1.4	2Y1, 2Y2	1.4	1979.07 - 1986.06		4026.89
1.6	6J2A, J2A	1.6	1982.07 - 1986.06		4026.89
1.9 Diesel	XUD9	1.9	1982.07 - 1986.06		4147.80D

MURENA

2.1	5N2	2.1	1980.09 - 1984.07		4026.89
2.1 S	X5N2	2.1	1983.04 - 1985.01		4026.89

SAMBA (51A)

0.9	5C1(XV8), 5C1(XV5)	0.9	1981.01 - 1985.12		3136.82D50
1.1	XW7	1.1	1981.01 - 1986.06		3136.82D50
1.2 Rallye	129 D	1.2	1983.01 - 1986.10		3136.82D50
1.4	XY8, XY7	1.4	1981.01 - 1986.06		3136.82D50
1.4	150 D	1.4	1983.06 - 1986.10		3136.82D50
1.4 Rallye	XY8	1.4	1983.01 - 1986.10		3136.82D50

SAMBA Cabriolet (51E)

1.4	XY8	1.4	1981.01 - 1986.06		3136.82D50
-----	-----	-----	-------------------	--	-------------------

TAGORA

2.1	5N2	2.1	1980.06 - 1983.12		4026.89
2.3 Turbo Diesel	XD2S	2.3	1981.08 - 1987.12		3053.75
2.6	9L6	2.6	1981.08 - 1983.10		4122.87D



TOYOTA

	Motor Engine Moteur	Ltr. Ltr. Ltr.	Jahr Year Année	Einschränkung Restriction* Restriction*	Thermostat Thermostat Thermostat
4 RUNNER					
2.4 TD	2L-T	2.4	1989.08 - 1995.11		3477.88D
2.7 i	3RZ-FE	2.7	1995.11 - 1996.03		410178.82D
3.0 Turbo-D	1KZ-T	3.0	1993.10 - 2002.11		410181.82D
3.4 i	5VZ-FE	3.4	1995.11 - 1996.03		4480.82D
ALPHARD					
2.4	2AZ-FE	2.4	2003.09 - 2008.04		4480.82D
2.4 Hybrid	2AZ-FXE	2.4	2003.09 - 2008.04		4480.82D
3.0	1MZ-FE	3.0	2003.04 - 2008.04		4480.82D
3.5	2GR-FE	3.5	2008.04 -		4480.82D
ALTEZZA					
2.0	1G-GE	2.0	1999.01 - 2001.06		411545.82D ▲
2.0 VVTi	1G-FE	2.0	2001.07 - 2005.07		411545.82D ▲
3.0	2JZ-GE	3.0	2001.07 - 2005.07		410231.82D
ARISTO					
3.0	2JZ-GTE	3.0	1990.10 - 2004.09		410231.82D
AURION					
3.5	2GR-FE	3.5	2006.03 - 2011.09		4480.82D
AURIS					
1.4 D-4D	1ND-TV	1.4	2007.03 - 2013.04		410231.82D
1.4 VVTi	4ZZ-FE	1.4	2007.03 -		4480.82D
1.6	1ZR-FAE	1.6	2009.05 -		4480.82D
1.6 VVTi	1ZR-FE	1.6	2007.03 -		4480.82D
1.8	2ZR-FAE	1.8	2009.02 -		4480.82D
1.8 VVTi	2ZR-FE	1.8	2006.10 -		4480.82D
2.0 D-4D	1AD-FTV	2.0	2007.03 -		4480.82D
2.2 D	2AD-FHV	2.2	2007.03 -		4480.82D
2.4 VVTi	2AZ-FE	2.4	2007.04 -		4480.82D
3.5 VVTi	2GR-FE	3.5	2007.04 -		4480.82D
AVALON					
3.0	1MZ-FE	3.0	2000.04 - 2005.06		4480.82D
AVANZA					
1.3	K3-VE	1.3	2003.12 -		410201.80D
1.5	3SZ-VE	1.5	2006.08 -		410201.80D
AVENSIS					
1.6	4A-FE	1.6	1997.09 - 2000.10		3478.82D
1.6	1ZR-FAE	1.6	2009.02 -		4480.82D
1.6 VVT-i	3ZZ-FE	1.6	2000.10 - 2008.11		4480.82D
1.8	7A-FE	1.8	1997.09 - 2000.10		3478.82D
1.8	1ZZ-FE	1.8	2003.04 - 2008.11		4480.82D
1.8	2ZR-FAE	1.8	2009.02 -		4480.82D
1.8 VVT-i	1ZZ-FE	1.8	2000.10 - 2003.02		4480.82D
1.9 D	2C-T	1.9	1997.10 - 1998.05		3478.82D
1.9 D	1CD-FTV	1.9	2002.09 - 2003.02		410231.82D

TOYOTA
**Motor
Engine
Moteur**
**Ltr.
Ltr.
Ltr.**
**Jahr
Year
Année**
**Einschränkung
Restriction*
Restriction***
**Thermostat
Thermostat
Thermostat**

2.0	3S-FE	2.0	1997.09 - 2000.10		3478.82D
2.0	1AZ-FSE	2.0	2003.04 - 2008.11		4480.82D
2.0	3ZR-FAE	2.0	2009.02 -		4480.82D
2.0 D	2C-T	2.0	1997.10 - 1998.05		3478.82D
2.0 D	1CD-FTV	2.0	2002.09 - 2003.02		410231.82D
2.0 D-4D	1CD-FTV	2.0	1999.10 - 2008.11		410231.82D
2.0 D-4D	1AD-FTV	2.0	2006.03 - 2008.11		410231.82D
2.0 D-4D	1AD-FTV	2.0	2009.02 -		4480.82D
2.0 TD	2C-TE	2.0	1997.09 - 2003.02		3478.82D
2.0 VVTi	1AZ-FE	2.0	2001.08 - 2009.11		4480.82D
2.0 VVT-i	1AZ-FSE	2.0	2000.10 - 2003.02		4480.82D
2.2 D-4D	2AD-FTV	2.2	2005.10 - 2008.11		4480.82D
2.2 D-4D	2AD-FHV, 2AD-FTV	2.2	2009.02 -		4480.82D
2.2 D-CAT	2AD-FHV	2.2	2005.07 - 2008.11		4480.82D
2.4	2AZ-FSE	2.4	2003.09 - 2008.11		4480.82D
2.4 VVTi	2AZ-FE	2.4	2003.10 - 2009.11		4480.82D

CALDINA

1.8	7A-FE	1.8	1997.10 - 2001.09		3478.82D
-----	-------	-----	-------------------	--	----------

CAMI

1.3	K3-VE, K3-VET	1.3	1999.06 - 2005.12		410201.80D
-----	---------------	-----	-------------------	--	------------

CAMRY (_V1_) 1983→1988

1.8	1S-L	1.8	1983.02 - 1986.10		4103.82D
1.8 Turbo-D	1C-TL	1.8	1983.11 - 1988.01		4103.82D
2.0	2S-E, 2S-EL, 2S-ELC, 3S-FE	2.0	1983.01 - 1988.07		4103.82D

CAMRY (_V1_) 1991→1996

2.0	3S-FSE	2.0	1993.08 - 1997.09		4103.82D
2.2	5S-FE	2.2	1991.06 - 1996.08		3478.82D
2000ZX	3S-FE	2.0	1991.06 - 1997.09		4103.82D
3.0	1MZ-FE, 3VZ-FE	3.0	1991.06 - 1996.08		4480.82D

CAMRY (_V2_) 1986→1991

1.8	1S	1.8	1986.11 - 1988.08		4103.82D
1.8 i	1S-L	1.8	1986.10 - 1988.08		4103.82D
2.0	3S-FE	2.0	1989.09 - 1991.06		3478.82D
2.0	3S-FC	2.0	1989.09 - 1991.06		3478.82D
2.0 GLi	3S-FE	2.0	1987.10 - 1991.05		4103.82D
2.0 Gli 16V	3S-FE	2.0	1986.11 - 1991.05		4103.82D
2.0 Turbo-D	2C-T	2.0	1986.11 - 1991.05		4103.82D
2.5	2VZ-FE	2.5	1990.01 - 1991.05		4480.82D

CAMRY (_V2_) 1996→2001

2.2	5S-FE	2.2	1996.08 - 2001.11		3478.82D
3.0 24V	1MZ-FE	3.0	1996.08 - 2001.11		4480.82D
3.0 V6	1MZ-FE	3.0	1996.08 - 2001.11		4480.82D

CAMRY (_V3_) 2001→

2.0 VVTi	1AZ-FE	2.0	2001.08 - 2006.11		4480.82D
2.4 VVT-i	2AZ-FE	2.4	2001.11 - 2006.11		4480.82D
3.0	1MZ-FE	3.0	2002.09 - 2006.06		4480.82D
3.0 V6	1MZ-FE	3.0	2001.11 - 2006.11		4480.82D

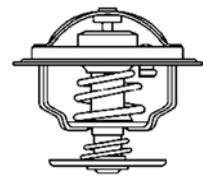

TOYOTA

	Motor Engine Moteur	Ltr. Ltr. Ltr.	Jahr Year Année	Einschränkung Restriction* Restriction*	Thermostat Thermostat Thermostat
3.3 VVTi	3MZ-FE	3.3	2002.08 - 2005.12		4480.82D
3.5 VVTi	2GR-FE	3.5	2006.01 - 2006.11		4480.82D
CAMRY SOLARA (_V2_, _V3_)					
2.2	5S-FE	2.2	1998.06 - 2002.11		3478.82D
2.4	2AZ-FE	2.4	2003.07 - 2008.11		4480.82D
3.0	1MZ-FE	3.0	1998.06 - 2008.11		4480.82D
3.3	3MZ-FE	3.3	2003.07 - 2008.11		4480.82D
CAMRY (_V4_)					
2.0 VVT-i	1AZ-FE	2.0	2006.01 - 2011.09		4480.82D
2.4 VVTi	2AZ-FE, 2AZ-FXE	2.4	2006.01 - 2011.09		4480.82D
2.5 VVTi	2AR-FE	2.5	2010.01 - 2011.09		4480.82D
3.5	2GR-FE	3.5	2008.01 - 2011.09		4480.82D
CARINA (TA4, TA6) 1978→1983					
1.6	2T	1.6	1978.01 - 1983.09		3119.82D5
1.8	3T, 3T-C	1.8	1978.01 - 1983.09		3119.82D5
1.8 D	1C	1.8	1982.04 - 1983.09		4103.82D
CARINA II (_T15_) 1983→1988					
1.6	4A-L, 4A-LC	1.6	1983.10 - 1987.11		4103.82D
1.8 GLI	1S-EL, 1S-L	1.8	1983.10 - 1987.11		4103.82D
2.0 D	2C-L	2.0	1984.02 - 1988.05		4103.82D
CARINA II (_T17_) 1988→1993					
1.6	4A-F, 4A-FE	1.6	1987.12 - 1992.03		4103.82D
1.8	4S-FI	1.8	1987.12 - 1992.03		4103.82D
2.0	3S-FE	2.0	1987.12 - 1992.04		4103.82D
2.0 D	2C, 2C-L	2.0	1988.03 - 1992.06		4103.82D
CARINA E (_T19_) 1992→1997					
1.6	4A-FE	1.6	1992.04 - 1997.09		3478.82D
1.6 16V	4A-FE	1.6	1994.12 - 1997.09		3478.82D
1.6 i	4A-FE	1.6	1995.02 - 1997.09		3478.82D
1.8	7A-FE	1.8	1992.04 - 1997.09		3478.82D
1.8 i	7A-FE	1.8	1995.02 - 1997.09		3478.82D
1.8 i 16V	7A-FE	1.8	1995.01 - 1997.09		3478.82D
2.0	3S-FE	2.0	1992.04 - 1997.09		3478.82D
2.0 D	2C	2.0	1992.04 - 1996.01		3478.82D
2.0 Gti	3S-GE	2.0	1992.04 - 1994.02		4480.82D
2.0 GTi 16V	3S-GE	2.0	1994.03 - 1997.09		4480.82D
2.0 i	3S-FE	2.0	1992.12 - 1997.09		3478.82D
2.0 TD	2C-T	2.0	1996.01 - 1997.09		3478.82D
CELICA (_T16_) 1985→1990					
1.6	4A-GELC, 4A-L	1.6	1986.04 - 1989.08		4103.82D
1.6 16V	4A-GEL	1.6	1985.09 - 1989.08		4103.82D
1.8	1S-EL	1.8	1987.08 - 1989.08		3478.82D
1.8	1S-ILU	1.8	1987.08 - 1989.08		4103.82D
2.0	3S-GEL, 3S-GELC	2.0	1985.08 - 1989.08		4103.82D
2.0 Turbo	3S-GTE	2.0	1988.03 - 1989.08		4480.82D

TOYOTA
**Motor
Engine
Moteur**
**Ltr.
Ltr.
Ltr.**
**Jahr
Year
Année**
**Einschränkung
Restriction*
Restriction***
**Thermostat
Thermostat
Thermostat**
CELICA (_T18_) 1989→1994

1.6 STi	4A-FE	1.6	1989.10 - 1993.11		4103.82D
2.0 GTi	3S-GE	2.0	1989.10 - 1993.11		4480.82D
2.0 Turbo	3S-GTE	2.0	1989.10 - 1993.11		4480.82D

CELICA (_T20_) 1993→1999

1.8 i 16V	7A-FE	1.8	1993.11 - 1996.08		3478.82D
2.0 i 16V	3S-GE	2.0	1996.04 - 1999.11		4480.82D
2.2 GT	5S-FE	2.2	1993.11 - 1999.08		3478.82D

**CELICA Coupe (_A6_)
1981→1986**

1.6	4A-GE	1.6	1983.12 - 1985.12		4103.82D
2.0	18R-G	2.0	1982.01 - 1985.12		3119.82D5
2.0	21R-U	2.0	1982.01 - 1985.12		3119.88D5

CELICA (ZZT23_) 1999→

1.8 16V TS	2ZZ-GE	1.8	1999.08 - 2005.09		4480.82D
1.8 16V VT-i	1ZZ-FE	1.8	1999.08 - 2005.07		4480.82D

COROLLA (_E10_) 1992→1999

1.3	4E-FE	1.3	1992.07 - 1997.04		4103.82D
1.3 12V	2E	1.3	1992.07 - 1997.04		3478.82D
1.3 16V	4E-FE	1.3	1992.07 - 1995.09		4103.82D
1.6	4A-FE	1.6	1992.05 - 1997.04		4103.82D
1.8	7A-FE	1.8	1992.05 - 1995.07		3478.82D
1.8	7A-FE	1.8	1992.05 - 1997.04		3478.82D
1.8 16V	7A-FE	1.8	1995.09 - 1997.04		3478.82D
2.0 D	2C	2.0	1992.07 - 1997.04		4103.82D

COROLLA (_E11_) 1997→2002

1.3	2E	1.3	1997.05 - 2001.10		3478.82D
1.4	4E-FE	1.4	1997.04 - 2000.02		4103.82D
1.4	4ZZ-FE	1.4	2000.02 - 2002.01		4480.82D
1.4 16V	4ZZ-FE	1.4	2000.02 - 2001.11		4480.82D
1.5	1NZ-FE	1.5	1999.09 - 2001.10		410231.82D
1.6	4A-FE	1.6	1997.04 - 2000.02		4103.82D
1.6	3ZZ-FE	1.6	2000.02 - 2002.01		4480.82D
1.6 16V	3ZZ-FE	1.6	2000.02 - 2001.11		4480.82D
1.8	7A-FE	1.8	1997.04 - 2002.06		3478.82D
1.9 D	1WZ	1.9	2000.02 - 2002.01		4446.83D
2.0 D	2C-E	2.0	1997.04 - 2000.02		4103.82D
2.0 D-4D	1CD-FTV	2.0	1997.04 - 2002.01		410231.82D
2.2 TD	3C-TE	2.2	1998.04 - 2001.10		3478.82D

COROLLA (_E12_) 2001→

1.4 D	1ND-TV	1.4	2004.07 - 2007.02		410231.82D
1.4 D-4D	1ND-TV	1.4	2004.07 - 2007.07		410231.82D
1.4 VVT-i	4ZZ-FE	1.4	2002.01 - 2007.07		4480.82D
1.5	1NZ-FE	1.5	2001.11 - 2007.07		410231.82D
1.6	1ZR-FE	1.6	2006.11 - 2007.07		4480.82D
1.6 VVT-i	3ZZ-FE	1.6	2002.01 - 2007.07		4480.82D
1.8	1ZZ-FE	1.8	2001.03 - 2007.07		4480.82D
1.8 VVT-i	1ZZ-FE	1.8	2002.01 - 2007.02		4480.82D

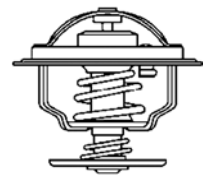

TOYOTA

	Motor Engine Moteur	Ltr. Ltr. Ltr.	Jahr Year Année	Einschränkung Restriction* Restriction*	Thermostat Thermostat Thermostat
1.8 VVTL-i	2ZZ-GE	1.8	2002.01 - 2007.02		4480.82D
2.0 D-4D	1CD-FTV	2.0	2001.09 - 2007.07		410231.82D
COROLLA (_E7_) 1979→1985					
1.3	4K, 4K-C	1.3	1979.09 - 1987.08		3119.82D5
1.6	2T, 2T-G, 2TB	1.6	1979.09 - 1983.09		3119.82D5
1.8	3T, 3T-C	1.8	1979.09 - 1983.09		3119.82D5
1.8 D	1C	1.8	1983.01 - 1987.08		4103.82D
COROLLA (_E8_) 1983→1989					
1.3	2A-L, 2E, 2E-L, 2E-LC	1.3	1983.06 - 1987.08		4103.82D
1.5		1.5	1983.06 - 1987.07		4103.82D
1.6	4A-C, 4A-L, 4A-LC	1.6	1983.06 - 1989.06		4103.82D
1.6 16V	4A-C, 4A-GE, 4A-GE, 4A-GEL	1.6	1983.05 - 1987.08		4103.82D
1.8 D	1C, 1C-L	1.8	1983.06 - 1988.05		4103.82D
COROLLA (_E9_) 1987→1994					
1.3	2E	1.3	1987.05 - 1992.04		4103.82D
1.3 i	2E-E, 2E	1.3	1987.08 - 1992.12		4103.82D
1.5	3E, 3E-E, 3E-TE	1.5	1987.11 - 1992.04		4103.82D
1.6	4A-F, 4A-FE, 4A-GE	1.6	1987.07 - 1993.06		4103.82D
1.8 D	1C	1.8	1987.07 - 1993.06		4103.82D
COROLLA LEVIN Coupe 1991→1997					
1.5	5A-FE	1.5	1991.06 - 1997.08		3478.82D
1.6 GT	4A-FE	1.6	1991.06 - 1997.08		3478.82D
COROLLA (ZER_, ZZE_) 2004→					
1.5	1NZ-FE	1.5	2004.03 - 2009.03		410231.82D
1.6	3ZZ-FE	1.6	2004.04 - 2009.03		4480.82D
1.8	1ZZ-FE	1.8	2004.04 - 2009.03		4480.82D
2.0 D-4D	1CD-FTV	2.0	2004.04 - 2009.03		410231.82D
2.2 D-4D	2AD-FTV	2.2	2005.10 - 2009.03		4480.82D
COROLLA (E14, E15)					
1.4 D-4D	1ND-TV	1.4	2007.01 -		410231.82D
1.6	1ZR-FE, 1ZR-FAE	1.6	2009.01 -		4480.82D
1.6 Dual VVTi	1ZR-FE	1.6	2007.01 -		4480.82D
1.8 Flex	2ZR-FE	1.8	2007.07 - 2011.12		4480.82D
2.0 D-4D	1AD-FTV	2.0	2007.01 -		4480.82D
CORONA 1987→1992					
1.6	4A-F	1.6	1987.12 - 1989.10		3478.82D
2.0 D	2C	2.0	1987.12 - 1992.01		4103.82D
CORONA 1992→1997					
1.6	4A-FE	1.6	1992.02 - 1997.09		3478.82D
1.8	7A-FE	1.8	1992.02 - 1997.09		3478.82D
2.0	3S-FE, 3S-GE	2.0	1992.02 - 1997.09		4103.82D

TOYOTA
**Motor
Engine
Moteur**
**Ltr.
Ltr.
Ltr.**
**Jahr
Year
Année**
**Einschränkung
Restriction*
Restriction***
**Thermostat
Thermostat
Thermostat**
CORONA 1996→

2.0	3S-FE	2.0	1996.09 - 2001.05		3478.82D
-----	-------	-----	-------------------	--	----------

CORSA

1.3	4E-FE	1.3	1990.10 - 1999.09		4103.82D
1.5	5E-FE	1.5	1994.11 - 1999.09		4103.82D
1.5 D	1N	1.5	1994.11 - 1999.09		4103.82D

CRESSIDA (_X6_) 1980→1992

2.0	21R, 21R-C	2.0	1981.05 - 1985.03		3119.82
2.0 GLi	1G-E, 1G-FE	2.0	1982.08 - 1992.09		3478.82D
2.2 D	L	2.2	1981.10 - 1985.03		4126.88

DYNA

2.0	3Y	2.0	1984.09 - 1987.08		4103.82D
2.0	1TR-FE	2.0	2006.09 -		410231.82D
2.0 LPG	1TR-FPE	2.0	2006.09 -		410231.82D
2.4 D	2J	2.4	1984.09 - 1987.08		3477.88D
2.5 D4d	2KD-FTV	2.5	2001.08 -		410181.82D
2.7	2TR-FE	2.7	2006.09 -		410231.82D
3.0 D4d	5L	3.0	2001.08 -		3477.88D
3.0 D4d	1KD-FTV	3.0	2006.09 -		410181.82D

HIACE II

1.8	2Y	1.8	1983.03 - 1989.11		4103.82D
2.0	3Y	2.0	1984.01 - 1989.11		4103.82D
2.2	4Y	2.2	1987.09 - 1989.08		4103.82D
2.2 D	L	2.2	1983.03 - 1989.11		4126.88
2.4 D	2L	2.4	1984.05 - 1989.11		3477.88D

HIACE III

2.0	1RZ	2.0	1989.08 - 1998.04		410178.82D
2.4	2RZ-E	2.4	1989.08 - 1995.08		410178.82D
2.4 D	2L	2.4	1989.08 - 1995.08		3477.88D
2.5 D-4D	2KD-FTV	2.5	2001.08 - 2004.08		410181.82D
3.0 D	5L	3.0	1998.08 - 2004.08		3477.88D

HIACE IV

2.4	2RZ-E	2.4	1995.08 - 2005.02		410178.82D
2.4 D	2L	2.4	1995.08 - 2006.08		3477.88D
2.4 TD	2L-T	2.4	1995.08 - 2006.08		3477.88D
2.5 D-4D	2KD-FTV	2.5	2001.11 - 2006.08		410181.82D
2.7	3RZ-FE	2.7	1998.04 - 2006.08		410178.82D

HIACE / COMMUTER IV

2.5 D-4D	2KD-FTV	2.5	2006.09 -		410181.82D
----------	---------	-----	-----------	--	------------

HILUX II Pick-up

1.8	2Y	1.8	1988.08 - 1994.07		4103.82D
2.0	3Y	2.0	1984.01 - 1986.12		4103.82D
2.2	4Y	2.2	1987.01 - 1989.12		4103.82D
2.4 D	2L	2.4	1984.01 - 2005.07		3477.88D

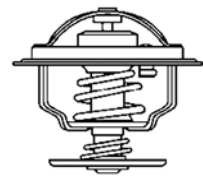

TOYOTA

	Motor Engine Moteur	Ltr. Ltr. Ltr.	Jahr Year Année	Einschränkung Restriction* Restriction*	Thermostat Thermostat Thermostat
2.4 i	2RZ-FE	2.4	1997.08 - 2005.07		410178.82D
2.4 TD	2L-T	2.4	1998.08 - 2002.01		3477.88D
2.5 D-4D	2KD-FTV	2.5	2001.11 - 2005.07		410181.82D
2.7	3RZ-FE	2.7	2001.08 - 2004.07		410178.82D
HILUX III Pick-up	2KD-FTV	2.5	2005.08 -		410181.82D
2.5 D					
2.5 D-4D	2KD-FTV	2.5	2006.06 -		410181.82D
3.0	1KD-FTV	3.0	2005.08 - 2006.09		410181.82D
3.0 D	1KD-FTV	3.0	2006.10 -		410181.82D
3.0 D-4D	1KD-FTV	3.0	2007.12 -		410181.82D
LAND CRUISER (_J7_) 1984→1996					
	2L	2.4	1984.11 - 1985.10		3477.88D
2.4 D					
2.4 TD	2L-T	2.4	1985.10 - 1996.05		3477.88D
3.0 TD	1KZ-T	3.0	1993.05 - 1996.05		410181.82D
LAND CRUISER (J12) 2002→					
3.0 D-4D	1KD-FTV	3.0	2002.09 - 2010.02		410181.82D
LAND CRUISER 80 (_J8_) 1990→1998					
	1KZ-T	3.0	1990.01 - 1991.09		410181.82D
3.0 TD					
LAND CRUISER 90 (_J9_) 1995→					
3.0 D-4D	1KD-FTV	3.0	2000.10 -		410181.82D
3.0 TD (KZJ90_, KZJ95_)	1KZ-TE	3.0	1996.04 -		410181.82D
3.4 i 24V (VZJ90_, VZJ95_)	5VZ-FE	3.4	1996.04 -		4480.82D
LAND CRUISER 150 (KDJ15_, GRJ15_)					
	1KD-FTV	3.0	2010.01 -		410181.82D
3.0 D-4D					
LITEACE (_M2_) 1979→1986					
1.3	4K	1.3	1979.10 - 1985.09		3119.82D5
1.8 D	1C	1.8	1982.10 - 1985.09		3478.82D
LITEACE (M2_) 1979→1986					
1.3	4K, 4K-C	1.3	1979.10 - 1986.10		3119.88D5
LITEACE (CM3_, KM3_) 1984→1992					
	5K	1.5	1985.10 - 1992.01		3119.88
1.5					
2.0 D	2C	2.0	1988.08 - 1992.01		3478.82D
LITEACE (_R2_LG) 1992→1998					
2.0 D	2C	2.0	1992.01 - 1994.05		3478.82D
2.2	4Y-EC	2.2	1992.01 - 1995.01		3478.82D

TOYOTA
**Motor
Engine
Moteur**
**Ltr.
Ltr.
Ltr.**
**Jahr
Year
Année**
**Einschränkung
Restriction*
Restriction***
**Thermostat
Thermostat
Thermostat**
MODELL F (_R2_,31)

1.8	2Y-C, 2Y	1.8	1982.11 - 1984.08		4103.82D
2.0	3Y, 3Y-C	2.0	1984.08 - 1990.01		4103.82D
2.2	4Y-EC	2.2	1987.08 - 1990.01		4103.82D

MR 2 I (_W1_)

1.6 16V	4A-GEL, 4A-GELC	1.6	1984.11 - 1990.06		4103.82D
---------	-----------------	-----	-------------------	--	----------

MR 2 II (_W2_)

2.0	3S-FE	2.0	1989.12 - 1992.08		4480.82D
2.0 16V	3S-GE	2.0	1989.12 - 1993.11		4480.82D

MR 2 III (_W3_)

1.8 16V VT-i	1ZZ-FE	1.8	1999.10 - 2007.06		4480.82D
--------------	--------	-----	-------------------	--	----------

PASEO (EL54)

1.5	5E-FE	1.5	1996.10 - 1999.03		3478.82D
1.5 16V	5E-FE	1.5	1995.08 - 1999.07		3478.82D

PICNIC (_XM10)

2.0	3S-FE	2.0	2001.01 - 2001.12		3478.82D
2.0 16V	3S-FE	2.0	1996.05 - 2001.12		3478.82D
2.2 D	3C-TE	2.2	1997.08 - 2001.12		3478.82D

**PREVIA (TCR1_,TCR2_)
1990→2000**

2.4	2TZ-FE, 2TZ-FZE	2.4	1990.05 - 2000.08		410178.82D
-----	-----------------	-----	-------------------	--	------------

PREVIA (ACR3) 2000→

2.0 D-4D	1CD-FTV	2.0	2001.03 - 2006.01		410231.82D
2.4	2AZ-FE	2.4	2000.08 - 2006.01		4480.82D
3.0 VVTi	1MZ-FE	3.0	2000.08 - 2005.12		4480.82D
3.5	2GR-FE	3.5	2000.02 - 2006.01		4480.82D

PREVIA III (ACR5_, GSR5_)

2.4	2AZ-FE	2.4	2005.10 -		4480.82D
3.5	2GR-FE	3.5	2006.01 -		4480.82D

PRIUS

1.5	1NZ-FXE	1.5	2000.05 - 2009.03		410231.82D
-----	---------	-----	-------------------	--	------------

RAV 4 I (SXA1_)

2.0	3S-FE	2.0	1994.06 - 2000.06		3478.82D
2.0 16V	3S-FE	2.0	1997.12 - 2000.06		3478.82D

RAV 4 II (_A2_)

1.8 VVTi	1ZZ-FE	1.8	2001.02 - 2005.11		4480.82D
2.0 D-4D	1CD-FTV	2.0	2001.09 - 2005.11		410231.82D
2.0 VVTi	1AZ-FE	2.0	2000.06 - 2005.11		4480.82D



TOYOTA

	Motor Engine Moteur	Ltr. Ltr. Ltr.	Jahr Year Année	Einschränkung Restriction* Restriction*	Thermostat Thermostat Thermostat
RAV 4 III (ACA3_, ACE_, ALA3_, GSA3_, ZSA3_)					
2.0	3ZR-FAE	2.0	2008.12 -		4480.82D
2.0 VVT-i	1AZ-FE, 3ZR-FAE	2.0	2006.03 -		4480.82D
2.2 D-4D	2AD-FHV, 2AD-FTV	2.2	2006.03 -		4480.82D
2.2 D-CAT	2AD-FHV	2.2	2006.03 -		4480.82D
2.4 VVTi	2AZ-FE	2.4	2005.11 -		4480.82D
3.5	2GR-FE	3.5	2007.08 -		4480.82D
3.5 VVTi	2GR-FE	3.5	2005.11 -		4480.82D
STARLET (KP6) 1978→1984					
1.0	2K	1.0	1978.02 - 1984.09		3119.82D5
1.2	3K-H	1.2	1978.02 - 1982.09		3119.82D5
1.3	4K	1.3	1982.08 - 1984.09		3119.82D5
STARLET (_P7_) 1984→1989					
1.0	1E-L	1.0	1984.10 - 1989.12		4103.82D
1.3	2E-LC	1.3	1984.10 - 1989.12		4103.82D
1.5 D	1N	1.5	1986.12 - 1989.12		4103.82D
STARLET (_P8_) 1989→1996					
1.3	2E	1.3	1989.12 - 1991.12		4103.82D
1.3 12V	2E-E, 2E	1.3	1989.12 - 1996.03		4103.82D
1.5 D	1N	1.5	1989.12 - 1996.03		4103.82D
STARLET (EP91) 1996→1999					
1.3	4E-FE	1.3	1996.04 - 1999.03		4103.82D
SUPRA (JZA80)					
3.0 i Bi-Turbo	2JZ-GTE	3.0	1993.05 - 2002.08		410231.82D
TERCEL (_L1_, _L2_) 1979→1988					
1.3	2A	1.3	1979.03 - 1988.01		4103.82D
1.45	3A-C	1.45	1983.08 - 1985.05		4103.82D
1.5	3A, 3A-C	1.5	1982.10 - 1988.01		4103.82D
VENZA (GGV1_, AGV1_)					
2.7	1AR-FE	2.7	2008.11 -		4480.82D
VERSO (_AUR2_, _ZGR2_)					
1.6	1ZR-FAE	1.6	2009.04 -		4480.82D
1.8	2ZR-FAE	1.8	2009.04 -		4480.82D
2.0 D-4D	1AD-FTV	2.0	2009.04 -		4480.82D
2.2 D-CAT	2AD-FHV	2.2	2009.04 -		4480.82D

TOYOTA
**Motor
Engine
Moteur**
**Ltr.
Ltr.
Ltr.**
**Jahr
Year
Année**
**Einschränkung
Restriction*
Restriction***
**Thermostat
Thermostat
Thermostat**
YARIS (_P1, P2, P9)

1.0 16V	1SZ-FE	1.0	1999.04 - 2005.09		410201.80D
1.0 VVT-i	1KR-FE	1.0	2006.01 -		410201.80D
1.3	2NZ-FE, 2SZ-FE	1.3	1999.11 - 2005.09		410231.82D
1.3 16V	2NZ-FE	1.3	1999.11 - 2005.09		410231.82D
1.3 VVT-i	2SZ-FE	1.3	2006.01 -		410201.80D
1.33 VVT-i	1NR-FE	1.33	2009.03 -		410201.80D
1.4 D-4D	1ND-TV	1.4	2001.12 - 2005.09		410231.82D
1.5	1NZ-FE	1.5	2000.03 - 2005.09		410231.82D
1.5 VVT-i	1NZ-FE	1.5	2001.04 - 2005.09		410231.82D
1.8 VVTi	2ZR-FE	1.8	2007.01 - 2008.08		4480.82D

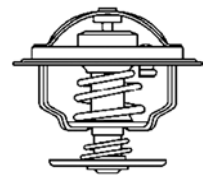
VAUXHALL

	Motor Engine Moteur	Ltr. Ltr. Ltr.	Jahr Year Année	Einschränkung Restriction* Restriction*	Thermostat Thermostat Thermostat
AGILA Mk I (A)					
1.0 12V	Z 10 XE, Z 10 XEP	1.0	2000.02 - 2006.11		411579.92D ▲
1.2 16V	Z 12 XE	1.2	2000.09 - 2008.03		411579.92D ▲
1.2 16V Twinport	Z 12 XEP	1.2	2004.07 - 2006.11		411579.92D ▲
1.3 CDTI	Z 13 DT	1.3	2003.08 - 2008.03		410588.88D
AGILA Mk II (B)					
1.3 CDTI	D13A, Z 13 DTJ	1.3	2008.01 -		410588.88D
ANTARA					
2.4	Z 24 XED	2.4	2006.08 -		4189.87D
2.4	A 24 XE	2.4	2010.11 -		411193.82D
ARENA					
1.9 D	F8Q 600, F8Q 606	1.9	1998.03 - 2001.08	ohne Gehäuse	3470.89D50
1.9 D	F8Q 606, F8Q 600	1.9	1998.04 - 2001.08	mit Gehäuse	410530.89D
2.5 D	S8U 780, S8U 782, S8U 758	2.5	1998.03 - 2001.08		4151.76D
		1.2	1979.10 - 1984.08		3017.92D50
ASTRA					
1.2	12 S				
1.2 S	12 S	1.2	1982.02 - 1984.08		3017.92D50
1.3	13 S	1.3	1980.09 - 1984.08		3017.92D50
1.3 S	13 S	1.3	1979.09 - 1984.08		3017.92D50
1.6 D	16 D	1.6	1982.02 - 1986.08		4115.92D
1.6 S	16 S, 16 SH	1.6	1981.09 - 1986.08		3054.87D50
1.8 GTE	18 E	1.8	1983.03 - 1986.08		4255.82D
ASTRA Mk II					
1.2	12 S	1.2	1984.09 - 1991.08		3017.92D2
1.3	13 S	1.3	1984.09 - 1991.08		3017.92D2
1.4 i	C 14 NZ	1.4	1990.01 - 1991.12		3017.92D2
1.4 S	14 NV	1.4	1989.01 - 1991.08		3017.92D2
1.5 DT	15 DT	1.5	1987.01 - 1991.08		3468.88D
1.6	16 SV	1.6	1984.09 - 1991.08		3017.92D2
1.6	16 SH	1.6	1985.09 - 1991.08		4115.92D
1.6 D	16 DA	1.6	1984.09 - 1991.08		4115.92D
1.6 i	16 SV, C 16 NZ, C 16 LZ, E 16 NZ	1.6	1987.01 - 1993.08		3017.92D2
1.6 S	16 SH	1.6	1984.09 - 1986.08		4115.92D
1.6 S	16 S, 16 SV	1.6	1989.01 - 1991.12		3017.92D2
1.7 D	17 D, 17 DR	1.7	1989.01 - 1991.12		4115.92D
1.8	18 SE	1.8	1986.01 - 1990.12		4164.92D
1.8 GTE	18 SE, 18 E	1.8	1984.09 - 1991.08	ohne Gehäuse	4115.92D
1.8 GTE	18 SE, 18 E	1.8	1984.09 - 1991.08	mit Gehäuse	4164.92D
1.8 i	18 SE, 18 E	1.8	1985.09 - 1991.08	mit Gehäuse	4164.92D
1.8 i	18 E	1.8	1990.01 - 1991.08	ohne Gehäuse	4115.92D
1.9	C 20 XE	1.9	1988.03 - 1991.08		3017.92D2
2.0 GTE	20 SEH	2.0	1986.09 - 1991.08		4164.92D
2.0 GTE 16V	20 XE	2.0	1988.05 - 1991.08		4164.92D
2.0 i	20 NE, C 20 NE	2.0	1987.01 - 1993.08		4164.92D
ASTRA Mk III					
1.4 i	C 14 NZ, C 14 SE	1.4	1991.01 - 2001.03		3017.92D2
1.4 i 16V	X 14 XE	1.4	1996.01 - 2001.03		4178.92D
1.4 S	14 NV	1.4	1991.09 - 1998.02		3017.92D2

VAUXHALL
**Motor
Engine
Moteur**
**Ltr.
Ltr.
Ltr.**
**Jahr
Year
Année**
**Einschränkung
Restriction*
Restriction***
**Thermostat
Thermostat
Thermostat**

1.6	C 16 SE	1.6	1994.03 - 1995.08		4178.92D
1.6 i	C 16 NZ, C 16 SE, E 16 NZ, X 16 SZ, X 16 SZR	1.6	1991.01 - 2001.03		3017.92D2
1.6 i 16V	X 16 XEL	1.6	1994.01 - 1998.09		4178.92D
1.6 Si	C 16 SE	1.6	1991.03 - 1994.12		3017.92D2
1.7 D	17 D, 17 DR	1.7	1991.12 - 1998.02		4115.92D
1.7 TD	17 DT (TC4EE1)	1.7	1991.11 - 1998.09	Motor no. →731418	3468.88D
1.7 TD	17 DT (TC4EE1)	1.7	1991.12 - 1998.09	Motor no. 731419→	3467.85D
1.7 TD	X 17 DTL	1.7	1994.01 - 1998.09		4115.92D
1.8	C 18 XE	1.8	1994.09 - 1996.08	Chassis No. →01458051	4177.92D
1.8	C 18 XE	1.8	1994.10 - 1996.08	Chassis No. 01458052→	4183.92D
1.8 16V	X 18 XE, C 18 XEL	1.8	1994.11 - 2001.03	Chassis No. →01458051	4177.92D
1.8 16V	X 18 XE, C 18 XEL	1.8	1994.12 - 2001.03	Chassis No. 01458052→	4183.92D
1.8 i	C 18 NZ	1.8	1991.09 - 1998.09		4168.92D
1.8 i 16V	C 18 XE, C 18 XEL	1.8	1993.06 - 1998.02	Chassis No. →01458051	4177.92D
1.8 i 16V	C 18 XE, C 18 XEL	1.8	1993.07 - 1998.02	Chassis No. 01458052→	4183.92D
1.8 i 16V	X 18 XE, C 18 XEL	1.8	1994.09 - 1998.02	Chassis No. →01458051	4177.92D
1.8 i 16V	X 18 XE, C 18 XEL	1.8	1994.10 - 1998.03	Chassis No. 01458052→	4183.92D
2.0 i	C 20 NE	2.0	1991.09 - 1998.09		4168.92D
2.0 i 16V	C 20 XE	2.0	1991.09 - 1998.02		4164.92D
2.0 i 16V	X 20 XEV	2.0	1994.01 - 1998.09		4183.92D

ASTRA Mk IV

1.2 16V	X 12 XE, Z 12 XE	1.2	1998.02 - 2005.05		4459.92D
1.4 16V	X 14 XE	1.4	1998.02 - 2005.05		4208.92D
1.4 16V	Z 14 XE	1.4	1998.02 - 2005.05		4242.92D
1.6	X 16 SZR, Z 16 SE	1.6	1998.02 - 2005.05		3017.92D2
1.6	Z 16 XEP	1.6	2002.12 - 2005.05		4431.105D
1.6 16V	X 16 XEL	1.6	1998.02 - 2005.05		4208.92D
1.6 16V	Z 16 XE	1.6	1998.02 - 2005.10		4242.92D
1.6 16V	C 16 SEL	1.6	1998.09 - 2005.05		3017.92D2
1.6 16V	Z 16 XEP	1.6	1998.09 - 2005.10		4431.105D
1.6 Dualfuel	Z 16 XE	1.6	1998.03 - 2005.05		4242.92D
1.6 i	X 16 SZR	1.6	1998.08 - 2000.09		3017.92D2
1.6 i	Z 16 SE	1.6	2000.09 - 2006.08		3017.92D2
1.7 TD	X 17 DTL	1.7	1998.02 - 2006.08		4115.92D
1.8 16V	Z 18 XE, Z 18 XEL, X 18 XE1	1.8	1998.02 - 2005.10		411578.92D ▲
1.8 16V Dualfuel	Z 18 XE	1.8	1998.02 - 2005.08		411578.92D ▲
2.0	X 20 XER, Z 20 LET	2.0	1999.10 - 2006.07		4183.92D
2.0 16V	X 20 XER, X 20 XEV	2.0	1998.02 - 2005.05		4183.92D
2.0 16V Turbo	Z 20 LET	2.0	2000.09 - 2005.08		4183.92D
2.0 DI	X 20 DTL, Y 20 DTL	2.0	1998.02 - 2006.08		4198.92D
2.0 DTI	Y 20 DTH	2.0	2004.04 - 2006.08	Motor no. →17B49754, → 2(2/5/6/8/B/H) 999999	4198.92D
2.0 DTI	Y 20 DTH	2.0	2004.05 - 2006.09	Motor no. 17B49755→	4428.92D
2.0 DTI 16V	Y 20 DTH	2.0	1998.02 - 2005.05	Motor no. →17B49754, → 2(2/5/6/8/B/H) 999999	4198.92D

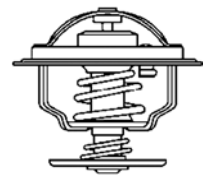

VAUXHALL

	Motor Engine Moteur	Ltr. Ltr. Ltr.	Jahr Year Année	Einschränkung Restriction* Restriction*	Thermostat Thermostat Thermostat
2.0 DTI 16V	Y 20 DTH	2.0	1998.04 - 2005.05	Motor no. 17B49755→, 3(2/5/6/8/B/H) 999999 →	4428.92D
2.0 SRI Turbo	Z 20 LET	2.0	2002.07 - 2005.05		4183.92D
2.0 Turbo	Z 20 LET	2.0	2002.03 - 2005.10		4183.92D
2.2 16V	Z 22 SE	2.2	2000.03 - 2005.10		411193.82D
2.2 DTI	Y 22 DTR	2.2	2002.09 - 2005.05		4433.92D
ASTRA Mk V					
1.2	Z 12 XEP	1.2	2005.08 - 2010.10		4459.92D
1.3 CDTI	Z 13 DTH	1.3	2004.01 - 2010.11		410048.88D
1.4	Z 14 XEL, Z 14 XEP	1.4	2004.01 - 2010.11		4459.92D
1.4 i	Z 14 XEP	1.4	2005.03 -		4459.92D
1.4 i 16V	Z 14 XEP	1.4	2005.03 - 2010.11		4459.92D
1.6	Z 16 XE1, Z 16 XEP, Z 16 XER	1.6	2004.01 - 2010.11		4431.105D
1.6	Z 16 LET	1.6	2004.08 - 2010.11		4357.92D
1.6 i 16V	Z 16 XER	1.6	2006.10 - 2010.11		4431.105D
1.8	Z 18 XE	1.8	2004.01 - 2010.11		411578.92D ▲
1.8	Z 18 XER, A 18 XER	1.8	2004.01 - 2010.11		4431.105D
1.8 i 16V	Z 18 XER, A 18 XER	1.8	2007.03 - 2010.11		4431.105D
1.9 CDTI	Z 19 DT, Z 19 DTH, Z 19 DTJ, Z 19 DTL	1.9	2004.01 - 2011.11		410049.88D
1.9 CDTI 16V	Z 19 DTJ	1.9	2004.01 - 2009.05		410049.88D
2.0	Z 20 LEL	2.0	2006.02 - 2010.11		4183.92D
2.0 Turbo	Z 20 LEH, Z 20 LEL, Z 20 LER	2.0	2004.01 - 2011.11		4183.92D
2.0 VXR	Z 20 LEH	2.0	2009.02 - 2010.11		4183.92D
ASTRA Mk VI (J)					
1.6	A 16 XER, A 16 LET	1.6	2009.12 -		411059.105D ▲
1.6 Turbo	A 16 LET	1.6	2009.12 -		411059.105D ▲
2.0 VXR	A 20 NFT	2.0	2012.04 -		411193.82D
CALIBRA					
2.0 i	C 20 NE	2.0	1990.06 - 1997.07		4144.92D
2.0 i 16V	C 20 XE	2.0	1990.06 - 1994.02		4164.92D
2.0 i 16V	X 20 XEV	2.0	1990.06 - 1997.07		4183.92D
2.0 i Turbo	C 20 LET	2.0	1992.03 - 1997.07		4164.92D
2.5 i V6	X 25 XE, C 25 XE	2.5	1993.04 - 1997.07		4175.92D
CARLTON Mk II					
1.8 S	18 S	1.8	1982.11 - 1986.08		4115.92D
2.0	20 E	2.0	1977.09 - 1986.08		4255.87D
2.0 i	20 E	2.0	1983.01 - 1984.12		4255.87D
2.0 S	C 20 NEJ	2.0	1978.10 - 1986.08		4144.92D
2.2 i	22 E	2.2	1984.11 - 1986.08		4255.92D
2.3 D	23 D	2.3	1983.05 - 1986.08		4255.92D
CARLTON Mk III					
1.8	S 18 NV	1.8	1986.09 - 1988.08		4115.92D
1.8	18 NV, 18 SEH, 18 SV, E 18 NVR	1.8	1986.09 - 1994.03		4144.92D
2.0	C 20 NE, C 20 NEF, C 20 NEJ	2.0	1986.09 - 1994.03		4144.92D
2.0 i	20 SE, C 20 NEJ	2.0	1986.09 - 1994.03		4144.92D
2.2 TD	23 YDT	2.2	1986.09 - 1988.08		4255.92D
2.3 D	23 YD	2.3	1986.09 - 1994.03		4255.92D

VAUXHALL
**Motor
Engine
Moteur**
**Ltr.
Ltr.
Ltr.**
**Jahr
Year
Année**
**Einschränkung
Restriction*
Restriction***
**Thermostat
Thermostat
Thermostat**

2.3 TD Interc.	23 DTR	2.3	1988.08 - 1994.03		4255.92D
2.4 i	C 24 NE	2.4	1988.09 - 1994.03		4255.92D
2.6 i	C 26 NE	2.6	1990.09 - 1994.03		4255.92D
3.0	C 30 NE	3.0	1987.03 - 1994.03		4255.92D
3.0 24V	C 30 SEJ	3.0	1989.09 - 1994.03		4255.92D
3.0 3000	30 NE	3.0	1987.03 - 1990.09		4255.92D
3.0 3000 24V	C 30 SE	3.0	1989.09 - 1994.03		4255.92D
3000	C 30 LE	3.0	1987.03 - 1994.03		4255.92D
3000 24V	C 30 SEJ	3.0	1989.09 - 1994.03		4255.92D

CAVALIER Mk II

1.3	13 N, 13 NB, 13 S	1.3	1981.09 - 1988.08		3017.92D2
1.6	16 SH	1.6	1983.10 - 1988.08		4164.92D
1.6 D	16 D, 16 DA	1.6	1982.03 - 1988.08		4115.92D
1.6 i	C 16 NZ, C 16 LZ, E 16 NZ	1.6	1986.08 - 1988.08		3017.92D2
1.6 N	16 N	1.6	1981.09 - 1988.08		4164.92D
1.6 S	16 SH	1.6	1981.09 - 1988.08		4164.92D
1.8	E 18 NV	1.8	1986.08 - 1988.08		4164.92D
1.8 i	18 E, 18 SE	1.8	1981.09 - 1988.08		4164.92D
1.8 i	C 18 NE	1.8	1985.01 - 1986.08		4115.92D
1600D	16 DA, 16 D	1.6	1982.03 - 1988.08		4115.92D
1800i	18 SE	1.8	1985.03 - 1988.10		4115.92D
2.0	20 E	2.0	1986.08 - 1987.08		4144.92D
2.0	20 S	2.0	1986.09 - 1987.08		3021.88D50
2.0 i	20 NE, C 20 NE	2.0	1986.09 - 1988.08		4164.92D
2.0 SRi 130	20 SEH	2.0	1987.03 - 1988.08		4164.92D
2000i	20 SE	2.0	1986.09 - 1988.08		4164.92D

CAVALIER Mk III

1.4 S	14 NV	1.4	1988.09 - 1995.11		3017.92D2
1.6	16 SV	1.6	1988.09 - 1993.05		3017.92D2
1.6 i	E 16 NZ, X 16 SZ	1.6	1988.09 - 1995.11		3017.92D2
1.7 D	17 D, 17 DR	1.7	1988.09 - 1995.11		4115.92D
1.7 TD	17 DT (TC4EE1)	1.7	1988.09 - 1995.11	Motor no. →731418	3468.88D
1.7 TD	17 DT (TC4EE1)	1.7	1988.10 - 1995.11	Motor no. 731419→	3467.85D
1.8	C 18 NZ, 18 SV	1.8	1988.09 - 1995.08		4144.92D
1.8 i	C 18 NZ	1.8	1990.03 - 1995.11		4144.92D
2.0 i	20 NE, 20 SEH, 20 XE, C 20 NE	2.0	1988.09 - 1995.11		4164.92D
2.0 i 16V	C 20 XE	2.0	1988.09 - 1995.11		4164.92D
2.0 i 16V	X 20 XEV	2.0	1993.09 - 1995.11		4183.92D
2.0 i Turbo	C 20 LET	2.0	1992.06 - 1994.11		4164.92D
2.0 SRi	20 SEH	2.0	1988.09 - 1992.09		4164.92D
2.0 SRi 16V	X 20 XEV	2.0	1993.09 - 1995.11		4183.92D
2.5 V6	C 25 XE	2.5	1988.08 - 1994.06		4175.92D

CHEVETTE

1.2	13 N	1.2	1976.09 - 1985.12		3017.92D50
1300	13 N, 13 S	1.3	1975.03 - 1985.12		3017.92D50

COMBO Mk I

1.2	C 12 NZ, X 12 SZ	1.2	1994.07 - 2001.10		3017.92D2
1.4	C 14 NZ, C 14 SE	1.4	1994.07 - 2001.10		3017.92D2
1.7 D	17 D (4EE1), X 17 D (4EE1)	1.7	1994.07 - 2001.10	Motor no. →334922	3467.85D

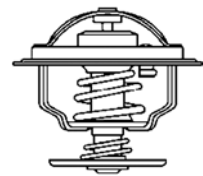

VAUXHALL

	Motor Engine Moteur	Ltr. Ltr. Ltr.	Jahr Year Année	Einschränkung Restriction* Restriction*	Thermostat Thermostat Thermostat
COMBO Mk II					
1.3 CDTI 16V	Y 13 DT, Z 13 DT, Z 13 DTJ	1.3	2004.09 - 2012.02		410588.88D
1.4	Z 14 XEP	1.4	2004.10 - 2010.09		4459.92D
1.4 16V	Z 14 XE	1.4	2001.10 - 2007.05		4242.92D
1.4 16V	Z 14 XEP	1.4	2004.01 - 2011.11		4459.92D
1.6	Z 16 SE	1.6	2001.08 - 2011.11		3017.92D2
1.6 CNG	Z 16 YNG	1.6	2006.06 - 2010.09		4242.92D
1.6 CNG 16V	Z 16 YNG	1.6	2005.04 - 2012.02		4242.92D
CORSA Mk I					
1.0 i 12V	X 10 XE	1.0	1996.11 - 2000.09		4459.92D
1.2 i	C 12 NZ, X 12 SZ	1.2	1993.03 - 2000.09		3017.92D2
1.2 i 16V	X 12 XE	1.2	1998.03 - 2000.09		4459.92D
1.4 i	C 14 NZ, X 14 SZ	1.4	1993.03 - 2000.09		3017.92D2
1.4 i 16V	X 14 XE	1.4	1994.09 - 2000.09		4178.92D
1.4 i S	C 14 SE	1.4	1993.03 - 2000.09		3017.92D2
1.5 D	15 D	1.5	1993.03 - 2000.09	Motor no. →544012	3468.88D
1.5 D	15 D	1.5	1993.04 - 2000.09	Motor no. 544013 →	3467.85D
1.5 TD	X 15 DT (T4EC1), 15 DT (T4EC1)	1.5	1993.03 - 1996.10	Motor no. →544012	3468.88D
1.5 TD	X 15 DT (T4EC1), 15 DT (T4EC1)	1.5	1993.04 - 1996.10	Motor no. 544013 →	3467.85D
1.6 i 16V	C 16 XE, X 16 XE	1.6	1993.03 - 2000.09		4178.92D
1.7 D	17 D (4EE1), X 17 D (4EE1)	1.7	1996.02 - 2000.09	Motor no. →334922	3467.85D
CORSA Mk II					
1.0 12V	Z 10 XE, Z 10 XEP	1.0	2000.09 - 2003.10		4459.92D
1.2 16V	Z 12 XE	1.2	2000.09 - 2006.10		4459.92D
1.2 16V Dualfuel	Z 12 XE	1.2	2001.08 - 2006.10		4459.92D
1.2 Twinport	Z 12 XEP	1.2	2004.07 - 2006.10		4459.92D
1.3 CDTI 16V	Z 13 DT	1.3	2000.08 - 2006.09		410588.88D
1.3 CDTI 16V	Z 13 DTJ	1.3	2005.09 - 2006.09		410048.88D
1.4 16V	Z 14 XE	1.4	2000.09 - 2006.10		4242.92D
1.4 Twinport	Z 14 XEP	1.4	2003.06 - 2006.10		4459.92D
1.6 CNG	Y 16 YNG, Z 16 YNG	1.6	2003.05 - 2006.10		4242.92D
1.8 16V	Z 18 XE	1.8	2000.08 - 2006.09		411578.92D ▲
CORSA Mk III					
1.0	Z 10 XEP, A 10 XEP	1.0	2006.11 -		4459.92D
1.0 i 12V	A 10 XEP	1.0	2010.06 -		4459.92D
1.2	Z 12 XEP	1.2	2006.11 -		4459.92D
1.2 LPG	Z 12 XEP	1.2	2009.09 -		4459.92D
1.3 CDTI	A 13 DTC, Z 13 DTH, Z 13 DTJ	1.3	2006.11 -		410048.88D
1.4	Z 14 XEP	1.4	2006.07 -		4459.92D
1.4 LPG	Z 14 XEP	1.4	2006.07 -		4459.92D
1.6 VXR	A 16 LER, Z 16 LER	1.6	2007.02 -		4357.92D
CORSAVAN Mk I					
1.4 i	C 14 NZ	1.4	1994.01 - 2000.09		3017.92D2
1.5 D	15 D	1.5	1994.08 - 1995.12	Motor no. 544013 →	3467.85D
1.5 D	15 D	1.5	1994.09 - 1995.12	Motor no. →544012	3468.88D
1.7 D	17 D (4EE1), X 17 D (4EE1)	1.7	1994.01 - 2000.09	Motor no. →334922	3467.85D

VAUXHALL

 Motor
Engine
Moteur

 Ltr.
Ltr.
Ltr.

 Jahr
Year
Année

 Einschränkung
Restriction*
Restriction*

 Thermostat
Thermostat
Thermostat

CORSAVAN Mk II

1.2 16V	Z 12 XE	1.2	2000.09 - 2006.06		4459.92D
1.2 16V Dualfuel	Z 12 XE	1.2	2001.08 - 2006.06		4459.92D
1.3 CDTI 16V	Z 13 DT	1.3	2004.04 - 2006.06		410588.88D
1.4	Z 14 XEP	1.4	2003.11 - 2006.06		4459.92D

CORSAVAN Mk III

1.2	Z 12 XEP	1.2	2009.07 -		4459.92D
1.3 CDTI	Z 13 DTH, Z 13 DTJ	1.3	2006.07 -		410048.88D

FRONTERA Mk I (A)

2.0	C 20 NE, X 20 SE	2.0	1995.04 - 1998.08		4144.92D
2.0 i	C 20 NE, X 20 SE	2.0	1992.03 - 1998.10		4144.92D
2.2 i	X 22 XE	2.2	1995.03 - 1998.10		4177.92D
2.3 TD	23 DTR	2.3	1991.09 - 1998.06		4255.92D
2.4 i	C 24 NE	2.4	1992.03 - 1998.10		4255.92D
2.5 TDS	25TDS (VM41B)	2.5	1991.11 - 1998.10		4158.80D
FRONTERA Mk II (B) 2.2 DTI	X 22 DTH, Y 22 DTH	2.2	1998.10 - 2004.09		4207.92D
2.2 i	X 22 SE, Y 22 SE	2.2	1998.10 - 2004.10		4177.92D
3.2 i	Y 32 NE, 6 VD1	3.2	1998.10 - 2004.10		4144.92D

INSIGNIA

1.6	A 16 XER	1.6	2008.07 -	Chassis No. →91999999	4431.105D
1.6	A 16 XER	1.6	2008.08 -	Chassis No. A1000001→	411059.105D ▲
1.6 Turbo	A 16 LET	1.6	2009.01 -		4357.92D
1.8	A 18 XER	1.8	2008.07 - 2013.09	Chassis No. →91999999	4431.105D
1.8	A 18 XER	1.8	2008.08 - 2013.09	Chassis No. A1000001→	411059.105D ▲
2.0 Turbo	A 20 NFT, A 20 NHT	2.0	2008.07 -		411193.82D

MAGNUM

1.8		1.8	1973.01 - 1981.01		3004.88D1
2.3		2.3	1973.01 - 1981.01		3004.88D1

MERIVA Mk I (A)

1.3 CDTI	Y 13 DT, Z 13 DT, Z 13 DTJ	1.3	2003.01 - 2010.06		410588.88D
1.4 16V Twinport	Z 14 XEP	1.4	2003.01 - 2009.10		4459.92D
1.6 i	Z 16 SE	1.6	2003.01 - 2010.06		3017.92D2
1.6 i 16V	Z 16 XE	1.6	2003.01 - 2005.09		4242.92D
1.6 i 16V Twinport	Z 16 XEP	1.6	2003.05 - 2010.06		4431.105D
1.6 Turbo	Z 16 LET	1.6	2006.05 - 2010.06		4357.92D
1.8 i 16V	Z 18 XE	1.8	2003.05 - 2005.08		411578.92D ▲

MOKKA

1.6	A 16 XER	1.6	2012.06 -		411059.105D ▲
-----	----------	-----	-----------	--	---------------

MOVANO

1.9 DTI	F9Q 770	1.9	2000.09 - 2001.10	Motor no. 000529→	3470.89D50
1.9 DTI	F9Q 774	1.9	2001.10 - 2010.05		410517.83D



VAUXHALL

	Motor Engine Moteur	Ltr. Ltr. Ltr.	Jahr Year Année	Einschränkung Restriction* Restriction*	Thermostat Thermostat Thermostat
2.5 D	S8U 770	2.5	1998.10 - 2000.09		4174.79D
2.8 DTI	S9W 702	2.8	1998.10 - 2001.10		4174.79D
NOVA					
1.0	10 S	1.0	1982.09 - 1993.03		3017.92D2
1.2	12 NV	1.2	1990.01 - 1994.10		3017.92D2
1.2 i	12 NC, C 12 NZ, E 12 GV	1.2	1985.01 - 1993.03		3017.92D2
1.2 N	12 NC, 12 NV, E 12 GV	1.2	1985.01 - 1993.03		3017.92D2
1.2 S	12 S, 12 ST	1.2	1982.09 - 1990.02		3017.92D2
1.3 i	13 NB, C 13 N	1.3	1985.09 - 1993.03		3017.92D2
1.3 S	13 SB	1.3	1982.09 - 1989.10		3017.92D2
1.4	14 NV, C 14 NZ, C 14 SE	1.4	1990.09 - 1993.03		3017.92D2
1.4 i	C 14 NZ	1.4	1990.01 - 1993.03		3017.92D2
1.4 i S	C 14 SE	1.4	1991.09 - 1993.03		3017.92D2
1.4 S	14 NV	1.4	1990.01 - 1993.03		3017.92D2
1.5 D	15 D	1.5	1987.09 - 1994.10		3468.88D
1.5 TD	15 DT (T4EC1)	1.5	1990.01 - 1993.03		3468.88D
1.6	E 16 SE	1.6	1988.09 - 1990.08		3017.92D2
1.6 GSI	C 16 SE, C 16 SEI, E 16 SE	1.6	1988.05 - 1993.03		3017.92D2
OMEGA					
2.0	20 SE, X 20 SE	2.0	1994.03 - 1999.09		4144.92D
2.0 16V	X 20 XEV	2.0	1994.03 - 2001.02		4183.92D
2.0 DTI 16V	X 20 DTH	2.0	1998.01 - 2000.09		4188.92D
2.2 16V	Y 22 XE, Z 22 XE	2.2	1994.01 - 2003.06		4183.92D
2.2 DTI 16V	Y 22 DTH	2.2	2000.08 - 2003.07		4188.92D
2.5 DTI 24V	Y 25 DT	2.5	2001.09 - 2003.07		4237.80D
2.5 TD	25 DT, X 25 DT	2.5	1994.04 - 2001.07		4237.80D
2.5 V6	X 25 XE	2.5	1994.03 - 2000.09		4175.92D
2.6 V6	Y 26 SE	2.6	2000.08 - 2003.07	Motor no. →11999999	4175.92D
3.0 V6	X 30 XE	3.0	1994.04 - 2000.07	Motor no. →11999999	4175.92D
3.2 V6	Y 32 SE	3.2	2001.02 - 2003.07	Motor no. →11999999	4175.92D
ROYALE					
2.0 E	H 20 E	2.0	1983.03 - 1984.10		4255.87D
2.2 E	22 E	2.2	1984.11 - 1987.08		4255.87D
2.2 TD	23 TD	2.2	1984.11 - 1987.08		4255.92D
2.5	25 S	2.5	1978.05 - 1980.12		3054.92D50
2.5 E	25 E, H 25 E	2.5	1983.01 - 1987.08		4255.87D
2.8	28 H	2.8	1978.02 - 1982.10		3054.92D50
2.9	30 E, 30 H, C 30 LE	2.9	1978.02 - 1987.08		4255.92D
2.9 E	30 E	2.9	1978.02 - 1986.12		4255.92D
3.0	30 E	3.0	1979.10 - 1982.10		4255.92D
SENATOR					
2.5 i	25 E	2.5	1984.09 - 1990.10		4255.87D
2.6 i	C 26 NE	2.6	1990.09 - 1993.09		4255.92D
3.0	30 NE, C 30 LE	3.0	1987.09 - 1993.09		4255.92D
3.0 24V	C 30 SE	3.0	1989.09 - 1993.09		4255.92D
3.0 i	30 E, C 30 NE	3.0	1984.09 - 1993.09		4255.92D

VAUXHALL

 Motor
Engine
Moteur

 Ltr.
Ltr.
Ltr.

 Jahr
Year
Année

 Einschränkung
Restriction*
Restriction*

 Thermostat
Thermostat
Thermostat

SIGNUM

1.8	Z 18 XE	1.8	2003.06 - 2005.07		411578.92D ▲
1.8	Z 18 XER	1.8	2005.08 - 2008.05		4431.105D
1.9 CDTI	Z 19 DT	1.9	2004.04 - 2008.03		410049.88D
1.9 CDTI 16V	Z 19 DTH	1.9	2004.04 - 2008.03		410049.88D
1.9 Turbo	Z 19 DTL	1.9	2005.01 - 2008.05		410049.88D
2.0 DTI	Y 20 DTH	2.0	2003.05 - 2008.05		4297.92D
2.0 i Turbo	Z 20 NET	2.0	2002.01 - 2008.10		411193.82D
2.2 DTI	Y 22 DTR	2.2	2003.05 - 2008.05		4297.92D
2.2 i	Z 22 YH	2.2	2003.05 - 2008.05		411193.82D
3.2 V6	Z 32 SE	3.2	2003.05 - 2008.05		4175.92D

SINTRA

2.2 i 16 V	X 22 XE	2.2	1996.11 - 1999.04		4183.92D
3.0 i 24V	X 30 XE	3.0	1996.11 - 1999.04		4175.92D

SPEEDSTER

VXR20	Z 20 LET	2.0	2001.03 - 2006.09		4183.92D
-------	----------	-----	-------------------	--	----------

TIGRA Mk I (F07)

1.4 16V	X 14 XE	1.4	1994.07 - 2000.12		4178.92D
1.6 16V	X 16 XE	1.6	1994.07 - 2000.12		4178.92D

TIGRA TwinTop

1.3 CDTI	Z 13 DT	1.3	2004.06 - 2009.08		410588.88D
1.4	Z 14 XEP	1.4	2004.06 - 2009.08		4178.92D
1.8	Z 18 XE	1.8	2004.06 - 2009.08		411578.92D ▲

VECTRA

1.6 i	X 16 SZR	1.6	1995.08 - 2002.03		3017.92D2
1.6 i 16V	X 16 XEL	1.6	1995.08 - 2002.03		4178.92D
1.6 i 16V	Y 16 XE, Z 16 XE	1.6	1995.08 - 2002.03		4242.92D
1.7 TD	X 17 DT (TC4EE1)	1.7	1995.10 - 1997.12		3467.85D
1.8 i 16V	X 18 XE	1.8	1995.10 - 2000.09		4183.92D
2.0 DI 16V	X 20 DTL	2.0	1995.08 - 2001.10		4188.92D
2.0 DTI 16V	Y 20 DTH, X 20 DTH	2.0	1995.08 - 2001.10		4201.92D
2.0 i	20 NEJ	2.0	1995.10 - 2002.03		4144.92D
2.0 i 16V	X 20 XEV	2.0	1995.10 - 2001.01		4183.92D
2.2 DTI 16V	Y 22 DTR	2.2	1995.08 - 2001.10		4201.92D
2.2 i 16V	Z 22 SE	2.2	1995.08 - 2003.07		411193.82D
2.5 i GSi	X 25 XE	2.5	1998.03 - 2000.07		4175.92D
2.5 i V6	X 25 XE	2.5	1995.09 - 2000.08		4175.92D
2.6 i V6	Y 26 SE	2.6	2000.09 - 2003.07	Motor no. →11162841 →17080724	4175.92D

VECTRA Mk II

1.6	Z 16 XEP	1.6	2006.01 - 2008.07		4431.105D
1.6 16V	Z 16 XE	1.6	2004.06 - 2008.07		4242.92D
1.8	Z 18 XEL	1.8	2002.04 - 2008.07		411578.92D ▲
1.8	Z 18 XER	1.8	2006.01 - 2008.07		4431.105D
1.8 16V	Z 18 XE	1.8	2002.04 - 2008.07		411578.92D ▲
1.8 16V Dualfuel	Z 18 XE	1.8	2002.04 - 2008.07		411578.92D ▲
1.9 CDTI	Z 19 DT, Z 19 DTL	1.9	2002.04 - 2008.09		410049.88D

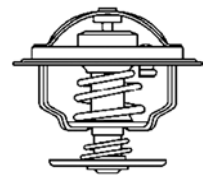

VAUXHALL

	Motor Engine Moteur	Ltr. Ltr. Ltr.	Jahr Year Année	Einschränkung Restriction* Restriction*	Thermostat Thermostat Thermostat
1.9 CDTI 16V	Z 19 DTH	1.9	2004.04 - 2008.08		410049.88D
2.0 16V Turbo	Z 20 NET	2.0	2000.01 - 2008.10		411193.82D
2.0 DTI 16V	Y 20 DTH	2.0	2002.04 - 2008.10		4297.92D
2.2 16V	Z 22 SE	2.2	2002.01 - 2008.10		411193.82D
2.2 direct	Z 22 YH	2.2	2002.01 - 2008.10		411193.82D
2.2 DTI 16V	Y 22 DTR	2.2	2002.04 - 2008.10		4297.92D
3.2 V6	Z 32 SE	3.2	2002.08 - 2008.07		4175.92D
VIVARO					
1.9 DI	F9Q 762	1.9	2001.08 - 2006.12	Chassis No. →1Y799999 →1V699999	410517.89D
1.9 DI	F9Q 762	1.9	2001.09 - 2006.12	Chassis No. 2Y700001→ 2V600001→	410517.83D
1.9 DTI	F9Q 760	1.9	2001.08 - 2006.12		410517.83D
2.0 16V	F4R 720	2.0	2001.08 - 2006.07	Deckel Thermostatgehäuse	126104 ▲
2.0 16V	F4R 720	2.0	2001.08 - 2006.07		3466.89D
2.0 CDTI	M9R	2.0	2006.01 -		411476.83D ▲
2.0 ECOTEC	F4R 820	2.0	2006.08 -		3466.89D
VX 220					
2.0 i Turbo	Z 20 LET	2.0	2001.03 - 2004.04		4183.92D
2.2 i	Z 22 SE	2.2	2000.09 - 2005.07		411193.82D
ZAFIRA Mk I (A)					
1.6 16V	Z 16 XE, X 16 XEL	1.6	1999.04 - 2005.08		4208.92D
1.6 CNG	Z 16 YNG	1.6	2001.09 - 2005.06		4242.92D
1.8 16V	X 18 XE1, Z 18 XE	1.8	1999.05 - 2005.08		411578.92D ▲
1.8 Dualfuel	Z 18 XE	1.8	2000.09 - 2005.08		411578.92D ▲
2.0	Z 20 LET	2.0	2002.06 - 2005.06		4183.92D
2.0 DI 16V	X 20 DTL	2.0	1999.10 - 2005.08		4198.92D
2.0 DTI 16V	Y 20 DTH	2.0	1999.04 - 2005.08	Motor no. →17B49754, → 2(2/5/6/8/B/H) 999999	4428.92D
2.0 DTI 16V	Y 20 DTH	2.0	1999.05 - 2005.08	Motor no. 17B49755→, 3(2/5/6/8/B/H) 999999 →	4428.92D
2.0 GSI Turbo	Z 20 LET	2.0	2001.09 - 2005.06		4183.92D
2.2 16V	Z 22 SE	2.2	1998.11 - 2004.08		411193.82D
2.2 D	Y 22 DTR	2.2	2001.06 - 2005.06		4433.92D
ZAFIRA Mk II (B)					
1.6	A 16 XER, Z 16 XE1, Z 16 XEP, Z 16 XER	1.6	2005.07 -		4431.105D
1.6 CNG	Z 16 YNG	1.6	2005.07 -		4242.92D
1.8	Z 18 XER, A 18 XER	1.8	2005.04 -		4431.105D
1.9 CDTI	Z 19 DT, Z 19 DTH, Z 19 DTL	1.9	2005.07 -		410049.88D
2.0	Z 20 LEH, Z 20 LER	2.0	2005.07 -		4183.92D
2.2	Z 22 YH	2.2	2005.07 -		411193.82D
ZAFIRA Mk III (P12)					
1.6 CNG	A 16 XNT	1.6	2011.10 -		411059.105D ▲
1.8	A 18 XER, A 18 XEL	1.8	2011.10 -		411059.105D ▲

VOLKSWAGEN

 Motor
Engine
Moteur

 Ltr.
Ltr.
Ltr.

 Jahr
Year
Année

 Einschränkung
Restriction*
Restriction*

 Thermostat
Thermostat
Thermostat

BEETLE (9C1, 1C1)

1.4	BCA	1.4	2001.11 -	mit Gehäuse	410475.87D
1.6	AWH ,AYD, BFS	1.6	1999.10 -		3141.87D
1.8 T	AWV, APH, AVC, AGU, AWU, BKF, AWP, BNU	1.8	1999.10 -		3141.87D
1.9 TDI	ALH, BEW, ATD, BSW	1.9	1998.01 - 2004.06		4264.87D
2.0	APK, AZJ, AVH, AQY, AEG, BEV, BHP, BER, AZG, CBPA, BEJ	2.0	1998.01 -		3141.87D
2.3 V5	AQN	2.3	2000.10 -		4123.80D
2.5	BPS, BPR	2.5	2005.07 -		4488.80D0

BEETLE Cabriolet (1Y7)

1.4	BCA	1.4	2003.01 - 2010.09	mit Gehäuse	410475.87D
1.6	BFS	1.6	2003.01 - 2010.09		3141.87D
1.8 T	AWV, AWU, BKF	1.8	2003.01 - 2010.09		3141.87D
1.9 TDI	AXR, BSW	1.9	2003.06 - 2010.09		4264.87D
2.0	AZJ, BEV, BDC, BGD	2.0	2002.09 - 2010.10		3141.87D
2.5	BPS, BPR	2.5	2005.07 - 2010.09		4488.80D0

BEETLE (5C1)

1.6 TDI	CAYC	1.6	2011.10 -		410845.92D
2.0 TDI	CFFB, CJAA	2.0	2011.04 -		410845.87D
2.5	CCCA, CBUA, CBTA	2.5	2011.04 -		4488.80D0

BEETLE Cabriolet (5C7)

1.6 TDI	CAYC	1.6	2012.12 -		410845.92D
2.0 TDI	CFFB	2.0	2012.12 -		410845.87D

BORA

1.4 16V	AHW, AXP, BCA, APE, AKQ	1.4	2000.03 - 2005.05	mit Gehäuse	410989.87D
1.6	AEH, AKL	1.6	1998.10 - 2005.05		3141.87D
1.6 16V	AUS, ATN, BCB, AZD	1.6	2000.02 - 2005.05	mit Gehäuse	410989.87D
1.8	AGN	1.8	1999.02 - 2005.05		3141.87D
1.8 T	AGU, AUM	1.8	2000.05 - 2005.05		3141.87D
1.8 T	AUQ	1.8	2002.03 - 2005.05		3141.87D
1.9 SDI	AGP, AQM	1.9	1998.10 - 2005.05		4264.87D
1.9 TDI	AGR, ALH, AHF, ASV, AJM, AUY, ASZ, AXR, ATD	1.9	1998.10 - 2005.05		4264.87D
2.0	APK, AZH, AZJ, AQY, AZG, BBW	2.0	1998.10 - 2005.05		3141.87D
2.3 V5	AGZ, AQN	2.3	1998.10 - 2000.10	Chassis No. →1J-X-800 000	4264.87D
2.3 V5	AGZ, AQN	2.3	1998.11 - 2000.10	Chassis No. 1J-Y-000 001→ 1J-2-799 999	4123.80D
2.3 V5	AGZ, AQN	2.3	1998.12 - 2005.05	Chassis No. 1J-3-000 001→	4455.80D
2.8 V6	AQP, AUE, BDE	2.8	1999.03 - 2005.05	Chassis No. →1J-2-799 999	4123.80D
2.8 V6	AQP, AUE, BDE	2.8	1999.04 - 2005.05	Chassis No. 1J-3-000 001→	4455.80D

CADDY I

1.5	JB	1.5	1982.08 - 1983.07		4264.87D
1.6	EM, EW	1.6	1982.10 - 1983.10		4264.87D
1.6 D	JK, ME	1.6	1982.08 - 1992.07		4253.87D
1.8	JH	1.8	1985.08 - 1992.07		4264.87D

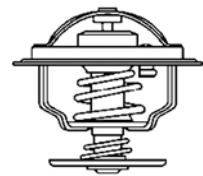
VOLKSWAGEN

	Motor Engine Moteur	Ltr. Ltr. Ltr.	Jahr Year Année	Einschränkung Restriction* Restriction*	Thermostat Thermostat Thermostat
CADDY II (9K9)					
1.4	AUA, AEX, AKV, APQ, AUD	1.4	1995.11 - 2004.01	mit Gehäuse	410989.87D
1.4 16V	AUA	1.4	2000.08 - 2004.01	mit Gehäuse	410989.87D
1.6	1F	1.6	1995.11 - 1997.05		4264.87D
1.6	AEE	1.6	1997.06 - 2000.09	mit Gehäuse	410989.87D
1.7 SDI	AHB	1.7	1996.07 - 2000.09		4264.87D
1.9 D	1Y	1.9	1995.11 - 2004.01		4264.87D
1.9 SDI	AYQ, AEY	1.9	1995.11 - 2004.01		4264.87D
1.9 TDI	1Z, AHU, ALH, ALE	1.9	1996.09 - 2004.01		4264.87D
60 1.4	AEX, APQ, AUD	1.4	1995.11 - 2004.01	mit Gehäuse	410989.87D
75 1.6	AEE	1.6	1995.11 - 2000.09	mit Gehäuse	410989.87D
75 1.6	1F	1.6	1995.11 - 1997.05		4264.87D
CADDY II Pick-up (9U7)					
1.6	AEE	1.6	1996.06 - 2000.12	mit Gehäuse	410989.87D
1.9 D	AEF	1.9	1996.06 - 2000.12		4264.87D
CADDY III (2KB, 2KJ)					
1.4	BCA	1.4	2004.03 - 2006.05	mit Gehäuse	410475.87D
1.4 16V	BUD	1.4	2006.05 - 2010.08		3143.87D
1.6	BGU, BSF, BSE	1.6	2004.04 -		3141.87D
1.6 BiFuel	CHGA	1.6	2011.05 -		3141.87D
1.6 TDI	CAYD, CAYE	1.6	2010.08 -		410845.92D
1.9 TDI	BJB	1.9	2004.04 - 2010.08		4264.87D
1.9 TDI	BLS, BSU	1.9	2004.04 - 2010.08		4820.87D
2.0 EcoFuel	BSX	2.0	2006.04 -		3141.87D
2.0 SDI	BST, BDJ	2.0	2004.03 - 2010.08		4264.87D
2.0 TDI	BMM	2.0	2007.09 - 2010.08		4820.87D
2.0 TDI	CLCA, CFHF, CFJA	2.0	2010.08 -		410845.87D
2.0 TDI 16V	CFHC, CLCB	2.0	2010.11 -		410845.87D
CADDY III (2C, 2K, 2KH, 2CA, 2CH)					
1.4	BCA	1.4	2004.03 - 2006.05	mit Gehäuse	410475.87D
1.4 16V	BUD	1.4	2006.05 - 2010.08	mit Gehäuse	410475.87D
1.6	BGU, BSF, BSE	1.6	2004.04 -		3141.87D
1.6 BiFuel	CHGA	1.6	2011.05 -		3141.87D
1.6 TDI	CAYD, CAYE	1.6	2010.08 -		410845.92D
1.9 TDI	BJB	1.9	2004.04 - 2010.08		4264.87D
1.9 TDI	BLS, BSU	1.9	2004.04 - 2010.08		4820.87D
2.0 EcoFuel	BSX	2.0	2006.04 -		3141.87D
2.0 SDI	BST, BDJ	2.0	2004.03 - 2010.08		4264.87D
2.0 TDI	BMM	2.0	2007.09 - 2010.08		4820.87D
2.0 TDI	CLCA, CFHE, CFHF, CFJA	2.0	2010.08 -		410845.87D
2.0 TDI 16V	CFHC, CLCB	2.0	2010.11 -		410845.87D
CC (358)					
2.0 TDI	CFFA, CFFB, CFGB, CFGC, CLLA	2.0	2011.11 -		410845.87D
CORRADO					
1.8 16V	KR	1.8	1989.04 - 1992.07		4264.87D
1.8 G60	PG	1.8	1988.09 - 1993.09		4264.87D
2.0 i	ADY, 2E	2.0	1993.04 - 1995.12		4264.87D
2.0 i 16V	9A	2.0	1991.08 - 1995.12		4264.87D
2.9 VR6	ABV	2.9	1991.08 - 1995.12		4123.80D

VOLKSWAGEN

 Motor
Engine
Moteur

 Ltr.
Ltr.
Ltr.

 Jahr
Year
Année

 Einschränkung
Restriction*
Restriction*

 Thermostat
Thermostat
Thermostat

CRAFTER

2.5 TDI	BJJ, BJK, BJL, BJM, CEBA, CEBB, CECA, CECB	2.5	2006.04 -		4116.87D1
---------	--	-----	-----------	--	-----------

DERBY (86, 86C, 80)

0.9	HA	0.9	1977.02 - 1981.09		3091.92D
1.0	HZ	1.0	1981.08 - 1984.12		4264.84D
1.0	GL	1.0	1981.10 - 1984.12		3091.92D
1.1	HB	1.1	1977.02 - 1983.07		3091.92D
1.3	GK, HH, HJ, HK, HW	1.3	1977.02 - 1984.12		3091.92D

EOS

2.0 FSI	BVZ, BVY	2.0	2006.03 - 2008.05		411186.87D
2.0 TDI	BMM	2.0	2006.06 - 2008.05		4820.87D
2.0 TDI	CFFA	2.0	2010.11 -		410845.87D
2.0 TDI 16V	CBAB	2.0	2008.05 - 2009.07		3472.87D
2.0 TDI 16V	CFFB	2.0	2008.05 -		410845.87D
2.0 TFSI	BPY, BWA	2.0	2006.03 -		411187.87D
3.2 V6	CBRA, BUB	3.2	2006.06 - 2009.05		4455.80D

FOX (5Z1, 5Z3)

1.4	BKR	1.4	2005.04 -	mit Gehäuse	410475.87D
1.4 TDI	BNM	1.4	2005.04 -		4264.87D
1.9 D	ASY	1.9	2007.12 -		4264.87D
GOL	1.6 Rally	BJF	1.6	2003.08 - 2005.01	4256.80D
1.6 Rally	BJF	1.6	2003.08 - 2005.01		4264.87D
1.8	UDH	1.8	2002.06 - 2008.05		4264.87D

GOLF I (17)

1.1	FA, FJ, GG, HC	1.1	1974.04 - 1983.07		3091.92D
1.3	GF, GS	1.3	1979.08 - 1983.12		3091.92D
1.5	FH	1.5	1974.04 - 1975.12		4256.80D
1.5	JB	1.5	1977.08 - 1983.07		4264.87D
1.5 D	CK	1.5	1976.08 - 1980.07		4256.80D
1.6	EM, FN, FP, FT	1.6	1975.08 - 1984.02		4256.80D
1.6	EW, HN	1.6	1983.01 - 1984.02		4264.87D
1.6 D	JK, CR	1.6	1980.08 - 1983.07		4264.87D
1.6 GTI	EG	1.6	1976.08 - 1982.07		4256.80D
1.6 TD	CY	1.6	1982.03 - 1983.07		4264.87D
1.8 GTI	JJ, DX	1.8	1982.08 - 1983.12		4264.87D

GOLF I Cabriolet (155)

1.3	HK	1.3	1983.08 - 1986.07		3091.92D
1.5	JB	1.5	1979.01 - 1983.11		4264.87D
1.6	EG, EW, HN, RE	1.6	1979.08 - 1982.07		4264.87D
1.8	2H, EV, EX, PB, DX, JH	1.8	1982.08 - 1993.04		4264.87D

GOLF II (19E, 1G1)

1.0	GN	1.0	1983.11 - 1985.08		3091.92D
1.0	HZ	1.0	1985.08 - 1991.10		4264.84D
1.3	GT, HK	1.3	1983.08 - 1987.06		3091.92D
1.3	2G, MH, NU, NZ	1.3	1983.08 - 1992.12		4264.84D
1.6	HM, ABN, EZ, PN, RF	1.6	1983.08 - 1992.12		4264.87D
1.6 D	ME, JP	1.6	1983.08 - 1991.10		4264.87D

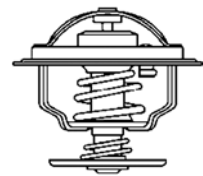
VOLKSWAGEN

	Motor Engine Moteur	Ltr. Ltr. Ltr.	Jahr Year Année	Einschränkung Restriction* Restriction*	Thermostat Thermostat Thermostat
1.6 TD	1V, JR, MF, RA, SB	1.6	1983.08 - 1991.10		4264.87D
1.8	1P, GX, GU, HV, RH	1.8	1984.08 - 1991.10		4264.87D
1.8 GTI	EV, GZ, PB, DX, HT, RD, RV, PF	1.8	1983.08 - 1991.10		4264.87D
1.8 GTI 16V	KR, PL	1.8	1986.02 - 1991.10		4264.87D
1.8 GTI G60	PG, 1H	1.8	1988.08 - 1991.12		4264.87D
1.8 i	GX, RP	1.8	1987.08 - 1991.10		4264.87D
2.0		2.0	1985.08 - 1992.07		4264.87D
GOLF III (1H1, 1H5)					
1.3	2G	1.3	1991.08 - 1992.07		4264.87D
1.4	AEX	1.4	1991.10 - 1999.04	mit Gehäuse	410989.87D
1.4	ABD	1.4	1991.10 - 1999.04		4264.84D
1.6	AEE	1.6	1992.09 - 1997.08	mit Gehäuse	410989.87D
1.6	ABU, AEA	1.6	1992.09 - 1997.08		4264.84D
1.6	AEK, AFT, AKS	1.6	1994.07 - 1999.04		4264.87D
1.8	AAM, ABS, ACC, ADZ, ANN, ANP	1.8	1991.11 - 1999.04		4264.87D
1.9 D	1Y	1.9	1991.11 - 1999.04		4253.87D
1.9 GTD	AAZ	1.9	1991.11 - 1997.08		4253.87D
1.9 SDI	AEY	1.9	1995.07 - 1999.04		4253.87D
1.9 TD	AAZ	1.9	1993.07 - 1999.04		4253.87D
1.9 TDI	ALE, 1Z, AHU, AFN	1.9	1993.09 - 1999.04		4253.87D
2.0	ABA, ADY, AKR, 2E, AGG, AEP	2.0	1991.11 - 1999.04		4264.87D
2.0 GTI 16V	ABF	2.0	1992.08 - 1997.08		4264.84D
2.8 VR6	AAA	2.8	1992.01 - 1997.09		4123.80D
2.9 VR6	ABV	2.9	1994.10 - 1999.04		4123.80D
GOLF III Cabriolet (1E7)					
1.6	AEK, AFT, AKS	1.6	1994.10 - 1998.05		4264.87D
1.8	AAM, ADZ, ABS	1.8	1993.07 - 1998.05		4264.87D
1.9 TDI	ALE, 1Z, AHU, AFN	1.9	1995.08 - 1998.05		4253.87D
2.0	ADY, AKR, 2E, AGG	2.0	1993.07 - 1998.05		4264.87D
GOLF IV (1J1, 1J5)					
1.4 16V	AHW, AXP, BCA, APE, AKQ	1.4	1999.05 - 2006.06	mit Gehäuse	410989.87D
1.6	AKL, APF, AEH	1.6	1997.08 - 2004.05		3141.87D
1.6 16V	AUS, ATN, BCB, AZD	1.6	2000.02 - 2006.06	mit Gehäuse	410989.87D
1.8	AGN	1.8	1997.08 - 2005.06		3141.87D
1.8 T	ARZ, AQA, AGU, AUM, AWD	1.8	1997.08 - 2006.06		3141.87D
1.8 T GTI	AUQ	1.8	2001.08 - 2005.06		3141.87D
1.9 SDI	AGP, AQM	1.9	1997.08 - 2006.06		4264.87D
1.9 TD	AAZ	1.9	1997.10 - 1999.09		4253.87D
1.9 TDI	AGR, ALH, AHF, ASV, AJM, AUJ, AXR, ATD, ASZ, ARL	1.9	1997.08 - 2006.06		4264.87D
2.0	APK, AZJ, AQY, AZG, AZH	2.0	1998.07 - 2006.06		3141.87D
2.0 Bi-Fuel	BEH	2.0	2002.02 - 2006.06		3141.87D
2.3 V5	AGZ, AQN	2.3	1997.08 - 2006.06	Chassis No. →1J-X-800 000	4264.87D
2.3 V5	AGZ, AQN	2.3	1997.09 - 2006.06	Chassis No. 1J-Y-000 001→ 1J-2-799 999	4123.80D
2.3 V5	AGZ, AQN	2.3	1997.10 - 2006.06	Chassis No. 1J-3-000 001→	4455.80D
2.8 V6	AQP, AUE, BDE	2.8	1999.03 - 2006.06	Chassis No. →1J-2-799 999	4123.80D
2.8 V6	AQP, AUE, BDE	2.8	1999.04 - 2006.06	Chassis No. 1J-3-000 001→	4455.80D
3.2 R32	BFH, BML	3.2	2002.09 - 2005.06		4455.80D

VOLKSWAGEN

 Motor
Engine
Moteur

 Ltr.
Ltr.
Ltr.

 Jahr
Year
Année

 Einschränkung
Restriction*
Restriction*

 Thermostat
Thermostat
Thermostat

GOLF IV Cabriolet (1E7)

1.6	AFT, AKS	1.6	1998.06 - 2002.06		4264.87D
1.8	ADZ, ANP, ANN, AAM	1.8	1998.06 - 2002.06		4264.87D
1.9 TDI	ALE, AHU, AVG, AFN	1.9	1998.06 - 2002.06		4264.87D
2.0	ATU, AKR, AWF, AGG, AWG	2.0	1998.06 - 2002.06		4264.87D

GOLF V / PLUS

1.4	BUD	1.4	2007.06 -	mit Gehäuse	410475.87D
1.4 16V	BCA	1.4	2003.10 - 2006.05	mit Gehäuse	410989.87D
1.4 16V	BUD, CGGA	1.4	2006.05 -	mit Gehäuse	410475.87D
1.6	BGU, BSF, BSE, CCSA, CMXA	1.6	2004.01 -		3141.87D
1.6 BiFuel	CHGA	1.6	2009.05 -		3141.87D
1.6 MultiFuel	CCSA, CMXA	1.6	2007.11 -		3141.87D
1.6 TDI	CAYB, CAYC	1.6	2009.02 - 2010.05	mit Gehäuse	410536.92D
1.6 TDI	CAYB, CAYC	1.6	2009.02 - 2010.05	ohne Gehäuse	410537.92D
1.6 TDI	CAYB, CAYC	1.6	2010.06 -		410845.92D
1.9 TDI	BLS, BXJ	1.9	2003.10 -		4820.87D
1.9 TDI	BKC, BXE, BRU, BXF	1.9	2004.05 -		4264.87D
2.0	BWA, CAWB, CCTA	2.0	2007.06 -		411187.87D
2.0 FSI	BVY, BVZ	2.0	2004.01 - 2008.11		411186.87D
2.0 GTI	BWA, BPY, AXX, CBFA, CAWB, CCTA	2.0	2004.10 - 2009.02		411187.87D
2.0 SDI	BDK	2.0	2004.01 - 2008.11		4264.87D
2.0 TDI	AZV, BMN	2.0	2003.10 -		3472.87D
2.0 TDI	BMM	2.0	2004.08 - 2009.05		4820.87D
2.0 TDI	CBDA, CBDC	2.0	2005.05 - 2009.07		3472.87D
2.0 TDI	CFHB, CLCA	2.0	2005.05 -		410845.87D
2.0 TDI	BEE	2.0	2005.05 - 2007.05		4820.87D
2.0 TDI 16V	CBDB, BKD	2.0	2003.10 -		3472.87D
2.0 TDI 16V	CFHC	2.0	2005.01 - 2009.07		410845.87D
3.2 R32	CBRA, BUB	3.2	2005.11 - 2008.11		4455.80D

GOLF VI

1.4	BUD, CGGA	1.4	2008.10 -	mit Gehäuse	410475.87D
1.6	CCSA, BSF, CMXA, BSE	1.6	2008.10 - 2012.11		3141.87D
1.6 BiFuel	CHGA	1.6	2009.03 - 2012.11		3141.87D
1.6 MultiFuel	CCSA, CMXA	1.6	2008.10 - 2012.11		3141.87D
1.6 TDI	CAYC, CAYB	1.6	2009.02 - 2010.05	mit Gehäuse	410536.92D
1.6 TDI	CAYC, CAYB	1.6	2009.02 - 2010.05	ohne Gehäuse	410537.92D
1.6 TDI	CAYC, CAYB	1.6	2010.06 - 2012.11		410845.92D
2.0 TDI	CBAA, CBAB, CBBB, CBDC	2.0	2008.10 - 2009.07		3472.87D
2.0 TDI	CFFA, CFFB, CFGB, CFHB, CLCA	2.0	2008.11 - 2013.05		410845.87D
2.0 TDI	BMM	2.0	2009.07 - 2013.05		4820.87D
2.0 TDI 16V	CJAA, CBDB, CFHC, CLCB	2.0	2009.07 -		410845.87D

GOLF VI Cabriolet (517)

1.6 TDI	CAYC	1.6	2011.03 -		410845.92D
2.0 TDI	CFHC	2.0	2011.11 -		410845.92D

ILTIS

1.6 TD	1C	1.6	1987.08 - 1988.12		4253.87D
1.7	YX, WL	1.7	1979.03 - 1988.12		4264.87D

VOLKSWAGEN

	Motor Engine Moteur	Ltr. Ltr. Ltr.	Jahr Year Année	Einschränkung Restriction* Restriction*	Thermostat Thermostat Thermostat
JETTA I (16)					
1.1	GG, FA	1.1	1978.08 - 1984.02		3091.92D
1.3	GF, GS	1.3	1979.08 - 1984.02		3091.92D
1.5	JB	1.5	1978.08 - 1984.02		4264.87D
1.5 D	CK	1.5	1978.08 - 1980.07		4264.87D
1.6	EM, EW, FR	1.6	1978.08 - 1983.07		4256.80D
1.6 D	JK, CR	1.6	1980.08 - 1984.02		4264.87D
1.6 GLI	EG	1.6	1978.08 - 1982.07		4264.87D
1.6 TD	CY	1.6	1982.03 - 1984.02		4264.87D
1.8	JJ, DX	1.8	1982.08 - 1984.02		4264.87D
JETTA II (19E, 1G2, 165)					
1.3	GT, HK	1.3	1984.01 - 1987.06		3091.92D
1.3	2G, MH, NZ	1.3	1984.01 - 1991.12		4264.84D
1.6	HM, ABN, EZ, PN, RF	1.6	1984.01 - 1992.07		4264.87D
1.6 D	ME, JP	1.6	1984.01 - 1991.10		4264.87D
1.6 TD	1V, JR, MF, RA, SB	1.6	1984.01 - 1991.10		4264.87D
1.8	1P, EV, GZ, PB, GX, GU, HV, RP, PF, RD, RH	1.8	1984.01 - 1991.10		4264.87D
1.8 16V	KR, PL	1.8	1986.08 - 1991.10		4264.87D
JETTA III (1K2)					
1.6	BGU, CCSA, BSF, BSE	1.6	2005.10 - 2010.10		3141.87D
1.6 MultiFuel	CCSA	1.6	2008.01 - 2010.10		3141.87D
1.6 TDI	CAYC	1.6	2009.06 - 2010.05	mit Gehäuse	410536.92D
1.6 TDI	CAYC	1.6	2009.06 - 2010.05	ohne Gehäuse	410537.92D
1.9 TDI	BKC, BXE	1.9	2005.08 - 2010.10		4264.87D
1.9 TDI	BLS	1.9	2005.08 - 2010.10		4820.87D
2.0 FSI	BVY, BVZ	2.0	2005.08 - 2010.10		411186.87D
2.0 TDI	AZV, CBDA	2.0	2005.09 - 2009.07		3472.87D
2.0 TDI	BMM, BMN	2.0	2005.10 - 2010.10		4820.87D
2.0 TDI 16V	CJAA, CBDB, BKD	2.0	2005.08 - 2010.10		3472.87D
2.0 TFSI	BWA, BPY, AXX, CBFA, CCZA, CAWB, CCTA	2.0	2005.10 - 2010.10		411187.87D
2.5 FSI	BTK, BGP, CCCA, CBUA, CBTA	2.5	2006.01 - 2010.10		4488.80D0
JETTA IV (162)					
1.6 TDI	CAYC	1.6	2011.02 -	mit Gehäuse	410536.92D
1.6 TDI	CAYC	1.6	2011.02 -	ohne Gehäuse	410537.92D
2.0 TDI	CFHC, CFFB, CLCA	2.0	2010.10 -		410845.87D
LT 28 - 55					
2.0	CH	2.0	1975.04 - 1983.09		4006.82D
2.3	AGL	2.3	1996.05 - 2006.07		4275.87D
2.4	DL	2.4	1982.12 - 1992.07		4123.80D
2.4 D	1S, ACT, DW	2.4	1978.12 - 1996.06		4123.80D
2.4 i	1E	2.4	1989.08 - 1996.06		4123.80D
2.4 TD	1G, ACL, DV	2.4	1978.08 - 1996.06		4123.80D
2.5 SDI	AGX	2.5	1996.07 - 2006.07		4116.87D1
2.5 TDI	AHD, AVR, ANJ, APA, BBE, BBF	2.5	1996.05 - 2006.07		4116.87D1
2.7 D	CG	2.7	1975.11 - 1980.01		4006.82D
2.8 TDI	AGK, ATA, BCQ, AUH	2.8	1997.06 - 2006.07		3145.79D

VOLKSWAGEN

 Motor
Engine
Moteur

 Ltr.
Ltr.
Ltr.

 Jahr
Year
Année

 Einschränkung
Restriction*
Restriction*

 Thermostat
Thermostat
Thermostat

LUPO					
1.0	AER, ALD, ANV, ALL, AUC	1.0	1998.09 - 2005.07	mit Gehäuse	410989.87D
1.2 TDI 3L	AYZ, ANY	1.2	1999.07 - 2005.07		4264.87D
1.4	AUD	1.4	2000.10 - 2005.07	mit Gehäuse	410989.87D
1.4 16V	AHW, APE, BBY, AKQ, AUA, AFK, AUB, AQQ	1.4	1999.08 - 2005.07	mit Gehäuse	410989.87D
1.4 TDI	AMF	1.4	1999.01 - 2005.07		4264.87D
1.6 GTI	AVY	1.6	2000.09 - 2005.07	mit Gehäuse	410475.80D
1.7 SDI	AKU	1.7	1998.09 - 2005.07		4264.87D
MULTIVAN T5					
1.9 TDI	AXC, AXB, BRS	1.9	2003.04 - 2009.11		4264.87D
1.9 TDI	BRR	1.9	2006.01 - 2009.11		3472.87D
2.0	AXA	2.0	2003.11 -		3141.87D
2.5 TDI	AXE, BPC, AXD, BNZ, BLJ	2.5	2003.04 - 2009.11		4430.87D
3.2	BDL	3.2	2003.11 - 2006.06		4455.80D
3.2 V6	BDL, BKK	3.2	2004.02 - 2009.11		4455.80D
PARATI					
1.0	ASW, AZP	1.0	2002.08 -		4264.87D
1.6	BJF, UNF, UPD	1.6	2003.07 -	80° Variante	4256.80D
1.6	BJF, UNF, UPD	1.6	2003.07 -	87° Variante	4264.87D
1.8	UDH	1.8	2002.08 -	80° Variante	4256.80D
1.8	UDH	1.8	2002.08 -	87° Variante	4264.87D
1.9 D	1Y	1.9	2002.08 -		4264.87D
1.9 SDI	BGG	1.9	2002.08 -		4264.87D
2.0	UQG	2.0	2003.07 -		4264.87D
PASSAT (32/33)					
1.3	FY	1.3	1973.05 - 1980.07		3091.92D
1.3	ZF	1.3	1973.05 - 1978.01		4256.80D
1.3	ZA	1.3	1973.05 - 1978.01		4264.87D
1.5	ZB, YJ, ZC	1.5	1973.05 - 1975.12		4256.80D
1.5 D	CK	1.5	1977.02 - 1980.07		4256.80D
1.6	FS, YN, YP	1.6	1975.08 - 1980.07	Chassis No. →328 2300 000	4256.80D
1.6	FS, YN, YP	1.6	1975.09 - 1980.07	Chassis No. 328 2000 001→	4264.87D
1.6 D	CR	1.6	1979.02 - 1980.07		4264.87D
1.6 i	YS	1.6	1978.06 - 1980.07		4264.87D
PASSAT (32B)					
1.3	FY, FZ	1.3	1980.08 - 1986.07		3091.92D
1.3	EP, EU	1.3	1980.08 - 1986.07		4264.87D
1.6	DT, RL, YP, WV, YN	1.6	1980.08 - 1988.03		4264.87D
1.6 D	JK, CR	1.6	1980.08 - 1988.03		4253.87D
1.6 TD	CY, RA	1.6	1982.04 - 1988.03		4253.87D
1.8	DS, JN, JV, DZ, RM	1.8	1983.01 - 1988.03		4264.87D
1.9	WN	1.9	1981.01 - 1983.07		4116.87D1
2.0	JS, HP	2.0	1983.08 - 1988.03		4116.87D1
2.1	WE	2.1	1981.01 - 1983.07		4116.87D1
2.2	JT, KV, KX	2.2	1985.01 - 1988.03		4116.87D1

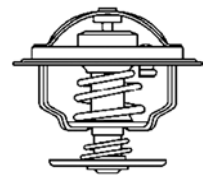

VOLKSWAGEN

	Motor Engine Moteur	Ltr. Ltr. Ltr.	Jahr Year Année	Einschränkung Restriction* Restriction*	Thermostat Thermostat Thermostat
PASSAT (35I, 3A2, 3A5)					
1.6	1F, ABN, EZ, AEK, AFT	1.6	1988.02 - 1996.08		4264.87D
1.6 TD	RA, SB	1.6	1988.08 - 1993.09		4253.87D
1.8	AAM, RP, ADZ, ABS, PF, PB, KR	1.8	1988.02 - 1997.05		4264.87D
1.8 16V	KR	1.8	1988.04 - 1989.12		4264.87D
1.8 G60	PG	1.8	1988.08 - 1997.05		4264.87D
1.9 D	1Y	1.9	1989.05 - 1993.10		4253.87D
1.9 TD	AAZ	1.9	1991.03 - 1997.05		4253.87D
1.9 TDI	1Z, AFN, AHU	1.9	1993.10 - 1997.05		4253.87D
2.0	ABA, ADY, 2E, AGG, AEP	2.0	1988.04 - 1997.05		4264.87D
2.0 16V	9A	2.0	1988.08 - 1993.09		4264.87D
2.0 16V	ABF	2.0	1994.01 - 1997.05		4264.84D
2.8 VR6	AAA	2.8	1991.06 - 1997.05		4123.80D
2.9 VR6	ABV	2.9	1994.01 - 1997.05		4123.80D
PASSAT (3B2, 3B5)					
1.6	AHL, ADP, ARM, ANA	1.6	1996.10 - 2000.11		3141.87D
1.8	ADR, APT, ARG, AFY	1.8	1996.10 - 2000.11		3141.87D
1.8 T	AEB, ANB, APU	1.8	1996.10 - 2000.11		3141.87D
1.9 TDI	AHU, AHH, ATJ, AJM, AVB, AVG, AFN	1.9	1996.10 - 2000.11		4264.87D
2.3 VR5	AGZ	2.3	1996.10 - 2000.11		4264.87D
2.5 TDI	AKN, AFB	2.5	1998.07 - 2000.11		4274.87D
2.8	AGE	2.8	1997.05 - 1999.09	Chassis No. →3B-X-500 000	4274.87D
2.8	AGE	2.8	1997.06 - 1999.09	Chassis No. 3B-X-500 001→	4274.92D
2.8 V6	ACK, ALG, APR, AQD	2.8	1996.08 - 2000.11		4274.87D
2.8 V6	AGE	2.8	1997.05 - 1999.09	Chassis No. →3B-X-500 000	4274.87D
2.8 V6	AGE	2.8	1997.06 - 1999.09	Chassis No. 3B-X-500 001→	4274.92D
2.8 V6	ATX, BBG	2.8	1999.09 - 2000.11		4274.92D
PASSAT (3B3, 3B6)					
1.6	ALZ	1.6	2000.11 - 2005.05		3141.87D
1.8 T	AWM	1.8	2001.02 - 2005.08		3141.87D
1.8 T 20V	AWT	1.8	2000.11 - 2005.05		3141.87D
1.9 TDI	AVB, AWX, AVF	1.9	2000.11 - 2005.05		4264.87D
2.0	AZM	2.0	2000.11 - 2005.05		3141.87D
2.0 TDI	BGW, BHW	2.0	2003.12 - 2005.05		4264.87D
2.3 V5	AZX	2.3	2000.11 - 2005.05		4123.80D
2.3 VR5	AZX	2.3	2000.11 - 2005.05		4123.80D
2.5 TDI	AKN, AFB, BAU, BDH, BDG	2.5	2000.11 - 2005.05		4274.87D
2.8	ATQ, AMX	2.8	2000.11 - 2005.05		4274.92D
PASSAT (3C2, 3C5)					
1.6	BSF, BSE	1.6	2005.05 - 2010.11		3141.87D
1.6 TDI	CAYC	1.6	2009.08 - 2010.11	mit Gehäuse	410536.92D
1.6 TDI	CAYC	1.6	2009.08 - 2010.11	ohne Gehäuse	410537.92D
1.9 TDI	BXE, BKC	1.9	2005.03 - 2008.11		4264.87D
1.9 TDI	BLS	1.9	2005.03 - 2008.11		4820.87D
2.0 BlueTDI	CBAC	2.0	2009.01 - 2009.07		3472.87D
2.0 FSI	BVY, BVZ	2.0	2005.03 - 2010.11		411186.87D
2.0 FSI	AXX, BPY, BWA	2.0	2005.07 - 2010.11		411187.87D
2.0 FSI	BLX, BVX	2.0	2005.09 - 2010.11	Chassis No. 3C-6-160 001→	411186.87D

VOLKSWAGEN

 Motor
Engine
Moteur

 Ltr.
Ltr.
Ltr.

 Jahr
Year
Année

 Einschränkung
Restriction*
Restriction*

 Thermostat
Thermostat
Thermostat

2.0 TDI	BMA, BUZ, BVE, BWV, CBBB, BMR	2.0	2005.03 - 2010.11		3472.87D
2.0 TDI	CBAA, CBDC	2.0	2005.03 - 2009.07		3472.87D
2.0 TDI	BMP	2.0	2005.03 -		4820.87D
2.0 TDI 16V	CBAB	2.0	2005.03 - 2009.07		3472.87D
2.0 TDI 16V	BKP	2.0	2005.03 -		3472.87D

PASSAT (362, 365)

1.6 TDI	CAYC	1.6	2010.08 - 2010.11	mit Gehäuse	410536.92D
1.6 TDI	CAYC	1.6	2010.08 - 2010.11	ohne Gehäuse	410537.92D
1.6 TDI	CAYC	1.6	2010.12 -		410845.92D
2.0 TDI	CFFA, CFFB, CFGB, CFGC, CLLA	2.0	2010.08 -		410845.87D

PASSAT CC

2.0 BlueTDI	CBAC	2.0	2009.05 - 2010.11		3472.87D
2.0 TDI	CBAA, CBAB, CBBB	2.0	2008.06 - 2009.07		3472.87D
2.0 TDI	CFFA, CFFB, CFGB	2.0	2008.06 -		410845.87D

PHAETON

3.2 V6	AYT, BKL, BRK	3.2	2002.04 -		4455.80D
5.0 V10 TDI	AJS	5.0	2002.11 -		4572.105D

POLO (80, 86, 86C) 1975→1994

0.8	HE	0.8	1975.09 - 1981.09		3091.92D
0.9	HA	0.9	1975.09 - 1981.12		3091.92D
1.0	GL	1.0	1981.10 - 1986.10		3091.92D
1.0	AAU, AAK, ACM, HZ	1.0	1981.10 - 1994.09		4264.84D
1.1	HB, HC	1.1	1975.03 - 1989.09		3091.92D
1.3	GT, GK, HJ, HK, HH, HW	1.3	1976.12 - 1988.07		3091.92D
1.3	2G, 3F, AAV, NZ, MH	1.3	1983.08 - 1994.09		4264.84D
1.3 D	MN	1.3	1986.08 - 1990.08		4264.84D
1.3 G40	PY	1.3	1987.01 - 1994.09		4264.84D
1.4 D	1W	1.4	1990.08 - 1994.09		4264.84D

POLO (6N_) 1994→1999

1.0	AAU	1.0	1994.10 - 1999.12		4264.84D
1.4	AEX, APQ	1.4	1998.05 - 1999.12	mit Gehäuse	410989.87D
1.6	AEA	1.6	1994.09 - 1995.12		4264.87D
1.7 SDI	AHG, AKU	1.7	1997.04 - 1999.12		4264.87D
1.9 D	AEF	1.9	1994.10 - 1999.12		4264.87D
1.9 SDI	AGD	1.9	1996.07 - 1999.12		4264.87D
100 1.4 16V	AFH	1.4	1996.04 - 1999.10	mit Gehäuse	410989.87D
120 1.6 16V GTI	AJV	1.6	1998.09 - 1999.10	mit Gehäuse	410989.80D
45 1.0	AEV	1.0	1994.10 - 1996.09		4253.87D
50 1.0	AER, ALL	1.0	1996.09 - 1999.10	mit Gehäuse	410989.87D
55 1.3	ADX	1.3	1994.10 - 1995.07		4253.87D
55 1.4	AEX	1.4	1995.08 - 1999.10	mit Gehäuse	410989.87D
60 1.4	AEX, AKV, APQ	1.4	1995.07 - 1999.10	mit Gehäuse	410989.87D
60 1.7 SDI	AKU	1.7	1997.08 - 1999.10		4264.87D
64 1.9 D	AEF	1.9	1994.10 - 1999.10		4264.87D
64 1.9 SDI	AGD	1.9	1996.07 - 1999.10		4264.87D
75 1.6	AEE, AHS	1.6	1994.10 - 1999.10	mit Gehäuse	410989.87D
75 1.6	AEA	1.6	1994.10 - 1999.10		4264.87D

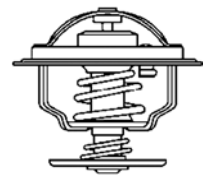
VOLKSWAGEN

	Motor Engine Moteur	Ltr. Ltr. Ltr.	Jahr Year Année	Einschränkung Restriction* Restriction*	Thermostat Thermostat Thermostat
POLO (6KV2, 6KV5, 6N2) 1999→2002					
1.0	ALD, AUC	1.0	1999.10 - 2001.09	mit Gehäuse	410989.87D
1.4	AEX, AKV, ANW, AKK, APQ, AUD, ANX, AKP	1.4	1997.05 - 2001.09	mit Gehäuse	410989.87D
1.4 16V	AFK, AUB, AQQ, AHW, APE, AUA	1.4	1999.10 - 2001.09	mit Gehäuse	410989.87D
1.4 TDI	AMF	1.4	1999.10 - 2001.09		4264.87D
1.6	AEH, AKL, APF, AUR	1.6	1997.05 - 2001.09		3141.87D
1.6	ALM, AEE	1.6	1997.05 - 2001.09	mit Gehäuse	410989.87D
1.6	AFT	1.6	1997.05 - 2001.09		4264.87D
1.6 16V GTI	AVY, ARC	1.6	1999.10 - 2001.09	mit Gehäuse	410989.80D
1.7 SDI	AKU, AKW	1.7	1997.08 - 2001.09		4264.87D
1.8	ADZ	1.8	1997.05 - 2001.09		4264.87D
1.9 D	AEF	1.9	1999.10 - 2001.09		4264.87D
1.9 SDI	AEY, AGP, AQM, ASX, AGD	1.9	1996.06 - 2001.09		4264.87D
1.9 TDI	ALE, AHU, AGR, ALH, AFN, ASV	1.9	1997.05 - 2001.09		4264.87D
100 1.6	AEH, AKL, APF, AUR	1.6	1995.12 - 2001.09		3141.87D
100 1.6	AFT	1.6	1995.12 - 2001.09		4264.87D
110 1.9 TDI	AFN, ASV	1.9	1998.06 - 2002.01		4264.87D
2.0	ADC	2.0	1999.08 - 2001.09		4264.87D
54 1.4	ANX	1.4	1998.01 - 1999.08	mit Gehäuse	410989.87D
57 1.7 SDI	AKW	1.7	1997.07 - 2001.09		4264.87D
60 1.4	AEX, AKV, ANW, AKK, APQ, AUD	1.4	1995.12 - 2001.09	mit Gehäuse	410989.87D
64 1.9 D	1Y	1.9	1996.01 - 1996.10		4264.87D
64 1.9 SDI	AEY	1.9	1995.12 - 1999.08		4264.87D
68 1.9 SDI	AGP, AQM	1.9	1999.08 - 2002.01		4264.87D
75 1.4 16V	APE, AUA	1.4	1999.10 - 2001.09	mit Gehäuse	410989.87D
75 1.6	AEE, ALM	1.6	1995.11 - 2001.09	mit Gehäuse	410989.87D
75 1.6	1F	1.6	1995.11 - 1997.09		4264.87D
90 1.8	ADZ, ADD, ABS	1.8	1997.01 - 2001.09		4264.87D
90 1.9 TDI	ALE, AHU, AGR, ALH	1.9	1996.09 - 2001.09		4264.87D
POLO (9_) 2001→2010				mit Gehäuse	
1.4	BBY, BKY, BBZ	1.4	2003.07 -		410475.87D
1.4 16V	BBY, BKY, BBZ, BUD	1.4	2001.10 - 2009.11	mit Gehäuse	410475.87D
1.4 16V	AUA, AUB	1.4	2001.10 - 2008.05	mit Gehäuse	410989.87D
1.4 TDI	AMF, BAY, BMS, BNV, BNM, BWB	1.4	2001.10 - 2009.11		4264.87D
1.8 GTI	BJX	1.8	2005.09 - 2009.11		3141.87D
1.8 GTi Cup Edition	BBU	1.8	2006.05 - 2009.11		3141.87D
1.9 SDI	ASY	1.9	2001.10 - 2009.11		4264.87D
1.9 TDI	ATD, AXR, ASZ, BLT	1.9	2001.10 - 2009.11		4264.87D
1.9 TDI	BMT	1.9	2001.10 - 2009.11		4820.87D
POLO (6R_) 2009→					
1.4	CGGB	1.4	2009.06 -	mit Gehäuse	410475.87D
1.6 TDI	CAYA, CAYB, CAYC, CLNA	1.6	2009.06 - 2010.05	mit Gehäuse	410536.92D
1.6 TDI	CAYA, CAYB, CAYC, CLNA	1.6	2009.06 - 2010.05	ohne Gehäuse	410537.92D
1.6 TDI	CAYA, CAYB, CAYC, CLNA	1.6	2010.06 -		410845.92D
SANTANA (32B)					
1.3	FZ	1.3	1981.08 - 1983.07		3091.92D
1.3	EP	1.3	1984.08 - 1985.12		4264.87D
1.6	DT, WV, YP	1.6	1981.08 - 1984.12		4264.87D
1.6 D	JK, CR	1.6	1981.08 - 1984.12		4253.87D
1.6 TD	CY	1.6	1981.12 - 1984.12		4253.87D

VOLKSWAGEN

 Motor
Engine
Moteur

 Ltr.
Ltr.
Ltr.

 Jahr
Year
Année

 Einschränkung
Restriction*
Restriction*

 Thermostat
Thermostat
Thermostat

1.8	DS	1.8	1983.01 - 1984.12		4264.87D
1.9	WN	1.9	1981.08 - 1983.07		4116.87D1
2.0	JS, HP	2.0	1983.08 - 1984.12		4116.87D1
2.1	WE	2.1	1982.08 - 1983.12		4116.87D1

SAVEIRO

1.6	BJF	1.6	2002.03 -	80° Variante	4256.80D
1.6	BJF	1.6	2002.03 -	87° Variante	4264.87D
1.6 Flex	BJY	1.6	2002.03 -	80° Variante	4256.80D
1.6 Flex	BJY	1.6	2002.03 -	87° Variante	4264.87D
1.8	UDH	1.8	2002.03 -	80° Variante	4256.80D
1.8	UDH	1.8	2002.03 -	87° Variante	4264.87D
2.0	UQG	2.0	2002.03 -		4264.87D

SCIROCCO (53, 53B)

1.1	FA	1.1	1974.04 - 1979.07		3091.92D
1.3	GF	1.3	1979.08 - 1983.12		3091.92D
1.5	FD, FH	1.5	1974.02 - 1977.12		4256.80D
1.5	JB, ZB, YJ	1.5	1974.02 - 1983.12		4264.87D
1.6	FN, FP, FT	1.6	1975.08 - 1979.07		4256.80D
1.6	EG, EW, EWA, FR, RE	1.6	1975.08 - 1990.07		4264.87D
1.8	EV, EX, JJ, JH, PB, DX	1.8	1985.11 - 1992.07		4264.87D
1.8 16V	KR, PL	1.8	1985.10 - 1992.07		4264.87D

SCIROCCO (137)

2.0 TDI	CFHB, CFGB, CFHC	2.0	2008.08 -		410845.87D
2.0 TDI	CBBB	2.0	2009.05 - 2009.07		3472.87D

SHARAN

1.8 T 20V	AWC, AJH	1.8	1997.09 - 2010.03		3141.87D
1.9 TDI	ANU, 1Z, AHU, AVG, AFN, ASZ, BTB, BVK, AUJ	1.9	1995.09 - 2010.03		4264.87D
2.0	ATM, ADY	2.0	1995.09 - 2010.03		4264.87D
2.0 LPG	ATM	2.0	2006.04 - 2010.03		3141.87D
2.0 TDI	BVH	2.0	2005.11 - 2010.03		3472.87D
2.0 TDI	BRT	2.0	2005.11 - 2010.03		4264.87D
2.8 V6 24V	AYL	2.8	2000.04 - 2010.03	Chassis No. →7M-3-010-000	4123.80D
2.8 V6 24V	AYL	2.8	2000.05 - 2010.03	Chassis No. 7M-3-010-001→	4455.80D
2.8 VR6	AAA, AMY	2.8	1995.09 - 2000.04		4123.80D

SHARAN (7N)

2.0 TDI	CFFA, CFFB, CFFE, CFGB	2.0	2010.05 -		410845.87D
---------	------------------------	-----	-----------	--	------------

TARO

1.8	2Y	1.8	1989.04 - 1994.09		4103.82D
2.2	4Y	2.2	1989.06 - 1994.07		4103.82D
2.4 D	2L	2.4	1991.09 - 1995.04	Chassis No. →7A-S9501 924, →7A-SH001 995	3477.88D

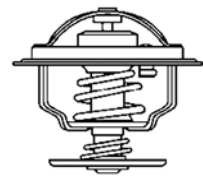
VOLKSWAGEN

	Motor Engine Moteur	Ltr. Ltr. Ltr.	Jahr Year Année	Einschränkung Restriction* Restriction*	Thermostat Thermostat Thermostat
TIGUAN (5N_)					
2.0 TDI	CBAA, CBBA, CBAB, CBBB	2.0	2007.11 - 2009.07		3472.87D
2.0 TDI	CFFA, CFFB, CFFD, CLJA, CFGB	2.0	2010.05 -		410845.87D
TOUAREG					
2.5 R5 TDI	BPE, BAC, BLK, BPD	2.5	2003.01 - 2010.05		4430.87D
3.2 V6	AZZ, BMV, BKJ, BAA, BMX, BRJ	3.2	2002.10 - 2006.11		4455.80D
4.2 V8	AXQ	4.2	2002.12 - 2006.11		4274.82D
5.0 R50 TDI	CBWA	5.0	2007.08 - 2010.05		4572.105D
5.0 V10 TDI	AYH, BLE	5.0	2002.10 - 2010.05		4572.105D
TOURAN (1T1, 1T2)					
1.6	BGU, BSF, BSE	1.6	2003.07 - 2010.05		3141.87D
1.9 TDI	AVQ, BKC, BXE, BRU, BXF	1.9	2003.02 - 2004.05		4264.87D
1.9 TDI	BLS, BXJ	1.9	2003.08 - 2010.05		4820.87D
2.0 EcoFuel	BSX	2.0	2006.02 - 2009.05		3141.87D
2.0 TDI	AZV, BMN	2.0	2003.02 - 2010.05		3472.87D
2.0 TDI	CFJA	2.0	2005.12 - 2010.05		410845.87D
2.0 TDI	BMM	2.0	2005.12 - 2010.05		4820.87D
2.0 TDI 16V	BKD	2.0	2003.08 - 2010.05		3472.87D
TOURAN (1T3)					
1.6 TDI	CAYB	1.6	2010.05 -		410845.92D
2.0 TDI	CFHC, CFJA, CFJB, CLCA, CFHF	2.0	2010.05 -		410845.87D
TRANSPORTER T3					
1.6 D	CS	1.6	1981.01 - 1987.07		4253.87D
1.6 TD	JX	1.6	1984.08 - 1992.07	88° Variante	4253.87D
1.6 TD	JX	1.6	1984.10 - 1992.07	80° Variante	4256.80D
1.7 D	KY	1.7	1985.08 - 1992.07	88° Variante	4253.87D
1.7 D	KY	1.7	1985.08 - 1992.07	80° Variante	4256.80D
1.9	DF, DG, DH, GW	1.9	1982.08 - 1992.07		4155.87D
2.1	DJ, MV, SR	2.1	1985.08 - 1992.07		4155.87D
2.1 i	SS	2.1	1989.07 - 1992.07		4155.87D
TRANSPORTER T4					
1.8	PD	1.8	1990.12 - 1992.07		4253.87D
1.9 D	1X	1.9	1990.07 - 1995.12		4264.87D
1.9 TD	ABL	1.9	1992.10 - 2003.04		4264.87D
2.0	AAC	2.0	1990.07 - 2003.04		4264.87D
2.4 D	AAB, AJA	2.4	1990.07 - 2003.04	87° Variante	4116.87D1
2.4 D	AAB, AJA	2.4	1990.07 - 2003.04	80° Variante	4123.80D
2.5	AEN, AAF, ACU, AEU, AVT, AET, APL	2.5	1990.11 - 2003.04		4116.87D1
2.5 TDI	AYC, AUF, ACV, AXL, AXG, AHY, AJT, AYY	2.5	1995.09 - 2003.04		4116.87D1
2.8	AES	2.8	1996.05 - 2000.05		4123.80D
2.8 VR 6	AES	2.8	1995.11 - 2000.04		4123.80D
2.8 VR 6	AMV	2.8	2000.04 - 2003.04	Chassis No. →70-2-275-000	4123.80D
2.8 VR 6	AMV	2.8	2000.05 - 2003.04	Chassis No. 70-2-275-001→	4455.80D

VOLKSWAGEN

 Motor
Engine
Moteur

 Ltr.
Ltr.
Ltr.

 Jahr
Year
Année

 Einschränkung
Restriction*
Restriction*

 Thermostat
Thermostat
Thermostat

TRANSPORTER T5

1.9 TDI	AXB, AXC, BRR, BRS	1.9	2003.04 - 2009.11		4264.87D
2.0	AXA	2.0	2003.11 -		3141.87D
2.5 TDI	AXD, BNZ, AXE, BPC, BLJ	2.5	2003.04 - 2009.11		4430.87D
3.2 4motion	BDL, BKK	3.2	2003.11 - 2009.11		4455.80D
3.2 V6	BDL, BKK	3.2	2003.04 - 2009.11		4455.80D

VENTO

1.4	AEX	1.4	1991.11 - 1998.09	mit Gehäuse	410989.87D
1.4	ABD	1.4	1991.11 - 1998.09		4264.84D
1.6	AEE	1.6	1992.09 - 1998.09	mit Gehäuse	410989.87D
1.6	ABU	1.6	1992.09 - 1998.09		4264.84D
1.6	AEA, AEK, AFT	1.6	1992.09 - 1998.09		4264.87D
1.8	AAM, ADZ, ABS	1.8	1991.11 - 1998.09		4264.87D
1.9 D	1Y	1.9	1991.11 - 1998.09		4253.87D
1.9 SDI	AEY	1.9	1997.04 - 1998.09		4253.87D
1.9 TD	AAZ	1.9	1991.11 - 1998.09		4253.87D
1.9 TDI	AFN, ALE, 1Z, AHU	1.9	1993.09 - 1998.09		4253.87D
2.0	ADY, AKR, 2E, AGG, AEP	2.0	1991.11 - 1998.09		4264.87D
2.8 VR6	AAA	2.8	1992.01 - 1998.09		4123.80D

VOLVO

	Motor Engine Moteur	Ltr. Ltr. Ltr.	Jahr Year Année	Einschränkung Restriction* Restriction*	Thermostat Thermostat Thermostat
240					
2.0	B 19, B 20	2.0	1974.08 - 1984.12		4089.87D
2.1	B 21	2.1	1974.08 - 1984.07		4089.87D
2.1 Turbo	B 21 ET	2.1	1980.08 - 1985.07		4089.87D
2.3	B 23	2.3	1978.08 - 1989.12		4089.87D
2.3 i	B 230 F	2.3	1986.08 - 1993.07		4089.87D
2.4 Diesel	D 24	2.4	1978.08 - 1993.08		4116.87D1
2.7 GLT6	B 27 E	2.7	1979.08 - 1980.07		4122.87D
260					
2.7	B 27	2.7	1974.08 - 1982.07		4122.87D
2.8	B 28	2.8	1980.08 - 1982.07		4122.87D
340 / 360					
1.4	B 14	1.4	1975.08 - 1988.12		3029.89
1.6 Diesel	D 16	1.6	1984.08 - 1991.07		3470.89D50
1.7	B 17	1.7	1985.08 - 1991.07		3136.88D50
2.0	B 19, B 20	2.0	1980.08 - 1990.07		4089.87D
2.1	B 21 E	2.1	1981.08 - 1982.07		4089.87D
440 / 460 / 480					
1.6	B 16 F	1.6	1988.09 - 1996.12		3470.89D50
1.7	B 18	1.7	1986.04 - 1996.12		3470.89D50
1.7 Turbo	B 18 FT	1.7	1987.08 - 1996.12		3470.89D50
1.8	B 18	1.8	1991.08 - 1996.12		3470.89D50
1.9 Turbo-Diesel	D 19 T	1.9	1994.07 - 1996.12	Fahrgestellnummer →617193	4147.80D
1.9 Turbo-Diesel	D 19 T	1.9	1994.08 - 1996.12	Fahrgestellnummer 617194→	3470.89D50
2.0	B 20 F	2.0	1992.08 - 1996.07		3470.89D50
740					
2.0	B 19	2.0	1983.04 - 1984.07		4089.87D
2.0	B 20	2.0	1985.01 - 1992.07		4089.87D
2.0 16V	B 204 E	2.0	1987.09 - 1990.08		4088.87D
2.0 Turbo	B 200 ET, B 200 FT	2.0	1985.05 - 1991.08		4089.87D
2.3	B 23	2.3	1983.08 - 1992.07		4089.87D
2.3 Turbo	B 23	2.3	1985.08 - 1991.08		4089.87D
2.4 Diesel	D 24	2.4	1984.08 - 1992.07		4116.87D1
2.4 TD	D 24 T, D 24 TIC	2.4	1984.08 - 1990.07		4116.87D1
2.4 TD Interc.	D 24 TIC	2.4	1986.08 - 1988.07		4116.87D1
2.4 Turbo-Diesel	D 24 T	2.4	1985.09 - 1992.07		4116.87D1
760					
2.3	B 230 FT	2.3	1988.01 - 1992.07		4089.87D
2.3 Turbo	B 23 ET	2.3	1982.08 - 1990.08		4089.87D
2.4 D	D 24	2.4	1982.01 - 1992.07		4088.87D
2.4 TD Interc.	D 24 TIC	2.4	1987.08 - 1992.07		4116.87D1
2.4 Turbo Diesel	D 24 T	2.4	1982.08 - 1992.07		4116.87D1
2.8	B 28	2.8	1981.08 - 1991.08		4122.87D
780					
2.9	B 280 E, B 280 F	2.9	1986.08 - 1990.07		4122.87D

VOLVO
**Motor
Engine
Moteur**
**Ltr.
Ltr.
Ltr.**
**Jahr
Year
Année**
**Einschränkung
Restriction*
Restriction***
**Thermostat
Thermostat
Thermostat**
850

2.0	B 5202 S, B 5204 F	2.0	1991.06 - 1996.12		4272.90D
2.0 Turbo	B 5204 T, B 5204 T2, 5204 FT	2.0	1993.02 - 1997.10		4272.90D
2.3	B 5234 FS	2.3	1996.01 - 1996.10		4272.90D
2.3 T5	B 5234 FT	2.3	1993.02 - 1996.12		4272.90D
2.3 T5 R	B 5234 T4	2.3	1995.08 - 1996.12		4272.90D
2.3 T5 R	B 5234 T2	2.3	1996.04 - 1996.10		4272.90D
2.3 Turbo R	B 5234 T5	2.3	1995.06 - 1997.10		4272.90D
2.4	B 5254 T	2.4	1993.09 - 1997.10		4272.90D
2.5	B 5252, B 5254	2.5	1991.06 - 1996.12		4272.90D
2.5 TDI	D 5252 T	2.5	1995.08 - 1996.12		4116.87D1

940

2.0	B 20	2.0	1990.09 - 1997.05		4089.87D
2.0 Turbo	B 200 FT	2.0	1990.08 - 1998.10		4089.87D
2.3	B 23	2.3	1990.08 - 1998.10		4089.87D
2.3 ti	B 230 FK	2.3	1995.01 - 1998.10		4089.87D
2.3 Turbo	B 230 FT	2.3	1990.08 - 1998.10		4089.87D
2.4 D	D 24	2.4	1990.08 - 1995.07		4088.87D
2.4 TD Interc.	D 24 TIC	2.4	1994.08 - 1998.10		4088.87D
2.4 TD Intercooler	D 24 TIC	2.4	1990.08 - 1994.12		4088.87D
2.4 Turbo Diesel	D 24 T	2.4	1990.08 - 1994.12		4088.87D

960

2.0	B 20	2.0	1990.09 - 1993.08		4088.87D
2.3 Turbo	B 230 FT	2.3	1990.09 - 1993.08		4089.87D
2.4 TD Interc.	D 24 TIC	2.4	1991.09 - 1994.07		4116.87D1
2.5	B 6254 S	2.5	1994.07 - 1996.12		4272.90D
2.8	B 28	2.8	1990.09 - 1992.05		4122.87D
2.9	B 6304 F, B 6304 S	2.9	1990.08 - 1994.07		4272.90D

C 30

1.6	B 4164 S3	1.6	2006.10 - 2012.12		4483.82D
2.4 i	B 5244 S4	2.4	2006.10 - 2012.12		4489.90D
D3	D 5204 T5	2.0	2010.10 - 2012.12		410765.90D ▲
D4	D 5204 T	2.0	2010.10 - 2012.12		410765.90D ▲
D5	D 5244 T8, D 5244 T9, D 5244 T13	2.4	2006.10 - 2012.12	Schaltgetriebe	4816.90D
D5	D 5244 T8, D 5244 T9, D 5244 T13	2.4	2006.10 - 2012.12	Automatikgetriebe	4818.90D
T5	B 5254 T3, B 5254 T7	2.5	2006.10 - 2012.12		4489.90D

C 70 I

2.0	B 5204 T2	2.0	1997.03 - 2005.10		4272.90D
2.0 T	B 5204 T3, B 5204 T4	2.0	1997.03 - 2005.10		4272.90D
2.3 T-5	B 5234 T3, B 5234 T9	2.3	1997.03 - 2005.10		4272.90D
2.4 T	B 5244 T7	2.4	2002.07 - 2005.10		4272.90D
2.5	B 5244 S, B 5254 S	2.5	1998.06 - 2005.10		4272.90D
2.5 T	B 5254 T, B 5244 T	2.5	1997.03 - 2005.10		4272.90D

C 70 II

2.4	B 5244 S5	2.4	2006.03 -		4489.90D
2.4 D	D 5244 T9	2.4	2007.03 -	Schaltgetriebe	4816.90D
2.4 D	D 5244 T9	2.4	2007.03 -	Automatikgetriebe	4818.90D
2.4 i	B 5244 S4	2.4	2006.03 -		4489.90D
D3	D 5204 T5	2.0	2010.10 -		410765.90D ▲

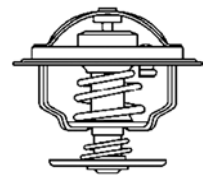
VOLVO

	Motor Engine Moteur	Ltr. Ltr. Ltr.	Jahr Year Année	Einschränkung Restriction* Restriction*	Thermostat Thermostat Thermostat
D4	D 5204 T	2.0	2010.10 -		410765.90D ▲
D5	D 5244 T8, D 5244 T13	2.4	2006.03 -	Schaltgetriebe	4816.90D
D5	D 5244 T8, D 5244 T13	2.4	2006.03 -	Automatikgetriebe	4818.90D
T5	B 5254 T3, B 5254 T7	2.5	2006.03 -		4489.90D
S 40 I					
1.6	B 4164 S, B 4164 S2	1.6	1995.09 - 2003.12		4272.90D
1.8	B 4184 S, B 4184 S2, B 4184 S3, B 4184 S9	1.8	1995.07 - 2003.12		4272.90D
1.8 i	B 4184 SJ, B 4184 SM	1.8	1998.03 - 2003.12		4637.82D
1.9 DI	D 4192 T2, D 4192 T3, D 4192 T4	1.9	1999.03 - 2003.12		3470.89D50
1.9 T4	B 4194 T, B 4194 T2	1.9	1997.05 - 2000.07		4272.90D
1.9 TD	D 4192 T	1.9	1995.07 - 1999.08		3470.89D50
2.0	B 4204 S, B 4204 S2	2.0	1995.07 - 2003.12		4272.90D
2.0 T	B 4204 T, B 4204 T2, B 4204 T3	2.0	1997.10 - 2003.12		4272.90D
2.0 T4	B 4204 T5	2.0	2000.07 - 2003.12		4272.90D
S 40 II					
1.6	B 4164 S3	1.6	2005.01 -		4483.82D
2.4	B 5244 S, B 5244 S4, B 5244 S5	2.4	2004.01 -		4489.90D
2.4 D5	D 5244 T8, D 5244 T13	2.4	2006.03 -	Schaltgetriebe	4816.90D
2.4 D5	D 5244 T8, D 5244 T13	2.4	2006.03 -	Automatikgetriebe	4818.90D
D3	D 5204 T5	2.0	2010.10 -		410765.90D ▲
D4	D 5204 T	2.0	2010.10 -		410765.90D ▲
T5	B 5254 T3, B 5254 T7	2.5	2004.01 -		4489.90D
S 60					
2.0 T	B 5204 T5	2.0	2001.09 - 2001.12		4272.90D
2.0 T	B 5204 T5	2.0	2002.01 - 2004.12		4817.90D
2.0 T	B 5204 T5	2.0	2005.01 - 2010.04		4818.90D
2.3 T5	B 5234 T7	2.3	2000.07 - 2002.09	ohne Gehäuse	4272.90D
2.3 T5	B 5234 T7	2.3	2000.07 - 2002.09	mit Gehäuse	4817.90D
2.4	B 5244 S	2.4	2000.11 - 2002.12		4272.90D
2.4	B 5244 S2	2.4	2000.11 - 2010.04		4272.90D
2.4	B 5244 S	2.4	2003.01 - 2010.04		4816.90D
2.4	B 5244 T5	2.4	2004.02 - 2004.08		4817.90D
2.4	B 5244 T5	2.4	2004.09 - 2010.04		4818.90D
2.4	B 5244 T4	2.4	2005.01 - 2006.10		4818.90D
2.4 Bifuel	B 5244 SG	2.4	2002.06 - 2002.12		4272.90D
2.4 Bifuel	B 5244 SG	2.4	2003.01 - 2010.04		4816.90D
2.4 D	D 5244 T2, D 5244 T5, D 5244 T6, D 5244 T7	2.4	2001.12 - 2010.04		4816.90D
2.4 D5	D 5244 T, D 5244 T4	2.4	2001.07 - 2010.04		4816.90D
2.4 T	B 5244 T3	2.4	2000.11 - 2001.12		4272.90D
2.4 T	B 5244 T3	2.4	2002.01 - 2004.12		4817.90D
2.4 T	B 5244 T3	2.4	2005.01 - 2010.04		4818.90D
2.4 T5	B 5244 T5	2.4	2004.04 - 2004.12		4817.90D
2.4 T5	B 5244 T5	2.4	2005.01 - 2010.04		4818.90D
2.5	B 5254 T4	2.5	2003.09 - 2004.12		4817.90D
2.5	B 5254 T4	2.5	2005.01 - 2010.04		4818.90D
2.5 T	B 5254 T2	2.5	2004.02 - 2004.12		4817.90D
2.5 T	B 5254 T2	2.5	2005.01 - 2010.04		4818.90D
R 2.5 T	B 5254 T4	2.5	2003.03 - 2004.12		4817.90D
R 2.5 T	B 5254 T4	2.5	2005.01 - 2010.04		4818.90D
T5	B 5234 T3	2.3	2000.11 - 2010.04		4272.90D

VOLVO
**Motor
Engine
Moteur**
**Ltr.
Ltr.
Ltr.**
**Jahr
Year
Année**
**Einschränkung
Restriction*
Restriction***
**Thermostat
Thermostat
Thermostat**

S 60 II					
D3	D 5204 T2, D 5204 T3, D 5204 T7	2.0	2010.04 -		410765.90D ▲
D4	D 5204 T3	2.0	2012.05 -		410765.90D ▲
D5	D 5244 T10, D 5244 T15, D 5244 T11	2.4	2010.04 -		410765.90D ▲
T6	B 6304 T4	3.0	2010.04 -		4831.90D ▲
S 70					
2.0	B 5202 S, B 5202 F, B 5204 T	2.0	1997.01 - 2000.11		4272.90D
2.3	B 5234 T7	2.3	1999.04 - 2000.09		4272.90D
2.3 T-5	B 5234 T3, B 5234 T4	2.3	1996.11 - 2000.11		4272.90D
2.3 T-5 R	B 5234 T2	2.3	1996.11 - 1998.09		4272.90D
2.3 Turbo	B 5234 FT+	2.3	1997.01 - 2000.11		4272.90D
2.4	B 5244 S, B 5252 FS, B 5254 S	2.4	1997.01 - 2000.11		4272.90D
2.4 Blu-Fuel	B 5244 SG, B 5244 S2	2.4	1997.07 - 2000.09		4272.90D
2.4 T5	B 5254 T	2.4	1996.11 - 1999.04		4272.90D
2.4 Turbo	B 5254 T, B 5244 T	2.4	1997.01 - 2000.11		4272.90D
2.5	B 5252 FS, B 5254 S	2.5	1997.01 - 2000.11		4272.90D
2.5 Bifuel	B 5244 SG, GB 5252 S	2.5	1998.10 - 2000.11		4272.90D
2.5 TDI	D 5252 T	2.5	1997.01 - 2000.11		4116.87D1
S 80					
2.0	B 5204 T4	2.0	1998.06 - 2006.07		4272.90D
2.0 T	B 5204 T3	2.0	1998.06 - 2006.07		4272.90D
2.0 T	B 5204 T5	2.0	1999.12 - 2001.08		4272.90D
2.0 T	B 5204 T5	2.0	2001.09 - 2004.04		4817.90D
2.0 T	B 5204 T5	2.0	2004.09 - 2006.07		4818.90D
2.3 R	B 5234 T7	2.3	2000.04 - 2001.12		4272.90D
2.3 R	B 5234 T7	2.3	2002.01 - 2004.12		4817.90D
2.3 R	B 5234 T7	2.3	2005.01 - 2005.08		4818.90D
2.4	B 5244 S, B 5244 S2	2.4	1999.01 - 2002.12		4272.90D
2.4	B 5244 S, B 5244 S2	2.4	2003.01 - 2006.07		4816.90D
2.4 Bifuel	B 5244 SG2	2.4	2001.09 - 2002.12		4272.90D
2.4 Bifuel	B 5244 SG2	2.4	2003.01 - 2006.07		4816.90D
2.4 D	D 5244 T2	2.4	2001.10 - 2006.07		4816.90D
2.4 D5	D 5244 T	2.4	2001.08 - 2006.07		4816.90D
2.4 LTP	B 5244 T4	2.4	2004.06 - 2006.07		4818.90D
2.4 T	B 5244 T3	2.4	2000.06 - 2001.12		4272.90D
2.4 T	B 5244 T3	2.4	2002.01 - 2004.12		4817.90D
2.4 T	B 5244 T3	2.4	2005.01 - 2006.07		4818.90D
2.4 T5	B 5244 T3	2.4	2000.04 - 2001.12		4272.90D
2.4 T5	B 5244 T3	2.4	2002.01 - 2003.09		4817.90D
2.5 T	B 5254 T2	2.5	2003.03 - 2004.12		4817.90D
2.5 T	B 5254 T2	2.5	2005.01 - 2006.07		4818.90D
2.5 TDI	D 5252 T	2.5	1999.01 - 2006.07		4116.87D1
2.8 T6	B 6284 T	2.8	1998.05 - 2006.07		4206.90D
2.9	B 6294 S, B 6304 S3	2.9	1998.05 - 2006.07		4206.90D
3.0	B 6294 S2	3.0	2001.06 - 2006.07		4206.90D
3.0 T6	B 6294 T	3.0	2001.06 - 2006.07		4206.90D
S 80 II					
2.4 D	D 5244 T, D 5244 T5	2.4	2006.03 -		4816.90D
2.5 T	B 5254 T6, B 5254 T10	2.5	2006.03 -		4489.90D
2.5 T FlexFuel	B 5254 T8, B 5254 T11	2.5	2008.05 -		4489.90D
3.2	B 6324 S, B 6324 S5	3.2	2006.03 -		4831.90D ▲
D3	D 5204 T7	2.0	2012.05 -		410765.90D ▲

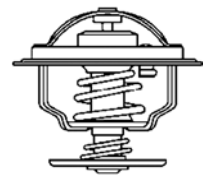
VOLVO

	Motor Engine Moteur	Ltr. Ltr. Ltr.	Jahr Year Année	Einschränkung Restriction* Restriction*	Thermostat Thermostat Thermostat
D3 / D4	D 5204 T2, D 5204 T3	2.0	2010.01 -		410765.90D ▲
D5	D 5244 T4	2.4	2006.03 -		4816.90D
D5	D 5244 T10, D 5244 T11, D 5244 T15	2.4	2011.01 -		410765.90D ▲
T6	B 6304 T2, B 6304 T4	3.0	2007.01 -		4831.90D ▲
S 90					
2.5	B 6244 FS, B 6254 FS	2.5	1996.11 - 1998.10		4272.90D
2.9	B 6304 G, B 6304 S2	2.9	1997.01 - 1998.05		4272.90D
V 40					
1.6	B 4164 S, B 4164 S2	1.6	1995.12 - 2004.06		4272.90D
1.8	B 4184 S, B 4184 S2, B 4184 S3, B 4184 S9	1.8	1995.07 - 2004.06		4272.90D
1.8 Bi-Fuel	B 4184 S9	1.8	1999.11 - 2003.08		4272.90D
1.8 Blu-Fuel	B 4184 S2	1.8	2001.06 - 2003.08		4272.90D
1.8 i	B 4184 SJ, B 4184 SM	1.8	1998.03 - 2004.06		4637.82D
1.9 DI	D 4192 T2, D 4192 T3, D 4192 T4	1.9	1999.03 - 2004.06		3470.89D50
1.9 T4	B 4194 T	1.9	1997.05 - 2000.07		4272.90D
1.9 TD	D 4192 T	1.9	1995.07 - 1999.08		3470.89D50
2.0	B 4204 S, B 4204 S2	2.0	1995.07 - 2004.06		4272.90D
2.0 T	B 4204 T, B 4204 T2, B 4204 T3	2.0	1997.10 - 2004.06		4272.90D
2.0 T4	B 4204 T5	2.0	2000.07 - 2004.06		4272.90D
D3	D 5204 T6	2.0	2012.03 -		410765.90D ▲
D4	D 5204 T4	2.0	2012.03 -		410765.90D ▲
T4	B 5204 T8	2.0	2013.07 -		410765.90D ▲
T5	B 5204 T9	2.0	2013.03 -		410765.90D ▲
V 50					
1.6	B 4164 S3	1.6	2005.01 -		4483.82D
2.4	B 5244 S4, B 5244 S5	2.4	2004.04 -		4489.90D
2.4 D5	D 5244 T8, D 5244 T13	2.4	2006.03 -	Schaltgetriebe	4816.90D
2.4 D5	D 5244 T8, D 5244 T13	2.4	2006.03 -	Automatikgetriebe	4818.90D
2.4 Tdi	D 5244 T9	2.4	2007.05 -	Schaltgetriebe	4816.90D
2.4 Tdi	D 5244 T9	2.4	2007.05 -	Automatikgetriebe	4818.90D
D3	D 5204 T5	2.0	2010.10 -		410765.90D ▲
D4	D 5204 T	2.0	2010.10 -		410765.90D ▲
T5	B 5254 T3, B 5254 T7	2.5	2004.04 -		4489.90D
V 60					
2.4 D5	D 5244 T15, D 5244 T11	2.4	2011.06 -		410765.90D ▲
2.4 Hybrid	D 5244 T15	2.4	2012.06 -		410765.90D ▲
D3	D 5204 T7	2.0	2012.12 -		410765.90D ▲
D3 / D4	D 5204 T2, D 5204 T3	2.0	2010.09 -		410765.90D ▲
D4	D 5244 T17	2.4	2012.12 -		410765.90D ▲
D5	D 5244 T10	2.4	2010.09 -		410765.90D ▲
T6	B 6304 T4	3.0	2010.09 -		4831.90D ▲
V 70 I					
2.0	B 5204 F, B 5202 S, B 5204 T2, B 5204 T4	2.0	1997.01 - 2000.03		4272.90D
2.0 Turbo	B 5204 T, B 5204 T3	2.0	1997.01 - 2000.03		4272.90D
2.3	B 5234 T3, B 5234 T7, B 5234 T8	2.3	1997.04 - 2000.02		4272.90D
2.3 T	B 5234 FT+	2.3	1997.04 - 2000.03		4272.90D
2.3 T-5	B 5234 T3	2.3	1997.01 - 2000.03		4272.90D
2.3 Turbo	B 5234 FT+	2.3	1997.01 - 2000.03		4272.90D

VOLVO

	Motor Engine Moteur	Ltr. Ltr. Ltr.	Jahr Year Année	Einschränkung Restriction* Restriction*	Thermostat Thermostat Thermostat
2.4	B 5244 S, B 5244 S2, B 5254 S, B 5244 SG2	2.4	1997.01 - 2000.05		4272.90D
2.4 Bifuel	B 5244 SG	2.4	1999.08 - 2000.03		4272.90D
2.4 Turbo	B 5244 T, B 5244 T2, B 5254 T	2.4	1997.01 - 2000.03		4272.90D
2.5	B 5252 FS, B 5254 S	2.5	1997.01 - 2000.03		4272.90D
2.5 Bifuel	GB 5252 S	2.5	1998.10 - 1999.08		4272.90D
2.5 TDI	D 5252 T	2.5	1996.11 - 2000.05		4116.87D1
2.5 Turbo	B 5254 T, B 5244 T	2.5	1997.01 - 2000.05		4272.90D
V 70 II					
2.0 T	B 5204 T5	2.0	2001.07 - 2001.08		4272.90D
2.0 T	B 5204 T5	2.0	2001.09 - 2004.04		4817.90D
2.0 T	B 5204 T5	2.0	2004.09 - 2007.08		4818.90D
2.3	B 5234 T7, B 5234 T8	2.3	2000.10 - 2001.12		4272.90D
2.3	B 5234 T7, B 5234 T8	2.3	2002.01 - 2004.09		4817.90D
2.3 T5	B 5234 T3, B 5234 T4	2.3	2000.03 - 2001.12		4272.90D
2.3 T5	B 5234 T3, B 5234 T4	2.3	2002.01 - 2004.12		4817.90D
2.3 T5	B 5234 T3, B 5234 T4	2.3	2005.01 - 2007.08		4818.90D
2.4	B 5244 S, B 5244 S2	2.4	2000.03 - 2002.12		4272.90D
2.4	B 5244 S, B 5244 S2	2.4	2003.01 - 2002.12		4816.90D
2.4 Bifuel	B 5244 SG2	2.4	2001.09 - 2002.12		4272.90D
2.4 Bifuel	B 5244 SG2	2.4	2003.01 - 2007.08		4816.90D
2.4 D	D 5244 T2	2.4	2001.12 - 2007.08		4816.90D
2.4 D	D 5244 T7	2.4	2005.05 - 2007.08		4818.90D
2.4 D5	D 5244 T	2.4	2001.08 - 2007.08		4816.90D
2.4 D5	D 5244 T2, D 5244 T4, D 5244 T5	2.4	2001.08 - 2007.08		4818.90D
2.4 T	B 5244 T3	2.4	2000.03 - 2001.12		4272.90D
2.4 T	B 5244 T3	2.4	2002.01 - 2004.12		4817.90D
2.4 T	B 5244 T3	2.4	2005.01 - 2007.08		4818.90D
2.4 T5	B 5244 T5	2.4	2004.04 - 2004.08		4817.90D
2.4 T5	B 5244 T5	2.4	2004.09 - 2007.08		4818.90D
2.5 R Sport	B 5254 T4	2.5	2002.12 - 2004.08		4817.90D
2.5 R Sport	B 5254 T4	2.5	2004.09 - 2007.08		4818.90D
2.5 T	B 5254 T2	2.5	2002.09 - 2004.08		4817.90D
2.5 T	B 5254 T2	2.5	2004.09 - 2007.08		4818.90D
2.5 TDI	D 5252 T	2.5	2000.03 - 2007.08		4116.87D1
R 2.5 T	B 5254 T4	2.5	2003.03 - 2004.08		4817.90D
R 2.5 T	B 5254 T4	2.5	2004.09 - 2007.08		4818.90D
V 70 III					
2.4 D	D 5244 T5	2.4	2007.08 -		4816.90D
2.5 T	B 5254 T6, B 5254 T10	2.5	2007.08 -		4489.90D
2.5 T FlexiFuel	B 5254 T8, B 5254 T11	2.5	2008.05 -		4489.90D
3.2	B 6324 S, B 6324 S5	3.2	2007.08 -		4831.90D ▲
D3 / D4	D 5204 T2, D 5204 T3	2.0	2010.03 -		410765.90D ▲
D5	D 5244 T4	2.4	2007.08 -		4816.90D
D5	D 5244 T10, D 5244 T15, D 5244 T11	2.4	2011.01 -		410765.90D ▲
T6	B 6304 T2, B 6304 T4	3.0	2007.08 -		4831.90D ▲
V 90					
2.5	B 6244 FS, B 6254 FS	2.5	1996.11 - 1997.10		4272.90D
2.9	B 6304 G, B 6304 S2	2.9	1997.01 - 1998.12		4272.90D

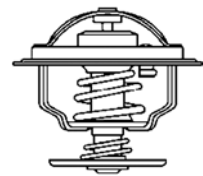
VOLVO

	Motor Engine Moteur	Ltr. Ltr. Ltr.	Jahr Year Année	Einschränkung Restriction* Restriction*	Thermostat Thermostat Thermostat
XC 60					
2.4 D	D 5244 T14	2.4	2009.07 -	Fahrgestellnummer 135000 →	410765.90D ▲
2.4 D / D3 / D4	D 5244 T16, D 5244 T17	2.4	2008.05 -	Fahrgestellnummer 135000 →	410765.90D ▲
2.4 D / D3 / D4	D 5244 T5	2.4	2008.05 -		4816.90D
3.2	B 6324 S, B 6324 S5	3.2	2009.07 -		4831.90D ▲
D3 / D4	D 5204 T2, D 5204 T3	2.0	2010.03 -		410765.90D ▲
D5	D 5244 T4	2.4	2008.05 -		4816.90D
D5	D 5244 T10	2.4	2011.01 -	Fahrgestellnummer 135000 →	410765.90D ▲
D5	D 5244 T11, D 5244 T15	2.4	2011.06 -		410765.90D ▲
T6	B 6304 T2, B 6304 T4	3.0	2008.05 -		4831.90D ▲
T6		3.0	2010.03 -		4831.90D ▲
XC 70					
2.4 D5	D 5244 T	2.4	2002.09 - 2007.08		4816.90D
2.4 D5	D 5244 T4	2.4	2005.12 - 2007.08		4818.90D
2.4 T	B 5254 T	2.4	1997.11 - 2002.09		4272.90D
2.4 T	B 5244 T3	2.4	2000.03 - 2001.12		4272.90D
2.4 T	B 5244 T3	2.4	2002.01 - 2002.09		4817.90D
2.5 T	B 5254 T2	2.5	2002.09 - 2004.08		4817.90D
2.5 T	B 5254 T2	2.5	2004.09 - 2007.08		4818.90D
XC 70 II					
2.4 D / D4	D 5244 T5	2.4	2007.08 -		4816.90D
3.2	B 6324 S, B 6324 S5	3.2	2007.08 -		4831.90D ▲
D3	D 5204 T2, D 5204 T3	2.0	2011.08 -		410765.90D ▲
D5	D 5244 T4	2.4	2007.08 -		4816.90D
D5	D 5244 T10	2.4	2011.01 -		410765.90D ▲
D5	D 5244 T15, D 5244 T11	2.4	2011.06 -		410765.90D ▲
T6	B 6304 T2, B 6304 T4	3.0	2008.01 -		4831.90D ▲
XC 90					
2.5 T	B 5254 T2	2.5	2002.10 - 2004.12		4817.90D
2.5 T	B 5254 T2	2.5	2005.01 -		4818.90D
3.2	B 6324 S, B 6324 S5	3.2	2006.05 -		4831.90D ▲
D3 / D5	D 5244 T5	2.5	2009.04 -		4818.90D
D5	D 5244 T, D 5244 T5	2.4	2002.10 -		4816.90D
D5	D 5244 T4, D 5244 T18	2.4	2006.05 -		4818.90D
T6	B 6294 T	2.9	2002.10 -		4206.90D

WARTBURG

 Motor
Engine
Moteur

 Ltr.
Ltr.
Ltr.

 Jahr
Year
Année

 Einschränkung
Restriction*
Restriction*

 Thermostat
Thermostat
Thermostat

Barkas B 1000

1.0	H362-21	1.0	1967.04 - 1991.12	Dichtring	003187
1.0	H362-21	1.0	1967.04 - 1991.12		3017.83

Trabant 1.1

1.1	4V05,9 / 7,5GRF	1.1	1990.05 - 1991.12		4253.87D
-----	-----------------	-----	-------------------	--	-----------------

Wartburg 353

1.0	353,18	1.0	1966.06 - 1989.01	Dichtring	003187
1.0	353,18	1.0	1966.06 - 1989.01		3017.83
1.0	1A	1.0	1967.10 - 1969.04	Dichtring	003187
1.0	1A	1.0	1967.10 - 1969.04		3017.83

353

1.3	4V07,2, 7,5GRF	1.3	1988.09 - 1991.05		4264.84D
-----	----------------	-----	-------------------	--	-----------------

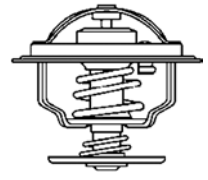

ALFA ROMEO
**Motor
Engine
Moteur**
**Ltr.
Ltr.
Ltr.**
**Jahr
Year
Année**
**Einschränkung
Restriction*
Restriction***
**Thermoschalter
Thermoswitches
Thermocontact**
145 (930)

1.6 i.e.	AR 33201	1.6	1994.10 - 1996.12	ohne Klimaanlage	6031.92D
1.7 i.e. 16V	AR 33401	1.7	1994.10 - 1996.12	ohne Klimaanlage	6031.92D

146 (930)

1.6 i.e.	AR 33201	1.6	1994.12 - 1996.12	ohne Klimaanlage	6031.92D
1.7 i.e. 16V	AR 33401	1.7	1994.12 - 1996.12	ohne Klimaanlage	6031.92D

155 (167)

1.6 16V T.S.	AR 67601	1.6	1996.05 - 1997.12	mit Klimaanlage	6035.92D
1.7 T.S.	AR 67103, AR 67105	1.7	1993.04 - 1996.04	ohne Klimaanlage	6031.92D
1.7 T.S. 16V	AR 67106	1.7	1996.05 - 1997.12	mit Klimaanlage	6035.92D
1.8 T.S.	AR 67101	1.8	1992.02 - 1993.06	ohne Klimaanlage	6031.92D
1.8 T.S. Sport	AR 67101, AR 67102	1.8	1992.01 - 1996.12	ohne Klimaanlage	6031.92D
2.0 T.S. 16V (167.A2G)	AR 67204	2.0	1995.03 - 1997.12		6035.92D
2.5 TD (167.A1A)	VM 07 B, VM 31 B	2.5	1993.04 - 1997.12		6035.92D
2.5 V6	AR 67301, AR 67302, AR 67303	2.5	1992.02 - 1997.12	ohne Klimaanlage	6031.92D

ALFASUD

1.2	AR 30102, AR 30102 S	1.2	1972.06 - 1984.09		6010.95D
1.2 ti	AR 30104	1.2	1973.11 - 1984.09		6010.95D
1.3	AR 30160, AR 30180, AR 30184	1.3	1978.01 - 1979.07 1976.09 - 1981.12		6010.92D 6010.95D
1.3 (901.F0)	AR 30180	1.3	1978.01 - 1980.02		6010.95D
1.3 SC/ti Super	AR 30164	1.3	1977.09 - 1984.09		6010.95D
1.3 Super (901.F2)	AR 30160	1.3	1979.01 - 1984.09		6010.95D
1.3 ti (901.G0)	AR 30184	1.3	1977.09 - 1984.09		6010.95D
1.4	AR 30164, AR 30168	1.4	1978.05 - 1989.12		6010.95D
1.5	AR 30124, AR 30128, AR 30146	1.5	1978.05 - 1987.12		6010.95D
1.7	AR 30550	1.7	1987.03 - 1989.12		6010.95D
1.7 i.e.	AR 30558	1.7	1987.10 - 1989.12		6010.95D

ALFETTA

1.6	AR 01600	1.6	1975.01 - 1984.12		6010.95D
1.8	AR 01608, AR 01608 X, AR 01678	1.8	1974.01 - 1984.12		6010.95D
2.0	AR 01623, AR 01655, AR 01713, AR 10520	2.0	1977.03 - 1986.01		6010.95D
2.0 TD	VM4HT/2	2.0	1979.10 - 1983.03		6010.82D
2.4 TD	VM4HT 2.4	2.4	1983.04 - 1984.12		6010.82D

GIULIETTA

1.3 (116.44A)	AR 01644	1.3	1977.10 - 1983.06		6010.95D
1.6 (116.50B)	AR 01600	1.6	1977.10 - 1985.04		6010.95D
1.8 (116.AA, 116.AB)	AR 01678	1.8	1979.04 - 1985.04		6010.95D
1.8 Turbo	AR 01354	1.8	1984.01 - 1985.12		6010.95D
2.0 (116.A1A)	AR 01655, AR 11671	2.0	1980.06 - 1985.04		6010.95D
2.0 TD	VM 4 HT	2.0	1983.01 - 1985.12		6010.82D
2.0 Turbo	AR 01699	2.0	1983.07 - 1984.06		6010.95D

GTV (916)

2.0 T.SPARK 16V (916.C2__, 916C2C00)	AR 16201, AR 32310	2.0	1995.06 -		6035.92D
2.0 T.SPARK 16V (916C2C)	AR 32301	2.0	1998.05 - 2000.08		6035.92D
2.0 V6 Turbo (916.C2A)	AR 16202	2.0	1995.06 -		6035.92D
3.0 V6 24V	AR 16102, AR 16105	3.0	1996.10 - 2000.10		6035.92D

MONTREAL

2.6 (105,64)	AR 10832	2.6	1972.12 - 1979.03		6010.95D
--------------	----------	-----	-------------------	--	----------

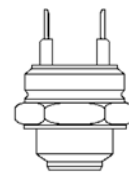
**ALFA ROMEO**

	Motor Engine Moteur	Ltr. Ltr. Ltr.	Jahr Year Année	Einschränkung Restriction* Restriction*	Thermoschalter Thermoswitches Thermocontact
SPIDER (916)					
2.0 T.SPARK 16V	AR 16201, AR 32301, AR 32310	2.0	1995.06 - 2005.04		6035.92D
2.0 V6 Turbo	AR 16202	2.0	1998.05 - 2005.04		6035.92D
3.0 V6	AR 16101, AR 16105	3.0	1995.06 - 2005.04		6035.92D
3.0 V6 24V	AR 16102	3.0	1999.01 - 2000.10		6035.92D
3.2 V6 24V	936 A6.000	3.2	2003.04 - 2005.04		6035.92D

AUDI

	Motor Engine Moteur	Ltr. Ltr. Ltr.	Jahr Year Année	Einschränkung Restriction* Restriction*	Thermoschalter Thermoswitches Thermocontact
80 (quattro)					
1.3	EP, FY, FZ, ZA, ZF	1.3	1972.05 - 1978.07 1972.05 - 1986.07		6010.92D 6024.95D
1.4	SE	1.4	1986.08 - 1988.07 1986.08 - 1988.07		6017.95D 6024.95D
1.5	YJ, ZB, ZC	1.5	1972.05 - 1976.07		6010.92D
1.6	ABB, ABM, DT, PP, RN, SA, WV, YN, YP, YT, YY	1.6	1975.09 - 1978.07 1986.02 - 1994.12 1975.09 - 1994.12		6010.92D 6017.95D 6024.95D
1.6 D	CR, JK	1.6	1980.08 - 1991.08 1980.08 - 1991.08		6017.95D 6024.95D
1.6 E	ADA	1.6	1993.06 - 1996.01 1993.06 - 1996.01		6017.95D 6024.95D
1.6 GLE	YZ	1.6	1979.01 - 1986.12		6024.95D
1.6 GT	XX	1.6	1973.09 - 1976.07		6010.92D
1.6 GTE	YS	1.6	1976.01 - 1978.07 1976.01 - 1978.07		6010.92D 6024.95D
1.6 TD	CY, RA, SB	1.6	1981.08 - 1991.08 1981.08 - 1991.08		6017.95D 6024.95D
1.8	DS, JN, RU, SD, SF	1.8	1983.01 - 1990.01 1983.01 - 1990.08		6017.95D 6024.95D
1.8 CC	JN, JV, NE	1.8	1984.08 - 1986.08		6024.95D
1.8 E	DZ	1.8	1986.06 - 1991.08		6024.95D
1.8 GTE	DZ, PV	1.8	1984.10 - 1986.08 1984.08 - 1986.08		6017.95D 6024.95D
1.8 S	JN, NE, PM, SF	1.8	1986.09 - 1991.10		6024.95D
1.9 CD-5S	WN	1.9	1981.09 - 1983.07		6024.95D
1.9 D	1Y	1.9	1989.08 - 1991.08 1989.08 - 1991.08		6017.95D 6024.95D
1.9 TD	AAZ	1.9	1991.09 - 1994.12 1991.09 - 1994.12		6017.95D 6024.95D
1.9 TDI	1Z	1.9	1991.09 - 1996.01 1991.09 - 1996.01		6017.95D 6024.95D
2.0	3A, AAD, ABT, HP, JS	2.0	1991.09 - 1996.01 1983.10 - 1984.09 1983.10 - 1996.01		6017.95D 6020.95D 6024.95D
2.0 E	3A, ABK	2.0	1991.09 - 1996.01 1988.08 - 1996.01		6017.95D 6024.95D
2.0 E 16V	6A, ACE	2.0	1990.03 - 1996.01 1992.04 - 1996.01		6017.95D 6024.95D
2.2	KK, KL, WE	2.2	1982.08 - 1984.07 1980.10 - 1983.07		6020.95D 6024.95D
2.3 E	NG	2.3	1991.09 - 1996.01 1991.09 - 1996.01		6017.95D 6024.95D
2.6	ABC	2.6	1992.06 - 1996.01 1992.06 - 1996.01		6017.95D 6024.95D
2.8	AAH	2.8	1991.09 - 1996.01 1991.09 - 1996.01		6017.95D 6024.95D
RS2	ADU	2.2	1994.03 - 1995.05		6017.95D
S2	ABY	2.2	1993.02 - 1995.07 1993.02 - 1995.07		6017.95D 6024.95D
90 (quattro)					
1.6 TD	CY, RA, SB	1.6	1985.10 - 1991.09 1985.10 - 1991.09		6017.95D 6024.95D
2.0	HP, JS, PS, SK	2.0	1984.10 - 1991.09 1984.10 - 1991.09		6017.95D 6024.95D

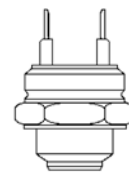

AUDI

	Motor Engine Moteur	Ltr. Ltr. Ltr.	Jahr Year Année	Einschränkung Restriction* Restriction*	Thermoschalter Thermoswitches Thermocontact
2.0 20 V	NM	2.0	1988.08 - 1991.09 1988.08 - 1991.09		6017.95D 6024.95D
2.2	HY, KV, KX	2.2	1984.10 - 1987.03 1984.10 - 1987.03		6017.95D 6024.95D
2.2 E	JT, KV	2.2	1984.11 - 1991.09		6024.95D
2.3 E	NG	2.3	1987.04 - 1991.09		6024.95D
2.3 E 20V	7A	2.3	1988.06 - 1991.09		6024.95D
100 1968 --> 1983					
1.6	YM, YV	1.6	1976.08 - 1983.02 1975.01 - 1983.02 1976.08 - 1983.02	Chassis No →4382300000 Chassis No 4392000001→	6017.95D 6010.92D 6024.95D
1.8	ZU, ZV, ZX, ZZ	1.8	1968.11 - 1976.07		6010.92D
1.9	WH, ZJ, ZP	1.9	1980.08 - 1982.07 1970.07 - 1982.07 1980.08 - 1982.07	Chassis No →4382300000 Chassis No 4392000001→	6017.95D 6010.92D 6024.95D
2.0	WA	2.0	1976.06 - 1980.07 1976.06 - 1980.07	Chassis No →4382300000	6017.95D 6010.92D
2.0 D	CN	2.0	1978.08 - 1983.02 1978.08 - 1983.02 1978.08 - 1983.02	Chassis No →4382300000 Chassis No 4392000001→	6017.95D 6010.92D 6024.95D
2.1	WB, WC, WE, WG	2.1	1977.03 - 1983.02 1977.03 - 1983.02	Chassis No 4392000001→	6017.95D 6024.95D
100 1982 --> 1990 (quattro)					
1.8	DR, DS, JW, NP, RS, SH	1.8	1982.08 - 1990.07 1982.08 - 1990.07		6017.95D 6024.95D
1.8 KAT	4B, PH	1.8	1985.03 - 1990.11 1985.03 - 1990.11		6017.95D 6024.95D
1.8 quattro KAT	4B, PH	1.8	1985.08 - 1990.11 1985.08 - 1990.11		6017.95D 6024.95D
1.9	WH	1.9	1982.08 - 1984.07 1982.08 - 1984.07		6017.95D 6024.95D
2.0	KP, RT, SL	2.0	1984.08 - 1990.11 1984.08 - 1990.11		6017.95D 6024.95D
2.0 D	CN	2.0	1982.08 - 1990.11 1982.08 - 1990.11		6017.95D 6024.95D
2.0 D Turbo	DE, NC	2.0	1982.08 - 1990.11 1982.08 - 1990.11		6017.95D 6024.95D
2.0 E	KP, RT	2.0	1985.01 - 1990.11 1985.01 - 1990.11		6017.95D 6024.95D
2.0 TD	DE, NC	2.0	1983.03 - 1990.11 1983.03 - 1990.11		6017.95D 6024.95D
2.1	WC	2.1	1982.08 - 1984.07 1982.08 - 1984.07		6017.95D 6024.95D
2.2	HX, KF, KU, KZ, WU	2.2	1982.08 - 1990.11 1982.08 - 1990.11		6017.95D 6024.95D
2.2 E	PX	2.2	1985.08 - 1986.07 1985.08 - 1986.07		6017.95D 6024.95D
2.2 E Turbo	MC	2.2	1986.08 - 1990.11 1986.08 - 1990.11		6017.95D 6024.95D

AUDI

	Motor Engine Moteur	Ltr. Ltr. Ltr.	Jahr Year Année	Einschränkung Restriction* Restriction*	Thermoschalter Thermoswitches Thermocontact
2.2 Turbo	MC	2.2	1986.08 - 1990.11 1986.08 - 1990.11		6017.95D 6024.95D
2.3	AAR, NF	2.3	1986.08 - 1990.11 1986.08 - 1990.11		6017.95D 6024.95D
2.3 E	AAR, NF	2.3	1986.08 - 1990.11 1986.08 - 1990.11		6017.95D 6024.95D
2.4 D	3D	2.4	1989.08 - 1991.07 1989.08 - 1991.07		6017.95D 6024.95D
2.5 TDI	1T	2.5	1990.01 - 1990.11 1990.01 - 1990.11		6017.95D 6024.95D
100 1990 --> 1994 (quattro)					
2.0	AAE	2.0	1990.12 - 1994.06		6017.95D
2.0 E	AAD, AAE, ABK	2.0	1990.12 - 1994.06		6017.95D
2.0 E 16V	ACE	2.0	1992.01 - 1994.06 1992.01 - 1994.06		6017.95D 6024.95D
2.3 E	AAR	2.3	1990.12 - 1994.06		6017.95D
2.4 D	AAS	2.4	1990.12 - 1994.06		6017.95D
2.5 TDI	AAT, ABP	2.5	1990.12 - 1994.06		6017.95D
2.6	ABC, ACZ	2.6	1992.03 - 1994.06		6017.95D
2.8 E	AAH	2.8	1990.12 - 1994.06		6017.95D
S4 Turbo	AAN	2.2	1991.08 - 1994.06		6017.95D
S4 V8	ABH, AEC	4.2	1992.10 - 1994.06		6017.95D
200 (quattro)					
2.1 5 E	WC	2.1	1979.10 - 1984.07 1979.10 - 1984.07		6010.95D 6017.95D
2.1 5 T	WJ	2.1	1979.10 - 1982.08 1979.10 - 1982.08		6010.95D 6017.95D
2.1 Turbo	KG	2.1	1983.08 - 1988.01 1983.08 - 1988.01		6010.95D 6017.95D
2.2	KU	2.2	1984.08 - 1985.07 1984.08 - 1985.07		6010.95D 6017.95D
2.2 20V Turbo	3B	2.2	1989.03 - 1990.12		6017.95D
2.2 Turbo	1B, 2B, MC	2.2	1983.09 - 1991.12 1983.09 - 1991.12		6010.95D 6017.95D
2.3	NF	2.3	1986.11 - 1991.09 1986.11 - 1991.09		6010.95D 6017.95D
A3 (8L)					
1.6	AEH, AKL, APF	1.6	1996.09 - 2000.08 1996.09 - 2000.08		6037.95D 6039.95D
1.8	AGN, APG	1.8	1996.09 - 1996.09 -		6037.95D 6039.95D
1.8 T	AGU, AQA, ARZ, AUM	1.8	1996.12 - 1996.12 -		6037.95D 6039.95D
1.9 TDI	AGR, AHF, ALH, ASV	1.9	1996.09 - 2001.07 1996.09 - 2001.07		6037.95D 6039.95D
A4 (quattro)					
1.6	ADP, AHL, ALZ, ANA, ARM	1.6	1995.01 - 2000.11 1995.01 - 2000.11		6017.95D 6024.95D
1.8	ADR, APT, ARG, AVV	1.8	1995.01 - 2001.09 1995.01 - 2001.09		6017.95D 6024.95D
1.8 T	AEB, ANB, APU, ARK, AWT	1.8	1995.01 - 2001.09 1995.01 - 2001.09		6017.95D 6024.95D
1.9 TDI	1Z, AFN, AHH, AHU, AVG	1.9	1995.01 - 2001.09 1995.01 - 2001.09		6017.95D 6024.95D

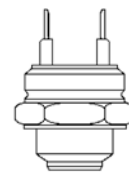

AUDI

	Motor Engine Moteur	Ltr. Ltr. Ltr.	Jahr Year Année	Einschränkung Restriction* Restriction*	Thermaschalter Thermoswitches Thermocontact
2.4	AGA, AJG, ALF, AML, AMM, APS, APZ, ARJ	2.4	1997.03 - 2001.09 1997.03 - 2001.09		6017.95D 6024.95D
2.6	ABC	2.6	1995.01 - 2001.09 1995.01 - 2001.09		6017.95D 6024.95D
2.8	AAH, ACK, ALG, AMX, APR, AQD	2.8	1995.01 - 2001.09 1995.01 - 2001.09		6017.95D 6024.95D
A6 (quattro)					
1.8	ADR	1.8	1995.12 - 1997.12		6017.95D
1.9 TDI	1Z, AHU	1.9	1994.06 - 1997.12		6017.95D
2.0	AAE, ABK, ADW	2.0	1994.06 - 1997.12		6017.95D
2.0 16V	ACE	2.0	1994.06 - 1997.12		6017.95D
2.3	AAR	2.3	1994.06 - 1995.12		6017.95D
2.4	AFM	2.4	1996.07 - 1997.12		6017.95D
2.5 TDI	AAT, AEL	2.5	1994.06 - 1997.12		6017.95D
2.6	ABC, ACZ	2.6	1994.06 - 1997.12		6017.95D
2.8	AAH, ACK, AEJ, AFC	2.8	1994.06 - 1997.12 1995.12 - 1997.12		6017.95D 6024.95D
S6 4.2	AEC	4.2	1994.06 - 1997.12		6017.95D
S6 Turbo	AAN	2.2	1994.06 - 1997.12		6017.95D
A8 (quattro)					
2.5 TDI	AFB, AKE, AKN	2.5	1997.01 - 2000.04 1997.01 - 2002.09		6017.95D 6087.87D
2.8	AAH, ACK, AEJ, ALG, AMX, APR, AQD	2.8	1994.03 - 2002.09 1994.03 - 1996.03 1996.04 - 2002.09		6017.95D 6024.95D 6087.87D
3.3 TDI	AKF	3.3	2000.06 - 2002.09		6087.87D
3.7	AEW, AKC, AKJ, AQG	3.7	1998.11 - 2002.09 1995.07 - 2002.09		6017.95D 6087.87D
4.2	ABZ, AKG, AQF, ARU, AUW, AUX	4.2	1998.11 - 2002.09 1994.03 - 2002.09		6017.95D 6087.87D
6.0 W12	AZC	6.0	2001.01 - 2002.09		6087.87D
S 8	AHC, AKH, AQH, AVP	4.2	1996.07 - 2002.09		6087.87D
CABRIOLET					
1.8	ADR	1.8	1997.01 - 2000.08 1997.01 - 2000.08		6017.95D 6024.95D
1.9 TDI	1Z, AHU	1.9	1995.06 - 2000.08 1995.06 - 2000.08		6017.95D 6024.95D
2.0 16V	ACE	2.0	1995.06 - 1996.07 1995.06 - 1996.07		6017.95D 6024.95D
2.0 E	ABK	2.0	1993.01 - 1998.07 1993.01 - 1998.07		6017.95D 6024.95D
2.3 E	NG	2.3	1991.05 - 1994.07 1991.05 - 1994.07		6017.95D 6024.95D
2.6	ABC, ACZ	2.6	1993.06 - 2000.08 1993.06 - 2000.08		6017.95D 6024.95D
2.8	AAH	2.8	1992.11 - 2000.08 1992.11 - 2000.08		6017.95D 6024.95D
COUPE (quattro)					
1.8	DD, DZ	1.8	1981.08 - 1983.07 1981.08 - 1991.07	Chassis No →85F220000 Chassis No 85G000001→	6024.95D 6017.95D

AUDI

	Motor Engine Moteur	Ltr. Ltr. Ltr.	Jahr Year Année	Einschränkung Restriction* Restriction*	Thermoschalter Thermoswitches Thermocontact
1.8 GT	DS, DZ, JN, JV, PV, SF	1.8	1982.09 - 1988.10	Chassis No →85F220000	6024.95D
			1982.09 - 1988.10	Chassis No 85G000001→	6017.95D
1.9	WN	1.9	1980.08 - 1983.07	Chassis No →85F220000	6024.95D
			1980.08 - 1983.07	Chassis No 85G000001→	6017.95D
2.0	AAD, ABK, HP, JS, SK	2.0	1983.09 - 1988.04	Chassis No →85F220000	6024.95D
			1983.09 - 1996.12	Chassis No 85G000001→	6017.95D
2.0 16 V	ACE	2.0	1992.08 - 1996.12		6017.95D
2.0 20 V	NM	2.0	1989.08 - 1991.07		6017.95D
			1989.08 - 1991.07		6024.95D
2.1 GT	KE, KL	2.1	1982.09 - 1984.08	Chassis No →85F220000	6024.95D
			1982.09 - 1984.08	Chassis No 85G000001→	6017.95D
2.2	JT, KV	2.2	1984.10 - 1988.10	Chassis No →85F220000	6024.95D
			1984.10 - 1991.07	Chassis No 85G000001→	6017.95D
2.2 GT	HY, KV, KX	2.2	1981.07 - 1988.10	Chassis No →85F220000	6024.95D
			1981.07 - 1988.10	Chassis No 85G000001→	6017.95D
2.3	NG	2.3	1987.01 - 1988.10	Chassis No →85F220000	6024.95D
			1987.01 - 1996.12	Chassis No 85G000001→	6017.95D
2.3 20V	7A	2.3	1988.11 - 1996.12		6017.95D
2.6	ABC	2.6	1992.08 - 1996.12		6017.95D
2.8	AAH	2.8	1991.08 - 1996.12		6017.95D
S2	3B, ABY	2.2	1990.09 - 1996.12		6017.95D
QUATTRO					
2.1 20V Turbo	KW	2.1	1984.05 - 1987.07		6024.95D
2.1 Turbo	GV, WR	2.1	1980.07 - 1987.07	Chassis No →85-F-902000	6010.95D
			1980.07 - 1987.07	Chassis No 85-G-900001→	6024.95D
2.2 Turbo	1B, MB	2.2	1987.08 - 1989.07		6017.95D

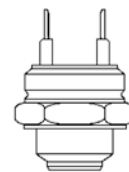

AUTOBIANCHI

	Motor Engine Moteur	Ltr. Ltr. Ltr.	Jahr Year Année	Einschränkung Restriction* Restriction*	Thermaschalter Thermaswitches Thermocontact
A 112					
0.9	A112A 5.000, A112B2.000	0.9	1969.10 - 1985.12		6010.95D
0.9 E	A112A 5.000	0.9	1973.01 - 1977.12		6010.95D
1.0 Abarth	A112A1.000, A112A2.000	1.0	1971.09 - 1984.12		6010.95D
1.0 E,Elite,LX	A112B1.000	1.0	1977.11 - 1985.12		6010.95D
Y 10					
1.0	156A.000, 156A2.000, 156A2.246, 156A3.000	1.0	1985.03 - 1991.12		6031.92D
1.0 Turbo	156A1.000	1.0	1985.03 -		6031.92D
1.1	156C.000	1.1	1989.06 - 1989.06 -	ohne Klimaanlage mit Klimaanlage	6031.92D 6035.92D
1.1 i.e.	156C.046	1.1	1990.09 -	ohne Klimaanlage	6031.92D

CITROËN
**Motor
Engine
Moteur**
**Ltr.
Ltr.
Ltr.**
**Jahr
Year
Année**
**Einschränkung
Restriction*
Restriction***
**Thermoschalter
Thermoswitches
Thermocontact**
AX

1.3 Sport	M4A	1.3	1987.04 - 1988.12		6010.95D
10 E	C3A	1.0	1986.12 - 1988.12		6010.95D
11	H1A, H1B	1.1	1986.12 - 1994.04		6010.95D
14	KAY (TU3CP)	1.4	1986.12 - 1988.12		6010.95D

BX

14	K1H (TU3A), KDY (TU3M), KDZ (TU3M/Z)	1.4	1989.01 - 1993.02		6010.88D
14 E	150A, 150C, 150F, K1G	1.4	1982.10 - 1993.02 1985.10 - 1989.05		6010.88D 6010.92D

CX

20	829 A5	2.0	1985.08 - 1986.08		6010.95D
20 RE	829 A5	2.0	1985.08 - 1992.12		6010.95D
2000	829 A5, M20-616	2.0	1974.09 - 1985.08		6010.95D
2200	M22-617	2.2	1974.09 - 1976.07		6010.95D
2200 D	M22-621	2.2	1975.10 - 1979.02		6010.88D
2400	M23-623	2.3	1976.08 - 1980.06		6010.95D
2500 D	M25-629	2.5	1978.02 - 1985.08		6010.95D

LNA

1.1	109/5E	1.1	1982.07 - 1985.04		6010.88D
-----	--------	-----	-------------------	--	----------

VISA

0.6	V06/665	0.6	1982.07 - 1991.03		6010.92D
11 E	109/5F, 109K	1.1	1978.09 - 1991.03		6010.88D
14 GT	150B (XY8)	1.4	1982.03 - 1991.03		6010.88D

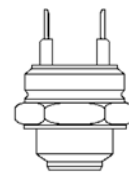

DACIA

	Motor Engine Moteur	Ltr. Ltr. Ltr.	Jahr Year Année	Einschränkung Restriction* Restriction*	Thermoschalter Thermostatich Thermocontact
1300					
1.3	810-02/-99	1.3	1972.12 - 1983.05		6010.92D
1310					
1.3	810-02/-99	1.3	1983.05 -		6010.92D

DAEWOO

Motor
Engine
Moteur

Ltr.
Ltr.
Ltr.

Jahr
Year
Année

Einschränkung
Restriction*
Restriction*

Thermoschalter
Thermoswitches
Thermocontact

NEXIA (KLETN)

1.5	G15MF	1.5	1995.02 - 1997.08		6010.92D
1.5 16V	A15MF	1.5	1995.02 - 1997.08		6010.92D

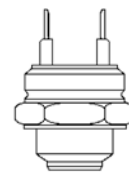

FIAT

	Motor Engine Moteur	Ltr. Ltr. Ltr.	Jahr Year Année	Einschränkung Restriction* Restriction*	Thermaschalter Thermoswitches Thermocontact
124 Spider					
1600 Sport (BS)		1.6	1969.11 - 1973.08		6010.92D
1600 Sport (BS1)	132 AC.000	1.6	1969.01 - 1974.12		6010.92D
1600 Sport (CS)	132 AC.000	1.6	1969.01 - 1974.12		6010.92D
1800 Rally Abarth (CSA)		1.7	1972.09 - 1975.07		6010.92D
1800 Sport (CS1)		1.8	1972.01 - 1977.12		6010.92D
1800 Sport (CS1)		1.7	1973.01 - 1975.07		6010.92D
127					
0.9	100 GL.000, 100 GL.048	0.9	1971.06 - 1983.05		6010.88D
1.0	127 A.000, 127 A1.000	1.0	1977.01 - 1986.12		6010.88D
1.3 Diesel	127 A5.000	1.3	1981.04 - 1986.12		6010.88D
1.3 Sport	127 A3.000	1.3	1981.12 - 1983.05		6010.88D
128					
1.1	128 A.000, 128 A.048	1.1	1969.03 - 1984.12		6010.88D
1.3	128 A1.000	1.3	1971.09 - 1984.12		6010.92D
131					
1.3 Mirafiori	131 A6.000	1.3	1974.10 - 1981.09 1974.10 - 1982.12		6010.88D 6010.92D
1.3 Mirafiori (AF)	131 A6.000	1.3	1975.03 - 1978.12		6010.88D
1.3 Super Mirafiori	131 B.000	1.3	1978.03 - 1980.12		6010.88D
1.4 Mirafiori	131 C.000, 131 C1.000	1.4	1980.11 - 1984.01		6010.88D
1.6	131 C2.000	1.6	1976.11 - 1985.04		6010.88D
1.6 (S)	131 A1.000	1.6	1974.10 - 1981.09		6010.88D
1.6 CL (AF1)	131 A1.000	1.6	1975.03 - 1978.12		6010.88D
1.6 Super	131 C3.000	1.6	1978.03 - 1984.01 1979.12 - 1981.12		6010.88D 6010.92D
1.6 Super Mirafiori (A)	131 B1.000	1.6	1979.03 - 1982.03		6010.88D
2.0 Racing	131 B2.000	2.0	1978.06 - 1981.12		6010.88D
2.0 Super	131 C4.000	2.0	1981.01 - 1984.12		6010.88D
2.5 Diesel	8144.61	2.5	1978.06 - 1984.02		6010.88D
2.5 Super Diesel (AF)	8144.61	2.5	1979.03 - 1984.12		6010.88D
132					
1.6	132 BB OA O, 132 C.000, 132 C6.000	1.6	1972.04 - 1982.12		6010.88D
1.7	132 B1.000	1.7	1972.04 - 1977.01		6010.88D
2.0	132 C2.000	2.0	1977.05 - 1981.06		6010.88D
2.0 GLS	132 C2.000	2.0	1976.01 - 1976.12		6010.92D
2.0 i.e.	132 C3.000	2.0	1980.01 - 1982.12		6010.88D
ARGENTA (132A)					
1600	132 D.000	1.6	1981.04 - 1985.12		6010.95D
2000	132 C2.000, 132 D1.000	2.0	1978.06 - 1985.12		6010.95D
2000 i.e.	132 C3.000	2.0	1981.06 - 1986.07		6010.95D
2500 Diesel	8144.61	2.5	1981.06 - 1985.11		6010.88D
2500 Turbodiesel	8144.61.500.81	2.4	1983.07 - 1985.08		6010.88D
BRAVA, BRAVO (182)					
1.2 16V 80	182 B2.000, 188 A5.000	1.2	1998.12 - 2001.10	ohne Klimaanlage	6031.92D
1.4 (182.AA)	182 A3.000	1.4	1995.10 - 2001.10 1995.10 - 2001.10	ohne Klimaanlage	6031.92D 6035.92D
1.4 (182.AG)	182 A5.000	1.4	1995.10 - 2001.10 1995.10 - 2001.10	ohne Klimaanlage mit Klimaanlage	6031.92D 6035.92D
1.4 (182.BG)	182 A5.000	1.4	1995.10 - 2001.10 1995.10 - 2001.10	ohne Klimaanlage mit Klimaanlage	6031.92D 6035.92D

FIAT

	Motor Engine Moteur	Ltr. Ltr. Ltr.	Jahr Year Année	Einschränkung Restriction* Restriction*	Thermoschalter Thermoswitches Thermocontact
1.4 12 V	182 A3.000	1.4	1995.10 - 1998.08 1995.10 - 1998.08	ohne Klimaanlage mit Klimaanlage	6031.92D 6035.92D
1.6 16V	182 A4.000, 182 A6.000	1.6	1995.10 - 2001.10 1995.10 - 2001.10	ohne Klimaanlage mit Klimaanlage	6031.92D 6035.92D
1.8 GT	182 A2.000	1.8	1995.10 - 2001.10	ohne Klimaanlage	6031.92D
1.9 JTD	182 B9.000	1.9	2000.09 - 2001.10	mit Klimaanlage	6035.92D
1.9 JTD 105	182 B4.000	1.9	1998.12 - 2001.10		6031.92D
1.9 TD 100 S	182 A7.000	1.9	1996.03 - 2001.10	mit Klimaanlage	6035.92D
1.9 TD 75 S	182 A8.000	1.9	1996.03 - 2001.10	mit Klimaanlage	6035.92D
2.0 HGT 20V	182 A1.000	2.0	1995.10 - 1998.07	ohne Klimaanlage	6031.92D
CINQUECENTO (170)					
0.7 (170AA)	170 A.000	0.7	1991.12 - 1996.01		6031.97D
0.7 i (170AD)	170 A.046	0.7	1994.07 - 1998.01		6031.97D
0.9 (170AB)	170 A1.000	0.9	1991.07 - 1993.12		6031.97D
0.9 i.e. (170AC)	170 A1.046	0.9	1991.07 - 1993.12		6031.97D
0.9 i.e. S (170AF, 170CF)	1170 A1.000, 1170 A1.046	0.9	1991.07 - 1999.07		6031.97D
1.1 Sporting (170AH)	176 B2.000	1.1	1994.10 - 1998.01		6031.97D
COUPE					
1.8 16V	183 A1.000	1.8	1996.03 - 2000.08		6035.92D
2.0 16V	836 A3.000	2.0	1993.11 - 1996.08 1993.11 - 1996.08	ohne Klimaanlage mit Klimaanlage	6031.92D 6035.92D
2.0 16V Turbo	175 A1.000	2.0	1993.11 - 1996.08 1993.11 - 1996.08	ohne Klimaanlage mit Klimaanlage	6031.92D 6035.92D
2.0 20V	182 A1.000, 182 B3.000	2.0	1996.08 - 2000.08 1996.08 - 2000.08	ohne Klimaanlage mit Klimaanlage	6031.92D 6035.92D
2.0 20V Turbo	175 A3.000	2.0	1996.08 - 2000.08 1996.08 - 2000.08	ohne Klimaanlage mit Klimaanlage	6031.92D 6035.92D
CROMA (154)					
1600	154 A.048	1.6	1986.07 - 1989.06		6031.92D
2000 16V	154 E1.000	2.0	1992.08 - 1996.08		6035.92D
2000 CHT		2.0	1991.01 - 1992.09		6031.92D
2000 CHT (154.AC)	154 A1.000	2.0	1985.12 - 1989.02		6035.92D
2000 i.e.	154 C3.000, 154 C3.046, 834 B.000, 834 B.048, 834 B.146	2.0	1986.03 - 1996.08		6035.92D
2000 i.e. Turbo	154 A2.000, 154 C4.046, 834 C.146	2.0	1985.12 - 1996.08		6035.92D
2500 D	8144.67	2.5	1985.12 - 1989.12		6017.85D
2500 TD (154.AE)	8144.91.2000	2.4	1985.12 - 1989.08		6017.85D
DUCATO (290)					
2.0	170 D	2.0	1992.05 - 1994.05		6031.92D
DUNA (146 B)					
60 1.1	146 A6.000	1.1	1987.01 - 1991.12		6031.92D
70 1.3	146 A5.000	1.3	1987.01 - 1991.12		6031.92D
DS 1.7	149 B3.000	1.7	1987.01 - 1991.12		6040.88
ELBA					
1.3		1.3	1986.04 - 1993.12		6031.92D
1.5	149 C1.000	1.5	1986.04 - 1996.12	149C1.000	6035.92D
1.6	159 A3.000	1.6	1989.04 - 1996.12		6035.92D
1.7 D	146 B2.000	1.7	1989.04 - 1996.12		6040.88
FIORINO (127)					
1050	127 A.000	1.0	1980.01 - 1987.12		6010.88D

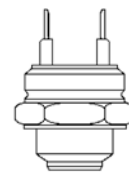
FIAT

	Motor Engine Moteur	Ltr. Ltr. Ltr.	Jahr Year Année	Einschränkung Restriction* Restriction*	Thermoschalter Thermostatich Thermocontact
FIORINO (146 Uno)					
60 1.1	146 A9.000	1.1	1988.05 - 1993.12		6031.92D
60 1.7 D	146 B2.000, 149 B3.000	1.7	1988.05 - 2000.05		6040.88
65 1.7 TD	146 D7.000	1.7	1997.01 - 2001.05	ohne Klimaanlage	6040.88
70 1.3	146 A5.000	1.3	1988.01 - 1994.12		6031.92D
70 i.e. 1.4	146 C5.000, 146 D5.000	1.4	1994.05 - 2001.05		6035.92D
75 i.e. 1.5	149 C1.000	1.5	1988.05 - 1993.12 1988.05 - 1993.12		6010.88D 6031.92D
75 i.e. 1.6	146 C6.000, 146 D6.000	1.6	1993.10 - 2001.05		6035.92D
FIORINO (147)					
1.0	127 A.000	1.0	1980.01 - 1987.12		6010.88D
1.1	146 A9.000	1.1	1986.11 - 1988.04		6031.92D
1.3	146 A5.000	1.3	1987.12 - 1993.08		6031.92D
1.3 D	127 A5.000	1.3	1982.03 - 1987.12		6040.88
FIORINO (146 Uno)					
1.4	146 D5.000	1.4	1994.05 - 2001.05		6035.92D
FIORINO (147)					
1.5	149 C1.000	1.5	1988.01 - 1993.08		6031.92D
FIORINO (146 Uno)					
1.6	146 C6.000, 146 D6.000	1.6	1994.01 - 2001.05		6035.92D
FIORINO (147)					
1.7 D	149 B2.000, 149 B3.000	1.7	1987.12 - 1990.12		6010.88D
FIORINO (146 Uno)					
1.7 TD	146 D7.000	1.7	1997.01 - 2001.05	ohne Klimaanlage	6040.88
MAREA (185)					
1.2 16V	182 B2.000	1.2	1998.10 - 1998.10 -	ohne Klimaanlage mit Klimaanlage	6031.92D 6035.92D
1.4 80 12V	182 A3.000	1.4	1996.09 - 1996.09 -	ohne Klimaanlage mit Klimaanlage	6031.92D 6035.92D
1.6 100 16V	182 A4.000	1.6	1996.09 - 1996.09 -	ohne Klimaanlage mit Klimaanlage	6031.92D 6035.92D
1.6 100 16V Bipower	185 A3.000, 186 A4.000	1.6	1999.04 - 1999.04 -	ohne Klimaanlage mit Klimaanlage	6031.92D 6035.92D
1.8 115 16V	182 A2.000	1.8	1996.09 - 1996.09 -	ohne Klimaanlage mit Klimaanlage	6031.92D 6035.92D
1.9 TD 100	182 A7.000	1.9	1996.09 - 1996.09 -	ohne Klimaanlage mit Klimaanlage	6031.92D 6035.92D
1.9 TD 75	182 A8.000	1.9	1996.09 -	mit Klimaanlage	6035.92D
2.0 150 20V	182 A1.000	2.0	1996.09 - 1999.04 1996.09 - 1999.04	ohne Klimaanlage mit Klimaanlage	6031.92D 6035.92D
PALIO					
1.0		1.0	1996.04 -		6031.92D
1.2	176 A8.000, 178 B5.000, 178 E2.000	1.2	1998.06 - 1998.06 -	ohne Klimaanlage mit Klimaanlage	6031.92D 6035.92D
1.2 (178DX.G1A)	178 B5.000	1.2	1996.04 - 2001.02 1996.04 - 2001.02	ohne Klimaanlage mit Klimaanlage	6031.92D 6035.92D
1.2 (178DYA1A)	188 A4.000	1.2	2001.02 - 2001.02 -	ohne Klimaanlage mit Klimaanlage	6031.92D 6035.92D
1.4	178 B2.000, 178 B2.016	1.4	1996.04 - 1996.04 -	ohne Klimaanlage mit Klimaanlage	6031.92D 6035.92D

FIAT

	Motor Engine Moteur	Ltr. Ltr. Ltr.	Jahr Year Année	Einschränkung Restriction* Restriction*	Thermoschalter Thermoswitches Thermocontact
1.5		1.5	1996.04 - 1998.06 1996.04 - 1998.06	ohne Klimaanlage mit Klimaanlage	6031.92D 6035.92D
1.6 16V	178 B3.000	1.6	1996.04 - 1996.04 -	ohne Klimaanlage mit Klimaanlage	6031.92D 6035.92D
1.6 16V (178DX.D1A)	178 B3.000	1.6	1996.04 - 2001.02 1996.04 - 2001.02	ohne Klimaanlage mit Klimaanlage	6031.92D 6035.92D
1.6 16V (178DYC1A06)	182 B6.000	1.6	2001.02 - 2001.02 -	ohne Klimaanlage mit Klimaanlage	6031.92D 6035.92D
1.7 TD (178DX.H1A)	176 A3.000	1.7	1996.04 - 2001.03 1996.04 - 2001.03	ohne Klimaanlage mit Klimaanlage	6031.92D 6035.92D
1.9 D (178DYD1A07)	223 A6.000	1.9	2001.03 - 2001.03 -	ohne Klimaanlage mit Klimaanlage	6031.92D 6035.92D

PANDA

650	141 A.000	0.7	1982.01 - 2004.07		6010.95D
750	141 B.000, 156 A4.000, 156 A4.048	0.8	1991.06 - 1997.12		6031.92D
800		0.8	1981.02 - 1985.12		6010.95D
900	100 GL3.000, 1170 A1.046, 146 A.000	0.9	1980.10 - 1994.06 1992.04 - 1996.12		6010.95D 6031.92D
950	A 112 B1.054	1.0	1982.09 - 1986.12		6010.95D
1000	141 C2.000, 156 A2.100, 156 A2.246, 156 A3.000, 156 A3.100	1.0	1985.01 - 1994.12		6031.92D
1000 i.e	156 A2.246	1.0	1992.08 - 2004.02		6031.92D
1000 i.e.	141 C2.000, 156 A2.246	1.0	1987.10 - 1998.08		6031.92D
1100	156 C.046, 176 B2.000, 187 A1.000	1.1	1991.05 - 2004.07		6031.92D

PUNTO (176)

1.1	176 B2.000	1.1	1996.04 - 2000.02	ohne Klimaanlage	6031.92D
1.4 GT Turbo	176 A4.000, 176 B6.000	1.4	1994.01 - 1999.09		6010.92D
55 1.1	176 A6.000, 176 B2.000	1.1	1993.09 - 1999.09	ohne Klimaanlage	6031.92D
60 1.2	176 A7.000, 176 B1.000, 176 B4.000	1.2	1994.01 - 1999.09	ohne Klimaanlage	6031.92D
75 1.2	176 A8.000	1.2	1993.10 - 1999.09 1993.10 - 1999.09	ohne Klimaanlage mit Klimaanlage	6031.92D 6035.92D
85 16V 1.2	176 B9.000	1.2	1997.04 - 2000.06 1997.04 - 2000.06	ohne Klimaanlage mit Klimaanlage	6031.92D 6035.92D
90 1.6	176 A9.000	1.6	1994.01 - 1997.04		6010.92D

REGATA

60 Diesel 1.7	138 B6.000, 149 B3.000	1.7	1983.09 - 1989.03		6017.85D
65 Diesel 1.9	149 A1.000	1.9	1984.04 - 1989.07		6017.85D
70 1.3	138 B2.000, 149 A3.000, 149 A7.000	1.3	1983.09 - 1989.07 1983.09 - 1986.07		6010.95D 6031.92D
75 1.5	138 B3.048, 138 C3.048	1.5	1983.12 - 1989.07		6010.95D
75 1.5 i.e.	138 C2.048, 149 C1.000	1.5	1985.07 - 1989.07 1986.12 - 1989.07		6010.95D 6031.92D
80 Turbo Diesel 1.9	831 D1.000	1.9	1986.05 - 1989.07		6017.85D
85 1.5	138 B3.000, 149 A5.000	1.5	1985.05 - 1987.12 1984.01 - 1989.04		6010.95D 6031.92D
85 1.6	149 A.000	1.6	1983.10 - 1990.06		6010.95D
85 Super 1.5	138 B3.000	1.5	1983.09 - 1985.04		6010.95D
90 i.e. 1.6	149 C2.000	1.6	1987.01 - 1989.07		6010.95D
100 1.6 (RF)	149 A4.000	1.6	1984.09 - 1986.12		6010.95D
100 i.e. 1.6	149 C3.000	1.6	1987.01 - 1990.12		6031.92D
100 Super 1.6	149 A2.000, 149 A4.000, 149 C3.000	1.6	1983.10 - 1990.12 1983.10 - 1989.07		6010.95D 6031.92D

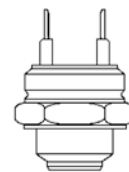
FIAT

	Motor Engine Moteur	Ltr. Ltr. Ltr.	Jahr Year Année	Einschränkung Restriction* Restriction*	Thermoschalter Thermostatich Thermocontact
RITMO I (138A)					
55 Diesel 1.7	138 A5.000	1.7	1979.10 - 1982.09		6017.85D
60 1.0	127 A6.000	1.0	1978.09 - 1982.09		6010.88D
65 1.3	138 A1.000	1.3	1978.01 - 1982.09		6010.88D
75 1.3	138 A3.000	1.3	1981.01 - 1982.09		6010.95D
75 i.e. 1.5	138 C2.048, 149 C1.000	1.5	1985.10 - 1987.05		6010.92D
85 1.5	138 A4.000	1.5	1981.01 - 1982.09		6010.95D
105 Sport 1.6	138 AR.000	1.6	1981.05 - 1982.12		6010.95D
125 TC Abarth 2.0	138 AR1.000	2.0	1981.11 - 1982.09		6010.95D
RITMO II (138A)					
60 1.1	138 B.000, 138 B1.000, 138 C1.000, 146 A4.048	1.1	1985.04 - 1987.12 1982.10 - 1985.10		6010.92D 6031.92D
70 1.3	138 B2.000	1.3	1983.01 - 1985.04		6010.92D
75 1.5	138 C2.048, 149 C1.000	1.5	1985.09 - 1988.12		6010.92D
RITMO Bertone Cabriolet					
85 1.5	138 A4.000, 138 B3.000	1.5	1980.01 - 1989.07		6031.92D
100 1.6	138 AR.000, 138 AR.048	1.6	1985.10 - 1987.12		6031.92D
SEICENTO (187)					
0.9	1170 A1.046	0.9	1998.01 -		6031.97D
1.1	176 B2.000, 187 A1.000	1.1	1998.01 -		6031.97D
SIENA					
1.2	178 B5.000	1.2	1998.09 - 1998.09 -	ohne Klimaanlage mit Klimaanlage	6031.92D 6035.92D
1.4	178 B2.000, 178 B2.016	1.4	1996.04 - 1996.04 -	ohne Klimaanlage mit Klimaanlage	6031.92D 6035.92D
1.6 16V	178 B3.000	1.6	1998.09 - 1998.09 -	ohne Klimaanlage mit Klimaanlage	6031.92D 6035.92D
STRADA (178E)					
1.2	178 B5.000, 188 A4.000	1.2	1999.06 - 1999.06 -	ohne Klimaanlage mit Klimaanlage	6031.92D 6035.92D
1.7 TD	176 A3.000	1.7	1999.06 -	ohne Klimaanlage	6031.92D
1.9 D	223 A6.000	1.9	2000.12 -	ohne Klimaanlage	6031.92D
TALENTO (290)					
2.0	170 B	2.0	1992.05 - 1994.03		6031.92D
TEMPRA (159)					
1.4 i.e.	159 A2.000, 160 A1.046, 836 A4.000	1.4	1991.03 - 1996.08	Motornummer →8742134	6035.92D
1.6	159 A3.000	1.6	1990.03 - 1993.04		6035.92D
1.6 i.e.	159 A3.046, 159 A3.048, 159 B9.000, 835 C1.000	1.6	1990.06 - 1996.08		6035.92D
1.8	159 A4.000	1.8	1992.07 - 1993.06		6035.92D
1.8 i.e.	159 A4.046, 835 C2.000, 835 C4.000, 836 A5.000	1.8	1992.03 - 1993.12 1990.03 - 1996.08	ohne Klimaanlage mit Klimaanlage	6031.92D 6035.92D
1.9 D	149 A1.000, 160 A7.000	1.9	1991.07 - 1996.08		6017.85D
1.9 TD	160 A6.000, 160 B6.046, 160 D1.000	1.9	1990.05 - 1996.08		6017.85D
2.0 i.e.	159 A6.046	2.0	1990.10 - 1996.08		6035.92D
2.0 i.e.	159 A6.046	2.0	1991.01 - 1995.03		6035.92D

FIAT

	Motor Engine Moteur	Ltr. Ltr. Ltr.	Jahr Year Année	Einschränkung Restriction* Restriction*	Thermoschalter Thermoswitches Thermocontact
TIPO (160)					
1.1	160 A3.000	1.1	1988.01 - 1991.10 1991.10 - 1991.10	ohne Klimaanlage mit Klimaanlage	6031.92D 6035.92D
1.4	160 A1.000, 160 A1.048	1.4	1987.07 - 1989.12		6035.92D
1.4 i.e.	159 A2.000, 160 A1.046, 836 A4.000	1.4	1989.05 - 1995.04	mit Klimaanlage	6035.92D
1.6	160 A2.000	1.6	1991.10 - 1991.10	mit Klimaanlage	6035.92D
1.6 i.e.	149 C2.046, 159 A3.046, 159 A3.048, 835 C1.000	1.6	1988.02 - 1993.01 1991.10 - 1995.04	ohne Klimaanlage mit Klimaanlage	6031.92D 6035.92D
1.6 SX DGT	159 A3.000	1.6	1989.05 - 1992.10	mit Klimaanlage	6035.92D
1.7 D	149 B4.000	1.7	1988.01 - 1995.10		6017.85D
1.8 i.e	836 A5.000	1.8	1993.03 - 1995.04		6031.92D
1.8 i.e.	159 A4.000, 159 A4.046, 835 C2.000, 835 C4.000	1.8	1990.10 - 1995.04 1990.10 - 1995.04	ohne Klimaanlage mit Klimaanlage	6031.92D 6035.92D
1.8 i.e. 16V Sport	160 A5.000	1.8	1989.11 - 1992.06		6031.92D
1.9 D	149 A1.000, 160 A7.000	1.9	1991.07 - 1996.08		6017.85D
1.9 TD (160.AW)	160 B6.046	1.9	1992.03 - 1993.06		6017.85D
1.9 TD (160.EL, 160.GL, 160.AQ, 160.EI, 160.AR)	160 A6.000, 160 A6.046, 160 D1.000	1.9	1990.09 - 1995.04		6017.85D
2.0 16V (160.AV)	160 A8.046	2.0	1991.07 - 1995.04		6035.92D
2.0 i.e. (160.AJ)	159 A5.046	2.0	1990.06 - 1992.03 1990.06 - 1992.03		6031.92D 6035.92D
2.0 i.e. (160.AT, 160.AJ)	159 A6.046	2.0	1990.03 - 1995.04 1990.03 - 1995.04		6031.92D 6035.92D
2.0 i.e. 16V Sport (160.EF)	836 A3.000	2.0	1993.03 - 1995.04	ohne Klimaanlage	6035.92D
UNO (146A/E)					
1.3 Super Diesel	127 A5.000, 146 B1.000	1.3	1983.06 - 1992.03		6017.85D
1.3 Turbo i.e.	146 A2.000, 146 A2.146, 146 A2.246	1.3	1985.04 - 1989.08 1989.09 - 1991.03		6031.92D 6033.88
1.4 Turbo i.e.	146 A8.000, 146 A8.046	1.4	1989.12 - 1996.12 1989.09 - 1993.09		6031.92D 6033.88
1.6	159 A3.046	1.6	1989.12 - 1993.12 1989.12 - 1993.12	ohne Klimaanlage mit Klimaanlage	6031.92D 6035.92D
1.6 R		1.6	1992.12 - 1995.12 1992.12 - 1995.12	ohne Klimaanlage mit Klimaanlage	6031.92D 6035.92D
1.9 D	149 B5.046	1.9	1989.09 - 1994.03		6040.88
45 0.9	146 A.000, 146 A.1000	0.9	1983.03 - 1992.09		6010.95D
45 1.0 (146A.ED)	156 A2.048, 156 A2.100	1.0	1986.06 - 1993.12		6031.92D
45 i.e. 1.0	156 A2.246	1.0	1984.04 - 1995.10		6031.92D
50 1.1	146 A4.044, 156 C.046	1.1	1986.01 - 1993.12 1990.01 - 1993.12	ohne Klimaanlage mit Klimaanlage	6031.92D 6035.92D
50 i.e. 1.1	146 C3.000	1.1	1992.06 - 1993.12 1992.06 - 1993.12	ohne Klimaanlage mit Klimaanlage	6031.92D 6035.92D
55 1.0		1.0	1994.04 - 2000.08		6031.92D
55 1.1	138 B.000	1.1	1983.01 - 1989.08		6031.92D
60 1.1	146 A4.048, 160 A3.000	1.1	1985.05 - 1992.12 1989.04 - 1992.12	mit Klimaanlage mit Klimaanlage	6031.92D 6035.92D
60 Diesel 1.7	146 B2.000, 149 B3.000	1.7	1986.07 - 1989.08 1989.09 - 1993.12		6017.85D 6040.88
70 1.3	138 B2.000, 149 A7.000	1.3	1983.01 - 1989.08		6031.92D
70 i.e. 1.4	146 C1.000, 160 A1.046	1.4	1989.09 - 1993.12 1989.09 - 1993.12	ohne Klimaanlage mit Klimaanlage	6031.92D 6035.92D
70 S 1.4	160 A1.048	1.4	1989.09 - 1992.10 1989.09 - 1992.10	ohne Klimaanlage mit Klimaanlage	6031.92D 6035.92D
70 TD 1.4	146 B.000, 146 B3.000	1.4	1986.10 - 1990.10		6017.85D
75 i.e. 1.5	138 C2.048, 149 C1.000	1.5	1985.10 - 1993.12 1985.10 - 1993.12	ohne Klimaanlage mit Klimaanlage	6031.92D 6035.92D

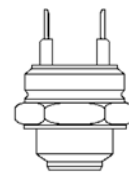
**FIAT**

	Motor Engine Moteur	Ltr. Ltr. Ltr.	Jahr Year Année	Einschränkung Restriction* Restriction*	Thermoschalter Thermoswitches Thermocontact
X 1/9 (128 AS)					
1.3	128 AS.000	1.3	1975.10 - 1978.06		6010.92D
1.3 Exclusiv Serie	128 AS.000	1.3	1973.05 - 1979.12		6010.92D
1.5 Five Speed	138 AS.000, 138 BS.031	1.5	1978.11 - 1989.12		6010.92D

FORD

	Motor Engine Moteur	Ltr. Ltr. Ltr.	Jahr Year Année	Einschränkung Restriction* Restriction*	Thermoschalter Thermoswitches Thermocontact
ESCORT III / IV 1980 --> 1990					
1.1	GLB, GMA, GPA, GSE, GSG	1.1	1980.09 - 1990.07		6010.95D
1.3	JBB, JLA, JLB, JPA	1.3	1980.09 - 1990.07		6010.95D
1.4	F6B, F6D, FUA, FUC	1.4	1986.01 - 1990.07		6010.88D
1.6	LP1, LPA, LUA, LUG	1.6	1980.09 - 1990.07		6010.95D
1.6 i	L4B, LJB	1.6	1985.07 - 1990.07		6010.95D
ESCORT V / VI / VII / Classic 1990 -->					
RS 2000	N7A	2.0	1995.02 - 1998.10		6010.95D
GALAXY					
1.9 TDI	1Z, AFN, AHU, ANU, ASZ, AUJ, AVG	1.9	1995.03 - 2006.05		6037.95D
2.8 V6	AYL	2.8	2000.04 - 2006.05		6037.95D
2.8 i V6	AAA, AMY	2.8	1995.11 - 2000.04		6037.95D
SIERRA					
1.6	LCS, LCT, LSD, LSE, LSF	1.6	1982.08 - 1993.02		6010.88D
1.6 i	L6B	1.6	1989.10 - 1993.02		6010.88D
1.8	R2A, R2C, R6A, REB, RED, REF	1.8	1984.10 - 1993.02		6010.88D
1.8 TD	RFA, RFB, RFL	1.8	1988.08 - 1993.02		6010.88D
2.0	N8C, N9C, NES, NET, NR2, NRB, NRD, NYT	2.0	1982.08 - 1993.02		6010.88D
2.0 16V Cosworth	N5C, N5D	2.0	1990.01 - 1993.02		6010.88D
2.0 i	N4A, N4B, N4I, N8A, N9B, N9C, NE5, NEJ, NR2, NRB	2.0	1985.03 - 1993.02		6010.88D
2.0 RS Cosworth	N5B	2.0	1987.11 - 1990.01		6010.88D
2.3	YYT	2.3	1982.08 - 1986.12		6010.88D
2.3 D	YTR, YTT	2.3	1982.08 - 1993.02		6010.88D
2.8	PRG	2.8	1987.01 - 1988.08		6010.88D
2.8 i XR	PRG	2.8	1987.01 - 1988.08		6010.88D
2.8 XR	PRT	2.8	1985.02 - 1986.12		6010.88D
2.8 XR4i	PR6, PRT	2.8	1982.08 - 1986.12		6010.88D
2.9	B4B, B4C	2.9	1988.08 - 1993.02		6010.88D
2.9 i	B4B, B4C	2.9	1988.08 - 1993.02		6010.88D
2.9 i XR	B4A, B4B, B4C	2.9	1988.08 - 1993.02		6010.88D

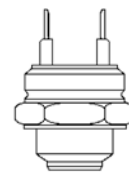

INNOCENTI

	Motor Engine Moteur	Ltr. Ltr. Ltr.	Jahr Year Année	Einschränkung Restriction* Restriction*	Thermoschalter Thermoswitches Thermocontact
MINI					
0.55	Daihatsu-EB	0.6	1987.01 - 1991.12		6010.92D
0.65		0.7	1984.01 - 1995.01		6010.92D
1.0	BLM C 99 H	1.0	1974.05 - 1991.10		6010.92D
1.3	BLM C 12 H	1.3	1976.08 - 1982.02		6010.92D
1.3 De Tomaso	BLM C 12 HH	1.3	1976.08 - 1982.02		6010.92D

JAGUAR
**Motor
Engine
Moteur**
**Ltr.
Ltr.
Ltr.**
**Jahr
Year
Année**
**Einschränkung
Restriction*
Restriction***
**Thermoschalter
Thermoswitches
Thermocontact**
XJ

12 5.3	V 12 (75-79)	5.3	1972.06 - 1989.09		6010.92D
12 H.E.	V 12 (82-90)	5.3	1981.09 - 1992.12		6010.92D
Sovereign V12	7P, V 12 (90-93, 197KW)	5.3	1985.07 - 1992.12		6010.92D

XJS / XJSC

5.3	8C (88-92), 8S (92-93), V 12 (90-93, 197KW), V 12 (90-93, 211KW)	5.3	1975.09 - 1993.08		6010.92D
5.3 H.E.	8S (86-88), V 12 (82-90)	5.3	1981.07 - 1992.05		6010.92D

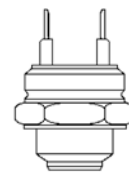

LADA

	Motor Engine Moteur	Ltr. Ltr. Ltr.	Jahr Year Année	Einschränkung Restriction* Restriction*	Thermoschalter Thermostat Thermocontact
1200 / 1300 / 1500 / 1600					
1200	BA3 2101	1.2	1970.01 - 1986.06		6010.92D
1300	BA3 21011, BA3 2105	1.3	1974.08 - 1987.01		6010.92D
1500	BA3 2103	1.4	1972.09 - 1986.10		6010.92D
1600	BA3 2106	1.6	1972.09 - 1986.10		6010.92D
NIVA (2121)					
1600	BA3 2121	1.6	1976.12 - 1995.03		6010.92D
1700 i	BA3 21214	1.7	1996.06 -		6010.92D
NOVA					
1300	BA3 2105	1.3	1985.09 - 1990.12		6010.92D
1500	BA3 2103, BA3 2103 (KAT)	1.4	1985.03 - 1993.02		6010.92D
1600	BA3 2106	1.6	1988.01 -		6010.92D
1700		1.7	1994.08 -		6010.92D
1700 i		1.7	1996.06 -		6010.92D
SAMARA (2108, 2109)					
1100	BA3 21081, BA3 21081 (KAT)	1.1	1988.02 - 1994.12		6010.92D
1300	BA3 2108, BA3 2108 (KAT), BA3 21115	1.3	1986.01 - 1994.12		6010.92D
1500	BA3 21083, BA3 21083 (KAT), BA3 2111	1.5	1988.01 -		6010.92D
SAMARA FORMA					
1100	BA3 21081 (KAT)	1.1	1991.07 -		6010.92D
1300	BA3 2108	1.3	1989.05 - 1997.07		6010.92D
1500	BA3 21083, BA3 21083 (KAT), BA3 2111	1.5	1991.07 -		6010.92D

LANCIA

	Motor Engine Moteur	Ltr. Ltr. Ltr.	Jahr Year Année	Einschränkung Restriction* Restriction*	Thermoschalter Thermoswitches Thermocontact
BETA (828)					
1300	828 D3.000	1.4	1981.12 - 1984.12		6010.88D
1600	828 B.000	1.6	1973.08 - 1984.12		6010.88D
2000	828 B1.000	2.0	1976.04 - 1986.10	828 B1.000	6010.88D
2000 i.e.	828 B4.000	2.0	1981.05 - 1984.12	828 B4.000	6010.88D
2000 Volumex		2.0	1983.07 - 1984.09		6010.88D
2000 VX		2.0	1983.07 - 1984.12		6010.88D
DEDRA (835)					
1.6	159 B9.000	1.6	1994.10 - 1999.07	ohne Klimaanlage	6031.92D
			1994.10 - 1999.07	mit Klimaanlage	6035.92D
1.6 16V	182 A4.000	1.6	1996.01 - 1999.07	ohne Klimaanlage	6031.92D
			1996.01 - 1999.07	mit Klimaanlage	6035.92D
1.6 i.e.	835 A1.000, 835 A1.046, 835 C1.000	1.6	1989.08 - 1999.07	ohne Klimaanlage	6031.92D
1.6 LE	159 B9.000	1.6	1994.07 - 1999.07	ohne Klimaanlage	6031.92D
			1994.07 - 1999.07	mit Klimaanlage	6035.92D
1.8 16V LE	182 A2.000	1.8	1996.03 - 1999.07	ohne Klimaanlage	6031.92D
			1996.03 - 1999.07	mit Klimaanlage	6035.92D
1.8 GT 16V	183 A1.000	1.8	1996.03 - 1999.07	ohne Klimaanlage	6031.92D
			1996.03 - 1999.07	mit Klimaanlage	6035.92D
1.8 i.e.	835 A2.000, 835 A2.046, 835 C5.000, 836 A5.000	1.8	1989.09 - 1999.07	ohne Klimaanlage Schaltgetriebe	6031.92D
			1989.09 - 1999.07	ohne Klimaanlage Automatikgetriebe	6035.92D
2.0 Integrale	836 A3.000	2.0	1994.07 - 1999.07	ohne Klimaanlage	6031.92D
			1994.07 - 1999.07	mit Klimaanlage	6035.92D
2.0 16V	836 A3.000	2.0	1994.07 - 1999.07	ohne Klimaanlage	6031.92D
			1994.07 - 1999.07	mit Klimaanlage	6035.92D
2.0 HF Integrale	835 A7.046	2.0	1990.11 - 1994.07	ohne Klimaanlage	6031.92D
			1990.11 - 1994.07	mit Klimaanlage	6035.92D
2.0 i.e.	835 A5.000, 835 A5.046	2.0	1989.09 - 1999.07	ohne Klimaanlage Schaltgetriebe	6031.92D
			1989.09 - 1999.07	ohne Klimaanlage Automatikgetriebe	6035.92D
2.0 i.e. Turbo	835 A8.046	2.0	1991.04 - 1999.07	ohne Klimaanlage	6031.92D
			1991.04 - 1999.07	mit Klimaanlage	6035.92D
2.0 i.e. Turbo Integrale	835 A7.000	2.0	1990.05 - 1994.07	ohne Klimaanlage	6031.92D
			1990.05 - 1994.07	mit Klimaanlage	6035.92D
2.0 Turbo	835 A8.000	2.0	1990.11 - 1994.06	ohne Klimaanlage	6031.92D
			1990.11 - 1994.06	mit Klimaanlage	6035.92D
DELTA I (831AB0)					
1.3	831 A2.000, 831 B.000	1.3	1979.09 - 1992.08		6010.88D
1.5	831 A1.000, 831 B1.000	1.5	1979.09 - 1992.12		6010.88D
1.6 GT i.e.	149 C2.000, 831 B7.000	1.6	1987.05 - 1992.08		6010.95D
			1986.08 - 1988.08		6017.85D
1.6 HF Turbo	831 B3.000, 831 B7.046	1.6	1986.08 - 1993.05		6017.85D
1.9 Turbo DS	831 D1.000	1.9	1986.10 - 1989.12		6017.85D
2.0 16V HF Evo Integrale	831 E5.000, 831 E5.046	2.0	1993.06 - 1994.01		6017.85D
2.0 16V HF Integrale	831 D5.000	2.0	1989.03 - 1991.09		6017.85D
2.0 HF Integrale	831 B5.000, 831 C5.000, 831 C5.046	2.0	1986.11 - 1992.12		6017.85D
DELTA II (836)					
1.4 i.e. (836AF, 836AH)	160 A1.046, 836 A4.000	1.4	1994.10 - 1999.08		6035.92D
1.6 i.e. (836AD)	835 C1.000	1.6	1993.06 - 1999.08		6035.92D

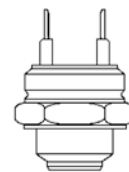

LANCIA

	Motor Engine Moteur	Ltr. Ltr. Ltr.	Jahr Year Année	Einschränkung Restriction* Restriction*	Thermaschalter Thermaswitches Thermocontact
1.6 i.e. (836AP)	182 A6.000	1.6	1996.03 - 1999.08 1996.03 - 1999.08	ohne Klimaanlage mit Klimaanlage	6031.92D 6035.92D
1.6 i.e. 16V (836AO)	182 A4.000	1.6	1996.01 - 1999.08 1996.01 - 1999.08	ohne Klimaanlage mit Klimaanlage	6031.92D 6035.92D
1.8 i.e. (836AE)	835 C2.000	1.8	1993.06 - 1999.08 1993.06 - 1999.08	ohne Klimaanlage mit Klimaanlage	6031.92D 6035.92D
1.8 i.e. (836AG, 836AL)	835 C4.000, 836 A6.000, 836 C4.000	1.8	1994.07 - 1999.08 1994.07 - 1999.08	ohne Klimaanlage mit Klimaanlage	6031.92D 6035.92D
1.8 i.e. 16V (836AQ)	182 A2.000	1.8	1996.03 - 1999.08 1996.03 - 1999.08	ohne Klimaanlage mit Klimaanlage	6031.92D 6035.92D
1.8 i.e. 16V GT (836AR)	183 A1.000	1.8	1996.03 - 1999.08 1996.03 - 1999.08	ohne Klimaanlage mit Klimaanlage	6031.92D 6035.92D
2.0 16V (836AA, 836CA)	836 A3.000	2.0	1993.06 - 1999.08 1993.06 - 1999.08	ohne Klimaanlage mit Klimaanlage	6031.92D 6035.92D
2.0 16V Turbo (836AB)	836 A2.000	2.0	1993.06 - 1999.08 1993.06 - 1995.12	ohne Klimaanlage mit Klimaanlage	6031.92D 6035.92D
2.0 16V Turbo (836AS)	175 A4.000	2.0	1996.07 - 1999.08	ohne Klimaanlage	6031.92D
FULVIA					
1.3		1.3	1968.09 - 1975.07		6010.88D
PRISMA (831AB0)					
1.3	831 A2.000	1.3	1983.01 - 1992.02		6010.88D
1.5	138 C2.048, 831 A1.000, 831 B1.000, 831 B1.048	1.5	1983.01 - 1992.02		6010.88D
1.6	831 B6.000	1.6	1986.08 - 1992.02		6010.88D
1.6 i.e.	831 B7.000	1.6	1986.05 - 1989.12		6010.88D
1.6 i.e. Super	149 C2.000	1.6	1987.05 - 1989.12		6010.88D
THEMA (834)					
2000 16V (834FA)	834 F1.000	2.0	1992.05 - 1994.07		6010.88D
2000 16V Turbo (834AC)	834 C1.000	2.0	1988.12 - 1990.06		6010.88D
2000 16V Turbo (834GC, 834FC)	834 F2.000	2.0	1992.10 - 1994.07		6010.88D
2000 i.e.	834 B.048	2.0	1986.03 - 1988.09		6010.88D
2000 i.e. (834B)	834 B.000	2.0	1984.11 - 1988.09		6010.88D
2000 i.e. (834BV)	834 B.146	2.0	1987.09 - 1992.05		6010.88D
2000 i.e. 16V (834AI)	834 B2.246	2.0	1989.02 - 1992.05		6010.88D
2000 i.e. 16V Turbo (834AL)	834 C1.246	2.0	1989.04 - 1993.03		6010.88D
2000 i.e. Turbo (834C)	834 C.000	2.0	1984.11 - 1987.12		6010.88D
2000 i.e. Turbo (834CV)	834 C.146	2.0	1986.07 - 1990.05		6010.88D
2000 Turbo	834 C.146	2.0	1989.01 - 1992.03		6010.88D
2000 Turbo 16V (834GC, 834FC)	834 F2.000	2.0	1992.11 - 1994.07		6010.88D
2500 Turbo D (834D)	8144.91	2.4	1984.11 - 1988.09		6010.85D
2500 Turbo DS (834AE)	8144.97	2.5	1988.06 - 1992.05		6010.85D
2500 Turbo DS (834AM)	8144.97S	2.5	1988.05 - 1992.07		6010.85D
2500 Turbo DS (834D)	8144.91	2.4	1987.03 - 1990.09		6010.85D
2500 Turbo DS (834FE, 834LE)	8144.97 Y	2.5	1992.05 - 1994.07		6010.85D
2850 V6 i.e. (834AD, 834CD, 834BD)	834 E.146	2.8	1988.06 - 1992.05		6017.85D
2850 V6 i.e. (834F)	834 E.000	2.8	1984.11 - 1988.09		6017.85D
TREVI (828DB)					
2000 i.e.	828 B4.000	2.0	1980.05 - 1987.01		6010.88D
2000 Volumex (828DB17)	828 B7.000	2.0	1983.08 - 1985.05		6010.88D
Y10 (156)					
1.0 Fire	156 A 2.000, 156 A 2.100, 156 A.000, 156 A2.246	1.0	1985.03 - 1992.02		6031.92D
1.0 Turbo	156 A 1.000	1.0	1985.03 - 1989.02		6031.92D

LANCIA

	Motor Engine Moteur	Ltr. Ltr. Ltr.	Jahr Year Année	Einschränkung Restriction* Restriction*	Thermoschalter Thermoswitches Thermocontact
1.1 Avenue	176 B2.000	1.1	1995.01 - 1995.12 1995.01 - 1995.12	ohne Klimaanlage mit Klimaanlage	6031.92D 6035.92D
1.1 i.e	156 C.000	1.1	1989.08 - 1992.06		6031.92D
1.1 i.e. Fire	156 C.046	1.1	1989.07 - 1995.12 1989.07 - 1995.12	ohne Klimaanlage mit Klimaanlage	6031.92D 6035.92D
1.3 i.e. Fire	146 A 5.046, 156 B.000	1.3	1987.11 - 1991.12		6031.92D

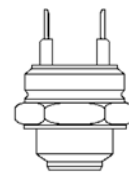
OPEL

	Motor Engine Moteur	Ltr. Ltr. Ltr.	Jahr Year Année	Einschränkung Restriction* Restriction*	Thermaschalter Thermostatiches Thermocontact
ASCONA C					
1.3 N	13 N	1.3	1981.09 - 1986.08		6010.95D
1.3 S	13 S	1.3	1981.09 - 1988.08		6010.95D
1.6	16 N, 16 SV	1.6	1981.09 - 1988.08		6010.95D
1.6 i	C 16 LZ, C 16 NZ, E 16 NZ	1.6	1986.09 - 1988.08		6010.95D
1.6 S	16 SH	1.6	1981.09 - 1986.08		6010.95D
1.8	E 18 NV	1.8	1987.09 - 1988.08		6010.95D
1.8 E	C 18 NE, S 18 NV	1.8	1985.01 - 1986.08		6010.95D
1.8 i	18 E	1.8	1982.09 - 1986.08		6010.95D
2.0 i	20 NE, C 20 NE, C 20 NEF	2.0	1986.09 - 1988.08		6010.95D
2.0 i GT	20 SEH	2.0	1987.03 - 1988.08		6010.95D
ASTRA F					
1.4	14 SE	1.4	1992.09 - 1998.01	mit Klimaanlage	6031.100D
			1992.09 - 1998.01	mit Klimaanlage	6031.88D
1.4 i	C 14 NZ	1.4	1991.09 - 1999.01	mit Klimaanlage	6031.100D
			1991.09 - 1999.01	mit Klimaanlage	6031.88D
1.4 i 16V	X 14 XE	1.4	1996.01 - 2001.03	mit Klimaanlage	6031.100D
			1996.01 - 2001.03	mit Klimaanlage	6031.88D
1.4 Si	C 14 SE	1.4	1992.03 - 2001.03	mit Klimaanlage	6031.100D
			1992.03 - 2001.03	mit Klimaanlage	6031.88D
1.6	16 LZ2, 16 NZR	1.6	1995.09 - 1998.01	mit Klimaanlage	6031.100D
			1995.09 - 1998.01	mit Klimaanlage	6031.88D
1.6 i	C 16 NZ, X 16 SZ, X 16 SZR	1.6	1991.09 - 2001.03	mit Klimaanlage	6031.100D
			1991.09 - 2001.03	mit Klimaanlage	6031.88D
1.6 i 16V	X 16 XEL	1.6	1994.08 - 1998.09	mit Klimaanlage	6031.100D
			1994.08 - 1998.09	mit Klimaanlage	6031.88D
1.6 Si	C 16 SE	1.6	1992.03 - 1994.12	mit Klimaanlage	6031.100D
			1992.03 - 1994.12	mit Klimaanlage	6031.88D
1.8 i	C 18 NZ	1.8	1991.09 - 1998.09	mit Klimaanlage	6031.100D
			1991.09 - 1998.09	mit Klimaanlage	6031.88D
1.8 i 16V	C 18 XE, C 18 XEL, X 18 XE	1.8	1993.06 - 2001.03	mit Klimaanlage	6031.100D
			1993.06 - 2001.03	mit Klimaanlage	6031.88D
2.0 GSI 16V	C 20 XE	2.0	1991.09 - 1998.01	mit Klimaanlage	6031.100D
			1991.09 - 1998.01	mit Klimaanlage	6031.88D
2.0 i	C 20 NE	2.0	1991.09 - 1998.09	mit Klimaanlage	6031.100D
			1991.09 - 1998.09	mit Klimaanlage	6031.88D
2.0 i 16V	C 20 XE, X 20 XEV	2.0	1993.03 - 1998.09	mit Klimaanlage	6031.100D
			1993.03 - 1998.09	mit Klimaanlage	6031.88D
CALIBRA A					
2.0 i	C 20 NE	2.0	1990.06 - 1997.07	mit Klimaanlage	6031.100D
			1990.06 - 1997.07	mit Klimaanlage	6031.88D
2.0 i 16V	C 20 XE, X 20 XEV	2.0	1990.06 - 1994.02	mit Klimaanlage	6031.100D
			1990.06 - 1997.07	mit Klimaanlage	6031.88D
2.0 i Turbo	C 20 LET	2.0	1992.03 - 1997.07	mit Klimaanlage	6031.100D
COMBO					
1.2	C 12 NZ, X 12 SZ	1.2	1994.07 - 2001.10		6031.100D
1.4	C 14 NZ, C 14 SE, X 14 SZ	1.4	1994.07 - 2001.10		6031.100D
1.4 16V	X 14 XE	1.4	1999.08 - 2001.10		6031.100D
CORSA A					
1.0	10 S	1.0	1982.09 - 1993.03	Chassis No →J4999999	6010.95D
			1982.09 - 1993.03	Chassis No K4000001→	6031.100D

OPEL

	Motor Engine Moteur	Ltr. Ltr. Ltr.	Jahr Year Année	Einschränkung Restriction* Restriction*	Thermoschalter Thermoswitches Thermocontact
1.2	12 NC, 12 ST, E 12 GV	1.2	1982.09 - 1990.08	Chassis No →J4999999	6010.95D
			1982.09 - 1990.08	Chassis No K4000001→	6031.100D
1.2 i	C 12 NZ	1.2	1989.09 - 1993.03	Chassis No →J4999999	6010.95D
			1989.09 - 1993.03	Chassis No K4000001→	6031.100D
1.2 N	12 NC, 12 NV, E 12 GV	1.2	1985.01 - 1993.03	Chassis No →J4999999	6010.95D
			1985.01 - 1993.03	Chassis No K4000001→	6031.100D
1.2 S	12 S, 12 ST	1.2	1982.09 - 1993.03	Chassis No →J4999999	6010.95D
			1982.09 - 1993.03	Chassis No K4000001→	6031.100D
1.3	13 NB, 13 SB, C 13 N	1.3	1985.09 - 1989.10	Chassis No →J4999999	6010.95D
			1985.09 - 1989.10	Chassis No K4000001→	6031.100D
1.3 i	C 13 N	1.3	1986.09 - 1990.09	Chassis No →J4999999	6010.95D
			1986.09 - 1990.09	Chassis No K4000001→	6031.100D
1.3 S	13 SB	1.3	1982.09 - 1989.10	Chassis No →J4999999	6010.95D
			1982.09 - 1989.10	Chassis No K4000001→	6031.100D
1.4 i	C 14 NZ	1.4	1985.01 - 1993.03	Chassis No →J4999999	6010.95D
			1985.01 - 1993.03	Chassis No K4000001→	6031.100D
1.4 S	14 NV	1.4	1989.09 - 1993.03	Chassis No →J4999999	6010.95D
			1989.09 - 1993.03	Chassis No K4000001→	6031.100D
1.4 Si	C 14 SE	1.4	1991.09 - 1993.03	Chassis No →J4999999	6010.95D
			1991.09 - 1993.03	Chassis No K4000001→	6031.100D
1.6 GSI	C 16 NZ, C 16 SE, C 16 SEI, E 16 SE	1.6	1988.05 - 1993.03	Chassis No →J4999999	6010.95D
			1988.05 - 1993.03	Chassis No K4000001→	6031.100D
CORSA B					
1.0 i 12V	X 10 XE	1.0	1996.11 - 2000.09		6031.100D
1.2 i	12 NZ, C 12 NZ, X 12 SZ	1.2	1993.03 - 2000.09		6031.100D
1.2 i 16V	X 12 XE	1.2	1998.03 - 2000.09		6031.100D
1.4	C 14 SE	1.4	1993.04 - 1994.08		6031.100D
1.4 i	C 14 NZ, X 14 SZ	1.4	1993.03 - 2000.09		6031.100D
1.4 i 16V	C 14 SEL, X 14 XE	1.4	1994.09 - 2000.09		6031.100D
1.4 Si	C 14 SE	1.4	1993.03 - 2000.09		6031.100D
1.6 GSI 16V	C 16 XE	1.6	1993.03 - 2000.09		6031.100D
1.6 i 16V	C 16 SEL, X 16 XE	1.6	1994.09 - 2000.09		6031.100D
KADETT D					
1.0	10 N, 10 S	1.0	1979.09 - 1984.08		6010.100D
1.2	12 N, 12 ST	1.2	1979.08 - 1984.08		6010.100D

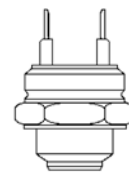

OPEL

	Motor Engine Moteur	Ltr. Ltr. Ltr.	Jahr Year Année	Einschränkung Restriction* Restriction*	Thermaschalter Thermoswitches Thermocontact
1.2 S	12 S	1.2	1979.08 - 1984.08		6010.100D
1.3 N	13 N, C 13 N	1.3	1979.08 - 1984.08		6010.100D
1.3 S	13 S	1.3	1979.08 - 1984.08		6010.100D
1.6		1.6	1979.09 - 1984.08		6010.100D
1.6 D	16 D	1.6	1982.03 - 1984.08		6010.100D
1.6 S	16 SH	1.6	1981.09 - 1984.08		6010.100D
1.8 GT/E	18 E	1.8	1983.02 - 1984.08		6010.95D
KADETT E					
1.2	12 SC	1.2	1984.09 - 1986.07	Chassis No →J2791967 →J5273427	6010.95D
			1984.09 - 1986.07	Chassis No J2791968→ J5273428→	6031.100D
1.3 i	C 13 N	1.3	1985.09 - 1991.08	Chassis No →J2791967 →J5273427	6010.95D
			1985.09 - 1991.08	Chassis No J2791968→ J5273428→	6031.100D
1.3 N	13 N, 13 NB	1.3	1984.09 - 1991.08	Chassis No →J2791967 →J5273427	6010.95D
			1984.09 - 1991.08	Chassis No J2791968→ J5273428→	6031.100D
1.3 S	13 S	1.3	1984.09 - 1993.02	Chassis No →J2791967 →J5273427	6010.95D
			1984.09 - 1993.02	Chassis No J2791968→ J5273428→	6031.100D
1.4 i	C 14 NZ	1.4	1990.01 - 1994.07		6031.100D
1.4 S	14 NV	1.4	1989.07 - 1993.02		6031.100D
1.6	16 SV	1.6	1986.09 - 1991.12	Chassis No →J2791967 →J5273427	6010.95D
			1986.09 - 1991.12	Chassis No J2791968→ J5273428→	6031.100D
1.6 D	16 D, 16 DA	1.6	1984.08 - 1989.12	Chassis No →JE222258 →J2791967	6010.95D
1.6 i	16 SV, C 16 LZ, C 16 NZ, E 16 NZ	1.6	1986.09 - 1993.02	Chassis No →J2791967 →J5273427	6010.95D
			1986.09 - 1994.07	Chassis No J2791968→ J5273428→	6031.100D
1.6 S	16 SH, 16 SV	1.6	1984.09 - 1991.08	Chassis No →J2791967 →J5273427	6010.95D
			1986.09 - 1991.08	Chassis No J2791968→ J5273428→	6031.100D

OPEL

	Motor Engine Moteur	Ltr. Ltr. Ltr.	Jahr Year Année	Einschränkung Restriction* Restriction*	Thermaschalter Thermoswitches Thermocontact
1.8	18 E	1.8	1987.09 - 1990.08	Chassis No →J2791967 →J5273427	6010.95D
			1987.09 - 1990.08	Chassis No J2791968→ J5273428→	6031.100D
1.8 E	C 18 NE	1.8	1985.10 - 1986.08		6010.95D
1.8 GSI	18 E	1.8	1984.09 - 1986.08		6010.95D
1.8 i	18 E, C 18 NE	1.8	1984.09 - 1986.08	Chassis No →J2791967 →J5273427	6010.95D
			1984.09 - 1986.08	Chassis No J2791968→ J5273428→	6031.100D
1.8 S	E 18 NV, S 18 NV	1.8	1987.09 - 1991.08	Chassis No →J2791967 →J5273427	6010.95D
			1987.09 - 1991.08	Chassis No J2791968→ J5273428→	6031.100D
OMEGA A					
1.8	18 SEH, E 18 NVR	1.8	1986.09 - 1994.03	Chassis No →P1132203	6010.95D
			1986.09 - 1994.03	Chassis No P1132204→	6031.105D
1.8 N	18 NV	1.8	1986.09 - 1987.08		6010.95D
1.8 S	18 SV	1.8	1986.09 - 1994.03	Chassis No →P1132203	6010.95D
			1986.09 - 1994.03	Chassis No P1132204→	6031.105D
2.0	20 SE, C 20 NEF, C 20 NEJ	2.0	1986.09 - 1994.03	Chassis No →P1132203	6010.95D
			1986.09 - 1994.03	Chassis No P1132204→	6031.105D
2.0 i	C 20 NE, C 20 NEJ	2.0	1986.09 - 1994.03	Chassis No →P1132203	6010.95D
			1986.09 - 1994.03	Chassis No P1132204→	6031.105D
2.3 D	23 YD	2.3	1986.09 - 1994.03	Chassis No →K1000098	6010.95D
			1986.09 - 1994.03	Chassis No K1000099→	6031.105D
2.3 TD	23 YDT	2.3	1986.09 - 1988.08	Chassis No →K1000098	6010.95D
			1986.09 - 1988.08	Chassis No K1000099→	6031.105D
2.3 TD Interc.	23 DTR	2.3	1988.08 - 1994.03	Chassis No →K1000098	6010.95D
			1988.08 - 1994.03	Chassis No K1000099→	6031.105D
2.4 i	C 24 NE	2.4	1988.09 - 1994.03	Chassis No →P1132203	6010.95D
			1988.09 - 1994.03	Chassis No P1132204→	6031.105D
2.6 i	C 26 NE	2.6	1990.09 - 1994.03	Chassis No →P1132203	6010.95D
			1990.09 - 1994.03	Chassis No P1132204→	6031.105D

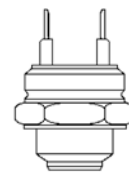

OPEL

	Motor Engine Moteur	Ltr. Ltr. Ltr.	Jahr Year Année	Einschränkung Restriction* Restriction*	Thermoschalter Thermoswitches Thermocontact
3.0 (3000)	C 30 LE	3.0	1987.03 - 1987.12		6010.95D
3.0 24V	C 30 SEJ	3.0	1989.09 - 1994.03	Chassis No →P1132203	6010.95D
			1989.09 - 1994.03	Chassis No P1132204→	6031.105D
3.0 24V (3000)	C 30 SE	3.0	1989.09 - 1994.03	Chassis No →P1132203	6010.95D
			1989.09 - 1994.03	Chassis No P1132204→	6031.105D
OMEGA B					
2.0	20 SE, X 20 SE	2.0	1994.03 - 2000.12	mit Klimaanlage	6031.100D
2.0 16V	X 20 XEV	2.0	1994.03 - 1999.09	mit Klimaanlage	6031.100D
2.2 16V	Y 22 XE, Z 22 XE	2.2	1999.09 - 2003.07	mit Klimaanlage	6031.100D
2.5 V6	X 25 XE	2.5	1994.03 - 2000.09	ohne Klimaanlage Chassis No R1000001→ →T1003097	6031.100D
			1994.03 - 2000.09	ohne Klimaanlage Chassis No T1003098→	6031.105D
3.0 V6	X 30 XE	3.0	1994.04 - 2001.02	ohne Klimaanlage Chassis No R1000001→ →T1003097	6031.100D
			1994.04 - 2001.02	ohne Klimaanlage Chassis No T1003098→	6031.105D
SENATOR					
2.5 i	25 NE	2.5	1990.09 - 1993.09	Chassis No →0053435	6010.95D
			1990.09 - 1993.09	Chassis No 0053436→	6031.105D
3.0	30 NE	3.0	1988.01 - 1990.09	Chassis No →0109241	6010.95D
			1988.01 - 1990.09	Chassis No 0109242→	6031.105D
3.0 i	C 30 NE	3.0	1988.01 - 1993.09	Chassis No →0011334	6010.95D
			1988.01 - 1993.09	Chassis No 0011335→	6031.105D
SINTRA					
2.2 DTI	X 22 DTH	2.2	1997.07 - 1999.04		6031.105D
2.2 i 16V	X 22 XE	2.2	1996.11 - 1999.04		6031.105D
3.0 i 24V	X 30 XE	3.0	1996.11 - 1999.04		6031.105D
TIGRA					
1.4 16V	X 14 XE	1.4	1994.07 - 2000.12		6031.100D
1.6 16V	C 16 SEL, X 16 XE	1.6	1994.07 - 1998.08		6031.100D
VECTRA A					
1.4 S	14 NV	1.4	1988.04 - 1992.06	Chassis No →KV999999 →K5999999 →L1000123	6031.100D

OPEL

	Motor Engine Moteur	Ltr. Ltr. Ltr.	Jahr Year Année	Einschränkung Restriction* Restriction*	Thermoschalter Thermoswitches Thermocontact
1.6	16 SV	1.6	1988.09 - 1993.05	Chassis No →KV999999 →K5999999 →L1000123	6031.100D
1.6 i	C 16 NZ, C 16 NZ2, E 16 NZ	1.6	1988.09 - 1995.11	C16 NZ, E 16 NZ Chassis No →KV999999 →K5999999 →L1000123	6031.100D
1.6 S	16 SV	1.6	1988.09 - 1993.05	Chassis No →KV999999 →K5999999 →L1000123	6031.100D
1.8 i	18 SV	1.8	1988.09 - 1990.10	Chassis No →KV999999 →K5999999 →L1000123	6031.100D
1.8 S	18 SV, E 18 NVR	1.8	1988.09 - 1990.10	Chassis No →KV999999 →K5999999 →L1000123	6031.100D
2.0	C 20 NEF	2.0	1988.04 - 1989.09	Chassis No →KV999999 →K5999999 →L1000123	6031.100D
2.0 i	20 NE, 20 SEH, C 20 NE	2.0	1988.09 - 1995.11	Chassis No →KV999999 →K5999999 →L1000123	6031.100D
2.0 i GT	20 SEH	2.0	1988.09 - 1995.11	Chassis No →KV999999 →K5999999 →L1000123	6031.100D
VECTRA B					
1.6 i	16 LZ2, X 16 SZR	1.6	1995.10 - 2003.07	ohne Klimaanlage	6031.100D
1.6 i 16V	X 16 XEL, Y 16 XE, Z 16 XE	1.6	1995.10 - 2002.07	ohne Klimaanlage	6031.100D

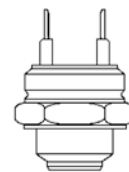

PEUGEOT

	Motor Engine Moteur	Ltr. Ltr. Ltr.	Jahr Year Année	Einschränkung Restriction* Restriction*	Thermoschalter Thermoswitches Thermocontact
104					
0.9	108 (XV3), 108 (XV5)	0.9	1972.10 - 1983.10		6010.88D
1.0	108C (XV8)	1.0	1983.09 - 1988.06		6010.88D
1.1	109 (XW3)	1.1	1976.07 - 1982.08		6010.88D
205 I					
1.0	108C (XV8)	1.0	1983.02 - 1987.10		6010.88D
1.1	109F (XW7), 109N (XW7)	1.1	1983.02 - 1987.10		6010.88D
1.4	150B (XY8), 150D (XY7), 150G (XY7), 150H (XY8)	1.4	1983.02 - 1987.10		6010.88D
205 II					
1.1	H1B (TU1)	1.1	1987.10 - 1990.10		6010.88D
1.4		1.4	1987.06 - 1989.12		6010.92D
1.6		1.6	1987.10 - 1998.09		6010.92D
1.6 GTI		1.6	1987.10 - 1989.12		6010.92D
305					
1.3	118 (XL5), XL5	1.3	1977.11 - 1982.09 1977.11 - 1986.08		6010.88D 6010.92D
1.5	117 (XR5S), 142 (XR5), 142 (XR5A)	1.5	1979.11 - 1982.09 1982.10 - 1990.07		6010.88D 6010.92D
1.6	171 (XU5S), B1A (XU51C), BAZ (XU5CP)	1.6	1982.10 - 1988.12 1982.10 - 1988.06		6010.88D 6010.92D
309					
1.1	E1, HDZ (TU1M)	1.1	1990.08 - 1993.12 1985.10 - 1989.07		6010.88D 6010.95D
1.3	G1A	1.3	1985.10 - 1989.07		6010.95D
1.4	K1D (TU3A), KDY (TU3M), KDZ (TU3M)	1.4	1989.03 - 1993.12		6010.88D
1.6	180Z (XU5J), B1A (XU51C), B2A (XU52C/K), B6B (XU5J)	1.6	1989.07 - 1993.12 1985.10 - 1989.07		6010.92D 6010.95D
1.9	D2B (XU9S), DDZ (XU9M), DFZ (XU9J1)	1.9	1985.10 - 1989.07		6010.95D
1.9 D	162 (XUD9), D9A (XUD9)	1.9	1986.06 - 1989.07		6010.95D
1.9 GTI	D6B (XU9JA (G-KAT)), DKZ (XU9JAZ)	1.9	1986.10 - 1989.07		6010.95D
405 I					
1.9 Sport MI-16	D6C (XU9J4), DFW (XU9J4Z)	1.9	1987.07 - 1992.12		6010.92D
504					
1.6	XC7P	1.6	1980.01 - 1987.06		6010.82D
1.8	XM, XM7	1.8	1968.07 - 1989.12		6010.82D
1.8 Injection	KF5, KF6	1.8	1968.07 - 1971.02		6010.82D
2.0	106 (XN1), 107 (XN2), XN1	2.0	1971.04 - 1986.07 1971.03 - 1986.06 1971.03 - 1986.06		6010.82D 6010.88D 6010.92D
2.0 TI	107 (XN2)	2.0	1971.01 - 1983.06		6010.88D
505					
1.8	105 (XM7), 105C (XM7A)	1.8	1981.06 - 1985.10 1985.09 - 1986.10		6010.88D 6010.92D
2.0	106 (XN1), 106E (XN1A)	2.0	1980.11 - 1991.09		6010.88D
2.0 TI,STI	829 (ZEJ)	2.0	1979.08 - 1986.10		6010.95D
2.2	851X (ZDJL)	2.2	1986.03 - 1993.12		6010.95D

PEUGEOT

	Motor Engine Moteur	Ltr. Ltr. Ltr.	Jahr Year Année	Einschränkung Restriction* Restriction*	Thermoschalter Thermoswitches Thermocontact
2.2 GTI	851B (ZDJL)	2.2	1985.09 - 1986.12 1983.08 - 1993.12		6010.88D 6010.92D
2.3 Turbo Diesel	147 (XD2S)	2.3	1980.09 - 1986.06		6010.88D
BOXER (230)					
2.0 i	RFW (XU10J2)	2.0	1994.03 - 2002.04 1994.03 - 2002.04	ohne Klimaanlage mit Klimaanlage	6031.92D 6035.92D
2.8 HDI	8140.43S (F28DTCR)	2.8	2000.11 - 2002.04	mit Klimaanlage	6035.92D

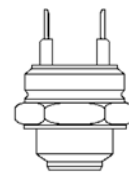

PORSCHE

	Motor Engine Moteur	Ltr. Ltr. Ltr.	Jahr Year Année	Einschränkung Restriction* Restriction*	Thermoschalter Thermoswitches Thermocontact
924					
2.0	XJ, XK	2.0	1975.11 - 1989.08		6010.92D
2.0 Carrera GT	M 31.50	2.0	1980.06 - 1986.10		6010.92D
2.0 Turbo	M 31.01, M 31.03	2.0	1978.11 - 1986.10		6010.92D
2.5 S	M 44.01, M 44.03	2.5	1981.10 - 1984.12		6010.92D
928					
4.6 S	M 28.11, M 28.12, M 28.21, M 28.22	4.6	1979.09 - 1983.07 1983.08 - 1986.07		6010.85D 6010.92D
944					
2.5	M 44.01, M 44.02, M 44.03, M 44.04, M 44.05, M 44.06, M 44.07, M 44.08, M 44.09, M 44.10	2.5	1981.06 - 1990.12		6010.92D
2.5 S	M 44.40	2.5	1986.08 - 1988.07		6010.92D
2.5 Turbo	M 44.50, M 44.51, M 44.52	2.5	1985.08 - 1991.07		6017.95D

RENAULT

	Motor Engine Moteur	Ltr. Ltr. Ltr.	Jahr Year Année	Einschränkung Restriction* Restriction*	Thermoschalter Thermoswitches Thermocontact
4					
0.8	800, 800 01, 800 705, B1B 707	0.8	1962.10 - 1989.07		6010.92D
1.1	688 711, 688 712, C1E 714, C1E 718, C1E 719	1.1	1976.10 - 1990.06 1982.07 - 1989.05		6010.92D 6010.95D
6					
0.8	800.02	0.8	1969.10 - 1980.04		6010.92D
1.1	688.10	1.1	1970.08 - 1987.04		6010.92D
12					
1.3	810-02/97	1.3	1969.10 - 1980.08		6010.92D
1.3 TS	810-06, 810.05	1.3	1972.08 - 1980.08		6010.92D
14					
1.2	129	1.2	1976.05 - 1983.12		6010.92D
1.4	150, X5J	1.4	1979.09 - 1983.12		6010.92D
16					
1.5		1.5	1965.09 - 1975.10		6010.92D
1.6	807, 807.04, 807.05, 821, 821.03, 821.04, 843, 843.01	1.6	1968.09 - 1980.08		6010.92D
18					
1.4	847 720, 847 722	1.4	1978.04 - 1986.07		6010.92D
1.6	841 717, 841 725, 841 726, A2M 723, A6M 725, A6M 726	1.6	1978.04 - 1986.07		6010.92D
1.6 Turbo	807 727, A5L 717, A5L 718	1.6	1980.10 - 1986.07		6010.92D
2.0	J6R 716	2.0	1981.10 - 1986.07		6010.92D
2.1 Diesel	852 710, J8S 711	2.1	1980.11 - 1986.07		6010.92D
20					
1.6	843, 843 720, 843 721	1.6	1975.10 - 1983.12		6010.92D
2.0	829 700, 829 701, 829 702, 829 703, 829.01	2.0	1977.10 - 1983.12		6010.92D
2.1 Diesel	852	2.1	1980.10 - 1983.12		6010.92D
2.2	851 700	2.2	1980.10 - 1983.12		6010.92D
21 Kombi					
1.7	F2N 710	1.7	1986.10 - 1988.12		6010.92D
2.0	J7R 750, J7R 751	2.0	1986.06 - 1988.12		6010.92D
25					
2.0	J6R 706, J6R 707, J6R 760, J6R 762, J6R 763, J7R 722, J7R 723	2.0	1984.04 - 1993.12		6010.92D
2.0 12V	J7R 726	2.0	1989.06 - 1992.12		6010.92D
2.1 Diesel	J8S 706, J8S 736	2.1	1984.04 - 1992.12		6010.92D
2.1 Turbo-D	J8S 708, J8S 738	2.1	1984.04 - 1992.12		6010.92D
2.2	J7T 706, J7T 707, J7T 708, J7T 714, J7T 715, J7T 730, J7T 731, J7T 732, J7T 733	2.2	1984.04 - 1992.12		6010.92D
2.4 V6 Turbo	Z7U 702	2.4	1984.10 - 1990.05		6010.92D
2.5 V6 Turbo	Z7U 700	2.5	1990.01 - 1992.12		6010.92D
2.7 V6 Injection	Z7V 708, Z7V 709, Z7V 711	2.7	1984.04 - 1989.08		6010.92D
2.8 V6	Z7W 700	2.8	1987.06 - 1990.02		6010.92D
2.8 V6 Injection	Z7W 702, Z7W 706, Z7W 707, Z7W 709	2.8	1986.06 - 1992.12		6010.92D

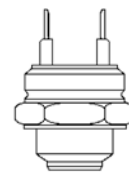

RENAULT

	Motor Engine Moteur	Ltr. Ltr. Ltr.	Jahr Year Année	Einschränkung Restriction* Restriction*	Thermoschalter Thermostatich Thermocontact
FUEGO					
1.4	847 720	1.4	1980.02 - 1985.10		6010.92D
1.6 TS/GTS	843 723, 843 724, A6M 725, A6M 726	1.6	1980.10 - 1985.10		6010.92D
1.6 Turbo	A5L 750	1.6	1983.08 - 1985.10		6010.92D
2.0 TX/GTX	829 710, J6R 710, J6R 712, J6R 713, J6R 715, J6R 726	2.0	1980.10 - 1985.10		6010.92D
TRAFIC (P6, T1, T3, T4, T5, T6, T7)					
1.6	841 705, A1M 707, A1M 708	1.6	1984.01 - 1986.06		6010.92D
1.7	F1N 724	1.7	1986.06 - 1989.04		6010.92D

SAAB

	Motor Engine Moteur	Ltr. Ltr. Ltr.	Jahr Year Année	Einschränkung Restriction* Restriction*	Thermoschalter Thermoswitches Thermocontact
90					
2.0	B 20 I	2.0	1984.08 - 1987.08		6010.95D
99					
1.7		1.7	1968.08 - 1971.05		6010.88D
1.85		1.9	1970.10 - 1974.05		6010.88D
1.85 i		1.9	1971.10 - 1972.09		6010.88D
2.0	B 20 P, B20T	2.0	1972.10 - 1978.05		6010.88D
2.0 EMS	B 20 I	2.0	1972.04 - 1978.12		6010.88D
2.0 GL	B 20 C, B 20 I	2.0	1974.09 - 1984.12		6010.88D
2.0 Turbo		2.0	1977.10 - 1980.06		6010.88D
900 I					
2.0	B202I, B202S	2.0	1985.10 - 1989.09 1983.09 - 1993.10		6010.88D 6010.92D
2.0 -16	B202I, B202S	2.0	1989.01 - 1994.06		6010.92D
2.0 c	B 20, B201XC, B20T, BT 20	2.0	1978.09 - 1988.12		6010.92D
2.0 EMS	BI 20	2.0	1978.09 - 1980.12		6010.92D
2.0 i	B201, B201XI, BI 20	2.0	1980.11 - 1990.08		6010.92D
2.0 S Turbo-16	B202S	2.0	1991.07 - 1994.06		6010.92D
2.0 T8		2.0	1986.10 - 1989.09		6010.92D
2.0 Turbo	B201S, B201XL, BSI 20	2.0	1978.09 - 1991.12		6010.92D
2.0 Turbo-16	B202L, B202XL	2.0	1984.02 - 1994.06		6010.92D
2.0 Turbo-16 S	B202XL	2.0	1984.01 - 1993.12		6010.92D
2.1 16 S		2.1	1989.10 - 1992.07		6010.92D
9000					
2.0 -16	B202I, B202XI, B202XI (KAT)	2.0	1985.12 - 1993.01		6010.92D
2.0 -16 CD	B204E, B204I, B204S	2.0	1993.09 - 1998.12		6010.92D
2.0 -16 CS	B202I, B204I	2.0	1989.01 - 1998.12		6010.92D
2.0 -16 ND Turbo	B202S, B204E, B204S	2.0	1993.09 - 1998.12		6010.88D
2.0 -16 Turbo	B202, B202XL	2.0	1984.09 - 1993.08		6010.88D
2.0 -16 Turbo CD	B202L, B202S, B202XL, B204E	2.0	1988.09 - 1998.12		6010.88D
2.0 -16 Turbo CS	B202L	2.0	1988.09 - 1998.12		6010.88D

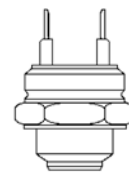
SEAT

	Motor Engine Moteur	Ltr. Ltr. Ltr.	Jahr Year Année	Einschränkung Restriction* Restriction*	Thermoschalter Thermoswitches Thermocontact
131					
1.5		1.5	1982.03 - 1985.01		6010.85D
1.6	132 BB OA O	1.6	1982.03 - 1985.01		6010.85D
2.0	131 C4.000	2.0	1978.06 - 1985.12		6010.85D
2.4 Diesel	8144.61	2.4	1978.06 - 1986.12		6010.85D
ALHAMBRA					
1.8 T 20V	AJH, AWC	1.8	1997.10 - 2010.03		6037.95D
1.9 TDI	1Z, AFN, AHU, ANU, ASZ, AUY, AVG, BVK	1.9	1996.04 - 2010.03		6037.95D
2.0 i	ADY, ATM	2.0	1996.04 - 2010.03		6037.95D
2.8 V6	AUE, AYL	2.8	2000.06 - 2010.03		6037.95D
AROSA					
1.0	AER, ALD, ALL, ANV, AUC	1.0	1997.05 - 2004.06 1997.05 - 2004.06		6037.95D 6039.95D
1.4	AEX, AKK, AKV, ANW, APQ, AUD	1.4	1997.05 - 2004.06 1997.05 - 2004.06		6037.95D 6039.95D
1.4 16V	AFK, AQQ, AUB	1.4	2000.01 - 2004.06 2000.01 - 2004.06		6037.95D 6039.95D
1.7 SDI	AKU	1.7	1997.08 - 2004.06 1997.08 - 2004.06		6037.95D 6039.95D
CORDOBA (6K2/C2, 6K5)					
1.0	ALD, ANV, AST, AUC, AVZ	1.0	1999.05 - 2002.10		6037.95D
1.0 16V	AST, AVZ	1.0	2000.05 - 2002.10		6037.95D
1.0 i	AER	1.0	1996.09 - 1999.06		6037.95D
1.4	AKK, ANW, APE, AQQ, AUA, AUB, AUD	1.4	1997.12 - 2002.12		6037.95D
1.4 16V	APE, AQQ, AUA, AUB	1.4	1999.06 - 2002.12		6037.95D
1.4 i	ABD, AEX, AKV, ANX, APQ	1.4	1994.06 - 1999.06	Chassis No →6K-TR099000	6017.95D
			1994.06 - 1999.06	Chassis No →6K-T	6020.95D
			1994.06 - 1999.06	Chassis No 6K-TR099001→	6037.95D
1.4 i 16V	AFH	1.4	1996.09 - 1999.06		6037.95D
1.6	AEH, AKL, ALM, APF, AUR	1.6	1999.05 - 2002.12		6037.95D
1.6 i	1F, ABU, AEE, AFT, ALM	1.6	1993.02 - 1999.06	Chassis No →6K-TR099000	6017.95D
			1993.02 - 1999.06	Chassis No →6K-T	6020.95D
			1993.02 - 1999.06	Chassis No 6K-TR099001→	6037.95D
1.7 SDI		1.7	1997.07 - 1999.06		6037.95D
1.8 i	ABS, ACC, ADZ	1.8	1993.02 - 1999.06	Chassis No →6K-TR099000	6017.95D
			1993.02 - 1999.06	Chassis No →6K-T	6020.95D
			1993.02 - 1999.06	Chassis No 6K-TR099001→	6037.95D
1.8 i 16V	ADL	1.8	1993.10 - 1996.08	Chassis No →6K-TR099000	6017.95D
			1993.10 - 1996.08	Chassis No →6K-T	6020.95D
			1993.10 - 1996.08	Chassis No 6K-TR099001→	6037.95D
1.8 T 20V Cupra	AQX, AYP	1.8	2000.07 - 2002.10		6037.95D

SEAT

	Motor Engine Moteur	Ltr. Ltr. Ltr.	Jahr Year Année	Einschränkung Restriction* Restriction*	Thermaschalter Thermoswitches Thermocontact
1.9 D	1Y, AGR, ALH, ASV	1.9	1993.02 - 1996.08	Chassis No →6K-TR099000	6017.95D
			1993.02 - 1996.08	Chassis No →6K-T	6020.95D
			1993.02 - 2002.09	Chassis No 6K-TR099001→	6037.95D
1.9 SDI	AEY, AGP, AQM	1.9	1996.08 - 2002.12		6037.95D
1.9 TD	AAZ	1.9	1993.02 - 1996.08	Chassis No →6k-TR099000	6017.95D
			1993.02 - 1996.08	Chassis No →6K-T	6020.95D
			1993.02 - 1996.08	Chassis No 6K-TR099001→	6037.95D
1.9 TDI	1Z, AFN, AGR, AHU, ALH, ASK, ASV	1.9	1996.08 - 2002.12		6037.95D
2.0 i	2E, AGG	2.0	1993.02 - 1999.06	Chassis No →6K-TR099000	6017.95D
			1993.02 - 1999.06	Chassis No →6K-T	6020.95D
			1993.02 - 1999.06	Chassis No 6K-TR099001→	6037.95D
2.0 i 16V	ABF	2.0	1996.08 - 1999.06		6037.95D
FURA					
0.9	09 NCA, 100 GL 7000	0.9	1984.03 - 1986.12		6016.92
IBIZA I (021A)					
0.9	09 NCA, 146 A 000	0.9	1986.08 - 1993.05		6020.92D
1.2	021 A 1000	1.2	1984.11 - 1993.12		6020.92D
1.2 i	021 C.1000	1.2	1989.01 - 1993.05		6020.92D
1.5	021 A 2000	1.5	1984.11 - 1993.05		6020.92D
1.5 i	021 B.2000, 021 C.2000, 021 D.2000	1.5	1986.10 - 1993.05		6020.92D
1.7	021 A.3000, 021 B.3000	1.7	1991.01 - 1993.05		6020.92D
IBIZA II (6K1)					
1.0	AAU	1.0	1993.03 - 1996.09 1993.03 - 1996.09		6017.95D 6020.95D
1.0 i	AER	1.0	1996.09 - 1999.08		6037.95D
1.3 i	2G, AAV	1.3	1993.03 - 1999.08	Chassis No →6K-TR099000	6017.95D
			1993.03 - 1999.08	Chassis No →6K-T	6020.95D
			1993.03 - 1999.08	Chassis No 6K-TR099001→	6037.95D
1.4 i	ABD, AEX, AKV, APQ	1.4	1993.09 - 1999.08	Chassis No →6K-TR099000	6017.95D
			1993.09 - 1999.08	Chassis No →6K-T	6020.95D
			1993.09 - 1999.08	Chassis No 6K-TR099001→	6037.95D
1.4 i 16V	AFH	1.4	1996.09 - 1999.08		6037.95D
1.6 i	1F, ABU, AEE, AFT, ALM	1.6	1993.03 - 1999.08	Chassis No →6K-TR099000	6017.95D
			1993.03 - 1999.08	Chassis No →6K-T	6020.95D
			1993.03 - 1999.08	Chassis No 6K-TR099001→	6037.95D

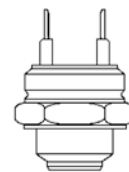
SEAT

	Motor Engine Moteur	Ltr. Ltr. Ltr.	Jahr Year Année	Einschränkung Restriction* Restriction*	Thermaschalter Thermoswitches Thermocontact
1.8 i	ABS, ADZ	1.8	1993.03 - 1999.08	Chassis No →6K-TR099000	6017.95D
			1993.03 - 1999.08	Chassis No →6K-T	6020.95D
			1993.03 - 1999.08	Chassis No 6K-TR099001→	6037.95D
1.8 i 16V	ADL	1.8	1993.11 - 1996.08		6017.95D
			1993.11 - 1996.08		6020.95D
1.9 D	1Y	1.9	1993.04 - 1996.08		6017.95D
			1993.04 - 1996.08		6020.95D
1.9 SDI	AEY	1.9	1996.08 - 1999.08		6037.95D
1.9 TD	AAZ	1.9	1993.03 - 1996.08		6017.95D
			1993.03 - 1996.08		6020.95D
1.9 TDI	1Z, AFN, AHU	1.9	1996.08 - 1999.08		6037.95D
2.0 i	2E, AGG	2.0	1993.03 - 1999.08	Chassis No →6K-TR099000	6017.95D
			1993.03 - 1999.08	Chassis No →6K-T	6020.95D
			1993.03 - 1999.08	Chassis No 6K-TR099001→	6037.95D
2.0 i 16V	ABF	2.0	1996.08 - 1999.08		6037.95D
IBIZA III (6K1)					
1.0	ALD, ANV, AUC	1.0	1999.08 - 2002.02		6037.95D
1.0 16V	AST, AVZ	1.0	2000.05 - 2002.02		6037.95D
1.4	AKK, ANW, AUD	1.4	1999.08 - 2002.02		6037.95D
1.4 16V	APE, AQQ, AUA, AUB	1.4	1999.08 - 2002.02		6037.95D
1.6	AEH, AKL, ALM, APF, AUR	1.6	1999.08 - 2002.02		6037.95D
1.8 T 20V Cupra	AQX, AYP	1.8	2000.07 - 2002.02		6037.95D
1.9 SDI	AGP, AQM	1.9	1999.08 - 2002.02		6037.95D
1.9 TDI	AGR, ALH, ASK, ASV	1.9	1999.08 - 2002.02		6037.95D
INCA					
1.4 16V	AUA	1.4	2000.04 - 2003.06		6037.95D
1.4 i	AEX, AKV, APQ, AUD	1.4	1995.11 - 2003.06		6037.95D
1.6 i	1F, AEE, ALM	1.6	1995.11 - 2000.09		6037.95D
1.7 D	AHB	1.7	1996.09 - 2003.06		6037.95D
1.9 D	1Y	1.9	1995.11 - 2003.06		6037.95D
1.9 SDI	AEY, AYQ	1.9	1995.11 - 2003.06		6037.95D
1.9 TDI	ALH	1.9	1996.09 - 2003.06		6037.95D
LEON (1M1) 2006<--					
1.4 16V	AHW, APE, AUA, AXP, BCA	1.4	1999.11 - 2006.06		6037.95D
			1999.11 - 2006.06		6039.95D
1.6	AEH, AKL, APF	1.6	1999.11 - 2006.06		6037.95D
			1999.11 - 2006.06		6039.95D
1.6 16 V	ATN, AUS, AZD, BCB	1.6	2000.09 - 2006.06		6039.95D
1.8 20V / T	AGN, AJQ, APG, APP, ARY, AUQ	1.8	1999.11 - 2006.06		6037.95D
			1999.11 - 2006.06		6039.95D
1.9 TDI	AGR, AHF, ALH, ASV	1.9	1999.11 - 2006.06		6037.95D
			1999.11 - 2006.06		6039.95D
MALAGA					
1.2	021 A 1000	1.2	1984.11 - 1993.12		6020.92D
1.2 i	021 C.1000	1.2	1989.12 - 1993.12		6020.92D
1.5	021 A 2000	1.5	1985.05 - 1993.12		6020.92D
1.5 i	021 A 2000, 021 B.2000, 021 C.2000, 021 D.2000	1.5	1986.10 - 1993.12		6020.92D

SEAT
**Motor
Engine
Moteur**
**Ltr.
Ltr.
Ltr.**
**Jahr
Year
Année**
**Einschränkung
Restriction*
Restriction***
**Thermoschalter
Thermoswitches
Thermocontact**
MARBELLA

0.8	08 NCA	0.8	1986.08 - 1993.12		6020.92D
0.9	08 NCB, 09 NCA, 09 NCB, 100 GL 7000	0.9	1987.01 - 1998.10		6020.92D

PANDA (141A)

0.9	100 GL 3000	0.9	1980.10 - 1986.12		6020.92D
-----	-------------	-----	-------------------	--	----------

RONDA

1.2	021 A 1000	1.2	1984.10 - 1986.12		6010.92D
1.5	021 A 2000	1.5	1984.09 - 1986.12		6010.92D

TERRA

0.9	09 NCA, 09 NCB	0.9	1987.01 - 1996.12		6020.92D
-----	----------------	-----	-------------------	--	----------

TOLEDO I

1.6 i	1F, ABN, AFT, EZ	1.6	1991.05 - 1999.03		6017.95D
1.8 16V	KR, PL	1.8	1991.05 - 1999.03		6017.95D
1.8 i	ABS, ADZ, RP	1.8	1991.05 - 1996.12		6017.95D
1.9 D	1Y	1.9	1991.05 - 1999.03		6017.95D
1.9 TD	AAZ	1.9	1991.05 - 1999.03		6017.95D
1.9 TDI	1Z, AFN, AHU	1.9	1995.08 - 1999.03		6017.95D
2.0 i	2E, AGG	2.0	1991.05 - 1999.03		6017.95D
2.0 i 16V	ABF	2.0	1993.11 - 1999.03		6017.95D

TOLEDO II

1.4 16V	AHW, APE, AUA, AXP, BCA	1.4	1999.07 - 2006.05		6039.95D
1.6 16V	AUS, AZD, BCB	1.6	2000.09 - 2006.05		6039.95D

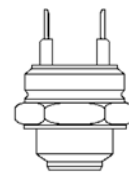

SKODA

	Motor Engine Moteur	Ltr. Ltr. Ltr.	Jahr Year Année	Einschränkung Restriction* Restriction*	Thermoschalter Thermostatich Thermocontact
105, 120					
1.0 105	742, 10	1.0	1976.08 - 1990.12		6010.92D
1.2 120	742, 12, 742.12 X	1.2	1976.08 - 1990.12		6010.92D
FABIA (6Y2, 6Y3, 6Y5)					
1.0	AQV, ARV	1.0	1999.12 - 2002.08		6037.95D
1.4	AME, AQW, ATZ	1.4	1999.08 - 2008.03		6037.95D
1.9 SDI	ASY	1.9	1999.12 - 2008.03		6037.95D
1.9 TDI	ATD, AXR	1.9	2000.01 - 2008.03		6037.95D
FELICIA I					
1.3	135 L, 135B, 135M, 136B, 136M, AMG, AMH, AMJ	1.3	1994.10 - 1998.05	ohne Klimaanlage	6010.95D
			1994.10 - 1998.03	ohne Servolenkung mit Klimaanlage für Fahrzeuge mit Servolenkung	6017.95D
1.6	AEE, EA111	1.6	1995.08 - 1998.03	mit Klimaanlage	6017.95D
1.9 D	AEF	1.9	1995.10 - 1998.03		6017.95D
FELICIA II					
1.3	AMG, AMH	1.3	1998.01 - 2001.06	mit Klimaanlage für Fahrzeuge mit Servolenkung	6017.95D
1.6	AEE	1.6	1998.01 - 2001.06	mit Klimaanlage	6017.95D
1.9 D	AEF	1.9	1998.01 - 2001.06		6017.95D

TALBOT
**Motor
Engine
Moteur**
**Ltr.
Ltr.
Ltr.**
**Jahr
Year
Année**
**Einschränkung
Restriction*
Restriction***
**Thermoschalter
Thermoswitches
Thermocontact**
1307-1510

1510 1.6	6J2A	1.6	1981.07 - 1982.06		6010.92D
Simca 1307 1.3	6G1D	1.3	1975.07 - 1981.08		6010.92D
Simca 1307 1.3S		1.3	1975.07 - 1978.12		6010.92D
Simca 1308 1.4	6Y2, 6Y2D	1.4	1978.11 - 1981.08		6010.92D
Simca 1510 1.4	6G1, 6Y2D	1.4	1980.01 - 1984.04		6010.92D
Simca 1510 1.6	6J1, 6J2	1.6	1978.10 - 1983.12		6010.92D

HORIZON

1.1	E1B	1.1	1979.01 - 1984.09		6010.92D
1.3	2G1, 2G1-BTC	1.3	1978.02 - 1986.06		6010.92D
1.4	2Y1, 2Y1B, 2Y2, Y2	1.4	1979.07 - 1986.06		6010.92D
1.6	6J2A, J2A	1.6	1982.07 - 1986.06		6010.92D
1.9 Diesel	XUD9	1.9	1982.07 - 1986.06		6010.92D

MURENA

1.6	X5J2A	1.6	1981.08 - 1985.01		6010.92D
2.1	5N2	2.1	1980.09 - 1984.07		6010.92D
2.1 S	X5N2	2.1	1983.04 - 1985.01		6010.92D

RANCHO

1.4	X3Y2	1.4	1977.01 - 1984.07		6010.92D
-----	------	-----	-------------------	--	----------

SAMBA (51A)

0.9	5C1(XV5), 5C1(XV8)	0.9	1981.01 - 1985.12		6010.92D
1.1	XW7	1.1	1981.01 - 1986.06		6010.92D
1.2 Rallye	129 D	1.2	1983.01 - 1986.10		6010.92D
1.4	150 D, XY7, XY8	1.4	1981.01 - 1986.10		6010.92D
1.4 Rallye	XY8	1.4	1983.01 - 1986.10		6010.92D

SAMBA Cabriolet (51E)

1.4	XY8	1.4	1981.01 - 1986.06		6010.92D
-----	-----	-----	-------------------	--	----------

SIMCA 1100

0.9 LE		0.9	1976.10 - 1980.01		6010.92D
0.9 LS		0.9	1970.10 - 1972.05		6010.92D
1.1	3E1, 3E1A, E1/BTC	1.1	1968.10 - 1980.01		6010.92D
1.1 LE, LX, GLS, ES	3E1, 3E1A	1.1	1976.10 - 1980.01		6010.92D
1.1 LS, GLS	E1/BTC	1.1	1968.10 - 1977.09		6010.92D
1.2 Spezial		1.2	1971.10 - 1977.09		6010.92D
1.3 Spezial		1.3	1974.07 - 1976.11		6010.92D
1.3 Spezial TI	3G4	1.3	1972.10 - 1977.09		6010.92D

SIMCA 1609/1610

1609 1.6	7R2	1.6	1976.09 - 1978.03		6010.92D
1610 1.8	7S2	1.8	1976.09 - 1980.12		6010.92D
1610 2.0	7T2	2.0	1976.09 - 1980.12		6010.92D
1610 2.0 D		1.9	1976.09 - 1980.12		6010.92D

SOLARA

1.3	6G1D/VP	1.3	1980.02 - 1986.07		6010.92D
1.6	6J1, J1B	1.6	1981.09 - 1986.07		6010.92D

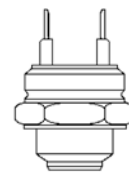

VAUXHALL

	Motor Engine Moteur	Ltr. Ltr. Ltr.	Jahr Year Année	Einschränkung Restriction* Restriction*	Thermaschalter Thermaswitches Thermocontact
ASTRA					
1.2	12 S	1.2	1979.10 - 1984.08		6010.100D
1.2 S	12 S	1.2	1982.02 - 1984.08		6010.100D
1.3		1.3	1980.09 - 1984.08 1982.08 - 1984.08	Chassis No →J2791967 →J5273427	6010.100D 6010.95D
			1982.08 - 1984.08	Chassis No J2791968→ J5273428→	6031.100D
1.3 S	13 S	1.3	1979.09 - 1984.08 1979.09 - 1984.08	Chassis No →J2791967 →J5273427	6010.100D 6010.95D
			1979.09 - 1984.08	Chassis No J2791968→ J5273428→	6031.100D
1.6 D	16 D	1.6	1982.03 - 1986.08 1982.02 - 1986.08	Chassis No →J2791967 →JE222258	6010.100D 6010.95D
1.6 S	16 S, 16 SH	1.6	1981.09 - 1986.08 1981.09 - 1986.08	Chassis No →J2791967 →J5273427	6010.100D 6010.95D
			1981.09 - 1986.08	Chassis No J2791968→ J5273428→	6031.100D
1.8 GTE	18 E	1.8	1983.03 - 1986.08		6010.100D
ASTRA Mk II					
1.2	12 S	1.2	1984.09 - 1991.08	Chassis No →J2791967 →J5273427	6010.95D
			1984.09 - 1991.08	Chassis No J2791968→ J5273428→	6031.100D
1.3	13 S	1.3	1984.09 - 1991.08	Chassis No →J2791967 →J5273427	6010.95D
			1984.09 - 1991.08	Chassis No J2791968→ J5273428→	6031.100D
1.4 i	C 14 NZ	1.4	1990.01 - 1991.12		6031.100D
1.4 S	14 NV	1.4	1989.01 - 1991.08		6031.100D
1.6	16 S, 16 SH, 16 SV	1.6	1984.09 - 1991.08	Chassis No →J2791967 →J5273427	6010.95D
			1984.09 - 1991.08	Chassis No J2791968→ J5273428→	6031.100D
1.6 D	16 DA	1.6	1984.09 - 1991.08	Chassis No →J2791967 →JE222258	6010.95D

VAUXHALL

	Motor Engine Moteur	Ltr. Ltr. Ltr.	Jahr Year Année	Einschränkung Restriction* Restriction*	Thermoschalter Thermoswitches Thermocontact
1.6 i	16 SV, C 16 LZ, C 16 NZ, E 16 NZ	1.6	1987.01 - 1993.08	Chassis No →J2791967 →J5273427	6010.95D
			1987.01 - 1993.08	Chassis No J2791968→ J5273428→	6031.100D
1.6 S	16 S, 16 SH, 16 SV	1.6	1984.09 - 1991.12	Chassis No →J2791967 →J5273427	6010.95D
			1984.09 - 1991.12	Chassis No J2791968→ J5273428→	6031.100D
1.8	18 SE	1.8	1986.01 - 1990.12	Chassis No →J2791967 →J5273427	6010.95D
			1986.01 - 1990.12	Chassis No J2791968→ J5273428→	6031.100D
1.8 GTE	18 E, 18 SE	1.8	1984.09 - 1991.08	Chassis No →J2791967 →J5273427	6010.95D
			1984.09 - 1991.08	Chassis No J2791968→ J5273428→	6031.100D
1.8 i	18 E, 18 SE	1.8	1985.09 - 1991.08	Chassis No →J2791967 →J5273427	6010.95D
			1985.09 - 1991.08	Chassis No J2791968→ J5273428→	6031.100D
ASTRA Mk III					
1.4 i	C 14 NZ, C 14 SE	1.4	1991.01 - 2001.03	mit Klimaanlage	6031.100D
			1991.01 - 2001.03	mit Klimaanlage	6031.88D
1.4 i 16V	X 14 XE	1.4	1996.01 - 2001.03	mit Klimaanlage	6031.100D
			1996.01 - 2001.03	mit Klimaanlage	6031.88D
1.4 S	14 NV	1.4	1991.09 - 1998.02	mit Klimaanlage	6031.100D
			1991.09 - 1998.02	mit Klimaanlage	6031.88D
1.6 i	C 16 NZ, C 16 SE, E 16 NZ, X 16 SZ, X 16 SZR	1.6	1991.01 - 2001.03	mit Klimaanlage	6031.100D
			1991.01 - 2001.03	mit Klimaanlage	6031.88D
1.6 i 16V	X 16 XEL	1.6	1994.01 - 1998.09	mit Klimaanlage	6031.100D
			1994.01 - 1998.09	mit Klimaanlage	6031.88D
1.6 Si	C 16 SE	1.6	1991.03 - 1994.12	mit Klimaanlage	6031.100D
			1991.03 - 1994.12	mit Klimaanlage	6031.88D
1.7 D	17 D, 17 DR	1.7	1991.09 - 1998.02	mit Klimaanlage	6031.88D
1.7 TD	17 DT (TC4EE1), X 17 DTL	1.7	1991.12 - 1998.02	mit Klimaanlage	6031.88D
1.8 16V	C 18 XEL, X 18 XE	1.8	1994.11 - 2001.03	mit Klimaanlage	6031.100D
			1994.11 - 2001.03	mit Klimaanlage	6031.88D
1.8 i	C 18 NZ	1.8	1991.09 - 1998.09	mit Klimaanlage	6031.100D
			1991.09 - 1998.09	mit Klimaanlage	6031.88D
1.8 i 16V	C 18 XE, C 18 XEL	1.8	1993.06 - 1998.02	mit Klimaanlage	6031.100D
			1993.06 - 1998.02	mit Klimaanlage	6031.88D
2.0 i	C 20 NE	2.0	1991.09 - 1998.09	mit Klimaanlage	6031.100D
			1991.09 - 1998.09	mit Klimaanlage	6031.88D
2.0 i 16V	C 20 XE, X 20 XEV	2.0	1991.09 - 1998.09	mit Klimaanlage	6031.100D
			1991.09 - 1998.09	mit Klimaanlage	6031.88D

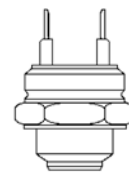

VAUXHALL

	Motor Engine Moteur	Ltr. Ltr. Ltr.	Jahr Year Année	Einschränkung Restriction* Restriction*	Thermaschalter Thermoswitches Thermocontact
CALIBRA					
2.0 i	C 20 NE	2.0	1990.06 - 1997.07 1990.06 - 1997.07	mit Klimaanlage mit Klimaanlage	6031.100D 6031.88D
2.0 i 16V	C 20 XE, X 20 XEV	2.0	1990.06 - 1994.02 1990.06 - 1997.07	mit Klimaanlage mit Klimaanlage	6031.100D 6031.88D
2.0 i Turbo	C 20 LET	2.0	1992.03 - 1997.07	mit Klimaanlage	6031.100D
CARLTON Mk III					
1.8	E 18 NVR	1.8	1987.09 - 1994.03		6010.95D
1.8 i	18 SEH	1.8	1986.09 - 1994.03		6010.95D
1.8 N	18 NV	1.8	1986.09 - 1987.08		6010.95D
1.8 S	18 SV	1.8	1986.09 - 1994.03		6010.95D
2.0	C 20 NE, C 20 NEF, C 20 NEJ	2.0	1986.09 - 1994.03	Chassis No →P1132203	6010.95D
			1990.09 - 1994.03	Chassis No P1132204→	6031.105D
2.0 i	20 SE, C 20 NEJ	2.0	1986.09 - 1994.03	Chassis No →P1132203	6010.95D
			1990.09 - 1994.03	Chassis No P1132204→	6031.105D
2.2 TD	23 YDT	2.2	1986.09 - 1988.08	Chassis No →K1000098	6010.95D
			1986.09 - 1988.08	Chassis No K1000099→	6031.105D
2.3 D	23 YD	2.3	1986.09 - 1994.03	Chassis No →K1000098	6010.95D
			1986.09 - 1994.03	Chassis No K1000099→	6031.105D
2.3 TD Interc.	23 DTR	2.3	1988.08 - 1994.03	Chassis No →K1000098	6010.95D
			1988.08 - 1994.03	Chassis No K1000099→	6031.105D
2.4 i	C 24 NE	2.4	1988.09 - 1994.03		6010.95D
2.6 i	C 26 NE	2.6	1990.09 - 1994.03	Chassis No →P1132203	6010.95D
			1990.09 - 1994.03	Chassis No P1132204→	6031.105D
3.0 3000 24V	C 30 SE	3.0	1989.09 - 1994.03		6010.95D
3000	C 30 LE, C 30 NE	2.9	1987.03 - 1994.03	Chassis No →P1132203	6010.95D
			1988.03 - 1994.03	Chassis No P1132204→	6031.105D
3000 24V	C 30 SEJ	3.0	1989.09 - 1994.03	Chassis No →P1132203	6010.95D
			1989.09 - 1994.03	Chassis No P1132204→	6031.105D
CAVALIER Mk II					
1.3	13 NB	1.3	1981.09 - 1988.08		6010.95D
1.3 N	13 N	1.3	1981.09 - 1988.08	Chassis No →J2791967 →J5273427	6010.95D
			1981.09 - 1988.08	Chassis No J2791968→ J5273428→	6031.100D

VAUXHALL

	Motor Engine Moteur	Ltr. Ltr. Ltr.	Jahr Year Année	Einschränkung Restriction* Restriction*	Thermoschalter Thermoswitches Thermocontact
1.3 S	13 S	1.3	1981.09 - 1988.08	Chassis No →J2791967 →J5273427	6010.95D
			1981.09 - 1988.08	Chassis No J2791968→ J5273428→	6031.100D
1.6	16 SH	1.6	1983.10 - 1988.08		6010.95D
1.6 i	C 16 LZ, C 16 NZ, E 16 NZ	1.6	1986.08 - 1988.08	Chassis No →J2791967 →J5273427	6010.95D
			1986.08 - 1988.08	Chassis No J2791968→ J5273428→	6031.100D
1.6 N	16 N	1.6	1981.09 - 1988.08		6010.95D
1.6 S	16 S, 16 SH	1.6	1981.09 - 1988.08		6010.95D
1.8	E 18 NV	1.8	1986.08 - 1988.08	Chassis No →J2791967 →J5273427	6010.95D
			1986.08 - 1988.08	Chassis No J2791968→ J5273428→	6031.100D
1.8 i	18 E, 18 SE, C 18 NE	1.8	1981.09 - 1988.08		6010.95D
1800i	18 SE	1.8	1985.03 - 1988.10		6010.95D
2.0	20 E, 20 S	2.0	1986.08 - 1987.08		6010.95D
2.0 i	20 NE, C 20 NE	2.0	1986.09 - 1988.08		6010.95D
2.0 SRi 130	20 SEH	2.0	1987.03 - 1988.08		6010.95D
2000i	20 SE	2.0	1986.09 - 1988.08		6010.95D
CAVALIER Mk III					
1.4 S	14 NV	1.4	1988.09 - 1995.11	Chassis No →KV999999 →K5999999 →L1000123	6031.100D
1.6	16 SV	1.6	1988.09 - 1993.05	Chassis No →KV999999 →K5999999 →L1000123	6031.100D
2.0 i	20 NE, 20 SEH, C 20 NE	2.0	1988.09 - 1995.11	Chassis No →KV999999 →K5999999 →L1000123	6031.100D
2.0 SRi	20 SEH	2.0	1988.09 - 1992.09	Chassis No →KV999999 →K5999999 →L1000123	6031.100D
COMBO Mk I					
1.2	C 12 NZ, X 12 SZ	1.2	1994.07 - 2001.10		6031.100D
1.4	C 14 NZ, C 14 SE	1.4	1994.07 - 2001.10		6031.100D
CORSA Mk II					
1.0 i 12V	X 10 XE	1.0	1996.11 - 2000.09		6031.100D
1.2 i	C 12 NZ, X 12 SZ	1.2	1993.03 - 2000.09		6031.100D
1.2 i 16V	X 12 XE	1.2	1998.03 - 2000.09		6031.100D
1.4 i	C 14 NZ, X 14 SZ	1.4	1993.03 - 2000.09		6031.100D
1.4 i 16V	X 14 XE	1.4	1994.09 - 2000.09		6031.100D
1.4 i S	C 14 SE	1.4	1993.03 - 2000.09		6031.100D
1.6 GSI 16V	C 16 XE	1.6	1993.03 - 2000.09		6031.100D
1.6 i 16V	X 16 XE	1.6	1994.09 - 2000.09		6031.100D

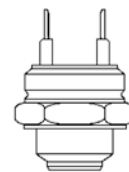

VAUXHALL

	Motor Engine Moteur	Ltr. Ltr. Ltr.	Jahr Year Année	Einschränkung Restriction* Restriction*	Thermaschalter Thermaswitches Thermocontact
CORSA Convertible					
1.4 i 16V	X 14 XE	1.4	1998.01 -		6031.100D
CORSAVAN Mk II					
1.4 i	C 14 NZ	1.4	1994.01 - 2000.09		6031.100D
NOVA					
1.0	10 S	1.0	1982.09 - 1987.10	Chassis No →J4999999	6010.95D
			1982.09 - 1993.03	Chassis No K4000001→	6031.100D
1.2	12 NV	1.2	1990.01 - 1994.10	Chassis No →J4999999	6010.95D
			1990.01 - 1994.10	Chassis No K4000001→	6031.100D
1.2 i	12 NC, C 12 NZ, E 12 GV	1.2	1985.01 - 1993.03	Chassis No →J4999999	6010.95D
			1985.01 - 1993.03	Chassis No K4000001→	6031.100D
1.2 N	12 NC, 12 NV, E 12 GV	1.2	1985.01 - 1993.03	Chassis No →J4999999	6010.95D
			1985.01 - 1993.03	Chassis No K4000001→	6031.100D
1.2 S	12 S, 12 ST	1.2	1982.09 - 1990.02	Chassis No →J4999999	6010.95D
			1982.09 - 1990.02	Chassis No K4000001→	6031.100D
1.3 i	13 NB, C 13 N	1.3	1985.09 - 1993.03	Chassis No →J4999999	6010.95D
			1985.09 - 1993.03	Chassis No K4000001→	6031.100D
1.3 S	13 SB	1.3	1982.09 - 1989.10	Chassis No →J4999999	6010.95D
			1982.09 - 1989.10	Chassis No K4000001→	6031.100D
1.4	14 NV, C 14 NZ, C 14 SE	1.4	1990.09 - 1993.03		6031.100D
1.4 i	C 14 NZ	1.4	1990.01 - 1993.03	Chassis No →J4999999	6010.95D
			1990.01 - 1993.03	Chassis No K4000001→	6031.100D
1.4 i S	C 14 SE	1.4	1991.09 - 1993.03	Chassis No →J4999999	6010.95D
			1991.09 - 1993.03	Chassis No K4000001→	6031.100D
1.4 S	14 NV	1.4	1990.01 - 1993.03	Chassis No →J4999999	6010.95D
			1990.01 - 1993.03	Chassis No K4000001→	6031.100D
1.6 GSI	C 16 SE, C 16 SEI, E 16 SE	1.6	1988.05 - 1993.03	Chassis No →J4999999	6010.95D
			1988.05 - 1993.03	Chassis No K4000001→	6031.100D
OMEGA					
2.0	20 SE, X 20 SE	2.0	1994.03 - 1999.09	mit Klimaanlage	6031.100D
2.0 16V	X 20 XEV	2.0	1994.03 - 2001.02	mit Klimaanlage	6031.100D
2.2 16V	Y 22 XE, Z 22 XE	2.2	1994.01 - 2003.06	mit Klimaanlage	6031.100D

VAUXHALL

	Motor Engine Moteur	Ltr. Ltr. Ltr.	Jahr Year Année	Einschränkung Restriction* Restriction*	Thermoschalter Thermoswitches Thermocontact
2.5 V6	X 25 XE	2.5	1994.03 - 2000.09	ohne Klimaanlage Chassis No R1000001→ →T1003097	6031.100D
			1994.03 - 2000.09	ohne Klimaanlage Chassis No T1003098→	6031.105D
3.0 V6	X 30 XE	3.0	1994.04 - 2000.07	ohne Klimaanlage Chassis No R1000001→ →T1003097	6031.100D
			1994.04 - 2000.07	ohne Klimaanlage Chassis No T1003098→	6031.105D
SENATOR					
3.0	30 NE	3.0	1988.01 - 1990.09	Chassis No →0109241	6010.95D
			1988.01 - 1990.09	Chassis No 0109242→	6031.105D
3.0 i	C 30 NE	3.0	1988.01 - 1993.09	Chassis No →0109241	6010.95D
			1988.01 - 1993.09	Chassis No 0109242→	6031.105D
SINTRA					
2.2 DTI	X 22 DTH	2.2	1997.07 - 1999.04		6031.105D
2.2 i 16 V	X 22 XE	2.2	1996.11 - 1999.04		6031.105D
3.0 i 24V	X 30 XE	3.0	1996.11 - 1999.04		6031.105D
TIGRA					
1.4 16V	X 14 XE	1.4	1994.07 - 2000.12		6031.100D
1.6 16V	X 16 XE	1.6	1994.07 - 2000.12		6031.100D
VECTRA					
1.6 i 16V	X 16 XEL, Y 16 XE, Z 16 XE	1.6	1995.08 - 2001.10	ohne Klimaanlage	6031.100D
2.0 i 16V	X 20 XEV	2.0	1995.10 - 2001.01		6031.88D

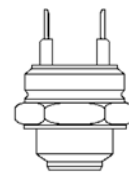

VOLKSWAGEN

	Motor Engine Moteur	Ltr. Ltr. Ltr.	Jahr Year Année	Einschränkung Restriction* Restriction*	Thermoschalter Thermostat Thermocontact
BORA					
1.6	AEH, AKL, APF	1.6	1998.10 - 1999.04 1998.10 - 1999.04		6037.95D 6039.95D
1.8	AGN, BAF	1.8	1998.10 - 1999.04 1998.10 - 1999.04		6037.95D 6039.95D
1.9 SDI	AGP, AQM	1.9	1998.10 - 1999.04 1998.10 - 1999.04		6037.95D 6039.95D
1.9 TDI	AGR, AHF, AJM, ALH, ASV, AUY	1.9	1998.10 - 1999.04 1998.10 - 1999.04		6037.95D 6039.95D
2.0	APK, AQY, AZG, AZH, AZJ, BBW	2.0	1998.10 - 1999.04 1998.10 - 1999.04		6037.95D 6039.95D
2.3 V5	AGZ	2.3	1998.12 - 1999.04 1998.12 - 1999.04		6037.95D 6039.95D
CADDY I					
1.5	JB	1.5	1982.08 - 1983.07 1982.08 - 1983.07		6017.95D 6020.95D
1.6	EM, EW	1.6	1983.01 - 1992.07 1982.10 - 1992.07		6017.95D 6020.95D
1.6 D	JK, ME	1.6	1982.08 - 1992.07 1982.08 - 1992.07		6017.95D 6020.95D
1.8	JH	1.8	1985.08 - 1992.07 1985.08 - 1992.07		6017.95D 6020.95D
CADDY II (9K9)					
1.4	AEX, AKV, APQ, AUA, AUD	1.4	1995.11 - 2004.01		6037.95D
1.4 16V	AUA	1.4	2000.08 - 2004.01		6037.95D
1.6	1F, AEE	1.6	1995.11 - 2000.09		6037.95D
1.7 SDI	AHB	1.7	1996.07 - 2000.09		6037.95D
1.9 D	1Y	1.9	1995.11 - 2004.01		6037.95D
1.9 SDI	AEY, AYQ	1.9	1995.11 - 2004.01		6037.95D
1.9 TDI	1Z, AHU, ALE, ALH	1.9	1996.09 - 2004.01		6037.95D
60 1.4	AEX, APQ, AUD	1.4	1995.11 - 2004.01		6037.95D
75 1.6	1F, AEE	1.6	1995.11 - 2000.09		6037.95D
CADDY II Pick-up (9U7)					
1.6	AEE	1.6	1996.06 - 2000.12 1996.06 - 1998.07	mit Klimaanlage ohne Klimaanlage Chassis No →9U-X-000 500	6017.95D 6010.95D
1.9 D	AEF	1.9	1996.06 - 2000.12		6017.95D
CORRADO					
1.8 16V	KR	1.8	1989.04 - 1992.07 1989.04 - 1992.07	Chassis No →50P020000 Chassis No 50R000001→	6017.95D 6037.95D
1.8 G60	PG	1.8	1988.09 - 1993.09 1988.09 - 1993.09	Chassis No →50P020000 Chassis No 50R000001→	6017.95D 6037.95D
2.0 i	2E, ADY	2.0	1993.04 - 1995.12 1993.04 - 1995.12	Chassis No →50P020000 Chassis No 50R000001→	6017.95D 6037.95D

VOLKSWAGEN

 Motor
Engine
Moteur

 Ltr.
Ltr.
Ltr.

 Jahr
Year
Année

 Einschränkung
Restriction*
Restriction*

 Thermaschalter
Thermoswitches
Thermocontact

2.0 i 16V	9A	2.0	1991.08 - 1995.12	Chassis No →50P020000	6017.95D
			1991.08 - 1995.12	Chassis No 50R000001→	6037.95D
2.9 VR6	ABV	2.9	1991.08 - 1995.12	Chassis No →50P020000	6017.95D
			1991.08 - 1995.12	Chassis No 50R000001→	6037.95D
DERBY (86, 86C, 80)					
0.9	HA	0.9	1977.02 - 1981.09	Chassis No →868 2600 000	6010.92D
			1977.02 - 1981.09	Chassis No 869 2500 001→	6020.95D
1.0	GL, HZ	1.0	1981.08 - 1984.12		6017.95D
			1981.08 - 1984.12		6020.95D
1.1	HB	1.1	1981.10 - 1983.07		6017.95D
			1977.02 - 1981.09	Chassis No →868 2600 000	6010.92D
1.3	GK, HH, HJ, HK	1.3	1981.08 - 1984.12		6017.95D
			1977.02 - 1981.09	Chassis No →868 2600 000	6010.92D
1.3	GK, HH, HJ, HK	1.3	1981.08 - 1984.12		6017.95D
			1977.02 - 1984.12	Chassis No 869 2500 001→	6020.95D
GOLF I (17)					
1.1	FA, FJ, GG, HC	1.1	1974.04 - 1983.07		6010.92D
			1981.01 - 1983.07		6017.95D
			1981.01 - 1983.07		6020.95D
1.3	GF	1.3	1979.08 - 1983.07		6017.95D
			1979.08 - 1983.07		6020.95D
1.5	FH, JB	1.5	1974.04 - 1975.12		6010.92D
			1977.08 - 1983.07		6017.95D
			1977.08 - 1983.07		6020.95D
1.5 D	CK	1.5	1976.08 - 1980.07		6020.95D
1.6	EM, FN, FP	1.6	1975.08 - 1984.02		6010.92D
1.6 D	CR, JK	1.6	1980.08 - 1983.07		6017.95D
			1980.08 - 1983.07		6020.95D
1.6 GTI	EG	1.6	1976.08 - 1982.07		6010.92D
			1976.08 - 1982.07		6020.95D
1.6 TD	CY	1.6	1982.03 - 1983.07		6017.95D
			1982.03 - 1983.07		6020.95D
1.8 GTI	DX, JJ	1.8	1982.08 - 1983.12		6017.95D
			1982.08 - 1983.12		6020.95D
GOLF I Cabriolet (155)					
1.6	EW, HN, RE	1.6	1983.08 - 1992.04		6017.95D
			1983.08 - 1992.04		6020.95D
1.8	2H, DX, EV, EX, JH, PB	1.8	1982.08 - 1993.04		6017.95D
			1982.08 - 1993.04		6020.95D
GOLF II (19E, 1G1)					
1.0	GN, HZ	1.0	1983.11 - 1991.10		6017.95D
			1983.11 - 1991.10		6020.95D
1.3	2G, GT, HK, MH, NU, NZ	1.3	1983.08 - 1992.12		6017.95D
			1983.08 - 1992.12		6020.95D

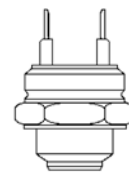

VOLKSWAGEN

	Motor Engine Moteur	Ltr. Ltr. Ltr.	Jahr Year Année	Einschränkung Restriction* Restriction*	Thermoschalter Thermostatiches Thermocontact
1.6	ABN, EZ, HM, PN, RF	1.6	1983.08 - 1992.12 1983.08 - 1992.12		6017.95D 6020.95D
1.6 D	JP, ME	1.6	1983.08 - 1991.10 1983.08 - 1991.10		6017.95D 6020.95D
1.6 TD	1V, JR, MF, RA, SB	1.6	1983.08 - 1991.10 1983.08 - 1991.10		6017.95D 6020.95D
1.8	1P, GU, GX, HV, RH	1.8	1984.08 - 1991.10 1984.08 - 1991.10		6017.95D 6020.95D
1.8 GTI	DX, EV, GZ, PB, PF, RD	1.8	1983.08 - 1991.10 1983.08 - 1991.10		6017.95D 6020.95D
1.8 GTI 16V	KR, PL	1.8	1986.02 - 1991.10 1986.02 - 1991.10		6017.95D 6020.95D
1.8 GTI G60	1H, PG	1.8	1988.08 - 1991.07 1988.08 - 1991.07		6017.95D 6020.95D
1.8 i	GX, RP	1.8	1987.08 - 1991.10 1987.08 - 1991.10		6017.95D 6020.95D
GOLF III (1H1, 1H5)					
1.4	ABD, AEX, APQ	1.4	1991.10 - 1999.04 1991.10 - 1999.04 1991.10 - 1999.04 1991.10 - 1999.04	Chassis No →1H P 990 000 Chassis No →1H P 990 000 Chassis No 1H R 000 001→ Chassis No 1H R 000 001→	6017.95D 6020.95D 6037.95D 6039.95D
1.6	ABU, AEA, AEE, AEK, AFT, AKS	1.6	1992.09 - 1999.04 1992.09 - 1999.04 1992.09 - 1999.04 1992.09 - 1999.04	Chassis No →1H P 990 000 Chassis No →1H P 990 000 Chassis No 1H R 000 001→ Chassis No 1H R 000 001→	6017.95D 6020.95D 6037.95D 6039.95D
1.8	AAM, ABS, ACC, ADZ, ANN, ANP	1.8	1991.11 - 1999.04 1991.11 - 1999.04 1991.11 - 1999.04 1991.11 - 1999.04	Chassis No →1H P 990 000 Chassis No →1H P 990 000 Chassis No 1H R 000 001→ Chassis No 1H R 000 001→	6017.95D 6020.95D 6037.95D 6039.95D
1.9 D	1Y	1.9	1991.11 - 1999.04 1991.11 - 1999.04 1991.11 - 1999.04 1991.11 - 1999.04	Chassis No →1H P 990 000 Chassis No →1H P 990 000 Chassis No 1H R 000 001→ Chassis No 1H R 000 001→	6017.95D 6020.95D 6037.95D 6039.95D
1.9 SDI	AEY	1.9	1995.07 - 1999.04 1995.07 - 1999.04	Chassis No 1H R 000 001→ Chassis No 1H R 000 001→	6037.95D 6039.95D

VOLKSWAGEN

	Motor Engine Moteur	Ltr. Ltr. Ltr.	Jahr Year Année	Einschränkung Restriction* Restriction*	Thermoschalter Thermoswitches Thermocontact
1.9 TD	AAZ	1.9	1993.07 - 1999.04	Chassis No →1H P 990 000	6017.95D
			1993.07 - 1999.04	Chassis No →1H P 990 000	6020.95D
			1993.07 - 1999.04	Chassis No 1H R 000 001→	6037.95D
			1993.07 - 1999.04	Chassis No 1H R 000 001→	6039.95D
1.9 TD, GTD	AAZ	1.9	1991.11 - 1997.08	Chassis No →1H P 990 000	6017.95D
			1991.11 - 1997.08	Chassis No →1H P 990 000	6020.95D
			1991.11 - 1997.08	Chassis No 1H R 000 001→	6037.95D
			1991.11 - 1997.08	Chassis No 1H R 000 001→	6039.95D
1.9 TDI	1Z, AFN, AHU, ALE	1.9	1993.09 - 1999.04	Chassis No →1H P 990 000	6017.95D
			1993.09 - 1999.04	Chassis No →1H P 990 000	6020.95D
			1993.09 - 1999.04	Chassis No 1H R 000 001→	6037.95D
			1993.09 - 1999.04	Chassis No 1H R 000 001→	6039.95D
2.0	2E, ABA, ADY, AGG, AKR	2.0	1991.11 - 1999.04	Chassis No →1H P 990 000	6017.95D
			1991.11 - 1999.04	Chassis No →1H P 990 000	6020.95D
			1991.11 - 1999.04	Chassis No 1H R 000 001→	6037.95D
			1991.11 - 1999.04	Chassis No 1H R 000 001→	6039.95D
2.0 GTI 16V	ABF	2.0	1992.08 - 1997.08	Chassis No →1H P 990 000	6017.95D
			1992.08 - 1997.08	Chassis No →1H P 990 000	6020.95D
			1992.08 - 1997.08	Chassis No 1H R 000 001→	6037.95D
			1992.08 - 1997.08	Chassis No 1H R 000 001→	6039.95D
2.8 VR6	AAA	2.8	1992.01 - 1997.08	Chassis No →1H P 990 000	6017.95D
			1992.01 - 1997.08	Chassis No →1H P 990 000	6020.95D
			1992.01 - 1997.08	Chassis No 1H R 000 001→	6037.95D
			1992.01 - 1997.08	Chassis No 1H R 000 001→	6039.95D
2.9 VR6	ABV	2.9	1994.10 - 1999.04	Chassis No →1H P 990 000	6017.95D
			1994.10 - 1999.04	Chassis No →1H P 990 000	6020.95D
			1994.10 - 1999.04	Chassis No 1H R 000 001→	6037.95D
			1994.10 - 1999.04	Chassis No 1H R 000 001→	6039.95D

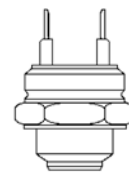

VOLKSWAGEN

	Motor Engine Moteur	Ltr. Ltr. Ltr.	Jahr Year Année	Einschränkung Restriction* Restriction*	Thermaschalter Thermaswitches Thermocontact
GOLF III Cabriolet (1E7)					
1.6	AEK, AFT, AKS	1.6	1994.10 - 1998.05 1994.10 - 1998.05		6037.95D 6039.95D
1.8	AAM, ABS, ADZ	1.8	1993.07 - 1998.05 1993.07 - 1998.05		6037.95D 6039.95D
1.9 TDI	1Z, AFN, AHU, ALE	1.9	1995.08 - 1998.05 1995.08 - 1998.05		6037.95D 6039.95D
2.0	2E, ADY, AGG, AKR	2.0	1993.07 - 1998.05 1993.07 - 1998.05		6037.95D 6039.95D
GOLF IV (1J1, 1J5)					
1.4 16V	AHW, AKQ, APE, AXP, BCA	1.4	1997.08 - 1999.04 1997.08 - 1999.04		6037.95D 6039.95D
1.6	AEH, AKL, APF	1.6	1997.08 - 1999.04 1997.08 - 1999.04		6037.95D 6039.95D
1.8	AGN, BAF	1.8	1997.08 - 1999.04 1997.08 - 1999.04		6037.95D 6039.95D
1.8 T	AGU, AQA, ARZ, AUM, AWD	1.8	1997.08 - 1999.04 1997.08 - 1999.04		6037.95D 6039.95D
1.9 SDI	AGP, AQM	1.9	1997.08 - 1999.04 1997.08 - 1999.04		6037.95D 6039.95D
1.9 TDI	AGR, AHF, AJM, ALH, ASV, AUW	1.9	1997.08 - 1999.04 1997.08 - 1999.04		6037.95D 6039.95D
2.0	APK, AQY, AZG, AZJ	2.0	1998.07 - 1999.04 1998.07 - 1999.04		6037.95D 6039.95D
2.3 V5	AGZ	2.3	1997.08 - 1999.04 1997.08 - 1999.04		6037.95D 6039.95D
GOLF IV Cabriolet (1E7)					
1.6	AFT, AKS	1.6	1998.06 - 2002.06 1998.06 - 2002.06		6037.95D 6039.95D
1.8	AAM, ADZ, ANN, ANP	1.8	1998.06 - 2002.06 1998.06 - 2002.06		6037.95D 6039.95D
1.9 TDI	AFN, AHU, ALE, AVG	1.9	1998.06 - 2002.06 1998.06 - 2002.06		6037.95D 6039.95D
2.0	AGG, AKR, ATU, AWF, AWG	2.0	1998.06 - 2002.06 1998.06 - 2002.06		6037.95D 6039.95D
ILTIS					
1.7	WL, YX	1.7	1979.03 - 1988.12		6020.95D
JETTA I (16)					
1.1	FA, GG	1.1	1978.08 - 1984.02 1978.08 - 1984.02		6017.95D 6020.95D
1.3	GF	1.3	1979.08 - 1984.02 1979.08 - 1984.02		6017.95D 6020.95D
1.5	JB	1.5	1978.08 - 1984.02 1978.08 - 1984.02		6017.95D 6020.95D
1.5 D	CK	1.5	1978.08 - 1980.07 1978.08 - 1980.07		6017.95D 6020.95D
1.6	FR	1.6	1978.08 - 1984.02 1978.08 - 1984.02		6017.95D 6020.95D
1.6 D	CR, JK	1.6	1980.08 - 1984.02 1980.08 - 1984.02		6017.95D 6020.95D
1.6 GLI	EG	1.6	1978.08 - 1982.07 1978.08 - 1982.07		6017.95D 6020.95D
1.6 TD	CY	1.6	1982.03 - 1984.02 1982.03 - 1984.02		6017.95D 6020.95D

VOLKSWAGEN

 Motor
Engine
Moteur

 Ltr.
Ltr.
Ltr.

 Jahr
Year
Année

 Einschränkung
Restriction*
Restriction*

 Thermaschalter
Thermoswitches
Thermocontact

1.8	DX, JJ	1.8	1982.08 - 1984.02 1982.08 - 1984.02		6017.95D 6020.95D
JETTA II					
1.3	2G, HK, MH, NZ	1.3	1984.01 - 1991.12 1984.01 - 1991.12		6017.95D 6020.95D
1.6	ABN, EZ, HM, PN, RF	1.6	1984.01 - 1992.07 1984.01 - 1992.07		6017.95D 6020.95D
1.6 D	JP, ME	1.6	1984.01 - 1991.10 1984.01 - 1991.10		6017.95D 6020.95D
1.6 TD	1V, JR, MF, RA, SB	1.6	1984.01 - 1991.10 1984.01 - 1991.10		6017.95D 6020.95D
1.8	1P, EV, GU, GX, GZ, HV, PB, PF, RD, RH, RP	1.8	1984.01 - 1991.10 1984.01 - 1991.10		6017.95D 6020.95D
1.8 16V	KR, PL	1.8	1986.08 - 1991.10 1986.08 - 1991.10		6017.95D 6020.95D
LUPO					
1.0	AER, ALD, ALL, ANV, AUC	1.0	1998.09 - 2005.07 1998.09 - 2005.07		6037.95D 6039.95D
1.2 TDI 3L	ANY, AYZ	1.2	1999.07 - 2005.07 1999.07 - 2005.07		6037.95D 6039.95D
1.4	AUD	1.4	2000.10 - 2005.07 2000.10 - 2005.07		6037.95D 6039.95D
1.4 16V	AFK, AHW, AKQ, APE, AQQ, AUA, AUB, BBY	1.4	1998.09 - 2005.07 1998.09 - 2005.07		6037.95D 6039.95D
1.4 FSI	ARR	1.4	2001.02 - 2005.07 2001.02 - 2005.07		6037.95D 6039.95D
1.6 GTI	AVY	1.6	2000.09 - 2005.07 2000.09 - 2005.07		6037.95D 6039.95D
1.7 SDI	AKU	1.7	1998.09 - 2005.07 1998.09 - 2005.07		6037.95D 6039.95D
NEW BEETLE					
1.6	AYD, BFS	1.6	2000.06 -		6037.95D
1.9 TDI	ALH	1.9	1998.01 - 2004.06		6037.95D
2.0	AEG, APK, AQY, AVH, AZG, AZJ, BEJ, BER, BEV, BHP, CBPA	2.0	1998.01 - 2001.05		6037.95D
PASSAT (32/33)					
1.3	FY, ZA, ZF	1.3	1973.05 - 1980.07 1973.05 - 1980.07	Chassis No →328 2300 000 Chassis No 329 2000 001→	6010.92D 6020.95D
1.5	YJ, ZB, ZC	1.5	1973.05 - 1975.12		6010.92D
1.5 D	CK	1.5	1977.02 - 1980.07 1977.02 - 1980.07	Chassis No →328 2300 000 Chassis No 329 2000 001→	6010.92D 6020.95D
1.6	FS, YN, YP	1.6	1975.08 - 1980.07 1975.08 - 1980.07	Chassis No →328 2300 000 Chassis No 329 2000 001→	6010.92D 6020.95D
1.6 D	CR	1.6	1979.02 - 1980.07 1979.02 - 1980.07	Chassis No →328 2300 000 Chassis No 329 2000 001→	6010.92D 6020.95D

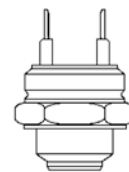
VOLKSWAGEN

	Motor Engine Moteur	Ltr. Ltr. Ltr.	Jahr Year Année	Einschränkung Restriction* Restriction*	Thermoschalter Thermoswitches Thermocontact
1.6 i	YS	1.6	1978.06 - 1980.07 1978.06 - 1980.07	Chassis No →328 2300 000 Chassis No 329 2000 001→	6010.92D 6020.95D
PASSAT (32B)					
1.3	EP, EU, FY, FZ	1.3	1980.08 - 1986.07 1980.08 - 1986.07		6017.95D 6020.95D
1.6	DT, PP, RL, WV, YN, YP	1.6	1980.08 - 1988.03 1980.08 - 1988.03		6017.95D 6020.95D
1.6 D	CR, JK	1.6	1980.08 - 1988.03 1980.08 - 1988.03		6017.95D 6020.95D
1.6 TD	CY, RA	1.6	1982.04 - 1988.03 1982.04 - 1988.03		6017.95D 6020.95D
1.8	DS, DZ, JN, JV, RM	1.8	1983.01 - 1988.03 1983.01 - 1988.03		6017.95D 6020.95D
1.9	WN	1.9	1981.01 - 1983.07 1981.01 - 1983.07		6017.95D 6020.95D
2.0	HP, JS	2.0	1983.08 - 1988.03 1983.08 - 1988.03		6017.95D 6020.95D
2.2	JT, KV, KX	2.2	1985.01 - 1988.03 1985.01 - 1988.03		6017.95D 6020.95D
PASSAT (35I, 3A2, 3A5)					
1.6	1F, ABN, AEK, AFT, EZ	1.6	1988.02 - 1991.09 1988.02 - 1991.09 1994.07 - 1996.08 1994.07 - 1996.08		6017.95D 6020.95D 6037.95D 6039.95D
1.6 TD	RA, SB	1.6	1988.08 - 1993.09 1988.08 - 1993.09		6017.95D 6020.95D
1.8	AAM, ABS, ADZ, PB, PF, RP	1.8	1988.02 - 1997.05 1988.02 - 1997.05 1990.08 - 1997.05 1990.08 - 1997.05		6017.95D 6020.95D 6037.95D 6039.95D
1.8 16V	KR	1.8	1988.04 - 1989.12 1988.04 - 1989.12		6017.95D 6020.95D
1.8 G60	PG	1.8	1988.08 - 1997.05		6017.95D
1.8 GL	KR	1.8	1991.08 - 1993.09 1991.08 - 1993.09		6017.95D 6020.95D
1.9 D	1Y	1.9	1989.05 - 1993.10 1989.05 - 1993.10		6017.95D 6020.95D
1.9 TD	AAZ	1.9	1991.03 - 1997.05 1991.03 - 1997.05		6037.95D 6039.95D
1.9 TDI	1Z, AFN, AHU	1.9	1993.10 - 1997.05 1993.10 - 1997.05		6037.95D 6039.95D
2.0	2E, ADY, AEP, AGG	2.0	1990.02 - 1997.05 1990.02 - 1997.05 1995.03 - 1996.08 1995.03 - 1996.08		6017.95D 6020.95D 6037.95D 6039.95D
2.0 16V	9A, ABF	2.0	1988.08 - 1993.09 1988.08 - 1993.09 1994.01 - 1997.05 1994.01 - 1997.05		6017.95D 6020.95D 6037.95D 6039.95D
2.8 VR6	AAA	2.8	1991.06 - 1997.05 1991.06 - 1997.05		6037.95D 6039.95D
2.9 VR6	ABV	2.9	1994.01 - 1997.05 1994.01 - 1997.05		6037.95D 6039.95D

VOLKSWAGEN

	Motor Engine Moteur	Ltr. Ltr. Ltr.	Jahr Year Année	Einschränkung Restriction* Restriction*	Thermaschalter Thermoswitches Thermocontact
PASSAT (3B2, 3B5)					
1.6	ADP, AHL, ANA, ARM	1.6	1996.10 - 2000.11 1996.10 - 2000.11		6017.95D 6024.95D
1.8	ADR, APT, ARG	1.8	1996.10 - 2000.11 1996.10 - 2000.11		6017.95D 6024.95D
1.8 T	AEB, ANB, APU	1.8	1996.10 - 2000.11 1996.10 - 2000.11		6017.95D 6024.95D
1.9 TDI	AFN, AHH, AHU, AJM, ATJ, AVG	1.9	1996.10 - 2000.11 1996.10 - 2000.11		6017.95D 6024.95D
2.3 VR5	AGZ	2.3	1996.10 - 2000.11 1996.10 - 2000.11		6017.95D 6024.95D
2.5 TDI	AFB, AKN	2.5	1998.07 - 2000.11 1998.07 - 2000.11		6017.95D 6024.95D
2.8	AGE	2.8	1997.05 - 1999.09 1997.05 - 1999.09		6017.95D 6024.95D
2.8 V6	ACK, ALG, APR, AQD	2.8	1996.08 - 2000.11 1996.08 - 2000.11		6017.95D 6024.95D
POLO (80, 86, 86C) 1975-->1994					
0.8	HE	0.8	1975.09 - 1981.09 1975.09 - 1981.09	Chassis No →868 2600 000 Chassis No 869 2500 001→	6010.92D 6020.95D
0.9	HA	0.9	1981.10 - 1981.12 1975.09 - 1981.09 1975.09 - 1981.12	Chassis No →868 2600 000 Chassis No 869 2500 001→	6017.95D 6010.92D 6020.95D
1.0	AAK, AAU, ACM, GL, HZ	1.0	1981.10 - 1994.09 1981.10 - 1994.09 1985.08 - 1994.09 1985.08 - 1994.09	Chassis No →80 P 500 000 Chassis No →80 P 500 000 Chassis No 80 R 000 001→ Chassis No 80 R 000 001→	6017.95D 6020.95D 6037.95D 6039.95D
1.1	HB, HC	1.1	1981.10 - 1989.09 1975.03 - 1981.09 1975.03 - 1989.09	Chassis No →868 2600 000 Chassis No 869 2500 001→	6017.95D 6010.92D 6020.95D
1.3	2G, 3F, AAV, GK, GT, HH, HJ, HK, MH, NZ	1.3	1976.12 - 1981.09 1981.10 - 1994.09 1976.12 - 1994.09 1987.07 - 1994.09 1987.07 - 1994.09	Chassis No →868 2600 000 Chassis No →80 P 500 000 Chassis No 869 2500 001→ →80 P 500 000 Chassis No 80 R 000 001→ Chassis No 80 R 000 001→	6010.92D 6017.95D 6020.95D 6037.95D 6039.95D
1.3 D	MN	1.3	1986.08 - 1990.08 1986.08 - 1990.08		6017.95D 6020.95D

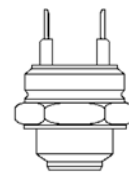

VOLKSWAGEN

	Motor Engine Moteur	Ltr. Ltr. Ltr.	Jahr Year Année	Einschränkung Restriction* Restriction*	Thermoschalter Thermoswitches Thermocontact
1.3 G40	PY	1.3	1987.01 - 1994.09	Chassis No →80 P 500 000	6017.95D
			1987.01 - 1994.09	Chassis No →80 P 500 000	6020.95D
			1990.08 - 1994.09	Chassis No 80 R 000 001→	6037.95D
			1990.08 - 1994.09	Chassis No 80 R 000 001→	6039.95D
1.4 D	1W	1.4	1990.08 - 1994.09	Chassis No →80 P 500 000	6017.95D
			1990.08 - 1994.09	Chassis No →80 P 500 000	6020.95D
			1990.08 - 1994.09	Chassis No 80 R 000 001→	6037.95D
			1990.08 - 1994.09	Chassis No 80 R 000 001→	6039.95D
POLO (6N_) 1994-->1999					
1.0	AAU	1.0	1994.10 - 1999.12	Chassis No →80 P 500 000	6017.95D
			1994.10 - 1999.12	Chassis No →80 P 500 000	6020.95D
			1994.10 - 1999.12	Chassis No 80 R 000 001→	6037.95D
			1994.10 - 1999.12	Chassis No 80 R 000 001→	6039.95D
1.4	AEX, APQ	1.4	1998.05 - 1999.12		6037.95D
			1998.05 - 1999.12		6039.95D
1.7 SDI	AHG, AKU	1.7	1997.04 - 1999.12		6037.95D
			1997.08 - 1999.12		6039.95D
1.9 D	AEF	1.9	1994.10 - 1999.12		6037.95D
			1994.10 - 1999.12		6039.95D
1.9 SDI	AGD	1.9	1996.07 - 1999.12		6037.95D
			1996.07 - 1999.12		6039.95D
100 1.4 16V	AFH	1.4	1996.04 - 1999.10		6037.95D
			1996.04 - 1999.10		6039.95D
120 1.6 16V GTI	AJV	1.6	1998.09 - 1999.10		6037.95D
			1998.09 - 1999.10		6039.95D
45 1.0	AEV	1.0	1994.10 - 1996.09		6037.95D
			1994.10 - 1996.09		6039.95D
50 1.0	AER, ALL	1.0	1996.09 - 1999.10		6037.95D
			1996.09 - 1999.10		6039.95D
55 1.3	ADX	1.3	1994.10 - 1995.07		6037.95D
			1994.10 - 1995.07		6039.95D
55 1.4	AEX	1.4	1995.08 - 1999.10		6037.95D
			1995.08 - 1999.10		6039.95D
60 1.4	AEX, AKV, APQ	1.4	1995.07 - 1999.10		6037.95D
			1995.07 - 1999.10		6039.95D
60 1.7 SDI	AKU	1.7	1997.08 - 1999.10		6037.95D
			1997.08 - 1999.10		6039.95D
64 1.9 D	AEF	1.9	1994.10 - 1999.10		6037.95D
			1994.10 - 1999.10		6039.95D
64 1.9 SDI	AGD	1.9	1996.07 - 1999.10		6037.95D
			1996.07 - 1999.10		6039.95D
75 1.6	AEA, AEE, AHS	1.6	1994.10 - 1999.10		6037.95D
			1994.10 - 1999.10		6039.95D

VOLKSWAGEN

 Motor
Engine
Moteur

 Ltr.
Ltr.
Ltr.

 Jahr
Year
Année

 Einschränkung
Restriction*
Restriction*

 Thermoschalter
Thermoswitches
Thermocontact

POLO (6KV2, 6KV5, 6N2) 1999-->2002

1.0	ALD, AUC	1.0	1999.10 - 2001.09 1999.10 - 2001.09		6037.95D 6039.95D
1.4	AEX, AKK, AKP, AKV, ANW, ANX, APQ, AUD	1.4	1997.05 - 2001.09 1997.05 - 2001.09		6037.95D 6039.95D
1.4 16V	AFK, AHW, APE, AQQ, AUA, AUB	1.4	1999.10 - 2001.09 1999.10 - 2001.09		6037.95D 6039.95D
1.6	AEE, AEH, AFT, AKL, ALM, APF, AUR	1.6	1997.05 - 2001.09 1997.05 - 2001.09		6037.95D 6039.95D
1.6 16V GTI	ARC, AVY	1.6	1999.10 - 2001.09		6039.95D
1.7 SDI	AKU, AKW	1.7	1997.08 - 2001.09 1997.08 - 2001.09		6037.95D 6039.95D
1.8	ADZ	1.8	1997.05 - 2001.09 1997.05 - 2001.09		6037.95D 6039.95D
1.9 D	AEF	1.9	1999.10 - 2001.09 1999.10 - 2001.09		6037.95D 6039.95D
1.9 SDI	AEY, AGD, AGP, AQM, ASX	1.9	1997.06 - 2001.09 1997.06 - 2001.09		6037.95D 6039.95D
1.9 TDI	AFN, AGR, AHU, ALE, ALH, ASV	1.9	1997.05 - 2001.09 1997.05 - 2001.09		6037.95D 6039.95D
100 1.6	AEH, AFT, AKL, APF, AUR	1.6	1995.12 - 2001.09 1995.12 - 2001.09		6037.95D 6039.95D
110 1.9 TDI	AFN, ASV	1.9	1998.06 - 2001.09 1998.06 - 2001.09		6037.95D 6039.95D
2.0	ADC	2.0	1999.08 - 2001.09 1999.08 - 2001.09		6037.95D 6039.95D
54 1.4	ANX	1.4	1998.01 - 1999.08 1998.01 - 1999.08		6037.95D 6039.95D
57 1.7 SDI	AKW	1.7	1997.07 - 2001.09 1997.07 - 2001.09		6037.95D 6039.95D
60 1.4	AEX, AKK, AKV, ANW, APQ, AUD	1.4	1995.12 - 2001.09 1995.12 - 2001.09		6037.95D 6039.95D
64 1.9 SDI	AEY	1.9	1995.12 - 1999.08 1995.12 - 1999.08		6037.95D 6039.95D
68 1.9 SDI	AGP, AQM	1.9	1999.08 - 2001.09 1999.08 - 2001.09		6037.95D 6039.95D
75 1.4 16V	APE, AUA	1.4	1999.10 - 2001.09 1999.10 - 2001.09		6037.95D 6039.95D
75 1.6	1F, AEE, ALM	1.6	1995.11 - 2001.09 1995.11 - 2001.09		6037.95D 6039.95D
90 1.8	ADD	1.8	1997.01 - 2001.09 1997.01 - 2001.09		6037.95D 6039.95D
90 1.9 TDI	AGR, AHU, ALE, ALH	1.9	1996.09 - 2001.09 1996.09 - 2001.09		6037.95D 6039.95D

SANTANA (32B)

1.3	FZ	1.3	1981.08 - 1983.07 1981.08 - 1983.07		6017.95D 6020.95D
1.6	DT, WV, YP	1.6	1981.08 - 1984.12 1981.08 - 1984.12		6017.95D 6020.95D
1.6 D	CR, JK	1.6	1981.08 - 1984.12 1981.08 - 1984.12		6017.95D 6020.95D
1.6 TD	CY	1.6	1981.12 - 1984.12 1981.12 - 1984.12		6017.95D 6020.95D
1.8	DS	1.8	1983.01 - 1984.12 1983.01 - 1984.12		6017.95D 6020.95D
1.9	WN	1.9	1981.08 - 1983.07 1981.08 - 1983.07		6017.95D 6020.95D

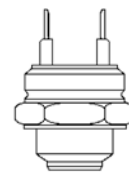
VOLKSWAGEN

	Motor Engine Moteur	Ltr. Ltr. Ltr.	Jahr Year Année	Einschränkung Restriction* Restriction*	Thermoschalter Thermoswitches Thermocontact
2.0	HP, JS	2.0	1983.08 - 1984.12 1983.08 - 1984.12		6017.95D 6020.95D
SCIROCCO (53, 53B)					
1.5	JB	1.5	1980.08 - 1983.12 1980.08 - 1983.12		6017.95D 6020.95D
1.6	EW, RE	1.6	1983.01 - 1990.07 1983.01 - 1990.07		6017.95D 6020.95D
1.8	DX, EV, EX, JH, JJ, PB	1.8	1982.08 - 1992.07 1982.08 - 1992.07		6017.95D 6020.95D
1.8 16V	KR, PL	1.8	1985.10 - 1992.07 1985.10 - 1992.07		6017.95D 6020.95D
SHARAN					
1.8 T 20V	AJH, AWC	1.8	1997.09 -		6037.95D
1.9 TDI	1Z, AFN, AHU, ANU, ASZ, AUJ, AVG, BVK	1.9	1995.09 - 2000.04		6037.95D
2.0	ADY, ATM	2.0	1995.09 -		6037.95D
2.8 V6 24V	AYL	2.8	2000.04 -		6037.95D
2.8 VR6	AAA, AMY	2.8	1995.09 - 2000.04		6037.95D
TRANSPORTER T3					
1.6 D	CS	1.6	1981.01 - 1987.07	Chassis No 24 F 000 001→	6087.87D
1.6 TD	JX	1.6	1984.08 - 1992.07	Chassis No 24 F 000 001→	6087.87D
1.7 D	KY	1.7	1986.10 - 1992.07		6087.87D
1.9	DF, DG, DH, GW	1.9	1982.08 - 1992.07 1982.08 - 1992.07 1982.08 - 1992.07	Chassis No →24 E 200 000 Chassis No 24 D 000 001→ Chassis No 24 F 000 001→	6017.95D 6020.95D 6087.87D
2.1	DJ, MV, SR	2.1	1985.08 - 1992.07		6087.87D
2.1 i	SS	2.1	1989.07 - 1992.07		6087.87D
TRANSPORTER T4					
1.8	PD	1.8	1990.12 - 1992.07		6087.87D
1.9 D	1X	1.9	1990.07 - 2003.04 1990.07 - 2003.04	Chassis No →70 P 250 000 Chassis No 70 R 000 001→	6087.87D 6037.87D
1.9 TD	ABL	1.9	1992.10 - 2003.04 1992.10 - 2003.04	Chassis No →70 P 250 000 Chassis No 70 R 000 001→	6087.87D 6037.87D
2.0	AAC	2.0	1990.07 - 2003.04 1990.07 - 2003.04	Chassis No →70 P 250 000 Chassis No 70 R 000 001→	6087.87D 6037.87D
2.4 D	AAB, AJA	2.4	1990.07 - 1998.09 1990.07 - 2003.04 1990.07 - 1998.09		6037.81D 6037.87D 6087.87D
2.5	AAF, ACU, AEN, AET, AEU, APL, AVT	2.5	1990.11 - 2003.04 1990.11 - 2003.04	Chassis No →70 P 250 000 Chassis No 70 R 000 001→	6087.87D 6037.87D
2.5 TDI	ACV, AHY, AJT, AUF, AXG, AXL, AYC, AYY	2.5	1995.09 - 2003.04		6037.87D

VOLKSWAGEN
**Motor
Engine
Moteur**
**Ltr.
Ltr.
Ltr.**
**Jahr
Year
Année**
**Einschränkung
Restriction*
Restriction***
**Thermoschalter
Thermoswitches
Thermocontact**

2.8 V6	AMV	2.8	2000.04 - 2003.04		6037.87D
2.8 VR 6	AES	2.8	1995.11 - 2000.04		6037.87D
VENTO					
1.4	ABD, AEX	1.4	1991.11 - 1998.09	Chassis No →1H P 990 000	6017.95D
			1991.11 - 1998.09	Chassis No →1H P 990 000	6020.95D
			1991.11 - 1998.09	Chassis No 1H R 000 001→	6037.95D
1.6	ABU, AEA, AEE, AEK, AFT	1.6	1992.09 - 1998.09	Chassis No →1H P 990 000	6017.95D
			1992.09 - 1998.09	Chassis No →1H P 990 000	6020.95D
			1992.09 - 1998.09	Chassis No 1H R 000 001→	6037.95D
1.8	AAM, ABS, ADZ	1.8	1991.11 - 1998.09	Chassis No →1H P 990 000	6017.95D
			1991.11 - 1998.09	Chassis No →1H P 990 000	6020.95D
			1991.11 - 1998.09	Chassis No 1H R 000 001→	6037.95D
1.9 D	1Y	1.9	1991.11 - 1998.09	Chassis No →1H P 990 000	6017.95D
			1991.11 - 1998.09	Chassis No →1H P 990 000	6020.95D
			1991.11 - 1998.09	Chassis No 1H R 000 001→	6037.95D
1.9 SDI	AEY	1.9	1997.04 - 1998.09		6037.95D
			1997.04 - 1998.09		6039.95D
1.9 TD	AAZ	1.9	1991.11 - 1998.09	Chassis No →1H P 990 000	6017.95D
			1991.11 - 1998.09	Chassis No →1H P 990 000	6020.95D
			1991.11 - 1998.09	Chassis No 1H R 000 001→	6037.95D
1.9 TDI	1Z, AFN, AHU, ALE	1.9	1996.04 - 1998.09		6039.95D
			1993.09 - 1998.09	Chassis No →1H P 990 000	6017.95D
			1993.09 - 1998.09	Chassis No →1H P 990 000	6020.95D
			1993.09 - 1998.09	Chassis No 1H R 000 001→	6037.95D
2.0	2E, ADY, AGG, AKR	2.0	1991.11 - 1998.09	Chassis No →1H P 990 000	6017.95D
			1991.11 - 1998.09	Chassis No →1H P 990 000	6020.95D
			1991.11 - 1998.09	Chassis No 1H R 000 001→	6037.95D
2.8 VR6	AAA	2.8	1992.01 - 1998.09	Chassis No →1H P 990 000	6017.95D
			1992.01 - 1998.09	Chassis No →1H P 990 000	6020.95D
			1992.01 - 1998.09	Chassis No 1H R 000 001→	6037.95D

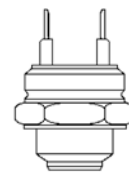

WARTBURG

Motor
Engine
Moteur

Ltr.
Ltr.
Ltr.

Jahr
Year
Année

Einschränkung
Restriction*
Restriction*

Thermoschalter
Thermostatich
Thermocontact

353					
1.0	1A, 353, 18	1.0	1966.06 - 1989.01 1975.02 - 1988.08		6020.92D 6020.95D
1.3	4VO7, 2/7, 5GRF	1.3	1988.09 - 1991.05		6020.95D

ZASTAVA
**Motor
Engine
Moteur**
**Ltr.
Ltr.
Ltr.**
**Jahr
Year
Année**
**Einschränkung
Restriction*
Restriction***
**Thermoschalter
Thermoswitches
Thermocontact**
101 (1100)

1.1	128 A.000, 128 A.064	1.1	1973.06 - 1993.12		6010.95D
1.1 Super	128 AC 5000	1.1	1979.07 - 1981.09		6010.95D

YUGO

1.1 60 EFI (145 A)	100 GL. 0.64, 11 E 1.064	1.1	1991.08 - 1995.06		6010.95D
1.3 65 EFI (145 A)	13 E 1.064	1.3	1991.08 - 1995.06		6010.95D

YUGO FLORIDA

1.3 (103 A)	13 E.3.064	1.3	1991.03 -		6010.95D
-------------	------------	-----	-----------	--	-----------------

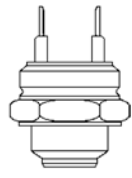

Vergleichsliste | Cross References

Hersteller Manufacturer Réf. Constructeur	Hersteller-Nr. Manufacturer's Ref. Réf. Constructeurs	Wahler-Nr Wahler-ref. Réf. Wahler	Hersteller Manufacturer Réf. Constructeur	Hersteller-Nr. Manufacturer's Ref. Réf. Constructeurs	Wahler-Nr Wahler-ref. Réf. Wahler	
AGCO	X815.090.002.000	2391.75		077 121 113 C	4274.82D	
				078 121 113 C	4274.87D	
ALFA ROMEO	105.00.01.064.00	3000.83		078 121 113 F	4274.87D	
	105.00.01.064.01	3000.83		078 121 113 G	4274.92D	
	5177 0698	411193.82D		078 121 113 H	4274.92D	
	5520 2510	410049.88D		078 121 113 J	4274.87D	
	5521 5006	410871.80D ▲		191 959 481 A	6017.95D	
	6050 4230	4003.86		191 959 481 B	6020.95D	
	6051 6212	4160.83D		191 959 481 C	6017.95D	
	6066 3619	410590.88D		1H0 959 481	6037.95D	
	6071 0617	3067.83		1H0 959 481 B	6037.95D	
	6071 3535	4008.79D		251 959 481	6017.95D	
	6081 5681	410512.88D		251 959 481 G	6087.87D	
	6081 6681	410511.88D		251 959 481 H	6087.87D	
	7175 4778	410049.88D		251 959 481 K	6087.87D	
	761 5234	4022.82D1		321 959 481 A	6017.95D	
				321 959 481 C	6017.95D	
ASTON MARTIN	52 06 139	3004.82		321 959 481 D	6017.95D	
				321 959 481 E	6020.95D	
AUDI	022 121 113	4455.80D		6U0 959 481 A	6017.95D	
	025 121 113 D	4155.87D		811 959 481	6024.95D	
	025 121 113 E	4155.87D		823 959 481	6010.92D	
	025 121 113 F	4155.87D		823 959 481 A	6010.92D	
	030 121 113 B	4264.84D		823 959 481 F	6010.92D	
	032 121 110 B	3143.87D		823 959 481 G	6010.95D	
	032 121 110 F	3167.83D		823 959 481 L	6010.92D	
	032 121 110 L	410475.87D		867 959 481	6039.95D	
	032 121 110 P	3143.87D		893 959 481	6024.95D	
	032 121 121 G	410475.87D				
	032 121 121 K	410475.87D		AUTOBIANCHI	415 4313	3023.87D
	035 121 113	4088.80D			421 8649	3345.79
	035 121 113 B	4088.87D			426 3997	6010.95D
	036 121 113	3091.92D			4355 8460	4091.82D
	036 121 113 A	3091.92D			4409 2540	4091.82D
	036 121 113 B	3091.92D			7545 9580	3105.87D
	03G 121 111 A	4820.87D			7581 3190	3105.87D
	03G 121 113	3472.87D				
	03G 121 113 A	4820.87D		BMW	11 51 7 500 597	410793.95D
	03L 121 111 AE	410845.87D			11 53 0 139 877	4326.97D
	03L 121 111 R	410845.92D			11 53 1 247 125	410792.95D
	03L 121 111 S	410845.92D			11 53 1 251 041	4231.80D
	03L 121 113 B	410537.92D			11 53 1 253 248	3344.80
	03L 121 114 B	410536.92D			11 53 1 253 249	3344.80
	044 121 113	4264.87D			11 53 1 254 065	4231.80D
	050 121 113 C	3141.87D			11 53 1 260 720	3344.75
	052 121 113 A	3091.92D			11 53 1 264 668	4232.80D
	056 121 113 A	4256.80D			11 53 1 265 085	4232.80D
	056 121 113 D	4264.87D			11 53 1 265 086	4232.71
	059 121 113 A	4006.82D			11 53 1 312 288	4619.80
	059 121 113 B	4006.82D			11 53 1 315 063	4619.80
	068 121 113 H	4253.87D			11 53 1 318 274	4621.80D
	069 121 113	4116.87D1			11 53 1 432 881	410792.95D
	06D 121 111 G	411186.87D			11 53 1 436 042	411573.105D ▲
	06F 121 111 F	411187.87D			11 53 1 436 823	4326.97D
075 121 113 D	4123.80D			11 53 1 437 040	4326.97D	
077 121 113	4274.87D			11 53 1 437 085	411573.105D ▲	
077 121 113 B	4274.87D			11 53 1 466 174	4235.71D	

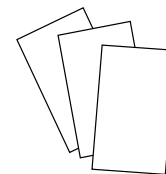

Hersteller Manufacturer Réf. Constructeur	Hersteller-Nr. Manufacturer's Ref. Réf. Constructeurs	Wahler-Nr Wahler-ref. Réf. Wahler	Hersteller Manufacturer Réf. Constructeur	Hersteller-Nr. Manufacturer's Ref. Réf. Constructeurs	Wahler-Nr Wahler-ref. Réf. Wahler	
	11 53 1 485 847	410263.91D		90 411 948	4177.92D	
	11 53 1 501 173	410263.91D		92 062 728	4189.87D	
	11 53 1 702 279	4519.95D		92 067 408	4189.87D	
	11 53 1 704 704	4594.90D		96 143 939	3017.87D2	
	11 53 1 710 056	4516.85D	CHRYSLER	04494 469	3000.90	
	11 53 1 710 953	4235.80D		04778 975	4158.80D	
	11 53 1 712 043	4238.92D		0489 2642 AC	410871.80D ▲	
	11 53 1 713 040	4235.80D		3156283	3000.83	
	11 53 1 720 033	4516.85D		4693 117 AA	410263.91D	
	11 53 1 720 306	4516.85D		4778 975	4158.80D	
	11 53 1 721 002	4236.88D		5098 918 AA	4281.87D	
	11 53 1 721 003	4236.88D		5202 8185 AB	3000.90	
	11 53 1 727 145	4237.80D		52028185	3000.90	
	11 53 1 729 720	4516.85D		5278 144 AA	410262.91D	
	11 53 1 729 841	4516.85D		6801 3949 AA	4833.100D	
	11 53 1 731 486	4516.70D		MD 194988	410180.82D	
	11 53 1 733 803	4236.92D		T 069 7157	4147.80D	
	11 53 1 739 755	410792.95D				
	11 53 1 743 528	4238.92D		CITROËN	1336 A7	3431.80D
	11 53 1 743 542	4238.92D			1336 AA	410075.79D ▲
	11 53 2 243 126	4237.80D			1336 N5	3463.89D
	11 53 2 244 151	4237.80D			1336 Q1	3463.89D
	11 53 2 246 199	4237.80D			1336 Q2	410184.89D
	11 53 2 246 825	4237.88D	1336 Z0		410705.89D	
	11 53 7 502 779	4508.105D	1337 26		3053.75	
	11 53 7 509 227	4326.97D	1338 11		3136.88D50	
	11 53 7 510 959	4337.105D	1338 21		4821.89D	
	11 53 7 511 083	4236.92D	1338 23		4446.83D	
	11 53 7 511 580	4236.88D	1338 26		4450.89D	
	11 53 7 536 655	410086.97D0	1338 38		410058.84D	
	11 53 7 544 788	410086.97D0	1338 39		4450.83D	
	11 53 7 549 476	410086.97D0	1338 44		3136.88D50	
	11 53 7 550 172	410087.97D0	1338 71		4447.85D	
	11 53 7 552 403	411574.102D ▲	1338 72		4447.80D	
	11 53 7 586 885	4508.105D	1338 90		4174.82D	
	11 53 7 596 787	410263.91D	1338 A0		3483.89D	
	11 53 7 601 158	410766.103D0 ▲	1338 F5		3497.88D	
	11 53 7 791 072	410231.82D	5454410R		3033.78D	
	11 53 9 055 587	3344.80	5474546		6010.88D	
	13 54 1 730 682	7129.00D ▲	5490459C	3033.78D		
			75441833	3033.78D		
BUGATTI	271990009-00	4618.70	79 100 111 01	3136.82D50		
	27199003-00	4618.82	79 100 118 73	3053.75		
BUICK			79 100 118 80	3136.88D50		
	93235636	410520.92D ▲	79 100 143 90	3136.82D50		
CATERPILLAR			79 100 165 60	3136.82D50		
	4 N 6958	4256.80D	91 500 723	3061.82		
	4 N 6959	4256.80D	93 501 145	4147.80D		
	9 L 9119	4256.80D	93 501 386	4147.80D		
	9 L 9652	4256.80D	95 492 929	3033.78D		
	9 N 5020	4256.80D	95 495 311	3033.84D ▲		
	9 N 5065	4256.80D	96 006 231	4821.89D		
	9 N 5121	4256.80D	96 049 146	3136.88D50		
	9 N 5488	4256.80D	96 050 286 80	3136.88D50		
CHEVROLET			96 057 136	3136.88D50		
	606 203 02 75	4176.85D	96 058 051	4447.85D		
	9 698 4104	4431.105D	96 108 092	4450.89D		

Vergleichsliste | Cross References

Hersteller Manufacturer Réf. Constructeur	Hersteller-Nr. Manufacturer's Ref. Réf. Constructeurs	Wahler-Nr Wahler-ref. Réf. Wahler	Hersteller Manufacturer Réf. Constructeur	Hersteller-Nr. Manufacturer's Ref. Réf. Constructeurs	Wahler-Nr Wahler-ref. Réf. Wahler
CITROËN	96 118 108	4447.80D	DODGE	9011 0080	410864.83D0
	96 145 00 980	410058.84D		5080 146 AB	410171.87D
	96 159 513	4147.80D		F 150.204.050.011	2391.75
	96 160 901	4446.83D		F 281.200.050.020	2389.75/1
	96 171 780 80	3136.82D50			
	96 300 66 780	3463.89D			
	96 300 666 80	3483.89D		EVOBUS	83 129 996 050
DACIA	77 00 101 179	126104 ▲	FIAT	F 150 204 050 10	2391.75
	77 00 866 387	126104 ▲		F 150 204 050 11	2391.75
	77 00 872 554	3466.89D		F 281 200 050 20	2389.75/1
	82 00 374 994	411043.89D		X 815 090 002 000	2391.75
	82 00 400 554	411039.83D		X 815 090 003 000	2389.75/1
	82 00 558 758	411039.83D			
	82 00 558 783	411043.89D		13 0707 7080	6031.88D
	82 00 561 420	126104 ▲		2828 6103	6010.92D
	82 00 660 882	3166.89D		406 2141	3000.83
	82 00 772 985	3466.89D		406 2172	3000.83
	82 00 954 288	411039.83D		406 5540	3000.83
DAEWOO	110 200 03 15	4276.87D	408 6415	3000.83	
	606 203 02 75	4176.85D	411 4572	6010.92D	
	90 354 822	4144.92D	413 8169	3000.83	
	90 411 948	4177.92D	415 4312	3023.87D	
	92 061 279	4180.82D	415 4313	3023.87D	
	92 062 728	4189.87D	4218 6500	3345.79	
	92 067 408	4189.87D	422 0309	4033.82D	
	96 143 939	3017.87D2	423 5333	6010.92D	
			423 5533	6010.92D	
			424 0878	6010.92D	
DAF	075 0562	4619.80	426 3597	6010.92D	
	129 3885 / F75-85-95	411133.80D	434 0878	6010.95D	
	166 1375 / CF 75	411135.87D	435 1196	4091.82D	
	168 4900 / CF 75	411135.83D	440 9254	4091.82D	
	225 070	3029.83	443 7481	4033.82D	
	295 024	4619.80	4641 7962	410515.88D	
	750 562	4619.80	4646 4992	3481.88D	
			4646 6123	4247.80D	
DAIHATSU	90048-33021-000	3119.88	4647 7717	6035.92D	
	90048-33029-000	4126.88	465 5782	4008.74D	
	90048-33047	410182.84D	4651 3506	3481.88D	
	90048-33056	410182.84D	4652 0219	6031.97D	
	90048-33078	410179.84D	4652 0785	410513.88D	
	90048-33083	410179.84D	4652 2664	3163.88D	
	90048-33088	410201.80D	4652 3118	3151.87D	
	90048-33092	410179.84D	4652 3733	3481.88D	
	90916-03040-000	3119.82	4652 5581	4246.80D	
	90916-03046-000	4103.82D	4653 6104	3164.88	
	90916-03090-000	3478.82D	4654 6375	410512.88D	
			467 4169	4008.74D	
			4673 7644	3151.87D	
DETROIT DIESEL	8929878	4619.86	4675 8586	410591.88D	
DEUTZ-FAHR	0117 2667	4094.71/1	4677 6216	3481.88D	
	0117 2668	4094.71/1	4677 6217	3163.88D	
	1227 0073	2393.75	4677 6218	3164.88	
	1227 0074	2391.75	4678 5392	410589.88D	
	1285 0152	4007.80D	4679 0294	410511.88D	
	1285 1663	4007.80D	4680 4764	410994.88D	

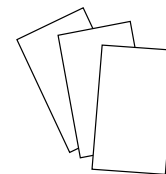

Hersteller Manufacturer Réf. Constructeur	Hersteller-Nr. Manufacturer's Ref. Réf. Constructeurs	Wahler-Nr Wahler-ref. Réf. Wahler	Hersteller Manufacturer Réf. Constructeur	Hersteller-Nr. Manufacturer's Ref. Réf. Constructeurs	Wahler-Nr Wahler-ref. Réf. Wahler
	4681 8413	3431.80D		762 5346	3431.80D
	470 3624	4008.74D		762 5347	3431.80D
	470 3625	4008.74D		762 6622	3361.87D
	475 0024	4008.79D		762 8417	3360.87D
	482 3226	4008.74D		762 8527	3355.80D
	482 6602	4151.76D		762 8799	6033.88
	5 0032 9622	4174.82D		765 5732	6035.92D
	50 415 0562	410081.79D		765 6384	3373.80D
	547 4546	6010.88D		765 6385	3373.80D
	5518 7784	410049.88D		765 6567	4022.82D1
	5519 3669	410090.88D		769 2450	3383.87
	5519 4029	410090.88D		769 6535	3383.87
	5519 4271	410048.88D		772 1399	4434.80D
	5519 9402	410588.88D		772 2107	3485.87D
	5520 2176	410090.88D		772 9959	410007.87D
	5520 2373	410048.88D		774 1883	3302.80D
	5520 2510	410049.88D		774 8867	6031.92D
	5520 3388	410049.88D		775 9596	3484.87D
	5521 5006	410871.80D ▲		777 0236	4436.80D
	5523 9819	410090.88D		777 0416	3301.80D
	592 1206	410692.71D		777 3790	410956.83D
	594 2240	3355.80D		779 1178	410516.88D
	595 0116	3159.82D		779 4132	3300.80D
	595 1985	6016.92		779 4218	410513.88D
	595 1987	6016.92		8242 0013	6031.92D
	595 8828	6033.88		8243 6410	6031.92D
	596 6787	3361.87D		8246 5533	6031.92D
	596 9749	3361.87D		8247 7919	6031.92D
	599 2746	6031.92D		907 0701	6031.92D
	6056 4101	6031.92D		9150 0723 80	3061.82
	6065 3946	410514.88D		9616 0901 80	4446.83D
	6080 8223	6031.92D		9616 0902 80	4450.83D
	6081 4382	410514.88D		9617 1780 80	3136.82D50
	708 3256	410520.92D ▲		9845 0800	3103.79
	7173 9800	4357.92D		9846 3637	4174.79D
	7174 2133	410229.82D		9849 8831	3116.82D
	7174 4389	4431.105D			
	7175 4778	410049.88D	FORD	0 801 587	4256.87D50
	7177 0832	4431.105D		1 001 993	4270.88D
	730 3174	4151.79D		1 002 788	4264.87D
	730 3615	4151.79D		1 007 754	4457.82D
	7350 2809	411193.82D		1 018 799	4123.80D
	754 0318	4022.82D1		1 031 881	4264.87D
	754 5958	3105.87D		1 032 249	4123.80D
	755 4544	3383.87		1 086 282	410131.88D ▲
	756 4583	3159.82D		1 096 283	3497.88D
	757 0837	6031.97D		1 096 699	4264.87D
	757 6281	6040.88		1 211 553	4457.82D
	758 1200	3109.87D		1 303 374	4457.82D
	758 1201	3109.87D		1 306 004	4483.82D
	758 9135	3105.87D		1 345 512	4825.98D
	7581 635	3109.82D		1 351 716	4825.98D
	759 7659	3431.80D		1 452 357	3004.88D1
	759 9824	3431.80D		1 472 378	3004.92D1
	761 3433	3378.80		1 473 089	410016.98D
	761 5234	3159.82D		1 473 090	410016.98D
	761 5235	3159.82D		1 497 689	3021.88D50

Vergleichsliste | Cross References

Hersteller Manufacturer Réf. Constructeur	Hersteller-Nr. Manufacturer's Ref. Réf. Constructeurs	Wahler-Nr Wahler-ref. Réf. Wahler	Hersteller Manufacturer Réf. Constructeur	Hersteller-Nr. Manufacturer's Ref. Réf. Constructeurs	Wahler-Nr Wahler-ref. Réf. Wahler
FORD	1 509 953	3021.88D50	GM	800 572	3021.88D50
	1 517 858	3021.88D50		800 573	3021.88D50
	1 518 627	3004.74		800 574	3021.88D50
	1 520 969	3021.88D50		81SF 8575 EA	3021.88D50
	1 607 993	3004.74		81SF 8575 FA	3021.88D50
	1 612 191	4147.80D		84FF 8575 BA	4256.87D50
	1 635 905	3021.88D50		85HF 8575 AA	3021.88D50
	1 649 194	3021.88		891F 8575 AA	3004.88D1
	1 663 819	4270.88D		89BM 8575 AC	3004.92D1
	1 712 228	4483.82D		89BM 8575 AD	3004.92D1
	3 257 449	3119.88		89FF 8575 AA	4270.88D
	3 396 924	4639.82D		89FF 8575 AB	410131.88D
	3 599 763	4639.82D		89TM 8575 AA	4270.88D
	3 893 570	4639.82D		91XM 8575 AA	3021.88D50
	3 902 514	4639.82D		928M 8575 AE	4270.88D
	4 176 181	4639.82D		948M 8575 AA	4270.88D
	4 188 498	4639.82D		95VW 8575 AB	4264.87D
	4 356 548	3100.92D ▲		95VW 8575 AC	4264.87D
	4M5G 6L721 GA	4825.98D		95VW 8B607GA	6037.95D
	4M5G 6L721 GB	4825.98D		95WM 8575 AA	3100.88D
	4M5G 8575 ZA	4483.82D		96MM 8575 A1A	4457.82D
	4M5G 8575 ZB	4483.82D		96MM 8575 BD	4457.82D
	5 004 887	3021.88D50		96MM 8575 BE	4457.82D
	5 004 890	3004.92D1		F42Z 8575 BA	4639.82D
	5 004 891	3004.92D1		KL01 15 171 A	4639.82D
	6 058 444	4256.92D50		XM34 8575 AA	4639.82D
	6 058 784	3053.75		XM34 8575 AB	4639.82D
	6 072 016	6010.95D		XS7Q 8575 AA	3497.88D
	6 077 895	6010.95D		YU3E 8575 BA	3100.92D
	6 077 896	6010.95D			
	6 077 897	6010.95D		02 898 440	3054.92D50
	6 077 898	6010.95D		02 898 688	3054.87D50
	6 077 985	6010.95D		08 966 483	4255.82D
	6 085 917	3021.88D50		08 966 485	4255.87D
	6 085 918	3021.88D50		12 615 097	411193.82D
	6 100 372	4256.87D50		12 622 410	411193.82D
	6 100 629	3021.92D50		12 992 692	4459.92D
	6 100 630	3021.88D50		21 018 811	411193.82D
	6 106 381	4256.87D50		24 405 922	4431.105D
	6 124 378	4256.87D50		24 420 652	4175.92D
	6 144 361	6010.88D		24 420 728	4297.92D
	6 153 501	4270.88D		24 435 781	4201.92D
	6 169 774	410131.88D		24 447 862	4433.92D
	6 176 366	4256.87D50		24 456 401	411578.92D ▲
	6 182 480	4147.80D		55 182 499	410588.88D
	6 201 207	3021.88D50		55 202 510	410049.88D
	6 201 247	3021.88D50		55 577 072	4431.105D
6 526 879	3004.92D1	9 108 106	4151.76D		
6 588 962	4270.88D	9 110 719	3470.89D50		
6 758 566	3100.92D	9 112 305	410517.89D		
6 866 389	4270.88D	9 128 786	4207.92D		
6 994 257	3100.88D	9 129 907	4242.92D		
691F 8575 BA	3004.92D1	9 161 123	4174.79D		
7 072 643	4158.80D	9 543 786	4193.92D		
7 215 818	6037.95D	90 009 956	4115.92D		
7S7G 6L721 AA	410016.98D	90 067 918	4255.92D		
7S7G 6L721 AB	410016.98D	90 108 636	6010.95D		

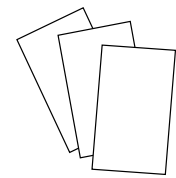

Hersteller Manufacturer Réf. Constructeur	Hersteller-Nr. Manufacturer's Ref. Réf. Constructeurs	Wahler-Nr Wahler-ref. Réf. Wahler	Hersteller Manufacturer Réf. Constructeur	Hersteller-Nr. Manufacturer's Ref. Réf. Constructeurs	Wahler-Nr Wahler-ref. Réf. Wahler
	90 156 558	4115.92D			
	90 200 836	3017.92D2	HOLDER	111 727	3000.83
	90 220 435	4164.92D		HD 035 A01	3000.83
	90 232 012	4144.92D			
	90 242 277	6031.100D	HONDA	19300-P08-014	410224.78D
	90 277 288	6031.105D		19300-PA0-003	3119.82
	90 352 677	4168.92D		19300-PB2-003	3119.82
	90 354 822	4164.92D		19300-PB2-004	3119.82
	90 357 303	6031.88D		19300-PB2-013	3119.82
	90 410 665	4144.82D		19300-PB2-014	3119.82
	90 410 897	4175.92D		19300-PB2-024	3119.82
	90 411 948	4177.92D		19300-PB2-811	3119.82
	90 412 901	4178.92D		19300-PB2-812	3119.82
	90 443 472	4164.92D		19300-PB2-815	3119.82
	90 443 473	4144.82D		19300-PB2-816	3119.82
	90 486 128	4180.82D		19300-PB2-817	3119.82
	90 501 081	4183.92D		19300-PDA-E01	410224.78D
	90 501 699	4183.82D		19300-PE0-013	4269.78D
	90 502 201	4175.92D		19300-PE0-024	4269.78D
	90 509 110	4237.80D		19300-PJ7-003	410224.78D
	90 529 846	4188.92D		19300-PJ7-004	410224.78D
	90 536 262	411578.92D ▲		19300-PLZ-004	4269.78D
	90 536 501	411578.92D ▲		19300-PM3-003	410224.78D
	90 537 453	411193.82D		19300-PM3-004	410224.78D
	90 537 605	411193.82D		19300-PR3-003	410224.78D
	90 537 811	411193.82D		19300-PT0-003	410224.78D
	90 570 620	4459.92D		19300-PT0-004	410224.78D
	90 572 899	4198.92D		19301-P07-306	410224.82D
	90 573 326	4208.92D		19301-P07-316	410224.82D
	90 573 926	4201.92D		19301-P08-000	410224.78D
	91 153 670	4158.80D		19301-P08-305	410224.78D
	91 159 950	3466.89D		19301-P08-306	410224.78D
	91 160 168	410517.83D		19301-P08-315	410224.78D
	91 160 216	126104 ▲		19301-P08-316	410224.78D
	9158251	411579.92D ▲		19301-P10-307	410224.78D
	92 063 300	4177.92D		19301-P1K-307	410224.78D
	92 063 300	4194.92D		19301-PAA-305	410224.78D
	93 177 343	410588.88D		19301-PAA-306	410224.78D
	93 179 136	410049.88D		19301-PDF-305	410224.78D
	93 181 245	411578.92D ▲		19301-PLC-305	410224.78D
	93 19 3581	410588.88D		19301-PLC-315	410224.78D
	93 198 017	410517.83D		19301-PNA-003	410225.78D
	93 198 035	411476.83D ▲		19301-PWA-305	410224.82D
	93 198 289	411476.83D ▲		19301-PZA-305	410224.82D
	93 198 317	411476.83D ▲		19301-RAF-003	410226.78D
	93 198 576	411476.83D ▲		19301-RAF-004	410226.78D
	93 198 646	411476.83D ▲		19301-REA-305	410224.78D
	93 275 736	410520.92D ▲		19301-RME-305	410224.78D
	94 372 762	3468.88D		19301-RNA-305	410224.82D
	94 580 182	410183.82D		19301-RNA-306	410224.82D
	96 610 574	410183.88D		19301-RNA-307	410224.82D
	97 087 130	3467.85D		19301-RP3-305	410224.78D
	97 094 283	3004.82			
			HYUNDAI		
HAKO	69015347	4264.87D		25500-22600	410351.88D
				25500-23001	410348.82D
HOLDEN	92 063 300	4177.92D		25511-29000	4446.83D

Vergleichsliste | Cross References

Hersteller Manufacturer Réf. Constructeur	Hersteller-Nr. Manufacturer's Ref. Réf. Constructeurs	Wahler-Nr Wahler-ref. Réf. Wahler	Hersteller Manufacturer Réf. Constructeur	Hersteller-Nr. Manufacturer's Ref. Réf. Constructeurs	Wahler-Nr Wahler-ref. Réf. Wahler
INNOCENTI	34 402 115	3004.82		9843 2310	4166.79D
	65 540 40601	3044.80		9843 3497	4165.79D
INTER. HARV. IHC	3059 676 R 1	4017.82		9846 3637	4174.79D
	3059 676 R 91	4017.82		9846 7516	4166.79D
	3059 676 R 92	4017.82		9846 7517	4163.79D
	3228 046 R 2	4017.82		9849 2868	4163.74D
	3228 046 R1	4017.82		9849 2873	4163.74D
	84247900	6010.75D		9849 8322	4622.82D0
				9849 8322 Kit	410763.82D
ISUZU	5-86000-349-0	410224.78D		9943 1512	4619.86
	5-86000-350-0	410224.78D	JAGUAR	C28067	4006.82D
	5-86008138	410224.82D		C33012	4006.82D
	5-86012-056	410224.78D		C37129	4006.82D
	5-86014-381-0	410224.78D	JEEP	04494469	3000.90
	5-86018-963	410224.78D		5175583AB	4630.87D ▲
	5-86018-964-0	410224.78D		52028185AB	3000.90
	5-86019-507-0	410224.78D		T 069 7157	4147.80D
	5-86019-513-0	410224.78D			
	8-79312-726-0	3467.85D	JOHN DEERE	AT 22961	3000.83
	8-94123-295-0	3468.88D		AT 22963	3000.90
	8-94123-295-1	3468.88D		RE 33705	3000.90
	8-94360-227-0	3467.85D			
	8-94372-762-0	3468.88D	KIA	OK2A-15-171	410352.82D
	8-97087-130-2	3467.85D		OK2C0-15-171A	410352.88D
	94 207 217	3004.82		OK710-15-171	3498.88D
	94 214 962	4022.82D		OK9FC-15-171	3498.88D
IVECO	413 8769	3000.83		KE5D3-15-171	3498.88D
	468 4390	4008.79D		KHE41-15-171	410352.82D
	470 3088	4008.79D	KOMATSU	2871 591 M	4520.80D
	471 6264	4152.79D		2872 578 M	4530.80
	473 8169	4165.79D			
	474 9724	4105.75D	LADA	21080-13060-10	3333.87
	477 0246	4174.79D		2108-13060-10	3333.87
	480 4321	4166.79D		21081-3060-11	3333.87
	480 7492	4152.79D		21215-13060-15	4446.83D
	482 3211	4174.79D			
	483 1783	4152.79D	LANCIA	4652 0785	410513.88D
	483 7166	4174.79D		4652 2664	3163.88D
	50 032 9622	4174.82D		4654 6375	410512.88D
	50 401 7209	3171.82D		4679 0294	410511.88D
	50 404 5799	3169.79D		599 9818	3431.80D
	50 408 4365	3169.79D		754 0318	4022.82D1
	50 409 6443	4619.86		758 1201	3109.82D
	50 409 6443 Kit	410608.86D		758 1636	3109.82D
	50 413 2246	410075.79D ▲		758 9135	3105.87D
	50 415 0562	410081.79D		779 4218	410513.88D
	50 425 8346	410289.81D		7910247116	4122.87D
	50 432 0545	410289.81D		8234 2688	3356.80D
	50 438 7382	410937.82D ▲		9616 0901 80	4446.83D
6131 6592	4162.79D				
6131 8373	4162.79D	LANDROVER	GTS 303	4147.80D	
730 3615	4151.79D		RTC 6673	4158.80D	
809 6735	4174.79D				
9842 0718	4163.79D	LEXUS	90916-03079	411545.82D ▲	
9842 4854	4165.79D		90916-03081	411545.82D ▲	

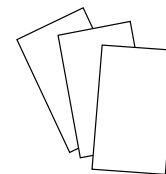

Hersteller Manufacturer Réf. Constructeur	Hersteller-Nr. Manufacturer's Ref. Réf. Constructeurs	Wahler-Nr Wahler-ref. Réf. Wahler	Hersteller Manufacturer Réf. Constructeur	Hersteller-Nr. Manufacturer's Ref. Réf. Constructeurs	Wahler-Nr Wahler-ref. Réf. Wahler		
LIEBHERR	90916-03144	4480.82D		8173-99-152 A	3499.88D		
	90916-03145	4480.82D		8173-99-152 B	3119.88D3		
				8173-99-152 B	3499.88D		
	738 0513	4530.80		8AB1-15-171	3498.88D		
	738 0833	4083.79 ▲		8AB3 15 171	4006.82D		
LOMBARDINI				8AB5-15-171	3498.88D		
	1000208309	4007.80D		8AB7-15-171	3499.82D		
	104 9195 092	4008.79D		8AB8-15-171	3498.88D		
	9195 057	4007.80D		8AB9-15-171	3499.82D		
	9195 1240	4007.80D		8ABA-15-171	3499.88D		
	ED0091951240S	4007.80D		8ABB-15-171	3499.88D		
MACK				8ABB-15-171A	3499.88D		
	657 GC 324 A-P80	411045.82D		8ABC-15-171	3499.82D		
MAN				8ABD-15-171	3499.88D		
	51.06402.0034	4150.79D50		8ABE-15-171	3498.88D		
	51.06402.0042	4150.71D50		8AG1-15-171	3468.88D		
	51.06402.0043	4150.79D50		8AG1-15-171A	3468.88D		
	51.06402.0044	4150.79D50		8AG2-15-171	3468.88D		
	51.06402.0049	4150.79D50		8AG2-15-171A	3468.88D		
	51.06402.0050	4150.79D50		8AG3-15-171	3498.88D		
	51.06402.0051	4150.79D50		8AG4-15-171	3119.88D3		
	51.06402.0052	4150.71D50		8AG4-15-171	3499.88D		
	51.06402.0053	4150.79D50		8AG5-15-171	3498.88D		
	51.06402.0056	4150.79D50		8AG6-15-171	3468.88D		
	51.06402.0057	4150.71D50		8AG7-15-171	3468.88D		
	51.06402.0058	4150.83D50		8AG8-15-171	3468.88D		
	51.06402.0060	4150.83D50		8AGX-15-171	4639.82D		
	51.06402.0061	4150.79D50		8AK1-15-171	3498.88D		
	51.06402.0062	4150.71D50		8AN1-15-171	3498.88D		
	51.06402.0063	4150.83D50		8AU1-15-171	3498.88D		
	51.06402.0064	4150.79D50		8AU-15-171	3498.88D		
	51.06402.0065	4150.71D50		8AX1-15-171	3119.88D3		
	51.06402.0066	4150.83D50		8AX1-15-171	3499.88D		
	51.06402.0067	4150.79D50		8AZ1-15-171	3468.88D		
	51.06402.0068	4150.71D50		AB6-15-171	3498.88D		
	51.06402.0069	4150.79D50		B366-15-171	3499.82D		
	81.06401.0019	410864.71D0		B3H3-15-171	3499.82D		
	81.06401.0037	410864.79D0		B3H8-15-171A	3499.82D		
	81.06401.0038	410864.83D0		B541-15-171	3119.88D3		
	81.06401.0042	410864.71D0		B541-15-171	3499.88D		
	81.06401.0045	410864.83D0		B6H-15-171	3498.88D		
	81.06401.0046	410864.79D0		B6H-15-171 A	3498.88D		
	81.06401.6002	4373.70 ▲		BP6F-15-171	3498.88D		
	MAZDA					BPD3-15-171	3498.88D
		0223-15-171		3499.82D		E5D3-15-171	3498.88D
		0419-15-171		3499.82D		F201-15-171	3498.88D
0419-99-152		3499.82D	FS05-15-171	4639.82D			
1A51-15-171		4639.82D	HE 41-99-152 A	3119.88D3			
1E03-15-171		3004.92D1	HE 41-99-152 C	3119.82D3			
1E05-15-171 A		4457.82D	HE 41-99-152C	3499.82D			
1E07-15-171		410131.88D	HE 41-99-152D	3499.82D			
1E07-15-171 A		410131.88D	KL01-15-171	4639.82D			
8124-99-152		3119.82	KL01-15-171 A	4639.82D			
8173-15-152 C		3499.88D	RF03-15-171A	3468.88D			
8173-15-171		3499.88D	ZZ40-15-171	3498.88D			
8173-99-152		3499.88D					
8173-99-152 A		3119.88D3					
			MERCEDES-BENZ	000 203 64 75		3000.80	

Vergleichsliste | Cross References

Hersteller Manufacturer Réf. Constructeur	Hersteller-Nr. Manufacturer's Ref. Réf. Constructeurs	Wahler-Nr Wahler-ref. Réf. Wahler	Hersteller Manufacturer Réf. Constructeur	Hersteller-Nr. Manufacturer's Ref. Réf. Constructeurs	Wahler-Nr Wahler-ref. Réf. Wahler
MERCEDES-BENZ	001 203 58 75	3000.80		005 203 59 75	4472.83D
	001 203 69 75	4083.83D50		100 200 05 15	4078.87D
	001 203 90 75	4078.79D		100 200 07 15	4078.79D
	001 203 91 75	4078.87D		102 200 08 15	4078.87D
	002 203 04 75	4083.83D50		102 200 14 15	4078.87D
	002 203 16 75	4078.71D		102 200 15 15	4078.87D
	002 203 31 75	4078.71D		102 200 19 15	4078.87D
	002 203 32 75	4105.83D		110 200 01 11	4078.87D
	002 203 35 75	4078.79D		110 200 05 15	4078.87D
	002 203 37 75	4078.79D		110 200 09 15	4078.71D
	002 203 38 75	4078.79D		110 200 19 15	4078.92D
	002 203 39 75	4105.71D		111 200 03 15	4276.87D
	002 203 45 75	4105.83D		111 200 08 15	4279.87D
	002 203 46 75	4078.79D		111 200 09 15	4275.87D
	002 203 47 75	4105.83D		111 200 17 15	4414.87D
	002 203 49 75	4105.83D		111 203 02 75	4275.87D
	002 203 53 75	4083.83D50		111 203 03 75	4276.87D
	002 203 56 75	4105.83D		111 203 05 75	4279.87D
	002 203 59 75	4105.83D		111 203 06 75	4275.87D
	002 203 72 75	4078.79D		111 203 08 75	4275.87D
	002 203 75 75	4117.80D		111 203 10 75	4414.87D
	002 203 76 75	4078.87D		112 200 00 15	4281.87D
	002 203 78 75	4078.79D		112 200 01 15	4298.87D
	002 203 79 75	4105.83D		112 203 02 75	4281.87D
	002 203 80 75	4117.80D		112 203 03 75	4298.87D
	002 203 81 75	4078.87D		116 200 00 15	4064.75D
	002 203 82 75	4064.75D		116 200 02 15	4233.84D
	002 203 90 75	4105.83D		116 200 03 15	4137.80D
	003 203 14 75	4105.83D		119 200 00 15	4278.80D
	003 203 22 75	3000.80		119 203 01 75	4278.80D
	003 203 28 75	4105.83D		120 200 00 15	4517.87D
	003 203 29 75	4105.71D		120 203 02 75	4517.87D
	003 203 31 75	4105.83D		160 200 03 15	3142.90D
	003 203 32 75	4105.71D		166 203 00 75	411576.87D ▲
	003 203 73 75	4105.83D		166 203 01 75	411576.87D ▲
	003 203 74 75	4105.71D		166 203 02 75	411576.87D ▲
	003 203 78 75	4105.83D		266 203 02 75	411577.80D ▲
	003 203 79 75	4105.71D		266 203 04 75	411577.80D ▲
	003 203 82 75	4233.84D		266 203 06 75	411577.80D ▲
	003 203 91 75	4105.79D		271 200 00 15	3457.90D
	003 203 92 75	4105.79D		271 200 01 15	410389.103D ▲
	003 203 98 75	4176.80D		271 200 02 15	410389.103D ▲
	004 203 09 75	4176.85D		271 200 03 15	410389.103D ▲
	004 203 39 75	4137.80D		271 203 03 75	3457.90D
	004 203 40 75	4137.80D		272 200 00 15	4834.100D
	004 203 65 75	4078.65D		272 200 01 15	4834.100D
	004 203 83 75	4105.83D		272 200 04 15	4834.100D
	004 203 84 75	4105.71D		272 200 05 15	4833.100D
	004 203 85 75	4105.79D		272 200 06 15	4829.100D ▲
	004 203 86 75	4078.92D		273 200 01 15	4829.100D ▲
005 203 17 75	4619.75		273 200 02 15	4833.100D	
005 203 18 75	4619.80		273 200 04 15	4829.100D ▲	
005 203 19 75	4619.86		373 203 70 75	4105.83D	
005 203 26 75	4105.83D		601 200 00 15	4176.85D	
005 203 27 75	4105.79D		601 200 01 15	4176.80D	
005 203 28 75	4105.71D		602 200 00 15	4176.80D	
005 203 29 75	4123.80D		603 200 00 15	4176.80D	

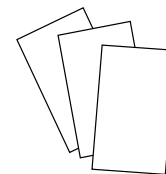

Hersteller Manufacturer Réf. Constructeur	Hersteller-Nr. Manufacturer's Ref. Réf. Constructeurs	Wahler-Nr Wahler-ref. Réf. Wahler	Hersteller Manufacturer Réf. Constructeur	Hersteller-Nr. Manufacturer's Ref. Réf. Constructeurs	Wahler-Nr Wahler-ref. Réf. Wahler
	603 203 04 74	4280.80D		MD 345617	4637.76D
	603 203 04 74	4280.85D		MD 348937	410180.82D
	604 203 00 75	4280.85D		MD 351495	410180.82D
	605 203 00 75	4280.80D		MD 360320	4637.82D
	606 203 01 75	4176.80D		MD 972903	3119.88D4
	606 203 02 75	4176.85D		MD 972905	3119.82D4
	606 203 05 75	4176.85D		MD 972908	3119.82D4
	607 200 00 15	3004.82		MD 997217	3119.82D4
	611 200 02 15	410171.87D		MD 997219	3119.82D4
	611 200 07 15	410171.87D		MD 997220	3119.82D4
	611 203 04 75	410171.87D		MD 997221	3119.88
	611 203 05 75	410171.87D		MD 997221	3119.88D4
	611 203 15 75	410171.87D		MD 997224	4638.82D
	611 203 19 75	410171.87D		MD 997461	3119.88D4
	615 200 13 15	4117.80D		MD 997602	3119.82D4
	616 200 04 15	4117.80D		MD 997603	3119.82D4
	617 200 03 15	4049.80D		MD 997605	4638.76D
	617 200 11 15	4049.80D		MD 997606	4638.82D
	617 200 18 15	4049.80D1		MD 997607	3119.82D4
	628 203 01 75	4309.92D		MD 997608	3119.88D4
	642 200 02 15	4490.87D		MD 997644	410180.82D
	642 200 02 15	4835.87D		ME 190303	4637.76D
	642 200 03 15	4630.87D ▲		ME 191593	4637.76D
	642 200 04 15	4835.87D		ME 200262	4637.76D
	642 200 07 15	4832.87D ▲		ME 220538	410180.82D
	642 200 08 15	410055.87D ▲		ME 241816	410180.82D
	642 200 20 15	4490.87D		ME 999295	4638.82D
	646 200 00 15	410174.92D		MN 980137	3472.87D
	646 200 11 15	410174.92D			
	646 200 12 15	410171.87D	MULTICAR	0820117806	4176.85D
	646 203 02 75	410174.92D		4008540	4264.87D
	660 200 03 15	3146.90D			
			MWM	1215 2752	2391.75
				1215 2766	2391.75
mitsubishi	M-474877	3470.89D50		6 052 5 010 005 0	4520.75
	M-863985	3470.89D50		6 052 5 011 001 1	2391.75
	MD 001370	3119.82D4		6 052 5 011 002 4	2393.75
	MD 005131	3119.88D4		6 052 5 011 004 2	2391.75
	MD 005371	3119.82D4		6 052 5 100 41	2393.75
	MD 008086	3119.82D4		9 225 0 757 014 6	4351.79
	MD 015299	4638.82D		9 229 8 757 004 6	4588.75/1
	MD 075460	3119.82D4		9 407 0 757 002 4	3145.79D
	MD 094120	4638.82D			
	MD 117759	3119.82D4	NEOPLAN	0303.191.04	4520.80D
	MD 126168	3119.82D4			
	MD 158570	4637.82D	NISSAN	11060-00Q0C	411475.89D ▲
	MD 164541	4637.76D		11060-00Q0E	411475.89D ▲
	MD 165630	4637.82D		11060-00Q0K	411442.83D ▲
	MD 170031	4637.76D		11060-00Q0S	411442.83D ▲
	MD 174233	410180.82D		11060-00QAF	410538.89D
	MD 175746	4637.82D		11060-00QAJ	411040.83D
	MD 194988	410180.82D		11060-00QAL	411475.89D ▲
	MD 310106	4637.82D		11060-AW300	410517.89D
	MD 315301	4637.82D		11060-BN700	411043.89D
	MD 317015	4637.76D		11061-00Q0A	411476.83D ▲
	MD 335170	4637.82D		11061-00Q0B	411476.83D ▲
	MD 337408	4637.82D		11061-00Q0D	411039.83D
	MD 338234	4637.82D			

Vergleichsliste | Cross References

Hersteller Manufacturer Réf. Constructeur	Hersteller-Nr. Manufacturer's Ref. Réf. Constructeurs	Wahler-Nr Wahler-ref. Réf. Wahler	Hersteller Manufacturer Réf. Constructeur	Hersteller-Nr. Manufacturer's Ref. Réf. Constructeurs	Wahler-Nr Wahler-ref. Réf. Wahler
NISSAN	11061-00Q0E	411043.89D		13 38 003	4242.92D
	11061-00Q0G	411476.83D ▲		13 38 007	411193.82D
	11061-00Q0K	411476.83D ▲		13 38 008	411193.82D
	11061-00Q0L	411476.83D ▲		13 38 009	4201.92D
	11061-00Q1B	411476.83D ▲		13 38 015	4297.92D
	11061-00QAB	410517.83D		13 38 015 old number	3017.92D50
	11061-00QAC	410517.83D		13 38 016	3054.92D50
	11061-00QAD	410517.89D		13 38 017	4433.92D
	11061-00QAE	3166.89D		13 38 018	3054.87D50
	11061-00QAG	411043.89D		13 38 020	410048.88D
	11061-00QAL	411043.89D		13 38 024	4255.82D
	11061-00QAM	411039.83D		13 38 030	3004.82
	21200-01B00	3044.90D1		13 38 033	4255.87D
	21200-2H600	3118.82D1		13 38 034	411193.82D
	21200-2H605	3118.88D1		13 38 038	4255.92D
	21200-41B00	3118.82D1		13 38 039	410049.88D
	21200-4M500	3478.82D		13 38 041	3054.87D50
	21200-57J00	410176.82D0		13 38 042	3021.88D50
	21200-57J05	410176.88D0		13 38 046	4115.92D
	21200-57J15	410176.82D0		13 38 049	4144.92D
	21200-6F900	4821.89D		13 38 050	4164.92D
	21200-6F901	4821.89D		13 38 052	3017.92D2
	21200-77A00	4634.76		13 38 054	4144.92D
	21200-77A05	3478.82D		13 38 056	3468.88D
	21200-77A60	4634.76		13 38 057	4164.92D
	21200-77A61	4634.76		13 38 059	4144.82D
	21200-77A63	4634.76		13 38 060	4168.92D
	21200-77A65	3478.82D		13 38 062	4144.82D
	21200-77A66	3478.82D		13 38 063	4164.92D
	21200-78515	3118.88D1		13 38 067	4175.92D
	21200-85G00	3118.82D1		13 38 068	4177.92D
	21200-85G05	3118.88D1		13 38 069	4180.82D
	21200-85G06	3118.88D1		13 38 073	4178.92D
	21200-86J00	3478.82D		13 38 075	3467.85D
	21200-86J01	3478.82D		13 38 076	4237.80D
	21200-90J00	3478.82D		13 38 077	3004.82
	21200-90J10	3478.82D		13 38 079	4183.92D
	21200-99B03	3118.82D1		13 38 080	4183.82D
	21200-9F600	3478.82D		13 38 084	4175.92D
	21200-BX000	410488.88D		13 38 087	4188.92D
	21200-ED000	411241.82D		13 38 096	4459.92D
	21200-ED00A	411241.82D		13 38 097	4201.92D
	21200-G3100	3000.83		13 38 100	4198.92D
	21200-P7500	3118.88D1		13 38 154	410049.88D
	21200-P7901	3118.82D1		13 38 178	4431.105D
	21200-P7905	3118.88D1		13 38 275	410049.88D
	21200-P7906	3118.88D1		13 38 331	4208.92D
21200-P7990	3118.82D1		13 38 427	411193.82D	
21200-P7991	3118.88D1		13 38 466	4158.80D	
21200-V0100	3118.82D1		13 38 478	4194.92D	
21200-V0105	3118.88D1		13 41 002	6010.95D	
21200-V0200	3118.82D1		13 41 011	6031.100D	
21200-V0201	3118.82D1		13 41 017	6031.105D	
21200-V0205	3118.88D1		13 41 028	6031.88D	
21200-V0206	3118.88D1		1338 001	411578.92D ▲	
			1338 004	411579.92D ▲	
			1338 098	411578.92D ▲	
OPEL	13 38 002	4207.92D			

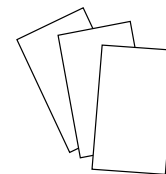

Hersteller Manufacturer Réf. Constructeur	Hersteller-Nr. Manufacturer's Ref. Réf. Constructeurs	Wahler-Nr Wahler-ref. Réf. Wahler	Hersteller Manufacturer Réf. Constructeur	Hersteller-Nr. Manufacturer's Ref. Réf. Constructeurs	Wahler-Nr Wahler-ref. Réf. Wahler
	44 00 106	4151.76D		1338 13	4447.85D
	44 02 719	3470.89D50		1338 19	4447.80D
	44 04 305	410517.89D		1338 20	4147.80D
	44 08 334	3466.89D		1338 21	4821.89D
	44 08 928	410517.83D		1338 23	4446.83D
	44 09 180	126104 ▲		1338 25	4147.80D
	44 32 983	410517.83D		1338 26	4450.89D
	44 33 121	411476.83D ▲		1338 37	3136.82D50
	44 34 144	411476.83D ▲		1338 38	410058.84D
	44 34 190	411476.83D ▲		1338 39	4450.83D
	44 49 134	411476.83D ▲		1338 44	3136.88D50
	44 49 506	411476.83D ▲		1338 71	4447.85D
	45 00 823	4174.79D		1338 72	4447.80D
	47 08 757	410588.88D		1338 83	3136.82D50
	48 11 586	4189.87D		1338 90	4174.82D
	63 38 004	4428.92D		1338 A0	3483.89D
	63 38 018	4431.105D		1338 C8	4821.89D
	63 38 022	410588.88D		1338 F5	3497.88D
	63 38 028	4459.92D		5474546	6010.88D
	63 38 039	410048.88D		79 100 118 73	3053.75
	63 38 050	4357.92D		79 102 461 13	4122.87D
	6338 005	411578.92D ▲		79 102 471 16	4122.87D
	6338 035	411578.92D ▲		91 500 723 80	3061.82
	93 18 4200	410048.88D		91 500 724 80	3061.88
				96 057 087 80	3136.88D50
PACCAR	129 3885 / F75-85-95	411133.80D		96 057 136 80	3136.88D50
	166 1375 / CF 75	411135.87D		96 090 230 80	4147.80D
	168 4900 / CF 75	411135.83D		96 108 092 80	4450.89D
				96 108 093 80	4450.89D
PEGASO	222730	4619.75		96 160 902 80	4450.83D
	770275	4078.75D		96 196 379 80	3136.88D50
	770662	4619.75		96 272 785 80	4447.80D
				96 272 814 80	4447.85D
PERKINS	7483490	3000.75		96 300 666 80	3483.89D
	PF 52.842	3000.80		96 300 667 80	3463.89D
				96 472 659 80	410705.89D
PEUGEOT	1264 32	6031.92D		964485 426 80	410184.89D
	1264 33	6035.92D			
	1264 50	6031.88D	PORSCHE	928.106.129.06	4161.83
	1264 50	6031.92D		928.106.129.16	4161.83
	1336 A7	3431.80D		928.106.129.17	4161.83
	1336 AA	410075.79D ▲		944.106.019.00	4256.83D60
	1336 N5	3463.89D		944.106.129.05	4256.80D60
	1336 Q1	3463.89D		944.106.129.05	4256.83D60
	1336 Q2	410184.89D		944.606.481.00	6010.92D
	1336 Z0	410705.89D		955.106.113.00	4455.80D
	1337 26	3053.75		996.106.013.54	4249.83D
	1337 27	3136.88D50		996.106.013.55	4249.83D
	1337 30	3136.82D50		996.106.013.56	4249.83D
	1337 34	4122.87D		996.106.013.57	4249.83D
	1337 47	3061.82		996.106.121.53	4249.83D
	1337 48	3159.82D		996.106.125.52	4249.83D
	1337 49	3061.88			
	1337 64	4147.80D	RENAULT	00 24 774 033	4529.70
	1337 65	3033.84D ▲		11 06 023 09R	411477.89D ▲
	1337 68	4147.80D		11 06 030 26R	411442.83D ▲
	1338 11	3136.88D50		11 06 055 36R	411442.83D ▲

Vergleichsliste | Cross References

Hersteller Manufacturer Réf. Constructeur	Hersteller-Nr. Manufacturer's Ref. Réf. Constructeurs	Wahler-Nr Wahler-ref. Réf. Wahler	Hersteller Manufacturer Réf. Constructeur	Hersteller-Nr. Manufacturer's Ref. Réf. Constructeurs	Wahler-Nr Wahler-ref. Réf. Wahler
RENAULT	50 00 684 865	410828.82D0		77 01 348 373	3470.89D50
	50 00 684 865 Kit	410828.82D		77 01 348 374	3029.86
	50 00 691 267	410828.86D0		77 01 348 376	3029.83
	50 00 691 267 Kit	410828.86D		77 01 349 173	4122.87D
	50 00 694 785	4529.83D0		77 01 349 415	4122.87D
	50 00 816 924	4151.76D		77 01 474 248	410518.89D
	50 01 855 520	4619.82		77 01 474 249	410530.89D
	50 10 284 184	411045.82D		82 00 039 885	411043.89D
	50 10 295 225	4596.83D		82 00 074 346	410517.89D
	50 10 295 225 2x Kit	410758.83D		82 00 074 349	410517.83D
	50 10 447 161	4619.86		82 00 112 054	410538.89D
	50 10 553 100	4619.86		82 00 171 021	411043.89D
	60 01 543 366	3466.89D		82 00 244 023	411039.83D
	60 05 000 004	2391.75		82 00 244 402	411043.89D
	60 05 004 616	2391.75		82 00 248 531	411477.89D ▲
	60 05 004 616	2393.75		82 00 267 349	411042.89D
	74 31 397 947	4272.90D		82 00 374 994	411043.89D
	74 36 842 409	4272.90D		82 00 380 898	411475.89D ▲
	74 39 180 811	4272.90D		82 00 400 553	411040.83D
	77 00 024 756	2389.75/1		82 00 400 554	411039.83D
	77 00 024 756	2391.75		82 00 403 437	411476.83D ▲
	77 00 101 179	126104 ▲		82 00 558 751	411040.83D
	77 00 109 641	410530.89D		82 00 558 758	411039.83D
	77 00 110 716	3166.89D		82 00 558 766	411042.89D
	77 00 112 491	410518.89D		82 00 558 779	411477.89D ▲
	77 00 260 959	4449.84D		82 00 558 783	411043.89D
	77 00 575 874	3029.83		82 00 561 420	126104 ▲
	77 00 619 931	3029.86		82 00 656 419	411475.89D ▲
	77 00 657 955	4122.87D		82 00 656 420	411475.89D ▲
	77 00 665 226	4147.80D		82 00 660 882	3166.89D
	77 00 697 157	4147.80D		82 00 674 368	410517.89D
	77 00 703 136	4122.87D		82 00 674 369	410517.83D
	77 00 710 657	4122.87D		82 00 699 392	411475.89D ▲
	77 00 722 762	3029.86		82 00 703 139	411475.89D ▲
	77 00 723 945	3470.89D50		82 00 703 140	411476.83D ▲
	77 00 727 190	3029.89		82 00 772 985	3466.89D
	77 00 730 540	3029.89		82 00 801 567	411476.83D ▲
	77 00 742 617	3469.91D		82 00 801 570	411475.89D ▲
	77 00 858 087	4147.80D		82 00 801 571	411475.89D ▲
	77 00 858 802	3469.91D		82 00 907 229	411475.89D ▲
	77 00 862 200	4147.80D		82 00 907 234	411475.89D ▲
	77 00 866 387	126104 ▲		82 00 907 239	411476.83D ▲
	77 00 866 896	3470.89D50		82 00 907 243	411476.83D ▲
	77 00 868 274	4446.83D		82 00 954 285	411043.89D
	77 00 868 980	3174.89D		82 00 954 288	411039.83D
	77 00 872 314	3470.89D50		82 00 954 289	411481.89D ▲
	77 00 872 554	3466.89D		82 00 954 328	411442.83D ▲
77 00 872 635	3466.89D				
77 01 026 647	4008.79D		ROLLS-ROYCE	11 53 7 586 885	4508.105D
77 01 035 736	3116.82D				
77 01 038 494	4446.83D		ROVER	GTS 282	3000.83
77 01 039 156	3116.82D			GTS 287	4158.80D
77 01 042 512	4174.79D			GTS 298	3000.90
77 01 068 770	411241.82D			GTS 299	4821.89D
77 01 348 068	3029.89			GTS 301	410808.88D
77 01 348 139	3053.85			PEL 000170	410806.88D
77 01 348 372	3136.82D50			PEL 10009 EVA	4158.80D

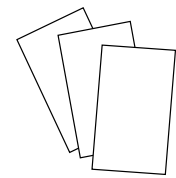

Hersteller Manufacturer Réf. Constructeur	Hersteller-Nr. Manufacturer's Ref. Réf. Constructeurs	Wahler-Nr Wahler-ref. Réf. Wahler	Hersteller Manufacturer Réf. Constructeur	Hersteller-Nr. Manufacturer's Ref. Réf. Constructeurs	Wahler-Nr Wahler-ref. Réf. Wahler	
SAAB	PEL 10016	410808.88D		032 121 110 L	410475.87D	
	PEL 10019 EVA	4821.89D		032 121 110 P	3143.87D	
				032 121 121 G	410475.87D	
	12 61 5097	411193.82D		032 121 121 K	410475.87D	
	12 62 2410	411193.82D		03G 121 111 A	4820.87D	
	24 435 102	4357.92D		03G 121 113	3472.87D	
	30 57 7561	4154.88D		03G 121 113 A	4820.87D	
	45 03 017	4175.92D		03L 121 111 AE	410845.87D	
	46 23 815	4175.92D		03L 121 111 R	410845.92D	
	47 72 190	4193.92D		03L 121 111 S	410845.92D	
	55 20 3388	410049.88D		03L 121 113 B	410537.92D	
	640972	411578.92D ▲		03L 121 114 B	410536.92D	
	75 02 297	4022.82D		044 121 113	4264.87D	
	75 17 345	4154.82D		050 121 113 C	3141.87D	
	83 89 512	4022.88D		056 121 113 D	4264.87D	
	85 47 572	6010.88D		068 121 113 H	4253.87D	
	85 69 23	6010.92D		06D 121 111 G	411186.87D	
	88 17 298	4154.88D		06F 121 111 F	411187.87D	
	88 17 538	4154.82D		075 121 113 D	4123.80D	
	88 22 025	4154.88D		191 959 481 A	6017.95D	
	90 53 7453	411193.82D		191 959 481 B	6020.95D	
	90 53 7811	411193.82D		191 959 481 C	6017.95D	
	91 66 687	4154.88D		1H0 959 481	6037.95D	
	91 94 101	4154.88D		1H0 959 481 B	6037.95D	
	91 94 242	4154.88D		251 959 481	6017.95D	
	93 20 284	4022.92D		321 959 481 A	6017.95D	
	93 37 551	4022.82D		321 959 481 C	6017.95D	
	95 26 518	6010.95D		321 959 481 D	6017.95D	
	SAURER	154.0943.426		4530.80	6U0 959 481 A	6017.95D
		461.0943		4030.70	823 959 481	6010.92D
SCANIA	1 347 594	4224.80D	823 959 481 A	6010.92D		
	1 358 995	4223.83D	823 959 481 F	6010.92D		
	1 395 856	4520.75	823 959 481 G	6010.95D		
	1 404 924	4223.83D	823 959 481 L	6010.92D		
	1 404 925	4224.80D	867 959 481	6039.95D		
	1 423 450	4223.83D	CA 032.221.01	3000.83		
	1 423 451	411004.80D	EA03222101	3023.87D		
	1 431 979	4223.75D	SE 020 032 221 A	3361.87D		
	1 458 198	4224.75D	SE 021 032 221 B	4256.87D50		
	1 745 449	4224.80D	SE 021 952 600 A	6020.92D		
	1 799 757	411004.80D				
	1 800 909	411004.80D	032 121 110 B	3143.87D		
	1 849 060	411004.80D	032 121 110 B	410989.87D		
	2 832 814	4520.80D	032 121 110 F	3167.83D		
	238 156	3096.75	032 121 110 J	410989.87D		
	283 281	4520.80D	032 121 110 L	410475.87D		
	525 076	3096.75	032 121 110 P	3143.87D		
	550 275	4520.80D	032 121 113	4253.87D		
	SEAT	0004218650	3345.79	032 121 121 G	410475.87D	
		030 121 113 B	4264.84D	032 121 121 K	410475.87D	
032 121 110 B		3143.87D	03G 121 111 A	4820.87D		
032 121 110 B		410989.87D	03G 121 113	3472.87D		
032 121 110 F		3167.83D	03G 121 113 A	4820.87D		
032 121 110 J		410989.87D	03L 121 111 AE	410845.87D		
			03L 121 111 R	410845.92D		
			03L 121 111 S	410845.92D		
			03L 121 113 B	410537.92D		

SKODA

Vergleichsliste | Cross References

Hersteller Manufacturer Réf. Constructeur	Hersteller-Nr. Manufacturer's Ref. Réf. Constructeurs	Wahler-Nr Wahler-ref. Réf. Wahler	Hersteller Manufacturer Réf. Constructeur	Hersteller-Nr. Manufacturer's Ref. Réf. Constructeurs	Wahler-Nr Wahler-ref. Réf. Wahler
SKODA	03L 121 114 B	410536.92D	SUZUKI	21210-AA120	411716.88D ▲
	044 121 113	4264.87D		21210-AA140	411715.84D ▲
	050 121 113 C	3141.87D		21210-AA150	411716.88D ▲
	056 121 113	4253.87D		21210-AA160	411715.84D ▲
	056 121 113 D	4264.87D		31753-0100	3000.83
	068 121 113 H	4253.87D			
	06D 121 111 G	411186.87D		17570-74000	410228.82D
	06F 121 111 F	411187.87D		17570-740001	410228.82D
	077 121 113	4274.87D		17570-86CA0	4446.83D
	077 121 113 B	4274.87D		17600-77820	410183.88D
	078 121 113	4274.87D		17600-83810	410228.82D
	078 121 113 C	4274.87D		17600-83811	410228.82D
	078 121 113 F	4274.87D		17600-83820	410228.82D
	078 121 113 J	4274.87D		17600-83821	410228.82D
	113 095 0	3032.80		17600-83821-000	3119.82
	113 095 075	6010.75D		17600-83822	410228.82D
	113 095 090	6010.92D		17600-83823	410228.82D
	113 095 091	3032.80		17600-85811	410183.82D
	114 095 090	3032.88		17600-85821	410183.88D
	115 095 070	6010.88D		17600-85830	410228.82D
	1H0 959 481 B	6037.95D		17600-85831	410228.82D
	441 044 330 186	6017.95D		17670-50G00	410183.82D
	823 959 481 G	6010.95D		17670-50G10	410183.88D
823 959 481 H	6010.95D	17670-50G20	410183.88D		
823 959 481 K	6010.95D	17670-63J00	410229.82D		
867 959 481	6039.95D	17670-65D00	410229.82D		
SMART			17670-66G00	4446.83D	
	0003179V009	3142.90D	17670-67H00	410183.88D	
	0003179V010	3142.90D	17670-73000	410228.82D	
	0004698V002	3146.90D	17670-73020	410228.82D	
	0004698V003	3146.90D	17670-73021	410228.82D	
	660 200 05 15	3146.90D	17670-76A00	410183.82D	
	Q0003179V010000000	3142.90D	17670-76A01	410183.82D	
STEYR			17670-76G00	410183.82D	
	217.87.71	6010.75D	17670-76G10	410183.88D	
	311.00.06.0065	4368.87	17670-77E00	410229.82D	
SUBARU			17670-77E10	4639.82D	
			17670-77E11	4639.82D	
			17670-77G00	410183.82D	
		17670-77G10	410183.88D		
		17670-78E00	3468.88D		
		17670-82810-000	410183.82D		
		17670-83000	410228.82D		
		17670-83001	410228.82D		
		17670-83010	410228.82D		
		17670-83011	410228.82D		
		17670-85020	410183.88D		
		17670-85C00	410229.82D		
		17690 84A00	411043.89D		
		17690-67JG0	410538.89D		
		17690-79J50	410049.88D		
		17690-84A10	411043.89D		
		17690-84A11	411043.89D		
		17690-84A50-000	411039.83D		
		17690-84A51	411477.89D ▲		
		17690-84E50-000	410588.88D		

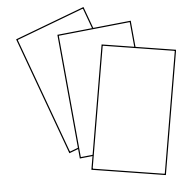

Hersteller Manufacturer Réf. Constructeur	Hersteller-Nr. Manufacturer's Ref. Réf. Constructeurs	Wahler-Nr Wahler-ref. Réf. Wahler	Hersteller Manufacturer Réf. Constructeur	Hersteller-Nr. Manufacturer's Ref. Réf. Constructeurs	Wahler-Nr Wahler-ref. Réf. Wahler
TALBOT	131 666.00	4026.89		13 38 018	3054.87D50
				13 38 024	4255.82D
TOYOTA	16340-54010	3477.88D		13 38 033	4255.87D
	90080-23002	3478.82D		13 38 038	4255.92D
	90916-03040	3119.88		13 38 041	3054.87D50
	90916-03040	3119.88D5		13 38 042	3021.88D50
	90916-03043	3477.88D		13 38 046	4115.92D
	90916-03043	4126.88		13 38 049	4144.92D
	90916-03046	4103.82D		13 38 052	3017.92D2
	90916-03055	3119.82D5		13 38 057	4164.92D
	90916-03060	3478.82D		13 38 060	4168.92D
	90916-03062	3477.88D		13 38 063	4164.92D
	90916-03062	4126.88		13 38 067	4175.92D
	90916-03065	4103.82D		13 38 068	4177.92D
	90916-03069	4103.82D		13 38 069	4180.82D
	90916-03072	3477.88D		13 38 073	4178.92D
	90916-03075	4480.82D		13 38 076	4237.80D
	90916-03078	3119.88D5		13 38 079	4183.92D
	90916-03079	411545.82D ▲		13 38 084	4175.92D
	90916-03081	411545.82D ▲		13 38 096	4459.92D
	90916-03084	4480.82D		13 38 466	4158.80D
	90916-03088	410178.82D		13 41 002	6010.95D
	90916-03090	3478.82D		13 41 011	6031.100D
	90916-03093	410231.82D		13 41 017	6031.105D
	90916-03095	3478.82D		13 41 028	6031.88D
	90916-03096	3478.82D		21 018 811	411193.82D
	90916-03097	410181.82D		24 405 922	4431.105D
	90916-03099	3477.88D		24 420 728	4297.92D
	90916-03101	410178.82D		24 435 781	4201.92D
	90916-03106	3477.88D		24 447 862	4433.92D
	90916-03109	3478.82D		24 456 401	411578.92D ▲
	90916-03115	3478.82D		40 191 1858	3021.88
	90916-03118	410181.82D		55 182 499	410588.88D
	90916-03120	410178.82D		55 202 510	410049.88D
	90916-03122	410201.80D		55 577 072	4431.105D
90916-03123	410231.82D		9 108 106	4151.76D	
90916-03125	4480.82D		9 110 719	3470.89D50	
90916-03129	4480.82D		90 009 956	4115.92D	
90916-03133	4480.82D		90 067 918	4255.92D	
90916-03136	4480.82D		90 108 636	6010.95D	
90916-03140	4480.82D		90 242 277	6031.100D	
90916-03144	4480.82D		90 264 080	4144.92D	
90916-03145	4480.82D		90 277 288	6031.105D	
90916-54010	3477.88D		90 357 303	6031.88D	
90916-A3001	4480.82D		90 411 948	4177.92D	
90916-A3002	4480.82D		90 509 110	4237.80D	
90916-A3003	4480.82D		90 529 846	4188.92D	
SU001-0223	4446.83D		90 536 262	411578.92D ▲	
			90 536 501	411578.92D ▲	
VALTRA	114 470	4351.79		90 537 453	411193.82D
	149 620	4588.75/1		90 537 605	411193.82D
				90 537 811	411193.82D
VAUXHALL	02 898 440	3054.92D50		90 570 620	4459.92D
	08 966 485	4255.87D		90 572 899	4198.92D
	12 615 097	411193.82D		90 573 326	4208.92D
	12 622 410	411193.82D		90 573 926	4201.92D
	13 38 016	3054.92D50		91 153 670	4158.80D

Vergleichsliste | Cross References

Hersteller Manufacturer Réf. Constructeur	Hersteller-Nr. Manufacturer's Ref. Réf. Constructeurs	Wahler-Nr Wahler-ref. Réf. Wahler	Hersteller Manufacturer Réf. Constructeur	Hersteller-Nr. Manufacturer's Ref. Réf. Constructeurs	Wahler-Nr Wahler-ref. Réf. Wahler
VAUXHALL	91 159 950	3466.89D		059 121 113 A	4006.82D
	91 160 216	126104 ▲		059 121 113 B	4006.82D
	91 28 786	4207.92D		062 121 111 A	3145.79D
	91 29 907	4242.92D		062 121 111 B	3145.79D
	91 61 123	4174.79D		068 121 113 A	4256.71
	93 177 343	410588.88D		068 121 113 H	4253.87D
	93 179 136	410049.88D		069 121 113	4116.87D1
	93 181 245	411578.92D ▲		069 121 113 A	4116.87D1
	93 198 035	411476.83D ▲		06B 121 113 A	3141.87D
	93 198 289	411476.83D ▲		06C 121 111 C	4814.92D
	93 198 317	411476.83D ▲		06C 121 111 D	4814.92D
	93 198 576	411476.83D ▲		06C 121 111 E	4814.92D
	93 198 646	411476.83D ▲		06D 121 111 G	411186.87D
	94 372 762	3468.88D		06F 121 111 F	411187.87D
	97 087 130	3467.85D		070 121 114	4430.87D
			075 121 113 D	4123.80D	
VM	3 901 2004 F	4158.80D		076 121 113 A	4123.70
	4 901 2012 F	4030.70		077 121 113	4274.87D
VOLKSWAGEN				077 121 113 B	4274.87D
	00A 121 113	4275.87D		077 121 113 C	4274.82D
	022 121 113	4455.80D		078 121 113	4274.87D
	025 121 113 D	4155.87D		078 121 113 C	4274.87D
	025 121 113 E	4155.87D		078 121 113 F	4274.87D
	025 121 113 F	4155.87D		078 121 113 J	4274.87D
	030 121 113	4264.84D		07K 121 113 B	4488.80D0
	030 121 113 B	4264.84D		07Z 121 111	4572.105D
	032 121 110 B	3143.87D		191 959 481 A	6017.95D
	032 121 110 B	410989.87D		191 959 481 B	6020.95D
	032 121 110 C	410989.80D		191 959 481 C	6017.95D
	032 121 110 F	3167.83D		1H0 959 481	6037.95D
	032 121 110 J	410989.87D		1H0 959 481 B	6037.95D
	032 121 110 L	410475.87D		251 959 481	6017.95D
	032 121 110 P	3143.87D		251 959 481 G	6087.87D
	032 121 113	4253.87D		251 959 481 H	6087.87D
	032 121 121 G	410475.87D		251 959 481 K	6087.87D
	032 121 121 K	410475.87D		321 959 481 A	6017.95D
	035 121 113	4088.80D		321 959 481 B	6020.95D
	035 121 113 B	4088.87D		321 959 481 C	6017.95D
	036 121 113	3091.92D		321 959 481 D	6017.95D
	036 121 113 A	3091.92D		321 959 481 E	6020.95D
	036 121 113 B	3091.92D		321 959 481 G	6020.95D
	037 121 113	4256.83D60		372 959 481 1	6039.95D
	03G 121 111 A	4820.87D		6U0 959 481 A	6017.95D
	03G 121 113	3472.87D		701 959 481	6037.87D
	03G 121 113 A	4820.87D		701 959 481 C	6037.81D
	03L 121 111 AE	410845.87D		701 959 481 J	6037.87D
	03L 121 111 R	410845.92D		811 959 481	6024.95D
	03L 121 111 S	410845.92D		823 959 481	6010.92D
	03L 121 113 B	410537.92D		823 959 481 A	6010.92D
	03L 121 114 B	410536.92D		823 959 481 F	6010.92D
	044 121 113	4264.87D		823 959 481 G	6010.95D
	050 121 113 C	3141.87D		823 959 481 H	6010.95D
	052 121 113 A	3091.92D		823 959 481 K	6010.95D
	056 121 113	4253.87D		823 959 481 L	6010.92D
	056 121 113 A	4256.80D		867 959 481	6039.95D
	056 121 113 D	4264.87D		893 959 481	6024.95D
	056 121 113 E	4256.71		9.407.0.757.002.4	3145.79D

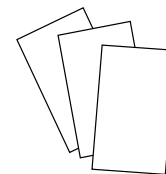

Hersteller Manufacturer Réf. Constructeur	Hersteller-Nr. Manufacturer's Ref. Réf. Constructeurs	Wahler-Nr Wahler-ref. Réf. Wahler
---	---	---

VOLVO

J 16 340 540 10	410201.80D
J 90 916 030 46	4103.82D
J 90 916 030 99	3477.88D
J 90 916 540 10	3477.88D
<hr/>	
1 219 150	4089.82D
1 544 097	4038.76D
1 544 098	4038.81D
1 544 389	4038.65D
1 544 683	4619.82
1 661 993	4619.75
1 665 694	4619.86
267 235	3029.89
271 417	4272.90D
271 664	4272.90D
272 246	4116.87D1
272 335	4206.90D
273 307	4089.92D
273 458	4022.88D
273 459	4089.87D
273 480	4122.87D
273 728	4088.87D
273 950	4038.65D

Vergleichsliste | Cross References

Wahler-Nr Wahler-ref. Réf. Wahler	Hersteller-Nr. Manufacturer's Ref. Réf. Constructeurs	Hersteller Manufacturer Réf. Constructeur	Wahler-Nr Wahler-ref. Réf. Wahler	Hersteller-Nr. Manufacturer's Ref. Réf. Constructeurs	Hersteller Manufacturer Réf. Constructeur
126104 ▲	44 09 180	OPEL	3000.90	04494 469	CHRYSLER
	77 00 101 179	DACIA		04494469	JEEP
	77 00 101 179	RENAULT		5202 8185 AB	CHRYSLER
	77 00 866 387	DACIA		52028185	CHRYSLER
	77 00 866 387	RENAULT		52028185AB	JEEP
	82 00 561 420	DACIA		AT 22963	JOHN DEERE
	82 00 561 420	RENAULT		GTS 298	ROVER
	91 160 216	GM		RE 33705	JOHN DEERE
2389.75/1	77 00 024 756	RENAULT	3004.74	1 518 627	FORD
	F 281 200 050 20	FENDT		1 607 993	FORD
	F 281.200.050.020	DODGE			
	X 815 090 003 000	FENDT			
2391.75			3004.82	13 38 030	OPEL
				13 38 077	OPEL
	1215 2752	MWM		34 402 115	INNOCENTI
	1215 2766	MWM		52 06 139	ASTON MARTIN
	1227 0074	DEUTZ-FAHR	607 200 00 15	MERCEDES-BENZ	
	6 052 5 011 001 1	MWM	94 207 217	ISUZU	
	6 052 5 011 004 2	MWM	97 094 283	GM	
	60 05 000 004	RENAULT			
	60 05 004 616	RENAULT	1 452 357	FORD	
	77 00 024 756	RENAULT	891F 8575 AA	FORD	
	F 150 204 050 10	FENDT			
	F 150 204 050 11	FENDT	3004.92D1	1 472 378	FORD
	F 150.204.050.011	DODGE		1E03-15-171	MAZDA
	X 815 090 002 000	FENDT		5 004 890	FORD
	X815.090.002.000	AGCO		5 004 891	FORD
	2393.75	1227 0073	DEUTZ-FAHR		6 526 879
6 052 5 011 002 4		MWM		691F 8575 BA	FORD
6 052 5 100 41		MWM		89BM 8575 AC	FORD
60 05 004 616		RENAULT		89BM 8575 AD	FORD
			3017.87D2	96 143 939	CHEVROLET
3000.75	7483490	PERKINS		96 143 939	DAEWOO
3000.80	000 203 64 75	MERCEDES-BENZ	3017.92D2	13 38 052	OPEL
	001 203 58 75	MERCEDES-BENZ		13 38 052	VAUXHALL
	003 203 22 75	MERCEDES-BENZ		90 200 836	GM
	PF 52.842	PERKINS			
3000.83			3017.92D50	13 38 015 old number	OPEL
	105.00.01.064.00	ALFA ROMEO			
	105.00.01.064.01	ALFA ROMEO	3021.88	1 649 194	FORD
	111 727	HOLDER		40 191 1858	VAUXHALL
	21200-G3100	NISSAN	3021.88D50	1 497 689	FORD
	3156283	CHRYSLER		1 509 953	FORD
	31753-0100	SUBARU		1 517 858	FORD
	406 2141	FIAT		1 520 969	FORD
	406 2172	FIAT		1 635 905	FORD
	406 5540	FIAT		13 38 042	OPEL
	408 6415	FIAT		13 38 042	VAUXHALL
	413 8169	FIAT		5 004 887	FORD
	413 8769	IVECO		6 085 917	FORD
	AT 22961	JOHN DEERE		6 085 918	FORD
	CA 032.221.01	SEAT		6 100 630	FORD
	GTS 282	ROVER		6 201 207	FORD
	HD 035 A01	HOLDER			

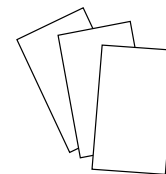

Wahler-Nr Wahler-ref. Réf. Wahler	Hersteller-Nr. Manufacturer's Ref. Réf. Constructeurs	Hersteller Manufacturer Réf. Constructeur	Wahler-Nr Wahler-ref. Réf. Wahler	Hersteller-Nr. Manufacturer's Ref. Réf. Constructeurs	Hersteller Manufacturer Réf. Constructeur
	6 201 247	FORD		13 38 041	OPEL
	800 572	FORD		13 38 041	VAUXHALL
	800 573	FORD			
	800 574	FORD	3054.92D50	02 898 440	GM
	81SF 8575 EA	FORD		02 898 440	VAUXHALL
	81SF 8575 FA	FORD		13 38 016	OPEL
	85HF 8575 AA	FORD		13 38 016	VAUXHALL
	91XM 8575 AA	FORD			
3021.92D50			3061.82	1337 47	PEUGEOT
	6 100 629	FORD		91 500 723	CITROËN
3023.87D				91 500 723 80	PEUGEOT
	415 4312	FIAT		9150 0723 80	FIAT
	415 4313	AUTOBIANCHI	3061.88		
	415 4313	FIAT		1337 49	PEUGEOT
	EA03222101	SEAT		91 500 724 80	PEUGEOT
3029.83			3067.83		
	225 070	DAF		6071 0617	ALFA ROMEO
	77 00 575 874	RENAULT	3091.92D		
	77 01 348 376	RENAULT		036 121 113	AUDI
3029.86				036 121 113	VOLKSWAGEN
	77 00 619 931	RENAULT		036 121 113 A	AUDI
	77 00 722 762	RENAULT		036 121 113 A	VOLKSWAGEN
	77 01 348 374	RENAULT		036 121 113 B	AUDI
3029.89				036 121 113 B	VOLKSWAGEN
	267 235	VOLVO		052 121 113 A	AUDI
	77 00 727 190	RENAULT		052 121 113 A	VOLKSWAGEN
	77 00 730 540	RENAULT	3096.75		
	77 01 348 068	RENAULT		238 156	SCANIA
3032.80				525 076	SCANIA
	113 095 0	SKODA	3100.88D		
	113 095 091	SKODA		6 994 257	FORD
3032.88				95WM 8575 AA	FORD
	114 095 090	SKODA	3100.92D		
3033.78D				4 356 548	FORD
	5454410R	CITROËN		6 758 566	FORD
	5490459C	CITROËN		YU3E 8575 BA	FORD
	75441833	CITROËN	3103.79		
	95 492 929	CITROËN		9845 0800	FIAT
3033.84D ▲			3105.87D		
	1337 65	PEUGEOT		754 5958	FIAT
	95 495 311	CITROËN		7545 9580	AUTOBIANCHI
3044.80				758 9135	FIAT
	65 540 40601	INNOCENTI		758 9135	LANCIA
3044.90D1				7581 3190	AUTOBIANCHI
	21200-01B00	NISSAN	3109.82D		
3053.75				758 1201	LANCIA
	1337 26	CITROËN		758 1636	LANCIA
	1337 26	PEUGEOT		7581 635	FIAT
	6 058 784	FORD	3109.87D		
	79 100 118 73	CITROËN		758 1200	FIAT
	79 100 118 73	PEUGEOT		758 1201	FIAT
3053.85			3116.82D		
	77 01 348 139	RENAULT		77 01 035 736	RENAULT
3054.87D50				77 01 039 156	RENAULT
	02 898 688	GM		9849 8831	FIAT
	13 38 018	OPEL	3118.82D1		
	13 38 018	VAUXHALL		21200-2H600	NISSAN

Vergleichsliste | Cross References

Wahler-Nr Wahler-ref. Réf. Wahler	Hersteller-Nr. Manufacturer's Ref. Réf. Constructeurs	Hersteller Manufacturer Réf. Constructeur	Wahler-Nr Wahler-ref. Réf. Wahler	Hersteller-Nr. Manufacturer's Ref. Réf. Constructeurs	Hersteller Manufacturer Réf. Constructeur	
3118.82D1	21200-41B00	NISSAN	3119.88D3	90916-03040	TOYOTA	
	21200-85G00	NISSAN		MD 997221	MITSUBISHI	
	21200-99B03	NISSAN		8173-99-152 A	MAZDA	
	21200-P7901	NISSAN		8173-99-152 B	MAZDA	
	21200-P7990	NISSAN		8AG4-15-171	MAZDA	
	21200-V0100	NISSAN		8AX1-15-171	MAZDA	
	21200-V0200	NISSAN		B541-15-171	MAZDA	
	21200-V0201	NISSAN		HE 41-99-152 A	MAZDA	
3118.88D1	21200-2H605	NISSAN	3119.88D4	MD 005131	MITSUBISHI	
	21200-78515	NISSAN		MD 972903	MITSUBISHI	
	21200-85G05	NISSAN		MD 997221	MITSUBISHI	
	21200-85G06	NISSAN		MD 997461	MITSUBISHI	
	21200-P7500	NISSAN		MD 997608	MITSUBISHI	
	21200-P7905	NISSAN	3119.88D5	90916-03040	TOYOTA	
	21200-P7906	NISSAN		90916-03078	TOYOTA	
	21200-P7991	NISSAN		3136.82D50	1337 30	PEUGEOT
	21200-P7991	NISSAN	1338 37		PEUGEOT	
	21200-V0105	NISSAN	1338 83		PEUGEOT	
	21200-V0205	NISSAN	77 01 348 372		RENAULT	
21200-V0206	NISSAN	79 100 111 01	CITROËN			
3119.82	17600-83821-000	SUZUKI	79 100 143 90		CITROËN	
	19300-PA0-003	HONDA	79 100 165 60	CITROËN		
	19300-PB2-003	HONDA	96 171 780 80	CITROËN		
	19300-PB2-004	HONDA	9617 1780 80	FIAT		
	19300-PB2-013	HONDA	3136.88D50	1337 27	PEUGEOT	
	19300-PB2-014	HONDA		1338 11	CITROËN	
	19300-PB2-024	HONDA		1338 11	PEUGEOT	
	19300-PB2-811	HONDA		1338 44	CITROËN	
	19300-PB2-812	HONDA		1338 44	PEUGEOT	
	19300-PB2-815	HONDA		79 100 118 80	CITROËN	
	19300-PB2-816	HONDA		96 049 146	CITROËN	
	19300-PB2-817	HONDA	96 050 286 80	CITROËN		
	8124-99-152	MAZDA	96 057 087 80	PEUGEOT		
	90916-03040-000	DAIHATSU	96 057 136	CITROËN		
3119.82D3	HE 41-99-152 C	MAZDA	96 057 136 80	PEUGEOT		
			96 196 379 80	PEUGEOT		
3119.82D4	MD 001370	MITSUBISHI	3141.87D	050 121 113 C	AUDI	
	MD 005371	MITSUBISHI		050 121 113 C	SEAT	
	MD 008086	MITSUBISHI		050 121 113 C	SKODA	
	MD 075460	MITSUBISHI		050 121 113 C	VOLKSWAGEN	
	MD 117759	MITSUBISHI		06B 121 113 A	VOLKSWAGEN	
	MD 126168	MITSUBISHI		3142.90D	0003179V009	SMART
	MD 972905	MITSUBISHI			0003179V010	SMART
	MD 972908	MITSUBISHI	160 200 03 15		MERCEDES-BENZ	
	MD 997217	MITSUBISHI	Q0003179V010000000		SMART	
	MD 997219	MITSUBISHI	3143.87D		032 121 110 B	AUDI
	MD 997220	MITSUBISHI			032 121 110 B	SEAT
	MD 997602	MITSUBISHI			032 121 110 B	SKODA
	MD 997603	MITSUBISHI		032 121 110 B	VOLKSWAGEN	
	MD 997607	MITSUBISHI				
3119.82D5	90916-03055	TOYOTA				
3119.88	3 257 449	FORD				
	90048-33021-000	DAIHATSU				

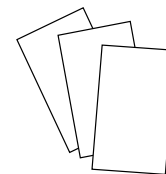

Wahler-Nr Wahler-ref. Réf. Wahler	Hersteller-Nr. Manufacturer's Ref. Réf. Constructeurs	Hersteller Manufacturer Réf. Constructeur	Wahler-Nr Wahler-ref. Réf. Wahler	Hersteller-Nr. Manufacturer's Ref. Réf. Constructeurs	Hersteller Manufacturer Réf. Constructeur
	032 121 110 P	AUDI	3344.75	11 53 1 260 720	BMW
	032 121 110 P	SEAT			
	032 121 110 P	SKODA	3344.80	11 53 1 253 248	BMW
	032 121 110 P	VOLKSWAGEN		11 53 1 253 249	BMW
				11 53 9 055 587	BMW
3145.79D	062 121 111 A	VOLKSWAGEN			
	062 121 111 B	VOLKSWAGEN	3345.79	0004218650	SEAT
	9 407 0 757 002 4	MWM		421 8649	AUTOBIANCHI
	9.407.0.757.002.4	VOLKSWAGEN		4218 6500	FIAT
3146.90D	0004698V002	SMART			
	0004698V003	SMART	3355.80D	594 2240	FIAT
	660 200 03 15	MERCEDES-BENZ		762 8527	FIAT
	660 200 05 15	SMART			
			3356.80D	8234 2688	LANCIA
3151.87D	4652 3118	FIAT			
	4673 7644	FIAT	3360.87D	762 8417	FIAT
3159.82D	1337 48	PEUGEOT	3361.87D	596 6787	FIAT
	595 0116	FIAT		596 9749	FIAT
	756 4583	FIAT		762 6622	FIAT
	761 5234	FIAT		SE 020 032 221 A	SEAT
	761 5235	FIAT			
			3373.80D	765 6384	FIAT
3163.88D	4652 2664	FIAT		765 6385	FIAT
	4652 2664	LANCIA			
	4677 6217	FIAT	3378.80	761 3433	FIAT
3164.88	4653 6104	FIAT	3383.87	755 4544	FIAT
	4677 6218	FIAT		769 2450	FIAT
				769 6535	FIAT
3166.89D	11061-00QAE	NISSAN			
	77 00 110 716	RENAULT	3431.80D	1336 A7	CITROËN
	82 00 660 882	DACIA		1336 A7	PEUGEOT
	82 00 660 882	RENAULT		4681 8413	FIAT
				599 9818	LANCIA
3167.83D	032 121 110 F	AUDI		759 7659	FIAT
	032 121 110 F	SEAT		759 9824	FIAT
	032 121 110 F	SKODA		762 5346	FIAT
	032 121 110 F	VOLKSWAGEN		762 5347	FIAT
3169.79D	50 404 5799	IVECO	3457.90D	271 200 00 15	MERCEDES-BENZ
	50 408 4365	IVECO		271 203 03 75	MERCEDES-BENZ
3171.82D	50 401 7209	IVECO	3463.89D	1336 N5	CITROËN
				1336 N5	PEUGEOT
3174.89D	77 00 868 980	RENAULT		1336 Q1	CITROËN
				1336 Q1	PEUGEOT
3300.80D	779 4132	FIAT		96 300 66 780	CITROËN
				96 300 667 80	PEUGEOT
3301.80D	777 0416	FIAT			
			3466.89D	44 08 334	OPEL
3302.80D	774 1883	FIAT		60 01 543 366	RENAULT
				77 00 872 554	DACIA
3333.87	21080-13060-10	LADA		77 00 872 554	RENAULT
	2108-13060-10	LADA		77 00 872 635	RENAULT
	21081-3060-11	LADA		82 00 772 985	DACIA
				82 00 772 985	RENAULT

Vergleichsliste | Cross References

Wahler-Nr Wahler-ref. Réf. Wahler	Hersteller-Nr. Manufacturer's Ref. Réf. Constructeurs	Hersteller Manufacturer Réf. Constructeur	Wahler-Nr Wahler-ref. Réf. Wahler	Hersteller-Nr. Manufacturer's Ref. Réf. Constructeurs	Hersteller Manufacturer Réf. Constructeur
3466.89D	91 159 950	GM	3478.82D	21200-4M500	NISSAN
	91 159 950	VAUXHALL		21200-77A05	NISSAN
3467.85D	13 38 075	OPEL	21200-77A65	NISSAN	
	8-79312-726-0	ISUZU	21200-77A66	NISSAN	
	8-94360-227-0	ISUZU	21200-86J00	NISSAN	
	8-97087-130-2	ISUZU	21200-86J01	NISSAN	
	97 087 130	GM	21200-90J00	NISSAN	
	97 087 130	VAUXHALL	21200-90J10	NISSAN	
			21200-9F600	NISSAN	
3468.88D	13 38 056	OPEL	90080-23002	TOYOTA	
	17670-78E00	SUZUKI	90916-03060	TOYOTA	
	8-94123-295-0	ISUZU	90916-03090	TOYOTA	
	8-94123-295-1	ISUZU	90916-03090-000	DAIHATSU	
	8-94372-762-0	ISUZU	90916-03095	TOYOTA	
	8AG1-15-171	MAZDA	90916-03096	TOYOTA	
	8AG1-15-171A	MAZDA	90916-03109	TOYOTA	
	8AG2-15-171	MAZDA	90916-03115	TOYOTA	
	8AG2-15-171A	MAZDA			
	8AG6-15-171	MAZDA	4646 4992	FIAT	
	8AG7-15-171	MAZDA	4651 3506	FIAT	
	8AG8-15-171	MAZDA	4652 3733	FIAT	
	8AZ1-15-171	MAZDA	4677 6216	FIAT	
	94 372 762	GM			
	94 372 762	VAUXHALL	3481.88D	4646 4992	FIAT
	RF03-15-171A	MAZDA		4651 3506	FIAT
				4652 3733	FIAT
			4677 6216	FIAT	
		3483.89D	1338 A0	CITROËN	
			1338 A0	PEUGEOT	
			96 300 666 80	CITROËN	
			96 300 666 80	PEUGEOT	
3469.91D	77 00 742 617	RENAULT	3484.87D	775 9596	FIAT
	77 00 858 802	RENAULT			
			3485.87D	772 2107	FIAT
3470.89D50	3 344 616	VOLVO	3497.88D	1 096 283	FORD
	3 345 628	VOLVO		1338 F5	CITROËN
	44 02 719	OPEL		1338 F5	PEUGEOT
	77 00 723 945	RENAULT		XS7Q 8575 AA	FORD
	77 00 866 896	RENAULT			
	77 00 872 314	RENAULT	3498.88D	0K710-15-171	KIA
	77 01 348 373	RENAULT		0K9FC-15-171	KIA
	9 110 719	GM		8AB1-15-171	MAZDA
	9 110 719	VAUXHALL		8AB5-15-171	MAZDA
	M-474877	MITSUBISHI		8AB8-15-171	MAZDA
M-863985	MITSUBISHI		8ABE-15-171	MAZDA	
			8AG3-15-171	MAZDA	
3472.87D	03G 121 113	AUDI		8AG5-15-171	MAZDA
	03G 121 113	SEAT		8AK1-15-171	MAZDA
	03G 121 113	SKODA		8AN1-15-171	MAZDA
	03G 121 113	VOLKSWAGEN		8AU1-15-171	MAZDA
	MN 980137	MITSUBISHI		8AU-15-171	MAZDA
				AB6-15-171	MAZDA
3477.88D	16340-54010	TOYOTA		B6H-15-171	MAZDA
	90916-03043	TOYOTA		B6H-15-171 A	MAZDA
	90916-03062	TOYOTA		BP6F-15-171	MAZDA
	90916-03072	TOYOTA		BPD3-15-171	MAZDA
	90916-03099	TOYOTA		E5D3-15-171	MAZDA
	90916-03106	TOYOTA		F201-15-171	MAZDA
	90916-54010	TOYOTA			
	J 90 916 030 99	VOLKSWAGEN			
	J 90 916 540 10	VOLKSWAGEN			

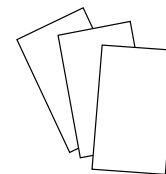

Wahler-Nr Wahler-ref. Réf. Wahler	Hersteller-Nr. Manufacturer's Ref. Réf. Constructeurs	Hersteller Manufacturer Réf. Constructeur	Wahler-Nr Wahler-ref. Réf. Wahler	Hersteller-Nr. Manufacturer's Ref. Réf. Constructeurs	Hersteller Manufacturer Réf. Constructeur		
3499.82D	KE5D3-15-171	KIA	4017.82	77 01 026 647	RENAULT		
	ZZ40-15-171	MAZDA		3059 676 R 1	INTER. HARV. IHC		
	0223-15-171	MAZDA		3059 676 R 91	INTER. HARV. IHC		
	0419-15-171	MAZDA		3059 676 R 92	INTER. HARV. IHC		
	0419-99-152	MAZDA		3228 046 R 2	INTER. HARV. IHC		
	8AB7-15-171	MAZDA		3228 046 R1	INTER. HARV. IHC		
	8AB9-15-171	MAZDA		4022.82D	75 02 297	SAAB	
	8ABC-15-171	MAZDA			93 37 551	SAAB	
	B366-15-171	MAZDA			94 214 962	ISUZU	
	B3H3-15-171	MAZDA		4022.82D1	754 0318	FIAT	
	B3H8-15-171A	MAZDA			754 0318	LANCIA	
	HE 41-99-152C	MAZDA			761 5234	ALFA ROMEO	
	HE 41-99-152D	MAZDA			765 6567	FIAT	
3499.88D	8173-15-152 C	MAZDA	4022.88D	273 458	VOLVO		
	8173-15-171	MAZDA		83 89 512	SAAB		
	8173-99-152	MAZDA		4022.92D	93 20 284	SAAB	
	8173-99-152 A	MAZDA	4026.89		131 666.00	TALBOT	
	8173-99-152 B	MAZDA			4029.81	466 017	VOLVO
	8ABA-15-171	MAZDA		4030.70		4 901 2012 F	VM
	8ABB-15-171	MAZDA	461.0943			SAURER	
	8ABB-15-171A	MAZDA	4033.82D		422 0309	FIAT	
	8ABD-15-171	MAZDA		443 7481	FIAT		
	8AG4-15-171	MAZDA		4038.65D	1 544 389	VOLVO	
	8AX1-15-171	MAZDA	273 950		VOLVO		
	B541-15-171	MAZDA	3 831 426		VOLVO		
	4003.86	6050 4230	ALFA ROMEO	4038.71D	424 370	VOLVO	
			466 127		VOLVO		
4006.82D	059 121 113 A	AUDI	4038.76D	875 788	VOLVO		
	059 121 113 A	VOLKSWAGEN		1 544 097	VOLVO		
	059 121 113 B	AUDI		273 951	VOLVO		
	059 121 113 B	VOLKSWAGEN		273 953	VOLVO		
	8AB3 15 171	MAZDA		875 787	VOLVO		
	C28067	JAGUAR		4038.81D	1 544 098	VOLVO	
	C33012	JAGUAR			273 952	VOLVO	
C37129	JAGUAR	4049.80D	617 200 03 15	MERCEDES-BENZ			
4007.80D	1000208309		LOMBARDINI	617 200 11 15	MERCEDES-BENZ		
	1285 0152		DEUTZ-FAHR	4049.80D1	617 200 18 15	MERCEDES-BENZ	
	1285 1663		DEUTZ-FAHR		4064.75D	002 203 82 75	MERCEDES-BENZ
	9195 057		LOMBARDINI			116 200 00 15	MERCEDES-BENZ
	9195 1240	LOMBARDINI	4078.65D	004 203 65 75	MERCEDES-BENZ		
ED0091951240S	LOMBARDINI						
4008.74D	465 5782	FIAT					
	467 4169	FIAT					
	470 3624	FIAT					
	470 3625	FIAT					
	482 3226	FIAT					
4008.79D	104 9195 092	LOMBARDINI					
	468 4390	IVECO					
	470 3088	IVECO					
	475 0024	FIAT					
	6071 3535	ALFA ROMEO					

Vergleichsliste | Cross References

Wahler-Nr Wahler-ref. Réf. Wahler	Hersteller-Nr. Manufacturer's Ref. Réf. Constructeurs	Hersteller Manufacturer Réf. Constructeur	Wahler-Nr Wahler-ref. Réf. Wahler	Hersteller-Nr. Manufacturer's Ref. Réf. Constructeurs	Hersteller Manufacturer Réf. Constructeur	
4078.71D	002 203 16 75	MERCEDES-BENZ	410016.98D	1 473 089	FORD	
	002 203 31 75	MERCEDES-BENZ		1 473 090	FORD	
	110 200 09 15	MERCEDES-BENZ		7S7G 6L721 AA	FORD	
4078.75D	770275	PEGASO	410048.88D	7S7G 6L721 AB	FORD	
4078.79D	001 203 90 75	MERCEDES-BENZ	410049.88D	13 38 020	OPEL	
	002 203 35 75	MERCEDES-BENZ		5519 4271	FIAT	
	002 203 37 75	MERCEDES-BENZ		5520 2373	FIAT	
	002 203 38 75	MERCEDES-BENZ		63 38 039	OPEL	
	002 203 46 75	MERCEDES-BENZ		93 18 4200	OPEL	
	002 203 72 75	MERCEDES-BENZ				
	002 203 78 75	MERCEDES-BENZ		13 38 039	OPEL	
4078.87D	100 200 07 15	MERCEDES-BENZ		13 38 154	OPEL	
	001 203 91 75	MERCEDES-BENZ		13 38 275	OPEL	
	002 203 76 75	MERCEDES-BENZ		17690-79J50	SUZUKI	
	002 203 81 75	MERCEDES-BENZ		55 20 3388	SAAB	
	100 200 05 15	MERCEDES-BENZ		55 202 510	GM	
	102 200 08 15	MERCEDES-BENZ		55 202 510	VAUXHALL	
	102 200 14 15	MERCEDES-BENZ		5518 7784	FIAT	
	102 200 15 15	MERCEDES-BENZ		5520 2510	ALFA ROMEO	
	102 200 19 15	MERCEDES-BENZ		5520 2510	FIAT	
	110 200 01 11	MERCEDES-BENZ		5520 3388	FIAT	
	110 200 05 15	MERCEDES-BENZ		7175 4778	ALFA ROMEO	
				7175 4778	FIAT	
	4078.92D	004 203 86 75	MERCEDES-BENZ		93 179 136	GM
		110 200 19 15	MERCEDES-BENZ		93 179 136	VAUXHALL
4083.79 •	738 0833	LIEBHERR	410055.87D ▲	642 200 08 15	MERCEDES-BENZ	
4083.83D50	001 203 69 75	MERCEDES-BENZ	410058.84D	1338 38	CITROËN	
	002 203 04 75	MERCEDES-BENZ		1338 38	PEUGEOT	
	002 203 53 75	MERCEDES-BENZ		96 145 00 980	CITROËN	
4088.80D	035 121 113	AUDI	410075.79D ▲	1336 AA	CITROËN	
	035 121 113	VOLKSWAGEN		1336 AA	PEUGEOT	
				50 413 2246	IVECO	
4088.87D	035 121 113 B	AUDI	410081.79D	50 415 0562	FIAT	
	035 121 113 B	VOLKSWAGEN		50 415 0562	IVECO	
	273 728	VOLVO				
4089.82D	1 219 150	VOLVO	410086.97D0	11 53 7 536 655	BMW	
	463 433	VOLVO		11 53 7 544 788	BMW	
				11 53 7 549 476	BMW	
4089.87D	273 459	VOLVO	410087.97D0			
				11 53 7 550 172	BMW	
4089.92D	273 307	VOLVO	410090.88D	5519 3669	FIAT	
				5519 4029	FIAT	
				5520 2176	FIAT	
				5523 9819	FIAT	
4091.82D	435 1196	FIAT	410131.88D	1 086 282	FORD	
	4355 8460	AUTOBIANCHI		1E07-15-171	MAZDA	
	440 9254	FIAT		1E07-15-171 A	MAZDA	
4094.71/1	4409 2540	AUTOBIANCHI		6 169 774	FORD	
	0117 2667	DEUTZ-FAHR		89FF 8575 AB	FORD	
	0117 2668	DEUTZ-FAHR				
410007.87D	772 9959	FIAT				

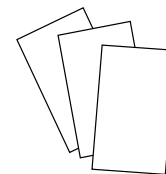

Wahler-Nr Wahler-ref. Réf. Wahler	Hersteller-Nr. Manufacturer's Ref. Réf. Constructeurs	Hersteller Manufacturer Réf. Constructeur	Wahler-Nr Wahler-ref. Réf. Wahler	Hersteller-Nr. Manufacturer's Ref. Réf. Constructeurs	Hersteller Manufacturer Réf. Constructeur
410171.87D	5080 146 AB	DODGE	410183.88D	17600-77820	SUZUKI
	611 200 02 15	MERCEDES-BENZ		17600-85821	SUZUKI
	611 200 07 15	MERCEDES-BENZ		17670-50G10	SUZUKI
	611 203 04 75	MERCEDES-BENZ		17670-50G20	SUZUKI
	611 203 05 75	MERCEDES-BENZ		17670-67H00	SUZUKI
	611 203 15 75	MERCEDES-BENZ		17670-76G10	SUZUKI
	611 203 19 75	MERCEDES-BENZ		17670-77G10	SUZUKI
	646 200 12 15	MERCEDES-BENZ		17670-85020	SUZUKI
410174.92D	646 200 00 15	MERCEDES-BENZ	410184.89D	21200-KA070	SUBARU
	646 200 11 15	MERCEDES-BENZ		96 610 574	GM
	646 203 02 75	MERCEDES-BENZ		1336 Q2	CITROËN
410176.82D0	21200-57J00	NISSAN	410201.80D	1336 Q2	PEUGEOT
	21200-57J15	NISSAN		96â485 426 80	PEUGEOT
410176.88D0	21200-57J05	NISSAN	410224.78D	90048-33088	DAIHATSU
410178.82D	90916-03088 90916-03101 90916-03120	TOYOTA TOYOTA TOYOTA		410224.78D	90916-03122
			J 16 340 540 10		VOLKSWAGEN
			410179.84D	90048-33078 90048-33083 90048-33092	DAIHATSU DAIHATSU DAIHATSU
19300-PDA-E01	HONDA				
19300-PJ7-003	HONDA				
410180.82D	MD 174233 MD 194988 MD 194988 MD 348937 MD 351495 MD 997644 ME 220538 ME 241816	MITSUBISHI CHRYSLER MITSUBISHI MITSUBISHI MITSUBISHI MITSUBISHI MITSUBISHI MITSUBISHI	410224.78D	19300-PJ7-004	HONDA
				19300-PM3-003	HONDA
				19300-PM3-004	HONDA
				19300-PR3-003	HONDA
				19300-PT0-003	HONDA
				19300-PT0-004	HONDA
				19301-P08-000	HONDA
				19301-P08-305	HONDA
19301-P08-306	HONDA				
410181.82D	90916-03097 90916-03118	TOYOTA TOYOTA	410224.78D	19301-P08-315	HONDA
				19301-P08-316	HONDA
410182.84D	90048-33047 90048-33056	DAIHATSU DAIHATSU	410224.78D	19301-P10-307	HONDA
				19301-P1K-307	HONDA
410183.82D	17600-85811 17670-50G00 17670-76A00 17670-76A01 17670-76G00 17670-77G00 17670-82810-000 21200-KA010 21200-KA050 21200-KA150 21200-KA151 21200-KA152 21200-KA153 21200-KA154 94 580 182	SUZUKI SUZUKI SUZUKI SUZUKI SUZUKI SUZUKI SUZUKI SUBARU SUBARU SUBARU SUBARU SUBARU SUBARU SUBARU SUBARU GM	410224.82D	19301-PAA-305	HONDA
				19301-PAA-306	HONDA
				19301-PDF-305	HONDA
				19301-PLC-305	HONDA
				19301-PLC-315	HONDA
				19301-REA-305	HONDA
				19301-RME-305	HONDA
				19301-RP3-305	HONDA
				5-86000-349-0	ISUZU
				5-86000-350-0	ISUZU
				5-86012-056	ISUZU
				5-86014-381-0	ISUZU
				5-86018-963	ISUZU
				5-86018-964-0	ISUZU
				5-86019-507-0	ISUZU
				5-86019-513-0	ISUZU
				19301-P07-306	HONDA
19301-P07-316	HONDA				
19301-PWA-305	HONDA				
19301-PZA-305	HONDA				
19301-RNA-305	HONDA				

Vergleichsliste | Cross References

Wahler-Nr Wahler-ref. Réf. Wahler	Hersteller-Nr. Manufacturer's Ref. Réf. Constructeurs	Hersteller Manufacturer Réf. Constructeur	Wahler-Nr Wahler-ref. Réf. Wahler	Hersteller-Nr. Manufacturer's Ref. Réf. Constructeurs	Hersteller Manufacturer Réf. Constructeur
410224.82D	19301-RNA-306	HONDA	410348.82D	25500-23001	HYUNDAI
	19301-RNA-307	HONDA		410351.88D	25500-22600
	5-86008138	ISUZU	410225.78D		19301-PNA-003
410226.78D	19301-RAF-003	HONDA	410352.82D		0K2A-15-171
	19301-RAF-004	HONDA		410352.88D	KHE41-15-171
410228.82D	17570-74000	SUZUKI	410389.103D ▲		271 200 01 15
	17570-740001	SUZUKI		271 200 02 15	MERCEDES-BENZ
	17600-83810	SUZUKI		271 200 03 15	MERCEDES-BENZ
	17600-83811	SUZUKI	410475.87D	032 121 110 L	AUDI
	17600-83820	SUZUKI		032 121 110 L	SEAT
	17600-83821	SUZUKI		032 121 110 L	SKODA
	17600-83822	SUZUKI		032 121 110 L	VOLKSWAGEN
	17600-83823	SUZUKI		032 121 121 G	AUDI
	17600-85830	SUZUKI		032 121 121 G	SEAT
	17600-85831	SUZUKI		032 121 121 G	SKODA
	17670-73000	SUZUKI		032 121 121 G	VOLKSWAGEN
	17670-73020	SUZUKI		032 121 121 K	AUDI
	17670-73021	SUZUKI		032 121 121 K	SEAT
	17670-83000	SUZUKI	032 121 121 K	SKODA	
	17670-83001	SUZUKI	032 121 121 K	VOLKSWAGEN	
	17670-83010	SUZUKI	410488.88D	21200-BX000	NISSAN
17670-83011	SUZUKI	4105.71D		002 203 39 75	MERCEDES-BENZ
410229.82D	17670-63J00		SUZUKI	003 203 29 75	MERCEDES-BENZ
	17670-65D00		SUZUKI	003 203 32 75	MERCEDES-BENZ
	17670-77E00		SUZUKI	003 203 74 75	MERCEDES-BENZ
	17670-85C00		SUZUKI	003 203 79 75	MERCEDES-BENZ
	7174 2133	FIAT	004 203 84 75	MERCEDES-BENZ	
410230.78D	21200-AA071	SUBARU	005 203 28 75	MERCEDES-BENZ	
	21200-AA072	SUBARU	4105.75D	474 9724	IVECO
	21210-AA030	SUBARU		4105.79D	003 203 91 75
410231.82D	11 53 7 791 072	BMW	003 203 92 75		MERCEDES-BENZ
	90916-03093	TOYOTA	004 203 85 75		MERCEDES-BENZ
	90916-03123	TOYOTA	005 203 27 75		MERCEDES-BENZ
410262.91D	5278 144 AA	CHRYSLER	4105.83D		002 203 32 75
410263.91D	11 53 1 485 847	BMW		002 203 45 75	MERCEDES-BENZ
	11 53 1 501 173	BMW		002 203 47 75	MERCEDES-BENZ
	11 53 7 596 787	BMW		002 203 49 75	MERCEDES-BENZ
	4693 117 AA	CHRYSLER		002 203 56 75	MERCEDES-BENZ
410289.81D	50 425 8346	IVECO	002 203 59 75	MERCEDES-BENZ	
	50 432 0545	IVECO	002 203 79 75	MERCEDES-BENZ	
4103.82D	90916-03046	TOYOTA	002 203 90 75	MERCEDES-BENZ	
	90916-03046-000	DAIHATSU	003 203 14 75	MERCEDES-BENZ	
	90916-03065	TOYOTA	003 203 28 75	MERCEDES-BENZ	
	90916-03069	TOYOTA	003 203 31 75	MERCEDES-BENZ	
	J 90 916 030 46	VOLKSWAGEN	003 203 73 75	MERCEDES-BENZ	
			003 203 78 75	MERCEDES-BENZ	
		004 203 83 75	MERCEDES-BENZ		

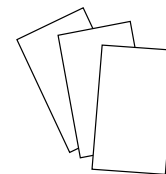

Wahler-Nr Wahler-ref. Réf. Wahler	Hersteller-Nr. Manufacturer's Ref. Réf. Constructeurs	Hersteller Manufacturer Réf. Constructeur	Wahler-Nr Wahler-ref. Réf. Wahler	Hersteller-Nr. Manufacturer's Ref. Réf. Constructeurs	Hersteller Manufacturer Réf. Constructeur	
410511.88D	005 203 26 75	MERCEDES-BENZ	410538.89D	03L 121 113 B	SKODA	
	373 203 70 75	MERCEDES-BENZ		03L 121 113 B	VOLKSWAGEN	
	83 129 996 050	EVOBUS		11060-00QAF	NISSAN	
	4679 0294	FIAT		17690-67JG0	SUZUKI	
	4679 0294	LANCIA		82 00 112 054	RENAULT	
410512.88D	6081 6681	ALFA ROMEO	410588.88D	17690-84E50-000	SUZUKI	
	4654 6375	FIAT		47 08 757	OPEL	
	4654 6375	LANCIA		55 182 499	GM	
	6081 5681	ALFA ROMEO		55 182 499	VAUXHALL	
410513.88D	4652 0785	FIAT	410589.88D	5519 9402	FIAT	
	4652 0785	LANCIA		63 38 022	OPEL	
	779 4218	FIAT		93 177 343	GM	
	779 4218	LANCIA		93 177 343	VAUXHALL	
410514.88D	6065 3946	FIAT	410590.88D	93 19 3581	GM	
	6081 4382	FIAT		4678 5392	FIAT	
410515.88D	4641 7962	FIAT	410591.88D	6066 3619	ALFA ROMEO	
410516.88D	779 1178	FIAT	410591.88D	4675 8586	FIAT	
410517.83D	11061-00QAB	NISSAN	410608.86D	50 409 6443 Kit	IVECO	
	11061-00QAC	NISSAN		592 1206	FIAT	
	44 08 928	OPEL	410705.89D	1336 Z0	CITROËN	
	44 32 983	OPEL		1336 Z0	PEUGEOT	
	82 00 074 349	RENAULT	410758.83D	96 472 659 80	PEUGEOT	
	82 00 674 369	RENAULT		50 10 295 225 2x Kit	RENAULT	
	91 160 168	GM	410763.82D	9849 8322 Kit	IVECO	
	93 198 017	GM		31293556	VOLVO	
410517.89D	11060-AW300	NISSAN	410765.90D ▲	11 53 7 601 158	BMW	
	11061-00QAD	NISSAN		410792.95D	11 53 1 247 125	BMW
	44 04 305	OPEL	11 53 1 432 881		BMW	
	82 00 074 346	RENAULT	11 53 1 739 755		BMW	
	82 00 674 368	RENAULT	410793.95D	11 51 7 500 597	BMW	
9 112 305	GM	410806.88D		PEL 000170	ROVER	
410518.89D	77 00 112 491	RENAULT	410808.88D	GTS 301	ROVER	
	77 01 474 248	RENAULT		PEL 10016	ROVER	
410520.92D ▲	708 3256	FIAT	410828.82D	50 00 684 865 Kit	RENAULT	
	93 275 736	GM		410828.82D0	50 00 684 865	RENAULT
	93235636	BUICK			410828.86D	50 00 691 267 Kit
410530.89D	77 00 109 641	RENAULT	410828.86D0	50 00 691 267	RENAULT	
	77 01 474 249	RENAULT				
410536.92D	03L 121 114 B	AUDI				
	03L 121 114 B	SEAT				
	03L 121 114 B	SKODA				
	03L 121 114 B	VOLKSWAGEN				
410537.92D	03L 121 113 B	AUDI				
	03L 121 113 B	SEAT				

Vergleichsliste | Cross References

Wahler-Nr Wahler-ref. Réf. Wahler	Hersteller-Nr. Manufacturer's Ref. Réf. Constructeurs	Hersteller Manufacturer Réf. Constructeur	Wahler-Nr Wahler-ref. Réf. Wahler	Hersteller-Nr. Manufacturer's Ref. Réf. Constructeurs	Hersteller Manufacturer Réf. Constructeur
410845.87D	03L 121 111 AE	AUDI	411040.83D	11060-00QAJ	NISSAN
	03L 121 111 AE	SEAT		82 00 400 553	RENAULT
	03L 121 111 AE	SKODA		82 00 558 751	RENAULT
	03L 121 111 AE	VOLKSWAGEN			
410845.92D	03L 121 111 R	AUDI	411042.89D	82 00 267 349	RENAULT
	03L 121 111 R	SEAT		82 00 558 766	RENAULT
	03L 121 111 R	SKODA	411043.89D	11060-BN700	NISSAN
	03L 121 111 R	VOLKSWAGEN		11061-00Q0E	NISSAN
	03L 121 111 S	AUDI		11061-00QAG	NISSAN
	03L 121 111 S	SEAT		11061-00QAL	NISSAN
	03L 121 111 S	SKODA		17690 84A00	SUZUKI
	03L 121 111 S	VOLKSWAGEN		17690-84A10	SUZUKI
410864.71D0	81.06401.0019	MAN	17690-84A11	SUZUKI	
	81.06401.0042	MAN	82 00 039 885	RENAULT	
410864.79D0	81.06401.0037	MAN	82 00 171 021	RENAULT	
	81.06401.0046	MAN	82 00 244 402	RENAULT	
410864.83D0	81.06401.0038	MAN	82 00 374 994	DACIA	
	81.06401.0045	MAN	82 00 374 994	RENAULT	
	9011 0080	DEUTZ-FAHR	82 00 558 783	DACIA	
			82 00 558 783	RENAULT	
410871.80D ▲	0489 2642 AC	CHRYSLER	82 00 954 285	RENAULT	
	5521 5006	ALFA ROMEO	411045.82D	50 10 284 184	RENAULT
	5521 5006	FIAT		657 GC 324 A-P80	MACK
410937.82D ▲	50 438 7382	IVECO	411133.80D	129 3885 / F75-85-95	DAF
				129 3885 / F75-85-95	PACCAR
410956.83D	777 3790	FIAT	411135.83D	168 4900 / CF 75	DAF
410989.80D	032 121 110 C	VOLKSWAGEN		168 4900 / CF 75	PACCAR
410989.87D	032 121 110 B	SEAT	411135.87D	166 1375 / CF 75	DAF
	032 121 110 B	SKODA		166 1375 / CF 75	PACCAR
	032 121 110 B	VOLKSWAGEN	411186.87D	06D 121 111 G	AUDI
	032 121 110 J	SEAT		06D 121 111 G	SEAT
	032 121 110 J	SKODA		06D 121 111 G	SKODA
	032 121 110 J	VOLKSWAGEN		06D 121 111 G	VOLKSWAGEN
410994.88D	4680 4764	FIAT	411187.87D	06F 121 111 F	AUDI
411004.80D	1 423 451	SCANIA		06F 121 111 F	SEAT
	1 799 757	SCANIA		06F 121 111 F	SKODA
	1 800 909	SCANIA		06F 121 111 F	VOLKSWAGEN
	1 849 060	SCANIA			
411039.83D	11061-00Q0D	NISSAN	411193.82D	12 61 5097	SAAB
	11061-00QAM	NISSAN		12 615 097	GM
	17690-84A50-000	SUZUKI		12 615 097	VAUXHALL
	82 00 244 023	RENAULT		12 62 2410	SAAB
	82 00 400 554	DACIA		12 622 410	GM
	82 00 400 554	RENAULT		12 622 410	VAUXHALL
	82 00 558 758	DACIA		13 38 007	OPEL
	82 00 558 758	RENAULT		13 38 008	OPEL
	82 00 954 288	DACIA		13 38 034	OPEL
	82 00 954 288	RENAULT		13 38 427	OPEL
				21 018 811	GM

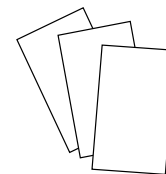

Wahler-Nr Wahler-ref. Réf. Wahler	Hersteller-Nr. Manufacturer's Ref. Réf. Constructeurs	Hersteller Manufacturer Réf. Constructeur	Wahler-Nr Wahler-ref. Réf. Wahler	Hersteller-Nr. Manufacturer's Ref. Réf. Constructeurs	Hersteller Manufacturer Réf. Constructeur	
411241.82D	21 018 811	VAUXHALL	411477.89D ▲	93 198 576	VAUXHALL	
	5177 0698	ALFA ROMEO		93 198 646	GM	
	7350 2809	FIAT		93 198 646	VAUXHALL	
	90 53 7453	SAAB				
	90 53 7811	SAAB		11 06 023 09R	RENAULT	
	90 537 453	GM		17690-84A51	SUZUKI	
	90 537 453	VAUXHALL		82 00 248 531	RENAULT	
	90 537 605	GM		82 00 558 779	RENAULT	
	90 537 605	VAUXHALL				
	90 537 811	GM		82 00 954 289	RENAULT	
411442.83D ▲	21200-ED000	NISSAN	4115.92D	13 38 046	OPEL	
	21200-ED00A	NISSAN		13 38 046	VAUXHALL	
	77 01 068 770	RENAULT		90 009 956	GM	
				90 009 956	VAUXHALL	
411475.89D ▲	11 06 030 26R	RENAULT	411545.82D ▲	90916-03079	LEXUS	
	11 06 055 36R	RENAULT		90916-03079	TOYOTA	
	11060-00Q0K	NISSAN		90916-03081	LEXUS	
	11060-00Q0S	NISSAN		90916-03081	TOYOTA	
	82 00 954 328	RENAULT				
	11060-00Q0C	NISSAN		11 53 1 436 042	BMW	
	11060-00Q0E	NISSAN		11 53 1 437 085	BMW	
	11060-00QAL	NISSAN				
	82 00 380 898	RENAULT		11 53 7 552 403	BMW	
	82 00 656 419	RENAULT				
411476.83D ▲	82 00 656 420	RENAULT	411573.105D ▲	166 203 00 75	MERCEDES-BENZ	
	82 00 699 392	RENAULT		166 203 01 75	MERCEDES-BENZ	
	82 00 703 139	RENAULT		166 203 02 75	MERCEDES-BENZ	
	82 00 801 570	RENAULT				
	82 00 801 571	RENAULT		266 203 02 75	MERCEDES-BENZ	
	82 00 801 571	RENAULT		266 203 04 75	MERCEDES-BENZ	
	82 00 907 229	RENAULT		266 203 06 75	MERCEDES-BENZ	
	82 00 907 234	RENAULT				
	11061-00Q0A	NISSAN		411574.102D ▲	1338 001	OPEL
	11061-00Q0B	NISSAN			1338 098	OPEL
11061-00Q0G	NISSAN	24 456 401	GM			
11061-00Q0K	NISSAN	24 456 401	VAUXHALL			
11061-00Q0L	NISSAN	6338 005	OPEL			
11061-00Q1B	NISSAN	6338 035	OPEL			
44 33 121	OPEL	640972	SAAB			
44 34 144	OPEL	90 536 262	GM			
44 34 190	OPEL	90 536 262	VAUXHALL			
44 49 134	OPEL	90 536 501	GM			
411579.92D ▲	44 49 506	OPEL	411577.80D ▲	90 536 501	VAUXHALL	
	82 00 403 437	RENAULT		93 181 245	GM	
	82 00 703 140	RENAULT		93 181 245	VAUXHALL	
	82 00 801 567	RENAULT				
	82 00 907 239	RENAULT		1338 004	OPEL	
	82 00 907 243	RENAULT		9158251	GM	
	93 198 035	GM				
	93 198 035	VAUXHALL				
	93 198 289	GM		4116.87D1	069 121 113	AUDI
	93 198 289	VAUXHALL			069 121 113	VOLKSWAGEN
93 198 317	GM	069 121 113 A	VOLKSWAGEN			
93 198 317	VAUXHALL	272 246	VOLVO			
93 198 576	GM	3 273 728	VOLVO			

Vergleichsliste | Cross References

Wahler-Nr Wahler-ref. Réf. Wahler	Hersteller-Nr. Manufacturer's Ref. Réf. Constructeurs	Hersteller Manufacturer Réf. Constructeur	Wahler-Nr Wahler-ref. Réf. Wahler	Hersteller-Nr. Manufacturer's Ref. Réf. Constructeurs	Hersteller Manufacturer Réf. Constructeur
4117.80D	002 203 75 75	MERCEDES-BENZ	4147.80D	90 264 080	VAUXHALL
	002 203 80 75	MERCEDES-BENZ		90 354 822	DAEWOO
	615 200 13 15	MERCEDES-BENZ			
	616 200 04 15	MERCEDES-BENZ		1 612 191	FORD
411715.84D ▲	21200-AA140	SUBARU		1337 64	PEUGEOT
	21200-AA160	SUBARU		1337 68	PEUGEOT
	21200-AA220	SUBARU		1338 20	PEUGEOT
	21200-AA230	SUBARU		1338 25	PEUGEOT
	21210-AA140	SUBARU		6 182 480	FORD
	21210-AA160	SUBARU		77 00 665 226	RENAULT
411716.88D ▲	21200-AA150	SUBARU		77 00 697 157	RENAULT
	21200-AA200	SUBARU		77 00 858 087	RENAULT
	21210-AA120	SUBARU	77 00 862 200	RENAULT	
	21210-AA150	SUBARU	93 501 145	CITROËN	
411743.82D ▲	21200-AA170	SUBARU	93 501 386	CITROËN	
	21210-AA080	SUBARU	96 090 230 80	PEUGEOT	
4122.87D	1337 34	PEUGEOT	96 159 513	CITROËN	
	273 480	VOLVO	GTS 303	LANDROVER	
	77 00 657 955	RENAULT	T 069 7157	CHRYSLER	
	77 00 703 136	RENAULT	T 069 7157	JEEP	
	77 00 710 657	RENAULT			
	77 01 349 173	RENAULT	51.06402.0042	MAN	
	77 01 349 415	RENAULT	51.06402.0052	MAN	
	79 102 461 13	PEUGEOT	51.06402.0057	MAN	
	79 102 471 16	PEUGEOT	51.06402.0062	MAN	
7910247116	LANCIA	51.06402.0065	MAN		
4123.70			51.06402.0068	MAN	
	076 121 113 A	VOLKSWAGEN			
			4150.71D50		
			4150.79D50		
			4150.83D50		
			4151.76D		
			4151.79D		
4123.80D	005 203 29 75	MERCEDES-BENZ	51.06402.0034	MAN	
	075 121 113 D	AUDI	51.06402.0043	MAN	
	075 121 113 D	SEAT	51.06402.0044	MAN	
	075 121 113 D	VOLKSWAGEN	51.06402.0049	MAN	
	1 018 799	FORD	51.06402.0049	MAN	
	1 032 249	FORD	51.06402.0050	MAN	
4126.88			51.06402.0051	MAN	
	90048-33029-000	DAIHATSU	51.06402.0053	MAN	
	90916-03043	TOYOTA	51.06402.0056	MAN	
4137.80D	90916-03062	TOYOTA	51.06402.0061	MAN	
	004 203 39 75	MERCEDES-BENZ	51.06402.0064	MAN	
	004 203 40 75	MERCEDES-BENZ	51.06402.0067	MAN	
4144.82D	116 200 03 15	MERCEDES-BENZ	51.06402.0069	MAN	
	13 38 059	OPEL	51.06402.0058	MAN	
	13 38 062	OPEL	51.06402.0060	MAN	
4144.92D	90 410 665	GM	51.06402.0063	MAN	
	90 443 473	GM	51.06402.0066	MAN	
	13 38 049	OPEL	44 00 106	OPEL	
			482 6602	FIAT	
			50 00 816 924	RENAULT	
			9 108 106	GM	
			9 108 106	VAUXHALL	
			730 3174	FIAT	
			730 3615	FIAT	
			730 3615	IVECO	
			471 6264	IVECO	

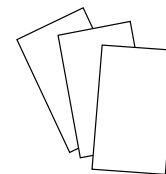

Wahler-Nr Wahler-ref. Réf. Wahler	Hersteller-Nr. Manufacturer's Ref. Réf. Constructeurs	Hersteller Manufacturer Réf. Constructeur	Wahler-Nr Wahler-ref. Réf. Wahler	Hersteller-Nr. Manufacturer's Ref. Réf. Constructeurs	Hersteller Manufacturer Réf. Constructeur
	480 7492	IVECO		9842 4854	IVECO
	483 1783	IVECO		9843 3497	IVECO
4154.82D	75 17 345	SAAB	4166.79D	480 4321	IVECO
	88 17 538	SAAB		9843 2310	IVECO
4154.88D	30 57 7561	SAAB	4168.92D	9846 7516	IVECO
	88 17 298	SAAB		13 38 060	OPEL
	88 22 025	SAAB	4174.79D	13 38 060	VAUXHALL
	91 66 687	SAAB		90 352 677	GM
	91 94 101	SAAB		45 00 823	OPEL
	91 94 242	SAAB		477 0246	IVECO
4155.87D	025 121 113 D	AUDI		482 3211	IVECO
	025 121 113 D	VOLKSWAGEN		483 7166	IVECO
	025 121 113 E	AUDI		77 01 042 512	RENAULT
	025 121 113 E	VOLKSWAGEN		809 6735	IVECO
	025 121 113 F	AUDI		9 161 123	GM
	025 121 113 F	VOLKSWAGEN		91 61 123	VAUXHALL
4158.80D	04778 975	CHRYSLER	4174.82D	9846 3637	FIAT
	13 38 466	OPEL		9846 3637	IVECO
	13 38 466	VAUXHALL		1338 90	CITROËN
	3 901 2004 F	VM		1338 90	PEUGEOT
	4778 975	CHRYSLER	4175.92D	5 0032 9622	FIAT
	7 072 643	FORD		50 032 9622	IVECO
	91 153 670	GM		13 38 067	OPEL
	91 153 670	VAUXHALL		13 38 067	VAUXHALL
	GTS 287	ROVER		13 38 084	OPEL
	PEL 10009 EVA	ROVER		13 38 084	VAUXHALL
	RTC 6673	LANDROVER		24 420 652	GM
	6051 6212	ALFA ROMEO		45 03 017	SAAB
4160.83D	928.106.129.06	PORSCHE		46 23 815	SAAB
	928.106.129.16	PORSCHE		90 410 897	GM
4161.83	928.106.129.17	PORSCHE	4176.80D	90 502 201	GM
	6131 6592	IVECO		003 203 98 75	MERCEDES-BENZ
4162.79D	6131 8373	IVECO		601 200 01 15	MERCEDES-BENZ
	9849 2868	IVECO		602 200 00 15	MERCEDES-BENZ
4163.74D	9849 2873	IVECO		603 200 00 15	MERCEDES-BENZ
	9842 0718	IVECO		606 203 01 75	MERCEDES-BENZ
4163.79D	9846 7517	IVECO	4176.85D	004 203 09 75	MERCEDES-BENZ
	13 38 050	OPEL		0820117806	MULTICAR
	13 38 057	OPEL		601 200 00 15	MERCEDES-BENZ
	13 38 057	VAUXHALL		606 203 02 75	CHEVROLET
4164.92D	13 38 063	OPEL		606 203 02 75	DAEWOO
	13 38 063	VAUXHALL		606 203 02 75	MERCEDES-BENZ
	90 220 435	GM	4177.92D	606 203 05 75	MERCEDES-BENZ
	90 354 822	GM		13 38 068	OPEL
	90 443 472	GM		13 38 068	VAUXHALL
	473 8169	IVECO		90 411 948	CHEVROLET
4165.79D				90 411 948	DAEWOO
				90 411 948	GM
				90 411 948	VAUXHALL

Vergleichsliste | Cross References

Wahler-Nr Wahler-ref. Réf. Wahler	Hersteller-Nr. Manufacturer's Ref. Réf. Constructeurs	Hersteller Manufacturer Réf. Constructeur	Wahler-Nr Wahler-ref. Réf. Wahler	Hersteller-Nr. Manufacturer's Ref. Réf. Constructeurs	Hersteller Manufacturer Réf. Constructeur
4177.92D	92 063 300	GM	4223.75D	1 431 979	SCANIA
	92 063 300	HOLDEN			
4178.92D	13 38 073	OPEL	4223.83D	1 358 995	SCANIA
	13 38 073	VAUXHALL		1 404 924	SCANIA
	90 412 901	GM		1 423 450	SCANIA
4180.82D	13 38 069	OPEL	4224.75D	1 458 198	SCANIA
	13 38 069	VAUXHALL			
	90 486 128	GM	4224.80D	1 347 594	SCANIA
	92 061 279	DAEWOO		1 404 925	SCANIA
4183.82D	13 38 080	OPEL	4231.80D	11 53 1 251 041	BMW
	90 501 699	GM		11 53 1 254 065	BMW
4183.92D	13 38 079	OPEL	4232.71	11 53 1 265 086	BMW
	13 38 079	VAUXHALL			
	90 501 081	GM	4232.80D	11 53 1 264 668	BMW
4188.92D	13 38 087	OPEL		11 53 1 265 085	BMW
	90 529 846	GM	4233.84D	003 203 82 75	MERCEDES-BENZ
	90 529 846	VAUXHALL		116 200 02 15	MERCEDES-BENZ
4189.87D	48 11 586	OPEL	4235.71D	11 53 1 466 174	BMW
	92 062 728	CHEVROLET			
	92 062 728	DAEWOO	4235.80D	11 53 1 710 953	BMW
	92 067 408	CHEVROLET		11 53 1 713 040	BMW
	92 067 408	DAEWOO	4236.88D	11 53 1 721 002	BMW
4193.92D	47 72 190	SAAB		11 53 1 721 003	BMW
	9 543 786	GM		11 53 7 511 580	BMW
4194.92D	13 38 478	OPEL	4236.92D	11 53 1 733 803	BMW
	92 063 300	GM		11 53 7 511 083	BMW
4198.92D	13 38 100	OPEL	4237.80D	11 53 1 727 145	BMW
	90 572 899	GM		11 53 2 243 126	BMW
	90 572 899	VAUXHALL		11 53 2 244 151	BMW
				11 53 2 246 199	BMW
4201.92D	13 38 009	OPEL		13 38 076	OPEL
	13 38 097	OPEL		13 38 076	VAUXHALL
	24 435 781	GM		90 509 110	GM
	24 435 781	VAUXHALL		90 509 110	VAUXHALL
	90 573 926	GM	4237.88D	11 53 2 246 825	BMW
	90 573 926	VAUXHALL			
4206.90D	272 335	VOLVO	4238.92D	11 53 1 712 043	BMW
	9 125 406	VOLVO		11 53 1 743 528	BMW
				11 53 1 743 542	BMW
4207.92D	13 38 002	OPEL	4242.92D	13 38 003	OPEL
	9 128 786	GM		9 129 907	GM
	91 28 786	VAUXHALL		91 29 907	VAUXHALL
4208.92D	13 38 331	OPEL	4246.80D	4652 5581	FIAT
	90 573 326	GM			
	90 573 326	VAUXHALL	4247.80D	4646 6123	FIAT

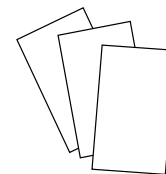

Wahler-Nr Wahler-ref. Réf. Wahler	Hersteller-Nr. Manufacturer's Ref. Réf. Constructeurs	Hersteller Manufacturer Réf. Constructeur	Wahler-Nr Wahler-ref. Réf. Wahler	Hersteller-Nr. Manufacturer's Ref. Réf. Constructeurs	Hersteller Manufacturer Réf. Constructeur	
4249.83D	996.106.013.54	PORSCHE	4256.92D50	6 058 444	FORD	
	996.106.013.55	PORSCHE		4264.84D	030 121 113	VOLKSWAGEN
	996.106.013.56	PORSCHE			030 121 113 B	AUDI
	996.106.013.57	PORSCHE			030 121 113 B	SEAT
	996.106.121.53	PORSCHE			030 121 113 B	VOLKSWAGEN
	996.106.125.52	PORSCHE				
4253.87D	032 121 113	SKODA	4264.87D		044 121 113	AUDI
	032 121 113	VOLKSWAGEN		044 121 113	SEAT	
	056 121 113	SKODA		044 121 113	SKODA	
	056 121 113	VOLKSWAGEN		044 121 113	VOLKSWAGEN	
	068 121 113 H	AUDI		056 121 113 D	AUDI	
	068 121 113 H	SEAT		056 121 113 D	SEAT	
	068 121 113 H	SKODA		056 121 113 D	SKODA	
	068 121 113 H	VOLKSWAGEN		056 121 113 D	VOLKSWAGEN	
4255.82D	08 966 483	GM	4269.78D	1 002 788	FORD	
	13 38 024	OPEL		1 031 881	FORD	
	13 38 024	VAUXHALL		1 096 699	FORD	
4255.87D	08 966 485	GM		4008540	MULTICAR	
	08 966 485	VAUXHALL		69015347	HAKO	
	13 38 033	OPEL		95VW 8575 AB	FORD	
	13 38 033	VAUXHALL		95VW 8575 AC	FORD	
4255.92D	13 38 038	OPEL	4270.88D	19300-PE0-013	HONDA	
	13 38 038	VAUXHALL		19300-PE0-024	HONDA	
	90 067 918	GM		19300-PLZ-004	HONDA	
	90 067 918	VAUXHALL				
4256.71	056 121 113 E	VOLKSWAGEN		1 001 993	FORD	
	068 121 113 A	VOLKSWAGEN		1 663 819	FORD	
4256.80D				6 153 501	FORD	
				6 588 962	FORD	
				6 866 389	FORD	
	056 121 113 A	AUDI		89FF 8575 AA	FORD	
	056 121 113 A	VOLKSWAGEN		89TM 8575 AA	FORD	
	4 N 6958	CATERILLAR		928M 8575 AE	FORD	
	4 N 6959	CATERILLAR	4272.90D	948M 8575 AA	FORD	
	9 L 9119	CATERILLAR		271 417	VOLVO	
	9 L 9652	CATERILLAR		271 664	VOLVO	
	9 N 5020	CATERILLAR		74 31 397 947	RENAULT	
9 N 5065	CATERILLAR	74 36 842 409	RENAULT			
9 N 5121	CATERILLAR	74 39 180 811	RENAULT			
9 N 5488	CATERILLAR	9 180 811	VOLVO			
4256.80D60	944.106.129.05	PORSCHE	4274.82D	077 121 113 C	AUDI	
				077 121 113 C	VOLKSWAGEN	
4256.83D60	037 121 113	VOLKSWAGEN	4274.87D	077 121 113	AUDI	
	944.106.019.00	PORSCHE		077 121 113	SKODA	
	944.106.129.05	PORSCHE		077 121 113	VOLKSWAGEN	
4256.87D50	0 801 587	FORD		077 121 113 B	AUDI	
	6 100 372	FORD		077 121 113 B	SKODA	
	6 106 381	FORD		077 121 113 B	VOLKSWAGEN	
	6 124 378	FORD		077 121 113 B	VOLKSWAGEN	
	6 176 366	FORD		078 121 113	SKODA	
	84FF 8575 BA	FORD		078 121 113	VOLKSWAGEN	
	SE 021 032 221 B	SEAT		078 121 113 C	AUDI	

Vergleichsliste | Cross References

Wahler-Nr Wahler-ref. Réf. Wahler	Hersteller-Nr. Manufacturer's Ref. Réf. Constructeurs	Hersteller Manufacturer Réf. Constructeur	Wahler-Nr Wahler-ref. Réf. Wahler	Hersteller-Nr. Manufacturer's Ref. Réf. Constructeurs	Hersteller Manufacturer Réf. Constructeur
4274.87D	078 121 113 C	SKODA	4368.87	63 38 050	OPEL
	078 121 113 C	VOLKSWAGEN		7173 9800	FIAT
	078 121 113 F	AUDI			
	078 121 113 F	SKODA		311.00.06.0065	STEYR
	078 121 113 F	VOLKSWAGEN			
	078 121 113 J	AUDI		81.06401.6002	MAN
	078 121 113 J	SKODA			
	078 121 113 J	VOLKSWAGEN		4414.87D	111 200 17 15
4274.92D	078 121 113 G	AUDI	4428.92D	111 203 10 75	MERCEDES-BENZ
	078 121 113 H	AUDI		63 38 004	OPEL
4275.87D	00A 121 113	VOLKSWAGEN	4430.87D	070 121 114	VOLKSWAGEN
	111 200 09 15	MERCEDES-BENZ	4431.105D		
	111 203 02 75	MERCEDES-BENZ		13 38 178	OPEL
	111 203 06 75	MERCEDES-BENZ		24 405 922	GM
	111 203 08 75	MERCEDES-BENZ		24 405 922	VAUXHALL
		55 577 072		GM	
4276.87D	110 200 03 15	DAEWOO		55 577 072	VAUXHALL
	111 200 03 15	MERCEDES-BENZ		63 38 018	OPEL
	111 203 03 75	MERCEDES-BENZ		7174 4389	FIAT
4278.80D	119 200 00 15	MERCEDES-BENZ		7177 0832	FIAT
	119 203 01 75	MERCEDES-BENZ		9 698 4104	CHEVROLET
4279.87D	111 200 08 15	MERCEDES-BENZ	4433.92D	13 38 017	OPEL
	111 203 05 75	MERCEDES-BENZ		24 447 862	GM
4280.80D	603 203 04 74	MERCEDES-BENZ	4434.80D	24 447 862	VAUXHALL
	605 203 00 75	MERCEDES-BENZ			
4280.85D	603 203 04 74	MERCEDES-BENZ	4436.80D	772 1399	FIAT
	604 203 00 75	MERCEDES-BENZ	4446.83D		
4281.87D	112 200 00 15	MERCEDES-BENZ		777 0236	FIAT
	112 203 02 75	MERCEDES-BENZ		1338 23	CITROËN
	5098 918 AA	CHRYSLER		1338 23	PEUGEOT
4297.92D	13 38 015	OPEL		17570-86CA0	SUZUKI
	24 420 728	GM		17670-66G00	SUZUKI
	24 420 728	VAUXHALL		21215-13060-15	LADA
				25511-29000	HYUNDAI
4298.87D	112 200 01 15	MERCEDES-BENZ		77 00 868 274	RENAULT
	112 203 03 75	MERCEDES-BENZ		77 01 038 494	RENAULT
4309.92D	628 203 01 75	MERCEDES-BENZ	4447.80D	96 160 901	CITROËN
				9616 0901 80	FIAT
4326.97D	11 53 0 139 877	BMW		9616 0901 80	LANCIA
	11 53 1 436 823	BMW		SU001-0223	TOYOTA
	11 53 1 437 040	BMW			
	11 53 7 509 227	BMW			
4337.105D	11 53 7 510 959	BMW	4447.85D	1338 13	PEUGEOT
				1338 71	CITROËN
4351.79	114 470	VALTRA		1338 71	PEUGEOT
	9 225 0 757 014 6	MWM		96 058 051	CITROËN
4357.92D	24 435 102	SAAB	4449.84D	96 272 814 80	PEUGEOT
				77 00 260 959	RENAULT

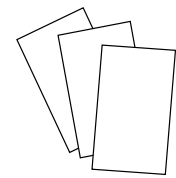

Wahler-Nr Wahler-ref. Réf. Wahler	Hersteller-Nr. Manufacturer's Ref. Réf. Constructeurs	Hersteller Manufacturer Réf. Constructeur	Wahler-Nr Wahler-ref. Réf. Wahler	Hersteller-Nr. Manufacturer's Ref. Réf. Constructeurs	Hersteller Manufacturer Réf. Constructeur		
4450.83D	1338 39	CITROËN	4490.87D	642 200 02 15	MERCEDES-BENZ		
	1338 39	PEUGEOT		642 200 20 15	MERCEDES-BENZ		
	96 160 902 80	PEUGEOT	4508.105D	11 53 7 502 779	BMW		
	9616 0902 80	FIAT		11 53 7 586 885	BMW		
4450.89D	1338 26	CITROËN	4516.70D	11 53 7 586 885	ROLLS-ROYCE		
	1338 26	PEUGEOT		11 53 1 731 486	BMW		
	96 108 092	CITROËN	4516.85D	11 53 1 710 056	BMW		
	96 108 092 80	PEUGEOT		11 53 1 720 033	BMW		
	96 108 093 80	PEUGEOT		11 53 1 720 306	BMW		
4455.80D	022 121 113	AUDI	4517.87D	11 53 1 729 720	BMW		
	022 121 113	VOLKSWAGEN		11 53 1 729 841	BMW		
	955.106.113.00	PORSCHE		120 200 00 15	MERCEDES-BENZ		
4457.82D	1 007 754	FORD	4519.95D	120 203 02 75	MERCEDES-BENZ		
	1 211 553	FORD		11 53 1 702 279	BMW		
	1 303 374	FORD	4520.75	1 395 856	SCANIA		
	1E05-15-171 A	MAZDA		6 052 5 010 005 0	MWM		
	96MM 8575 A1A	FORD		4520.80D	0303.191.04	NEOPLAN	
	96MM 8575 BD	FORD	2 832 814		SCANIA		
	96MM 8575 BE	FORD	283 281		SCANIA		
	4459.92D	12 992 692	GM	4529.70	2871 591 M	KOMATSU	
13 38 096		OPEL	550 275		SCANIA		
13 38 096		VAUXHALL	609E060013		STEYR		
63 38 028		OPEL	00 24 774 033		RENAULT		
90 570 620		GM	4529.83D0		50 00 694 785	RENAULT	
90 570 620		VAUXHALL			4530.80	154.0943.426	SAURER
005 203 59 75		MERCEDES-BENZ			2872 578 M	KOMATSU	
4480.82D	90916-03075	TOYOTA	4572.105D	738 0513	LIEBHERR		
	90916-03084	TOYOTA		07Z 121 111	VOLKSWAGEN		
	90916-03125	TOYOTA		4588.75/1	149 620	VALTRA	
	90916-03129	TOYOTA	9 229 8 757 004 6		MWM		
	90916-03133	TOYOTA	4594.90D		11 53 1 704 704	BMW	
	90916-03136	TOYOTA		4596.83D	50 10 295 225	RENAULT	
	90916-03140	TOYOTA			271990009-00	BUGATTI	
	90916-03144	LEXUS	4618.70		27199003-00	BUGATTI	
	90916-03144	TOYOTA		4618.82	005 203 17 75	MERCEDES-BENZ	
	90916-03145	LEXUS			1 661 993	VOLVO	
	90916-03145	TOYOTA	4619.75		222730	PEGASO	
	90916-A3001	TOYOTA		770662	PEGASO		
	90916-A3002	TOYOTA		4619.80	005 203 18 75	MERCEDES-BENZ	
	90916-A3003	TOYOTA	075 0562		DAF		
	1 306 004	FORD	4483.82D				
1 712 228	FORD						
30 711 624	VOLVO						
4488.80D0	4M5G 8575 ZA	FORD					
	4M5G 8575 ZB	FORD					
	07K 121 113 B	VOLKSWAGEN					
4489.90D	3071 3572	VOLVO					

Vergleichsliste | Cross References

Wahler-Nr Wahler-ref. Réf. Wahler	Hersteller-Nr. Manufacturer's Ref. Réf. Constructeurs	Hersteller Manufacturer Réf. Constructeur	Wahler-Nr Wahler-ref. Réf. Wahler	Hersteller-Nr. Manufacturer's Ref. Réf. Constructeurs	Hersteller Manufacturer Réf. Constructeur
4619.80	11 53 1 312 288	BMW	4639.82D	17670-77E10	SUZUKI
	11 53 1 315 063	BMW		17670-77E11	SUZUKI
	295 024	DAF		1A51-15-171	MAZDA
	750 562	DAF		3 396 924	FORD
4619.82	1 544 683	VOLVO	4814.92D	3 599 763	FORD
	50 01 855 520	RENAULT		3 893 570	FORD
	8 149 182	VOLVO		3 902 514	FORD
4619.86	005 203 19 75	MERCEDES-BENZ	4816.90D	4 176 181	FORD
	1 665 694	VOLVO		4 188 498	FORD
	50 10 447 161	RENAULT		8AGX-15-171	MAZDA
	50 10 553 100	RENAULT		F42Z 8575 BA	FORD
	50 409 6443	IVECO		FS05-15-171	MAZDA
	8 149 186	VOLVO		KL01 15 171 A	FORD
	8929878	DETROIT DIESEL		KL01-15-171	MAZDA
	9943 1512	IVECO		KL01-15-171 A	MAZDA
4621.80D	11 53 1 318 274	BMW	4817.90D	XM34 8575 AA	FORD
	4622.82D0	9849 8322		IVECO	XM34 8575 AB
4630.87D ▲	5175583AB	JEEP		4818.90D	06C 121 111 C
	642 200 03 15	MERCEDES-BENZ	06C 121 111 D		VOLKSWAGEN
4634.76	21200-77A00	NISSAN	4820.87D		06C 121 111 E
	21200-77A60	NISSAN		3063 7217	VOLVO
	21200-77A61	NISSAN		3065 0022	VOLVO
	21200-77A63	NISSAN	3077 7475	VOLVO	
4637.76D	MD 164541	MITSUBISHI	4821.89D	3129 3699	VOLVO
	MD 170031	MITSUBISHI		3063 7216	VOLVO
	MD 317015	MITSUBISHI		3065 0023	VOLVO
	MD 345617	MITSUBISHI		3121 9205	VOLVO
	ME 190303	MITSUBISHI		3065 0469	VOLVO
	ME 191593	MITSUBISHI		3077 7476	VOLVO
4637.82D	ME 200262	MITSUBISHI	4825.98D	3129 3698	VOLVO
	30874021	VOLVO		03G 121 111 A	AUDI
	30875350	VOLVO		03G 121 111 A	SEAT
	MD 158570	MITSUBISHI		03G 121 111 A	SKODA
	MD 165630	MITSUBISHI		03G 121 111 A	VOLKSWAGEN
	MD 175746	MITSUBISHI		03G 121 113 A	AUDI
	MD 310106	MITSUBISHI		03G 121 113 A	SEAT
	MD 315301	MITSUBISHI		03G 121 113 A	SKODA
	MD 335170	MITSUBISHI		03G 121 113 A	VOLKSWAGEN
	MD 337408	MITSUBISHI		1338 21	CITROËN
	MD 338234	MITSUBISHI		1338 21	PEUGEOT
4638.76D	MD 360320	MITSUBISHI	1338 C8	PEUGEOT	
	MD 997605	MITSUBISHI	21200-6F900	NISSAN	
4638.82D	MD 015299	MITSUBISHI	21200-6F901	NISSAN	
	MD 094120	MITSUBISHI	96 006 231	CITROËN	
	MD 997224	MITSUBISHI	GTS 299	ROVER	
	MD 997606	MITSUBISHI	PEL 10019 EVA	ROVER	
	ME 999295	MITSUBISHI	1 345 512	FORD	
			1 351 716	FORD	
			4M5G 6L721 GA	FORD	
			4M5G 6L721 GB	FORD	

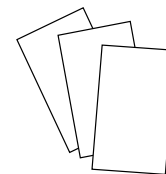

Wahler-Nr Wahler-ref. Réf. Wahler	Hersteller-Nr. Manufacturer's Ref. Réf. Constructeurs	Hersteller Manufacturer Réf. Constructeur	Wahler-Nr Wahler-ref. Réf. Wahler	Hersteller-Nr. Manufacturer's Ref. Réf. Constructeurs	Hersteller Manufacturer Réf. Constructeur			
4829.100D ▲	272 200 06 15	MERCEDES-BENZ		6 077 896	FORD			
	273 200 01 15	MERCEDES-BENZ		6 077 897	FORD			
	273 200 04 15	MERCEDES-BENZ		6 077 898	FORD			
4832.87D ▲	642 200 07 15	MERCEDES-BENZ		6 077 985	FORD			
				823 959 481 G	AUDI			
4833.100D	272 200 05 15 273 200 02 15 6801 3949 AA	MERCEDES-BENZ MERCEDES-BENZ CHRYSLER		823 959 481 G	SEAT			
				823 959 481 G	SKODA			
				823 959 481 G	VOLKSWAGEN			
4834.100D	272 200 00 15 272 200 01 15 272 200 04 15	MERCEDES-BENZ MERCEDES-BENZ MERCEDES-BENZ		823 959 481 H	SKODA			
				823 959 481 H	VOLKSWAGEN			
				823 959 481 K	SKODA			
4835.87D	642 200 02 15 642 200 04 15	MERCEDES-BENZ MERCEDES-BENZ		823 959 481 K	VOLKSWAGEN			
				90 108 636	GM			
6010.75D	113 095 075 217.87.71 84247900	SKODA STEYR INTER. HARV. IHC		90 108 636	VAUXHALL			
				95 26 518	SAAB			
6010.88D	115 095 070 547 4546 5474546 5474546 6 144 361 85 47 572	SKODA FIAT CITROËN PEUGEOT FORD SAAB		6016.92	595 1985	FIAT		
				6017.95D	595 1987	FIAT		
				6010.92D	113 095 090 2828 6103 411 4572 423 5333 423 5533 424 0878 426 3597 823 959 481 823 959 481 823 959 481 823 959 481 A 823 959 481 A 823 959 481 A 823 959 481 A 823 959 481 F 823 959 481 F 823 959 481 F 823 959 481 L 823 959 481 L 823 959 481 L 85 69 23 944.606.481.00	SKODA FIAT FIAT FIAT FIAT FIAT FIAT AUDI SEAT VOLKSWAGEN AUDI SEAT VOLKSWAGEN AUDI SEAT VOLKSWAGEN AUDI SEAT VOLKSWAGEN SEAT SEAT VOLKSWAGEN AUDI SEAT VOLKSWAGEN SEAT SEAT VOLKSWAGEN SAAB PORSCHÉ	191 959 481 A	AUDI
							191 959 481 A	SEAT
							191 959 481 A	VOLKSWAGEN
							191 959 481 C	AUDI
191 959 481 C	SEAT							
191 959 481 C	VOLKSWAGEN							
6010.95D	13 41 002 13 41 002 426 3997 434 0878 6 072 016 6 077 895	OPEL VAUXHALL AUTOBIANCHI FIAT FORD FORD		251 959 481	AUDI			
				251 959 481	SEAT			
				251 959 481	VOLKSWAGEN			
				321 959 481 A	AUDI			
				321 959 481 A	SEAT			
				321 959 481 A	VOLKSWAGEN			
				321 959 481 C	AUDI			
			321 959 481 C	SEAT				
			321 959 481 C	VOLKSWAGEN				
			321 959 481 D	AUDI				
			321 959 481 D	SEAT				
			321 959 481 D	VOLKSWAGEN				
6020.92D	823 959 481 823 959 481 823 959 481 823 959 481 A 823 959 481 A 823 959 481 A 823 959 481 A 823 959 481 F 823 959 481 F 823 959 481 F 823 959 481 L 823 959 481 L 823 959 481 L 85 69 23 944.606.481.00	AUDI SEAT VOLKSWAGEN AUDI SEAT VOLKSWAGEN AUDI SEAT VOLKSWAGEN AUDI SEAT VOLKSWAGEN SAAB PORSCHÉ	441 044 330 186	SKODA				
			6U0 959 481 A	AUDI				
			6U0 959 481 A	SEAT				
			6U0 959 481 A	VOLKSWAGEN				
			6020.95D	SE 021 952 600 A	SEAT			
			6020.95D	191 959 481 B	AUDI			
6024.95D	13 41 002 13 41 002 426 3997 434 0878 6 072 016 6 077 895	OPEL VAUXHALL AUTOBIANCHI FIAT FORD FORD	191 959 481 B	SEAT				
			191 959 481 B	VOLKSWAGEN				
			321 959 481 B	VOLKSWAGEN				
			321 959 481 E	AUDI				
			321 959 481 E	VOLKSWAGEN				
			321 959 481 G	VOLKSWAGEN				
6010.95D	13 41 002 13 41 002 426 3997 434 0878 6 072 016 6 077 895	OPEL VAUXHALL AUTOBIANCHI FIAT FORD FORD	811 959 481	AUDI				
			811 959 481	VOLKSWAGEN				
			893 959 481	AUDI				
			893 959 481	VOLKSWAGEN				

Vergleichsliste | Cross References

Wahler-Nr Wahler-ref. Réf. Wahler	Hersteller-Nr. Manufacturer's Ref. Réf. Constructeurs	Hersteller Manufacturer Réf. Constructeur
6031.100D	13 41 011	OPEL
	13 41 011	VAUXHALL
	90 242 277	GM
	90 242 277	VAUXHALL
6031.105D	13 41 017	OPEL
	13 41 017	VAUXHALL
	90 277 288	GM
	90 277 288	VAUXHALL
6031.88D	1264 50	PEUGEOT
	13 0707 7080	FIAT
	13 41 028	OPEL
	13 41 028	VAUXHALL
	90 357 303	GM
	90 357 303	VAUXHALL
6031.92D	1264 32	PEUGEOT
	1264 50	PEUGEOT
	599 2746	FIAT
	6056 4101	FIAT
	6080 8223	FIAT
	774 8867	FIAT
	8242 0013	FIAT
	8243 6410	FIAT
	8246 5533	FIAT
	8247 7919	FIAT
907 0701	FIAT	
6031.97D	4652 0219	FIAT

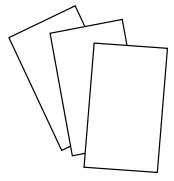

Wahler-Nr Wahler-ref. Réf. Wahler	Dichtung Gasket Joint	Wahler-Nr Wahler-ref. Réf. Wahler	Dichtung Gasket Joint	Wahler-Nr Wahler-ref. Réf. Wahler	Dichtung Gasket Joint
100456D5	100456	3119.88D5	100601	4038.71D	104224
102543D5	102543		100607	4038.76D	104224
110156D5	110156	3119.92D3	100599	4038.81D	104224
110392D5	110392		100600	4049.80D	002085
115600D5	115600	3136.82D50	002154	4049.80D1	002479
117385D5	117385		105433	4049.87D	002085
3004.82D1	002149	3136.88D50	002154	4064.75D	002085
3004.88D1	002149		105433	4078.65D	002085
3004.92D1	002149	3141.87D	002138	4078.71D	002085
3017.87D2	003187	3142.90D	102642	4078.75D	002085
3017.87D50	002137	3143.87D	102725	4078.79D	002085
	002150	3145.79D	108476	4078.87D	002085
3017.92D2	003187	3146.90D	102642	4078.92D	002085
3017.92D50	002137	3151.87D	003062	4083.83D50	002892
	002150	3159.82D	003594		002922
3021.88D50	002153	3163.88D	104360	4088.80D	002085
	002163	3164.88	104360	4088.87D	002085
	002164	3166.89D	105317	4089.71D	003192
	002523	3167.83D	102725	4089.82D	003192
3021.92D50	002153	3169.79D	119164	4089.87D	003192
	002163	3171.82D	119081	4089.92D	003192
	002164	3174.89D	105571	4091.82D	116692
	002523	3300.80D	104361		116693
3023.87D	002160	3301.80D	104361	410007.87D	003588
3033.78D	120675	3302.80D	104361	410048.88D	109953
3033.84D	120675	3355.80D	003587	410049.88D	109944
3044.90D1	100595	3356.80D	003590	410055.87D	114270
3054.87D50	002143	3360.87D	003588		114365
	002153	3361.87D	003588	410058.84D	114419
3054.92D50	002143	3373.80D	003587	410075.79D	119164
	002153	3383.87	108485	410081.79D	119164
3091.92D	002137	3431.80D	104361	410090.88D	112151
3100.88D	102511	3457.90D	114432	410131.88D	102511
3100.92D	102511		114433	410171.87D	104738
3103.79	003602	3466.89D	105414	410174.92D	104738
3105.87D	003062	3467.85D	114595	410178.82D	114229
3109.82D	003592	3469.91D	105414	410181.82D	115702
3109.87D	003592	3470.89D50	105434	410183.82D	118938
3116.82D	120392		105435		118939
3116.89D	120392	3472.87D	002138	410183.88D	118938
3118.82D1	100596	3477.88D	115864		118939
	100597	3478.82D	115422	410201.80D	115864
	100606	3481.88D	104360	410224.78D	115423
3118.88D1	100596	3484.87D	108485	410224.82D	115423
	100597	3485.87D	108485	410228.82D	100596
	100606	3498.88D	100599	410230.78D	116903
3118.92D1	100596	3499.82D	100599	410262.91D	114731
	100597	3499.88D	100599	410263.91D	114731
	100606	4006.82D	002138	410289.81D	120389
3119.82D3	100599	4007.80D	110991	4103.82D	115422
	100600	4008.74D	003594	410348.82D	117136
3119.82D4	100605	4008.79D	003594		118913
3119.82D5	100601	4022.82D	003192	410352.82D	100599
	100607	4022.82D1	003595	410352.88D	100599
3119.88D3	100599	4022.88D	003192	410389.103D	116490
	100600	4022.92D	003192		118342
3119.88D4	100605	4033.82D	002144	410475.80D	102725
		4038.65D	104224	410475.87D	102725

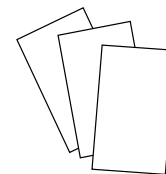

Wahler-Nr Wahler-ref. Réf. Wahler	Dichtung Gasket Joint	Wahler-Nr Wahler-ref. Réf. Wahler	Dichtung Gasket Joint	Wahler-Nr Wahler-ref. Réf. Wahler	Dichtung Gasket Joint
410488.88D	003192	4115.92D	002900	4201.92D	104892
4105.65D	002892	411545.82D	115864	4206.90D	100928
4105.71D	002892	4116.87D1	102081		101313
4105.75D	002892	4117.80D	002085	4207.92D	104892
4105.79D	002892	411715.84D	116903	4208.92D	102543
4105.83D	002892	411716.88D	116903	4223.75D	122689
410513.88D	003123	411743.82D	116903	4223.83D	122689
410514.88D	003123	4122.87D	002898	4224.75D	122690
410515.88D	003123	4123.80D	102081	4224.80D	122690
410516.88D	003123	4132.74D	002817	4231.71D	002140
410537.92D	002138	4137.71D	002085	4231.80D	002140
410590.88D	003123	4137.80D	002085	4231.84D	002140
410608.86D	118996	4144.82D	101973	4232.80D	002085
	119078	4144.92D	101973	4233.80D	002430
	119080	4147.80D	002898	4233.84D	002430
	120213	4150.71D50	002892	4235.71D	002085
	4619.86		106244	4235.75D	002085
410692.71D	119879	4150.79D50	002892	4235.80D	002085
	119880		106244	4236.88D	002085
410758.83D	120299	4150.83D50	002892	4236.92D	002085
	4596.83		106244	4237.80D	002085
410763.82D	003896	4151.76D	120392	4237.88D	002085
	120329	4151.79D	120392	4238.92D	002085
	120330	4152.79D	002817	4242.92D	102543
	4622.82D0	4154.82D	003192	4246.80D	104361
410765.90D	120222	4154.88D	003192	4247.80D	104361
410806.88D	120763	4155.87D	102081	4249.71D	106281
410808.88D	120763	4158.80D	002817	4249.83D	106281
410828.82D	121904	4160.83D	003052	4253.87D	002138
	122345	4162.79D	120392	4255.82D	003561
410828.86D	121904	4163.74D	002817	4255.87D	003561
	122345	4163.79D	102226	4255.92D	003561
410845.87D	120086	4164.92D	101973	4256.80D	002138
410845.92D	120086	4165.79D	102226	4256.80D60	000232
410871.80D	112151	4166.79D	002817		003602
	127334		102226	4256.83D60	003602
410937.82D	119081	4168.92D	101973		120392
410989.80D	124401	4174.79D	003595	4256.87D50	002138
410989.87D	124401		120392		002147
410994.88D	003123	4174.82D	003595		002148
411004.80D	122690		120392	4256.92D50	002138
411045.82D	121908	4174.88D	003595		002147
411133.80D	123872		120392		002148
	123873	4175.92D	100008	4264.84D	002138
	4619.80	4176.70D	002584	4264.87D	002138
411135.83D	123747	4176.75D	002584	4269.78D	115423
	123748	4176.80D	002584	4270.88D	102511
	411089.83D	4176.85D	002584	4272.90D	003192
411135.87D	123747	4177.92D	100007	4274.82D	102081
	123748	4178.92D	101973	4274.87D	102081
	411089.87D	4180.82D	101973	4274.92D	102081
411186.87D	120086	4183.82D	100007	4275.87D	002085
	127069	4183.92D	100007	4276.87D	002085
	127070	4188.92D	104892	4278.80D	102084
411187.87D	120086	4189.87D	100007	4279.87D	002085
	127069	4193.92D	104892	4280.80D	003650
	127070	4194.92D	100007	4280.85D	003650
4112.79D	002892	4198.92D	104892	4281.87D	003658

Wahler-Nr Wahler-ref. Réf. Wahler	Dichtung Gasket Joint	Wahler-Nr Wahler-ref. Réf. Wahler	Dichtung Gasket Joint	Wahler-Nr Wahler-ref. Réf. Wahler	Dichtung Gasket Joint
4297.92D	104892	6010.88D	002358	7187D	101561
4298.87D	003658	6010.92D	002358		115600
4309.92D	101642	6010.95D	002358	7188D	115599
4357.92D	104385	6017.85D	002358	7206D	101541
4414.87D	002085	6017.95D	002358		117943
4428.92D	104892	6020.92D	002358		117944
4430.87D	115028	6020.95D	002358	7211D	115599
4431.105D	104385	6024.95D	002358	7220D	117943
4433.92D	104892	6031.100D	002358		117944
4434.80D	104361	6031.105D	002358	7223D	110156
4436.80D	104361	6031.88D	002358	7234D	115618
4446.83D	105410	6031.92D	002358		115619
4447.80D	002898	6031.97D	002358	7241D	100456
4447.85D	002898	60347D	123800		115600
4449.84D	002898		123801	7256D	120620
4450.83D	105410	6035.92D	002358	7268D	111127
4450.89D	105410	60364D	117385		117420
4455.80D	102081	6037.81D	002358		117421
4457.82D	105686	6037.87D	002358	7271D	103995
	106503	6037.95D	002358		115600
4459.92D	102322	60375D	115586	7283D	100456
4472.83D	002892	6039.95D	002358	7293D	100456
4480.82D	114229	60409D	115600	7294D	100456
4483.82D	106307		117385		115600
	106503	60415D	123800		117385
4489.90D	108431	60579D	126105	7301D	117385
4490.87D	117217	60595D	101541	7327D	110156
4508.105D	100532		102241		115600
4516.70D	104887		117943		117385
4516.85D	104887	60633D	115600	7350D	118533
4517.87D	002085		117385	7353D	103046
4519.95D	104887	60700D	115600	7371D	110156
4520.80D	104470		117385		115600
4572.105D	120626	60702D	115600	7372D	110156
4594.90D	003562		117385		115600
4596.83D	120298	60777D	115600D5		117385
4621.80D	101216		117385	7375D	115593
4630.87D	117217	6087.87D	002358	7389D	103046
4638.76D	111209	61010D	115600	7396D	121743
4638.82D	111209	61384D	117385		121747
4814.92D	103394	665104D	115600D5	7451D	110156
4816.90D	114704	665574D	100456		117385
4817.90D	114704		102543	7496D	102543
4818.90D	114704		110156		110156
4820.87D	002138		110392		115600
4821.89D	109319		115600	7497D	118533
4829.100D	110657		117385		118534
4832.87D	114270	710023D	103046	7504D	110221
	117217	710073D	110221	7523D	118530
4833.100D	110657	710095D	106306	7527D	106306
4834.100D	110657	710327D	103386	7529D	110392
	111203	710476D	123589	7545D	108551
4835.87D	117217	710559D	127104	7556D	108056
6010.100D	002358	710571D	110392	7557D	108056
6010.70D	002358	710572D	110392	7574D	117948
6010.75D	002358	710574D	115600		126163
6010.82D	002358		127082	7610D	123590
6010.85D	002358	7159D	115586	7625D	103046

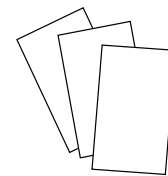

Wahler-Nr Wahler-ref. Réf. Wahler	Dichtung Gasket Joint
--	--------------------------------------

7631D	118493 118532 118533
--------------	----------------------------

7645D	106306
--------------	--------

7649D	101953 115600
--------------	------------------

7650D	101953 117385
--------------	------------------

Wahler-Nr Wahler-ref. Réf. Wahler	Dichtung Gasket Joint	Wahler-Nr Wahler-ref. Réf. Wahler	Dichtung Gasket Joint
003602	120392	4565.80	4565.80/2
100928	120389	4570.80	4684.80/1
104360	003123	4596.83	4596.83D
115600	115600D5	4622.82	4622.82D0
117385	117385D5	4663.80/1	410864.79D0
2383.75	2391.75	4665.80/1	4684.80/1
3000.70	3000.75	4684.70/1	410864.71D0
3004.88	3004.88D1	4684.80/1	410864.79D0
3021.88	3021.88D50	4684.83/1	410864.83D0
3029.72	3029.78	4689.97	4689.97D0
3033.78	3033.78D	4689.97D0	410086.97D0
3033.84	3033.84D	6035.92	6035.92D
3044.90	3044.90D1		
3053.72	3053.75		
3053.78	3053.75		
3054.92D	3054.92D50		
3118.82	3118.82D1		
3118.88	3118.88D1		
3118.92	3118.92D1		
3119.92	3119.92D3		
3347.80	3343.80D		
3391.92D	4459.92D		
4069.75/1	4083.79		
4083.71	4105.71D		
4083.71D1	4105.71D		
4083.79	4105.79D		
4083.83	4105.83D		
4089.87	4089.87D		
4089.92	4089.92D		
4091.82	4091.82D		
410044.82D	410231.82D		
410069.82D	410937.82D		
410176.82	410176.82D0		
410176.88	410176.88D0		
4103.82	4103.82D		
410695.105D	411059.105D		
4112.79D	4150.79D50		
4116.87D	4116.87D1		
4160.83	4160.83D		
4165.79	4165.79D		
4166.79	4166.79D		
4238.92D	4236.92D		
4269.78	4269.78D		
4340.80	4341.80		
4371.80	4351.79		
4378.80	4341.80		
4379.80	4351.79		
4417.81D	410289.81D		
4453.87D	410171.87D		
4488.80	4488.80D0		
4523.75	4520.75		
4523.80	4520.80D		
4546.80	4565.80		
4546.80	4565.80/2		
4547.70	4565.70		
4547.80	4565.80		
4547.80	4565.80/2		

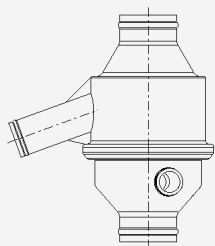
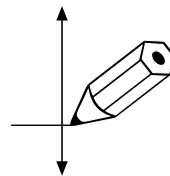

Typ 2389

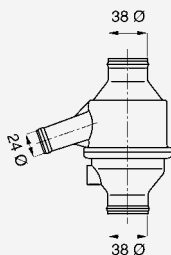

**Typ 2391
2394**

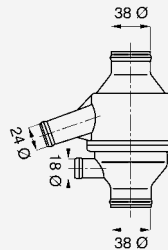

Typ 2393

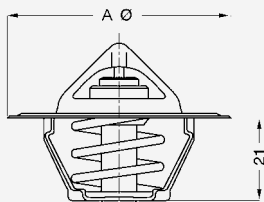

Typ A
3000 54 mit Entlüftungskerbe
3021 48
3044 44
3136 53,5
3141 54 ohne Entlüftungskerbe
3167 54 gummibeschichtete Ventilplatte

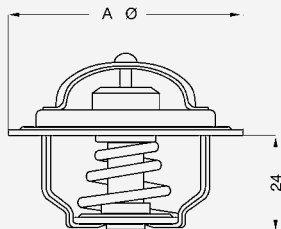

Typ A
3004 54 mit Entlüftungsventil
3032 60 mit Entlüftungsventil
3061 57 mit Entlüftungsventil
3063 53,5 mit Entlüftungskerbe

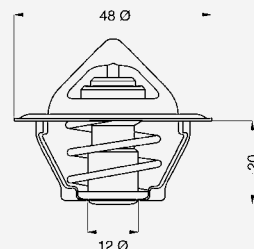

**Typ 3017
3091** mit Entlüftungskerbe mit Entlüftungsventil und gummibeschichteter Ventilplatte
3082 gummibeschichtete Ventilplatte

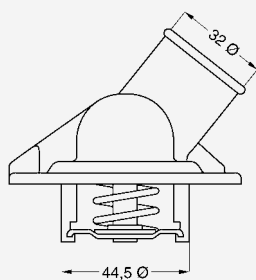

Typ 3022

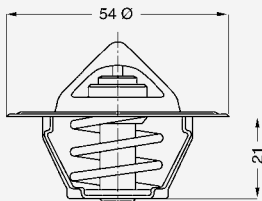

Typ 3023 mit Entlüftungskerbe

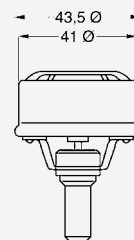

Typ 3029

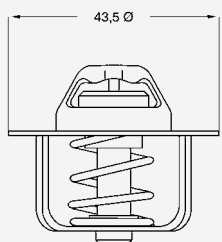

Typ 3033

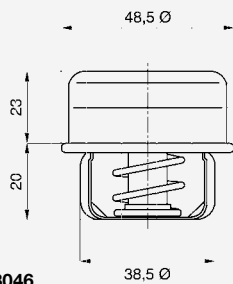

Typ 3046

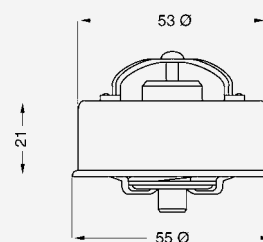

Typ 3053

Einbaumaße Assembly dimensions

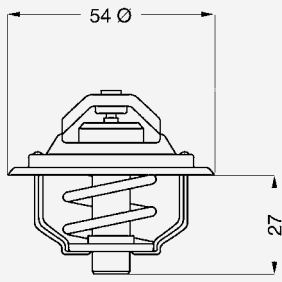

Typ 3054

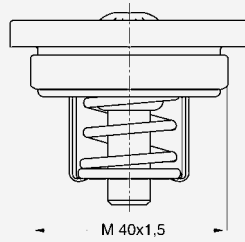

Typ 3067

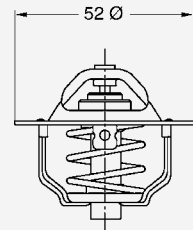

Typ 3100

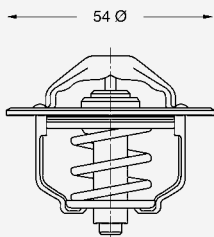

Typ 3103 mit Entlüftungsventil

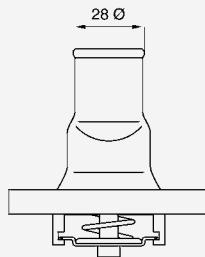

Typ 3105

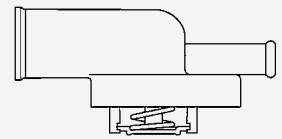

Typ 3109

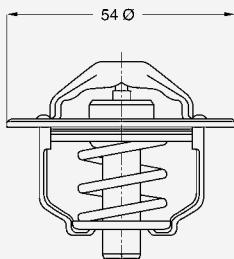

Typ 3116 mit Entlüftungsventil

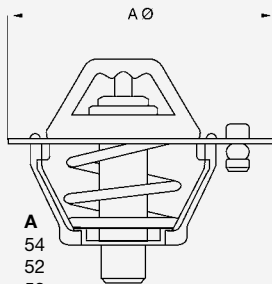

Typ	A
3118	54
3119	52
3499	52

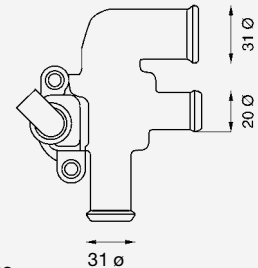

Typ 3142

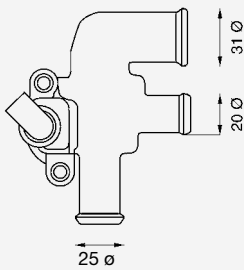

Typ 3146

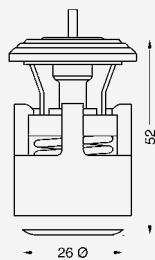

Typ 3143

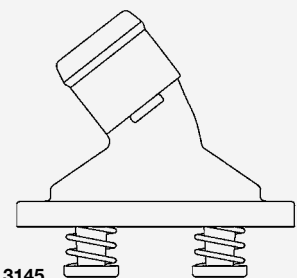

Typ 3145

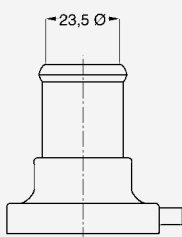

Typ 3151

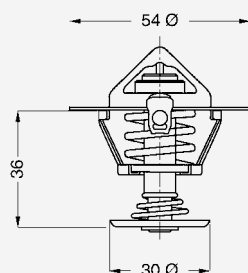

Typ 3159

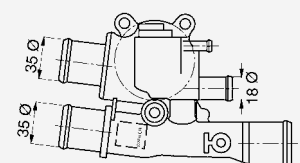

Typ	
3163	mit M 12 x 1,5
3481	mit M 12 x 1,5 / M 16 x 1,5

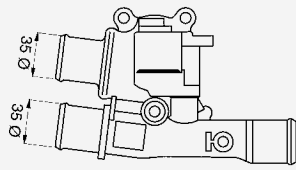
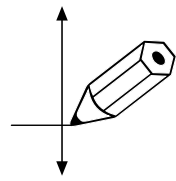

Typ 3164

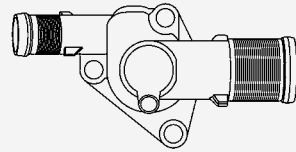

Typ 3166

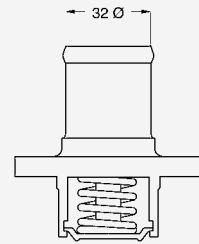

Typ 3174

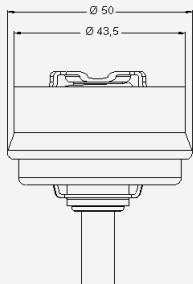

Typ 3187

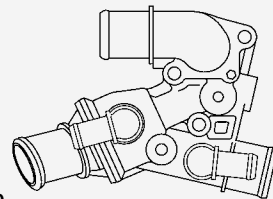

Typ
3300
4434 mit M22 x 1,5
4436 mit M16 x 1,5

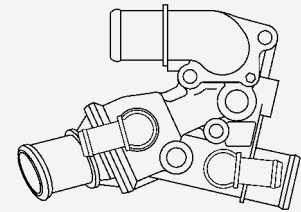

Typ
3301 mit 2 x M16 x 1,5
3302 mit 1 x M16 x 1,5

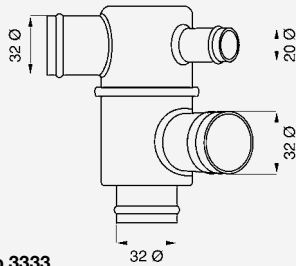

Typ 3333

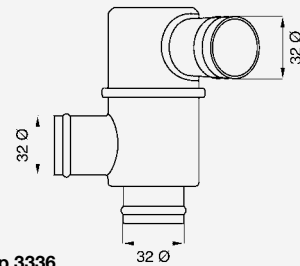

Typ 3336

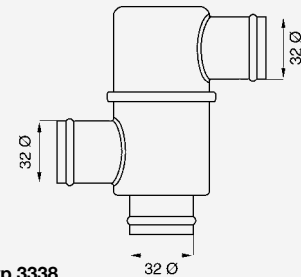

Typ 3338

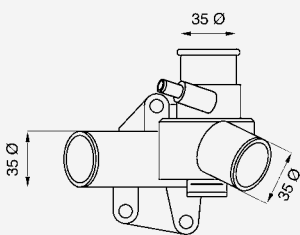

Typ
3343 21 Ø
3347 16,8 Ø

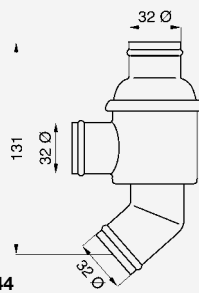

Typ 3344

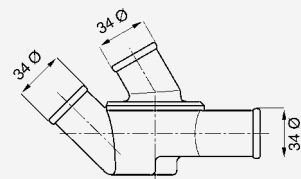

Typ 3345

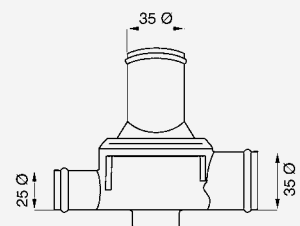
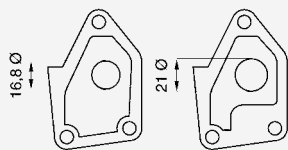

Typ 3352

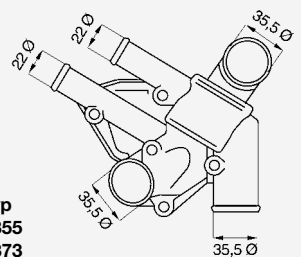

Typ
3355
3373
3378

Einbaumaße Assembly dimensions

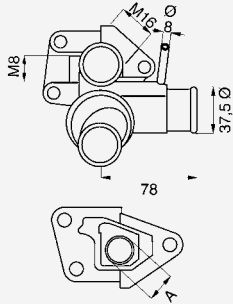

Typ A
3356 21, mit M 16, ohne M8, mit Ø 8
3364 23, ohne M 16, ohne M8, ohne Ø 8
3366 21, mit M 16, mit M8, mit Ø 8

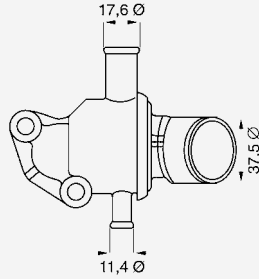

Typ 3361
3360 Stützen am Deckel
 um 90° gedreht

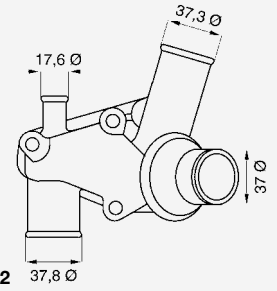

Typ 3362

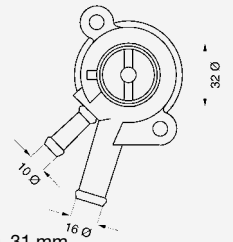

Typ 3383 mit Ø 10, 31 mm
3484 mit Ø 10, 51 mm
3485 ohne Ø 10

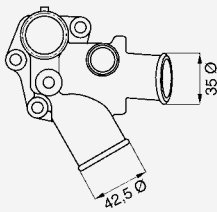

Typ 3431

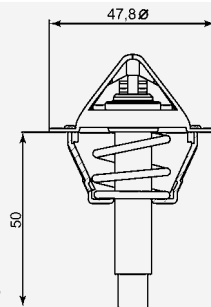

Typ 3457

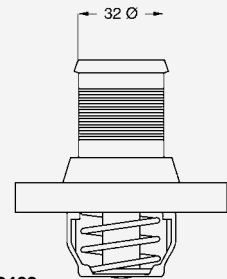

Typ 3463

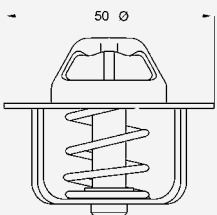

Typ 3466

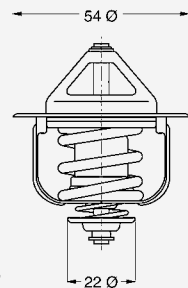

Typ 3467

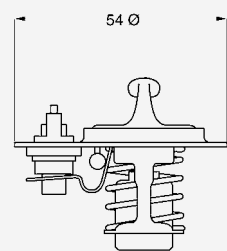

Typ 3468

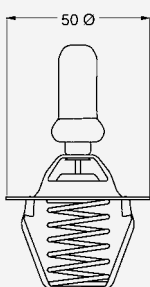

Typ 3469

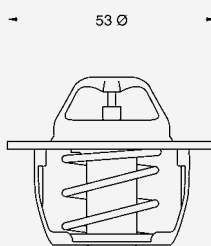

Typ 3470

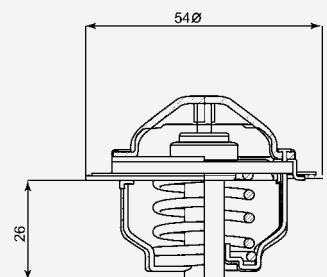

Typ 3472

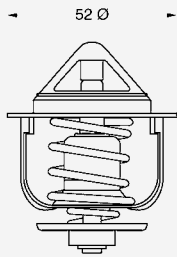
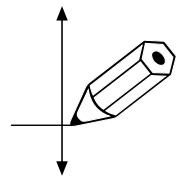

Typ 3477

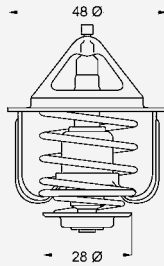

Typ 3478

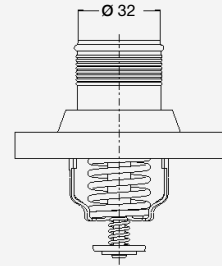

Typ 3483

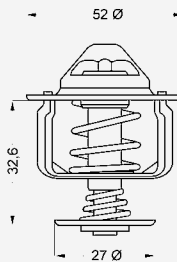

Typ 3497

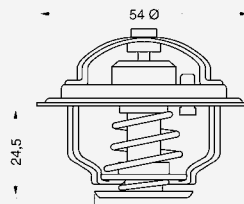

Typ
4003 ohne Entlüftungsventil oder -kerbe
4008 mit Entlüftungsventil
4015 mit Entlüftungsventil

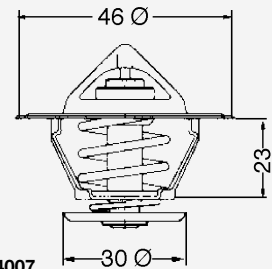

Typ 4007

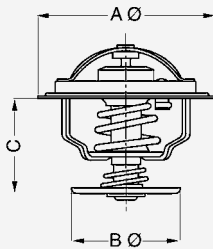

Typ	A	B	C	
4006	54	35	33	mit Entlüftungsventil
4026	54	28	30	mit Positionskerbe
4029	54	29	32	mit Entlüftungsventil
4033	56	34	33	ohne Entlüftungsventil oder -Kerbe
4154	54	29	32	mit Entlüftungsventil
4253	54	35	31	Ventilteller gummi- beschichtet
4256	54	35	31	ohne Entlüftungsventil oder -Kerbe
4272	54	35	31	mit Entlüftungsventil

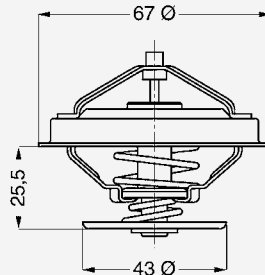

Typ	
4030	mit Entlüftungskerbe
4059	
4064	mit Entlüftungsventil kühlenseitig
4078	mit Entlüftungsventil motorseitig
4083	mit Entlüftungskerbe
4112	mit Entlüftungsventil
4122	mit Entlüftungsventil
4158	mit Entlüftungsventil

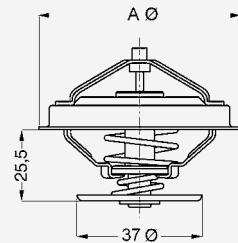

Typ	A	B	
4049	67	37	ohne Entlüftungsventil oder -kerbe
4088	67	37	ohne Entlüftungsventil oder -kerbe
4132	75	43	mit Entlüftungskerbe
4116	67	37	Ventilteller gummi- beschichtet
4117	67	37	mit Entlüftungskerbe

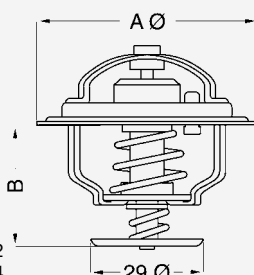

Typ	A	B
4022	54	32
4126	52	34
4154	54	32

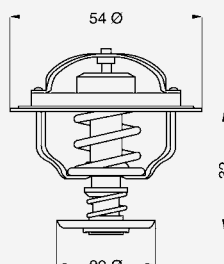

Typ 4038

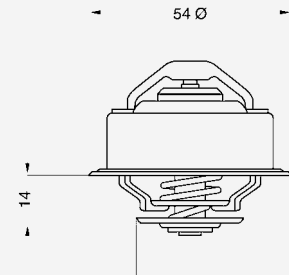

Typ 4089

Einbaumaße Assembly dimensions

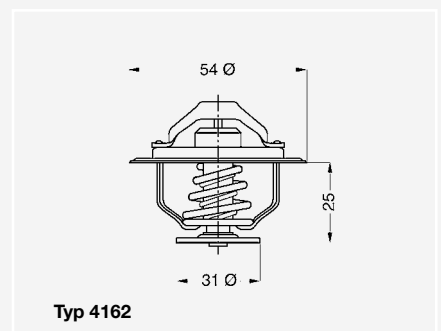
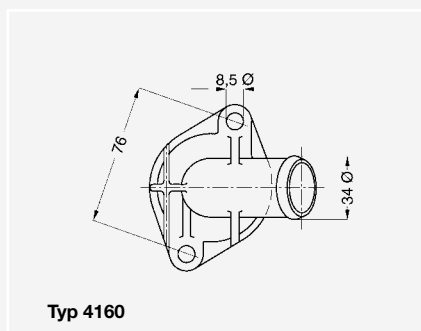
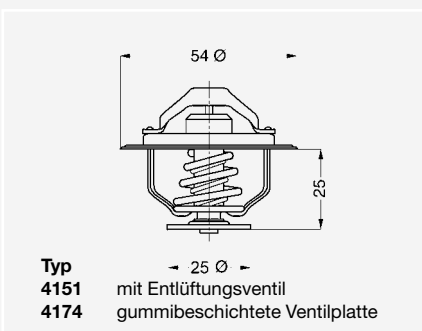
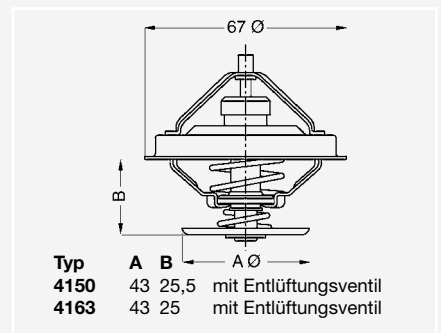
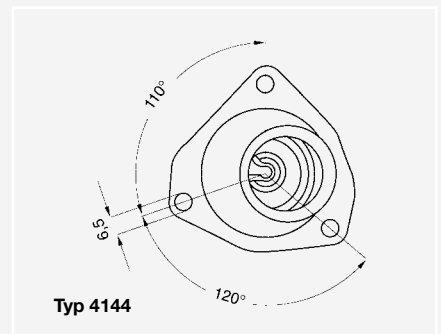
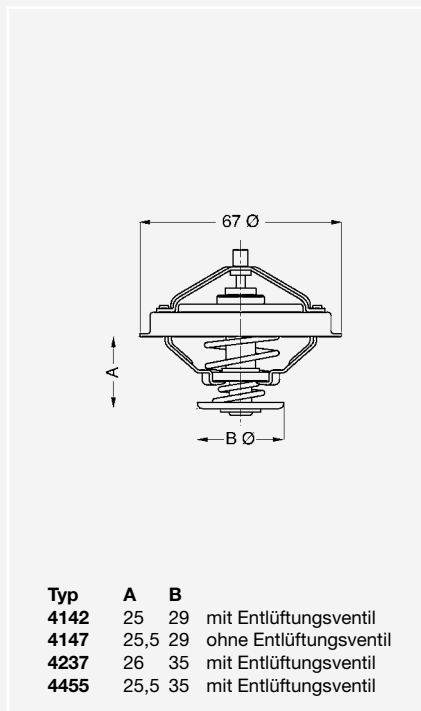
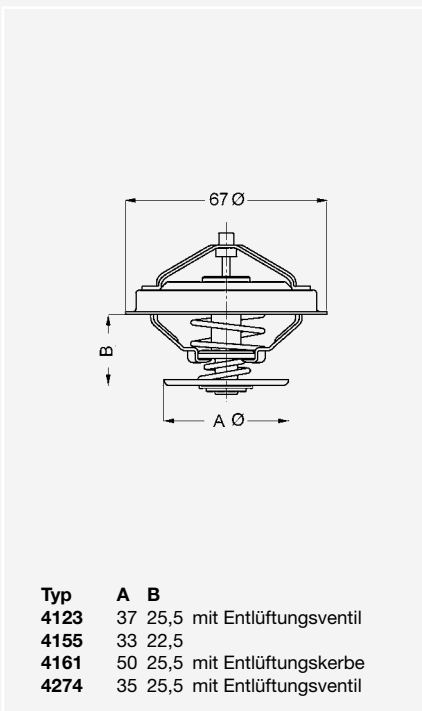
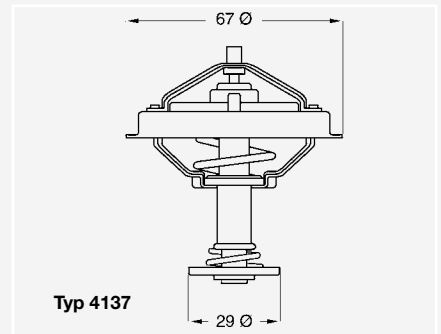
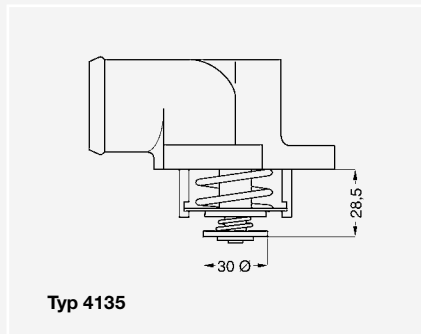
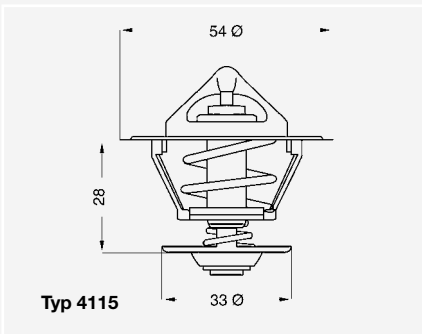
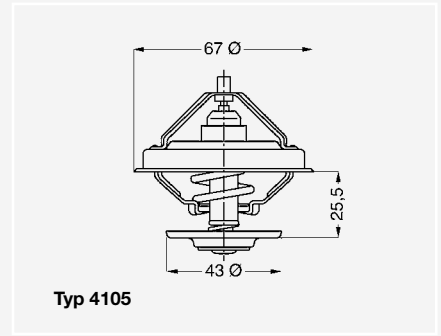
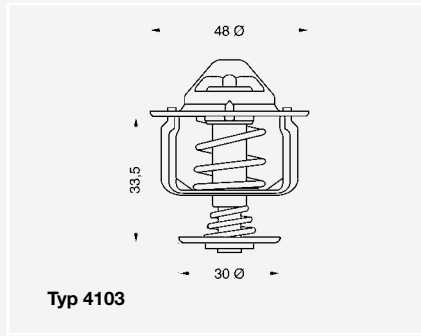
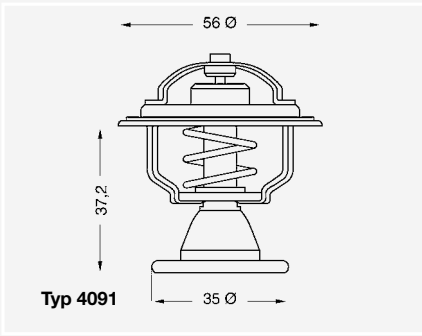

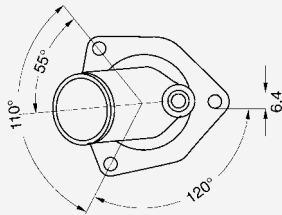
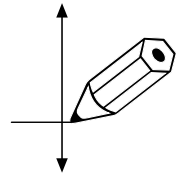

Typ 4164

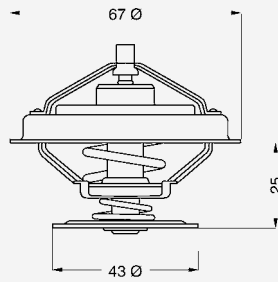

Typ 4165 mit Entlüftungsventil

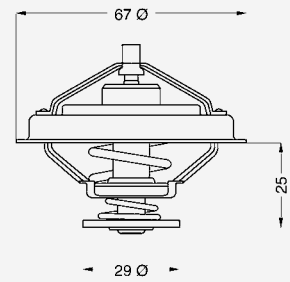

Typ 4166 mit Entlüftungsventil

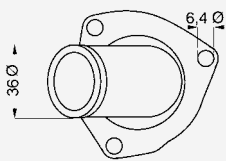

Typ 4168

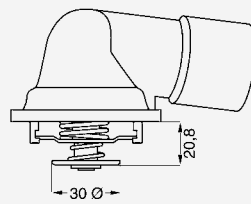

Typ 4175

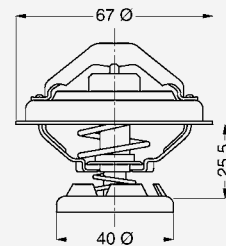

Typ 4176

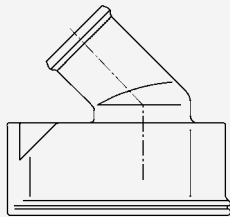

Typ 4177

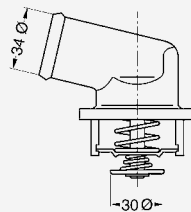

Typ 4178

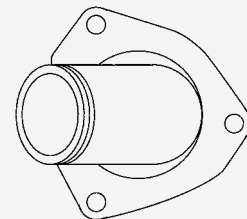

Typ 4180

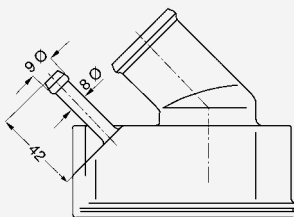

Typ 4183

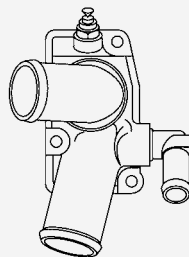

Typ 4188

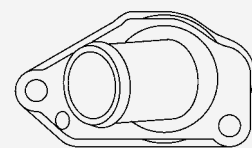

Typ 4189

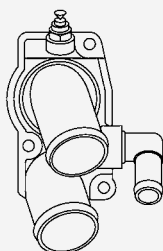

Typ 4193

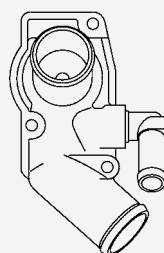

Typ 4198

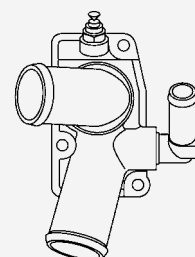

Typ 4201

Einbaumaße Assembly dimensions

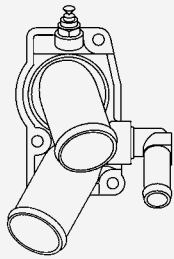

Typ 4207

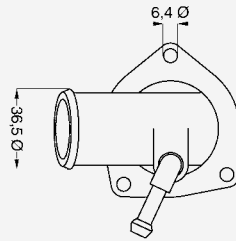

Typ 4208

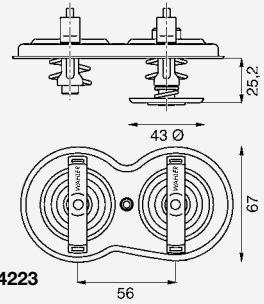

Typ 4223

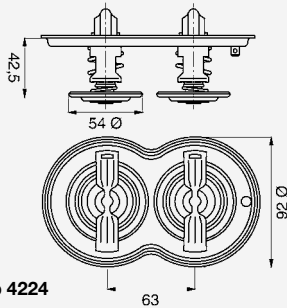

Typ 4224

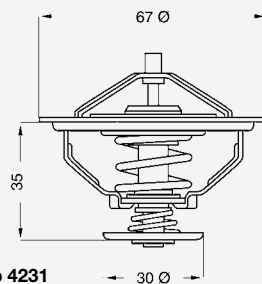

Typ 4231

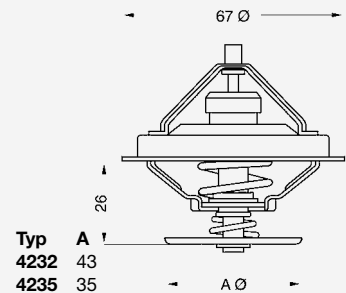

Typ A
4232 43
4235 35

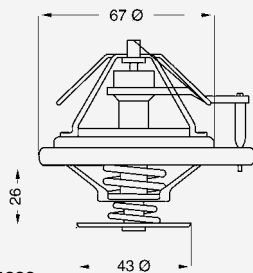

Typ 4233

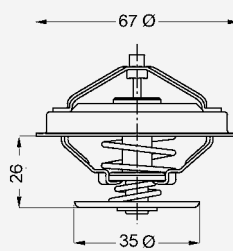

Typ 4236

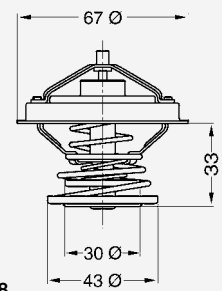

Typ 4238

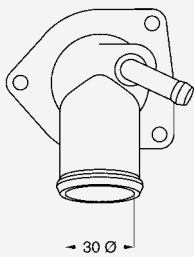

Typ 4242

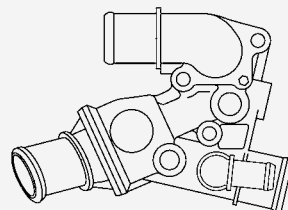

Typ 4246

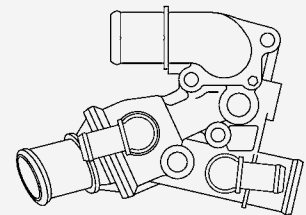

Typ
4247 mit M 16 x 1,5 / M 22 x 1,5
4434 mit M 16 x 1,5
4436 mit M 16 x 1,5 / M 16 x 1,5

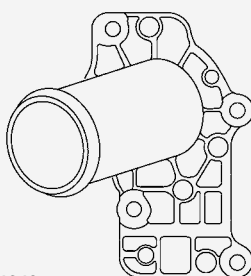

Typ 4249

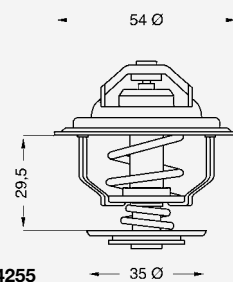

Typ 4255

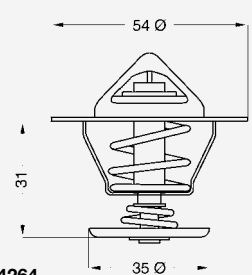

Typ 4264

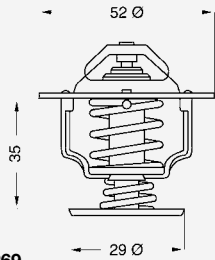
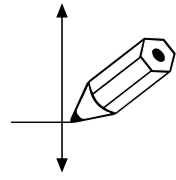

Typ 4269

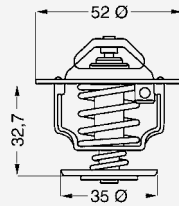

Typ 4270

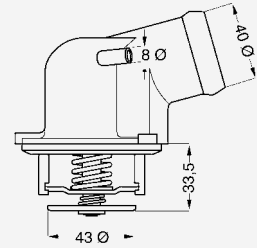

Typ 4275

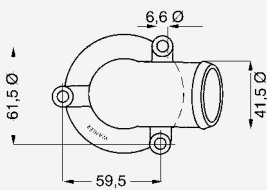

Typ 4276

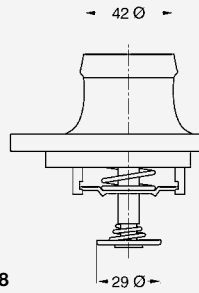

Typ 4278

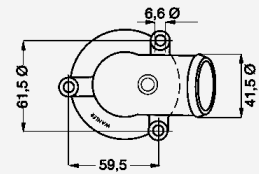

Typ 4279

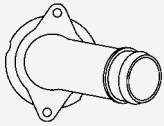

Typ 4280

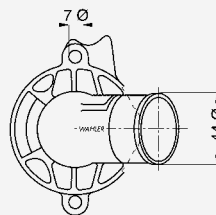

Typ 4281

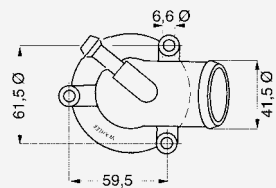

Typ 4286

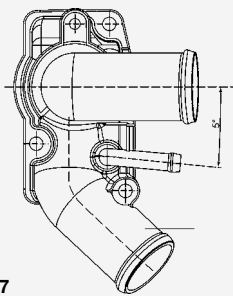

Typ 4297

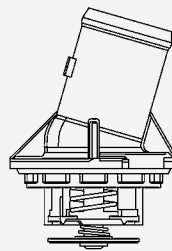

Typ 4298

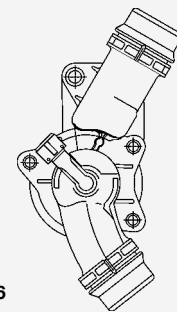

Typ 4326

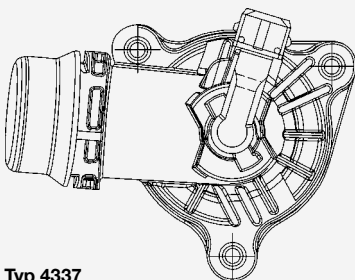

Typ 4337

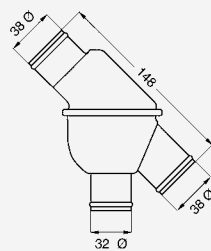

Typ 4341

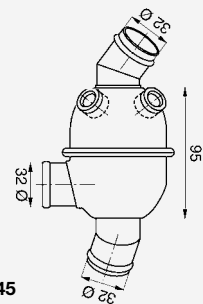

Typ 4345

Einbaumaße Assembly dimensions

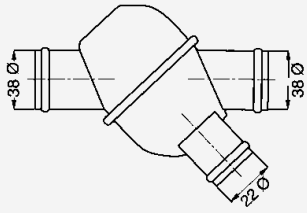

Typ 4351

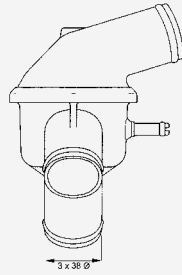

Typ 4368

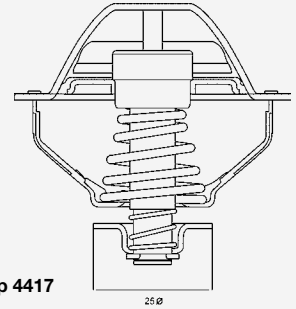

Typ 4417

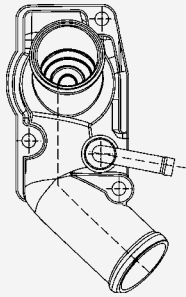

Typ 4433

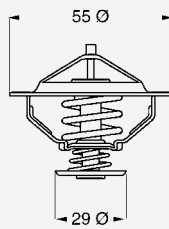

Typ 4446

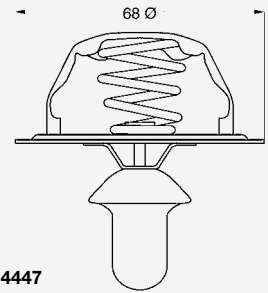

Typ 4447

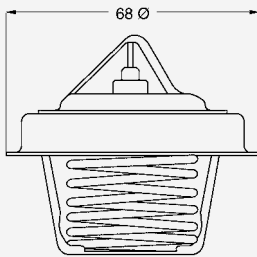

Typ 4449

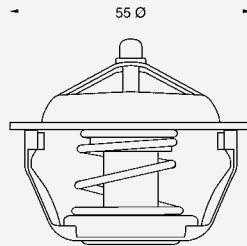

Typ 4450

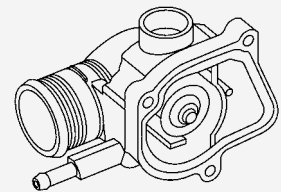

Typ 4453

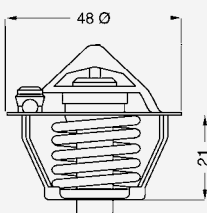

Typ 4457

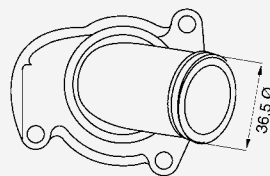

Typ
4459

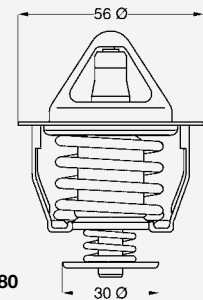

Typ 4480

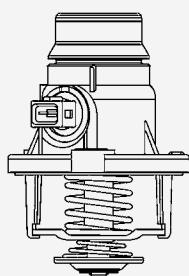

Typ 4508

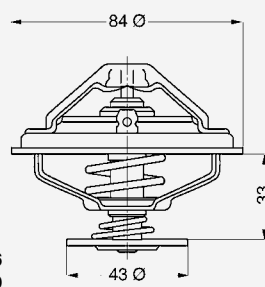

Typ
4516
4519

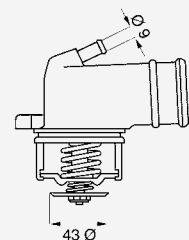

Typ 4517

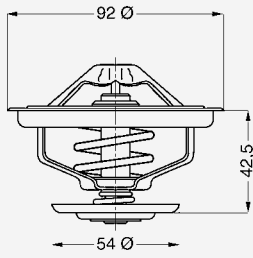
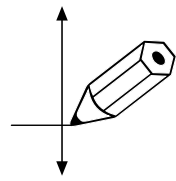

Typ 4520

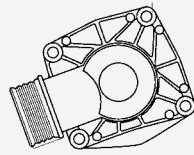

Typ 4594

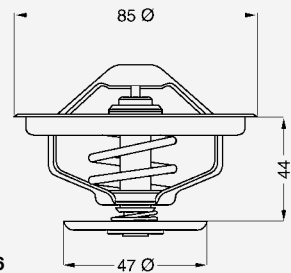

Typ 4596
4530 mit Entlüftungskerbe

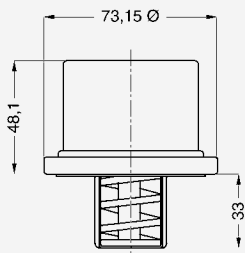

Typ 4619

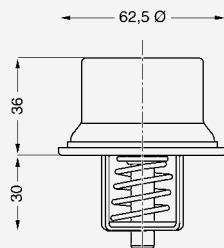

Typ 4621

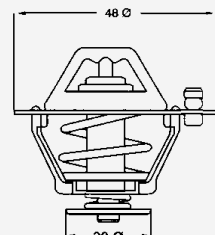

Typ 4634

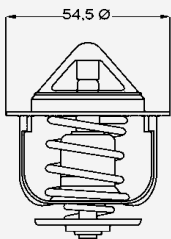

Typ 4635

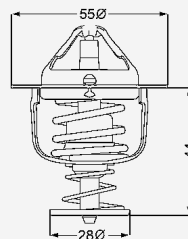

Typ 4637

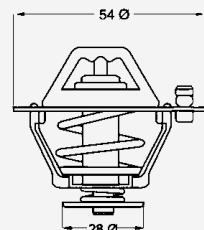

Typ 4638

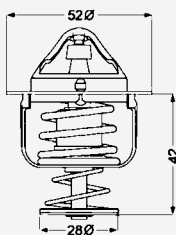

Typ 4639

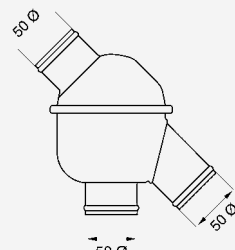

Typ 4663
4684 mit Entlüftungskerbe
mit Entlüftungsventil

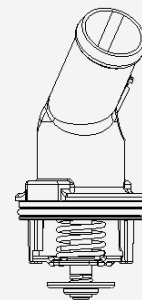

Typ 4814

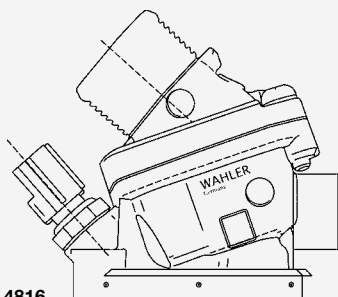

Typ 4816

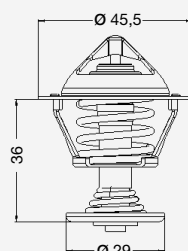

Typ 4821

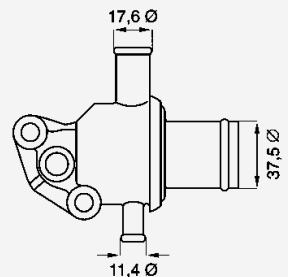

Typ 410007

Einbaumaße Assembly dimensions

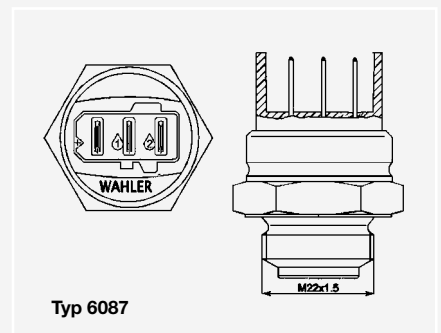
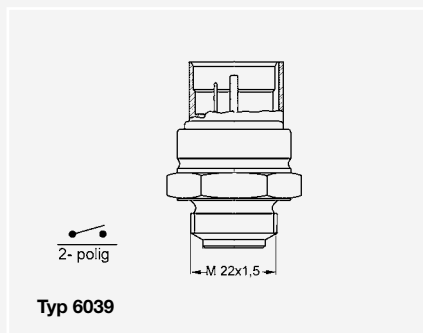
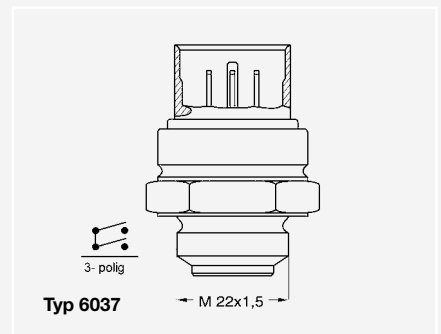
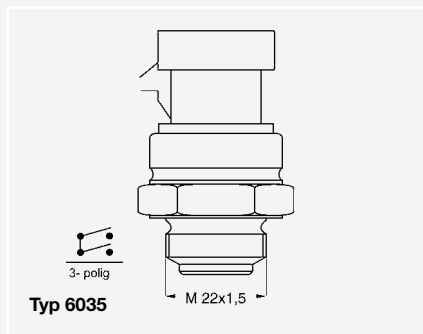
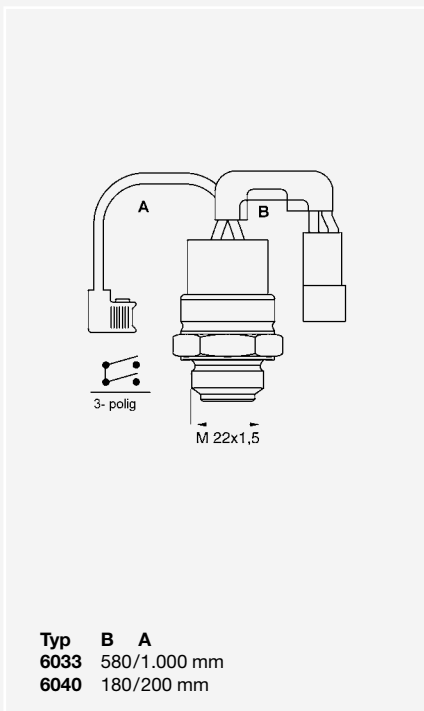
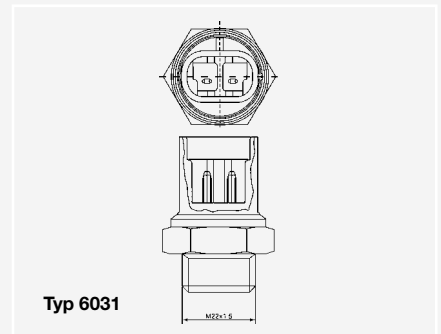
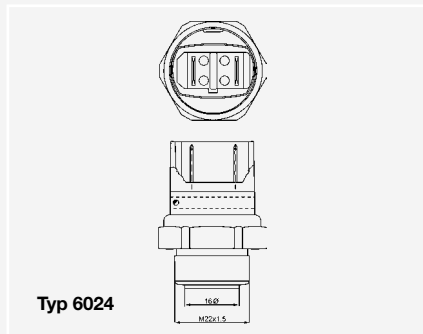
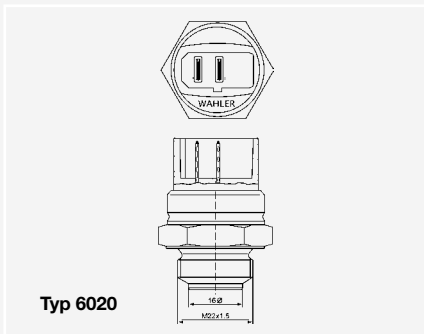
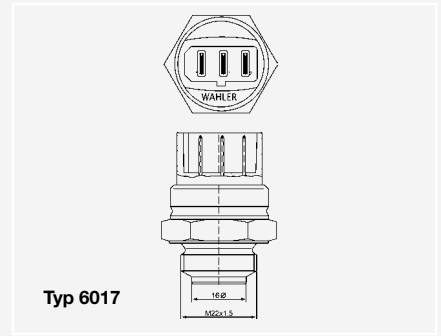
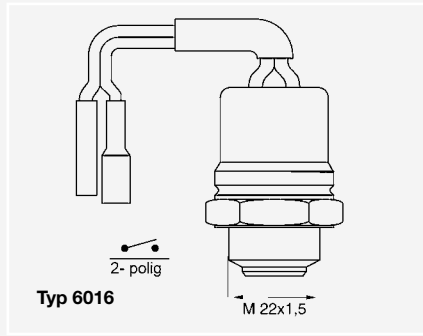
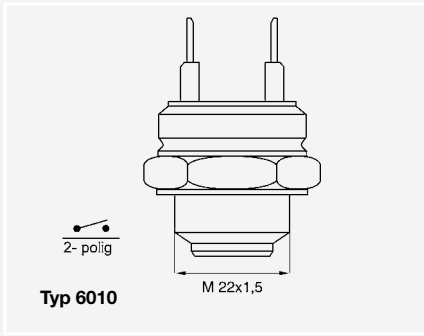

Erklärungen | Explanations | Nomenclatures

2 / 3 Anschlüsse	2 / 3 connections	2 / 3 connexions
2 / 4 polig	2 / 4 pole	2 / 4 pôle
2-teiliges Aluminiumgehäuse	2-piece aluminum housing	2 pièces boîtier en aluminium
A = Aktuator	A = actuator	A = Actuateur
AGR-Ventil	EGR valve	vanne EGR
Automatikgetriebe	automatic transmission	transmission automatique
Chassis-no. / Chassis	Chassis number	numéro de chassis
D = Drosselklappe	D = throttle flap	D = soupape d'étranglement
Deckel Thermostatgehäuse	thermostat housing cover	couvercle du boîtier de thermostat
Dichtring	seal	joint
Dichtung	seal	joint d'étanchéité
DPF = Dieselpartikelfilter	DPF = Diesel particle filter	DPF = diésel filtre à particules
Drosselklappe	throttle flap	soupape d'étranglement
Einbauseite Zylinderkopf	attached to the cylinder head	attaché à la culasse
Einsatzthermostat	insert Thermostat	thermostat intérieur
elektrisch	electrical	électrique
elektrisch beheizt	electrical heated	commande électrique
elektrischgesteuert	electrically controlled	commandés électriquement
ersatzlos entfallen	no longer available	n'est plus livré
Europa	Europe	Europe
Excl. = exclude	Excl. = exclude	Excl. = exclue
für OE-Nummer	for original number	pour réf. OE no.
Gehäuse	housing	boîtier
Gewinde	thread	filetage
Japan	Japan	Japon
Katalysator	catalyst	catalyseur
Katalysatorart	catalyst type	type de catalyseur
Kennfeldthermostat	electrically heated thermostat	thermostat piloté
Klimaanlage	air conditioner	système de climatisation
Kunststoffdeckel	plastic cover	plastique couvercle
L = AGR-Leitung	L = EGR-pipe	L = tuyau EGR
Leitung Drosselklappe zum Zylinderkopf	pipe throttle valve to cylinder head	tuyau gaz à culasse
Metalldeckel	metal cover	métal couvercle
mit	with	avec
Motor-no./ Motornummer	engine number	numéro de moteur
oben	upper	supérieur
ohne	without	sans
Ölkühlung	oil cooling	refroidissement de l'huile
Organisationsnummer	organisation number	numéro d'organisation
Partikelfilter	diesel sootfilter	filtre à particules
pneumatisch	pneumatic	pneumatique
Retarder	Retarder	retardateur
Rußpartikelfilter	particle filter	filtre à particules
Schaltgetriebe	manual transmission	boîte de vitesses manuelle
schwarz	black	noir
Serie / Serienausführung	series / Standard equipment	série / en série
solange vorrätig	available while stocks last	jusqu'à épuisement des stocks
thermisch	thermal	thermique
unten	lower	inférieur
USA	USA	USA
V = AGR-Ventil	V = EGR valve	V = vanne EGR
Variante	variant	variante
Wasserkühlung	water cooling	refroidissement par eau
zusätzlich benötigte Artikel	additionally required parts	article supplémentaire nécessaire
XXX → = ab	XXX → = from	XXX --> = à partir
→ XXX = bis	→ XXX = up to	--> XXX = jusque
XXX → XXX = von → bis	XXX → XXX = from → up to	XXX --> XXX = à partir --> jusque
▲ = neuer Artikel	▲ = new part number	▲ = nouveau article
● = Auslaufteil	● = article to be discontinued	● = article écoulé

BorgWarner Esslingen GmbH

Hindenburgstrasse 146

73730 Esslingen

Deutschland / Germany

Telefon: +49 711 3152-0

Telefax: +49 711 3152-210
