

2018

motorcycle
& scooter

RMS
YOUR BEST PARTNER

The background of the entire page is a repeating pattern of various icons related to motorcycles and vehicle maintenance. These icons include motorcycles, gears, wrenches, screwdrivers, batteries, pistons, and other mechanical parts, all rendered in a light gray color.

RMS

YOUR BEST PARTNER

IL MIGLIOR PARTNER PER LE MIGLIORI PRESTAZIONI

RMS è un'azienda **leader** all'interno del panorama europeo per quanto riguarda la distribuzione di **ricambi** ed **accessori** per **bici**, **moto&scooter** e **bici elettriche** che propone un'offerta completa rivolta a produttori e rivenditori di entrambi i settori.

Si avvale di **partnership consolidate** con i maggiori produttori mondiali, che garantiscono un ventaglio di prodotti all'avanguardia in un settore estremamente competitivo ed in continua evoluzione.

La **soddisfazione del cliente** rappresenta da sempre una delle principali priorità: nel perseguirla RMS utilizza **sistemi logistici innovativi** e tecnologie avanzate, affiancandole ai classici strumenti di divulgazione diretta, come i **cataloghi** in versione cartacea e digitale. **Customer Satisfaction** significa inoltre una presenza capillare sul territorio, grazie ad una rete di agenti in contatto diretto sia con il cliente che con la sede centrale, in grado per questo di rispondere prontamente a qualsiasi evenienza, di snellire le procedure e di completare in tempi brevi le pratiche di raccolta ed evasione degli ordini.

Tutti i clienti RMS hanno la possibilità di accedere ad un'**area riservata** su **www.rms.it**. Il B2B di RMS è strumento completamente dedicato alle loro esigenze, dove è possibile gestire e monitorare gli ordini, visualizzare le disponibilità, ricevere ed elaborare statistiche ed informazioni e raccogliere i relativi documenti in assoluta sicurezza.



I NUMERI DI
R.M.S.

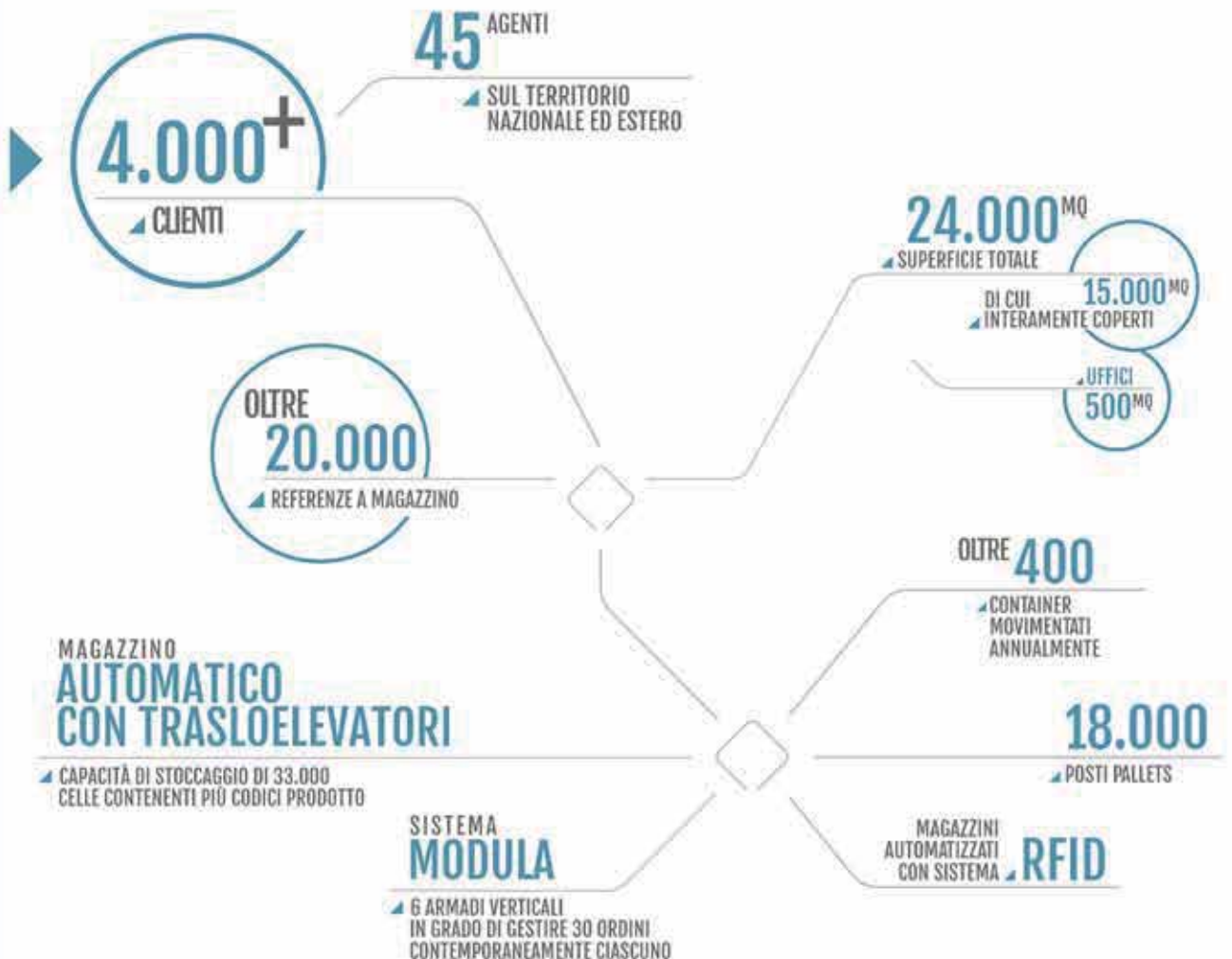

PERCHÈ
R.M.S.



PIÙ SCELTA

Con oltre 20.000 prodotti in un'area di 24.000 mq.

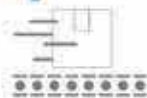

PIÙ VELOCITÀ

Grazie al magazzino interamente automatizzato.



PIÙ RISPARMIO

RMS con la sua struttura aziendale evoluta, garantisce un prezzo estremamente competitivo.



KENDA



FERODO
YOU ARE IN CONTROL.

ROLF



Muc-Off



UFI

DAYCO

arexons



KMG

GOETZE



Li-On

Li-OnR

YSS



Koyo



BS
MOTORS

BERU

Bikeservice
Premium Service Tools

Continental

FEDERAL MOGUL

NYPSO

WRAPPER

CHAMPION

FORSA

NTN

SINER
High Tech Lubricants MARKET



ENEOS



I NOSTRI MARCHI

TI PRESENTO HIVE IL MAGAZZINO AUTOMATICO

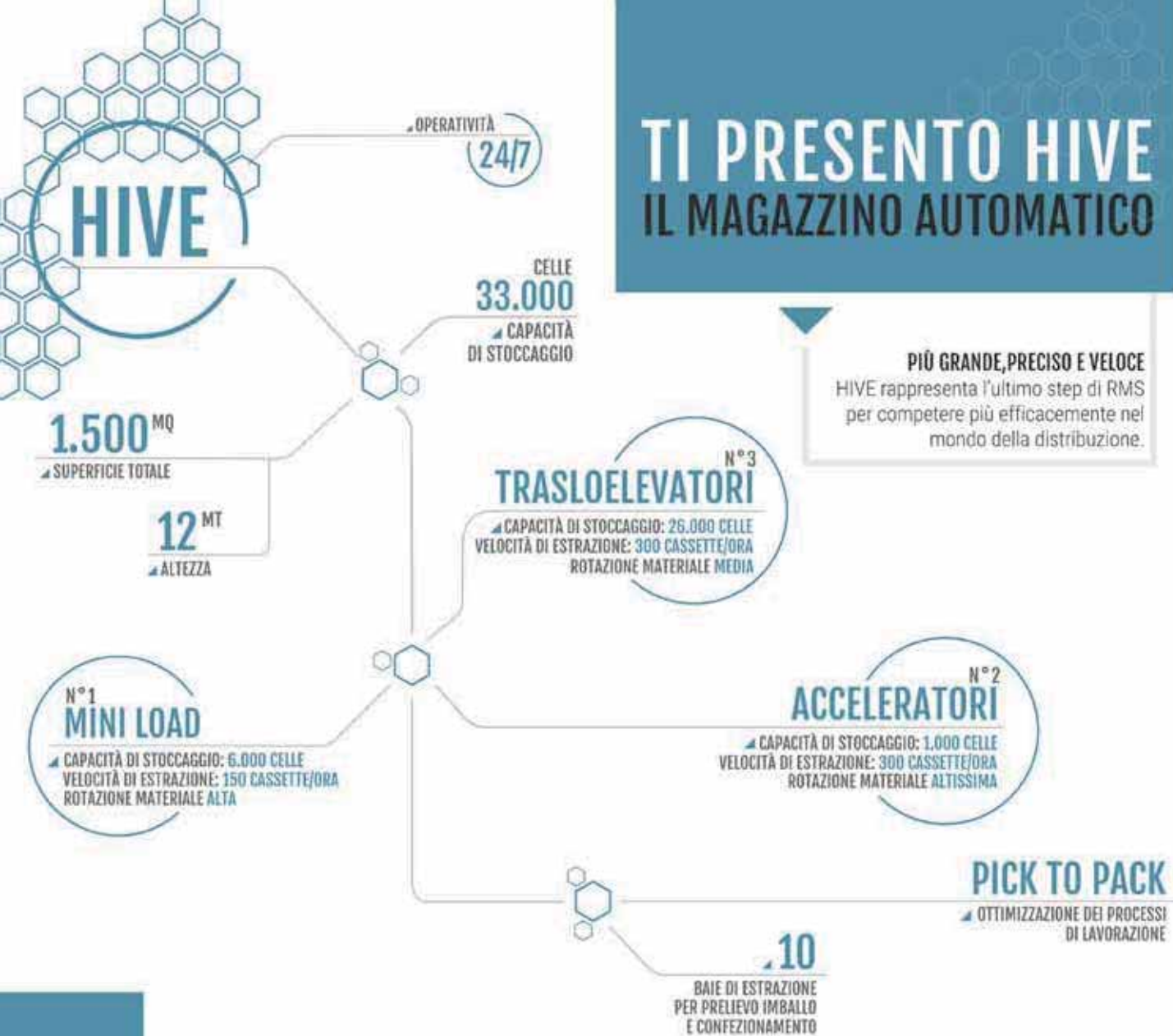

PIÙ GRANDE, PRECISO E VELOCE
HIVE rappresenta l'ultimo step di RMS per competere più efficacemente nel mondo della distribuzione.

LO SVILUPPO DELL'ORDINE



NUOVO B2B

What's new?

NAVIGAZIONE PERSONALIZZATA

La profilazione del sito si adatterà alle tue esigenze.

INTERFACCIA SEMPLIFICATA

La struttura del sito è pensata per garantirti una navigazione veloce ed intuitiva.

RICERCA VELOCE

Grazie alla gestione avanzata dei filtri di ricerca, potrai trovare velocemente i prodotti che cerchi, confrontarli con prodotti simili e verificare in real time la loro disponibilità.

CONTROLLO IMMEDIATO DELLA GESTIONE POST ORDINE

Nella tua area personale potrai monitorare in tempo reale tutti i movimenti post ordine.

PROGRAMMI ESCLUSIVI SU TARGET CLIENTE

Potrai aderire ai programmi esclusivi creati appositamente per te, monitorarne lo stato di completamento e valutare le promo consigliate in base alla tua navigazione.

APPLICAZIONE DEDICATA

Grazie allo sviluppo della nuova applicazione dedicata, sarà ancora più facile e veloce seguire i tuoi ordini!

The screenshot displays the RMS B2B website interface. At the top, there's a navigation bar with the RMS logo and various menu items. Below this, the main content area is divided into several sections: 'SCORRETTI IN TIME', 'LA TUA SITUAZIONE' (with a progress bar), 'PRODOTTI ESCLUSIVI' (featuring a circular chart with '100%' and a motorcycle image), and 'NEWS' (with a 'Mic-Off' advertisement). The middle section shows a grid of product cards for various categories like 'MOTO', 'MOTO SIDI', and 'MOTO SIDI'. Each card includes a product image, name, and price. At the bottom, there's a 'Banche per il credito' section with logos for LOOK, Continental, ELEKTRA, arexons, and BS. Below the main content, a dark banner titled 'COME FUNZIONA R.M.S.' features four icons representing different stages of the process: 'Seleziona il prodotto', 'Seleziona il fornitore', 'Seleziona il prezzo', and 'Seleziona il cliente'. The footer contains contact information and social media links.





INDICE

A		
Adattatori Specchi Retrovisori	499	
Alberi cambio	320	
Alberi Motore	18	
Alberi Ruota Posteriore	320	
Ammortizzatori FORSA	530	
Astucci a Rulli	108	
Attrezzi officina - BIKESERVICE	1028	
B		
Batterie - BS	807	
Batterie ELEKTRA	813	
Batterie Litio LI-ON	802	
Blocchetti Manubrio	859	
Bobine - Centraline AT	903	
Bobine Accensione BERU	910	
Boccole Messa in Moto	304	
Bulbo Temperatura Acqua	894	
Bulloni	743	
C		
Calandre	770	
Calotte Sterzo	731	
Campane Frizione	242	
Campane Frizione Vespa - Ape	314	
Candele - CHAMPION	818	
Candele NGK	816	
Capicorda Morsetti	436	
Cappucci Candele	825	
Cappucci Candele - CHAMPION	824	
Cappucci Candele - NGK	817	
Carica batterie - BS	811	
Carica batterie - Elektra	814	
Carrozzeria Particolari	784	
Catene Di Distribuzione KMC	46	
Catene Pompa Olio	60	
Catene Trasmissione KMC- AMC	326	
Cavalletti Centrali	502	
Cavalletti Lateral	515	
Cavalletti Paddock	1022	
Cavi - Contachilometri	404	
Cavi Freno	408	
Cavi Gas	412	
Cavi Moto	439	
Cavi Starter	422	
Cavi Trasmissioni APE	425	
Cavi Trasmissioni VESPA - Ciclomotori	431	
Centraline Elettroniche - CDI	898	
Cerchi	726	
Chiavi Candela	1062	
Cilindri	26	
Cilindri Freno	723	
Cilindri Racing	38	
Cilindri Serratura - RMS - ZADI	967	
Cinghie Ape - Ciclomotore	231	
Cinghie Batteria	814	
Cinghie Fissaggio per Trasporto	1021	
Cinghie Miscelatore	231	
Cinghie Trasmissione DAYCO - RMS	218	
Claxon	866	
Collettori Aspirazione	121	
Collettori Scarico	124	
Comandi Gas - DOMINO	384	
Comandi Portaleva - DOMINO	381	
Comando Gas Vespa	440	
Commutatori Accensione	964	
Condensatori	976	
Connettori Elettrici	973	
Contachilometri Vespa	763	
Contatti	977	
Contenitori Rulli Variatore	270	
Coperture - Camere KENDA	984	
Coprimanubri	769	
Copriventola	323	
Crocere Cambio	317	
Cuffie Testa Cilindro	323	
Cuscinetti a Sfere	104	
D		
Dadi	743	
Devio Luci	859	
Dischi Freno	704	
E		
Estrattori Volano	1061	
F		
Fanali anteriori	839	
Fanali posteriori	843	
Fasce Elastiche	42	
Filtri Aria - NYPSO - UFI	126	
Filtri Aria - Tabella Applicazioni	145	
Filtri Aria CHAMPION	160	
Filtri Aria Quad	144	
Filtri Aria Racing	142	
Filtri Carburante	202	
Filtri Olio CHAMPION	206	
Filtri Olio NYPSO	178	
Filtri Olio NYPSO - Tabella Applicazioni	189	
Filtri Olio UFI	188	
Forcelle	728	
Frecce Moto Complete	827	
Fregi e Stemmi	788	
Frizioni multidisco	314	
Fusibili	896	
G		
Gabbie a Rulli	108	
Gabbiette Sterzo	742	
Ganasce Freno	600	
Giranti Frizione	232	
Giunti Catene	326	
Gomme	984	
Gommini Telaio Vespa	781	
Guaine Cavi	439	
Guarnizioni	72	
I		
Impianti elettrici	972	
Ingranaggi Avviamento Kit	312	
Intermittenze Frecce	891	
Interruttore termico	894	
Interruttori elettrici	862	
Interruttori Frizione	871	
Interruttori Stop	876	
K		
Kit Conversione Luci a Led	854	
Kit Gommini Cofano	782	
Kit Pronto Soccorso	1025	
Kit Pulegge Motrici	269	
Kit Revisione Albero Motore	109	
Kit Revisione Pompa Acqua	94	
Kit Tagliando Scooter	299	
L		
Lampadine	848	
Lampadine Led	854	
Lana di Roccia	215	
Lenti Frecce	834	
Leve Freno - Figurato	338	
Leve Freno - Tabella Applicazioni	357	
Lucchetti - Catene	1023	
M		
Manicotti Aspirazione	121	
Manopole - DOMINO	390	
Manopole - RMS	398	
Marmitte e accessori marmitte	214	
Misurini Centilitrati	757	
Molle Messa in Moto	305	
Morsetti	436	
Motorini Avviamento	932	
O		
Olio Motore - ENEOS	1002	
Olio Motore - PETRONAS LINX	1005	
P		
Pacchi Lamellari	120	
Parafanghi	766	
Paraoli - Per Misura	118	
Paraoli Sets	113	
Paraoli Valvole	61	
Paraspruzzi	774	
Particolari gomma motore	321	
Passacavi	783	
Pastiglie Freno Applicazioni RMS - SINTER	603	
Pastiglie Freno Figurato RMS - SINTER	562	
Pattini Tendicaten	70	
Pedali	784	
Pedivelle Avviamento	306	
Pick Up	953	
Pignoni Messa in Moto	302	
Pistoni	42	
Pompe Benzina	758	
Pompe Freno	723	
Portapacchi Vespa	775	
Portatarga	784	
Preselettori Cambio	318	
Prigionieri	749	
Prodotti Chimici Moto MUC-OFF	996	
Prodotti Chimici Moto PETRONAS	1004	
Prodotti Chimici Officina AREXONS	1007	
Profili Vespa	779	
Prolunghe Ammortizzatori Scooter	559	
Pulsanti Claxon	859	
Puntine	997	
Q		
Quadretti Avviamento - RMS - ZADI	958	
R		
Regolatori di Tensione	918	
Relè Avviamento	901	
Relè Frecce	891	
Relè Ventola	102	
Resistenze	893	
Resistenze Frecce	827	
Rinvii Contachilometri	438	
Riparazione Tubeless	1020	
Riparazione Tubeless AIRMAN	1018	
Rondelle	743	
Rubinetti benzina	754	
Rulli Puleggia Motrice	272	
Ruote Libere Avviamento	308	
S		
Semipulegge Condotte Fisse	265	
Semipulegge Condotte Scorrevoli	267	
Semipulegge Motrici Fisse	253	
Semipulegge Motrici Mobili	258	
Sensori	894	
Serbatoi Benzina	774	
Serbatoi Olio	773	
Settori Messa in Moto	301	
Silent Block	321	
Soffietti	121	
Sonde Lambda	895	
Specchi Retrovisori	444	
Statori	944	
Strisce Pedana Vespa	778	
Supporti elastici	321	
Switch Frizione	871	
Switch Stop	876	
T		
Tamburi Freno	725	
Tamponi Ammortizzatori	560	
Tappettini in Gomma Vespa	776	
Tappi Benzina, olio motore, olio freni	762	
Targhette	788	
Tasselli Traino	271	
Teli Copri Moto	1021	
Termostati	102	
Teste Motore	41	
Trasmissione Ape Giunti	319	
Trasmissioni Primarie	314	
Tubi Benzina - Olio	757	
Tubi comando cambio / gas Vespa	440	
V		
Ventole Pulegge Motrici	271	
Vernice Spray WRAPPER	1013	
Viteria	743	
Volani	952	



MOTORE	
Alberi cambio	320
Alberi Motore	18
Boccole Messa in Moto	304
Catene Di Distribuzione KMC	46
Catene Pompa Olio	60
Cilindri	26
Cilindri Racing	38
Copriventola	323
Cuffie Testa Cilindro	323
Fasce Elastiche	42
Filtri Carburante	202
Filtri Olio CHAMPION	206
Filtri Olio NYPSO	178
Filtri Olio NYPSO - Tabella Applicazioni	189
Filtri Olio UFI	188
Guarnizioni	72
Ingranaggi Avviamento Kit	312
Kit Revisione Albero Motore	109
Kit Revisione Pompa Acqua	94
Molle Messa in Moto	305
Particolari gomma motore	321
Pattini Tendicatena Distribuzione	70
Pignoni Messa in Moto	302
Pistoni	42
Prigionieri	749
Ruote Libere Avviamento	308
Serbatoi Olio	773
Settori Messa in Moto	301
Silent Block	321
Supporti elastici	321
Teste Motore	41
ASPIRAZIONE	
Cinghie Miscelatore	231
Collettori Aspirazione	121
Filtri Aria - NYPSO - UFI	126
Filtri Aria - Tabella Applicazioni	145
Filtri Aria CHAMPION	160
Filtri Aria Quad	144
Filtri Aria Racing	142
Manicotti Aspirazione	121
Pacchi Lamellari	120
Pompe Benzina	758
Rubinetti benzina	754
Serbatoi Benzina	774
Soffietti	121
Tappi Benzina, olio motore, olio freni	762
Tubi Benzina - Olio	757
SCARICO	
Collettori Scarico	124
Lana di Roccia	215
Marmitte e accessori marmitte	214
Sonde Lambda	895
CUSCINETTI	
Astucci a Rulli	108
Cuscinetti a Sfere	104
Gabbie a Rulli	108
TENUTA	
Paraoli - Per Misura	118
Paraoli Sets	113
Paraoli Valvole	61
TRASMISSIONE MOTO	
Catene Trasmissione KMC- AMC	326
Giunti Catene	326
TRASMISSIONE SCOOTER VARIATORE	
Campagne Frizione	242
Cinghie Trasmissione DAYCO - RMS	218
Contenitori Rulli Variatore	270
Giranti Frizione	232
Kit Pulegge Motrici	269
Rulli Puleggia Motrice	272
Semipulegge Condotte Fisse	265
Semipulegge Condotte Scorrevoli	267
Semipulegge Motrici Fisse	253
Semipulegge Motrici Mobili	258
Tasselli Traino	271

Ventole Pulegge Motrici	271
TRASMISSIONE VESPA APE	
Alberi Ruota Posteriore	320
Campagne Frizione Vespa - Ape	314
Cinghie Ape - Ciclomotore	231
Crocere Cambio	317
Frizioni multidisco	314
Preselettori Cambio	318
Trasmissione Ape Giunti	319
Trasmissioni Primarie	314
TELAIO	
Calotte Sterzo	731
Capicorda Morsetti	436
Cavalletti Centrali	502
Cavalletti Lateral	515
Cavi - Contachilometri	404
Cavi Freno	408
Cavi Gas	412
Cavi Moto	439
Cavi Starter	422
Cavi Trasmissioni APE	425
Cavi Trasmissioni VESPA - Ciclomotori	431
Cerchi	726
Cilindri Serratura - RMS - ZADI	967
Comandi Gas - DOMINO	384
Comandi Portaleva - DOMINO	381
Comando Gas Vespa	440
Commutatori Accensione	964
Forcelle	728
Gabbiette Sterzo	742
Gommini Telaio Vespa	781
Guaine Cavi	439
Leve Freno - Figurato	338
Leve Freno - Tabella Applicazioni	357
Manopole - DOMINO	390
Manopole - RMS	398
Morsetti	436
Passacavi	783
Pedali	784
Pedivelle Avviamento	306
Tubi comando cambio / gas Vespa	440
SOSPENSIONI	
Ammortizzatori FORSA	530
Prolunghe Ammortizzatori Scooter	559
Tamponi Ammortizzatori	560
IMPIANTO FRENANTE	
Cilindri Freno	723
Dischi Freno	704
Ganasce Freno	600
Pastiglie Freno Applicazioni RMS - SINTER	603
Pastiglie Freno Figurato RMS - SINTER	562
Pompe Freno	723
Tamburi Freno	725
BATTERIE	
Batterie - BS	807
Batterie ELEKTRA	813
Batterie Litio LI-ON	802
Cinghie Batteria	814
IMPIANTO ELETTRICO	
Blocchetti Manubrio	859
Bobine - Centraline AT	903
Bobine Accensione BERU	910
Bulbo Temperatura Acqua	894
Candele - CHAMPION	818
Candele NGK	816
Cappucci Candele	825
Cappucci Candele - CHAMPION	824
Cappucci Candele - NGK	817
Centraline Elettroniche - CDI	898
Claxon	866
Condensatori	976
Connettori Elettrici	973
Contachilometri Vespa	763
Contatti	977
Devio Luci	859
Fanali anteriori	839
Fanali posteriori	843

Frecce Moto Complete	827
Fusibili	896
Impianti elettrici	972
Intermittenze Frecce	891
Interruttore termico	894
Interruttori elettrici	862
Interruttori Frizione	871
Interruttori Stop	876
Lampadine	848
Lampadine Led	854
Lenti Frecce	834
Motorini Avviamento	932
Pick Up	953
Pulsanti Claxon	859
Puntine	997
Quadretti Avviamento - RMS - ZADI	958
Regolatori di Tensione	918
Relè Avviamento	901
Relè Frecce	891
Relè Ventola	102
Resistenze	893
Resistenze Frecce	827
Sensori	894
Statori	944
Switch Frizione	871
Switch Stop	876
Termostati	102
Volani	952
CARROZZERIA	
Adattatori Specchi Retrovisori	499
Calandre	770
Carrozzeria Particolari	784
Coprimanubri	769
Fregi e Stemmi	788
Kit Gommini Cofano	782
Parafanghi	766
Paraspruzzi	774
Portatarga	784
Profili Vespa	779
Rinvii Contachilometri	438
Specchi Retrovisori	444
Strisce Pedana Vespa	778
Tappetini in Gomma Vespa	776
Targhette	788
COPERTURE	
Coperture - Camere KENDA	984
Gomme	984
ACCESSORI MOTO	
Carica batterie - BS	811
Carica batterie - Elektra	814
Cavalletti Paddock	1022
Cinghie Fissaggio per Trasporto	1021
Kit Conversione Luci a Led	854
Kit Pronto Soccorso	1025
Kit Tagliando Scooter	299
Lucchetti - Catene	1023
Portapacchi Vespa	775
Riparazione Tubeless	1020
Riparazione Tubeless AIRMAN	1018
Teli Copri Moto	1021
LUBRIFICANTI E PRODOTTI CHIMICI	
Olio Motore - ENEOS	1002
Olio Motore - PETRONAS LINX	1005
OFFICINA	
Attrezzi officina - BIKESERVICE	1028
Bulloni	743
Chiavi Candela	1062
Dadi	743
Estrattori Volano	1061
Misurini Centilitrati	757
Prodotti Chimici Moto MUC-OFF	996
Prodotti Chimici Moto PETRONAS	1004
Prodotti Chimici Officina AREXONS	1007
Rondelle	743
Vernice Spray WRAPPER	1013
Viteria	743



INDEX

A		
Air Filters - Applications Table	145	
Air Filters - NYPSO - UFI	126	
Air Filters CHAMPION	160	
Air Filters Quad	144	
Air Filters Racing Type	142	
Ape Driveshaft Coupling	319	
B		
Badges	788	
Ball Bearings	104	
Batteries - BS	807	
Batteries ELEKTRA	813	
Battery Chargers - BS	811	
Battery Chargers - ELEKTRA	814	
Battery Fixing Belts	814	
Belts APE - Moped	231	
Belts DAYCO - RMS	218	
Belts Mixer	231	
Blinker Lamps	827	
Blinkers Relays	891	
Body Parts	784	
Bolts	743	
Brake Cables	408	
Brake Cylinders	723	
Brake Discs	704	
Brake Drum	725	
Brake Master Cylinders	723	
Brake Pads Applications Table RMS - SINTER	603	
Brake Pads Drawings RMS - SINTER	562	
Brake Shoes	600	
Bush Starters	304	
C		
Cables Sleeves	439	
Carriers Vespa	775	
CDI	898	
Central Stands	502	
Chains KMC- AMC	326	
Chemical products for Motorcycles MUC-OFF	996	
Chemical products for Motorcycles PETRONAS	1004	
Chemical products for Workshop AREXONS	1007	
Choke Cables	422	
Clamps Terminals	436	
Clutch Assy	232	
Clutch Outers	242	
Clutch Outers - Vespa - Ape	314	
Clutch Switches	871	
Clutch Switches	871	
Coils	903	
Condensators	976	
Connecting Links (Chain)	326	
Crankshafts	18	
Crankshafts Revision Kits	109	
Cylinder Head Covers	323	
Cylinder Heads	41	
Cylinder Kits - Original Type	26	
Cylinder Kits - Racing Scooter 50 cc.	38	
Cylinder Locks - RMS - ZADI	967	
D		
Dosage Beakers	757	
Drawn Cups	108	
E		
Electric Fuel Pumps	758	
Electrical Connectors	973	
Electrical Devices	862	
Engine rubber parts	321	
Exhaust Manifolds	124	
F		
Fan Covers	323	
Fan Relay	894	
First Aid Kit	1025	
Fixed Drive Half Pulley	253	
Fixed Driven Half Pulley	265	
Floor Mats Vespa	776	
Flywheel Extractors	1061	
Flywheels	952	
Footrest Stripes Vespa	778	
Forks	728	
Frame Rubbers Kit Vespa	781	
Fuel Filters	202	
Fuel Tanks	774	
Fuel Taps - Pumps	754	
Fuel, Oil and Brake Fluid Caps	762	
Fuses	896	
G		
Gasket Sets	72	
Gear Box Selectors	318	
Gear Selectors	317	
Grips - DOMINO	390	
Grips - RMS	398	
Grommets	783	
H		
Handlebar Covers	769	
Hardware	743	
Head Lights	859	
Horn Buttons	859	
Horns	866	
I		
Ignition Coils BERU	910	
Ignition Switches	964	
Inlet Pipes	121	
Intake bellows	121	
Intermitences	891	
K		
Key Sets Main Switches - RMS - ZADI	958	
Kick Starters	306	
Kit Sidepanel Rubbers	782	
L		
Lamps	848	
Led Conversion Kits	854	
Led Lamps	854	
Lens	834	
Lever Supports - DOMINO	381	
Levers	338	
Levers - Applications Table	357	
Lights Switches	859	
Lithium Batteries LI-ON	802	
Locks	1023	
M		
Motorcycle Cables	439	
Motorcycle Covers	1021	
Movable Drive Half Pulley	258	
Movable Driven Half Pulley	267	
Mud Flaps	774	
Mudguards	766	
Mufflers	214	
Multi-disc Clutches /Primary Drives	314	
N		
Nameplates	788	
Nipple Screw Units	436	
Nuts	743	
O		
Oil - ENEOS	1002	
Oil - PETRONAS LINX	1005	
Oil and fuel Hoses	757	
Oil Filters CHAMPION	206	
Oil Filters NYPSO	178	
Oil Filters NYPSO - Applications Table	189	
Oil Filters UFI	188	
Oil Pump Chains	60	
Oil Seals - Search by Size	118	
Oil Seals Sets	113	
Oil Tanks	773	
Oxygen Sensors	895	
P		
Paddock Stands	1022	
Pedals	784	
Pick Up	953	
Pinion Starters	302	
Piston Kits	42	
Piston Rings	42	
Plate Holders	784	
Platiners	977	
Profiles Vespa	779	
Pulley - Kits	269	
Pulley Fans	271	
R		
Rear View Mirrors	444	
Rear View Mirrors Adapters	499	
Rear Wheel Axles	320	
Reed Valves	120	
Regulators	918	
Repair Kits for Tires	1020	
Resistors	893	
Resistors Blinkers	827	
Rock Wool Cartridge	215	
Roller Cages	108	
Roller Sets	272	
Roller Weight Housings	270	
Rubber Engine Mounts	321	
S		
Sensors	894	
Service Kits For Scooter	299	
Shock Absorbers Extensions	559	
Shock Absorbers FORSA	530	
Shock Absorbers Rubbers	560	
Side Stands	515	
Silentblocks	321	
Sleeves	121	
Sliders	271	
Spark Plug Wrench	1062	
Spark Plugs Caps	825	
Spark Plugs Caps - CHAMPION	824	
Spark Plugs Caps - NGK	817	
Spark Plugs CHAMPION	818	
Spark Plugs NGK	816	
Speedometer Cables	404	
Speedometer Pinions	438	
Speedometers Vespa	763	
Start Shafts	301	
Starter Gears Kits	312	
Starter Motors	932	
Starter Relays	901	
Starter Springs	305	
Starter Wheels	308	
Stators	944	
Steering Caps Sets	731	
Steering Covers	770	
Stop Switches	876	
Stop Switches	876	
Studs	749	
T		
Tail Lights	843	
Thermal Switches	102	
Thermostats	102	
Throttle Cables	412	
Throttles - DOMINO	384	
Tie Down	1021	
Timing Chain Guides Kit	70	
Timing Chains KMC	46	
Tires - Tubes KENDA	984	
Tires Repair Kit AIRMAN	1018	
Transmission Cables - APE	425	
Transmission Cables - Scooters	314	
Transmission Shafts	320	
U		
Upper Balls Cages	742	
V		
Valve Seals	61	
VESPA Cables	431	
Vespa Shift and Throttle Controls	440	
W		
Washers	743	
Water Pump Repair Kits	94	
Wheelrims	726	
Wiring Harness	972	
Workshop Tools - BIKESERVICE	1028	
WRAPPER Spray Paint	1013	



ENGINE		Roller Sets	272	Ignition Coils BERU	910	
Bush Starters	304	Roller Weight Housings	270	Intermittences	891	
Crankshafts	18	Sliders	271	Key Sets Main Switches - RMS - ZADI	958	
Crankshafts Revision Kits	109	TRANSMISSIONS VESPA APE			Lamps	848
Cylinder Head Covers	323	Ape Driveshaft Coupling	319	Led Lamps	854	
Cylinder Heads	41	Belts APE - Moped	231	Lens	834	
Cylinder Kits - Original Type	26	Clutch Outers - Vespa - Ape	314	Lights Switches	859	
Cylinder Kits - Racing Scooter 50 cc.	38	Gear Box Selectors	318	Pick Up	953	
Engine rubber parts	321	Gear Selectors	317	Platiners	977	
Fan Covers	323	Multi-disc Clutches /Primary Drives	314	Regulators	918	
Fuel Filters	202	Rear Wheel Axles	320	Resistors	893	
Gasket Sets	72	Transmission Cables - Scooters	314	Resistors Blinkers	827	
Oil Filters CHAMPION	206	CHASSIS			Sensors	894
Oil Filters NYPSO	178	Brake Cables	408	Spark Plugs Caps	825	
Oil Filters NYPSO - Applications Table	189	Cables Sleeves	439	Spark Plugs Caps - CHAMPION	824	
Oil Filters UFI	188	Central Stands	502	Spark Plugs Caps - NGK	817	
Oil Pump Chains	60	Choke Cables	422	Spark Plugs CHAMPION	818	
Oil Tanks	773	Clamps Terminals	436	Spark Plugs NGK	816	
Pinion Starters	302	Cylinder Locks - RMS - ZADI	967	Speedometers Vespa	763	
Piston Kits	42	Forks	728	Starter Motors	932	
Piston Rings	42	Frame Rubbers Kit Vespa	781	Starter Relays	901	
Rubber Engine Mounts	321	Grips - DOMINO	390	Stators	944	
Silentblocks	321	Grips - RMS	398	Stop Switches	876	
Start Shafts	301	Grommets	783	Stop Switches	876	
Starter Gears Kits	312	Ignition Switches	964	Tail Lights	843	
Starter Springs	305	Kick Starters	306	Thermal Switches	102	
Starter Wheels	308	Lever Supports - DOMINO	381	Thermostats	102	
Studs	749	Levers	338	Wiring Harness	972	
Timing Chain Guides Kit	70	Levers - Applications Table	357	BODY WORK		
Timing Chains KMC	46	Motorcycle Cables	439	Badges	788	
Transmission Shafts	320	Nipple Screw Units	436	Body Parts	784	
Water Pump Repair Kits	94	Pedals	784	Floor Mats Vespa	776	
INTAKE SYSTEM		Side Stands	515	Footrest Stripes Vespa	778	
Air Filters - Applications Table	145	Speedometer Cables	404	Handlebar Covers	769	
Air Filters - NYPSO - UFI	126	Steering Caps Sets	731	Kit Sidepanel Rubbers	782	
Air Filters CHAMPION	160	Throttle Cables	412	Mud Flaps	774	
Air Filters Quad	144	Throttles - DOMINO	384	Mudguards	766	
Air Filters Racing Type	142	Transmission Cables - APE	425	Nameplates	788	
Belts Mixer	231	Upper Balls Cages	742	Plate Holders	784	
Electric Fuel Pumps	758	VESPA Cables	431	Profiles Vespa	779	
Fuel Tanks	774	Vespa Shift and Throttle Controls	440	Rear View Mirrors	444	
Fuel Taps - Pumps	754	Wheelrims	726	Rear View Mirrors Adapters	499	
Fuel, Oil and Brake Fluid Caps	762	SUSPENSIONS			Speedometer Pinions	438
Inlet Pipes	121	Shock Absorbers Extensions	559	Steering Covers	770	
Intake bellows	121	Shock Absorbers FORSA	530	TIRES		
Oil and fuel Hoses	757	Shock Absorbers Rubbers	560	Tires - Tubes KENDA	984	
Reed Valves	120	BRAKING SYSTEM			ACCESSORIES	
Sleeves	121	Brake Cylinders	723	Battery Chargers - BS	811	
EXHAUST SYSTEM		Brake Discs	704	Battery Chargers - ELEKTRA	814	
Exhaust Manifolds	124	Brake Drum	725	Carriers Vespa	775	
Mufflers	214	Brake Master Cylinders	723	First Aid Kit	1025	
Oxygen Sensors	895	Brake Pads Applications Table RMS - SINTER	603	Led Conversion Kits	854	
Rock Wool Cartridge	215	Brake Pads Drawings RMS - SINTER	562	Locks	1023	
BEARINGS		Brake Shoes	600	Motorcycle Covers	1021	
Ball Bearings	104	BATTERIES			Paddock Stands	1022
Drawn Cups	108	Batteries - BS	807	Repair Kits for Tires	1020	
Roller Cages	108	Batteries ELEKTRA	813	Service Kits For Scooter	299	
TIGHT SYSTEM		Battery Fixing Belts	814	Tie Down	1021	
Oil Seals - Search by Size	118	Lithium Batteries LI-ON	802	Tires Repair Kit AIRMAN	1018	
Oil Seals Sets	113	ELECTRICAL SYSTEM			LUBRICANT AND CHEMICAL PRODUCTS	
Valve Seals	61	Blinker Lamps	827	Oil - ENEOS	1002	
TRANSMISSIONS MOTORCYCLE		Blinkers Relays	891	Oil - PETRONAS LINX	1005	
Chains KMC- AMC	326	CDI	898	WORKSHOP		
Connecting Links (Chain)	326	Clutch Switches	871	Bolts	743	
TRANSMISSIONS SCOOTER		Clutch Switches	871	Chemical products for Motorcycles MUC-OFF	996	
Belts DAYCO - RMS	218	Coils	903	Chemical products for Motorcycles PETRONAS	1004	
Clutch Assy	232	Condensators	976	Chemical products for Workshop AREXONS	1007	
Clutch Outers	242	Electrical Connectors	973	Dosage Beakers	757	
Fixed Drive Half Pulley	253	Electrical Devices	862	Flywheel Extractors	1061	
Fixed Driven Half Pulley	265	Fan Relay	894	Hardware	743	
Movable Drive Half Pulley	258	Flywheels	952	Nuts	743	
Movable Driven Half Pulley	267	Fuses	896	Spark Plug Wrench	1062	
Pulley - Kits	269	Head Lights	839	Washers	743	
Pulley Fans	271	Horn Buttons	859	Workshop Tools - BIKESERVICE	1028	
		Horns	866	WRAPPER Spray Paint	1013	



A			
Aceite motor - ENEOS	1002	Discos Frenos	704
Aceite motor - PETRONAS LINX	1005	E	
Adaptadores Espejos	499	Ejes de Transmisión	320
Alfombrillas Vespa	776	Embragues Multidiscos	314
Amortiguadores FORSA	530	Engranajes Kit Arranque	312
Anagramas	788	Elingas para Transporte	1021
Aplicaciones Manetas de Freno	357	Esparragos	749
Aplicaciones Pastillas de Freno RMS - SINTER	603	Espejos Retrovisores	444
Aros de Piston	42	Estators	944
B		Estractores Volantes	1061
Baterías - BS	807	Estuche a Bobina/Rodillo	108
Baterías ELEKTRA	813	F	
Baterías Litio LI-ION	802	Filtros Aceite CHAMPION	206
Bobinas	903	Filtros Aceite NYPSO	178
Bobinas de Encendido BERU	910	Filtros Aceite NYPSO - Tabla de Aplicaciones	189
Bombas de Gasolina	758	Filtros Aceite UFI	188
Bombas Freno	723	Filtros Aire - NYPSO - UFI	126
Bombillas Led	854	Filtros Aire - Tabla de Aplicaciones	145
Bornes	436	Filtros Aire CHAMPION	160
Botones Claxon	859	Filtros Aire Quad	144
Bujías CHAMPION	818	Filtros Aire Racing	142
Bujías NGK	816	Filtros Gasolina	202
C		Fundas de Cables	439
Caballetes Centrales	502	Fundas Moto	1021
Caballetes de Competición	1022	Fusibles	896
Caballetes Laterales	515	G	
Cables Acelerador	412	Goma de Aspiración	120
Cables Arranque	422	Gomas Chasis Vespa	781
Cables Cuenta Km	404	Gomas de Escudo Vespa	779
Cables Freno	408	Gomas Varias - Piaggio	321
Cables Moto	439	Grifos y Bombas de Gasolina	754
Cables Transmission Ape	425	Grupo Termico	26
Cables Transmission Scooter	314	Grupo Termico Racing	38
Cables Vespa	431	Guardabarros	766
Cadenas Bomba Aceite	60	Guias de Variador	271
Cadenas con Toricas	326	H	
Cadenas de Distribución KMC	46	Herramientas para Taller - BIKESERVICE	1028
Cadenas Transmisión KMC- AMC	326	Horquillas	728
Caja del Eje de Arranque	304	I	
Caja del Eje Rueda Trasera	320	Instalaciones Electricas	972
Cajas de Laminas	121	Intermitentes Completos	827
Campanas de Embrague	242	Interruptor Termico	894
Campanas de Embrague - Vespa - Ape	314	Interruptores de Arranque	964
Candados - Cadenas	1023	Interruptores de Embrague	871
Cargadores de Baterías - BS	811	Interruptores Stop	876
Cargadores de Baterías - ELEKTRA	814	J	
Casquillo de Dirección	731	Jaula de Aguja	108
Centralinas Electronicas - CDI	898	Jaula de Aguja Superiores	742
Cerraduras - RMS - ZADI	967	K	
Cerraduras de Contacto - RMS - ZADI	958	Kit de Juntas	72
Cigüeñales	18	Kit de Primeros Auxilios	1025
Cilindros Frenos	723	Kit de Reparación Tubeless AIRMAN	1018
Claxons	866	Kit Estribos Vespa	778
Cofia Cabeza Cilindro	323	Kit Gomas Tapa Lateral	782
Cojinetes de Bolas	104	Kit Guias Cadena de Distribución	70
Colector Aspiración-Escape	121	Kit Repara-Pinchazos Tubeless	1020
Colectores de Escape	124	Kits de Conversion LED	854
Condensadores	976	Kits Polea Motriz	269
Conductos de Cables	783	Kits Revision Bomba de Agua	94
Conectores Eléctricos	973	Kits Revision Eje Motor	109
Correas Ape	231	Kits Revision Scooter	299
Correas Mezclador	231	L	
Correas para Batería	814	Lamparas	848
Correas Transmisión DAYCO - RMS	218	Lana Tubo de Escape	215
Cruceta Cambio y Engranajes Cambio	317	Letreros	788
Cubierta Volante	323	Llantas	726
Cubiertas - Camaras KENDA	984	Llaves Bujías	1062
Cubre Dirección	770	Llaves de Contacto	977
Cubre Manillares	769	Luces Delanteras	839
Cuentakilometros Vespa	763	Luces Traseras	843
Culatas	41	M	
D		Mando Gas Vespa	440
Depositos de Aceite	773	Mandos de Cambio y Gas	440
Depositos de Gasolina	774	Mandos Gas - DOMINO	384
Desviadores Luces	859	Manetas de Freno	338
Detalles Chasis	784	Medidores Graduados Centilitros	757
		Mordazas	232
		Motores de Arranque	932
		Muelles de Arranque	305
		N	
		Neumaticos	984
		P	
		Partes de Transmission Ape	319
		Pastillas de Freno RMS - SINTER	562
		Pedales	784
		Pedales de Arranque	306
		Pick Up	953
		Piñones Cuentakm	438
		Piñones de Arranque	302
		Pipas de Bujías	825
		Pipas de Bujías - CHAMPION	824
		Pipas de Bujías - NGK	817
		Pistones	42
		Placa Portarodillos	270
		Portaequipajes Vespa	775
		Portamanetas - DOMINO	381
		Portamatriculas	784
		Productos Químicos para Motocicleta MUC-OFF	996
		Productos Químicos para Motocicleta PETRONAS	1004
		Productos Químicos para Taller AREXONS	1007
		Prolongadores de Amortiguador	559
		Puños - Domino	390
		Puños - RMS	398
		Puños Eléctricos	862
		R	
		Reguladores de Tension	918
		Relés Arranque	901
		Relés Intermitentes	891
		Relés Ventilador	102
		Resistencias	893
		Resistencias Intermitentes	827
		Retenes	113
		Retenes de la Valvula	61
		Retenes Ordenados por Medida	118
		Rodamientos	743
		Rodillos Variador	272
		Ruedas Libres de Arranque	308
		S	
		Salvabarros	774
		Sector de Arranque	301
		Selectores Cambio	318
		Semi Poleas Conductas Corredizas	267
		Semi Poleas Conductas Fijas	265
		Semi Poleas Motrizes Corredizas	258
		Semi Poleas Motrizes Fijas	253
		Sensores	894
		Silenciadores	214
		Silentbloc	321
		Silentblock Amortiguadores	560
		Sondas Lambda	895
		Soportes Elásticos	321
		T	
		Tambores de Freno	725
		Tapon Gasolina, Aceite Motor, Aceites Frenos	762
		Terminales Bornes	436
		Termostatos	102
		Toberas de Aspiración	121
		Tornillería	743
		Tornillos	743
		Tubos Gasolina - Aceite	757
		Tuercas	743
		Tulipas	834
		Tulipas Intermitentes	891
		V	
		Ventiladores de Poleas	271
		Volante Magnético	952
		W	
		WRAPPER Pintura Spray	1013
		Z	
		Zapatas Freno	600



MOTOR		TRANSMISIONES VESPA APE		FUSIBLES	
Aros de Piston	42	Cables Transmission Scooter	314	Instalaciones Electricas	972
Cadenas Bomba Aceite	60	Caja del Eje Rueda Trasera	320	Intermitentes Completos	827
Cadenas de Distribución KMC	46	Campanas de Embrague - Vespa - Ape	314	Interruptor Termico	894
Caja del Eje de Arranque	304	Correas Ape	231	Interruptores de Embrague	871
Cigüeñales	18	Cruceta Cambio y Engranajes Cambio	317	Interruptores Stop	876
Cofía Cabeza Cilindro	323	Embragues Multidiscos	314	Lamparas	848
Cubierta Volante	323	Partes de Transmission Ape	319	Llaves de Contacto	977
Culatas	41	Selectores Cambio	318	Luces Delanteras	839
Depositos de Aceite	773	CHASIS		Luces Traseras	843
Ejes de Transmisiòn	320	Aplicaciones Manetas de Freno	357	Motores de Arranque	932
Engranajes Kit Arranque	312	Bornes	436	Pick Up	953
Esparragos	749	Caballetes Centrales	502	Pipas de Bujias	825
Filtros Aceite CHAMPION	206	Caballetes Laterales	515	Pipas de Bujias - CHAMPION	824
Filtros Aceite NYPSO	178	Cables Acelerador	412	Pipas de Bujias - NGK	817
Filtros Aceite NYPSO - Tabla de Aplicaciones	189	Cables Arranque	422	Puños Electricos	862
Filtros Aceite UFI	188	Cables Cuenta Km	404	Reguladores de Tension	918
Filtros Gasolina	202	Cables Freno	408	Relés Arranque	901
Gomas Varias - Piaggio	321	Cables Moto	439	Relés Intermitentes	891
Grupo Termico	26	Cables Transmission Ape	425	Relés Ventilador	102
Grupo Termico Racing	38	Cables Vespa	431	Resistencias	893
Kit de Juntas	72	Casquillo de Direccion	731	Resistencias Intermitentes	827
Kit Guías Cadena de Distribucion	70	Cerraduras - RMS - ZADI	967	Sensores	894
Kits Revision Bomba de Agua	94	Conductos de Cables	783	Termostatos	102
Kits Revision Eje Motor	109	Fundas de Cables	439	Tulipas	834
Muelles de Arranque	305	Gomas Chasis Vespa	781	Tulipas Intermitentes	891
Piñones de Arranque	302	Horquillas	728	Volante Magnetico	952
Pistones	42	Interruptores de Arranque	964	CARROCERIA	
Ruedas Libres de Arranque	308	Jaula de Aguja Superiores	742	Adaptadores Espejos	499
Sector de Arranque	301	Llantas	726	Alfombrillas Vespa	776
Silentbloc	321	Mando Gas Vespa	440	Anagramas	788
Soportes Elasticos	321	Mandos de Cambio y Gas	440	Cubre Direccion	770
SISTEMA DE ADMISION		Mandos Gas - DOMINO	384	Cubre Manillares	769
Bombas de Gasolina	758	Manetas de Freno	338	Detalles Chasis	784
Cajas de Laminas	121	Pedales	784	Espejos Retrovisores	444
Colector Aspiracion-Escape	121	Pedales de Arranque	306	Gomas de Escudo Vespa	779
Correas Mezclador	231	Portamanetas - DOMINO	381	Guardabarros	766
Depositos de Gasolina	774	Puños - Domino	390	Kit Estribos Vespa	778
Filtros Aire - NYPSO - UFI	126	Puños - RMS	398	Kit Gomas Tapa Lateral	782
Filtros Aire - Tabla de Aplicaciones	145	Terminales Bornes	436	Letreros	788
Filtros Aire CHAMPION	160	SUSPENSIONES		Piñones Cuentakm	438
Filtros Aire Quad	144	Amortiguadores FORSA	530	Portamatriculas	784
Filtros Aire Racing	142	Prolongadores de Amortiguador	559	Salvabarros	774
Goma de Aspiracion	120	Silentblock Amortiguadores	560	NEUMATICOS	
Grifos y Bombas de Gasolina	754	SISTEMA DE FRENOS		Cubiertas - Camaras KENDA	984
Tapon Gasolina, Aceite Motor, Aceites Frenos	762	Aplicaciones Pastillas de Freno RMS - SINTER	603	Neumaticos	984
Toberas de Aspiracion	121	Bombas Freno	723	ACCESORIOS	
Tubos Gasolina-Aceite	757	Cilindros Frenos	723	Caballetes de Competicion	1022
SISTEMA DE ESCAPE		Discos Frenos	704	Candados - Cadenas	1023
Colectores de Escape	124	Pastillas de Freno RMS - SINTER	562	Cargadores de Baterias - BS	811
Lana Tubo de Escape	215	Tambores de Freno	725	Cargadores de Baterias - ELEKTRA	814
Silenciadores	214	Zapatas Freno	600	Eslingas para Transporte	1021
Sondas Lambda	895	BATERIAS		Fundas Moto	1021
COJINETES		Baterias - BS	807	Kit de Primeros Auxilios	1025
Cojinetes de Bolas	104	Baterias ELEKTRA	813	Kit de Reparacion Tubeless AIRMAN	1018
Estuche a Bobina/Rodillo	108	Baterias Litio LI-ON	802	Kit Repara-Pinchazos Tubeless	1020
Jaula de Aguja	108	Correas para Bateria	814	Kits de Conversion LED	854
SISTEMA DE RETENES		INSTALACION ELECTRICA		Kits Revision Scooter	299
Retenes	113	Bobinas	903	Portaequipajes Vespa	775
Retenes de la Valvula	61	Bobinas de Encendido BERU	910	LUBRICANTES Y PRODUCTOS QUIMICOS	
Retenes Ordenados por Medida	118	Bombillas Led	854	Aceite motor - ENEOS	1002
TRANSMISIONES MOTOCICLETA		Botones Claxon	859	Aceite motor - PETRONAS LINX	1005
Cadenas con Toricas	326	Bujias CHAMPION	818	TALLER	
Cadenas Transmision KMC- AMC	326	Bujias NGK	816	Estractores Volantes	1061
TRANSMISIONES SCOOTER		Centralinas Electronicas - CDI	898	Herramientas para Taller - BIKESERVICE	1028
Campanas de Embrague	242	Cerraduras de Contacto - RMS - ZADI	958	Llaves Bujias	1062
Correas Transmision DAYCO - RMS	218	Claxons	866	Medidores Graduados Centilitros	757
Guias de Variador	271	Condensadores	976	Productos Quimicos para Motocicleta MUC-OFF	996
Kits Polea Motriz	269	Conectores Eléctricos	973	Productos Quimicos para Motocicleta PETRONAS	1004
Mordazas	232	Cuentakilometros Vespa	763	Productos Quimicos para Taller AREXONS	1007
Placa Portarodillos	270	Desviadores Luces	859	Rodamientos	743
Rodillos Variador	272	Estators	944	Tornilleria	743
Semi Poleas Conductas Corredizas	267			Tornillos	743
Semi Poleas Conductas Fijas	265			Tuercas	743
				WRAPPER Pintura Spray	1013



A			
Adaptateurs Retroviseurs	499	Dispositifs électriques	862
Ammortisseurs FORSA	530	Disques Frein	704
Ampoules	848	Doseurs	757
Ampoules Led	854	Durite Essence - Huile	757
Arbres de Transmission	320	Durite Poignee/Gaz Vespa	440
Axe de Kick	301	E	
Axes de Roue Arrière	320	Echappements	214
B		Ecrous	743
Batteries - BS	807	Embrayages	232
Batteries ELEKTRA	813	Embrayages Multi-Disque	314
Batteries Lithium LI-ON	802	Engrenage Roue Démarrage	312
Bavettes	774	Ensembles de Pistons	42
Béquilles Centrales	515	Extensions Amortisseur	559
Béquilles de Stand	1022	Extracteur Volant Magnétique	1061
Béquilles Latérales	502	F	
Bobines d'Allumage BERU	910	Fan de Relais	102
Bobines HT	903	Fan de Variateur	271
Boite de Démarrage	304	Feux Arrieres	843
Bornier	436	Feux Intermittentes	891
Bouchons Essence, Huile Moteur, Huile Freins	762	Filtre à Air - Tableau d'Applications	145
Bougies CHAMPION	818	Filtre à Air CHAMPION	160
Bougies NGK	816	Filtre à Air NYPSO - UFI	126
Boulons	743	Filtre à Air Quad	144
C		Filtre à Air Racing	142
Cablage	972	Filtre à Huile CHAMPION	206
Cable Vespa	431	Filtre à Huile NYPSO	178
Cables Compteur	404	Filtre à Huile NYPSO - Tableau d'Applications	189
Cables de Demarreur	422	Filtre à Huile UFI	188
Cables de Frein	408	Filtre Essence	202
Cables de Gaz	412	Flasque Variateur Fixe Arriere	265
Cables Moto	439	Flasque Variateur Fixe Avant	253
Cables Transmission Ape	425	Flasque Variateur Mobile Arriere	267
Cabochons de Clignotant	834	Flasque Variateur Mobile Avant	258
Caches Direction	770	Fourches	728
Cage à Aiguilles	108	Frein à Tambour	725
Caoutchouc Chassis Vespa	781	Fusibles	896
Caoutchouc d'Admission	121	G	
Capot du Volant	323	Gaines de Câbles	439
Capteur	953	Galet Variateur	272
Capteurs	894	Garde-boues	766
Capuchon bougies	825	Goujons	749
Capuchon bougies - CHAMPION	824	Guides du Variateur	271
Capuchon bougies - NGK	817	H	
CDI	898	Housses Moto	1021
Chaines Antivol	1023	Huile Moteur - ENEOS	1002
Chaines de Distribution KMC	46	Huile Moteur - PETRONAS LINX	1005
Chaines Joints	326	I	
Chargeurs de Batteries - BS	811	Insignes de Carrosserie	788
Chargeurs de Batteries - ELEKTRA	814	Interrupteur Klaxon	859
Clapets	120	Interrupteurs d'Embrayage	871
Clé à Bougie	1062	J	
Clignotants	827	Jantes	726
Cloches Embrayage	242	Jeu de Baguettes Vespa	778
Cloches Embrayage - Vespa - Ape	314	Joint d'Huile - tableau par dimension	118
Coiffe Culasse	323	Joints des Vannes	61
Collecteur d'Échappement	124	Joints Transmission Ape	319
Commutateur Feu	859	K	
Commutateur Stop	876	Kick Démarrage	306
Commutateurs de Démarrage	964	Kit caoutchoucs de panneau latéral	782
Compteurs de vitesse Vespa	763	Kit Cylindre - Racing scooter 50 cc.	38
Condensateur	976	Kit Cylindre - Type Original	26
Connecteurs Electriques	973	Kit de Premiers Secours	1025
Contacteur Thermique	894	Kit de Serrure - RMS - ZADI	967
Contacteurs - RMS - ZADI	958	Kit de Transformation LED	854
Cosses et Bornes	436	Kit Guides Chaines de Distribution	70
Courroie Ape - Cyclomoteur	231	Kit Joints	72
Courroie de Mélangeur	231	Kit Joints d'Huile	113
Courroies DAYCO - RMS	218	Kit Reparation Pompe à Eau	94
Couvres Guidon	769	Kit Reparation Tubeless	1020
Croisillons	317	Kit Reparation Tubeless AIRMAN	1018
Culasses	41	Kit Reparation Vilebrequins	109
Cylindre du Frein	723	Kit Variateur	269
D		Kits Entretien Scooter	299
Demarreures électriques	932	Klaxon	866
		L	
		Laine de Roche	215
		Leviers Freinage	338
		Leviers Freinage - Tableau d'Applications	357
		M	
		Machoirs de Freins	600
		Manchon Vanne	121
		N	
		Noix de Kick	302
		O	
		Optique	839
		Outillage pour atelier - BIKESERVICE	1028
		P	
		Passe-fils	783
		Pédales	784
		Peinture WRAPPER	1013
		Pièces de Carrosserie	784
		Pièces en Caoutchouc pour Moteur	321
		Pignons Compteurs de Vitesse	438
		Pipes d'Admission	121
		Pistons	42
		Plaquettes de Freins - Applications RMS - SINTER	603
		Plaquettes de Freins RMS - SINTER	562
		Plateau Appui Galets	270
		Pneumatiques - KENDA	984
		Pneus	984
		Poignées - DOMINO	390
		Poignées - RMS	398
		Poignées de Gaz - DOMINO	384
		Pompe Huile Chaines	60
		Pompes a Essence	758
		Pompes Freins	723
		Porte Plaque	784
		Porte-bagages Vespa	775
		Produits Chimiques pour Atelier AREXONS	1007
		Produits Chimiques pour Moto MUC-OFF	996
		Produits Chimiques pour Moto PETRONAS	1004
		Profilés Vespa	779
		R	
		Régulateurs de Tension	918
		Relais de Clignotants	891
		Relais Démarrage	901
		Réservoir de carburant	774
		Réservoir d'Huile	773
		Résistances	893
		Résistances Clignotants	827
		Ressort de Kick	305
		Retroviseurs	444
		Robinet - Pompe a Essence	754
		Rondelles	743
		Roues Libres Demarreur	308
		Roulements à Billes	104
		Roulements à Rouleaux	108
		Roulements à Rouleaux supérieures	742
		Roulements de Direction	731
		S	
		Sangle Support Batterie	814
		Sangles de Transport	1021
		Secteurs Vitesse	318
		Silentbloc	321
		Silentblock Amortisseurs	560
		Sondes Lambda	895
		Stators	944
		Support de Levier - DOMINO	381
		Supports de Moteur en Caoutchouc	321
		T	
		Tapis de sol Vespa	776
		Thermostat	102
		Transmission Chaines KMC- AMC	326
		Transmissions Compteur Km.	314
		V	
		Vilebrequins	18
		Vis platine	977
		Visserie	743
		Volants	952



MOTEUR		Galet Variateur	272	CDI	898	
Arbres de Transmission	320	Guides du Variateur	271	Clignotants	827	
Axe de Kick	301	Kit Variateur	269	Commutateur Feu	859	
Boite de Demarrage	304	Plateau Appui Galets	270	Commutateur Stop	876	
Capot du Volant	323	TRANSMISSIONS VESPA - APE			Compteurs de vitesse Vespa	763
Chaines de Distribution KMC	46	Axes de Roue Arrière	320	Condensateur	976	
Coiffe Culasse	323	Cloches Embrayage - Vespa - Ape	314	Connecteurs Electriques	973	
Culasses	41	Courroie Ape - Cyclomoteur	231	Contacteur Thermique	894	
Engrenage Roue Démarrage	312	Croisillons	317	Contacteurs - RMS - ZADI	958	
Ensembles de Pistons	42	Embrayages Multi-Disque	314	Demarreurs électriques	932	
Filtre à Huile CHAMPION	206	Joints Transmission Ape	319	Dispositifs électriques	862	
Filtre à Huile NYPSO	178	Secteurs Vitesse	318	Fan de Relais	102	
Filtre à Huile NYPSO – Tableau d'Applications	189	Transmissions Compteur Km.	314	Feux Arrieres	843	
Filtre à Huile UFI	188	CHASSIS			Feux Intermittentes	891
Filtre Essence	202	Béquilles Centrales	515	Fusibles	896	
Goujons	749	Béquilles Latérales	502	Interrupteur Klaxon	859	
Kit Cylindre - Racing scooter 50 cc.	38	Bornier	436	Interrupteurs d'Embrayage	871	
Kit Cylindre - Type Original	26	Cable Vespa	431	Klaxon	866	
Kit Guides Chaines de Distribution	70	Cables Compteur	404	Optique	839	
Kit Joints	72	Cables de Demarreur	422	Régulateurs de Tension	918	
Kit Reparation Pompe à Eau	94	Cables de Frein	408	Relais de Clignotants	891	
Kit Reparation Vilebrequins	109	Cables de Gaz	412	Relais Demarrage	901	
Noix de Kick	302	Cables Moto	439	Résistances	893	
Pièces en Caoutchouc pour Moteur	321	Cables Transmission Ape	425	Résistances Clignotants	827	
Pistons	42	Caoutchouc Chassis Vespa	781	Stators	944	
Pompe Huile Chaines	60	Commutateurs de Demarrage	964	Thermostat	102	
Réservoir d'huile	773	Cosses et Bornes	436	Vis platiné	977	
Ressort de Kick	305	Durite Poignee/Gaz Vespa	440	Volants	952	
Roues Libres Demarreur	308	Fourches	728	CARROSSERIE		
Silentbloc	321	Gaines de Câbles	439	Adaptateurs Retroviseurs	499	
Supports de Moteur en Caoutchouc	321	Jantes	726	Bavettes	774	
Vilebrequins	18	Kick Demarrage	306	Caches Direction	770	
SYSTÈME D'ADMISSION		Kit de Serrure - RMS - ZADI	967	Couvres Guidon	769	
Bouchons Essence, Huile Moteur, Huile Freins	762	Leviers Freinage	338	Garde-boues	766	
Caoutchouc d'Admission	121	Leviers Freinage - Tableau d'Applications	357	Insignes de Carrosserie	788	
Clapets	120	Passe-fils	783	Jeu de Baguettes Vespa	778	
Courroie de Mélangeur	231	Pédales	784	Kit caoutchoucs de panneau latéral	782	
Durite Essence - Huile	757	Poignées - DOMINO	390	Pièces de Carrosserie	784	
Filtre à Air - Tableau d'Applications	145	Poignées - RMS	398	Pignons Compteurs de Vitesse	438	
Filtre à Air CHAMPION	160	Poignées de Gaz - DOMINO	384	Porte Plaque	784	
Filtre à Air NYPSO - UFI	126	Roulements à Rouleaux supérieures	742	Profilés Vespa	779	
Filtre à Air Quad	144	Roulements de Direction	731	Retroviseurs	444	
Filtre à Air Racing	142	Support de Levier - DOMINO	381	Tapis de sol Vespa	776	
Manchon Vanne	121	SUSPENSIONS			PNEUS	
Pipes d'Admission	121	Ammortisseurs FORSA	530	Pneumatiques - KENDA	984	
Pompes a Essence	758	Extensions Amortisseur	559	Pneus	984	
Réservoir de carburant	774	Silentblock Amortisseurs	560	ACCESSOIRES		
Robinet - Pompe a Essence	754	SYSTÈME DE FREINAGE			Béquilles de Stand	1022
SYSTÈME D'ÉCHAPPEMENT		Cylindre du Frein	723	Chaines Antivol	1023	
Collecteur d'Échappement	124	Disques Frein	704	Chargeurs de Batteries - BS	811	
Echappements	214	Frein à Tambour	725	Chargeurs de Batteries - ELEKTRA	814	
Laine de Roche	215	Machoières de Freins	600	Housses Moto	1021	
Sondes Lambda	895	Plaquettes de Freins - Applications RMS - SINTER	603	Kit de Premiers Secours	1025	
ROULEMENT		Plaquettes de Freins RMS - SINTER	562	Kit de Transformation LED	854	
Cage à Aiguilles	108	Pompes Freins	723	Kit Reparation Tubeless	1020	
Roulements à Billes	104	BATTERIES			Kit Reparation Tubeless AIRMAN	1018
Roulements à Rouleaux	108	Batteries - BS	807	Kits Entretien Scooter	299	
SYSTÈME DE JOINTS		Batteries ELEKTRA	813	Porte-bagages Vespa	775	
Joint d'Huile - tableau par dimension	118	Batteries Lithium LI-ON	802	Sangles de Transport	1021	
Joints des Vannes	61	Sangle Support Batterie	814	LUBRIFIANTS ET PRODUITS CHIMIQUES		
Kit Joints d'Huile	113	SYSTÈME ÉLECTRIQUE			Huile Moteur - ENEOS	1002
TRANSMISSIONS MOTOS		Ampoules	848	Huile Moteur - PETRONAS LINX	1005	
Chaines Joints	326	Ampoules Led	854	ATELIER		
Transmission Chaines KMC- AMC	326	Bobines d'Allumage BERU	910	Boulons	743	
TRANSMISSIONS SCOOTER		Bobines HT	903	Clé a Bougie	1062	
Cloches Embrayage	242	Bougies CHAMPION	818	Doseurs	757	
Courroies DAYCO - RMS	218	Bougies NGK	816	Ecrous	743	
Embrayages	232	Cablage	972	Extracteur Volant Magnétique	1061	
Fan de Variateur	271	Cabochons de Clignotant	834	Outillage pour atelier - BIKESERVICE	1028	
Flasque Variateur Fixe Arriere	265	Capteur	953	Peinture WRAPPER	1013	
Flasque Variateur Fixe Avant	253	Capteurs	894	Produits Chimiques pour Atelier AREXONS	1007	
Flasque Variateur Mobile Arriere	267	Capuchon bougies	825	Produits Chimiques pour Moto MUC-OFF	996	
Flasque Variateur Mobile Avant	258	Capuchon bougies - CHAMPION	824	Produits Chimiques pour Moto PETRONAS	1004	
		Capuchon bougies - NGK	817	Rondelles	743	
				Visserie	743	



RMS
YOUR BEST PARTNER

▶ **ALBERI MOTORE**
CRANKSHAFTS

▶ **CILINDRI**
CYLINDER KITS

▶ **PISTONI**
PISTON KITS

▶ **RMS**
YOUR BEST PARTNER

▶  **FEDERAL
MOGUL**

▶  **GOETZE**



MINARELLI VERTICALE - VERTICAL

SPINOTTO Ø 10 MM. - PIN Ø 10 MM

APRILIA 50: Amico 94-98 • Amico Gl-Gle 93-95 • Amico Lx • Sport-Cat 92-93 • Sr 93

ITALJET 50: Pista 2 • Scoop 2-3 • Yankee 95-96

MBK 50: Cw Booster 90-94 • Cw Booster 01-02 • Cw Booster Naked 03 • Cw Booster Spirit 96-00 • Cw Booster Spirit Euro2 02-03 • Cw L Booster 01-03 • Cw L Booster Spirit 03 • Cw R Booster Road 94-95 • Cw Rs Booster Ng 95-99 • Cw Rs Booster Ng 01-02 • Cw Rs Booster Ng Euro1 99-00 • Cw Rsp Booster Rocket 97-98 • Cw Rsx Booster Track 96-98 • Ew Stunt 00-02

YAMAHA 50: Bw's Bump 97-98 • Bw's Naked 03 • Bw's Next Generation 97-02 • Bw's Next Generation Cat 99-00 • Bw's Original 97-02 • Bw's Original Euro2 03 • Bw's R 01 • Cw Bw's Original Euro2 02 • Cw L Bw's 03 • Cw Rs Spy 95-98 • Ew Slider 00-02

STANDARD

BILANCIATO • BIELLA LUCIDATA • GABBIA A RULLI HQ
BALANCED • POLISHED CON ROD • HQ CAGE

INSERTO IN NYLON
WITH LINER

10 001 0010 

10 001 0011 

* **10 003 0010** 

* **10 003 0011** 



MINARELLI ORIZZONTALE - HORIZONTAL

SPINOTTO Ø 10 MM. - PIN Ø 10 MM

APRILIA 50: Gulliver 95-98 • Gulliver Lc 96-98 • Rally 95-03 • Rally Liquid Cooled 96-99 • Scarabeo 93-05 • Sonic 98-07 • Sr 94-96 • Sr Liquid Cooled 94-96 • Sr Www 97-01

BENELLI 50: 491 Gt 98-99 • 491 St 99-01 • K2 98-01 • Naked • Pepe 99-01 • Pepe Lx 03-04

BETA 50: Ark Air 96-08 • Ark Lc 03 • Ark Lc Serie K 04-08 • Eikon 99-03 • Quadra Chrono 502 95-99 • Tempo 94-99

MALAGUTI 50: Centro Base 93-94 • Ciak 99-00 • Ciak Master 04 • Ciak Mono Eu2 03 • Ciak Mono Euro 2 2.3 03 • F10 Rst Eu1 01-02 • F10 Rst Eu2 02-03 • F10 Rst Eu2 2.3 03-04 • F12 Aria Rst Eu1 06 • F12 Phantom Rst Eu1 01-02 • F12 Phantom Rst Eu2 2.3 03-04 • F15 Fire Fox Air Cooled 06 • F15 Fire Fox Eu2 02-03-F15 Fire Fox Twin Disks & Special 98-99 • Yesterday-Yesterday Eu 97-00

MBK 50: Ya R Forte 94-96 • Ye Evolis 92-95 • Yh Flipper 98 • Yh Flipper 01-02 • Yh Flipper Catalitico 99-00 • Ym Fizz 94-95 • Yo Nitro 97-01 • Yo Nitro Eu2 03

YAMAHA 50: Aerox 97-98 • Aerox R 99-00 • Cs Jog R 02 • Yh Why 98 • Yh Why 01-02 • Yh Why Euro1 99-00 • Ym Breeze 94-95 • Ym Neo's Eu2 99

STANDARD

BILANCIATO • BIELLA LUCIDATA • GABBIA A RULLI HQ
BALANCED • POLISHED CON ROD • HQ CAGE

INSERTO IN NYLON
WITH LINER

10 001 0030 

10 001 0031 

* **10 003 0030** 

* **10 003 0031** 





MINARELLI AM6 - AM345

APRILIA - BETA - MALAGUTI - MBK
YAMAHA: MINARELLI AM345-AM6 50 cc.

STANDARD

10 001 0050



APRILIA-PIAGGIO-GILERA 2T 50 CC

APRILIA 50: Sr Street 03-08 • Sr R R Factory 04-09 • Sr R • Factory ie e Carburatore 10
GILERA 50: Runner Purejet 02-10 • Runner Purejet St 08
PIAGGIO 50: Nrg Power Purejet 04-06-Nrg Purejet 02
 (R.O. 8269405)

STANDARD

10 001 0310



APRILIA-PIAGGIO-GILERA 4T 50 CC

SEDE CUSCINETTO LATO FRIZIONE Ø 25 MM.
BEARING SEAT CLUTCH SIDE Ø 25 MM
APRILIA 50: Scarabeo 4t 02-06
PIAGGIO 50: Liberty 4t 00-02-Vespa Et4 00-05 • Zip 4t 00-05
 (R.O. 969203)

STANDARD

10 001 0320



APRILIA - PIAGGIO - GILERA 2T 50 CC

APRILIA 50: Mojito 04-08 • Scarabeo Street 2T Restyling 06-09 • Scarabeo Street 05-06
DERBI 50: Atlantis 2t Eu2 07-09 • Atlantis Bullet 03-05 • Atlantis City 03-06 • Atlantis 02 • Gp1 01-03
GILERA 50: Dna 00-02 • Dna Gp Experience 03-04 • Easy Moving 95-96 • Ice 01-05 • Runner 97-00 • Runner Poggiali 02 • Stalker 97-04 • Stalker Naked 08 • Storm 94-95 • Typhoon 94-97 • Typhoon X 98-99 • Typhoon Xr 00
PIAGGIO 50: Diesis 01 • Fly 2t 05-07 • Free 92 • Free Delivery 00-01 • Free FL 95-02 • Liberty 97-05 • Liberty 2t Rst 04 • Liberty 2t Sport 07-08 • Liberty Ptt Eu2 04-05 • Nrg 94-96 • Nrg Extreme 99-00 • Nrg Mc3 01-04 • Nrg Power Dt 06 • Nrg Rst Mc2 96-98 • Ntt 95-96 • Quartz 92-96 • Sfera 91-93 • Sfera Maquillage 2 94 • Sfera Rst 95-97 • Typhoon 01-08 • Vespa Et2 97-05 • Vespa Lx 2t FL 09 • Vespa S 2t 07-08 • Zip 92-93 • Zip 00-04 • Zip 95-96 • Zip Bimodale 94-97 • Zip Fast Rider 93-94 • Zip Fast Rider Rst 96-97 • Zip Rst 96-99 • Zip Sp 96-00
 (R.O. 4316255)

STANDARD

BILANCIATO • BIELLA LUCIDATA • GABBIA A RULLI HQ
BALANCED • POLISHED CON ROD • HQ CAGE

INSERTO IN NYLON
WITH LINER

10 001 0200

* **10 003 0200**

* **10 003 0201**



10 020 0300 SKF (Nylon)
10 020 0310 SKF (Acciaio - Steel)
10 020 0312 NTN



10 015 0300



ALBERI MOTORE

CRANKSHAFTS

APRILIA - PIAGGIO 4T 50 CC

SEDE CUSCINETTO LATO FRIZIONE Ø 20 MM
BEARING SEAT CLUTCH SIDE Ø 20 MM

APRILIA 50: Scarabeo 4t 02-06 • Scarabeo 4t Restyling Eu 3 06-09 • Scarabeo 4t 4V Net 10 • Scarabeo Quattro 09 • Sport City 4t 08 (R.O. 969428)

DERBI 50: Atlantis 4t Eu2 07 • Atlantis 4t 04-06

PIAGGIO 50: Fly 4t 05-08 • Vespa Lx 4t 05-08 • Vespa S 4t 4v 08-09 • Zip 4t 00-08 • Liberty 4t 05-08 • Rst 04 • 4t Delivery 09 (R.O. 969428)

STANDARD

10 001 0350



APRILIA - DERBI 4T 100 CC

APRILIA 100: Scarabeo 4T Net 10 • 4T Restyling 06/09-4T 10

DERBI 100: Atlantis 4T 04-06 • Boulevard 4T 10
PIAGGIO 100: Fly 4T 06-07 • Zip 4T 06-10 (R.O. 9699585)

STANDARD

10 001 0420



HONDA 2T 50 CC

CUSCINETTO LATO FRIZIONE E VOLANO
Ø 25 MM
BEARING SEAT CLUTCH AND FLYWHEEL SIDE
Ø 25 MM

HONDA 50: Sh 96-Sky-X8R

STANDARD

10 001 0110



HONDA 2T 50 CC

CUSCINETTO LATO FRIZIONE E VOLANO
Ø 20 MM
BEARING SEAT CLUTCH AND FLYWHEEL SIDE
Ø 20 MM

HONDA 50: Sfx-Balj

STANDARD

10 001 0120



HONDA 4T 150 CC

HONDA 150: Sh 150 01-12 • Pantheon Fes 03-05 • S Wing Fes Abs 07-09 • @ 01-05 • Pes 06-10 • Dylan 02-04 (R.O. 13000-KGG-910)

STANDARD

10 001 0151



10 020 0692

HONDA 4T 125 CC

HONDA 125: Sh 150 01-12 • Pantheon Fes 03-05 • S Wing Fes Abs 07-09 • @ 01-05 • Pes 06-10 • Dylan 02-04 (R.O. 13000-KGF-910)

STANDARD

10 001 0500



10 020 0692



KYMCO 2T 50 CC

KYMCO 50: B&W 02 • B&W Euro2 03 • Dink 98-02 • Dink Classic Euro2 03 • Heroism 95-97 • People 99-00 • People 04 • People Euro2 03-08 • People S 05-08 • Sniper 93 • Sniper Dd 94-96 • Super 9 00 • Super 9 Sport Euro2 03-04 • Top Boy 97-00 • Vitality 2t 04 • Yup 02 • Yup Euro2 03 (R.O. 00110201)

STANDARD

10 001 0340 

KYMCO 4T 50 CC

KYMCO 50: Agility 4T R10 06-08 • Agility R12 05 • Filly Lx 01-02 • Filly 98-00 • Super 8 07 (R.O. 00103629)

STANDARD

10 001 0450 

10 001 0470 

MALAGUTI 2T 50 CC

LUNGHEZZA PERNO LATO FRIZIONE 110 MM
CLUTCH SIDE LENGHT 110 MM
MALAGUTI 50: F12 Phantom Lc Eu1 99-00 • F12 Phantom Lc Eu2 02 • F12 Phantom Lc Restyling Eu1 01-02 • F12 Phantom Lc Restyling Eu2-2.3 03-04 • (R.O. 77116200)

STANDARD

10 001 0330 



MALAGUTI 2T 50 CC

MALAGUTI 50: F12 R Phantom Ac 07-10 (R.O. 59012200)

STANDARD

10 001 0040 



PEUGEOT 2T 50 CC

PEUGEOT 50: Buxy 94-97 • Elyseo 99 • Looxor 01-03 • Metal X 02 • Speedfight Acqua 92-98 • Speedfight Aria 97-98 • Speedfight Aria Catalitico 99 • Squab 95-97 • Trekker 98-00 • Vivacity 99 • Vivacity Catalitico 99-02 • Vivacity Vsx-Xr 02-04 • X-Fight 00 • Xrace 03 • Zemith N 97-98 • Zenith L 94-96 • Zenith Ln-Ls 97-98

BILANCIATO • BIELLA LUCIDATA • GABBIA A RULLI HQ
BALANCED • POLISHED CON ROD • HQ CAGE

INSERTO IN NYLON
WITH LINER

* **10 003 0130** 

* **10 003 0131** 





ALBERI MOTORE
CRANKSHAFTS

PEUGEOT 2T 50 CC

PEUGEOT 50: Ludix

PIAGGIO VESPA 2T 125 CC

PIAGGIO 125: Vespa Primavera 125 67-83 • Vespa 125 Et3 67-83 • Vespa Pk 125 82-85 (R.O. 123296)

STANDARD

10 001 0400

STANDARD

10 001 0250

BILANCIATO • BIELLA LUCIDATA • GABBIA A RULLI HQ
BALANCED • POLISHED CON ROD • HQ CAGE

* **10 003 0250**



PIAGGIO VESPA PK 2T 50 CC

CONO PICCOLO A DUE GABBIE
SMALL CONE FLYWHEEL SIDE

PIAGGIO 50: Vespa 50 67-82 • Vespa Pk 50 82-85 - (R.O. 123292)

PIAGGIO VESPA PK 2T 50 CC

CONO VOLANO GROSSO
BIG CONE FLYWHEEL SIDE

PIAGGIO 50: Vespa FL 90 • Vespa N 89-90 • Vespa Pk 50 82-84 • Vespa Pk XL 85-88 • Vespa Pk XL Rush 88-89 (R.O. 224587)

PIAGGIO VESPA PX 125-150 CC

PIAGGIO 125: Vespa Px 98-01 • Vespa Px 30 Anni 07-08 • Vespa Px Eu2 01-07 • Vespa Pxe 81-97

150: Vespa Px 98-01 • Vespa Pxe 81-97 (R.O. 133154)

STANDARD

10 001 0230



STANDARD

10 001 0240



STANDARD

10 001 0270





PIAGGIO VESPA PE 200 CC

PIAGGIO 200: Vespa PE • Cosa
 (R.O. 1331535)

STANDARD

10 001 0280



PIAGGIO VESPA GL SPRINT 150 CC

PIAGGIO 150: Vespa GL Sprint
 (R.O. 131321)

STANDARD

10 001 0290



PIAGGIO VESPA PK 50-125 CC

CONO GROSSO - BIG CONE
PIAGGIO: Vespa Pk 50 A 125 XL

BILANCIATO • BIELLA LUCIDATA
• GABBIA A RULLI HQ
BALANCED • POLISHED CON ROD • HQ CAGE

* **10 003 0310**



PIAGGIO APE 50 CC

PIAGGIO 50: Ape Eu 2 03-10
 (R.O.8462675)

STANDARD

10 001 0410



PIAGGIO SI - BRAVO 2T 50 CC

PIAGGIO 50: Bravo Erre 2 75-81 • Ciao 80-88 • Ciao Eu1 99-01 • Ciao Eu2 02-04 • Ciao Tre 71-99 • Grillo 89-93-Si 79-88 • Si FL2 91-97
 (R.O. 184154) Spinotto Ø 10 mm. - Pin Ø 10 mm
 (R.O. 113708) Spinotto Ø 12 mm. - Pin Ø 12 mm

STANDARD
 SPINOTTO Ø 10 MM. - PIN Ø 10 MM

10 001 0211



STANDARD
 SPINOTTO Ø 12 MM. - PIN Ø 12 MM

10 001 0221





PIAGGIO 125-150 CC 4T

APRILIA 125: Atlantic Eu3 10-12 • Atlantic Eu3 06-08 • Mojito 08 • Scarabeo Motore Piaggio Eu3 06 • Sport City Cube 08-10 • Sport City One 4T Eu3 08-11 • Sport City Street 12 • Sr Motard 12-14

DERBI 125: Boulevard Eu2 04-07 • Boulevard 4T Eu3 08-12 • Gp1 Eu2 06 • Gp1 Low Seat Eu3 07-08 • Rambla 08-09 • Rambla Eu3 2Ver 08 • Sonar 4T 09-11 • Variant Sport 4T Eu3 12

150: Boulevard 4T Eu3 10 • Sonar 4T 09

GILERA 125: Nexus Eu3 07-08 • Runner 4T St Eu3 08-13 • Runner Vx 05-06 • Runner Vx 4T Eu3 06-07 • Runner Vx Race 06 • Runner Vx Sc 06-07 • Runner Vx-Vxr 02-04

PIAGGIO 125: Beverly 01-03 • Beverly Eu3 07-08 • Beverly Eu3 Mic 07 • Beverly Eu3 Sport 07-08 • Beverly Rst 04-05 • Beverly Rst 05-07 • Beverly Tourer Eu3 07-10 • Carnaby 07-10 • Carnaby 07-10 • Fly 05-07 • Fly Eu3 08-11 • Fly Eu3 07 • Hexagon Gtx 00 • Liberty 01-02 • Liberty 4T 06-07 • Liberty 4T 2V Eu3 09-12 • Liberty 4T 2V ie Ptt - Ita 12-13 • Liberty 4T Eu3 06-08 • Liberty 4T Eu3 Delivery - Single 07-15 • Liberty 4T Eu3 Delivery - Tnt - Nexive 08-15 • Liberty 4T Sport Eu3 06-08 • Liberty Rst 04-05 • Liberty Rst Ptt 05-11 • Liberty Sport 06 • Mp3 06-08 • Skipper 4T 00-02 • Super Hexagon Gtx 12 01-02 • Typhoon 4T 2V Eu3 10-11 • Vespa Et4 99-02 • Vespa Granturismo 06-07 • Vespa Granturismo 03-05 • Vespa Granturismo Eu3 06-07 • Vespa Gts Eu3 07-12 • Vespa Gtv 06-08 • Vespa Gtv 4T Navy Eu3 08 • Vespa Lx 05-06 • Vespa Lx 4T Eu3 Touring 10-11 • Vespa Lx 4T Fl 09 • Vespa Lx Eu3 06-08 • Vespa Lx Eu3 ie 09-11 • Vespa Lxv 4T Eu3 06-09 • Vespa Lxv 4T Navy Eu3 07-08 • Vespa Lxv ie 4T 10-13 • Vespa S 4T Eu3 07-08 • Vespa S 4T ie & College 09-11 • X Evo 07-16 • X Evo 07-16 • X Evo 07-16 • X Evo 07-16 • X7 Eu3 08 • X8 05-06 • X8 04 • X8 Premium Eu2 06 • X8 Premium Eu3 06-07 • X8 Street Eu2 06-07 • X9 01-02 • X9 Evolution 05-06 • X9 Evolution 03 • X9 Evolution Eu3 07 • Zip 00-02

150: Fly 05-07 • Fly Eu3 08-11 • Liberty 4T Eu3 08 • Liberty 4T Sport Eu3 08 • Liberty Moc 4T Eu3 09-13 • Vespa Lx 05-06 • Vespa Lx 4T FL 09 • Vespa Lx Eu3 06-08 • Vespa Lx Eu3 ie 09-11 • Vespa Lx Touring 10-12 • Vespa S 4T 08-09 • Vespa S 4T ie & College 09-12 • X8 Street Euro 2 06-08 - w (R.O. 8412985001)

STANDARD

10 001 0480



PIAGGIO 125-150 CC 4T

PIAGGIO 125: Fly 4T 3V ie Eu3 Dt 13-15 • Fly 4T 3V ie Eu3 Lem 12-13 • Liberty 4T 3V ie Eu3 13-14 • Vespa 946 4T 3V Abs 13-15 • Vespa 946 4T 3V Abs Armani 15 • Vespa Lx 4T 3V ie - Touring 12-13 • Vespa Lx Primavera 4T 3V ie 13-16 • Vespa S 4T 3V ie 12 • Vespa Sprint 4T 3V ie 14-15

150: Liberty 4T 3V Lem 13-14 • Vespa Gts Super ie 4T 3V Au,Ex,JP,Ri,T,V 14-15 • Vespa Lt 4T 3V ie 14 • Vespa Lx 4T 3V ie - Touring 12-13 • Vespa Primavera 4T-3V 13-16 • Vespa Sprint 4T 3V ie 15 (R.O. 8805270001)

STANDARD

10 001 0490



SUZUKI BURGMAN 250 CC

SUZUKI 250: Burgman 03-06 • Burgman 98-02

STANDARD

10 001 0370



10 020 0702

SUZUKI BURGMAN 150 CC

SUZUKI 150: Burgman 02-06

STANDARD

10 001 0390



10 020 0702



YAMAHA 4T 50 CC

YAMAHA 50: Neo's 4T 09-12
(R.O. 5STE14001100)

STANDARD

10 001 0060





CILINDRI
CYLINDER KITS

MOTORI PIAGGIO ARIA 50 CC - AIR COOLED PIAGGIO ENGINE 50 CC

Ø 40 MM - CANNA ESTERNA 53,5 MM - EXTERNAL HOLE 53,5 MM

PIAGGIO 50: Free 92-94 • Free FL 95-02 • Liberty 97-05 • Sfera 91-93 • Sfera Rst 95-97 • Zip 92-93 • Zip Fast Raider Rst 96-97

GILERA 50: Easy Moving 95-96 • Stalker 97-04 • Storm 94-95 • Typhoon 94-97

(R.O. 487820)

10 008 0010



10 008 0011



	RICAMBI - SPARE PARTS			RICAMBI - SPARE PARTS	
		10 009 0010 - 40 mm 10 009 0014 - 40,4 mm 10 009 0018 - 40,8 mm			10 009 0011 - 40 mm 10 009 0015 - 40,4 mm
		10 010 0010 - 40 mm 10 010 0014 - 40,4 mm 10 010 0018 - 40,8 mm			10 010 0011 - 40 mm 10 010 0015 - 40,4 mm
		10 068 9040			10 068 9040

MOTORI PIAGGIO ARIA 50 CC - AIR COOLED PIAGGIO ENGINE 50 CC

Ø 40 MM - CANNA ESTERNA 52 MM - EXTERNAL HOLE 52 MM

APRILIA 50: Mojito 04-08 • Scarabeo 2T Eu2 Motore Piaggio 10 • Scarabeo 2T Net 09-10 • Scarabeo Street 2T Restyling 06-09 • Sport City One 2T 08-10 • Scarabeo Street 05-06

DERBI 50: Atlantis 2T Eu2 07-09 • Atlantis 2T 10 • Bullet City 03-06 • Atlantis Two Chic 05 • Boulevard 2T 09 • Sonar 2T 09

GILERA 50: Ice 01-05 • Stalker Naked 08 • Stalker Special edition 07-08 • Stalker 97-10 • Storm Eu 2 07 • Typhoon Xr 00

PIAGGIO 50: Diesis 01 • Fly 2T 05-10 • Liberty 2T Rst 04 • Liberty 2T Sport 06-08 • Liberty 2T 06-08 • Liberty Moc 2T Elle 09-11 • Liberty Ptt Eu2 04-05 • Nrg Power Dt Serie speciale 07-08 • Nrg Power Dt 06-08 • Typhoon 2T E2 10-11 • Typhoon 01-09 • Vespa Lx 2T FL 09-10 • Vespa Lx 2T Touring 10-11 • Vespa Lx 2T 05-08 • Vespa Lxv 2T Navy 08 • Vespa Lxv 2T 06-08 • Vespa S 2T & College 07-10 • Zip 2T 08-10 • Zip 00-04

(R.O. 831116)

10 008 0250



10 008 0251



	RICAMBI - SPARE PARTS			RICAMBI - SPARE PARTS	
		10 009 0010 - 40 mm 10 009 0014 - 40,4 mm 10 009 0018 - 40,8 mm			10 009 0011 - 40 mm 10 009 0015 - 40,4 mm
		10 010 0010 - 40 mm 10 010 0014 - 40,4 mm 10 010 0018 - 40,8 mm			10 010 0011 - 40 mm 10 010 0015 - 40,4 mm
		10 068 9040			10 068 9040



MOTORI PIAGGIO LIQUIDO 50 CC <2000
LIQUID COOLED PIAGGIO ENGINE 50 CC < 2000

GILERA 50: Runner 97-00

PIAGGIO 50: Nrg Extreme 99-00 • Nrg Rst Mc2 96-98 • Zip Sp 96-00
(R.O. 480625)

10 008 0021

	RICAMBI - SPARE PARTS	
		10 009 0011 - 40 mm 10 009 0015 - 40,4 mm
		10 010 0011 - 40 mm 10 010 0015 - 40,4 mm
		10 068 9050

MOTORI PIAGGIO LIQUIDO 50 CC >2000 - LIQUID COOLED PIAGGIO ENGINE 50 CC > 2000

APRILIA 50: Sr Factory 04-09 • Sr Street 03-08

DERBI 50: Gp1 01-03 • Gp1 Eu2 05-06 • Gp1 Open Eu2 06-09 • Gp1 Race Eu2 05-07

GILERA 50: Dna 05-07 • Runner Purejet 02-07 • Runner Sp 05-07

PIAGGIO 50: Nrg Mc 01-04 • Nrg Purejet 02-08 • Zip St 01-04 • Zip Sp Eu2 06-09
(R.O. 830656/833596)

10 008 0090

	RICAMBI - SPARE PARTS	
		10 009 0010 - 40 mm 10 009 0014 - 40,4 mm 10 009 0018 - 40,8 mm
		10 010 0010 - 40 mm 10 010 0014 - 40,4 mm 10 010 0018 - 40,8 mm
		10 068 9070

10 008 0091

	RICAMBI - SPARE PARTS	
		10 009 0011 - 40 mm 10 009 0015 - 40,4 mm
		10 010 0011 - 40 mm 10 010 0015 - 40,4 mm
		10 068 9070



CILINDRI CYLINDER KITS

MOTORI PIAGGIO 4T 50 CC - PIAGGIO ENGINE 4T 50 CC

Ø 39 MM - MOTORI 4T - 4T ENGINE

DERBI 50: Atlantis 4T Eu2 07 • Atlantis 4T 04-06 • Boulevard 4T Eu2 09
PIAGGIO 50 4T: Fly Motore Chn 06-07 • Fly 05-07 • Fly 08-10 •
 Liberty Delivery Tnt 09 • Liberty Ptt 09-10 • Liberty Rst 04 • Liberty
 Sport 06 • Liberty Sport 07-08 • Liberty 4T 00-02 • Liberty 4T 05-08
 • Liberty Moc 4T & Elle 09-10 • Vespa Et4 00-05 • Vespa Lx 4T 05-08 •
 Zip 4T 00-05 • Zip 4T 06-10
 (R.O. 969603)

10 008 0101



RICAMBI - SPARE PARTS	
	<p>10 009 0101 - 39 mm 10 009 0104 - 39,4 mm 10 009 0108 - 39,8 mm</p>
	<p>10 010 0101 - 39 mm 10 010 0104 - 39,4 mm 10 010 0108 - 39,8 mm</p>
	<p>10 068 9101</p>

MOTORI PIAGGIO 4T 125 CC - PIAGGIO ENGINE 4T 125 CC

Ø 57 MM - MOTORI 4T - 4T ENGINE

PIAGGIO 125: Hexagon Lx4 98-99 • Liberty 98-00 • Sfera 95-97
 • Vespa Et4 96-98
 (R.O. 485945)

10 008 0060



RICAMBI - SPARE PARTS	
	<p>10 009 0060 - 57 mm</p>
	<p>-</p>
	<p>-</p>

PIAGGIO 125 4T CC - PIAGGIO 4T 125 CC

Ø 57 MM - MOTORI 4T - 4T ENGINE - GHISA - CAST IRON

PIAGGIO 125: Fly Eu3 07 • Fly 05-07 • Liberty 4T 2V Eu3 09-12
 • Liberty 4T 2V ie Ptt - Ita 12 • Liberty 4T Eu3 Delivery Single 07-12
 • Liberty 4T Eu3 Delivery - Tnt 08-09 • Liberty 4T Eu3 07-08 • Liberty
 4T Sport Eu3 06-08 • Liberty 4T 06-07 • Liberty Rst Ptt 05-11 • Liberty
 Rst 04-05 • Liberty Sport 06 • Liberty 01-02 • Skipper 4T 00-02 •
 Typhoon 4T 2V Eu3 10-11 • Vespa Et4 99-02 • Vespa Lx 4T Eu3 Tou-
 ring 10-11 • Vespa Lx 4T FL 09 • Vespa Lx Eu3 ie 09-11 • Vespa Lx Eu3
 06-08 • Vespa Lx 05-06 • Vespa Lxv 4T Eu3 06-09 • Vespa Lxv 4T Navy
 Eu3 07-08 • Vespa Lxv ie 4T 10-13 • Vespa S 4T Eu3 07-08 • Vespa S 4T
 ie & College 09-11 • Zip 00-02
 (R.O. 831975)

10 008 0531



RICAMBI - SPARE PARTS	
	<p>10 009 0531 - 57 mm</p>
	<p>10 010 0531 - 57 mm</p>
	<p>-</p>

LML 150 CC 2T Ø 57,8 MM - LML 150 CC 2T Ø 57,8 MM

Ø 57,8 MM - FASCE 2 MM - PISTON RINGS 2 MM
 LML 150: 2T

10 008 0630



FEDERAL
MOGUL

RICAMBI - SPARE PARTS	
	<p>GOETZE 10 009 0630 - 57,8 mm 10 009 0632 - 58 mm 10 009 0634 - 58,2 mm</p>
	<p>-</p>
	<p>10 068 4110</p>



PIAGGIO APE CAR Ø 68 MM SPINOTTO 18 MM
PIAGGIO APE CAR Ø 68 MM PIN 18 MM

Ø 68 MM - SPINOTTO Ø 18 MM - PISTON PIN Ø 18 MM
PIAGGIO 220: Ape Car P2-P3 78-85 • Ape Tm P602 82-83 • Ape Tm P703-P703V 84-05
(R.O. 828864)

10 008 0181



NEW

RICAMBI - SPARE PARTS	
	 10 009 0181 - 68 mm 10 009 0186 - 68,6 mm 10 009 0188 - 68,8 mm
	 10 010 0180 - 68 mm 10 010 0186 - 68,6 mm 10 010 0188 - 68,8 mm
	10 070 3080 10 070 5320

MOTORI PIAGGIO APE MP Ø 68 MM
PIAGGIO ENGINE APE MP Ø 68 MM

Ø 68 MM - SPINOTTO Ø 18 MM - PISTON PIN Ø 18 MM
PIAGGIO 220: Ape Mp P501-P601 78-96
(R.O. 243117)

10 008 0191



NEW

RICAMBI - SPARE PARTS	
	 10 009 0181 - 68 mm 10 009 0186 - 68,6 mm 10 009 0188 - 68,8 mm
	 10 010 0180 - 68 mm 10 010 0186 - 68,6 mm 10 010 0188 - 68,8 mm
	10 070 3080 10 070 5320

PIAGGIO CIAO Ø 38,2 MM SPINOTTO 10 MM
PIAGGIO CIAO Ø 38,2 MM PIN 10 MM

Ø 38,2 MM - SPINOTTO Ø 10 MM - PISTON PIN Ø 10 MM
PIAGGIO 50: Ciao
(R.O. 196121)

10 008 0310



RICAMBI - SPARE PARTS	
	 10 009 0314 - 38,4 mm 10 009 0316 - 38,6 mm 10 009 0318 - 38,8 mm
	 10 010 0314 - 38,4 mm 10 010 0316 - 38,6 mm 10 010 0318 - 38,8 mm
	10 068 4000

PIAGGIO VESPA PX - PE 150 CC Ø 57,8 MM
PIAGGIO VESPA PX - PE 150 CC Ø 57,8 MM

Ø 57,8 MM - FASCE 2,5 MM - PISTON RINGS 2,5 MM
PIAGGIO 150: Vespa Px • Vespa Pe • Cosa
(R.O. 244172)

10 008 0670



FEDERAL MOGUL

RICAMBI - SPARE PARTS	
	 Per 10 008 0370 10 009 0418 - 57,8 mm
	 GOETZE Per 10 008 0670 10 009 0670 - 57,8 mm 10 009 0676 - 58,4 mm 10 009 0678 - 58,6 mm
	-
	10 068 4110



CILINDRI
CYLINDER KITS

PIAGGIO VESPA SPRINT 150 CC Ø 57 MM
PIAGGIO VESPA SPRINT 150 CC Ø 57 MM

Ø 57 MM - FASCE 2,5 MM - PISTON RINGS 2,5 MM
PIAGGIO 150: Vespa Sprint
(R.O. 90628)

10 008 0660



FEDERAL MOGUL

	RICAMBI - SPARE PARTS	
		Per 10 008 0410 10 009 0414 - 57,4 mm 10 009 0416 - 57,6 mm 10 009 0418 - 57,8 mm
		GOETZE Per 10 008 0660 10 009 0660 - 57 mm 10 009 0664 - 57,4 mm 10 009 0666 - 57,6 mm
		10 068 4080

PIAGGIO VESPA PK 125 Ø 55 MM
PIAGGIO VESPA PK 125 Ø 55 MM

Ø 55 MM
PIAGGIO 125: Vespa Pk 125
(R.O. 196771)

10 008 0420



	RICAMBI - SPARE PARTS	
		10 009 0424 - 55,4 mm 10 009 0426 - 55,6 mm
		10 070 3090

PIAGGIO VESPA PE 200 Ø 66,5 MM
PIAGGIO VESPA PE 200 Ø 66,5 MM

Ø 66,5 MM
PIAGGIO 200: Vespa Pe • Cosa • Rally VSX1T - VSR1T - VSE1T
(R.O. 414708)

10 008 0700



NEW

	RICAMBI - SPARE PARTS	
		10 070 4010

PIAGGIO VESPA 50 Ø 38,4 MM
PIAGGIO VESPA 50 Ø 38,4 MM

Ø 38,4 MM - 3 TRAVASI - 3 INTAKE PORTS
PIAGGIO 50: Vespa • Ape

10 008 0521



	RICAMBI - SPARE PARTS	
		10 009 0528 - 38,8 mm 10 009 0529 - 39 mm
		10 010 0521 - 38,4 mm 10 010 0528 - 38,8 mm 10 010 0529 - 39 mm
		10 068 4040



PIAGGIO VESPA PX 125 CC Ø 52,5 MM
PIAGGIO VESPA PX 125 CC Ø 52,5 MM

Ø 52,5 MM - FASCE 2,5 MM - PISTON RINGS 2,5 MM
PIAGGIO 125: Vespa Px
(R.O. 840087)

PIAGGIO VESPA 125 PRIMAVERA Ø 55 MM
PIAGGIO VESPA 125 PRIMAVERA Ø 55 MM

Ø 55 MM
PIAGGIO: Vespa 125 Primavera VMA2T
(R.O. 151981)

10 008 0680



FEDERAL MOGUL

10 008 0650



RICAMBI - SPARE PARTS	
	<p>10 009 0680 - 52,5 mm 10 009 0684 - 52,9 mm 10 009 0686 - 53,1 mm</p>
	<p>10 068 4110</p>

RICAMBI - SPARE PARTS	



CILINDRI CYLINDER KITS

MOTORI MINARELLI ORIZZONTALE 50 CC - MINARELLI HORIZONTAL ENGINE 50 CC

APRILIA 50: Gulliver 95-98 • Rally 95-03 • Scarabeo 93-05 • Sonic 98-07 • Sr 94-96

BETA 50: Ark Air 96-07 • Quadra 502 95-99

MALAGUTI 50: Centro Base 93-94 • F10 Rst Eu1-Eu2 01-03 • F12 Aria Rst Eu2 06 - (R.O. 771625000)

MBK 50: Forte 94-96 • Flipper Cat 99-00 • Fizz 94-95 • Ovetto Eu1-Eu2 97-03

SYM 50: A30-Pure

YAMAHA 50: Breeze 94-95 • Cs Jog 02 • Neo'S 02-10 • Why Eu1 99-00

10 008 0030



10 008 0031



	RICAMBI - SPARE PARTS			RICAMBI - SPARE PARTS	
		10 009 0030 - 40 mm 10 009 0034 - 40,4 mm 10 009 0038 - 40,8 mm			10 009 0031 - 40 mm 10 009 0035 - 40,4 mm
		10 010 0030 - 40 mm 10 010 0034 - 40,4 mm 10 010 0038 - 40,8 mm			10 010 0031 - 40 mm 10 010 0035 - 40,4 mm
		10 068 9010			10 068 9010

MOTORI MINARELLI VERTICALE 50 CC - MINARELLI VERTICAL ENGINE 50 CC

APRILIA 50: Amico 94-98 • Amico GL-GLE 93-95 • Amico Lx • Sport-Cat 92-93

MBK 50: Booster 90-94 • Booster Road 94-95

YAMAHA 50: Bw'S Bump 97-98 • Bw'S Ng 97-98 • Bw'S Original 97-98 • Spy 95-98

(R.O. 3VLE13110000)

10 008 0040



10 008 0041



	RICAMBI - SPARE PARTS			RICAMBI - SPARE PARTS	
		10 009 0030 - 40 mm 10 009 0034 - 40,4 mm 10 009 0038 - 40,8 mm			10 009 0031 - 40 mm 10 009 0035 - 40,4 mm
		10 010 0030 - 40 mm 10 010 0034 - 40,4 mm 10 010 0038 - 40,8 mm			10 010 0031 - 40 mm 10 010 0035 - 40,4 mm
		10 068 9000			10 068 9000



MOTORI MINARELLI 50 CC LIQUIDO - MINARELLI ENGINE 50 CC L. C.

BENELLI 50: 491 Gt 98-99 • 491 Sport 98-99 • K2 LC 99-01

BETA 50: Ark Lc 96-03 • Elkon 99-03

ITALJET 50: Dragster-Formula Lc 97

MALAGUTI 50: F12 Phantom Lc Twin Disks 94-98 • F15 Fire Fox 96-98

MBK 50: Nitro 97-04 • Nitro Eu2 03

(R.O. 77113200)

10 008 0050

10 008 0051

	RICAMBI - SPARE PARTS			RICAMBI - SPARE PARTS	
		10 009 0030 - 40 mm 10 009 0034 - 40,4 mm 10 009 0038 - 40,8 mm			10 009 0031 - 40 mm 10 009 0035 - 40,4 mm
		10 010 0030 - 40 mm 10 010 0034 - 40,4 mm 10 010 0038 - 40,8 mm			10 010 0031 - 40 mm 10 010 0035 - 40,4 mm
		10 068 9020			10 068 9020

MOTORI MINARELLI AM6 50 CC LIQUIDO
MINARELLI ENGINE AM6 50 CC L. C.

APRILIA-BETA-YAMAHA Motori Minarelli Am6.Am345-50

Imposte guarnizioni sulla testa cilindro

Gaskets caves on cylinder head

10 008 0111

	RICAMBI - SPARE PARTS	
		10 009 0111 - 40,3 mm
		10 010 0111 - 40,3 mm
		10 068 9670





CILINDRI CYLINDER KITS

MOTORI KYMCO 50 CC Ø 39 MM KYMCO ENGINE 50 CC Ø 39 MM

Ø 39 MM

KYMCO 50: Agility 4T R10 06-08 • Agility 4T R12 07-08 • Agility 4T R16 08-09 • Agility R12 05 • Filly Lx 01-02 • Filly 98-00 • Super 8 4T 09 • Super 8 07
(R.O. 00103618)

10 008 0381 

RICAMBI - SPARE PARTS	
	10 009 0381 - 39 mm
	-
	10 068 0381

MOTORI KYMCO 125 CC Ø 52,4 MM KYMCO ENGINE 125 CC Ø 52,4 MM

Ø 52,4 MM

KYMCO 125: Agility 4T Eu 3 06-08 • Agility 4T 06 • Agility Carry 11 • Agility R16 08-12 • Agility Rs 09 • Like Lx 12 • Like 09 • People Eu 3 11 • Super 8 08-09
(R.O. 00123115)

10 008 0391 

RICAMBI - SPARE PARTS	
	10 009 0391 - 52,4 mm
	-
	10 068 0391

MOTORI KYMCO 150 CC Ø 57,4 MM KYMCO ENGINE 150 CC Ø 57,4 MM

Ø 57,4 MM

KYMCO 150: Agility R16 08-09
(R.O. 00112042)

10 008 0401 

RICAMBI - SPARE PARTS	
	Per 10 008 0401 10 009 0401 - 57,4 mm
	-
	10 068 0401

MOTORI KYMCO 50 CC 2T ARIA KYMCO ENGINE 50 CC 2T AIR COOLED

Ø 39 MM



KYMCO 50: Agility 2T R16 10-12 • Agility Rs Naked 2T 10 • Dink Classic Eu2 03 • Dink Lc 98-02 • Like 2T 09 • People Eu2 03-11 • People S 05-08 • People 99-04 • Super 8 2T 09 • Top Boy 97-00 • Vitality 2T 04 • Yup Eu2 03 • Yup 02
(R.O. 00102511)

10 008 0461 

Ø Canna esterna 51 mm
External hole 51 mm

10 008 0551 

Ø Canna esterna 49 mm
External hole 49 mm

RICAMBI - SPARE PARTS	
	10 009 0461 - 39 mm
	10 010 0461 - 39 mm
	-



MOTORI SUZUKI 50 CC 2T ARIA
ENGINE SUZUKI 50 CC 2T AIR

APRILIA 50: Habana Custom 99-02
ATALA 50: Byte At 10 • Hacker At 12
DERBI 50: Vamos 93-95
ITALJET 50: Formula • Torpedo (F. Morini) • Velocifero
MALAGUTI 50: Crosser Cr1 95-98
SUZUKI 50: Ah Address 92-95 • Aj Zz Sepia S 95-97 • Ap R-T (R7) 94-97 • Ay Ayw Katana V-Y 97-00 • Uf Estilete 00
TGB 50: R 50 • Laser R • Tapo • 101S • Hawk • Bullet

10 008 0641 **NEW**

	RICAMBI - SPARE PARTS	
		10 009 0641
		10 068 0840

KEEWAY 50 CC 2T ARIA
KEEWAY 50 CC 2T AIR COOLED

Ø 40 MM
KEEWAY 50: Atv Ec2 06 • F-Act Evo 09 • F-Act 07-08 • Flash07-08 • Focus 06 • Hurricane 06-07 • Matrix 06-08 • Ry6 10 • Ry8 Sport 07-10 • Ry808 (R.O. 204200041000)

10 008 0711 **NEW**

Scarico circolare
Round exhaust

10 008 0581

Scarico ovale
Oval exhaust

	RICAMBI - SPARE PARTS	
		100090471 - 40 mm
		100100471 - 40 mm
		10 068 9010

MOTORI PEUGEOT 50 CC 2T
PEUGEOT ENGINE 50 CC 2T

Ø 40 MM
PEUGEOT 50: Buxy 94-97 • Elyseo 99 • Looxor 01-03 • Metal-X 02 • Speedake 95-97 • Speedfight 2 Aria 05-06 • Vivacity Vsx-Xr 02-04

10 008 0070

	RICAMBI - SPARE PARTS	
		10 009 0070 - 40 mm 10 009 0074 - 40,4 mm
		10 010 0070 - 40 mm 10 010 0074 - 40,4 mm
		10 068 9030

MOTORI PEUGEOT LIQUIDO 50 CC 2T
PEUGEOT ENGINE 50 CC L. C.

Ø 40 MM
PEUGEOT 50: Speedfight Acqua 97-98 • X-Fight 00 (R.O. 753038)

10 008 0201

	RICAMBI - SPARE PARTS	
		10 009 0201 - 40 mm
		10 010 0201 - 40 mm
		-



CILINDRI
CYLINDER KITS

MOTORI YAMAHA 125 CC Ø 52 MM
YAMAHA ENGINE 125 CC Ø 52 MM

Ø 52 MM

YAMAHA 125: Vp X-City 08-10 • Yp R X-Max Abs 11 - Yp R X • Max 08-11 • Yzf - R 08-11

10 008 0341



	RICAMBI - SPARE PARTS	
		-
		-

MOTORI YAMAHA 125 CC Ø 53,7 MM
YAMAHA ENGINE 125 CC Ø 53,7 MM

Ø 53,7 MM

YAMAHA 125: Xn Teo's 00 • Xq Maxter 01-02 • Yp E Majesty 03-09 • Yp majesty 98-02

10 008 0350



	RICAMBI - SPARE PARTS	
		-
		10 068 9140



MOTORI HONDA 150 CC Ø 57,5 MM LIQUIDO
HONDA ENGINE 150 CC Ø 57,5 L. C.

Ø 57,5 MM

HONDA 150: Sh 150 01-08 • Nes 4T • Ps 4T • Pantheon 4T

KEEWAY 150: Outlook 07-08

10 008 0440

MOTORI HONDA 125 CC Ø 52,4 MM LIQUIDO
HONDA ENGINE 125 CC Ø 52,4 L. C.

Ø 52,4 MM

HONDA 125: Sh

10 008 0450

RICAMBI - SPARE PARTS	
	10 009 0440 - 57,5 mm
	10 010 0440 - 57,5 mm
	10 068 9090 10 068 0440

RICAMBI - SPARE PARTS	
	10 009 0450 - 52,4 mm
	10 010 0450 - 52,4 mm
	10 068 9080 10 068 0450

MOTORI HONDA 50 CC 2T ARIA
HONDA ENGINE 50 CC 2T AIR COOLED

Ø 39 MM

HONDA 50: Sfx V 95 • Sh 91-96 • Sj Bali 93 • Sky 97 • Sxr 95

10 008 0080

RICAMBI - SPARE PARTS	
	10 009 0080 - 39 mm 10 009 0084 - 39,4 mm 10 009 0088 - 39,8 mm
	10 010 0080 - 39 mm 10 010 0084 - 39,4 mm 10 010 0088 - 39,8 mm
	10 068 9060



GRUPPI TERMICI RACING

RACING CYLINDER KITS

MOTORI MINARELLI ORIZZONTALE MINARELLI HORIZONTAL ENGINE

Ø 47 MM

APRILIA 50: Gulliver 95-98 • Rally 95-03 • Scarabeo 93-05
• Sonic 98-07 • Sr 94-96

MALAGUTI 50: Centro Base 93-94 • F10 Rst Eu1-Eu2 01-03
• F12 Aria Rst Eu2 06

MBK 50: Forte 94-96 • Flipper Cat 99-00 • Fizz 94-95 • Ovetto Eu1-Eu2 97-03

10 008 0490



MOTORI MINARELLI VERTICALE MINARELLI VERTICAL ENGINE

Ø 47 MM

APRILIA 50: Amico 94-98 • Amico GL-GLE 93-95 • Amico Lx
• Sport-Cat 92-93

MBK 50: Booster 90-94 • Booster Road 94-95

YAMAHA 50: Bw'S Bump 97-98 • Bw'S Ng 97-98 • Bw'S Original 97-98
• Spy 95-98

10 008 0500



MOTORI MINARELLI LIQUIDO MINARELLI ENGINE L. C.

Ø 47 MM

APRILIA 50: Sr Liquid Cooled 94-96 • Sr Stealth - Racing 97-99 •
Sonic Gp 98-08 • Rally Liquid Cooled 96-99 • Gulliver Lc 96-98

BENELLI 50: 491 Gt 98-99 • 491 Sport 98-99 • K2 Lc 99-01

BETA 50: Ark Lc 96-03 • Elkon 99-03

ITALJET 50: Dragster-Formula Lc 97

MALAGUTI 50: F12 Phantom Lc-Twin Disks 94-98

• F15 Fire Fox 96-98

MBK 50: Nitro 97-04 • Nitro Eu2 03

YAMAHA 50: Aerox 97-07 • Aerox Eu2 03

10 008 0510



PIAGGIO CIAO Ø 43 MM SPINOTTO 10 MM PIAGGIO CIAO Ø 43 MM PIN 10 MM

Ø 43 MM - SPINOTTO Ø 10 MM - PISTON PIN Ø 10 MM

PIAGGIO 50: Ciao

10 008 0690

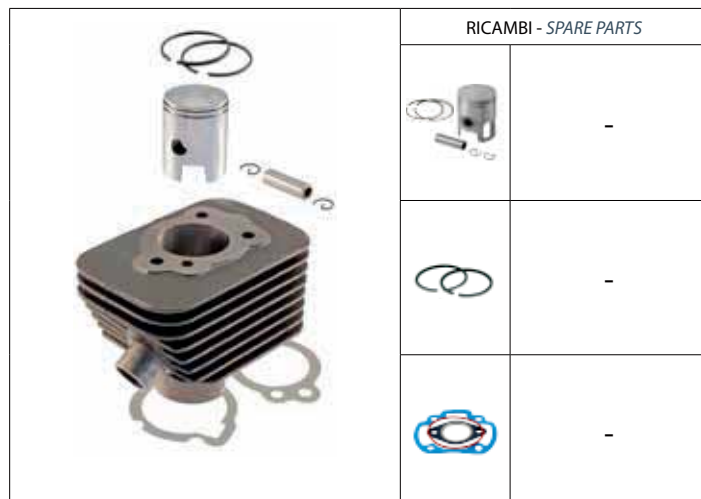



MOTORI PIAGGIO ARIA
AIR COOLED PIAGGIO ENGINE

Ø 47 MM - CANNA ESTERNA 53,5 MM - EXTERNAL HOLE Ø 53,5 MM

DERBI - GILERA 50: Free 92-94 • Free FL 95-02 • Liberty 97-05
• Sfera 91-93 • Sfera Rst 95-97 • Zip 92-93 • Zip Fast Raider Rst 96-97
PIAGGIO 50: Free 92-94 • Free FL 95-02 • Liberty 97-05
• Sfera 91-93 • Sfera Rst 95-97 • Zip 92-93 • Zip Fast Raider Rst 96-97

10 008 0480



	RICAMBI - SPARE PARTS	
		10 009 0560 - 47 mm
		10 010 0550 - 47 mm
		10 068 9720

MOTORI PIAGGIO ARIA
AIR COOLED PIAGGIO ENGINE

Ø 47 MM - CANNA ESTERNA 52 MM - EXTERNAL HOLE Ø 52 MM

PIAGGIO 50: Diesis 01 • Fly 2T 05-10 • Liberty 2T Rst 04 • Liberty 2T Sport 06-08 • Liberty 2T 06-08 • Liberty Moc 2T Elle 09-11 • Liberty Ptt Eu2 04-05 • Nrg Power Dt Serie speciale 07-08 • Nrg Power Dt 06-08 • Typhoon 2T E2 10-11 • Typhoon 01-09 • Vespa Lx 2T FL 09-10 • Vespa Lx 2T Touring 10-11 • Vespa Lx 2T 05-08 • Vespa Lxv 2T Navy 08 • Vespa Lxv 2T 06-08 • Vespa S 2T & College 07-10 • Zip 2T 08-10 • Zip 00-04

10 008 0610



	RICAMBI - SPARE PARTS	
		10 009 0580 - 47 mm
		10 010 0550 - 47 mm
		10 068 9840

MOTORI PIAGGIO LIQUIDO <2000
PIAGGIO ENGINE L. C. <2000

Ø 47 MM

GILERA 50: Runner 97-00

PIAGGIO 50: Nrg Extreme 99-00 • Nrg Rst Mc2 96-98 • Zip Sp 96-00

10 008 0560



	RICAMBI - SPARE PARTS	
		10 009 0560 - 47 mm
		10 010 0550 - 47 mm
		10 068 9760

MOTORI PIAGGIO LIQUIDO >2000
PIAGGIO ENGINE L. C. >2000

Ø 47 MM

APRILIA 50: Sr Factory 04-09 • Sr Street 03-08

DERBI 50: Gp1 01-03 • Gp1 Eu2 05-06 • Gp1 Open Eu2 06-09 • Gp1 Race Eu2 05-07

GILERA 50: Dna 05-07 • Runner Purejet 02-07 • Runner Sp 05-07

PIAGGIO 50: Nrg Mc3 01-04 • Nrg Power Purejet 04-08

Nrg Purejet 02-04 • Zip Sp 01-04 • Zip Sp Eu2 06-09

10 008 0570



	RICAMBI - SPARE PARTS	
		10 009 0570 - 47 mm
		10 010 0570 - 47 mm
		10 068 9770













MOTORI PIAGGIO VESPA APE - PIAGGIO ENGINE VESPA APE

10 008 0281  Ø 47 mm - 3 Travasi - 3 intake ports

10 008 0271  Ø 50 mm - 3 Travasi - 3 intake ports

10 008 0141  Ø 55 mm - 6 Travasi - 6 intake ports

	RICAMBI - SPARE PARTS - Ø 47		RICAMBI - SPARE PARTS - Ø 50		RICAMBI - SPARE PARTS - Ø 55	
		10 009 0280 - 47 mm 10 009 0284 - 47,4 mm 10 009 0288 - 47,8 mm		10 009 0271 - 50 mm 10 009 0274 - 50,4 mm 10 009 0278 - 50,8 mm		10 009 0141 - 55 mm 10 009 0144 - 55,4 mm 10 009 0148 - 55,8 mm
	10 010 0280 - 47 mm 10 010 0284 - 47,4 mm 10 010 0288 - 47,8 mm		10 010 0271 - 50 mm 10 010 0274 - 50,4 mm 10 010 0278 - 50,8 mm		10 010 0141 - 55 mm 10 010 0144 - 55,4 mm 10 010 0148 - 55,8 mm	
	-		-		-	





MOTORI KYMCO 4T
KYMCO ENGINE 4T

Ø 47 MM - FORNITO SENZA TESTA CILINDRO - NO CYLINDER HEAD
KYMCO 50: Agility 4T R10 06-08 • Agility 4T R12 07-08 • Agility 4T R16 08-09 • Agility R12 05 • Filly Lx 01-02 • Filly 98-00 • Super 8 4T 09 • Super 8 07





YAMAHA 150 CC Ø 60,5 MM
YAMAHA ENGINE 150 CC Ø 60,5 MM

Ø 60.5 MM - FORNITO SENZA TESTA CILINDRO - NO CYLINDER HEAD
YAMAHA 125: Yp X-City 08-10 • Yp R X-Max Abs 11 • Yp R X • Max 08-11 • Yzf - R 08-11

10 008 0540 

	RICAMBI - SPARE PARTS	
		10 009 0540 - 47 mm
	10 010 0540 - 47 mm	
	-	

10 008 0621 

	RICAMBI - SPARE PARTS	
		-
	-	
	10 068 0461	

TESTE MOTORE - TIPO ORIGINALE
CYLINDER HEAD - ORIGINAL TYPE



10 007 0021 

PER CILINDRO PIAGGIO RAFF. LIQUIDO MOD.<00
FOR CYLINDER PIAGGIO LIQUID COOLED <00
GILERA 50: Runner 97/98
PIAGGIO 50: Nrg • Nrg Rst Mc2 • Ntt • Quartz



10 007 0081 

PER CILINDRO PIAGGIO RAFF. LIQUIDO MOD.>00
FOR CYLINDER PIAGGIO LIQUID COOLED >00
APRILIA: Sr Fun master Street 03 • Sr R 04
GILERA: Dna • Gp Experience 03-06
 Runner Poggiali • Sp-Sp Race 02-06
PIAGGIO: Nrg Mc3 01-04 • Purejet 02-04
 Nrg Power DD 05-06 • Zip Sp 01-04
 (R.O. 830656-833598)



10 007 0010 

PER CILINDRO PIAGGIO RAFF. ARIA
FOR CYLINDER PIAGGIO AIR COOLED
GILERA: Stalker 97-98 • Storm 94-95
 Easy Moving 95-96 • Typhoon 94-97
PIAGGIO: Free 92-94 • Free FL 95-98
 Sfera Rst 95-97 • Sfera Maquillage-Liberty
 97-98 • Vespa Et2 97-98 • Zip & Zip
 Bimodale 94-97 • Zip Base 92-96 • Zip
 Fast Raider 93-97 • Zip Rst 96-98 -
 (R.O. 286534)



10 007 0020 

PER CILINDRO PIAGGIO RAFF. LIQUIDO MOD.<00
FOR CYLINDER PIAGGIO LIQUID COOLED <00
GILERA: Runner 97-98
PIAGGIO: Quartz 92-96 • Ntt 95-96 • Nrg 94-96
 Nrg Rst Mc2 96-98 • ZIP SP 96-97
 (R.O. 289513)



10 007 0030 

PER CILINDRI MINARELLI ORIZZONTALE
FOR CYLINDER MINARELLI HORIZONTAL
MINARELLI - MBK - YAMAHA
 (R.O. 77701400)



10 007 0040 

PER CILINDRI MINARELLI VERTICALE
FOR CYLINDER MINARELLI VERTICAL
APRILIA - MBK - YAMAHA
 (R.O. 3VLE 11110000)



10 007 0050 

PER CILINDRI MINARELLI LIQUIDO
FOR CYLINDER MINARELLI LIQUID COOLED
MINARELLI - MBK - YAMAHA
 (R.O. 77701600)



10 007 0060 

PER CILINDRO PEUGEOT ARIA
FOR CYLINDER PEUGEOT AIR COOLED
50: Elyseo 99 • SV Geo 91-95 • Zenith L 94-96 •
 Zenith N 97-98 • Zenith LN • LS 97-98 • Spee-
 dake 95-97 • Speedfight 97-98 • Squab 95-97
 • Trekker 98 • Buxy 94-97



10 007 0120 

PER CILINDRI PIAGGIO CIAO Ø 38,2
FOR CYLINDER PIAGGIO CIAO Ø 38,2
 (R.O. 124533)



10 007 0071 

NEW

PER CILINDRI MOTORI MINARELLI
AM6-AM345-50 CC
FOR CYLINDER ENGINE MINARELLI
AM6-AM345-50 CC
APRILIA-BETA
HM-HRD
MOTORHISPANIA
PEUGEOT-RIEJU
YAMAHA



10 007 0123 

NEW

PER CILINDRO LML 10 008 0630
FOR CYLINDER LML 10 008 0630
150: 2T



10 007 0521 

NEW

















































PER CILINDRO PIAGGIO 10 008 0521
FOR CYLINDER PIAGGIO 10 008 0521
50: Vespa Special-N-L-R
 (R.O. 112515)





PISTONI COMPLETI E FASCE PER CILINDRI RMS





















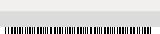













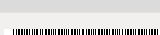
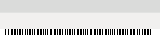









PISTONS AND PISTON RINGS FOR RMS CYLINDERS

							
		PISTONI COMPLETI PER CILINDRI RMS <i>PISTONS FOR RMS CYLINDERS</i>			KIT FASCE ELASTICHE PER PISTONI RMS <i>PISTON RINGS FOR RMS PISTONS</i>		
APPLICAZIONI - APPLICATIONS	CC.	Ø PISTONE MM Ø PISTON MM	CODICE RMS RMS CODE	CODICE A BARRE BARCODE	Ø FASCE ELASTICHE MM Ø PISTON RINGS MM	CODICE RMS RMS CODE	CODICE A BARRE BARCODE
Aprilia - Beta - Malaguti - Mbk - Sym Minarelli Orizzontale - (Per For 10 008 0031)	50	40	10 009 0031		40 x 1,2	10 010 0031	
	50	40,4	10 009 0035		40,4 x 1,2	10 010 0035	
Minarelli - MBK - Yamaha (Raffr. Aria e Liquido) Minarelli - MBK - Yamaha (Liquid and air cooled)	50	40	10 009 0030		40 x 1,5	10 010 0030	
		40,4	10 009 0034		40,4 x 1,5	10 010 0034	
		40,8	10 009 0038		40,8 x 1,5	10 010 0038	
Minarelli - MBK - Yamaha (Verticale) Minarelli - MBK - Yamaha (Vertical)	50	-	-	-	40 x 1,2	10 010 0040	
		-	-	-	40,4 x 1,2	10 010 0044	
		-	-	-	40,8 x 1,2	10 010 0048	
Minarelli - AM6 - Aprilia - Beta HM - Peugeot - Yamaha	50	40,3	10 009 0111		40,3 x 1,2	10 010 0111	
Piaggio - Gilera - (Per For 10 008 0011)	50	40	10 009 0011		40 x 1,2	10 010 0011	
		-	-	-	40 x 1,5	10 010 0021	
		40,4	10 009 0015		40,4 x 1,2	10 010 0015	
Piaggio - Gilera	50	40	10 009 0010		40 x 1,5	10 010 0010	
		40,4	10 009 0014		40,4 x 1,5	10 010 0014	
		40,8	10 009 0018		40,8 x 1,5	10 010 0018	
Piaggio Ciao spinotto Ø 10 mm - Pin Ø 10 mm	50	38,4	10 009 0314		38,4	10 010 0314	
		38,6	10 009 0316		38,6	10 010 0316	
		38,8	10 009 0318		38,8	10 010 0318	
Piaggio 4T	50	39	10 009 0101		39	10 010 0101	
		39,4	10 009 0104		39,4	10 010 0104	
		39,8	10 009 0108		39,8	10 010 0108	
Piaggio - Vespa	50	38,4	10 009 0521		38,4	10 010 0521	
		38,8	10 009 0528		38,8	10 010 0528	
		39	10 009 0529		39	10 010 0529	
Honda Sh	50	39	10 009 0080		39 x 1,5 39 x 1,2	10 010 0080	
		39,4	10 009 0084		39,4 1,5 39,4 x 1,2	10 010 0084	
		39,8	10 009 0088		39,8 x 1,5 39,8 x 1,2	10 010 0088	

PISTONI COMPLETI E FASCE PER CILINDRI RMS

PISTONS AND PISTON RINGS FOR RMS CYLINDERS











































		 PISTONI COMPLETI PER CILINDRI RMS <i>PISTONS FOR RMS CYLINDERS</i>			 KIT FASCE ELASTICHE PER PISTONI RMS <i>PISTON RINGS FOR RMS PISTONS</i>		
APPLICAZIONI - APPLICATIONS	CC.	Ø PISTONE MM Ø PISTON MM	CODICE RMS RMS CODE	CODICE A BARRE BARCODE	Ø FASCE ELASTICHE MM Ø PISTON RINGS MM	CODICE RMS RMS CODE	CODICE A BARRE BARCODE
Keeway	50	40	10 009 0471		40	10 010 0471	
Kymco 2T	50	39	10 009 0461		39	10 010 0461	
Kymco 50 4T - (Per For 10 008 0380)	50	39	10 009 0380		39	10 010 0380	
Kymco 50 4T - (Per For 10 008 0381)	50	39	10 009 0381		-	-	-
Peugeot (Raffr. Aria) Peugeot (Air cooled)	50	40	10 009 0070		40 x 1,5	10 010 0070	
		40,4	10 009 0074		40,4 x 1,5	10 010 0074	
Peugeot (Raffr. Acqua) Peugeot (Liquid cooled)	50	40	10 009 0201		40	10 010 0201	
Suzuki 2T (Raffr. Acqua) Suzuki 2T (Air cooled)	-	41	10 009 0641 NEW		-	-	-
Aprilia - Beta - Malaguti - Mbk - Sym Minarelli Orizzontale - (Per For 10 008 0490)	75	47	10 009 0550		47 x 1,2	10 010 0550	
Aprilia - Mbk - Yamaha Minarelli Verticale - (Per For 10 008 0500)	75	47	10 009 0550		47 x 1,2	10 010 0550	
Aprilia - Benelli - Beta - Italjet - Malaguti Mbk - Yamaha Minarelli Lc - (Per For 10 008 0510)	75	47	10 009 0550		47 x 1,2	10 010 0550	
Minarelli - MBK - Yamaha (Per For 10 008 0210) (Per For 10 008 0220) (Per For 10 008 0230)	75	-	-	-	47,4 x 1,2	10 010 0214	
		-	-	-	47,8 x 1,2	10 010 0218	
Aprilia - Derbi - Gilera - Piaggio (Per For 10 008 0570)	75	47	10 009 0570		47 x 1,5	10 010 0570	
Derbi - Gilera - Piaggio (Per For 10 008 0480 - 10 008 0560)	75	47	10 009 0560		47 x 1,2	10 010 0550	
Gilera - Piaggio Lc (Per For 10 008 0560)	75	47	10 009 0560		47 x 1,2	10 010 0550	
Piaggio 2T (Per For 10 008 0610)	75	47	10 009 0580		47 x 1,2	10 010 0550	
Piaggio - Gilera (Per For 10 008 0240) (Per For 10 008 0320) (Per For 10 008 0330)	75	-	-	-	47,4 x 1,2	10 010 0214	
		-	-	-	47,8 x 1,2	10 010 0218	
Piaggio Vespa Ape	75	47	10 009 0280		47 x 1,5	10 010 0280	
		47,4	10 009 0284		47,4 x 1,5	10 010 0284	
		47,8	10 009 0288		47,8 x 1,5	10 010 0288	
Piaggio Vespa Ape	85	50	10 009 0271		50 x 1,5	10 010 0271	
		50,4	10 009 0274		50,4 x 1,5	10 010 0274	
		50,8	10 009 0278		50,8 x 1,5	10 010 0278	



PISTONI COMPLETI E FASCE PER CILINDRI RMS













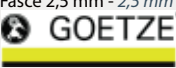













PISTONS AND PISTON RINGS FOR RMS CYLINDERS

		 PISTONI COMPLETI PER CILINDRI RMS <i>PISTONS FOR RMS CYLINDERS</i>			 KIT FASCE ELASTICHE PER PISTONI RMS <i>PISTON RINGS FOR RMS PISTONS</i>		
APPLICAZIONI - APPLICATIONS	CC.	Ø PISTONE MM Ø PISTON MM	CODICE RMS RMS CODE	CODICE A BARRE BARCODE	Ø FASCE ELASTICHE MM Ø PISTON RINGS MM	CODICE RMS RMS CODE	CODICE A BARRE BARCODE
Piaggio-Vespa-Ape	100	55	10 009 0141		55 x 1,5	10 010 0141	
		55,4	10 009 0144		55,4 x 1,5	10 010 0144	
		55,8	10 009 0148		55,8 x 1,5	10 010 0148	
Piaggio: Liberty-Sfera-Vespa ET4 4T- (Per For 10 008 0060)	125	57	10 009 0060		-	-	-
Piaggio: Liberty-Vespa Lx- (Per For 10 008 0531)	125	57	10 009 0531		57	10 010 0531	
Piaggio Vespa Pk 125	125	-	-	-	55	10 010 0420 NEW	
		55,4	10 009 0424		-	-	-
		55,6	10 009 0426		-	-	-
Piaggio Vespa Px (Per For 10 008 0680) Fasce 2,5 mm - 2,5 mm Piston rings  NEW	125	52,5	10 009 0680		-	-	-
		52,9	10 009 0684		-	-	-
		53,1	10 009 0686		-	-	-
Honda Sh 125 - (Per For 10 008 0450)	125	52,4	10 009 0450		52,4	10 010 0450	
Kymco 125 - (Per For 10 008 0390)	125	52,4	10 009 0390		52,4	10 010 0390	
Kymco 125 - (Per For 10 008 0391)	125	52,4	10 009 0391		-	-	-
Yamaha 125 - (Per For 10 008 0340)	125	52	10 009 0340		-	-	-
Yamaha 125 - (Per For 10 008 0341)	125	52	10 009 0341		-	-	-
Honda Sh 150 - (Per For 10 008 0150)	150	58	10 009 0150		-	-	-
		58,4	10 009 0154		58,4	10 010 0154	
		58,8	10 009 0158		58,8	10 010 0158	
Honda Sh 150 - (Per For 10 008 0440)	150	57,5	10 009 0440		57,5	10 010 0440	
Kymco 150 - (Per For 10 008 0401)	150	57,4	10 009 0401		-	-	-
LML 150 cc 2T (Per For 10 008 0630) Fasce 2 mm - 2 mm Piston rings  NEW	150	57,8	10 009 0630		-	-	-
		58	10 009 0632		-	-	-
		58,2	10 009 0634		-	-	-
Piaggio Vespa Px - Sprint	150	57,4	10 009 0414		-	-	-
		57,6	10 009 0416		-	-	-
		57,8	10 009 0418		-	-	-

PISTONI COMPLETI E FASCE PER CILINDRI RMS

PISTONS AND PISTON RINGS FOR RMS CYLINDERS



		 PISTONI COMPLETI PER CILINDRI RMS <i>PISTONS FOR RMS CYLINDERS</i>			 KIT FASCE ELASTICHE PER PISTONI RMS <i>PISTON RINGS FOR RMS PISTONS</i>		
APPLICAZIONI - APPLICATIONS	CC.	Ø PISTONE MM Ø PISTON MM	CODICE RMS RMS CODE	CODICE A BARRE BARCODE	Ø FASCE ELASTICHE MM Ø PISTON RINGS MM	CODICE RMS RMS CODE	CODICE A BARRE BARCODE
Piaggio Vespa Px - Pe (Per For 10 008 0670) Fasce 2,5 mm - 2,5 mm Piston rings  NEW	150	57,8	10 009 0670		-	-	-
		58,4	10 009 0676		-	-	-
		58,6	10 009 0678		-	-	-
Piaggio Vespa Sprint (Per For 10 008 0660) Fasce 2,5 mm - 2,5 mm Piston rings  NEW	150	57	10 009 0660		-	-	-
		57,4	10 009 0664		-	-	-
		57,6	10 009 0666		-	-	-
Piaggio Ape - Spinotto Ø 18 mm - Pin Ø 18 mm	220	68	10 009 0181 NEW		68 x 2,5	10 010 0180	
		-	-	-	68,4 x 2,5	10 010 0184	
		68,6	10 009 0186		68,6 x 2,5	10 010 0186	
		68,8	10 009 0188		68,8 x 2,5	10 010 0188	
Piaggio Ape - Spinotto Ø 16 mm - Pin Ø 16 mm	220	68	10 009 0360		68 x 2,5	10 010 0180	
		68,4	10 009 0364		68,4 x 2,5	10 010 0184	
		68,6	10 009 0366		68,6 x 2,5	10 010 0186	
		68,8	10 009 0368		68,8 x 2,5	10 010 0188	
Kymco Dink 250	250	72,7	-	-	72,7	10 010 0160	



Le catene di distribuzione **KMC** sono prodotte in modo accurato grazie all'utilizzo di materiale di alta qualità, a metodi di stampaggio avanzati ed a speciali trattamenti termici delle piastre. Queste procedure ottimizzano l'area di contatto tra le piastre della catena e le ruote dentate, aumentano la resistenza a fatica della catena assicurando una diminuzione del rumore di funzionamento. Queste qualità rendono le catene di distribuzione **KMC** una buona alternativa al ricambio originale per qualità, durata e prezzo.

KMC timing chains are precisely fabricated with an high grade alloy material, with advanced stamping method and exclusive heat-treatment for link plates. It maximizes contact area between links and sprocket for a better chain strength, impact resistance and low running noise. These properties make KMC timing chains a good option of OEM timing chains in terms of quality, like and price.

16 371 2010 

MODELLO - MODEL

2023LN



16 371 9180 

GIUNTO CATENA - CONNECTING LINK

KYMCO 50 • (R.O. 00103612) • **SYM 50** • (R.O. 1C14401BE2A00) • **YAMAHA 50** • (R.O. 5STE21900000)

16 371 2020 

MODELLO - MODEL

2023LN



16 371 9180 

GIUNTO CATENA - CONNECTING LINK

APRILIA 50-100 • **PIAGGIO 50-100** • (R.O. 96933R)

16 371 2030 

MODELLO - MODEL

2023LN



16 371 9180 

GIUNTO CATENA - CONNECTING LINK

APRILIA 125 • **HONDA 125-150** • (R.O. 14401-KCW-851) • **KYMCO 125-150-200** • (R.O. 00123110 • 00114099)
PIAGGIO 125-150-200 • (R.O. 82643R) • **SYM 125-150-200** • (R.O. 1C14401M900)

16 371 2040 

MODELLO - MODEL

2023LN



16 371 9180 

GIUNTO CATENA - CONNECTING LINK

HONDA 110 • (R.O. 14401 • GFM-971) • **SYM 125** • (R.O. 1C14401V000)

16 371 2050 

MODELLO - MODEL

2023LN



16 371 9180 

GIUNTO CATENA - CONNECTING LINK

HONDA 125-150 • (R.O. 14401-KSS-931) • SYM 125-150 • (R.O. 1C14401F6A000)

16 371 2060 

MODELLO - MODEL

2034LW



16 371 9210 

GIUNTO CATENA - CONNECTING LINK

SUZUKI 125-150 • (R.O. 12760-055A0-000)

16 371 2070 

MODELLO - MODEL

2023LN



16 371 9180 

GIUNTO CATENA - CONNECTING LINK

APRILIA 125 • (R.O. 82644R) • GILERA 125-200 • (R.O. 82644R) • PIAGGIO 125-150-200 • (R.O. 82644R)
• MALAGUTI 125-150-200 • (R.O. 51700400) • YAMAHA 125-150 • (R.O. 94568A809600 • 1C14401A1A000)

16 371 2080 

MODELLO - MODEL

2023LN



16 371 9180 

GIUNTO CATENA - CONNECTING LINK

KYMC0 250 • (R.O. 00123910)

16 371 2090 

MODELLO - MODEL

2023LW



16 371 9190 

GIUNTO CATENA - CONNECTING LINK

SUZUKI 125-150-200 • (R.O. 12760-04B00-000)

16 371 2100 

MODELLO - MODEL

2034LN



16 371 9200 

GIUNTO CATENA - CONNECTING LINK

APRILIA 400-500 • (R.O. 827889) • GILERA 500 • (R.O. 827889) • PIAGGIO 400-500 • (R.O. 827889) • MALAGUTI 500 • (R.O. 41701000)

16 371 2110 

MODELLO - MODEL

2034LN



16 371 9200 

GIUNTO CATENA - CONNECTING LINK

YAMAHA 500 • (R.O. 945821813200)

16 371 2120 

MODELLO - MODEL

2034LN



16 371 9200 

GIUNTO CATENA - CONNECTING LINK

YAMAHA 400 • (R.O. 945821813600)

16 371 2130 

MODELLO - MODEL
2023LW



16 371 9210 

GIUNTO CATENA - CONNECTING LINK

KYMCO 125-150-200 • (R.O. 00123912) • **MBK 125-150** • (R.O. 945914809400) • **YAMAHA 125-150-180** • (R.O. 945914809400)
MALAGUTI 125-150 • (R.O. 71700800)

16 371 2140 

MODELLO - MODEL
2023LW



16 371 9190 

GIUNTO CATENA - CONNECTING LINK

APRILIA 125.150 • (R.O. AP0297932)

16 371 2150 

MODELLO - MODEL
2034LW



16 371 9210 

GIUNTO CATENA - CONNECTING LINK

SUZUKI 250-400 • (R.O. 12760-19B71-000)

16 371 2160 

MODELLO - MODEL
2034LW



16 371 9210 

GIUNTO CATENA - CONNECTING LINK

SUZUKI 400-650 • (R.O. 12760-19F01-000)

16 371 2170 

MODELLO - MODEL
2034LN



16 371 9200 

GIUNTO CATENA - CONNECTING LINK

HONDA 400-600 • (R.O. 14401-MCT-003)

16 371 2180 

MODELLO - MODEL
2023LW



16 371 9190 

GIUNTO CATENA - CONNECTING LINK

APRILIA 250 • (R.O. AP8122434) • **MALAGUTI 250** • (R.O. 91700100) • **MBK 250-300** • (R.O. 945821710400)
• **YAMAHA 250- 300** • (R.O. 945821710400)

16 371 2190 

MODELLO - MODEL
2023LN



16 371 9180 

GIUNTO CATENA - CONNECTING LINK

HONDA 300 • (R.O. 14401-KFB-751)

16 371 2200 

MODELLO - MODEL
2023LN



16 371 9180 

GIUNTO CATENA - CONNECTING LINK

APRILIA 125-300 • **DERBI 125-250-300** Rambla • **GILERA 250-300** • **PIAGGIO 250-300** • (R.O. 82723R)

16 371 2210 

MODELLO - MODEL
2023LN



PEUGEOT 50 • (R.O. 801526) • SYM 50 • (R.O. 1C14401A1A000)

16 371 9180 

GIUNTO CATENA - CONNECTING LINK

16 371 2240 

MODELLO - MODEL
2023LN



PIAGGIO 125 • (R.O. 436246)

16 371 9180 

GIUNTO CATENA - CONNECTING LINK

16 371 2250 

MODELLO - MODEL
2023LN



SYM 50-100 • (R.O. 1C14401A31000)

16 371 9180 

GIUNTO CATENA - CONNECTING LINK

16 371 2260 

MODELLO - MODEL
2034LN



SYM 250-300 • (R.O. 1C14401RFA000)

16 371 9200 

GIUNTO CATENA - CONNECTING LINK

16 371 2270 

MODELLO - MODEL
2034LN



KYMCO 200-300-400 • (R.O. 00114051) • SYM 400 • (R.O. 1C14401L4A000)

16 371 9200 

GIUNTO CATENA - CONNECTING LINK

16 371 2280 

MODELLO - MODEL
2023LN



PIAGGIO 350 • (R.O. 82992R)

16 371 9180 

GIUNTO CATENA - CONNECTING LINK

16 371 2290 

MODELLO - MODEL
2034LN



KYMCO 500 • (R.O. 00123058)

16 371 9200 

GIUNTO CATENA - CONNECTING LINK

16 371 2310 

MODELLO - MODEL
2034LN



YAMAHA 530 • (R.O. 945915313400)

16 371 9200 

GIUNTO CATENA - CONNECTING LINK

Codice Rms Rms Code	Modello - Model	Cc.	Da From	A To	Rif.Originale Oem Number
APRILIA					
16 371 2020	Scarabeo 4T	50	02	06	AP8551071
16 371 2020	Scarabeo 4T	50	02	06	AP8551071
16 371 2020	Scarabeo 4T 4V	50	10	12	96933R
16 371 2020	Scarabeo 4T 4V	50	14	14	96933R
16 371 2020	Scarabeo 4T 4V Net	50	09	09	96933R
16 371 2020	Scarabeo 4T 4V Net	50	10	10	96933R
16 371 2020	Scarabeo 4T Restyling Eu3	50	06	09	96933R
16 371 2020	Scarabeo Quattro	50	09	09	96933R
16 371 2020	Sport City One 4T	50	08	10	96933R
16 371 2020	Sr Motard 4T 4V	50	13	14	96933R
16 371 2020	Scarabeo 4T	100	01	05	AP8551071
16 371 2020	Scarabeo 4T	100	01	05	AP8551071
16 371 2020	Scarabeo 4T	100	10	12	96933R
16 371 2020	Scarabeo 4T	100	14	14	96933R
16 371 2020	Scarabeo 4T Net	100	09	09	96933R
16 371 2020	Scarabeo 4T Net Eu3	100	10	10	96933R
16 371 2020	Scarabeo 4T Restyling	100	06	09	96933R
16 371 2070	Atlantic	125	03	05	AP8580130
16 371 2070	Atlantic Eu3	125	10	12	82644R
16 371 2070	Atlantic Eu3 125-250	125	06	08	AP8580130
16 371 2200	Atlantic Eu3 125-250	125	06	08	AP8577032
16 371 2140	Leonardo	125	96	98	AP0297930
16 371 2140	Leonardo	125	99	02	AP0297930
16 371 2140	Leonardo St	125	01	04	AP0297930
16 371 2030	Mojito	125	03	07	AP8540048
16 371 2030	Mojito	125	03	07	AP8540048
16 371 2030	Mojito	125	03	07	AP8540048
16 371 2030	Mojito	125	08	08	82643R
16 371 2030	Mojito	125	08	08	82643R
16 371 2070	Scarabeo	125	03	03	AP8580130
16 371 2070	Scarabeo	125	04	06	AP8580130
16 371 2200	Scarabeo	125	04	06	AP8577032
16 371 2070	Scarabeo Motore Piaggio Eu3	125	06	06	AP8580130
16 371 2140	Scarabeo Motore Rotax	125	99	04	AP0297932
16 371 2070	Sport City	125	04	06	AP8580130
16 371 2070	Sport City Cube	125	08	10	82644R
16 371 2070	Sport City Eu3	125	06	08	AP8580130
16 371 2200	Sport City Eu3	125	06	08	AP8577032
16 371 2030	Sport City One 4T Eu3	125	08	11	82643R
16 371 2030	Sport City One 4T Eu3	125	08	11	82643R
16 371 2070	Sport City Street	125	12	12	82644R
16 371 2070	Sr Max	125	11	14	82644R
16 371 2030	Sr Motard	125	12	14	82643R
16 371 2030	Sr Motard	125	12	14	82643R
16 371 2180	Leonardo	250	99	01	AP8122434
16 371 2180	Leonardo	250	02	04	AP8552083
16 371 2180	Leonardo St	250	01	01	AP8122434
16 371 2200	Scarabeo Light	250	06	08	AP8577032
16 371 2200	Sport City Cube	250	08	12	82723R
16 371 2200	Atlantic	300	10	11	82723R
16 371 2200	Scarabeo Light	300	09	10	82723R
16 371 2200	Sport City Street	300	12	12	82723R
16 371 2200	Sr Max	300	11	14	82723R
16 371 2100	Atlantic Sprint 400-500	400	05	08	AP8560060

Codice Rms Rms Code	Modello - Model	Cc.	Da From	A To	Rif.Originale Oem Number
16 371 2100	Scarabeo Light 400-500	400	06	08	827889
16 371 2100	Atlantic	500	01	04	AP8560060
16 371 2100	Scarabeo	500	03	06	AP8560060
DERBI					
16 371 2020	Atlantis 4T Eu2	50	07	07	96933R
16 371 2020	Atlantis 50-100 4T	50	04	06	96933R
16 371 2020	Boulevard 4T Eu2 25 Km/H	50	09	09	96933R
16 371 2020	Dirt Boy & Dirt Kid	50	04	07	96933R
16 371 2020	Boulevard 4T	100	10	11	96933R
16 371 2030	Boulevard 125-150	125	03	04	82643R
16 371 2030	Boulevard 125-150 Eu2	125	04	07	82643R
16 371 2030	Boulevard 4T Eu3	125	08	12	82643R
16 371 2070	Gp1 Eu2	125	06	06	82644R
16 371 2070	Gp1 Low Seat 125 Eu3	125	07	08	82644R
16 371 2070	Rambla 125-250	125	08	09	82644R
16 371 2200	Rambla 125-250	125	08	09	82723R
16 371 2070	Rambla 125-250 E3 2Ver	125	08	08	82644R
16 371 2200	Rambla 125-250 E3 2Ver	125	08	08	82723R
16 371 2030	Sonar 4T	125	09	11	82643R
16 371 2030	Variant Sport 4T E3	125	12	12	82643R
16 371 2030	Boulevard 4T E3	150	10	10	82643R
16 371 2030	Sonar 4T	150	09	09	82643R
16 371 2030	Boulevard Eu2	200	05	06	82643R
16 371 2200	Gp1	250	06	07	82723R
16 371 2200	Gp1 Low Seat 250 Eu3	250	07	08	82723R
16 371 2200	Rambla	300	10	11	82723R
GILERA					
16 371 2070	Dna 125-180	125	01	01	82644R
16 371 2070	Nexus Eu3	125	07	08	82644R
16 371 2070	Nexus Eu3 le	125	08	08	82644R
16 371 2070	Nexus Eu3 le	125	09	10	82644R
16 371 2070	Runner 4T St Eu3	125	08	13	82644R
16 371 2070	Runner Vx	125	05	06	82644R
16 371 2070	Runner Vx 4T Eu3	125	06	07	82644R
16 371 2070	Runner Vx Race	125	06	06	82644R
16 371 2070	Runner Vx Sc	125	06	07	82644R
16 371 2070	Runner Vx-Vxr 125-180	125	00	01	82644R
16 371 2070	Runner Vx-Vxr 125-200	125	02	04	82644R
16 371 2070	Runner Vxr	200	05	06	82644R
16 371 2070	Runner Vxr 4T St Eu3	200	08	11	82644R
16 371 2070	Runner Vxr Eu3	200	07	07	82644R
16 371 2070	Runner Vxr Race	200	05	06	82644R
16 371 2200	Nexus Eu3	250	06	06	82723R
16 371 2200	Nexus Eu3	250	07	07	82723R
16 371 2200	Nexus Sp Eu3	250	06	07	82723R
16 371 2200	Oregon	250	06	10	82723R
16 371 2200	Nexus Eu3	300	08	08	82723R
16 371 2200	Nexus Eu3	300	09	11	82723R
16 371 2100	Fuoco 4T-4V le E3 Lt	500	13	14	827889
16 371 2100	Fuoco Eu3	500	07	13	827889
16 371 2100	Nexus	500	03	05	827889
16 371 2100	Nexus Eu3	500	06	08	827889
16 371 2100	Nexus Eu3	500	09	11	827889
16 371 2100	Nexus Sp Eu3	500	06	07	827889

Codice Rms Rms Code	Modello - Model	Cc.	Da From	A To	Rif.originale Oem Number	Codice Rms Rms Code	Modello - Model	Cc.	Da From	A To	Rif.originale Oem Number
HONDA						16 371 2030	Pes 150 R Two Tones	150	08	09	14401-KRJ-901
16 371 2040	Dio Vision 110	110	11	11	14401-GFM-971	16 371 2030	Ps 150 Injection	150	10	10	14401-KRJ-901
16 371 2040	Lead 110	110	08	12	14401-GFM-971	16 371 2030	S Wing 150 Fes	150	09	09	14401-KRJ-901
16 371 2040	Vision 110	110	13	16	14401-GFM-971	16 371 2030	S Wing 150 Fes Abs	150	07	09	14401-KRJ-901
16 371 2030	Arobase 125	125	05	06	14401-KRJ-901	16 371 2030	Sh 150	150	05	12	14401-KRJ-901
16 371 2050	Forza 125	125	15	15	14401-KSS-931	16 371 2050	Sh 150	150	13	16	14401-KSS-931
16 371 2050	Forza 125 Abs	125	15	16	14401-KSS-931	16 371 2030	Sh 150 2Ed	150	06	10	14401-KRJ-901
16 371 2050	Innova 125	125	10	12	14401-KSS-931	16 371 2050	Sh 150 Abs	150	14	16	14401-KSS-931
16 371 2030	Pantheon 125 Fes	125	03	05	14401-KRJ-901	16 371 2050	Sh 150 Abs Sporty	150	14	14	14401-KSS-931
16 371 2050	Pcx 125	125	10	15	14401-KSS-931	16 371 2050	Sh 150 D	150	13	16	14401-KSS-931
16 371 2050	Pcx 125 Limited Edition	125	12	12	14401-KSS-931	16 371 2050	Sh 150 D Abs	150	16	16	14401-KSS-931
16 371 2030	Pes 125 Injection	125	06	09	14401-KRJ-901	16 371 2050	Sh 150 Ds	150	16	16	14401-KSS-931
16 371 2030	Pes 125 Injection Sporty	125	06	09	14401-KRJ-901	16 371 2050	Sh 150 Ds Abs	150	16	16	14401-KSS-931
16 371 2030	Ps 125 Injection	125	10	12	14401-KRJ-901	16 371 2030	Sh 150 R	150	08	12	14401-KRJ-901
16 371 2030	Ps 125 Injection 2Ed	125	10	10	14401-KRJ-901	16 371 2030	Sh 150 R Top Box	150	10	10	14401-KRJ-901
16 371 2030	Ps 125 Injection Sporty	125	10	10	14401-KRJ-901	16 371 2030	Sh 150 Rear Disk	150	09	09	14401-KRJ-901
16 371 2030	Ps 125 Injection Sporty 2Ed	125	10	10	14401-KRJ-901	16 371 2050	Sh 150 S	150	16	16	14401-KSS-931
16 371 2030	S Wing 125	125	12	12	14401-KRJ-901	16 371 2030	Sh 150 S	150	08	11	14401-KRJ-901
16 371 2030	S Wing 125 Abs	125	12	12	14401-KRJ-901	16 371 2050	Sh 150 S Abs	150	16	16	14401-KSS-931
16 371 2030	S Wing 125 Fes	125	07	09	14401-KRJ-901	16 371 2050	Sh 150 Sporty	150	14	14	14401-KSS-931
16 371 2030	S Wing 125 Fes 2Ed	125	11	11	14401-KRJ-901	16 371 2030	Sh 150 Top Box 2Ed	150	05	05	14401-KRJ-901
16 371 2030	S Wing 125 Fes Abs	125	07	11	14401-KRJ-901	16 371 2190	Crf 230	230	04	08	14401-KFB-751
16 371 2030	S Wing 125 Fes Abs 2Ed	125	11	11	14401-KRJ-901	16 371 2190	Crf 230 F	230	09	09	14401-KFB-751
16 371 2030	S Wing 125 Fes Abs Top Box	125	07	07	14401-KRJ-901	16 371 2190	Forza 250 Abs	250	08	08	14401-KFB-751
16 371 2030	Sh 125	125	07	11	14401-KRJ-901	16 371 2190	Reflex 250 Sport	250	08	08	14401-KFB-751
16 371 2050	Sh 125	125	13	16	14401-KSS-931	16 371 2190	Forza 300	300	13	16	14401-KFB-751
16 371 2030	Sh 125 2Ed	125	07	07	14401-KRJ-901	16 371 2190	Forza 300 Abs	300	13	16	14401-KFB-751
16 371 2050	Sh 125 Abs	125	13	16	14401-KSS-931	16 371 2190	Sh 300	300	07	14	14401-KFB-751
16 371 2050	Sh 125 Abs Sporty	125	14	14	14401-KSS-931	16 371 2190	Sh 300 3E	300	09	09	14401-KFB-751
16 371 2050	Sh 125 Abs Sporty Top Case	125	14	14	14401-KSS-931	16 371 2190	Sh 300 Abs	300	07	14	14401-KFB-751
16 371 2050	Sh 125 Abs Top Case	125	14	14	14401-KSS-931	16 371 2190	Sh 300 Abs 3Ed	300	09	09	14401-KFB-751
16 371 2050	Sh 125 D	125	16	16	14401-KSS-931	16 371 2190	Sh 300 Abs Black	300	13	13	14401-KFB-751
16 371 2050	Sh 125 D Abs	125	16	16	14401-KSS-931	16 371 2190	Sh 300 Abs Black Special	300	14	14	14401-KFB-751
16 371 2030	Sh 125 D Rear Drum	125	09	09	14401-KRJ-901	16 371 2190	Sh 300 Abs Sport	300	09	09	14401-KFB-751
16 371 2050	Sh 125 Ds	125	16	16	14401-KSS-931	16 371 2190	Sh 300 Abs Sport 3Ed	300	09	09	14401-KFB-751
16 371 2050	Sh 125 Ds Abs	125	16	16	14401-KSS-931	16 371 2190	Sh 300 Abs Sporty	300	14	14	14401-KFB-751
16 371 2030	Sh 125 Injection	125	05	05	14401-KRJ-901	16 371 2190	Sh 300 Abs Sporty	300	14	14	14401-KFB-751
16 371 2030	Sh 125 Injection Top Box	125	05	06	14401-KRJ-901	16 371 2190	Sh 300 Abs Top Box	300	10	11	14401-KFB-751
16 371 2030	Sh 125 R 2Ed Rear Drum	125	08	08	14401-KRJ-901	16 371 2190	Sh 300 Black Special	300	14	14	14401-KFB-751
16 371 2030	Sh 125 R Rear Drum	125	08	08	14401-KRJ-901	16 371 2190	Sh 300 I Abs	300	15	15	14401-KFB-751
16 371 2030	Sh 125 R Rear Drum, Tob Box	125	10	10	14401-KRJ-901	16 371 2190	Sh 300 R	300	12	13	14401-KFB-751
16 371 2030	Sh 125 R White	125	12	12	14401-KRJ-901	16 371 2190	Sh 300 R Abs	300	12	13	14401-KFB-751
16 371 2030	Sh 125 Rear Disk	125	09	09	14401-KRJ-901	16 371 2190	Sh 300 R Abs White	300	13	13	14401-KFB-751
16 371 2030	Sh 125 Rear Disk, Top Box	125	10	10	14401-KRJ-901	16 371 2190	Sh 300 Spc	300	08	10	14401-KFB-751
16 371 2050	Sh 125 S	125	16	16	14401-KSS-931	16 371 2190	Sh 300 Spc 2F	300	08	10	14401-KFB-751
16 371 2050	Sh 125 S Abs	125	16	16	14401-KSS-931	16 371 2190	Sh 300 Spc 3Ed	300	09	09	14401-KFB-751
16 371 2030	Sh 125 S Top Case	125	07	08	14401-KRJ-901	16 371 2190	Sh 300 Sporty	300	14	14	14401-KFB-751
16 371 2030	Sh 125 S Top Case 2Ed	125	07	07	14401-KRJ-901	16 371 2190	Sh 300 Sporty Abs	300	08	10	14401-KFB-751
16 371 2050	Sh 125 Sporty	125	14	14	14401-KSS-931	16 371 2190	Sh 300 Sporty Abs Top Box	300	10	10	14401-KFB-751
16 371 2030	Sh 125 Top Box	125	12	12	14401-KRJ-901	16 371 2190	Sh 300 Top Box	300	10	10	14401-KFB-751
16 371 2050	Sh Mode 125	125	14	16	14401-KSS-931	16 371 2170	Silver Wing 400	400	07	08	14401-MCT-003
16 371 2030	Arobase 150	150	05	06	14401-KRJ-901	16 371 2170	Silver Wing 400	400	06	09	14401-MCT-003
16 371 2030	Pantheon 150 Fes	150	03	05	14401-KRJ-901	16 371 2170	Silver Wing 400 Abs	400	09	09	14401-MCT-003
16 371 2050	Pcx 150	150	12	16	14401-KSS-931	16 371 2170	Silver Wing 600	600	07	07	14401-MCT-003
16 371 2030	Pes 150 Injection	150	06	09	14401-KRJ-901	16 371 2170	Silver Wing 600	600	01	02	14401-MCT-003

Codice Rms <i>Rms Code</i>	Modello - <i>Model</i>	Cc.	Da <i>From</i>	A <i>To</i>	Rif.Originale <i>Oem Number</i>	Codice Rms <i>Rms Code</i>	Modello - <i>Model</i>	Cc.	Da <i>From</i>	A <i>To</i>	Rif.Originale <i>Oem Number</i>
16 371 2170	Silver Wing 600	600	03	11	14401-MCT-003	16 371 2010	Filly	50	98	00	00103612
16 371 2170	Silver Wing 600 Abs	600	07	07	14401-MCT-003	16 371 2010	Filly	50	98	00	00103612
16 371 2170	Silver Wing 600 Abs	600	03	11	14401-MCT-003	16 371 2010	Filly	50	98	00	00103612
16 371 2170	Ctx 1300 Abs	1300	14	14	14401-MCT-003	16 371 2010	Filly	50	98	00	00103612
16 371 2170	Pan European 1300 Abs	1300	02	14	14401-MCT-003	16 371 2010	Filly Lx	50	01	02	00103612
16 371 2170	Pan European St 1300	1300	02	09	14401-MCT-003	16 371 2010	Filly Lx	50	01	02	00103612
KYMCO						16 371 2010	Filly Lx	50	01	02	00103612
16 371 2010	Agility 4T Carry	50	11	11	00103612	16 371 2010	Filly Lx	50	01	02	00103612
16 371 2010	Agility 4T Carry	50	11	11	00103612	16 371 2010	Like 4T	50	09	09	00103612
16 371 2010	Agility 4T Carry	50	11	11	00103612	16 371 2010	Like 4T	50	09	09	00103612
16 371 2010	Agility 4T Carry	50	11	11	00103612	16 371 2010	Like 4T	50	09	09	00103612
16 371 2010	Agility 4T R10	50	06	06	00103612	16 371 2010	Like 4T	50	09	09	00103612
16 371 2010	Agility 4T R10	50	06	06	00103612	16 371 2010	Like 4T	50	09	09	00103612
16 371 2010	Agility 4T R10	50	06	06	00103612	16 371 2010	People S 4T	50	06	08	00103612
16 371 2010	Agility 4T R10	50	06	06	00103612	16 371 2010	People S 4T	50	06	08	00103612
16 371 2010	Agility 4T R10	50	06	06	00103612	16 371 2010	People S 4T	50	06	08	00103612
16 371 2010	Agility 4T R10	50	07	08	00103612	16 371 2010	People S 4T	50	06	08	00103612
16 371 2010	Agility 4T R10	50	07	08	00103612	16 371 2010	Sento	50	08	08	00103612
16 371 2010	Agility 4T R10	50	07	08	00103612	16 371 2010	Sento	50	08	08	00103612
16 371 2010	Agility 4T R10	50	07	08	00103612	16 371 2010	Sento	50	08	08	00103612
16 371 2010	Agility 4T R12	50	07	08	00103612	16 371 2010	Sento	50	08	08	00103612
16 371 2010	Agility 4T R12	50	07	08	00103612	16 371 2010	Super 8	50	07	07	00103612
16 371 2010	Agility 4T R12	50	07	08	00103612	16 371 2010	Super 8	50	07	07	00103612
16 371 2010	Agility 4T R12	50	07	08	00103612	16 371 2010	Super 8	50	07	07	00103612
16 371 2010	Agility 4T R12	50	07	08	00103612	16 371 2010	Super 8	50	07	07	00103612
16 371 2010	Agility 4T R16	50	08	08	00103612	16 371 2010	Super 8	50	07	07	00103612
16 371 2010	Agility 4T R16	50	08	08	00103612	16 371 2010	Super 8 4T	50	09	09	00103612
16 371 2010	Agility 4T R16	50	08	08	00103612	16 371 2010	Super 8 4T	50	09	09	00103612
16 371 2010	Agility 4T R16	50	08	08	00103612	16 371 2010	Super 8 4T	50	09	09	00103612
16 371 2010	Agility 4T R16	50	08	08	00103612	16 371 2010	Super 8 4T	50	09	09	00103612
16 371 2010	Agility 4T R16	50	09	09	00103612	16 371 2010	Super 8 4T	50	09	09	00103612
16 371 2010	Agility 4T R16	50	09	09	00103612	16 371 2010	Super 8 4T	50	13	13	00103612
16 371 2010	Agility 4T R16	50	09	09	00103612	16 371 2010	Super 8 4T	50	13	13	00103612
16 371 2010	Agility 4T R16	50	09	09	00103612	16 371 2010	Super 8 4T	50	13	13	00103612
16 371 2010	Agility 4T R16	50	12	12	00103612	16 371 2010	Super 8 4T	50	13	13	00103612
16 371 2010	Agility 4T R16	50	12	12	00103612	16 371 2010	Super 8 4T	50	13	13	00103612
16 371 2010	Agility 4T R16	50	12	12	00103612	16 371 2010	Vitality 4T	50	04	04	00103612
16 371 2010	Agility 4T R16	50	12	12	00103612	16 371 2010	Vitality 4T	50	04	04	00103612
16 371 2010	Agility 4T R16	50	12	12	00103612	16 371 2010	Vitality 4T	50	04	04	00103612
16 371 2010	Agility Plus 4T	50	14	14	00103612	16 371 2010	Vitality 4T	50	04	04	00103612
16 371 2010	Agility Plus 4T	50	14	14	00103612	16 371 2030	Agility 4T	125	06	06	00123110
16 371 2010	Agility Plus 4T	50	14	14	00103612	16 371 2030	Agility 4T Eu3	125	06	08	00123110
16 371 2010	Agility R12	50	05	05	00103612	16 371 2030	Agility Carry	125	11	11	00123110
16 371 2010	Agility R12	50	05	05	00103612	16 371 2030	Agility Plus	125	14	14	00123110
16 371 2010	Agility R12	50	05	05	00103612	16 371 2030	Agility Plus E4	125	16	16	00123110
16 371 2010	Agility R12	50	05	05	00103612	16 371 2030	Agility R16	125	08	08	00123110
16 371 2010	Agility R12	50	05	05	00103612	16 371 2030	Agility R16	125	09	09	00123110
16 371 2010	Agility R12 Ecs	50	16	16	00103612	16 371 2030	Agility R16	125	12	12	00123110
16 371 2010	Agility R12 Ecs	50	16	16	00103612	16 371 2030	Agility Rs	125	09	09	00123110
16 371 2010	Agility R12 Ecs	50	16	16	00103612	16 371 2130	B&W 125-150	125	00	00	00123912
16 371 2010	Agility R12 Ecs	50	16	16	00103612	16 371 2130	B&W 125-150 Eu2	125	03	04	00123912
16 371 2010	Agility Rs	50	09	09	00103612	16 371 2030	Dink 125 Eu3	125	06	07	00123110
16 371 2010	Agility Rs	50	09	09	00103612	16 371 2130	Dink 125-150	125	97	98	00123912
16 371 2010	Agility Rs	50	09	09	00103612	16 371 2130	Dink Classic 125-150	125	02	02	00123912
16 371 2010	Agility Rs	50	09	09	00103612	16 371 2130	Dink Classic 125-150 Eu2	125	03	03	00123912
16 371 2010	Dink 50 4T	50	07	07	00103612	16 371 2130	Dink Lx 125-150	125	98	00	00123912
16 371 2010	Dink 50 4T	50	07	07	00103612	16 371 2030	G-Dink	125	12	12	00123110
16 371 2010	Dink 50 4T	50	07	07	00103612	16 371 2030	Grand Dink 125-150	125	01	02	00123110
16 371 2010	Dink 50 4T	50	07	07	00103612	16 371 2030	Grand Dink 125-150 Eu2	125	03	04	00123110

Codice Rms Rms Code	Modello - Model	Cc.	Da From	A To	Rif.originale Oem Number	Codice Rms Rms Code	Modello - Model	Cc.	Da From	A To	Rif.originale Oem Number
16 371 2030	Like	125	09	09	00123110	16 371 2270	People Gti	300	11	11	00114051
16 371 2030	Like Lx	125	12	12	00123110	16 371 2270	People Gti	300	14	14	00114051
16 371 2030	Movie	125	99	00	00123110	16 371 2270	People Gti Abs	300	12	12	00114051
16 371 2030	Movie 125 Eu3	125	06	07	00123110	16 371 2270	People Gti Abs	300	14	14	00114051
16 371 2030	Movie XI 125-150	125	01	01	00123110	16 371 2270	People Gti Abs E4	300	16	16	00114051
16 371 2030	Movie XI 125-150 Eu2	125	03	04	00123110	16 371 2270	Downtown Abs E4	350	16	16	00114051
16 371 2030	People 125-150	125	99	00	00123110	16 371 2270	Downtown I Abs	350	15	15	00114051
16 371 2030	People 125-150 Eu2	125	03	03	00123110	16 371 2270	Mxu	400	08	08	00114051
16 371 2030	People Eu3	125	07	07	00123110	16 371 2270	X Citing I	400	13	13	00114051
16 371 2030	People Eu3	125	08	08	00123110	16 371 2270	X Citing I	400	15	15	00114051
16 371 2030	People Eu3	125	11	11	00123110	16 371 2270	X Citing I Abs	400	14	14	00114051
16 371 2030	People One E4	125	16	16	00123110	16 371 2270	X Citing I Abs	400	15	15	00114051
16 371 2030	People One I	125	13	13	00123110	16 371 2270	X Citing I Abs E4	400	16	16	00114051
16 371 2030	People One I Dd	125	15	15	00123110	16 371 2270	Maxxer I	450	10	10	00114051
16 371 2030	People S	125	05	05	00123110	16 371 2290	Mxu	500	05	06	00123058
16 371 2030	People S Dd Eu3	125	07	08	00123110	16 371 2290	Mxu Irs	500	10	10	00123058
16 371 2030	Super 8	125	08	08	00123110	16 371 2290	Uxv	500	08	08	00123058
16 371 2030	Super 8	125	09	09	00123110	16 371 2290	Uxv I	500	10	10	00123058
16 371 2030	Vivio 125-150	125	00	00	00123110	16 371 2290	X Citing	500	05	05	00123058
16 371 2030	Agility R16	150	08	08	00123110	16 371 2290	X Citing 500 R	500	09	09	00123058
16 371 2030	Agility R16	150	09	09	00123110	16 371 2290	X Citing 500I	500	06	07	00123058
16 371 2030	Movie 150 Eu3	150	06	07	00123110	16 371 2290	X Citing 500I	500	08	08	00123058
16 371 2030	Agility 200I R16	200	10	10	00123110	16 371 2290	X Citing 500I R	500	07	08	00123058
16 371 2030	Agility I Plus	200	14	14	00123110	MALAGUTI					
16 371 2030	Agility R16	200	12	12	00123110	16 371 2070	Ciak	125	00	01	51700400
16 371 2130	Dink Classic	200	04	04	00123912	16 371 2070	Ciak Master	125	04	04	51700400
16 371 2030	Dink Eu3i	200	06	07	00123110	16 371 2070	Ciak Master Eu3	125	06	06	51700400
16 371 2270	Downtown I	200	10	10	00114051	16 371 2070	Ciak Restyling Eu2	125	03	03	51700400
16 371 2030	Like 200I	200	09	09	00123110	16 371 2130	Madison	125	99	01	71700800
16 371 2030	Like Lx	200	12	12	00123110	16 371 2130	Madison R Restyling	125	02	02	71700800
16 371 2270	People Gti	200	10	10	00114051	16 371 2130	Madison R Restyling Eu2	125	03	04	71700800
16 371 2270	People Gti	200	14	14	00114051	16 371 2130	Phantom Max	125	03	03	71700800
16 371 2030	People S	200	05	05	00123110	16 371 2070	Ciak	150	00	02	51700400
16 371 2030	People S 200I	200	07	07	00123110	16 371 2070	Ciak Master	150	04	04	51700400
16 371 2080	B&W	250	00	00	00123910	16 371 2070	Ciak Restyling Eu2	150	03	03	51700400
16 371 2080	B&W Eu2	250	03	03	00123910	16 371 2130	Madison T	150	99	01	71700800
16 371 2080	Grand Dink	250	01	02	00123910	16 371 2070	Ciak Master Euro 2	200	06	06	51700400
16 371 2080	Grand Dink Eu2	250	03	04	00123910	16 371 2180	Madison S	250	99	01	91700100
16 371 2080	Kxr	250	03	04	00123910	16 371 2180	Password	250	05	06	71701200
16 371 2080	Mxu	250	05	05	00123910	16 371 2180	Password Eu3	250	07	08	71701200
16 371 2080	People Lc	250	03	04	00123910	16 371 2100	Spidermax Gt	500	04	05	41701000
16 371 2080	People S	250	06	06	00123910	16 371 2100	Spidermax Gt Eu3	500	06	06	41701000
16 371 2080	People S	250	06	06	00123092	16 371 2100	Spidermax Rs	500	08	08	41701000
16 371 2080	People S 250I	250	07	07	00123910	MBK					
16 371 2080	X Citing	250	05	05	00123910	16 371 2130	Xn Doodo	125	00	01	945914809400
16 371 2080	X Citing	250	05	05	00123092	16 371 2130	Xq Thunder	125	01	02	945914809400
16 371 2080	X Citing I	250	06	07	00123910	16 371 2130	Yp E Skyliner	125	03	03	945914809400
16 371 2080	Yup	250	03	03	00123910	16 371 2130	Yp Skyliner	125	98	00	945914809400
16 371 2270	Downtown 300I	300	09	09	00114051	16 371 2130	Yp Skyliner	125	01	02	945914809400
16 371 2270	Downtown Abs	300	10	10	00114051	16 371 2130	Xn Doodo	150	01	02	945914809400
16 371 2270	Downtown Abs I	300	11	16	00114051	16 371 2130	Xq Thunder	150	01	02	945914809400
16 371 2270	Downtown I	300	11	11	00114051	16 371 2130	Yp Skyliner	150	00	00	945914809400
16 371 2270	K-Xct I	300	12	12	00114051	16 371 2130	Yp Skyliner	150	01	02	945914809400
16 371 2270	K-Xct I Abs	300	14	14	00114051	16 371 2130	Yp E Skyliner	180	03	03	945914809400
16 371 2270	People Gti	300	10	10	00114051	16 371 2180	Yp Skyliner	250	00	01	945821710400

Codice Rms <i>Rms Code</i>	Modello - <i>Model</i>	Cc.	Da <i>From</i>	A <i>To</i>	Rif.Originale <i>Oem Number</i>	Codice Rms <i>Rms Code</i>	Modello - <i>Model</i>	Cc.	Da <i>From</i>	A <i>To</i>	Rif.Originale <i>Oem Number</i>
16 371 2180	Yp Skyliner	250	02	03	945821710400	16 371 2020	Vespa S 4T-4V & College	50	08	12	96933R
16 371 2180	Yp Skyliner Abs	250	03	03	945821710400	16 371 2020	Vespa Sprint 4T 2V 25 Km/H	50	14	16	96933R
16 371 2180	Xc Kilibre	300	03	03	945821710400	16 371 2020	Vespa Sprint 4T 4V	50	14	16	96933R
PEUGEOT						16 371 2020	Zip 4T	50	00	05	96933R
16 371 2210	Fight 3 4T Dse	50			801526	16 371 2020	Zip 4T	50	06	13	96933R
16 371 2210	Fight 3 A 4T Dse	50			801526	16 371 2020	Zip 4T 25Km-H	50	06	16	96933R
16 371 2210	Fight 3 Ar 4T	50			801526	16 371 2020	Fly 4T	100	06	07	96933R
16 371 2210	Fight 3 R 4T	50			801526	16 371 2020	Fly 4T	100	08	14	96933R
16 371 2210	Tweet A Pmx	50			801526	16 371 2020	Free	100	02	03	96933R
16 371 2210	Tweet Pmx	50			801526	16 371 2020	Zip 4T	100	06	10	96933R
16 371 2210	Tweet V	50			801526	16 371 2070	Beverly	125	01	03	82644R
16 371 2210	Tweet N	50			801526	16 371 2070	Beverly Eu3	125	07	08	82644R
16 371 2210	Tweet X	50			801526	16 371 2070	Beverly Eu3 Mic	125	07	07	82644R
16 371 2210	Tweet	50			801526	16 371 2070	Beverly Eu3 Sport	125	07	08	82644R
16 371 2210	Viva 3L 4T	50			801526	16 371 2070	Beverly Rst	125	04	05	82644R
16 371 2030	Looxor	125			756294	16 371 2070	Beverly Rst	125	05	07	82644R
16 371 2070	Citystar	125			766961	16 371 2070	Beverly Rst 4T 4V le Eu3	125	10	15	82644R
16 371 2070	Satelis	125			766961	16 371 2070	Beverly Tourer Eu3	125	07	10	82644R
16 371 2070	Geopolis	125			766961	16 371 2070	Carnaby	125	07	10	82644R
16 371 2050	Tweet	125			802130	16 371 2030	Fly	125	05	07	82643R
16 371 2030	Looxor	150			756294	16 371 2030	Fly Eu3	125	07	07	82643R
16 371 2050	Tweet	150			802130	16 371 2030	Fly Eu3	125	08	11	82643R
16 371 2070	Citystar	200			766961	16 371 2070	Hexagon Gtx	125	00	00	82644R
16 371 2200	Geopolis	250			758715	16 371 2240	Hexagon Lx4	125	98	99	436246
16 371 2200	Setelis	250			758715	16 371 2240	Liberty	125	98	00	436246
16 371 2200	Geopolis	300			758715	16 371 2030	Liberty	125	01	02	82643R
16 371 2200	Setelis	300			758715	16 371 2030	Liberty 4T	125	06	07	82643R
16 371 2100	Geopolis	400			759717	16 371 2030	Liberty 4T 2V Eu3	125	09	12	82643R
16 371 2100	Satelis	400			759717	16 371 2030	Liberty 4T 2V le Ptt - Ita	125	12	13	82643R
16 371 2100	Geopolis	500			759717	16 371 2030	Liberty 4T Eu3	125	06	08	82643R
PIAGGIO						16 371 2030	Liberty 4T Eu3 Delivery - Single	125	07	15	82643R
16 371 2020	Fly 4T	50	05	07	96933R	16 371 2030	Liberty 4T Eu3 Delivery-Tnt-Nexive	125	08	15	82643R
16 371 2020	Fly 4T & 25-30 Km/H	50	08	11	96933R	16 371 2030	Liberty 4T Sport Eu3	125	06	08	82643R
16 371 2020	Fly 4T 2V	50	13	15	96933R	16 371 2030	Liberty Rst	125	04	05	82643R
16 371 2020	Fly 4T 2V 25-30Km-H	50	12	14	96933R	16 371 2030	Liberty Rst Ptt	125	05	11	82643R
16 371 2020	Fly 4T 4V	50	12	13	96933R	16 371 2030	Liberty Sport	125	06	06	82643R
16 371 2020	Fly 4T Motore Chn	50	06	07	96933R	16 371 2070	Mp3	125	06	08	82644R
16 371 2020	Liberty 4T	50	00	02	96933R	16 371 2070	Mp3 Ibrido	125	09	10	82644R
16 371 2020	Liberty 4T	50	05	08	96933R	16 371 2070	Mp3 le	125	08	09	82644R
16 371 2020	Liberty 4T Delivery - Single	50	10	14	96933R	16 371 2070	Mp3 le Touring	125	11	12	82644R
16 371 2020	Liberty 4T Delivery Tnt	50	09	09	96933R	16 371 2070	Mp3 Yourban Erl	125	11	13	82644R
16 371 2020	Liberty 4T Ptt - Double - Nexive	50	09	15	96933R	16 371 2240	Sfera	125	95	97	436246
16 371 2020	Liberty 4T Ptt (Deu)	50	07	12	96933R	16 371 2030	Skipper 4T	125	00	02	82643R
16 371 2020	Liberty 4T Rst	50	04	04	96933R	16 371 2070	Super Hexagon Gtx 12	125	01	02	82644R
16 371 2020	Liberty 4T Sport	50	06	06	96933R	16 371 2030	Typhoon 4T 2V Eu3	125	10	11	82643R
16 371 2020	Liberty 4T Sport	50	07	08	96933R	16 371 2240	Vespa Et4	125	96	98	436246
16 371 2020	Liberty Iget 4T 3V 25Km/H	50	16	16	96933R	16 371 2030	Vespa Et4	125	99	02	82643R
16 371 2020	Liberty Iget 4T 3V le	50	15	16	96933R	16 371 2070	Vespa Granturismo	125	03	05	82644R
16 371 2020	Liberty Moc 4T & Elle	50	09	16	96933R	16 371 2070	Vespa Granturismo	125	06	07	82644R
16 371 2020	Vespa Et4	50	00	05	96933R	16 371 2070	Vespa Granturismo Eu3	125	06	07	82644R
16 371 2020	Vespa Lx 4T	50	05	09	96933R	16 371 2070	Vespa Gts 4T le Super	125	09	16	82644R
16 371 2020	Vespa Lx 4T-4V	50	09	13	96933R	16 371 2070	Vespa Gts Eu3	125	07	12	82644R
16 371 2020	Vespa Lx 4T-4V Touring	50	10	13	96933R	16 371 2070	Vespa Gtv	125	06	08	82644R
16 371 2020	Vespa Primavera 4T 2V 25 Km/H	50	14	16	96933R	16 371 2070	Vespa Gtv 4T Navy Eu3	125	08	08	82644R
16 371 2020	Vespa Primavera 4T-4V	50	13	16	96933R	16 371 2030	Vespa Lx	125	05	06	82643R

Codice Rms Rms Code	Modello - Model	Cc.	Da From	A To	Rif.originale Oem Number	Codice Rms Rms Code	Modello - Model	Cc.	Da From	A To	Rif.originale Oem Number
16 371 2030	Vespa Lx 4T Eu3 Touring	125	10	11	82643R	16 371 2200	Carnaby	250	08	08	82723R
16 371 2030	Vespa Lx 4T Fl	125	09	09	82643R	16 371 2200	Mp3	250	06	08	82723R
16 371 2030	Vespa Lx Eu3	125	06	08	82643R	16 371 2200	Mp3 Lt	250	08	09	82723R
16 371 2030	Vespa Lx Eu3 le	125	09	11	82643R	16 371 2200	Mp3 Mic	250	08	09	82723R
16 371 2030	Vespa Lxv 4T Eu3	125	06	09	82643R	16 371 2200	Vespa Gt 60 Eu3	250	06	07	82723R
16 371 2030	Vespa Lxv 4T Navy Eu3	125	07	08	82643R	16 371 2200	Vespa Gts	250	05	16	82723R
16 371 2030	Vespa Lxv le 4T	125	10	13	82643R	16 371 2200	Vespa Gts Abs	250	05	12	82723R
16 371 2030	Vespa S 4T Eu3	125	07	08	82643R	16 371 2200	Vespa Gtv	250	06	09	82723R
16 371 2030	Vespa S 4T le & College	125	09	11	82643R	16 371 2200	Vespa Gtv 4T Navy Eu3	250	07	07	82723R
16 371 2070	X Evo	125	07	16	82644R	16 371 2200	X Evo	250	07	16	82723R
16 371 2070	X Evo	125	07	16	82644R	16 371 2200	X Evo	250	07	16	82723R
16 371 2070	X10 4T 4V le Eu3	125	12	13	82644R	16 371 2200	X7 Eu3	250	08	08	82723R
16 371 2070	X7 Eu3	125	08	08	82644R	16 371 2200	X8 Eu3	250	05	08	82723R
16 371 2070	X7 Evo le Eu3	125	09	10	82644R	16 371 2200	X9 Evolution	250	04	04	82723R
16 371 2070	X8	125	04	04	82644R	16 371 2200	X9 Evolution	250	06	06	82723R
16 371 2070	X8	125	05	06	82644R	16 371 2200	Beverly le Abs E4	300	16	16	82723R
16 371 2070	X8 Premium Euro 2	125	06	06	82644R	16 371 2200	Beverly Rst 4T 4V le Eu3	300	10	15	82723R
16 371 2070	X8 Premium Eu3	125	06	07	82644R	16 371 2200	Beverly Tourer Eu3	300	09	10	82723R
16 371 2030	X8 Street Euro 2	125	06	07	82643R	16 371 2200	Carnaby Cruiser	300	09	12	82723R
16 371 2070	X9	125	01	02	82644R	16 371 2200	Mp3 300 le Lt	300	10	11	82723R
16 371 2070	X9 Evolution	125	03	03	82644R	16 371 2200	Mp3 300 le Mic	300	10	10	82723R
16 371 2070	X9 Evolution	125	05	06	82644R	16 371 2200	Mp3 300 le Mic	300	11	11	82723R
16 371 2070	X9 Evolution Eu3	125	07	07	82644R	16 371 2200	Mp3 Lt Business-Sport Abs-Enjoy	300	14	16	82723R
16 371 2030	Zip	125	00	02	82643R	16 371 2200	Mp3 4T 4V le Erl Ibrido	300	10	13	82723R
16 371 2030	Fly	150	05	07	82643R	16 371 2200	Mp3 4T 4V le Lt Ibrido	300	10	11	82723R
16 371 2030	Fly Eu3	150	08	11	82643R	16 371 2200	Mp3 le E4 Lt Business-Sport Abs	300	16	16	82723R
16 371 2030	Liberty 4T Eu3	150	08	08	82643R	16 371 2200	Mp3 le Lt- le Lt Sport	300	11	14	82723R
16 371 2030	Liberty 4T Sport Eu3	150	08	08	82643R	16 371 2200	Mp3 le Lt Touring	300	11	13	82723R
16 371 2030	Liberty Moc 4T Eu3	150	09	13	82643R	16 371 2200	Mp3 le Touring	300	11	12	82723R
16 371 2030	Vespa Lx	150	05	06	82643R	16 371 2200	Mp3 Yourban Erl	300	11	15	82723R
16 371 2030	Vespa Lx 4T Fl	150	09	09	82643R	16 371 2200	Mp3 Yourban Lt Erl	300	11	12	82723R
16 371 2030	Vespa Lx Eu3	150	06	08	82643R	16 371 2200	Vespa Gts le & Touring	300	12	16	82723R
16 371 2030	Vespa Lx Eu3 le	150	09	11	82643R	16 371 2200	Vespa Gts le Abs E4	300	16	16	82723R
16 371 2030	Vespa Lx Touring	150	10	12	82643R	16 371 2200	Vespa Gts le Touring	300	11	12	82723R
16 371 2030	Vespa S 4T	150	08	09	82643R	16 371 2200	Vespa Gts Super	300	08	16	82723R
16 371 2030	Vespa S 4T le & College	150	09	12	82643R	16 371 2200	Vespa Gts Super Sport	300	10	13	82723R
16 371 2030	X8 Street Euro 2	150	06	08	82643R	16 371 2200	Vespa Gtv 4T 4V le	300	10	13	82723R
16 371 2070	X9 Amalfi	180	00	03	82644R	16 371 2200	Vespa Gtv Via Montenapoleone	300	10	10	82723R
16 371 2070	Carnaby	200	07	08	82644R	16 371 2200	X7 Evo le Eu3	300	09	10	82723R
16 371 2030	Liberty	200	06	06	82643R	16 371 2280	Beverly 4T 4V le Eu3 Sport Touring	350	11	14	82992R
16 371 2030	Liberty 4T Eu3	200	06	08	82643R	16 371 2280	Beverly 4T St le Abs	350	16	16	82992R
16 371 2030	Liberty 4T Sport Eu3	200	06	07	82643R	16 371 2280	X10 4T 4V le Eu3	350	12	15	82992R
16 371 2030	Liberty Rst	200	04	04	82643R	16 371 2100	Beverly Eu3	400	06	07	827889
16 371 2030	Liberty Sport	200	06	06	82643R	16 371 2100	Beverly Tourer Eu3	400	08	10	827889
16 371 2070	Vespa Granturismo	200	06	07	82644R	16 371 2100	Mp3	400	07	08	827889
16 371 2070	X8	200	05	07	82644R	16 371 2100	Mp3 le Lt - Mp3 le Lt Sport	400	08	10	827889
16 371 2070	X9	200	02	03	82644R	16 371 2100	Mp3 le Lt Touring	400	11	11	827889
16 371 2070	X9 Evolution	200	03	03	82644R	16 371 2100	Mp3 Mic	400	08	10	827889
16 371 2200	Beverly	250	06	07	82723R	16 371 2100	Mp3 Rl Touring	400	11	11	827889
16 371 2200	Beverly Cruiser	250	07	09	82723R	16 371 2100	X Evo	400	07	11	827889
16 371 2200	Beverly Eu3 Mic	250	07	07	82723R	16 371 2100	X Evo	400	07	11	827889
16 371 2200	Beverly le Eu3	250	06	08	82723R	16 371 2100	X8 Eu3	400	06	08	827889
16 371 2200	Beverly Rst	250	04	05	82723R	16 371 2100	Beverly	500	02	04	827889
16 371 2200	Beverly Sport	250	06	08	82723R	16 371 2100	Beverly	500	05	06	827889
16 371 2200	Beverly Tourer Eu3	250	07	09	82723R	16 371 2100	Beverly Cruiser	500	07	12	827889

Codice Rms <i>Rms Code</i>	Modello - <i>Model</i>	Cc.	Da <i>From</i>	A <i>To</i>	Rif. originale <i>Oem Number</i>	Codice Rms <i>Rms Code</i>	Modello - <i>Model</i>	Cc.	Da <i>From</i>	A <i>To</i>	Rif. originale <i>Oem Number</i>
16 371 2100	Beverly Eu3	500	06	08	827889	16 371 2160	DI650a V-Strom Abs L4	650	14	14	12760-19F01-000
16 371 2100	Mp3 Lt Business Abs	500	14	16	827889	16 371 2160	DI650a V-Strom Abs L5	650	15	15	12760-19F01-000
16 371 2100	Mp3 Lt Sport - Business	500	11	13	827889	16 371 2160	DI650a(Ue)/Xa(Ue)L6 V-Strom	650	16	16	12760-19F01-000
16 371 2100	Mp3 RI Sport - Business	500	11	12	827889	16 371 2160	DI650xt V-Strom	650	15	15	12760-19F01-000
16 371 2100	Mp3 Sport Abs	500	14	15	827889	16 371 2160	Sfv Gladius K9-L0	650	09	10	12760-19F01-000
16 371 2100	X10 4T 4V Ie Eu3	500	12	14	827889	16 371 2160	Sfv Gladius L1	650	11	11	12760-19F01-000
16 371 2100	X9	500	01	02	827889	16 371 2160	Sfv Gladius L2	650	12	12	12760-19F01-000
16 371 2100	X9 Evolution	500	03	05	827889	16 371 2160	Sfv Gladius L3	650	13	13	12760-19F01-000
16 371 2100	X9 Evolution	500	06	07	827889	16 371 2160	Sfv Gladius L4	650	14	14	12760-19F01-000
16 371 2100	X9 Evolution Abs	500	06	07	827889	16 371 2160	Sfv650(U/A/Ua)Gladius L5	650	15	15	12760-19F01-000
SUZUKI						16 371 2160	Sv650 K3-K7	650	03	07	12760-19F00-000
16 371 2090	Uc Epicuro X-K1	125	99	01	12760-04B00-000	16 371 2160	Sv650 K8-L0	650	08	10	12760-19F01-000
16 371 2090	Uh125 Burgman K2-K6	125	02	06	12760-04B00-000	16 371 2160	Sv650 X-K2	650	99	02	12760-19F00-000
16 371 2090	Uh125 Burgman K7-L0	125	07	10	12760-04B00-000	16 371 2160	Sv650a L7	650	17	17	12760-19F01-000
16 371 2090	Uh125 Burgman L1	125	11	12	12760-04B00-000	16 371 2160	Sv650sI5	650	15	15	12760-19F01-000
16 371 2090	Uh125 Burgman L3	125	13	13	12760-04B00-000	SYM					
16 371 2090	Uh125 Burgman L4	125	14	14	12760-04B00-000	16 371 2250	Cinderella	50	99	02	1C14401A31000
16 371 2090	Uh125 Burgman L6	125	16	16	12760-04B00-000	16 371 2250	Cinderella	50	99	02	1C14401A31000
16 371 2060	Ux Sixteen K8-L0	125	08	10	12760-055A0-000	16 371 2010	Fiddle Ii	50	08	08	1C14401BE2A00
16 371 2060	Ux Sixteen L1	125	11	11	12760-055A0-000	16 371 2010	Fiddle Ii	50	08	08	1C14401BE2A00
16 371 2090	Uc Epicuro X-K1	150	99	01	12760-04B00-000	16 371 2210	Fiddle Ii S	50	09	10	1C14401A1A000
16 371 2090	Uh200 Burgman K2-K6	150	02	06	12760-04B00-000	16 371 2210	Fiddle Ii S	50	11	13	1C14401A1A000
16 371 2060	Ux Sixteen K8-L0	150	08	10	12760-055A0-000	16 371 2210	Fiddle Iii	50	14	14	1C14401A1A000
16 371 2060	Ux Sixteen L1	150	11	11	12760-055A0-000	16 371 2210	Jet4	50	09	10	1C14401A1A000
16 371 2090	Uh200 Burgman K7-L0	200	07	10	12760-04B00-000	16 371 2210	Mio	50	06	07	1C14401A1A000
16 371 2090	Uh200 Burgman L1	200	11	12	12760-04B00-000	16 371 2210	Mio	50	09	09	1C14401A1A000
16 371 2090	Uh200 Burgman L3	200	13	13	12760-04B00-000	16 371 2210	Simply Ii	50	14	14	1C14401A1A000
16 371 2090	Uh200 Burgman L4	200	14	14	12760-04B00-000	16 371 2210	Symphony	50	09	09	1C14401A1A000
16 371 2090	Uh200 Burgman L6	200	16	16	12760-04B00-000	16 371 2210	Symphony S	50	10	10	1C14401A1A000
16 371 2090	Uh200(A) Burgman L5	200	15	15	12760-04B00-000	16 371 2210	Symphony S	50	11	11	1C14401A1A000
16 371 2150	An250 Burgman K3-K6	250	03	06	12760-19B71-000	16 371 2210	Symphony S	50	12	14	1C14401A1A000
16 371 2150	An250 Burgman W-K2	250	98	02	12760-19B71-000	16 371 2210	Symphony Sr	50	10	10	1C14401A1A000
16 371 2150	Dr350s L-R	350	90	94	12760-19B71-000	16 371 2210	Symphony Sr	50	11	11	1C14401A1A000
16 371 2150	Dr350se R-W	350	94	98	12760-19B71-000	16 371 2210	Symphony Sr	50	12	14	1C14401A1A000
16 371 2150	An400 Burgman K3-K6	400	03	06	12760-19B71-000	16 371 2210	Symphony St	50	15	15	1C14401A1A000
16 371 2160	An400 Burgman K7-L0	400	07	10	12760-19F01-000	16 371 2210	Symply Ii	50	09	09	1C14401A1A000
16 371 2160	An400 Burgman L1	400	11	11	12760-19F01-000	16 371 2210	X Pro	50	13	13	1C14401A1A000
16 371 2160	An400 Burgman L2	400	12	12	12760-19F01-000	16 371 2250	Cinderella	100	99	01	1C14401A31000
16 371 2160	An400 Burgman L3	400	13	13	12760-19F01-000	16 371 2250	Cinderella	100	99	01	1C14401A31000
16 371 2160	An400 Burgman L4	400	14	14	12760-19F01-000	16 371 2250	Mio Eu2	100	05	06	1C14401A31000
16 371 2160	An400 Burgman L5	400	15	15	12760-19F01-000	16 371 2250	Mio Eu3	100	07	08	1C14401A31000
16 371 2160	An400 Burgman L6	400	16	16	12760-19F01-000	16 371 2030	Attila	125	99	00	1C14401M900
16 371 2150	An400 Burgman X-K2	400	99	02	12760-19B71-000	16 371 2030	Euro Mx	125	02	02	1C14401M900
16 371 2150	Lt-A400f Kingquad 4X4 K8-L0	400	08	10	12760-19B71-000	16 371 2030	Euro Mx	125	02	02	1C14401M900
16 371 2150	Lt-A400f Kingquad 4X4 L1	400	11	11	12760-19B71-000	16 371 2030	Euro Mx E2	125	03	04	1C14401M900
16 371 2150	Lt-F Kingquad Fs 4X2 K8-L0	400	08	10	12760-19B71-000	16 371 2040	Fiddle Ii	125	08	08	1C14401V000
16 371 2150	Lt-F Kingquad Fs 4X4 K8-L0	400	08	10	12760-19B71-000	16 371 2040	Fiddle Ii	125	09	09	1C14401V000
16 371 2150	Lt-F Kingquad Fs 4X4 L1	400	11	11	12760-19B71-000	16 371 2050	Fiddle Ii	125	10	13	1C14401F6A000
16 371 2150	Lt-F Kingquad Fs 4X4 L2	400	12	12	12760-19B71-000	16 371 2030	Fiddle Iii	125	14	14	1C14401M900
16 371 2160	An650 Burgman L4	650	14	14	12760-19F01-000	16 371 2030	Gts Joymax	125	06	07	1C14401M900
16 371 2160	DI650 V-Strom K4-K6	650	04	06	12760-19F00-000	16 371 2030	Hd Eu2	125	03	04	1C14401M900
16 371 2160	DI650 V-Strom K7-L0	650	07	10	12760-19F01-000	16 371 2030	Hd Eu3	125	07	08	1C14401M900
16 371 2160	DI650 V-Strom L1	650	11	11	12760-19F01-000	16 371 2030	Hd Evo	125	05	06	1C14401M900
16 371 2160	DI650 V-Strom L2	650	12	12	12760-19F01-000	16 371 2030	Hd Evo Eu3	125	07	08	1C14401M900
16 371 2160	DI650a V-Strom Abs L3	650	13	13	12760-19F01-000	16 371 2030	Hd Evo Eu3	125	10	11	1C14401M900

Codice Rms Rms Code	Modello - Model	Cc.	Da From	A To	Rif.originale Oem Number	Codice Rms Rms Code	Modello - Model	Cc.	Da From	A To	Rif.originale Oem Number
16 371 2030	Hd Evo Tamburo Eu3	125	08	09	1C14401M900	16 371 2030	Hd Evo I Tamburo Eu3	200	08	09	1C14401M900
16 371 2030	Hd2	125	11	11	1C14401M900	16 371 2030	Hd2 I	200	11	11	1C14401M900
16 371 2030	Hd2	125	14	14	1C14401M900	16 371 2030	Hd2 I	200	14	14	1C14401M900
16 371 2030	Jet V	125	11	11	1C14401M900	16 371 2030	Joyride	200	03	03	1C14401M900
16 371 2050	Jet4	125	09	10	1C14401F6A000	16 371 2030	Joyride Eu2	200	03	04	1C14401M900
16 371 2030	Joyride	125	01	02	1C14401M900	16 371 2030	Joyride Eu2	200	05	06	1C14401M900
16 371 2030	Joyride Eu2	125	03	04	1C14401M900	16 371 2030	Joyride Evo I	200	09	09	1C14401M900
16 371 2030	Joyride Eu2	125	05	06	1C14401M900	16 371 2030	Joyride Evo I	200	13	14	1C14401M900
16 371 2030	Joyride Eu3	125	07	07	1C14401M900	16 371 2030	Joyride I Eu3	200	07	09	1C14401M900
16 371 2030	Joyride Evo	125	09	10	1C14401M900	16 371 2030	Joyride I Evo	200	10	10	1C14401M900
16 371 2030	Joyride Evo	125	10	10	1C14401M900	16 371 2030	Symphony St	200	15	15	1C14401M900
16 371 2030	Joyride Evo	125	13	13	1C14401M900	16 371 2260	Joymax Eu3 I	250	07	08	1C14401RFA000
16 371 2030	Joyride Evo	125	14	14	1C14401M900	16 371 2260	Sb 250Ni	250	12	12	1C14401RFA000
16 371 2030	Megalò	125	06	07	1C14401M900	16 371 2260	Citycom	300	08	09	1C14401RFA000
16 371 2040	New Duke	125	00	01	1C14401V000	16 371 2260	Citycom Efi	300	10	11	1C14401RFA000
16 371 2030	Shark	125	99	02	1C14401M900	16 371 2260	Citycom I Cbs	300	12	12	1C14401RFA000
16 371 2040	Super Duke	125	99	02	1C14401V000	16 371 2260	Citycom S 300 I Cbs	300	15	15	1C14401RFA000
16 371 2050	Symphony	125	09	09	1C14401F6A000	16 371 2260	Joymax Evo	300	09	09	1C14401RFA000
16 371 2050	Symphony S	125	09	09	1C14401F6A000	16 371 2260	Joymax Evo I	300	10	10	1C14401RFA000
16 371 2050	Symphony S	125	10	10	1C14401F6A000	16 371 2260	Joymax I	300	12	12	1C14401RFA000
16 371 2050	Symphony S	125	12	12	1C14401F6A000	16 371 2260	Joymax I	300	14	14	1C14401RFA000
16 371 2050	Symphony S	125	13	14	1C14401F6A000	16 371 2260	Joymax I Abs	300	13	13	1C14401RFA000
16 371 2050	Symphony Sr	125	10	10	1C14401F6A000	16 371 2260	Joymax I Abs	300	14	14	1C14401RFA000
16 371 2050	Symphony Sr	125	12	14	1C14401F6A000	16 371 2260	Quad Lander	300	08	08	1C14401RFA000
16 371 2030	Symphony St	125	15	15	1C14401M900	16 371 2260	Quad Lander S	300	07	08	1C14401RFA000
16 371 2030	Symphony St Euro4	125	16	16	1C14401M900	16 371 2270	Maxsym I	400	11	11	1C14401L4A000
16 371 2040	Symply	125	07	08	1C14401V000	16 371 2270	Maxsym I	400	12	12	1C14401L4A000
16 371 2040	Symply li	125	09	10	1C14401V000	16 371 2270	Maxsym I Abs	400	12	12	1C14401L4A000
16 371 2050	Symply li	125	14	14	1C14401F6A000	YAMAHA					
16 371 2030	Vs	125	06	06	1C14401M900	16 371 2010	Ns50f Aerox F	50	14	16	5STE21900000
16 371 2030	Vs Eu3	125	07	08	1C14401M900	16 371 2010	Ns50f Aerox F	50	14	16	5STE21900000
16 371 2050	X Pro	125	13	13	1C14401F6A000	16 371 2010	Xf Giggle	50	08	08	5STE21900000
16 371 2030	Attila	150	00	01	1C14401M900	16 371 2010	Xf Giggle	50	08	08	5STE21900000
16 371 2030	Euro Mx	150	02	02	1C14401M900	16 371 2010	Yn F Neo's 4	50	09	10	5STE21900000
16 371 2030	Euro Mx	150	02	02	1C14401M900	16 371 2010	Yn F Neo's 4	50	09	10	5STE21900000
16 371 2030	Euro Mx Eu2	150	03	04	1C14401M900	16 371 2010	Yn F Neo's 4	50	11	12	5STE21900000
16 371 2050	Fiddle li	150	10	10	1C14401F6A000	16 371 2010	Yn F Neo's 4	50	11	12	5STE21900000
16 371 2050	Fiddle li	150	12	12	1C14401F6A000	16 371 2010	Yn F Neo's 4	50	12	15	5STE21900000
16 371 2030	Joyride	150	01	02	1C14401M900	16 371 2010	Yn F Neo's 4	50	12	15	5STE21900000
16 371 2030	Shark	150	00	01	1C14401M900	16 371 2070	Mt125	125	15	15	94568A809600
16 371 2050	Symphony S	150	09	09	1C14401F6A000	16 371 2070	Mt125	125	16	16	94568A809600
16 371 2050	Symphony S	150	10	10	1C14401F6A000	16 371 2070	Mt125a	125	15	15	94568A809600
16 371 2050	Symphony S	150	12	12	1C14401F6A000	16 371 2070	Mt125a	125	16	16	94568A809600
16 371 2050	Symphony S	150	13	14	1C14401F6A000	16 371 2070	Mt125a	125	17	17	94568A809600
16 371 2050	Symphony Sr	150	10	10	1C14401F6A000	16 371 2070	Vp X-City	125	08	11	94568A809600
16 371 2050	Symphony Sr	150	12	14	1C14401F6A000	16 371 2070	Wr125r	125	09	11	94568A809600
16 371 2030	Vs	150	06	06	1C14401M900	16 371 2070	Wr125x	125	09	11	94568A809600
16 371 2030	Vs Eu3	150	07	08	1C14401M900	16 371 2070	Wr125x	125	13	14	94568A809600
16 371 2030	Track Runner	180	06	07	1C14401M900	16 371 2130	Xn Teo's	125	00	00	945914809400
16 371 2030	Fiddle liii	200	15	15	1C14401M900	16 371 2130	Xq Maxster	125	01	02	945914809400
16 371 2030	Hd Eu2	200	03	04	1C14401M900	16 371 2130	Yp125 Majesty	125	98	00	945914809400
16 371 2030	Hd Eu3 I	200	07	07	1C14401M900	16 371 2130	Yp125 Majesty	125	01	02	945914809400
16 371 2030	Hd Evo Eu2	200	05	06	1C14401M900	16 371 2130	Yp125e Majesty	125	03	05	945914809400
16 371 2030	Hd Evo Eu3 I	200	07	07	1C14401M900	16 371 2130	Yp125e Majesty	125	06	06	945914809400
16 371 2030	Hd Evo I Eu3	200	10	12	1C14401M900	16 371 2130	Yp125e Majesty	125	07	07	945914809400

Codice Rms <i>Rms Code</i>	Modello - <i>Model</i>	Cc.	Da <i>From</i>	A <i>To</i>	Rif.Originale <i>Oem Number</i>	Codice Rms <i>Rms Code</i>	Modello - <i>Model</i>	Cc.	Da <i>From</i>	A <i>To</i>	Rif.Originale <i>Oem Number</i>
16 371 2130	Yp125e Majesty	125	08	08	945914809400	16 371 2120	Yp400 Majesty	400	09	11	945821813600
16 371 2130	Yp125e Majesty	125	09	09	945914809400	16 371 2120	Yp400 Majesty Abs	400	07	07	945821813600
16 371 2070	Yp125r X-Max	125	06	07	94568A809600	16 371 2120	Yp400 Majesty Abs	400	08	08	945821813600
16 371 2070	Yp125r X-Max	125	08	09	94568A809600	16 371 2120	Yp400 Majesty Abs	400	09	11	945821813600
16 371 2070	Yp125r X-Max	125	10	12	94568A809600	16 371 2120	Yp400r X-Max	400	13	14	945821813600
16 371 2070	Yp125r X-Max	125	12	13	94568A809600	16 371 2120	Yp400r X-Max Momodesign	400	14	14	945821813600
16 371 2070	Yp125r X-Max	125	14	14	94568A809600	16 371 2120	Yp400ra X-Max Abs	400	14	14	945821813600
16 371 2070	Yp125r X-Max	125	15	16	94568A809600	16 371 2120	Yp Ra X-Max Momodesign Abs	400	14	14	945821813600
16 371 2070	Yp125r X-Max Abs	125	11	11	94568A809600	16 371 2110	Xp T-Max	500	01	03	945821813200
16 371 2070	Yp125ra X-Max Abs	125	13	13	94568A809600	16 371 2110	Xp T-Max	500	04	05	945821813200
16 371 2070	Yp125ra X-Max Abs	125	14	15	94568A809600	16 371 2110	Xp T-Max	500	06	06	945821813200
16 371 2070	Yp125ra X-Max Abs	125	16	16	94568A809600	16 371 2110	Xp T-Max	500	07	07	945821813200
16 371 2070	Yp125ra X-Max Abs	125	17	17	94568A809600	16 371 2110	Xp T-Max	500	08	08	945821813200
16 371 2070	Yzf-R125	125	08	11	94568A809600	16 371 2110	Xp T-Max	500	09	11	945821813200
16 371 2070	Yzf-R125	125	12	12	94568A809600	16 371 2110	Xp T-Max Abs	500	05	05	945821813200
16 371 2070	Yzf-R125	125	13	13	94568A809600	16 371 2110	Xp T-Max Abs	500	06	06	945821813200
16 371 2070	Yzf-R125	125	14	14	94568A809600	16 371 2110	Xp T-Max Abs	500	07	07	945821813200
16 371 2070	Yzf-R125	125	15	15	94568A809600	16 371 2110	Xp T-Max Abs	500	08	11	945821813200
16 371 2070	Yzf-R125	125	16	15	94568A809600	16 371 2110	Xp T-Max Abs Sv	500	10	11	945821813200
16 371 2070	Yzf-R125a	125	15	15	94568A809600	16 371 2110	Xp T-Max Black Max	500	06	06	945821813200
16 371 2070	Yzf-R125a	125	16	16	94568A809600	16 371 2110	Xp T-Max Black Max-Night Max	500	07	07	945821813200
16 371 2070	Yzf-R125a	125	17	17	94568A809600	16 371 2110	Xp T-Max Sv	500	11	11	945821813200
16 371 2070	Mws150-A Tricity	150	16	16	94568A809600	16 371 2110	Xp T-Max White Max	500	10	10	945821813200
16 371 2130	Xn Teo's	150	01	02	945914809400	16 371 2310	Xp T-Max	530	12	12	945915313400
16 371 2130	Xq Maxster	150	01	02	945914809400	16 371 2310	Xp T-Max	530	13	14	945915313400
16 371 2130	Yp150 Majesty	150	00	00	945914809400	16 371 2310	Xp T-Max	530	15	16	945915313400
16 371 2130	Yp150 Majesty	150	01	02	945914809400	16 371 2310	Xp T-Max Abs	530	12	12	945915313400
16 371 2130	Yp180e Majesty	180	03	06	945914809400	16 371 2310	Xp T-Max Abs	530	13	14	945915313400
16 371 2180	Vp X-City	250	07	07	945821710400	16 371 2310	Xp T-Max Abs	530	15	16	945915313400
16 371 2180	Vp X-City	250	08	08	945821710400	16 371 2310	Xp T-Max Sp	530	15	15	945915313400
16 371 2180	Vp X-City	250	09	12	945821710400	16 371 2310	Xp T-Max Sp Abs	530	15	16	945915313400
16 371 2180	Vp X-City	250	13	15	945821710400						
16 371 2180	Yp250 Majesty	250	96	98	945821710400						
16 371 2180	Yp250 Majesty	250	00	01	945821710400						
16 371 2180	Yp250 Majesty	250	02	03	945816310400						
16 371 2180	Yp250 Majesty Abs	250	03	03	945816310400						
16 371 2180	Yp250 Majesty Dx	250	98	98	945816310400						
16 371 2180	Yp250 Majesty Dx	250	99	99	945821710400						
16 371 2180	Yp250r Black X-Max	250	09	09	945821710400						
16 371 2180	Yp250r X-Max	250	05	06	945821710400						
16 371 2180	Yp250r X-Max	250	07	09	945821710400						
16 371 2180	Yp250r X-Max	250	10	12	945821710400						
16 371 2180	Yp250r X-Max	250	12	13	945821710400						
16 371 2180	Yp250r X-Max	250	14	16	945821710400						
16 371 2180	Yp250r X-Max Sport	250	11	12	945821710400						
16 371 2180	Yp250ra X-Max Abs	250	11	12	945821710400						
16 371 2180	Yp250ra X-Max Abs	250	12	13	945821710400						
16 371 2180	Yp250ra X-Max Abs	250	14	15	945821710400						
16 371 2180	Yp250ra X-Max Abs	250	16	16	945821710400						
16 371 2180	Xc Versity	300	03	03	945821710400						
16 371 2180	Xc Versity	300	04	05	945821710400						
16 371 2180	Xc Versity	300	06	06	945821710400						
16 371 2120	Yp400 Majesty	400	04	05	945821813600						
16 371 2120	Yp400 Majesty	400	06	06	945821813600						
16 371 2120	Yp400 Majesty	400	07	08	945821813600						

Codice Kmc Kmc Code	P	W	T1	T2	H	d	L	-	-
	Passo Pitch	Larghezza Interna Roller Link Width	Spessore maglia esterna Outer plate thickness	Spessore maglia interna Inner plate thickness	Altezza maglia interna Inner plate height	Diam. Perno Pin Diameter	Lunghezza Perno Over-All Width. Riv.	Carico Rottura Minimo Minimum Tensile Strength	Carico Rottura Medio Average Tensile Strength
UNITÀ DI MISURA UNIT OF MEASURE	mm.	mm.	mm.	mm.	mm.	mm.	mm.	kgf	kgf
2023LN	6,35	3,05	0,7	1,0	6,70	2,42	6,10	550	660
2034LN	6,35	5,10	0,7	1,0	6,70	2,42	8,25	800	1100
2023LW	6,35	3,05	0,7	1,0	6,72	2,72	6,10	520	620
2034LW	6,35	5,10	0,7	1,0	6,72	2,72	8,25	700	850

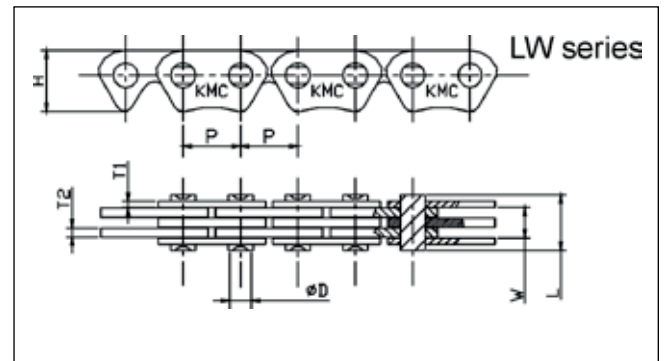
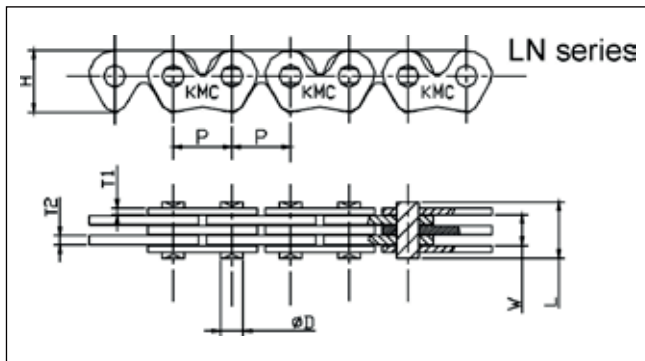

16 371 9180 

GIUNTO CATENA - CONNECTING LINK
2023 LN



16 371 9190 

GIUNTO CATENA - CONNECTING LINK
2023 LW



16 371 9200 

GIUNTO CATENA - CONNECTING LINK
2034 LN



16 371 9210 

GIUNTO CATENA - CONNECTING LINK
2034 LW



CATENE POMPA OLIO - OIL PUMP CHAINS

16 371 2220 

MODELLO - MODEL

25H



APRILIA 50: Scarabeo 4T Restyling 06-09 • Scarabeo Quattro 09 • Scarabeo 4T 4V 09-14 • Sport City One 4T 08-10 • Sr Motard 4T 4V 13-14
100: Scarabeo 4T 06-14

DERBI 50: Atlantis 4T 04-07 • Boulevard 4T 09 • **100:** Boulevard 4T 10-11

PIAGGIO 50: Fly 4T 05-14 • Liberty 4T 00-14 • Vespa Lx 4T 05-08 • Vespa Lx 4T 4V 09-14 • Vespa Primavera 4T 4V 13-14 • Vespa Sprint 4T 4V 14
 Zip 4T 00-13 • **100:** Fly 4T 06-08 • Free 02-03 • Zip 4T 06-10 • **125:** Hexagon Lx4 98-99 • Liberty 98-00 • Sfera 95-97 • Vespa Et4 96-98
 (R.O. 434447)

16 371 2230 

MODELLO - MODEL

25H



APRILIA 125: Atlantic Eu3 06-12 • Atlantic 03-05 • Mojito 03-08 • Scarabeo 03-06 • Sport City Cube 08-10 • Sport City Eu3 04-08 • Sport City One
 4T 08-11 • Sport City Street 12 • Sr Max 11-14 • Sr Motard 12-14 • **250:** Scarabeo Light 06-08 • Sport City Cube 08-12 • **300:** Atlantic 10-11 • Scarabeo
 Light 09-10 • Sport City Street 12 • Sr Max 11-14

DERBI 125: Boulevard 03-12 • Gp1 07-08 • Rambla 08-09 • Sonar 09-11 • Variant Sport 12 • **150:** Boulevard 10 • Sonar 09 • **200:** Boulevard Eu2
 05-06 • **250:** Gp1 06-08 • **300:** Rambla 10-11

GILERA 125: Dna 01 • Nexus 07-10 • Runner 4T 00-13 • **200:** Runner 4T 05-11 • **250:** Nexus 06-07 • **300:** Nexus 08-11

PIAGGIO 125: Beverly 01-13 • Fly 05-11 • Liberty 4T 01-12 • Mp3 06-12 • Skipper 4T 00-02 • Vespa Et4 99-02 • Vespa Gts 03-12 • Vespa Gtv 06-08
 • Vespa Lx 05-11 • Vespa S 4T 07-11 • X Evo 07-12 • X10 4T 4V 12-13 • X7 08-10 • X8 04-07 • X9 01-07 • Zip 00-02 • **150:** Fly 05-11 • Liberty 08-13 •
 Vespa Lx 05-12 • Vespa S 4T 08-12 • X8 06-08 • **180:** X9 00-03 • **200:** Carnaby 07-08 • Liberty 04-08 • Vespa Gts 06-07 • X8 05-07 • X9 02-03 • **250:**
 Beverly 04-09 • Carnaby 08 • Mp3 06-09 • Vespa Gts 05-14 • Vespa Gtv 06-09 • X Evo 07-13 • X7 08 • X8 05-08 • X9 04-08 • **300:** Beverly 09-14 •
 Carnaby Cruiser 09-12 • Mp3 10-14 • Vespa Gts 08-14 • Vespa Gtv 09-10 • X7 Evo 09-10
 (R.O. 82649R)



			10 066 9200		
			APRILIA-PIAGGIO: 843307 (Conf. 10 pezzi - 10 pcs/pack)		
10 066 9210		10 066 9220		10 066 9230	
APRILIA-DERBI-GILERA: 436438 PEUGEOT: 756140 - PIAGGIO: 436438 (Conf. 10 pezzi - 10 pcs/pack)		APRILIA: AP8122606 YAMAHA: 5H0121190000 (Conf. 10 pezzi - 10 pcs/pack)		APRILIA: AP0650120 (Conf. 10 pezzi - 10 pcs/pack)	
10 066 9240		10 066 9250		10 066 9260	
HONDA: 12209-GB4-681 KYMCO: 00122779 (Conf. 10 pezzi - 10 pcs/pack)		HONDA: 12209-MA6-003 - PEUGEOT: 766514 SUZUKI: 09289-04002-000-YAMAHA: 52SE21190000 (Conf. 10 pezzi - 10 pcs/pack)		PEUGEOT: 800984 (Conf. 10 pezzi - 10 pcs/pack)	
10 066 9270		10 066 9280		10 066 9290	
YAMAHA: 5STE21190000 (Conf. 10 pezzi - 10 pcs/pack)		SUZUKI: 09289-05011-000 (Conf. 10 pezzi - 10 pcs/pack)		SYM: 12209H6B900 (Conf. 10 pezzi - 10 pcs/pack)	
10 066 9300		10 066 9310		10 066 9320	
HONDA: 12208-ML0-721 - 12208-ML0-722 YAMAHA: 5YPE21190000 (Conf. 10 pezzi - 10 pcs/pack)		YAMAHA: 3P6121290000 (Conf. 10 pezzi - 10 pcs/pack)		YAMAHA: 4TV121190000 (Conf. 10 pezzi - 10 pcs/pack)	



PARAOLI VALVOLE VALVES OIL SEALS

MODELLO - MODEL	Cc	ANNI YEARS	CODICE RMS RMS CODE	RIF. ORIGINALE OEM NUMBER	MODELLO - MODEL	Cc	ANNI YEARS	CODICE RMS RMS CODE	RIF. ORIGINALE OEM NUMBER
APRILIA					Srv-Srv Abs Atc	850	12-14	10 066 9210	436438
Scarabeo 4T	50	02-06	10 066 9210	436438	Rsv4 R	1000	11-12	10 066 9210	436438
Scarabeo 4T 4V	50	10-12	10 066 9200	843307	Rsv4 R Abs	1000	13-14	10 066 9210	436438
Scarabeo 4T 4V	50	14	10 066 9200	843307	Rsv4 Factory-Sbk Racing	1000	09-10	10 066 9210	436438
Scarabeo 4T 4V Net	50	09-10	10 066 9200	843307	Rsv4 Factory Abs	1000	13-14	10 066 9210	436438
Scarabeo 4T Restyling Eu3	50	06-09	10 066 9210	436438	Rsv4 Factory Std-Se	1000	11-12	10 066 9210	436438
Scarabeo Quattro	50	09	10 066 9200	843307	Rsv4 R	1000	09-10	10 066 9210	436438
Sport City One 4T	50	08-10	10 066 9210	436438	Tuono V4 R Abs	1000	14	10 066 9210	436438
Sr Motard 4T 4V	50	13-14	10 066 9200	843307	Tuono V4 R Std	1000	11-13	10 066 9210	436438
Scarabeo 4T	100	01-05	10 066 9210	436438	DERBI				
Scarabeo 4T	100	10-12	10 066 9210	436438	Atlantis 4T Eu2	50	07	10 066 9210	436438
Scarabeo 4T	100	14	10 066 9210	436438	Atlantis 4T	50	04-06	10 066 9210	436438
Scarabeo 4T Net	100	09	10 066 9210	436438	Boulevard 4T Eu2 25 Km/H	50	09	10 066 9210	436438
Scarabeo 4T Net Eu3	100	10	10 066 9210	436438	Boulevard 4T	100	10-11	10 066 9210	436438
Scarabeo 4T Restyling	100	06-09	10 066 9210	436438	Boulevard	125	02-04	10 066 9210	436438
Atlantic	125	03-05	10 066 9210	436438	Boulevard Eu2	125	04-07	10 066 9210	436438
Atlantic Eu3	125	10-12	10 066 9210	436438	Boulevard 4T Eu3	125	08-12	10 066 9210	436438
Atlantic Eu3	125	06-08	10 066 9210	436438	Gp1 Eu2	125	06	10 066 9210	436438
Leonardo	125	96-02	10 066 9230	AP0650120	Gp1 Low Seat Eu3	125	07-08	10 066 9210	436438
Leonardo St	125	01-04	10 066 9230	AP0650120	Rambla	125	08-09	10 066 9210	436438
Mojito	125	03-08	10 066 9210	436438	Rambla E3 2Ver	125	08	10 066 9210	436438
Mojito Retrò-Custom	125	99-01	10 066 9210	436438	Sonar 4T	125	09-11	10 066 9210	436438
Scarabeo	125	03-06	10 066 9210	436438	Variant Sport 4T E3	125	12	10 066 9210	436438
Scarabeo Mot. Piaggio Eu3	125	06	10 066 9210	436438	Boulevard 4T E3	150	10	10 066 9210	436438
Scarabeo Motore Rotax	125	99-04	10 066 9230	AP0650120	Boulevard Eu2	200	05-06	10 066 9210	436438
Sport City	125	04-06	10 066 9210	436438	Gp1	250	06-07	10 066 9210	436438
Sport City Cube	125	08-10	10 066 9210	436438	Gp1 Low Seat Eu3	250	07-08	10 066 9210	436438
Sport City Eu3	125	06-08	10 066 9210	436438	Rambla	300	10-11	10 066 9210	436438
Sport City One 4T Eu3	125	08-11	10 066 9210	436438	GILERA				
Sport City Street	125	12	10 066 9210	436438	Dna	125	01	10 066 9210	436438
Sr Max	125	11-14	10 066 9210	436438	Nexus Eu3	125	07-08	10 066 9210	436438
Sr Motard	125	12-14	10 066 9210	436438	Nexus Eu3 ie	125	08-10	10 066 9210	436438
Leonardo	250	99-04	10 066 9220	AP8122606	Runner 4T St Eu3	125	08-13	10 066 9210	436438
Leonardo St	250	01	10 066 9220	AP8122606	Runner Vx	125	05-06	10 066 9210	436438
Scarabeo Light	250	06-08	10 066 9210	436438	Runner Vx 4T Eu3	125	06-07	10 066 9210	436438
Sport City Cube	250	08-10	10 066 9210	436438	Runner Vx Race	125	06	10 066 9210	436438
Atlantic	300	10-11	10 066 9210	436438	Runner Vx Sc	125	06-07	10 066 9210	436438
Scarabeo Light	300	09-10	10 066 9210	436438	Runner Vx- Vxr	125	00-01	10 066 9210	436438
Sport City Street	300	12	10 066 9210	436438	Runner Vx- Vxr	125	02-04	10 066 9210	436438
Sr Max	300	11-14	10 066 9210	436438	Runner Vxr	200	05-06	10 066 9210	436438
Atlantic Sprint	400	05-08	10 066 9210	436438	Runner Vxr 4T St Eu3	200	08-11	10 066 9210	436438
Scarabeo Light	400	06-08	10 066 9210	436438	Runner Vxr Eu3	200	07	10 066 9210	436438
Atlantic	500	01-04	10 066 9210	436438	Runner Vxr Race	200	05-06	10 066 9210	436438
Scarabeo	500	03-06	10 066 9210	436438	Nexus Eu3	250	06-07	10 066 9210	436438
Pegaso (Fun)-Factory-Trail	660	05-09	10 066 9220	AP8122606	Nexus Sp Eu3	250	06-07	10 066 9210	436438
Dorsoduro	750	08-14	10 066 9210	436438	Oregon	250	06-10	10 066 9210	436438
Dorsoduro Factory	750	10-13	10 066 9210	436438	Nexus Eu3	300	08-11	10 066 9210	436438
Shiver	750	07-14	10 066 9210	436438	Fuoco 4T- 4V ie E3 Lt	500	13-14	10 066 9210	436438
Shiver Gt	750	09	10 066 9210	436438	Fuoco Eu3	500	07-13	10 066 9210	436438
Mana	850	07-11	10 066 9210	436438	Nexus	500	03-05	10 066 9210	436438
Mana Gt	850	09-13	10 066 9210	436438	Nexus Eu3	500	06-11	10 066 9210	436438



MODELLO - MODEL	Cc	ANNI YEARS	CODICE RMS RMS CODE	RIF. ORIGINALE OEM NUMBER
Nexus Sp Eu3	500	06-07	10 066 9210	436438
Gp	800	07-11	10 066 9210	436438
Gp Centenario	800	09	10 066 9210	436438
HONDA				
Vision 110	110	12	10 066 9250	12209-MA6-003
@125	125	01-06	10 066 9250	12209-MA6-003
Ch 125 Spacy	125	93-96	10 066 9250	12209-MA6-003
Ch Spacy	125	84-86	10 066 9250	12209-MA6-003
Dylan 125	125	02-04	10 066 9250	12209-MA6-003
Dylan 125	125	02-04	10 066 9250	12209-MA6-003
Pantheon Fes	125	03-05	10 066 9250	12209-MA6-003
Pes 125 Injection	125	06-12	10 066 9250	12209-MA6-003
S Wing 125 Fes	125	07-10	10 066 9250	12209-MA6-003
S Wing 125 Fes Abs	125	07-12	10 066 9250	12209-MA6-003
Sh 125	125	01-12	10 066 9250	12209-MA6-003
@150	150	00-01	10 066 9250	12209-MA6-003
Crf 150	150	07-09	10 066 9300	12208-ML0-721
Crf 150 Expert	150	07-13	10 066 9300	12208-ML0-721
Crf 150 R	150	10-14	10 066 9300	12208-ML0-721
Dylan 150	150	02-04	10 066 9250	12209-MA6-003
Pantheon 150 Fes	150	03-09	10 066 9250	12209-MA6-003
Pes 150 Injection	150	06-10	10 066 9250	12209-MA6-003
S Wing 150 Fes Abs	150	03-07	10 066 9250	12209-MA6-003
Sh 150	150	01-12	10 066 9250	12209-MA6-003
Cn	250	88-99	10 066 9250	12209-MA6-003
Crf 250	250	10-11	10 066 9300	12208-ML0-721
Crf 250 R	250	12-15	10 066 9300	12208-ML0-721
Forza 300	300	13	10 066 9300	12208-ML0-721
Forza 300	300	13	10 066 9300	12208-ML0-721
Forza 300 Abs	300	13	10 066 9300	12208-ML0-721
Forza 300 Abs	300	13-15	10 066 9300	12208-ML0-721
Sh 300	300	07-16	10 066 9300	12208-ML0-721
Rvf 400	400	96	10 066 9300	12208-ML0-721
Silver Wing 400	400	06-09	10 066 9300	12208-ML0-721
Sw T 400 Abs	400	09	10 066 9300	12208-ML0-721
Vfr 400	400	90-91	10 066 9300	12208-ML0-721
CB 500	500	02-06	10 066 9300	12208-ML0-721
CB 500	500	94-02	10 066 9300	12208-ML0-721
Cbf 500	500	04-06	10 066 9300	12208-ML0-721
Cbf 500 Abs	500	04-06	10 066 9300	12208-ML0-721
Silver Wing 600	600	01-10	10 066 9300	12208-ML0-721
Silver Wing 600 Abs	600	03-07	10 066 9300	12208-ML0-721
Ctx 700 Abs	700	14	10 066 9250	12209-MA6-003
Ctx 700 Abs	700	14	10 066 9250	12209-MA6-003
Ctx 700 Dual Clutch	700	14	10 066 9250	12209-MA6-003
Ctx 700 Dual Clutch	700	14	10 066 9250	12209-MA6-003
Ctx 700 N	700	14	10 066 9250	12209-MA6-003
Ctx 700 N Abs	700	14	10 066 9250	12209-MA6-003
Ctx 700 N Abs	700	14	10 066 9250	12209-MA6-003
Ctx 700 N Dual Clutch	700	14	10 066 9250	12209-MA6-003
Ctx 700 N Dual Clutch	700	14	10 066 9250	12209-MA6-003

MODELLO - MODEL	Cc	ANNI YEARS	CODICE RMS RMS CODE	RIF. ORIGINALE OEM NUMBER
Integra 700	700	12-13	10 066 9250	12209-MA6-003
Nc 700 35Kw	700	12-13	10 066 9250	12209-MA6-003
Nc 700 Abs 35Kw	700	12-13	10 066 9250	12209-MA6-003
Nc 700 Abs Dct 35Kw	700	12-13	10 066 9250	12209-MA6-003
Nc 700 X	700	12	10 066 9250	12209-MA6-003
Nc 700 X 35Kw	700	12-13	10 066 9250	12209-MA6-003
Nc 700 X Abs	700	12-13	10 066 9250	12209-MA6-003
Nc 700 X Abs 35Kw	700	12-13	10 066 9250	12209-MA6-003
Nc 700 X Abs Dct	700	12-13	10 066 9250	12209-MA6-003
Integra 750	750	16	10 066 9250	12209-MA6-003
Integra 750	750	16	10 066 9250	12209-MA6-003
Nc 750 J Vultus	750	15	10 066 9250	12209-MA6-003
Nc 750 S	750	14-16	10 066 9250	12209-MA6-003
Nc 750 S Abs	750	14-15	10 066 9250	12209-MA6-003
Nc 750 S Abs	750	14-16	10 066 9250	12209-MA6-003
Nc 750 S Dct	750	14-16	10 066 9250	12209-MA6-003
Nc 750 X	750	14-16	10 066 9250	12209-MA6-003
Nc 750 X Abs	750	14-15	10 066 9250	12209-MA6-003
Nc 750 X Abs	750	14-16	10 066 9250	12209-MA6-003
Nc 750 X Abs Dct	750	14-15	10 066 9250	12209-MA6-003
Nc 750 X Abs Dct	750	14-16	10 066 9250	12209-MA6-003
Rc45 Rvf 750	750	94-95	10 066 9300	12208-ML0-721
Shadow 750	750	93-99	10 066 9300	12208-ML0-721
Vfr 750	750	90-97	10 066 9300	12208-ML0-721
Crossrunner 800	800	11-15	10 066 9300	12208-ML0-721
Vfr 800	800	02-04	10 066 9300	12208-ML0-721
Vfr 800	800	98-01	10 066 9300	12208-ML0-721
Vfr 800 Abs	800	02-04	10 066 9300	12208-ML0-721
Vfr 800 F	800	14-15	10 066 9300	12208-ML0-721
Vfr 800 Vtec	800	05-09	10 066 9300	12208-ML0-721
Vfr 800 Vtec Abs	800	05-09	10 066 9300	12208-ML0-721
Crosstourer 1200	1200	12-16	10 066 9300	12208-ML0-721
Crosstourer 1200	1200	15-16	10 066 9300	12208-ML0-721
Vfr 1200	1200	10-13	10 066 9300	12208-ML0-721
Vfr 1200	1200	15	10 066 9300	12208-ML0-721
Vfr 1200 Dct	1200	12-15	10 066 9300	12208-ML0-721
F6b 1800 Bagger	1800	13-15	10 066 9250	12209-MA6-003
GL1800 Gold Wing	1800	01-16	10 066 9250	12209-MA6-003
KYMCO				
Agility 4T Carry	50	11	10 066 9240	00122779
Agility 4T R10	50	06-08	10 066 9240	00122779
Agility 4T R12	50	07-08	10 066 9240	00122779
Agility 4T R16	50	08-09	10 066 9240	00122779
Agility 4T R16	50	12	10 066 9240	00122779
Agility R12	50	05	10 066 9240	00122779
Agility Rs	50	09	10 066 9240	00122779
Filly	50	98-00	10 066 9240	00122779
Filly Lx	50	01-02	10 066 9240	00122779
Like 4T	50	09	10 066 9240	00122779
Super 8	50	07	10 066 9240	00122779
Super 8 4T	50	09	10 066 9240	00122779



PARAOLI VALVOLE VALVES OIL SEALS

MODELLO - MODEL	Cc	ANNI YEARS	CODICE RMS RMS CODE	RIF. ORIGINALE OEM NUMBER	MODELLO - MODEL	Cc	ANNI YEARS	CODICE RMS RMS CODE	RIF. ORIGINALE OEM NUMBER
Super 8 4T	50	13	10 066 9240	00122779	Like Lx	200	12	10 066 9240	00122779
Vitality 4T	50	04	10 066 9240	00122779	People Gti	200	10	10 066 9240	00122779
Agility Rs	125	09	10 066 9240	00122779	People Gti	200	14	10 066 9240	00122779
Agility 4T	125	06	10 066 9240	00122779	People S	200	05	10 066 9240	00122779
Agility 4T Eu3	125	06-08	10 066 9240	00122779	People S I	200	07	10 066 9240	00122779
Agility Carry	125	11	10 066 9240	00122779	B&w	250	00	10 066 9240	00122779
Agility Plus	125	14	10 066 9240	00122779	B&w Eu2	250	03	10 066 9240	00122779
Agility R16	125	08-09	10 066 9240	00122779	Grand Dink	250	01-02	10 066 9240	00122779
Agility R16	125	12	10 066 9240	00122779	Grand Dink Eu2	250	03-04	10 066 9240	00122779
B&w	125	00	10 066 9240	00122779	Kxr	250	03-04	10 066 9240	00122779
B&w Eu2	125	03-04	10 066 9240	00122779	People S	250	06	10 066 9240	00122779
Dink Eu3	125	06-07	10 066 9240	00122779	Venox Eu3	250	07	10 066 9240	00122779
Dink Eu3	125	06-07	10 066 9240	00122779	X Citing I	250	05-07	10 066 9240	00122779
Dink	125	97-98	10 066 9240	00122779	X Citing I	500	06-07	10 066 9240	00122779
Dink Classic	125	02	10 066 9240	00122779	PEUGEOT				
Dink Classic Eu2	125	03	10 066 9240	00122779	Tweet	50	-	10 066 9260	800984
Dink Lx	125	98-00	10 066 9240	00122779	Tweet A Pmx	50	-	10 066 9260	800984
G-Dink	125	12	10 066 9240	00122779	Tweet N	50	-	10 066 9260	800984
Grand Dink	125	01-02	10 066 9240	00122779	Tweet Pmx	50	-	10 066 9260	800984
Grand Dink Eu2	125	03-04	10 066 9240	00122779	Tweet V	50	-	10 066 9260	800984
Heroism	125	95-97	10 066 9240	00122779	Tweet X	50	-	10 066 9260	800984
K-Pipe	125	12-13	10 066 9240	00122779	City Star	125	-	10 066 9260	800984
Like	125	09	10 066 9240	00122779	Citystar 125 Lc	125	-	10 066 9250	766514
Like Lx	125	12	10 066 9240	00122779	Citystar 125 Lc Av	125	-	10 066 9250	766514
Movi E Eu3	125	06-07	10 066 9240	00122779	Citystar 125 Lc Mx	125	-	10 066 9250	766514
Movie	125	99-00	10 066 9240	00122779	Fight3 125	125	-	10 066 9260	800984
Movie 1Eu3	125	06-07	10 066 9240	00122779	Fight3 125 Ds	125	-	10 066 9260	800984
Movie XL	125	01	10 066 9240	00122779	Fight3 125	125	-	10 066 9260	800984
Movie XL Eu2	125	03-04	10 066 9240	00122779	Geo 125	125	-	10 066 9250	766514
People	125	99-00	10 066 9240	00122779	Looxor	125	-	10 066 9210	756140
People Eu2	125	03	10 066 9240	00122779	Lxr 125	125	-	10 066 9260	800984
People Eu3	125	07-08	10 066 9240	00122779	Sat 125	125	-	10 066 9250	766514
People Eu3	125	11	10 066 9240	00122779	Tweet 125	125	-	10 066 9260	800984
People One I	125	13	10 066 9240	00122779	Citystar 150	150	-	10 066 9260	800984
People S	125	05	10 066 9240	00122779	Looxor 150 F	150	-	10 066 9210	756140
People S Dd Eu3	125	07-08	10 066 9240	00122779	Tweet 150	150	-	10 066 9260	800984
Quannon	125	08	10 066 9240	00122779	Citystar 200 Lc	200	-	10 066 9250	766514
Quannon Naked	125	10	10 066 9240	00122779	Lxr 200	200	-	10 066 9260	800984
Super 8	125	08-09	10 066 9240	00122779	Geo 250	250	-	10 066 9210	756140
Vivio	125	00	10 066 9240	00122779	Sat 250	250	-	10 066 9210	756140
Agility R16	150	08-09	10 066 9240	00122779	Geo	300	-	10 066 9210	756140
Heroism	150	95-97	10 066 9240	00122779	Sat 2	300	-	10 066 9210	756140
Movi E Eu3	150	06-07	10 066 9240	00122779	Geo C	400	-	10 066 9210	756140
Movie Eu3	150	06-07	10 066 9240	00122779	Geo S	400	-	10 066 9210	756140
Agility I R16	200	10	10 066 9240	00122779	Geo Sc	400	-	10 066 9210	756140
Agility I Plus	200	14	10 066 9240	00122779	Geo X	400	-	10 066 9210	756140
Agility R16	200	12	10 066 9240	00122779	Geo Xn	400	-	10 066 9210	756140
Dink Eu3i	200	06-07	10 066 9240	00122779	Sat	400	-	10 066 9210	756140
Dink Classic	200	04	10 066 9240	00122779	Sat C	400	-	10 066 9210	756140
Downtown I	200	10	10 066 9240	00122779	Sat S	400	-	10 066 9210	756140
Like I	200	09	10 066 9240	00122779	Sat Sc	400	-	10 066 9210	756140



MODELLO - MODEL	Cc	ANNI YEARS	CODICE RMS RMS CODE	RIF. ORIGINALE OEM NUMBER
Sat X	400	-	10 066 9210	756140
Sat Xn	400	-	10 066 9210	756140
Geo	500	-	10 066 9210	756140
Sat	500	-	10 066 9210	756140
Sat C	500	-	10 066 9210	756140
Sat S	500	-	10 066 9210	756140
Sat Sc	500	-	10 066 9210	756140
Sat X	500	-	10 066 9210	756140
PIAGGIO				
Fly 4T	50	05-07	10 066 9210	436438
Fly 4T & 25-30 Km/H	50	08-11	10 066 9210	436438
Fly 4T 2V	50	13	10 066 9210	436438
Fly 4T 2V 25-30Km-H	50	12-14	10 066 9210	436438
Fly 4T 4V	50	12-13	10 066 9200	843307
Fly 4T Motore Chn	50	06-07	10 066 9210	436438
Liberty 4T	50	00-02	10 066 9210	436438
Liberty 4T	50	05-08	10 066 9210	436438
Liberty 4T Delivery - Single	50	10-12	10 066 9210	436438
Liberty 4T Delivery Tnt	50	09	10 066 9210	436438
Liberty 4T Ptt - Double	50	09-12	10 066 9210	436438
Liberty 4T Ptt (Deu)	50	07-12	10 066 9210	436438
Liberty 4T Rst	50	04	10 066 9210	436438
Liberty 4T Sport	50	06-08	10 066 9210	436438
Liberty lget 4T 3V ie	50	15-16	10 066 9200	843307
Liberty Moc 4T & Elle	50	09-13	10 066 9210	436438
Vespa Et4	50	00-05	10 066 9210	436438
Vespa Lx 4T	50	05-08	10 066 9210	436438
Vespa Lx 4T- 4V	50	09-13	10 066 9200	843307
Vespa Lx 4T- 4V Touring	50	10-13	10 066 9200	843307
Vespa Primavera 4T- 4V	50	13-16	10 066 9200	843307
Vespa S 4T- 4V & College	50	08-12	10 066 9200	843307
Vespa Sprint 4T 4V	50	14-16	10 066 9200	843307
Zip 4T	50	00-13	10 066 9210	436438
Fly 4T	100	06-08	10 066 9210	436438
Free	100	02-03	10 066 9210	436438
Zip 4T	100	06-10	10 066 9210	436438
Beverly	125	01-03	10 066 9210	436438
Beverly Eu3	125	07-08	10 066 9210	436438
Beverly Eu3 Mic	125	07	10 066 9210	436438
Beverly Eu3 Sport	125	07-08	10 066 9210	436438
Beverly Rst	125	04-07	10 066 9210	436438
Beverly Rst 4T 4V ie Eu3	125	10-13	10 066 9210	436438
Beverly Tourer Eu3	125	07-10	10 066 9210	436438
Carnaby	125	07-10	10 066 9210	436438
Fly	125	05-07	10 066 9210	436438
Fly 4T 3V ie E3 Dt	125	13-15	10 066 9200	843307
Fly 4T 3V ie Eu3 Lem	125	12-13	10 066 9200	843307
Fly 4T 3V ie E3 Dt	125	13	10 066 9210	436438
Fly 4T 3V ie Eu3 Lem	125	12-13	10 066 9210	436438
Fly Eu3	125	07-11	10 066 9210	436438
Hexagon Gtx	125	00	10 066 9210	436438

MODELLO - MODEL	Cc	ANNI YEARS	CODICE RMS RMS CODE	RIF. ORIGINALE OEM NUMBER
Hexagon Lx4	125	98-99	10 066 9210	436438
Liberty 4T 3V ie E3	125	13-14	10 066 9200	843307
Liberty	125	98-02	10 066 9210	436438
Liberty 4T	125	06-07	10 066 9210	436438
Liberty 4T 2V Eu3	125	09-12	10 066 9210	436438
Liberty 4T 2V ie Ptt - Ita	125	12	10 066 9210	436438
Liberty 4T 3V ie E3	125	13-14	10 066 9210	436438
Liberty 4T Eu3	125	07-08	10 066 9210	436438
Liberty 4T Eu3 Delivery-Single	125	07-12	10 066 9210	436438
Liberty 4T Eu3 Delivery - Tnt	125	08-09	10 066 9210	436438
Liberty 4T Sport Eu3	125	06-08	10 066 9210	436438
Liberty lget 4T 3V ie	125	15-16	10 066 9200	843307
Liberty Rst	125	04-05	10 066 9210	436438
Liberty Rst Ptt	125	05-11	10 066 9210	436438
Liberty Sport	125	06	10 066 9210	436438
Medley 4T ie Abs	125	16	10 066 9200	843307
Mp3	125	06-08	10 066 9210	436438
Mp3 Ibrido	125	09-10	10 066 9210	436438
Mp3 ie	125	08-09	10 066 9210	436438
Mp3 ie Touring	125	11-12	10 066 9210	436438
Mp3 Yourban ERL	125	11-12	10 066 9210	436438
Sfera	125	95-97	10 066 9210	436438
Skipper 4T	125	00-02	10 066 9210	436438
Super Hexagon Gtx 12	125	01-02	10 066 9210	436438
Typhoon 4T 2V Eu3	125	10-11	10 066 9210	436438
Vespa 946 4T 3V Abs (Aspirazione - Intake)	125	13-15	10 066 9200	843307
Vespa 946 4T 3V Abs (Scarico - Exhaust)	125	13-14	10 066 9210	436438
Vespa Et4	125	96-02	10 066 9210	436438
Vespa Granturismo	125	03-07	10 066 9210	436438
Vespa Granturismo Eu3	125	06-07	10 066 9210	436438
Vespa Gts 4T ie Super	125	09-14	10 066 9210	436438
Vespa Gts Eu3	125	07-12	10 066 9210	436438
Vespa Gtv	125	06-08	10 066 9210	436438
Vespa Gtv 4T Navy Eu3	125	08	10 066 9210	436438
Vespa Lx 4T 3V ie - Touring	125	12-13	10 066 9200	843307
Vespa Lx Primavera 4T 3V ie	125	13-16	10 066 9200	843307
Vespa Primavera 4T 3V lget Abs	125	16	10 066 9200	843307
Vespa S 4T 3V ie	125	12	10 066 9200	843307
Vespa Sprint 4T 3V ie	125	14-15	10 066 9200	843307
Vespa Sprint lget 4T 3V Abs	125	16	10 066 9200	843307
Liberty 4T 3V Lem	150	13-14	10 066 9200	843307
Liberty lget 4T 3V ie	150	15-16	10 066 9200	843307
Medley 4T ie Abs	150	16	10 066 9200	843307
Vespa Lx 4T 3V ie-Touring	150	12-13	10 066 9200	843307
Vespa Primavera 4T- 3V	150	13-16	10 066 9200	843307
Vespa Primavera 4T 3V lget Abs	150	16	10 066 9200	843307



PARAOLI VALVOLE VALVES OIL SEALS

MODELLO - MODEL	Cc	ANNI YEARS	CODICE RMS RMS CODE	RIF. ORIGINALE OEM NUMBER
SUZUKI				
An S-Y	125	95-00	10 066 9280	09289-05011-000
Dr Sm K9-L0	125	09-10	10 066 9280	09289-05011-000
Gz Marauder K3-K4	125	03-04	10 066 9280	09289-05011-000
Gz Marauder K8-L0	125	08-10	10 066 9280	09289-05011-000
Rv Van Van K3-K7	125	03-07	10 066 9280	09289-05011-000
Rv Van Van K8-L0	125	08-10	10 066 9280	09289-05011-000
Rv Van Van L3	125	13	10 066 9280	09289-05011-000
Uc Epicuro X-K1	125	99-01	10 066 9280	09289-05011-000
Uh Burgman K2-K6	125	02-06	10 066 9280	09289-05011-000
Uh Burgman K7-L0	125	07-10	10 066 9280	09289-05011-000
Uh Burgman L1	125	11-12	10 066 9280	09289-05011-000
Uh Burgman L3	125	13	10 066 9280	09289-05011-000
Ux Sixteen K8-L0	125	08-10	10 066 9280	09289-05011-000
Ux Sixteen L1	125	11	10 066 9280	09289-05011-000
VI Intruder K5-K7	125	05-07	10 066 9250	09289-04002-000
VI Intruder Y-K1	125	00-01	10 066 9250	09289-04002-000
An T-Y	150	96-00	10 066 9280	09289-05011-000
Uc Epicuro X-K1	150	99-01	10 066 9280	09289-05011-000
Uh Burgman K2-K6	150	02-06	10 066 9280	09289-05011-000
Ux Sixteen K8-L0	150	08-10	10 066 9280	09289-05011-000
Ux Sixteen L1	150	11	10 066 9280	09289-05011-000
Uh Burgman K7-L0	200	07-10	10 066 9280	09289-05011-000
Uh Burgman L1	200	11-12	10 066 9280	09289-05011-000
Uh Burgman L3	200	13	10 066 9280	09289-05011-000
An Burgman K3-K6	250	03-06	10 066 9280	09289-05011-000
An Burgman W-K2	250	98-02	10 066 9280	09289-05011-000
Rm-Z K7-K9	250	07-09	10 066 9250	09289-04002-000
Rm-Z L0	250	10	10 066 9250	09289-04002-000
Rm-Z L1	250	11	10 066 9250	09289-04002-000
Rm-Z L2	250	12	10 066 9250	09289-04002-000
Rm-Z L3	250	13	10 066 9250	09289-04002-000
Rm-Z L4	250	14	10 066 9250	09289-04002-000
VL Intruder K5-K7	250	05-07	10 066 9250	09289-04002-000
VL Intruder Y-K1	250	00-01	10 066 9250	09289-04002-000
Dr S L-R	350	90-94	10 066 9280	09289-05011-000
Dr Se R-W	350	94-98	10 066 9280	09289-05011-000
An Burgman K3-K6	400	03-06	10 066 9280	09289-05011-000
An Burgman K7-L0	400	07-10	10 066 9250	09289-04002-000
An Burgman L1	400	11	10 066 9250	09289-04002-000
An Burgman L2	400	12	10 066 9250	09289-04002-000
An Burgman L3	400	13	10 066 9250	09289-04002-000
An Burgman L4	400	14	10 066 9250	09289-04002-000
An Burgman X-K2	400	99-02	10 066 9280	09289-05011-000
Dr-Z E K5-K7	400	05-07	10 066 9280	09289-05011-000
Dr-Z S K5-K9	400	05-09	10 066 9280	09289-05011-000
Dr-Z S Y-K4	400	00-04	10 066 9280	09289-05011-000
Dr-Z Sm K5-K9	400	05-09	10 066 9280	09289-05011-000
Dr-Z Y-K3	400	00-03	10 066 9280	09289-05011-000
Gsf Bandit M-P	400	91-93	10 066 9250	09289-04002-000
Lt-A F Kingquad 4X4 K8-L0	400	08-10	10 066 9280	09289-05011-000
Lt-A F Kingquad 4X4 L1	400	11	10 066 9280	09289-05011-000

MODELLO - MODEL	Cc	ANNI YEARS	CODICE RMS RMS CODE	RIF. ORIGINALE OEM NUMBER
Lt-F Kingquad Fs 4X2 K8-L0	400	08-10	10 066 9280	09289-05011-000
Lt-F Kingquad Fs 4X4 K8-L0	400	08-10	10 066 9280	09289-05011-000
Lt-F Kingquad Fs 4X4 L1	400	11	10 066 9280	09289-05011-000
Lt-F Kingquad Fs 4X4 L2	400	12	10 066 9280	09289-05011-000
Lt-Z QuadSport K4-K7	400	04-07	10 066 9280	09289-05011-000
Lt-Z QuadSport K8	400	08	10 066 9280	09289-05011-000
Lt-Z QuadSport K9-L0	400	09-10	10 066 9280	09289-05011-000
Lt-Z QuadSport L1	400	11	10 066 9280	09289-05011-000
Lt-Z QuadSport L2	400	12	10 066 9280	09289-05011-000
Lt-A X Kingquad 4X4 K7-L0	450	07-10	10 066 9280	09289-05011-000
Rm-Z K5-K6	450	05-06	10 066 9280	09289-05011-000
Lt-A Kingquad X L2	500	12	10 066 9280	09289-05011-000
Lt-A Kingquad Xp K9-L0	500	09-10	10 066 9280	09289-05011-000
Lt-A Kingquad Xp L1	500	11	10 066 9280	09289-05011-000
Lt-A Kingquad Xp L2	500	12	10 066 9280	09289-05011-000
Lt-A F Vinson K4-K7	500	04-07	10 066 9280	09289-05011-000
Gsf Bandit S-W	600	95-98	10 066 9280	09289-05011-000
Gsf Bandit Y-K4	600	00-04	10 066 9280	09289-05011-000
Gsx F J-S	600	88-95	10 066 9280	09289-05011-000
Gsx F K4-K6	600	04-06	10 066 9280	09289-05011-000
Gsx Fw-K3	600	98-03	10 066 9280	09289-05011-000
Gsx-R K4-K5	600	04-05	10 066 9250	09289-04002-000
Gsx-R K6-K7	600	06-07	10 066 9250	09289-04002-000
Gsx-R K8-L0	600	08-10	10 066 9250	09289-04002-000
Gsx-R L1	600	11	10 066 9250	09289-04002-000
Gsx-R L2	600	12	10 066 9250	09289-04002-000
Gsx-R L3	600	13	10 066 9250	09289-04002-000
Gsx-R L4	600	14	10 066 9250	09289-04002-000
Gsx-R V-Y	600	97-00	10 066 9250	09289-04002-000
Rf R P-T	600	93-96	10 066 9250	09289-04002-000
An Burgman K3-K5	650	03-05	10 066 9250	09289-04002-000
An Burgman K6-L0	650	06-10	10 066 9250	09289-04002-000
An Burgman L1	650	11	10 066 9250	09289-04002-000
An Burgman L2	650	12	10 066 9250	09289-04002-000
An Burgman L3	650	13	10 066 9250	09289-04002-000
DL V-Strom Abs L4	650	14	10 066 9250	09289-04002-000
DL V-Strom K4-K6	650	04-06	10 066 9250	09289-04002-000
DL V-Strom K7-L0	650	07-10	10 066 9250	09289-04002-000
DL V-Strom L1	650	11	10 066 9250	09289-04002-000
DL V-Strom L2	650	12	10 066 9250	09289-04002-000
Gsf Bandit K5-K6	650	05-06	10 066 9280	09289-05011-000
Gsf Bandit K7-K8	650	07-08	10 066 9250	09289-04002-000
Gsf Bandit K9-L0	650	09-10	10 066 9250	09289-04002-000
Gsf Bandit L1	650	11	10 066 9250	09289-04002-000
Gsf Bandit L2	650	12	10 066 9250	09289-04002-000
Gsx F K8-L0	650	08-10	10 066 9250	09289-04002-000
Gsx F L1	650	11	10 066 9250	09289-04002-000
Gsx F L2	650	12	10 066 9250	09289-04002-000
Sfv Gladius K9-L0	650	09-10	10 066 9250	09289-04002-000
Sfv Gladius L1	650	11	10 066 9250	09289-04002-000
Sfv Gladius L2	650	12	10 066 9250	09289-04002-000
Sfv Gladius L3	650	13	10 066 9250	09289-04002-000
Sfv Gladius L4	650	14	10 066 9250	09289-04002-000
Sv K3-K7	650	03-07	10 066 9250	09289-04002-000
Sv K8-L0	650	08-10	10 066 9250	09289-04002-000



MODELLO - MODEL	Cc	ANNI YEARS	CODICE RMS RMS CODE	RIF. ORIGINALE OEM NUMBER
Sv X-K2	650	99-02	10 066 9250	09289-04002-000
Gsx F K4-K6	750	04-06	10 066 9280	09289-05011-000
Gsx F K-T	750	89-96	10 066 9280	09289-05011-000
Gsx F W-K3	750	98-03	10 066 9280	09289-05011-000
Gsx W-K1	750	98-01	10 066 9280	09289-05011-000
Gsx-R F-H	750	85-87	10 066 9280	09289-05011-000
Gsx-R J-L	750	88-90	10 066 9280	09289-05011-000
Gsx-R K4-K5	750	04-05	10 066 9250	09289-04002-000
Gsx-R K6-K7	750	06-07	10 066 9250	09289-04002-000
Gsx-R K8-L0	750	08-10	10 066 9250	09289-04002-000
Gsx-R L1	750	11	10 066 9250	09289-04002-000
Gsx-R L2	750	12	10 066 9250	09289-04002-000
Gsx-R L3	750	13	10 066 9250	09289-04002-000
Gsx-R L4	750	14	10 066 9250	09289-04002-000
Gsx-R M	750	91-91	10 066 9280	09289-05011-000
Gsx-R Sp R	750	94-94	10 066 9250	09289-04002-000
Gsx-R T-X	750	96-99	10 066 9250	09289-04002-000
Gsx-R W N-S	750	92-95	10 066 9250	09289-04002-000
Rf R R-T	900	94-96	10 066 9250	09289-04002-000
Gsx-R K5-K6	1000	05-06	10 066 9250	09289-04002-000
Gsx-R K7-K8	1000	07-08	10 066 9250	09289-04002-000
Gsx-R K9-L0	1000	09-10	10 066 9250	09289-04002-000
Gsx-R L1	1000	11	10 066 9250	09289-04002-000
Gsx-R L2	1000	12	10 066 9250	09289-04002-000
Gsx-R L3	1000	13	10 066 9250	09289-04002-000
Gsx-R L4	1000	14	10 066 9250	09289-04002-000
Gsx-R ZL4	1000	14	10 066 9250	09289-04002-000
Gsx F J-P	1100	88-93	10 066 9280	09289-05011-000
Gsx-R G-J	1100	86-88	10 066 9280	09289-05011-000
Gsx-R K-L	1100	89-90	10 066 9280	09289-05011-000
Gsx-R M-N	1100	91-92	10 066 9280	09289-05011-000
Gsx-R W P-T	1100	93-96	10 066 9250	09289-04002-000
Gsf Bandit K1-K5	1200	01-05	10 066 9280	09289-05011-000
Gsf Bandit K6	1200	06	10 066 9280	09289-05011-000
Gsf Bandit T-Y	1200	96-00	10 066 9280	09289-05011-000
Gsx X-K1	1200	99-01	10 066 9280	09289-05011-000
Gsf Bandit K7-L0	1250	07-10	10 066 9250	09289-04002-000
Gsf Bandit L1	1250	11	10 066 9250	09289-04002-000
Gsf S Bandit L1	1250	11	10 066 9250	09289-04002-000
Gsf S Bandit L2	1250	12	10 066 9250	09289-04002-000
Gsx Fa L0	1250	10	10 066 9250	09289-04002-000
Gsx Fa L1	1250	11	10 066 9250	09289-04002-000
Gsx Fa L2	1250	12	10 066 9250	09289-04002-000
Gsx Bk B-King K8-L0	1300	08-10	10 066 9280	09289-05011-000
Gsz R Hayabusa K4-K7	1300	04-07	10 066 9280	09289-05011-000
Gsz R Hayabusa K8-L0	1300	08-10	10 066 9280	09289-05011-000
Gsz R Hayabusa L1	1300	11	10 066 9280	09289-05011-000
Gsz R Hayabusa L2	1300	12	10 066 9280	09289-05011-000
Gsz R Hayabusa X-K3	1300	99-03	10 066 9280	09289-05011-000
Gsz Ra Hayabusa L3	1300	13	10 066 9280	09289-05011-000
Gsz Ra Hayabusa L4	1300	14	10 066 9280	09289-05011-000

MODELLO - MODEL	Cc	ANNI YEARS	CODICE RMS RMS CODE	RIF. ORIGINALE OEM NUMBER
Gsx K2-K5	1400	02-05	10 066 9250	09289-04002-000
Gsx K6-K7	1400	06-07	10 066 9250	09289-04002-000
SYM				
Fiddle Li S	50	09-13	10 066 9290	12209H6B900
Jet4	50	09-10	10 066 9290	12209H6B900
Mio	50	06-07	10 066 9290	12209H6B900
Mio	50	09	10 066 9290	12209H6B900
Simply Li	50	14	10 066 9290	12209H6B900
Symphony	50	09	10 066 9290	12209H6B900
Symphony S	50	10-12	10 066 9290	12209H6B900
Symphony Sr	50	11-12	10 066 9290	12209H6B900
Symply Li	50	09	10 066 9290	12209H6B900
X Pro	50	13	10 066 9290	12209H6B900
Mio Eu2	100	05-06	10 066 9290	12209H6B900
Mio Eu3	100	07-08	10 066 9290	12209H6B900
Fiddle II	125	10-13	10 066 9290	12209H6B900
Fiddle III	125	14	10 066 9290	12209H6B900
Gts Joymax	125	06-07	10 066 9290	12209H6B900
Hd Eu2	125	03-04	10 066 9290	12209H6B900
Hd Eu3	125	07-08	10 066 9290	12209H6B900
Hd Evo	125	05-06	10 066 9290	12209H6B900
Hd Evo Eu3	125	07-08	10 066 9290	12209H6B900
Hd Evo Eu3	125	10-11	10 066 9290	12209H6B900
Hd Evo Tamburo Eu3	125	08-09	10 066 9290	12209H6B900
Hd2	125	11	10 066 9290	12209H6B900
Hd2	125	14	10 066 9290	12209H6B900
Jet V	125	11	10 066 9290	12209H6B900
Jet4	125	09-10	10 066 9290	12209H6B900
Joyride Eu2	125	03-04	10 066 9290	12209H6B900
Joyride Eu2	125	05-06	10 066 9290	12209H6B900
Joyride Evo	125	09-10	10 066 9290	12209H6B900
Joyride Eu3	125	07	10 066 9290	12209H6B900
Joyride Evo	125	10	10 066 9290	12209H6B900
Joyride Evo	125	13-14	10 066 9290	12209H6B900
Megalo	125	06-07	10 066 9290	12209H6B900
Megalo	125	06-07	10 066 9290	12209H6B900
Symphony	125	09	10 066 9290	12209H6B900
Symphony S	125	09-10	10 066 9290	12209H6B900
Symphony S	125	12-14	10 066 9290	12209H6B900
Symphony Sr	125	10	10 066 9290	12209H6B900
Symphony Sr	125	12	10 066 9290	12209H6B900
Symply II	125	14	10 066 9290	12209H6B900
Vs	125	06	10 066 9290	12209H6B900
Vs	125	06	10 066 9290	12209H6B900
Vs Eu3	125	07-08	10 066 9290	12209H6B900
Vs Eu3	125	07-08	10 066 9290	12209H6B900
X Pro	125	13	10 066 9290	12209H6B900
Fiddle II	150	10	10 066 9290	12209H6B900
Fiddle II	150	12	10 066 9290	12209H6B900
Joyride	150	01-02	10 066 9290	12209H6B900
Symphony S	150	09-10	10 066 9290	12209H6B900



PARAOLI VALVOLE VALVES OIL SEALS

MODELLO - MODEL	Cc	ANNI YEARS	CODICE RMS RMS CODE	RIF. ORIGINALE OEM NUMBER	MODELLO - MODEL	Cc	ANNI YEARS	CODICE RMS RMS CODE	RIF. ORIGINALE OEM NUMBER
Symphony S	150	12-14	10 066 9290	12209H6B900	Tw	125	03	10 066 9220	5H0121190000
Symphony Sr	150	10	10 066 9290	12209H6B900	Vp X- City	125	08-11	10 066 9300	5YPE21190000
Symphony Sr	150	12	10 066 9290	12209H6B900	Wr R	125	09-11	10 066 9300	5YPE21190000
Vs	150	06	10 066 9290	12209H6B900	Wr X	125	09-11	10 066 9300	5YPE21190000
Vs	150	06	10 066 9290	12209H6B900	Wr X	125	13	10 066 9300	5YPE21190000
Vs Eu3	150	07-08	10 066 9290	12209H6B900	Xc Cygnus R	125	99-99	10 066 9300	4TE121190000
Vs Eu3	150	07-08	10 066 9290	12209H6B900	Xc Cygnus R	125	00-03	10 066 9300	4TE121190000
Track Runner	180	06-07	10 066 9290	12209H6B900	Xc R Majesty S	125	14	10 066 9250	52SE21190000
Track Runner	180	06-07	10 066 9290	12209H6B900	Xn Teo' S	125	00	10 066 9300	4TE121190000
Hd Eu2	200	03-04	10 066 9290	12209H6B900	Xq Maxster	125	01-02	10 066 9300	4TE121190000
Hd Eu3 I	200	07	10 066 9290	12209H6B900	Yp Majesty	125	98-02	10 066 9300	4TE121190000
Hd Evo Eu2	200	05-06	10 066 9290	12209H6B900	Yp E Majesty	125	03-09	10 066 9300	4TE121190000
Hd Evo Eu3 I	200	07	10 066 9290	12209H6B900	Yp R X- Max	125	06-12	10 066 9300	5YPE21190000
Hd Evo I Eu3	200	10-12	10 066 9290	12209H6B900	Yp R X- Max	125	12-13	10 066 9300	5YPE21190000
Hd Evo I Tamburo Eu3	200	08-09	10 066 9290	12209H6B900	Yp R X- Max Abs	125	11	10 066 9300	5YPE21190000
Hd2 I	200	11	10 066 9290	12209H6B900	Yp Ra X- Max Abs	125	13	10 066 9300	5YPE21190000
Hd2 I	200	14	10 066 9290	12209H6B900	Yzf- R	125	08-13	10 066 9300	5YPE21190000
Joyride	200	03	10 066 9290	12209H6B900	Hw Xenter	150	12	10 066 9250	52SE21190000
Joyride Eu2	200	03-04	10 066 9290	12209H6B900	Xn Teo' S	150	01-02	10 066 9300	4TE121190000
Joyride Eu2	200	05-06	10 066 9290	12209H6B900	Xq Maxster	150	01-02	10 066 9300	4TE121190000
Joyride Evo I	200	09	10 066 9290	12209H6B900	Yp Majesty	150	00-02	10 066 9300	4TE121190000
Joyride Evo I	200	13	10 066 9290	12209H6B900	Yp E Majesty	180	03-06	10 066 9300	4TE121190000
Joyride I Eu3	200	07-09	10 066 9290	12209H6B900	Tw	200	94-94	10 066 9220	5H0121190000
Joyride I Evo	200	10	10 066 9290	12209H6B900	Vp X- City	250	07-13	10 066 9220	5H0121190000
Gts	250	07-08	10 066 9290	12209H6B900	Wr F	250	01-11	10 066 9320	4TV121190000
Gts	250	07-08	10 066 9290	12209H6B900	Wr R	250	08	10 066 9300	4TE121190000
Joymax	250	05-07	10 066 9290	12209H6B900	Wr R	250	13	10 066 9300	4TE121190000
Joymax Eu3 I	250	07-08	10 066 9290	12209H6B900	Wr X	250	08	10 066 9300	4TE121190000
Quad Lander	250	06-07	10 066 9290	12209H6B900	Xg Tricker	250	05	10 066 9220	5H0121190000
Sb Ni	250	12	10 066 9290	12209H6B900	Ybr	250	07-11	10 066 9220	5H0121190000
Citycom	300	08-09	10 066 9290	12209H6B900	Yp Majesty	250	96-98	10 066 9220	5H0121190000
Citycom Efi	300	10-11	10 066 9290	12209H6B900	Yp Majesty	250	00-03	10 066 9220	5H0121190000
Citycom I Cbs	300	12	10 066 9290	12209H6B900	Yp Majesty Abs	250	03	10 066 9220	5H0121190000
Joymax Evo	300	09	10 066 9290	12209H6B900	Yp Majesty Dx	250	98-99	10 066 9220	5H0121190000
Joymax Evo I	300	10	10 066 9290	12209H6B900	Yp R Black X- Max	250	09	10 066 9220	5H0121190000
Joymax I	300	12	10 066 9290	12209H6B900	Yp R X- Max	250	05-12	10 066 9220	5H0121190000
Joymax I	300	14	10 066 9290	12209H6B900	Yp R X- Max	250	12-14	10 066 9220	5H0121190000
Joymax I Abs	300	13-14	10 066 9290	12209H6B900	Yp R X- Max Sport	250	11-12	10 066 9220	5H0121190000
Quad Lander	300	08	10 066 9290	12209H6B900	Yp Ra X- Max Abs	250	12-14	10 066 9220	5H0121190000
Quad Lander S	300	07-08	10 066 9290	12209H6B900	Yz F	250	01-14	10 066 9300	4TE121190000
Maxsym I	400	11-12	10 066 9290	12209H6B900	Xc Versity	300	03-06	10 066 9220	5H0121190000
Maxsym I Abs	400	12	10 066 9290	12209H6B900	Yp Majesty	400	07-11	10 066 9310	3P6121290000
Quad Raider	600	08	10 066 9290	12209H6B900	Yp Majesty Abs	400	07-11	10 066 9310	3P6121290000
YAMAHA					Yp X- Max	400	13-14	10 066 9310	3P6121290000
Xf Gi Ggle	50	08	10 066 9270	5STE21190000	Yp Ra X- Max Abs	400	14	10 066 9310	3P6121290000
Yn F Neo' S 4	50	09-12	10 066 9270	5STE21190000	Xp T-Max	500	01-11	10 066 9320	4TV121190000
Yn F Neo' S 4	50	12-14	10 066 9270	5STE21190000	Xp T-Max Abs	500	05-11	10 066 9320	4TV121190000
Hw Xenter	125	12	10 066 9250	52SE21190000	Xp T-Max Abs Sv	500	11	10 066 9320	4TV121190000
Sr	125	99-00	10 066 9220	5H0121190000	Xp T-Max Black Max	500	06	10 066 9320	4TV121190000
Tw	125	99-01	10 066 9220	5H0121190000	Xp T-Max Black Max-Night Max	500	07	10 066 9320	4TV121190000
					Xp T-Max Sv	500	11	10 066 9320	4TV121190000



MODELLO - MODEL	Cc	ANNI YEARS	CODICE RMS RMS CODE	RIF. ORIGINALE OEM NUMBER	MODELLO - MODEL	Cc	ANNI YEARS	CODICE RMS RMS CODE	RIF. ORIGINALE OEM NUMBER
Xp T-Max White Max	500	10	10 066 9320	4TV121190000	Yzf R1 (Scarico - Exhaust)	1000	11	10 066 9300	4TE121190000
Xp T-Max	530	12-14	10 066 9320	4TV121190000	Yzf R1 (Aspirazione - Intake)	1000	11	10 066 9310	3P6121290000
Xp T-Max Abs	530	12-14	10 066 9320	4TV121190000	Yzf R1 (Scarico - Exhaust)	1000	12	10 066 9300	4TE121190000
Fz6	600	04-07	10 066 9320	4TV121190000	Yzf R1 (Aspirazione - Intake)	1000	12	10 066 9310	3P6121290000
Fz6 Fazer	600	04-07	10 066 9320	4TV121190000	Yzf R1 (Scarico - Exhaust)	1000	13-14	10 066 9300	4TE121190000
Fz6 Fazer Abs	600	06-07	10 066 9320	4TV121190000	Yzf R1 (Aspirazione - Intake)	1000	13-14	10 066 9310	3P6121290000
Fz6 Fazer S2	600	07-08	10 066 9320	4TV121190000	Yzf-R1 Sp	1000	06	10 066 9320	4TV121190000
Fz6 Fazer S2 Abs	600	08	10 066 9320	4TV121190000	Fjr A Abs	1300	06-08	10 066 9310	3P6121290000
Fz6 Ns	600	05-06	10 066 9320	4TV121190000	Fjr A Abs	1300	10-11	10 066 9310	3P6121290000
Fz6 S2	600	07-08	10 066 9320	4TV121190000	Fjr A Abs	1300	13-14	10 066 9310	3P6121290000
Fzr R	600	94-95	10 066 9320	4TV121190000	Fjr Ae	1300	14	10 066 9310	3P6121290000
Fzs Fazer	600	98-99	10 066 9320	4TV121190000	Fjr As	1300	06-08	10 066 9310	3P6121290000
Fzs Fazer	600	02-03	10 066 9320	4TV121190000	Xvs Cu Custom	1300	14	10 066 9220	5H0121190000
Fzs Fazer (Fzs S)	600	00-01	10 066 9320	4TV121190000	V- Max	1700	09-12	10 066 9310	3P6121290000
Xj6-F Diversion	600	10-11	10 066 9320	4TV121190000					
Xj6-Fa Diversion Abs	600	11	10 066 9320	4TV121190000					
Xj6-N	600	09-11	10 066 9320	4TV121190000					
Xj6-N	600	13	10 066 9320	4TV121190000					
Xj6-N Sp	600	13	10 066 9320	4TV121190000					
Xj6-Na Abs	600	13	10 066 9320	4TV121190000					
Xj6-S Diversion	600	09-11	10 066 9320	4TV121190000					
Xj6-S Diversion	600	13	10 066 9320	4TV121190000					
Yzf R Thunder Cat	600	96-99	10 066 9320	4TV121190000					
Yzf R Thunder Cat	600	00-02	10 066 9320	4TV121190000					
Yzf R46	600	05	10 066 9320	4TV121190000					
Yzf R6	600	99-05	10 066 9320	4TV121190000					
Mt- 03	660	06-11	10 066 9220	5H0121190000					
Szr	660	95-97	10 066 9220	5H0121190000					
Xt R	660	04-11	10 066 9220	5H0121190000					
Xt R	660	14	10 066 9220	5H0121190000					
Xt X	660	04-11	10 066 9220	5H0121190000					
Xt X	660	14	10 066 9220	5H0121190000					
Xt Z Tenere	660	91-96	10 066 9220	5H0121190000					
Xt Z Tenere	660	08-13	10 066 9220	5H0121190000					
Mt- 07	700	14	10 066 9300	4TE121190000					
Mt- 09	850	14	10 066 9300	4TE121190000					
Xv	950	14	10 066 9220	5H0121190000					
Xv Abs	950	14	10 066 9220	5H0121190000					
Xv R Abs	950	14	10 066 9220	5H0121190000					
Fz1	1000	06-09	10 066 9320	4TV121190000					
Fz1 Fazer	1000	06-12	10 066 9320	4TV121190000					
Fz1 Fazer Abs	1000	11-12	10 066 9320	4TV121190000					
Fz1-N	1000	11	10 066 9320	4TV121190000					
Fz1-Na	1000	10-11	10 066 9320	4TV121190000					
Fzs Fazer	1000	01-05	10 066 9320	4TV121190000					
Yzf R1	1000	98-06	10 066 9320	4TV121190000					
Yzf R1	1000	07-08	10 066 9310	3P6121290000					
Yzf R1 (Scarico-Exhaust)	1000	09	10 066 9300	4TE121190000					
Yzf R1 (Aspirazione - Intake)	1000	09	10 066 9310	3P6121290000					
Yzf R1 (Scarico - Exhaust)	1000	10	10 066 9300	4TE121190000					
Yzf R1 (Aspirazione - Intake)	1000	10	10 066 9310	3P6121290000					



PATTINI CATENA DISTRIBUZIONE

TIMING CHAIN GUIDES

16 371 4010



KIT PATTINI CATENA DISTRIBUZIONE TIMING CHAIN GUIDES KIT

KYMCO 125: B&w Eu2 03-04 • B&w 00 • Dink Eu3 06-07 • Dink 97-98 • Dink Classic Eu2 03 • Dink Classic 02 • Dink Lx 98-00 • Gran Dink Eu2 03-04 • Gran Dink 01-02 • **200:** Dink Classic 04 • Dink Eu3 I 06-07 • (R.O. 00123913-00123914)



16 371 4020



KIT PATTINI CATENA DISTRIBUZIONE TIMING CHAIN GUIDES KIT

KYMCO 125: Downtown I 09 • K-Xct I 12-14 • People Gti 10-14 • (R.O. 00114104-00114105)



16 371 4030



KIT PATTINI CATENA DISTRIBUZIONE TIMING CHAIN GUIDES KIT

KYMCO 200: Downtown I 10 • People Gti 10-14 • **300:** Downtown I 09 • Downtown Abs I 11 • Downtown Abs 10 • Downtown I 11 • K-Xct I Abs 14 • K-Xct I 12 • People Gti Abs 12-14 • People Gti 10-14 • **350:** Downtown I Abs 15 • **400:** X Citing I Abs 14-15 • X Citing I 13-15 (R.O. 00114090-00114091)



16 371 4040



KIT PATTINI CATENA DISTRIBUZIONE TIMING CHAIN GUIDES KIT

KYMCO 50: Agility 4T Carry 11 • Agility 4T R10 06-08 • Agility R12 07-08 • Agility R16 08-12 • Agility Plus 4T 14 • Agility R12 05 • Agility Rs 09 • Dink 4T 07 • Filly Lx 01-02 • Filly 98-00 • Like 4T 01-02 • People S 4T 06-08 • Sento 08 • Super 8 4T 09-13 • Super 8 07 • Vitality 4T 04 (R.O. 00103613-00103614)



16 371 4050



KIT PATTINI CATENA DISTRIBUZIONE TIMING CHAIN GUIDES KIT

KYMCO 250: B&w Eu2 03 • B&w 00 • Grand Dink Eu2 03-04 • Grand Dink 01-02 • Kxr 03-04 • Mxu 05 • People Lc 03-04 • People S I 07 • People S 06 • X Citing I 06-07 • X Citing 05 • Yup 03 (R.O. 00123911-00123917)



16 371 4060



KIT PATTINI CATENA DISTRIBUZIONE TIMING CHAIN GUIDES KIT

KYMCO 125: Agility 4T Eu3 06-08 • Agility 4T 06 • Agility Carry 11 • Agility Plus 14 • Agility R16 08-12 • Agility bRs 09 • Like Lx 12 • Like 09 • Movie Eu3 06-07 • Movie XL Eu2 03-04 • Movie XL 01 • Movie 99-00 • People Eu2 03 • People 99-00 • People Eu3 07-11 • People One I Dd 15 • People One I 13 • People S Dd Eu3 07-08 • People S 05 • Super 8 08-09 • Vivio 00 • **200:** Agility R16 08-09 • Movie Eu3 06-07 • Agility I R16 10 • Agility I Plus 14 • Agility R16 12 • Like I 09 • Like Lx 12 • People S I 07 • People S 05 - (R.O. 00123111-00123112)



16 371 4070



KIT PATTINI CATENA DISTRIBUZIONE TIMING CHAIN GUIDES KIT

KYMCO 500: X Citing R 09 • X Citing I R 07-08 • X Citing I 06-08 • X Citing 05 (R.O. 00123060-00122047)



16 371 4080



KIT PATTINI CATENA DISTRIBUZIONE TIMING CHAIN GUIDES KIT

KYMCO 300: G-Dink 12 • Maxxer 05-06 • Mxu R 10 • Mxu 05-06 • People S I 08 • X Citing I R 08-09 • X Citing I 08 (R.O. 00123095-00123096)





▶ GUARNIZIONI

GASKET SETS



RMS
YOUR BEST PARTNER



SERIE GUARNIZIONI MOTORE
ENGINE GASKET SETS

APRILIA

10 068 0011 

50: Amico 90-96



10 068 0041 

50: Ditech
(Iniezione e carburatore - *Injection and carburator*)



10 068 1200 

50: Mojito Custom 2T Motore Piaggio 04-10

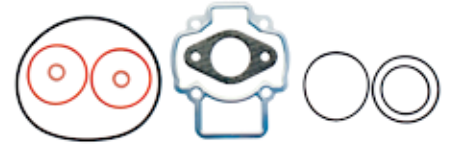

10 068 0050 

50: Rs moto

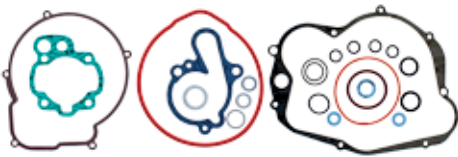

10 068 0071 

50: SR • Scarabeo • Rally • Gulliver



10 068 4200 

50: Scarabeo 4T 4V 10-14 • Scarabeo Quattro 09 •
Scarabeo 4T 4V Net 09-10 • Sr Motard 4T 4V 13-14



10 068 4260 

50: Scarabeo 4T 02-06 • 100: Scarabeo 4T 01-05

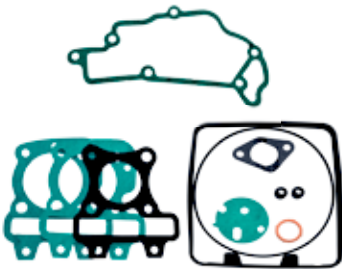

10 068 9180 

50: Scarabeo • Ditech 01-03

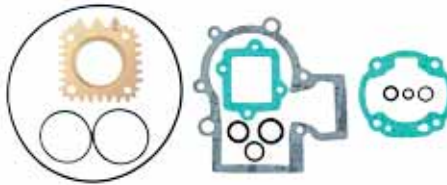

10 068 4220 

250: Sport City Cube 08-12
300: Atlantic 10-11 • Scarabeo Light 09-10 •
Sport City Street 11-14

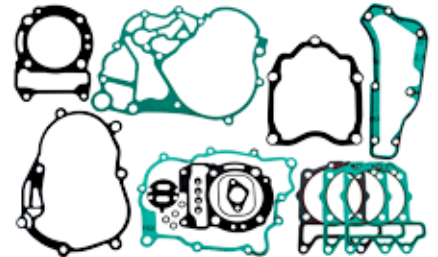

10 068 4230 

125: Atlantic 03-05 • Scarabeo 03-06

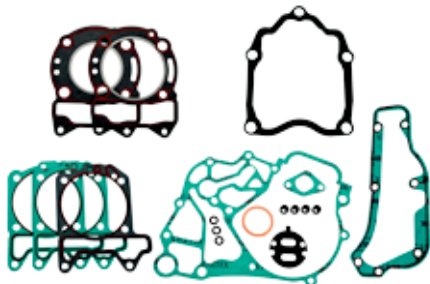

10 068 9191 

125: Leonardo 96-01



10 068 4240 

125: Mojito 03-07



10 068 4210 

125: Mojito 08 • Sport City One 4T Eu3 08-11 • Sr
Motard 12-14

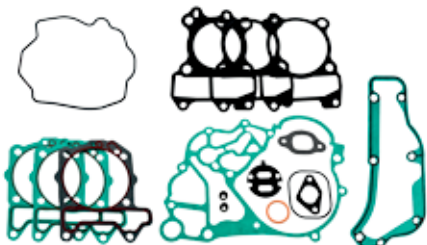

10 068 9000 

Motori Scooter Minarelli cilindro verticale raffr. aria
*Minarelli Scooter Engines with Air cooled Vertical
cylinder*



10 068 9010 

Motori Scooter Minarelli cilindro orizzontale raffr. aria
*Minarelli Scooter Engines with Air cooled hori-
zontal cylinder*





APRILIA

10 068 9020 

Motori Scooter Minarelli raffr. a liquido
Minarelli Scooter Engines with liquid cooled cylinder

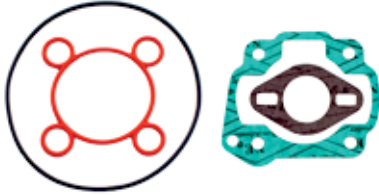

10 068 9160 

250: Leonardo 99-01



10 068 9170 

50: Sr Di Tech 00 00-03



10 068 9200 

150: Leonardo 96-01



10 068 9210 

125: Scarabeo Gt 99-02



10 068 9221 

150: Scarabeo 99-02



10 068 9410 

500: Atlantic 02-04 • Scarabeo 03-04



10 068 9550 

250: Atlantic Eu3 06-08
• Scarabeo Light 06-08

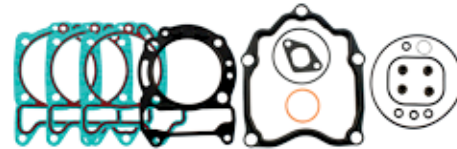

ATALA

10 068 0830 

50: Hacker



BENELLI

10 068 9160 

250: Velvet



BETA

10 068 9290 

125: Eikon 99-02



10 068 9300 

150: Eikon 99-02





SERIE GUARNIZIONI MOTORE
ENGINE GASKET SETS

DERBI

10 068 4260 

50-100: Atlantis 4T 04-06

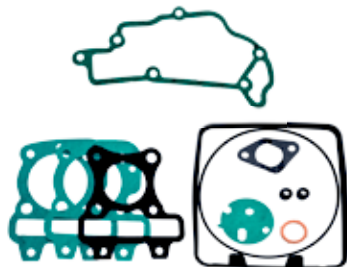

10 068 4240 

125-150: Boulevard 02-04



10 068 4210 

125: Boulevard 03-07 • Boulevard 4T Eu3 08-12
• Sonar 4T 09-11 • Variant Sport 4T Eu3 12
150: Boulevard 03-07 • Boulevard 4T Eu3 10
• Sonar 4T 09
200: Boulevard Eu2 05-06

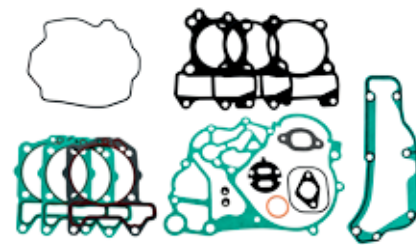

10 068 4230 

125: Gp1 06-08

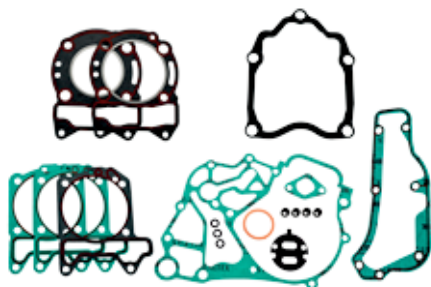

10 068 4220 

250: Gp1 06-08
300: Rambla 10-11

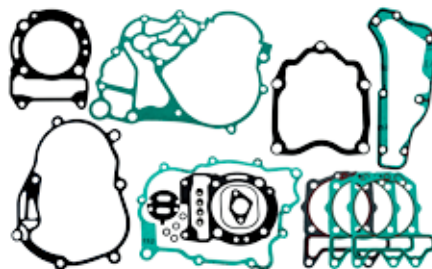

F. MORINI

10 068 0830 

50: AH L 94-95
(Raffreddato aria - Air cooled)



10 068 9370 

50: H2
(Carter Lungo - Long Crankcase)



GILERA

10 068 1200 

50: Typhoon • Storm • Easy moving



10 068 9040 

50: Motori raffr. ad aria - Air cooled Engines



10 068 9050 

50: Runner 97-00
Motori raffr. a liquido - Liquid cooled cylinder

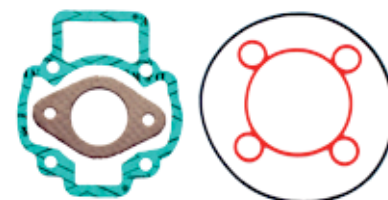



GILERA

10 068 9070 

50: Runner Poggiali • Runner FL 02
Motori raffr. a liquido - *Liquid cooled Engines*

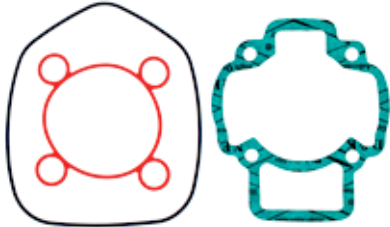

10 068 9480 

50: Runner Purejet 02-04

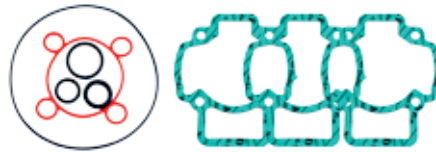

10 068 9400 

125: Dna 01 • Runner Vx • Race • Sc 00-07



10 068 9381 

180: Runner Sp Fxr 97-02

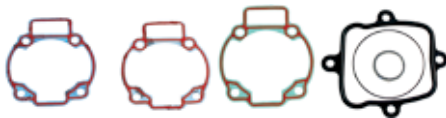

10 068 9390 

180: Dna 01 • Runner Vxr 00-01



HONDA

10 068 3500 

50: Vision 1° serie 85-87

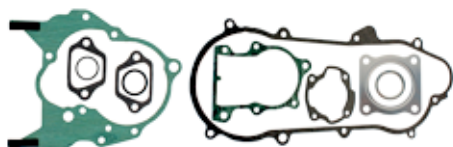

10 068 9060 

50: Sh 96> • Sfx • Sky • Balj
Motori raffr. ad aria - *Air cooled*



10 068 9230 

125: Pantheon 98-02



10 068 0450 

125: Sh • Chiocciola • Dylan 00-01



10 068 9080 

125: Sh • Chiocciola • Dylan 00-01



10 068 9830 

125: Pcx 10-15

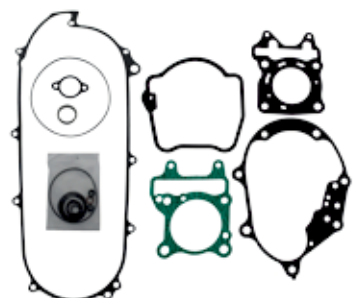



SERIE GUARNIZIONI MOTORE
ENGINE GASKET SETS

HONDA

10 068 9241 

150: Pantheon 98-01



10 068 9090 

150: Sh



10 068 0440 

150: Sh



10 068 9251 

250: Fes • Foresight 98-99



10 068 9260 

250: Jazz 01

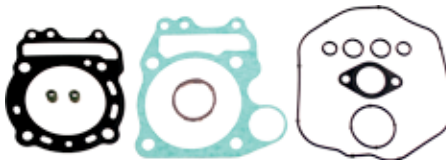

10 068 9561 

300: Sh 300

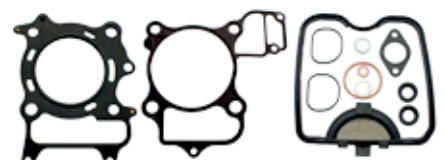

ITALJET

10 068 0830 

50: Formula



10 068 9381 

180: Dragster 99-00

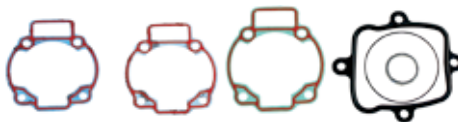

KYMCO

10 068 4270 

50: Agility 4T Carry 11 • Agility 4T R10 06-08 •
Agility 4T R16 08-12 • Agility Plus 4T 14 • Agility
R12 05 • Agility Rs 09 • Dink 4T 07 • Filly 98-00 •
Filly Rx 01-02 • Like 4T 09 • People S 4T 06-08 •
Sento 08 • Super 8 07-13 • Vitality 4T 04



10 068 0381 

50: Agility 4T Carry 11 • Agility 4T R10 06-08 •
Agility 4T R16 08-12 • Agility Plus 4T 14 • Agility
R12 05 • Agility Rs 09 • Dink 4T 07 • Filly 98-00 •
Filly Rx 01-02 • Like 4T 09 • People S 4T 06-08 •
Sento 08 • Super 8 07-13 • Vitality 4T 04



10 068 9680 

50: Agility R16 08-12





KYMCO

10 068 9270 

50: Dink
(Raffreddato aria - *Air cooled*)



10 068 9280 

50: Dink LC
(Raffreddato liquido - *Liquid cooled*)



10 068 0391 

125: Agility R16 08-12



10 068 9290 

125: Dink 97-98



10 068 9330 

125: People 99-00



10 068 9350 

125: B&W 00 • Dink Lx 98-00 • Dink Classic 02-03



10 068 9690 

125: Agility R16 08-12



10 068 9921 

125: People One E4 16 • People One I Dd 15 •
People One I 13

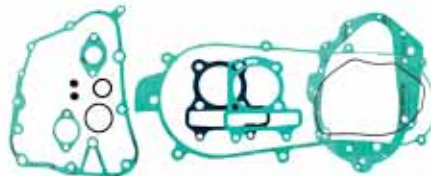

NEW

10 068 0401 

150: Agility R16 08-11



10 068 9300 

150: Dink 97-98



10 068 9340 

150: People 99-00



10 068 9360 

150: B&w 00 • Dink Classic 02-03 • Dink Lx 98-00



10 068 9700 

150: Agility R16 08-11



10 068 4290 

200: Downtown I 10 • People Gti 10-14
300: Downtown I 09-11 • K-Xct i 12-14 • People Gti
10-14



10 068 9710 

200: Agility R16 10-12





SERIE GUARNIZIONI MOTORE
ENGINE GASKET SETS

KYMCO

10 068 4280



250: B&w 00-03 • Gran Dink 01-04 • People Lc 03-04 • People S 06-07 • X Citing 05-07 • Yup 03 **300:** People S 08 • X Citing 08 • X Citing I R 08-09



10 068 9310



250: Grand Dink



10 068 9911



NEW

350: Downtown Abs E4 16
• Downtown I Abs 15



10 068 9901



NEW

400: X Citing Abs 14-15 • X Citing I 13-15



MALAGUTI

10 068 2500



50: F 10 Yesterday 92-95
(Raffreddato aria - *Air cooled*)



10 068 0070



50: F12 • F15 • Centro



10 068 9320



100: Ciak • F12 Phantom



10 068 9330



125: Ciak 00-01



10 068 9350



125: F18 Warrior 00-01

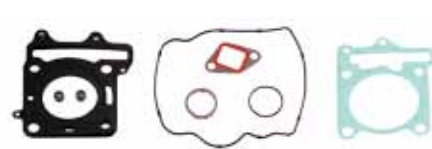

10 068 9140



125: Madison 99

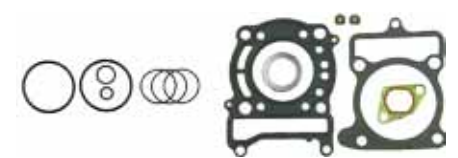

10 068 9340



150: Ciak 00-01



10 068 9360



150: F18 Warrior 00-01

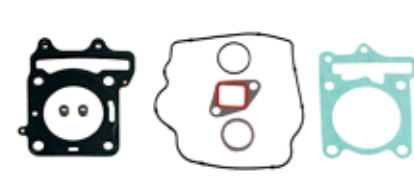

10 068 9160



250: Madison 99-01





MALAGUTI

10 068 9000 

Motori Scooter Minarelli cilindro verticale raffr. aria
Minarelli Scooter Engines with Air cooled Vertical cylinder



10 068 9010 

Motori Scooter Minarelli cilindro orizzontale raffr. aria
Minarelli Scooter Engines with Air cooled horizontal cylinder



10 068 9020 

Motori Scooter Minarelli raffr. a liquido
Minarelli Scooter Engines with liquid cooled cylinder

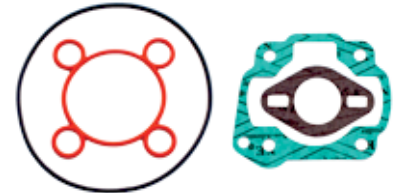

MBK

10 068 0011 

50: Booster 90-95



10 068 3000 

50: CT S Sorriso 90-93



10 068 2500 

50: Evolis 93-96



10 068 0071 

50: Nitro • Ovetto



10 068 9140 

125: Doodo 00-01 • Thunder • Skyliner 00-02



10 068 9160 

250: Skyliner 00-01



10 068 9151 

150: Doodo 01-02 • Xq Thunder 01-02 • Yp Skyliner 00-02



10 068 9531 

180: Yp E Skyliner 03



10 068 9470 

100: Yn Ovetto 00-02 • Yq Nitro 00-02 • Yw Booster 99-01

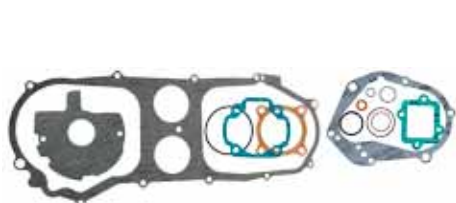

MINARELLI

10 068 0080 

50: Am6 II Serie - *New Model*



10 068 9630 

50: Am6 II Serie - *New Model*

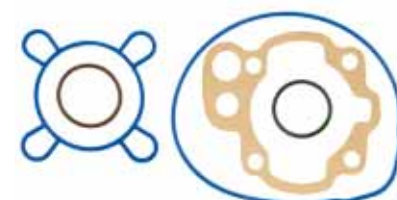

10 068 9670 

50: Motore Am6 50 cc.

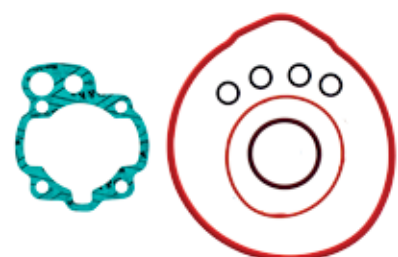



SERIE GUARNIZIONI MOTORE
ENGINE GASKET SETS

PEUGEOT

10 068 3500

50: ST • STL • STL2 Rapido • Rapido 3 85-93

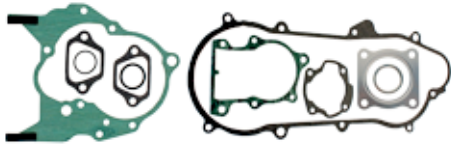

10 068 3520

50: Buxy • Speedake • Squab 94-95



10 068 9030

50: Buxy • Speedake • Squab 94-95



10 068 9420

100: Trekker • Sv • Elyseo



10 068 9430

125: Elyseo 99



10 068 9881

NEW

125: Tweet Pmx • Ap Es • Ap • N • Pro • V Pro • Vx • V • X
150: Tweet N • Vx • V • X

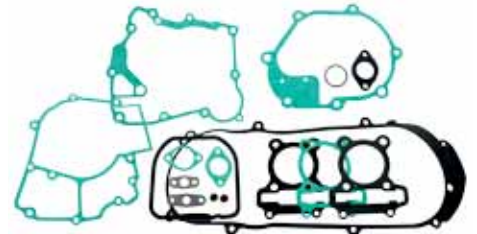

10 068 9891

NEW

125: Geo C • E • Epm • Es • Exn • Ex • Sc • S • X



10 068 9871

NEW

250: Geo Ev 20 • Ev • C • Sc • S • X • Es • Ex • Ex • E • Nx
300: Ev U • St • Xn • X • Sat2



PIAGGIO

10 068 4000

50: Ciao • Si • Bravo • Grillo • Boxer 70-93



10 068 4040

50-90-125: Vespa Primavera ET3-125
modello 66-84
(R.O. 091925)



10 068 4050

50: Vespa Pk XL Rush
(R.O. 154616)







PIAGGIO

10 068 6500 

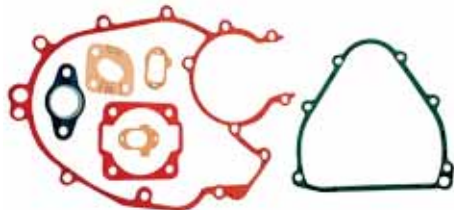
50: Ape TM 50 P



10 068 4021 

50: Nrg • Ntt 95-96



10 068 9050 

50: Nrg Extreme 99-00
Ntt 95-96 • Nrg 94-96
Nrg Rst Mc2 96-98 • Zip Sp 96-00
Motori raffr. a liquido - *Liquid cooled cylinder*
(Conf. 5 pz. - Pack 5 pcs)

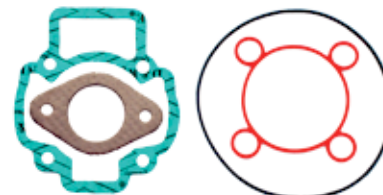

10 068 9480 

50: Nrg Purejet 02-04

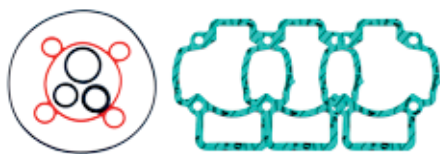

10 068 9070 

50: Nrg Mc3 01-02 • Zip Sp 01-02
Motori raffr. a liquido - *Liquid cooled Engines*
(Conf. 5 pz. - Pack 5 pcs)

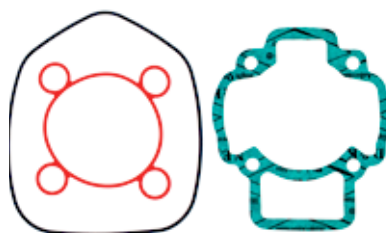

10 068 1200 

50: Diesis 01 • Free Delivery 00-01 • Free FL 95-02 • Free 92-94 • Nrg extreme 99-00 • Nrg Mc3 01-04 • Nrg power Dt 06-11 • Sfera Maquillage 2 94 • Sfera Rst 95-97 • Sfera 91-93 • Typhoon 01-08 • Vespa Et2 97-05 • Vespa Lx 2T 09-13 • Zip Fast Raider Rst 96-97 • Zip Fast Raider 93-94 • Zip Rst 96-99 • Zip 92-04
80: Skr City



10 068 9040 

50: Motori raffr. ad aria - *Air cooled Engines*
(Conf. 5 pz. - Pack 5 pcs)



10 068 9101 

50: Fly 4T 2V 25-30 Km/h 12 • Fly 4T 05-07 • Liberty 4T Delivery • Single 10-12 • Liberty 4T Delivery Tnt 09 • Liberty 4T Ptt (Deu) 07-12 • Liberty 4T Ptt • Double 09-12 • Liberty 4T Rst 04 • Liberty 4T Sport 07-08 • Liberty 4T 00-08 • Liberty Moc 4T & Elle 09-13 • Vespa Et4 00-05 • Vespa Lx 4T 05-08 • Zip 4T 00-13



10 068 4260 

50: Liberty 4T 00-02 • Liberty 4T Rst 04 • Vespa Et4 00-05 • Zip 4T 00-05
100: Free 00-02

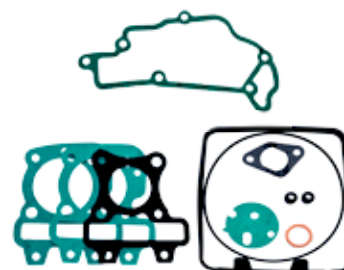

10 068 4200 

50: Fly 4T 4V 12-13 • Vespa Lx 4T 4V 09-13 • Vespa Primavera 4T 4V 13-15 • Vespa S 4T 4V 08-12 • Vespa Sprint 4T 4V 14



10 068 9941 

50: Liberty lget 4T 3V le 15



10 068 4070 

125: Vespa T5 85-89
(Confezione 5 pezzi - 5 pcs pack)
(R.O. 154699)





SERIE GUARNIZIONI MOTORE
ENGINE GASKET SETS

PIAGGIO

10 068 4090 

125-150: Vespa Px • Vespa Pxe Arcobaleno Sprint 3° serie 78-93
(R.O. 154563)



10 068 4130 

125-150: Vespa 1961
(R.O. 86684)



10 068 4140 

125-150: Vespa VNB1T-VNB2T
(R.O. 86686)



10 068 4160 

125: Vespa Granturismo VNL2T



10 068 4180 

125-150: Vespa Super VBC1T
(R.O. 91991)



10 068 4080 

150: Vespa GL Sprint
(R.O. 091730)



10 068 4170 

150: Vespa Sprint VLB-VLA



10 068 4190 

150: Vespa Super GTR



10 068 4150 

160: Vespa GS VSB1T



10 068 4110 

125-150: Cosa CL-CLX 88-91 • Cosa 2 91-97 • Vespa Pxe Arcob. 81-97 • Vespa PX 98-01
(Con Miscelatore - *With mixer*)
(R.O. 154546)



10 068 4120 

200: Cosa 88-91 • Cosa 2 91-97 • Vespa Pxe Arcobaleno 81-97 • Vespa Px 98-01
(Con Miscelatore - *With mixer*)



10 068 4100 

200: Vespa PE • Vespa PX Arcobaleno Rally 84-93
(R.O. 154547)





PIAGGIO

10 068 6530 

220: Ape MP P501 - P601



10 068 6540 

220: Ape TM 602 - TM 703



10 068 6520 

420: Ape MP

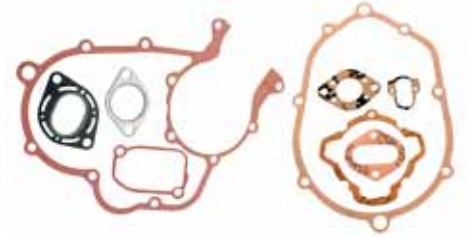

10 068 9381 

180: Hexagon Lxt 97-99



10 068 9390 

180: Super Hexagon Gtx 00-02 • X9 Amalfi 00-03

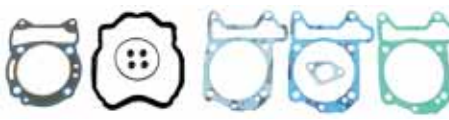

10 068 9110 

125-150: Liberty

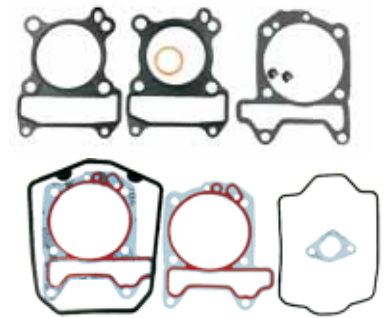

10 068 4031 

125-150: Hexagon 94-96

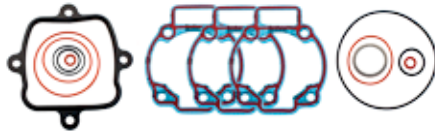

10 068 9780 

125: Hexagon Lx4 98-99 • Liberty 98-00 • Sfera 95-97 • Vespa Et4 96-98

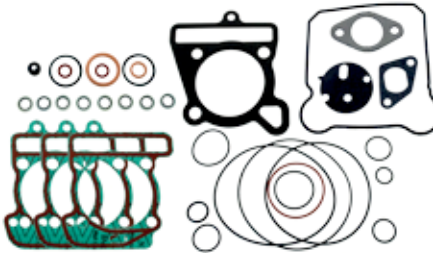

10 068 9490 

125-200: Beverly 01-02



10 068 9400 

125: Super Hexagon Gtx 00-02 • X9 01-02



10 068 4240 

125: Beverly 01-05 • Fly Eu3 07 • Liberty 01-05 • Skipper 4T 00-02 • Super Hexagon Gtx 12 01-02 • Vespa Et4 99-02 • Vespa Gran Turismo 03-05 • X8 04-06 • X9 Evolution 03 • X9 01-02 • Zip 00-02 • X9 Amalfi 00-03
200: Liberty Rst 04 • X9 Evolution 03 • X9 02-03 • Carnaby 07-08 • Vespa Gran Turismo 06-07 • X8 05-07



10 068 4230 

125: Beverly Rst 04-07 • Vespa Gran Turismo 03-07 • Vespa Gtv 06-08 • X8 04-06 • X8 Premium Eu2 06 • X9 Evolution 03-06
200: Vespa Gran Turismo 06-07 • X8 05-07 • X9 02-03 • X9 Evolution 03

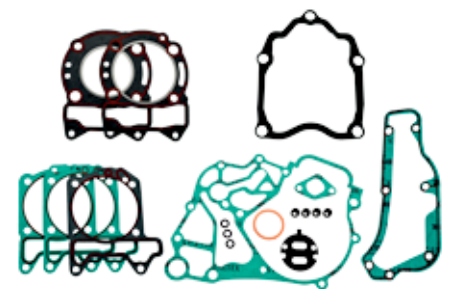



SERIE GUARNIZIONI MOTORE
ENGINE GASKET SETS

PIAGGIO

10 068 4210

125: Fly 05-07 • Fly Eu3 07-11 • Liberty 4T 01-11 • Liberty 4T Eu3 06-15 • Liberty 4T 2V 09-12 • Skipper 4T 00-02 • Typhoon 4T 2V Eu3 10-11 • Vespa Et4 99-02 • Vespa Lx 05-11 • Vespa Lxv 06-13 • Vespa S 07-11 • X8 Street Eu2 06-07 • Zip 00-02
150: Fly 05-08 • Liberty 4T Eu3 08-13 • Vespa Lx 09-12 • Vespa S 4T 09-12 • X8 Street Eu2 06-08
200: Liberty 4T 06-08 • Liberty Rst 04 • Liberty Sport 06 • Liberty 06

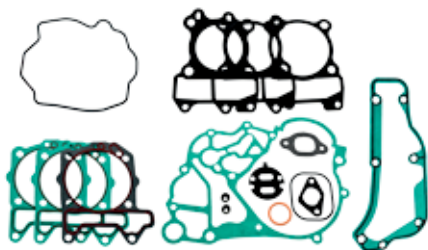

10 068 4250

125: Fly 4T 3V le 12-15 • Liberty 4T 3V le 13-14 • Vespa 946 4T 3V 13-14 • Vespa Lx 4T 4V 12-13 • Vespa Lx Primavera 4T 3V 13-14 • Vespa S 4T 3V 12 • Vespa Sprint 4T 3V 14-15
150: Liberty 4T 3V 13-14 • Vespa Gts Super le 4T 3V 14-15 • Vespa Lt 4T 3V 14 • Vespa Lx 4T 3V le 12-13 • Vespa Primavera 4T 3V 13-14 • Vespa Sprint 4T 3V le 15

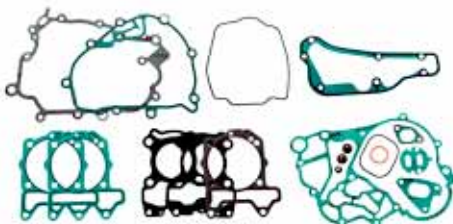

10 068 9951 **NEW**

125: Liberty Iget 4T 3V le 15 • Vespa 946 4T 3V Abs Armani 15 • Vespa 946 4T 3V Abs 13-15 • Vespa Sprint 4T 3V le 14-15
150: Liberty Iget 4T 3V le 15 • Vespa Gts Super le 4T 3V Au,Ex,Jp,Ri,T,V 14-15 • Vespa Lt 4T 3V le 14 • Vespa Primavera 4T 3V 13-15 • Vespa Sprint 4T 3V le 15

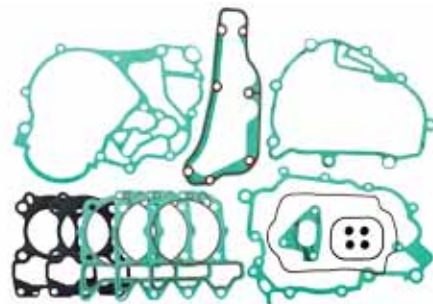

10 068 4220

250: Beverly 04-09 • Carnaby 08 • Mp3 06-09 • Vespa Gts 05-14 • Vespa Gtv 07-09 • X Evo 07-13 • X7 Eu3 08 • X8 Eu3 05-08 • X9 Evolution 04-06
300: Beverly Rst 10-15 • Beverly Tourer Eu3 09-10 • Carnaby Cruiser 09-12 • Mp3 10-14 • Mp3 You-urban 11-15 • Vespa Gts 08-15 • Vespa Gtv 10-13 • X7 Evo Eu3 09-10

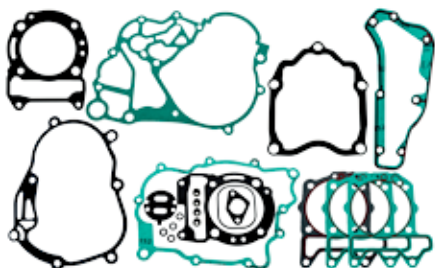

10 068 9550

250: Beverly Cruiser 07-09 • Beverly le Eu3 06-08 • Beverly 06-07 • Beverly Rst 04-05 • Beverly Sport 06-08 • Beverly Tourer Eu3 08-09 • Carnaby 08 • Mp3 Lt 08-09 • Mp3 Mic 08-09 • Mp3 06-08 • Vespa Gt 60 Eu3 06-07 • Vespa Gts 05-13 • Vespa Gtv 4T Navy Eu3 07 • Vespa Gtv 06-09 • Vespa Gts Abs 05-12 • X Evo 07-13 • X7 Eu3 08 • X8 Eu3 05-08 • X9 Evolution 04-08

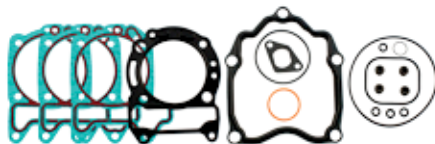

10 068 9931 **NEW**

PIAGGIO 350: Beverly 4T 4V le Eu3 Sport Touring 11-14 • X10 4T 4V le Eu3 12-13



10 068 9410

500: X9 01-02



10 068 9500

500: Beverly 02-03





SUZUKI

10 068 0830 

50: Motore F. Morini



10 068 0060 

50: Katana 50 Lc 97-00 • Ux Zillion 99 • Ay 01-04



10 068 9120 

250: Burgman 98-02



10 068 9440 

150: Burgman



10 068 9450 

250: Burgman 03-06



10 068 9130 

400: Burgman 99-02



10 068 9460 

400: Burgman 03-06

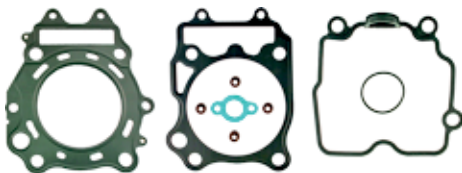

YAMAHA

10 068 0011 

50: Bw's 90-93



10 068 3000 

50: Ct



10 068 2500 

50: Cy (3YE1) Jog 90-99



10 068 0071 

50: Motore Ma-My 50
Raffreddato aria e liquido (Cilindro orizzontale)
Air and liquid cooled (Horizontal cylinder)



10 068 9820 

50: Neo'S 4T 08-15



10 068 9000 

50: Motori Scooter Minarelli cilindro verticale raffr. aria
Minarelli Scooter Engines with Air cooled Vertical cylinder





SERIE GUARNIZIONI MOTORE
ENGINE GASKET SETS

YAMAHA

10 068 9010 

50: Motori Scooter Minarelli cilindro orizzontale raffr. aria
Minarelli Scooter Engines with Air cooled horizontal cylinder



10 068 9020 

50: Motori Scooter Minarelli raffr. a liquido
Minarelli Scooter Engines with liquid cooled cylinder

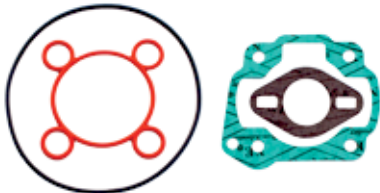

10 068 9470 

100: Bw's • Aerox • Neo's

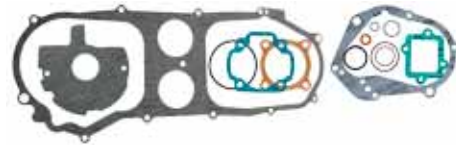

10 068 9140 

125: Teo's • Maxter 01 • Majesty 98-01



10 068 9810 

125: X-Max 06-13



10 068 9851 

NEW

YAMAHA 125: Hw Xenter 12-16
• Xc R Majesty S 14
150: Hw Xenter 12-16



10 068 9151 

150: Majesty



10 068 9531 

180: Majesty 03-05



10 068 9160 

250: Majesty 96-01 • X City 07-08 • X Max 05-09
• Majesty 96-03 • Dx 98-00 • Abs 03



10 068 9540 

250: X City 09>



10 068 9800 

300: Versity 03-06



10 068 9790 

400: Majesty 04-06

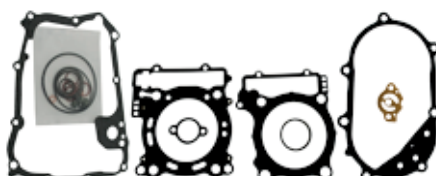

10 068 9861 

NEW

YAMAHA 400: Yp Majesty Abs 07-11 • Yp Majesty 04-11 • Yp R X-Max Momodesign 14
• Yp R X-Max 13-16 • Yp Ra X-Max Abs 14-16
• Yp Ra X-Max Ironmax Abs 16 • Yp Ra X-Max Momodesign Abs 14

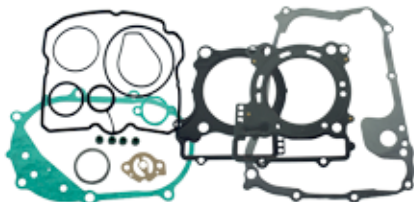

10 068 9520 

500: T-Max 01-11

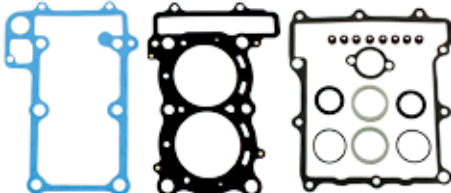

10 068 4300 

530: Xp T-Max Abs 12-15 • Xp T-Max Sp Abs 15
• Xp T-Max Sp 15 • Xp T-Max 12-15
(R.O. 59C114000000)

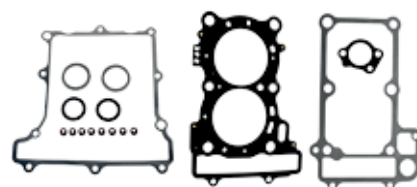

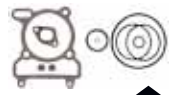

KIT GUARNIZIONI CILINDRI RMS RACING - RMS BIG BORE CYLINDER GASKET KIT

10 068 9600 

Serie guarnizioni Piaggio aria Ø 47
Gasket set Ø 47 for Piaggio air cooled
GILERA 50: Easy Moving 95-96 • Stalker 97-04
Storm 94-95 • Typhoon 94-97
PIAGGIO 50: Free 92-94 • Free FL 95-02
Liberty 97-05 • Sfera 91-93 • Sfera Rst 95-97
Zip 92-93 • Zip Fast Raider Rst 96-97
Per cilindro 10 008 0240
For cylinder 10 008 0240



10 068 9720 

Serie guarnizioni per cilindro Piaggio raffr. aria
Ø 47 mm
Gasket sets for Piaggio air cooled Ø 47 mm
Per cilindro 10 008 0480
For cylinder 10 008 0480



10 068 9730 

Serie guarnizioni Minarelli Oriz. Ø 47 mm
Gasket sets for Minarelli Horizontal Ø 47 mm
Per cilindro 10 008 0490
For cylinder 10 008 0490

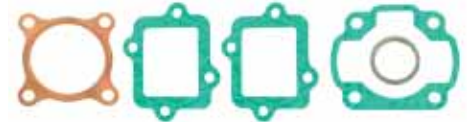

10 068 9740 

Serie guarnizioni per cilindro Minarelli Vert. Ø 47 mm
Gasket sets for Minarelli vertical Ø 47 mm
Per cilindro 10 008 0500
For cylinder 10 008 0500



10 068 9750 

Serie guarnizioni per cilindro Minarelli liquido
Ø 47 mm
Gasket sets for Minarelli liquid cooled Ø 47 mm
Per cilindro 10 008 0510
For cylinder 10 008 0510



10 068 9760 

Serie guarnizioni Piaggio liquido modelli fino
al 2000 Ø 47 mm
Gasket set Piaggio liquid cooled Ø 47 < 2000
Per cilindro 10 008 0560
For cylinder 10 008 0560

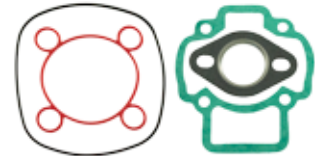

10 068 9770 

Serie guarnizioni Piaggio liquido modelli dal
2001 Ø 47 mm
Gasket set Piaggio liquid cooled Ø 47 > 2000
Per cilindro 10 008 0570
For cylinder 10 008 0570

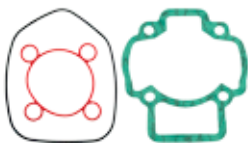

10 068 9840 

Serie Guarnizioni Cilindro
Cylinder Gasket Set
Per cilindro 10 008 0610
For cylinder 10 008 0610



10 068 0461 

NEW

SERIE GUARNIZIONI MOTORE
ENGINE GASKET SETS

Solo per Cilindro 10 008 0621
(Maggiorazione X-Max da 125 a 150 cc)





GUARNIZIONI VARIE
VARIOUS GASKETS

GUARNIZIONI BASE CILINDRO - BOTTOM CYLINDER GASKET

10 070 2010 

APRILIA 50: Amico
MBK: Booster 90-95
(Conf. 5 pz. - Pack 5 pcs)



10 070 2020 

MOTORI MINARELLI: CY, MY 50
Raffr. aria - *Air cooled*
APRILIA: Sr • Scarabeo • Rally • Gulliver
MBK 50: Evolis • (Conf. 5 pz. - Pack 5 pcs)



10 070 2030 

MOTORI MINARELLI: MA 50
Raffr. acqua - *Liquid cooled*
APRILIA 50: Sr LC
MALAGUTI 50: Phantom LC
(Conf. 5 pz. - Pack 5 pcs)



10 070 2300 

GILERA 50: Typhoon • Storm
PIAGGIO: Sfera • Zip • Free 91-96
(Conf. 5 pz. - Pack 5 pcs)



10 070 3030 

PIAGGIO 50-90-125: Vespa • Primavera ET3
Ape 50 • TM 50 • P 50
(Conf. 5 pz. - Pack 5 pcs)



10 070 3050 

PIAGGIO 50: Quartz • Nrg 95-96
Spessore 0,5 mm - Thickness 0,5 mm
(Conf. 5 pz. - Pack 5 pcs)



10 070 4010 

PIAGGIO 200: Vespa Px • Pxe • Cosa Vsr1t
(R.O. 191695)
(Conf. 5 pz. - Pack 5 pcs)



10 070 3080 

PIAGGIO: Ape MP Car • MPV • TM 602 • 703
(Conf. 5 pz. - Pack 5 pcs)



10 070 3090 

PIAGGIO 125: Vespa Pk XL Vmx6t
(R.O.826911)
(Conf. 5 pz. - Pack 5 pcs)



10 070 4000 

PIAGGIO 125-150: Vespa Px • Vnx-Vlx
Vespa Pxe • Vnx2-Vlx2 • Cosa Vlr1T
(Conf. 5 pz. - Pack 5 pcs)



10 070 4020 

NEW

PIAGGIO 150: Vespa GL•Sprint•Sprint
Veloce•VLA-VLB-VBC
(R.O. 89120)
(Conf. 5 pz. - Pack 5 pcs)





GUARNIZIONE SCARICO - EXHAUST GASKET

10 070 4500 

APRILIA 50: Amico • SR • Scarabeo • Rally • Gulliver

MBK 50: Booster • Evolis 90-95
(Conf. 5 pz. - Pack 5 pcs)



10 070 4510 

APRILIA: SR • Scarabeo (a Flangia - Flange).
(Conf. 5 pz. - Pack 5 pcs)



10 070 4520 

APRILIA 50: SR LC
MOTORI FRANCO M. 50: AH L
ITALJET: Formula
MALAGUTI 50: Crosser • Phantom LC Raffr.
Acqua - Liquid cooled
SUZUKI 50: 94-95
(Conf. 5 pz. - Pack 5 pcs)



10 070 5010 

KYMCYO 50: Dji
PEUGEOT 50: Buxy • Speedake • Squab • SV
Geo • Zenith

HONDA 50: Pk Wallaroo • GP • SP • HSS
• Dio • SK • SA • SJ Bali 94-95
(Conf. 5 pz. - Pack 5 pcs)



10 070 5100 

PIAGGIO 50: Vespa • PK XL • Rush
Ø 6
(Conf. 5 pz. - Pack 5 pcs)



10 070 5111 

PIAGGIO 50-125: Vespa • Primavera ET3
50: PK • Ape • TM • P
Ø 8
(Conf. 5 pz. - Pack 5 pcs)



10 070 5120 

PIAGGIO 125: Vespa Pk XL
(Conf. 5 pz. - Pack 5 pcs)



10 070 5130 

PIAGGIO: Sfera • Free • Zip • Fast Rider 91-93
(Conf. 5 pz. - Pack 5 pcs)



10 070 5140 

PIAGGIO: Nrg • Ntt • Quartz
GILERA: Typhoon 91-93
(Conf. 5 pz. - Pack 5 pcs)



10 070 5150 

PIAGGIO: Zip • Quartz
GILERA: Typhoon • Storm 91-93
(Conf. 5 pz. - Pack 5 pcs)



10 070 5320 

PIAGGIO: Ape Car • TM.
(Conf. 5 pz. - Pack 5 pcs)





GUARNIZIONI VARIE
VARIOUS GASKETS

GUARNIZIONI VARIE - VARIOUS GASKET

10 070 1010



GUARNIZIONE TESTA MOTORE
CYLINDER HEAD GASKET

APRILIA: Amico - **MBK:** Booster
YAMAHA 50: Ct • Cr Z 90-95
(Conf. 5 pz. - Pack 5 pcs)



10 070 1020



GUARNIZIONE TESTA MOTORE
CYLINDER HEAD GASKET

MOTORI MINARELLI 50: Cy • My 93-95
Raffr. aria • *Air cooled*
APRILIA: SR • Scarabeo • Rally • Gulliver
YAMAHA 50: CY • MY • CH 50 Beluga
MBK 50: Evolis -
(Conf. 5 pz. - Pack 5 pcs)



10 070 3970



GUARNIZIONE FILTRO
GASKET FILTER

PIAGGIO 50-90: Vespa
V5A1-V5B1-V5B2-V5SA1-V9A1
(R.O. 79900)
(Conf. 5 pz. - Pack 5 pcs)



10 070 3980



GUARNIZIONE PRESELETTORE CAMBIO
GASKET GEAR SELECTOR

PIAGGIO 125-150-200: Vespa Px
150: Pxe T5 GL • Sprint • Super • Rally
VNX - VLX - VBX - VNX5T - VNX2 - VLX2 - VSX1 -
VLA - VLB - VBC
(Conf. 5 pz. - Pack 5 pcs)
(R.O. 47162)



10 070 5160



GUARNIZIONE SILENZIATORE
SILENCER GASKET

PIAGGIO 125-180-200-250-300:
Motori 4T - *Four Stroke Engine*
(R.O. 8263885)



10 070 5610



GUARNIZIONE COPERCHIO CARTER FRIZIONE
CLUTCH COVER GASKET

APRILIA 50: SR • Scarabeo • Rally • Gulliver • Sr Lc
MALAGUTI: F 12 • Phantom Lc Raffr. acqua
Motori Minarelli: My 50 Raffr. aria
• Ma Raffr. Acqua 93-95
(Conf. 5 pz. - Pack 5 pcs)



10 070 6200



GUARNIZIONE COPERCHIO CARTER FRIZIONE
CLUTCH COVER GASKET

PIAGGIO 50: Ape • Tm • P
50-90-125: Vespa
50-125: Primavera Et3 Pk
(Conf. 5 pz. - Pack 5 pcs)



10 070 6500



GUARNIZIONE COPERCHIO CARTER
TRASMISSIONE
TRANSMISSION COVER

APRILIA 50: Amico • Sr • Scarabeo • Rally
Gulliver • SR Lc
MALAGUTI: F 10 • F 12 • Phantom Raffr. aria e
acqua - *Air and water cooled*
MBK: Booster • M. minarelli, Ma
YAMAHA 50: CY • MY 90-95
(Conf. 5 pz. - Pack 5 pcs)



10 070 7120



GUARNIZIONE COPERCHIO CARTER
TRASMISSIONE
TRANSMISSION COVER

PIAGGIO 50-125: Primavera Et3 Pk
50-90-125: Vespa
Flangia portaganasce posteriori
Rear brake shoes flange
(Conf. 5 pz. - Pack 5 pcs)





GUARNIZIONI VARIE - VARIOUS GASKET

10 070 8000 

GUARNIZIONE RONDELLE FIBRA
WASHER FIBRE

Rondella Ø 8 x 12 x 1 - Washer Ø 8 x 12 x 1
(Conf. 10 pz. - Pack 10 pcs)



10 070 9040 

GUARNIZIONE BASE CARBURATORE
GASKET CARBURETOR

(Conf. 5 pz. - Pack 5 pcs)
(R.O.131079)



10 070 9050 

GUARNIZIONE BASE CARBURATORE
GASKET CARBURETOR

(Conf. 5 pz. - Pack 5 pcs)
(R.O. 131115)



12 183 0650 

GUARNIZIONE SERBATOIO GOMMA
RUBBER TANK GASKET

PIAGGIO 125-150-200: Vespa Px
VNX-VLX-VSX
(R.O. 159804)



12 183 0660 

GUARNIZIONE SERBATOIO SUGHERO
CORK TANK GASKET

PIAGGIO 125: Vespa 125 anni 48-52
(R.O. 003979)



12 183 0670 

GUARNIZIONE SERBATOIO SUGHERO
CORK TANK GASKET

PIAGGIO 125: Vespa 125 anni 53-54
(R.O. 016704)



12 183 0680 

GUARNIZIONE SERBATOIO SUGHERO
CORK TANK GASKET

PIAGGIO 125-150: Vespa anni 55-57
(R.O. 028231)



12 183 0690 

GUARNIZIONE TAPPO BENZINA SUGHERO
CORK GASKET FUEL CAP

PIAGGIO 50-90-125: Vespa Primavera -Et3
V5A1-V5B1-V5B2-V5SA1-V9A1-VMA2-VMB1-
VNA-VNB
(Conf. 5 pz. - Pack 5 pcs)



12 183 0700 

GUARNIZIONE TAPPO BENZINA SUGHERO
CORK GASKET FUEL CAP

PIAGGIO 125-150-200: Vespa Px V5A1-V5B1-
V5B2-V5SA1-V9A1-VMA2-VMB1-VNA-VNB
(Conf. 5 pz. - Pack 5 pcs)



12 183 0710 

GUARNIZIONE RUBINETTO BENZINA
SUGHERO

CORK (PACK 5 PCS) GASKET FUEL COCK
PIAGGIO 50-90-125: Vespa Primavera -Et3
V5A1-V5B1-V5B2-V5SA1-V9A1-VMA2-VMB1-
VNA-VNB
(Conf. 5 pz. - Pack 5 pcs)



12 183 0720 

GUARNIZIONE RUBINETTO BENZINA
SUGHERO

CORK (PACK 5 PCS) GASKET FUEL COCK
PIAGGIO 125-150-200: Vespa Px VNX-VLX-VSX
(Conf. 5 pz. - Pack 5 pcs)



10 070 9060 

GUARNIZIONE BASE CARBURATORE
GASKET CARBURETOR

PIAGGIO 125-150: Vespa Px T5-Vnx2-VLx1-
Vsx1-Vnx5T
(Conf. 5 pz. - Pack 5 pcs)
(R.O. 150131)





GUARNIZIONI VARIE
VARIOUS GASKETS

GUARNIZIONI VARIE - VARIOUS GASKET

10 070 3520



APRILIA 50: Sr • Scarabeo • Rally • Gulliver • Sr Lc
MALAGUTI 50: Phantom Lc • F 10
YAMAHA: Cy • My • Ma
MBK 50: Evolis 93-95
(Conf. 5 pz. - Pack 5 pcs)



10 070 3930



PIAGGIO 50: Ape • Tm P
(Conf. 5 pz. - Pack 5 pcs)



10 070 3950



PIAGGIO 50-90-125: Vespa
(R.O. 078543)
(Conf. 5 pz. - Pack 5 pcs)



10 070 3960



PIAGGIO 50: Vespa Pk
(R.O. 196431)
(Conf. 5 pz. - Pack 5 pcs)



O-RING

10 070 6210



GUARNIZIONE COPERCHIO FRIZIONE
CLUTCH COVER GASKET

PIAGGIO 150: Vespa GL • Sprint
125-150: Vespa Px
(Conf. 5 pz. - Pack 5 pcs)
(R.O. 017881)

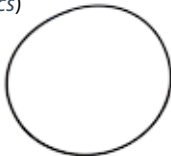

10 070 6220



O RING LEVETTA CAMBIO 6,75X2
O RING LEVER CHANGE

PIAGGIO 50-90-125: Vespa primavera - Et3
V5A1-V5B1-V5B2-V9A1-VMA2-VMB1
(Conf. 50 pz. - Pack 50 pcs)
(R.O. 006706)



10 070 6230



O RING LEVETTA CAMBIO 8,73X1,78
O RING LEVER CHANGE

PIAGGIO: Vespa Pk-Px
V5X1T-V5X2T-V5X3T-VN1XT-VLX1T
(Conf. 50 pz. - Pack 50 pcs)
(R.O. 006708)



10 070 6240



O RING PER CAMMA FRENO 11,11X1,78
O RING REAR CAM

PIAGGIO 125-150-200: Vespa Px
VN1XT-VLX1T-VSX1T
(Conf. 50 pz. - Pack 50 pcs)
(R.O. 006714)



10 070 6250



O RING PER SETTORE M. MOTO 15,88X2,62
O RING KICK STARTER SECTOR

PIAGGIO 125-150-200: Vespa Px
VN1XT-VLX1T-VSX1T
(Conf. 50 pz. - Pack 50 pcs)
(R.O. 006721)



10 070 6260



O RING PER PERNO RUOTA 23,4X3,53
O RING HUB

PIAGGIO 125-150-200: Vespa Px
VN1XT-VLX1T-VSX1T
(Conf. 50 pz. - Pack 50 pcs)
(R.O. 006731)





O-RING

10 070 6270 

O RING KARTER

O RING CRANKCASE

PIAGGIO 50-90-125: Vespa Primavera -Et3
V5A1-V5B1-V5B2-V9A1-VMA2-VMB1

(Conf. 50 pz. - Pack 50 pcs)

(R.O. 006716)



10 070 6280 

O RING PERNO SOSPENSIONE

O RING FRONT WHEEL PIN

PIAGGIO 125-150-200: Vespa Px
VN1XT-VLX1T-VSX1T

(Conf. 50 pz. - Pack 50 pcs)

(R.O. 177408)



10 070 6290 

O RING MOZZO POSTERIORE

O RING REAR HUB

PIAGGIO 125-150-200: Vespa Px
VN1XT-VLX1T-VSX1T

(Conf. 50 pz. - Pack 50 pcs)

(R.O. 78163)



10 070 6300 

O RING MOZZO POSTERIORE

O RING REAR HUB

Vespa old models

(Conf. 50 pz. - Pack 50 pcs)

(R.O. 79164)



10 070 6310 

O RING TAMBURO POSTERIORE

REAR DRUM O RING KIT

PIAGGIO 125-150-200: Vespa Px-Pxe Arcoba-
leno-VNX-VLX-VSX-VNX2-VLX2-VSX2

(R.O. 139433)



10 070 9030 

KIT O RING (Pack 7 Pcs)

PIAGGIO: Vespa Px -Sprint

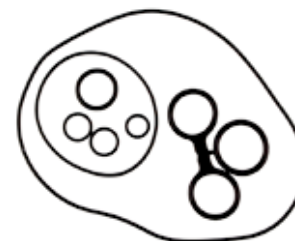

10 070 9000 

KIT O RING 382 PZ. 32 MISURE NBR

KIT O RING 382 PCS. 32 SIZES NBR



10 070 9010 

GUARNIZIONE O-RING COPERCHIO VALVOLE
VALVE COVER O-RING

KYMC0 50: Agility 4T • Dink 4T • Filly Lx • Like
4T • People S 4T • Super 8 4T • Vitality 4T

(R.O. 00102064)

(Conf. 5 pz. - Pack 5 pcs)

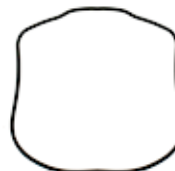

10 070 9020 

GUARNIZIONE O-RING COPERCHIO VALVOLE
VALVE COVER O-RING

KYMC0 125-150-200: Agility R16 4T

(R.O. 00122754)

(Conf. 5 pz. - Pack 5 pcs)





KIT REVISIONE POMPA ACQUA
WATER PUMP REPAIR KITS

APRILIA

10 011 0010 

Motori Minarelli 50 cc
 Con paraolio doppia tenuta
With special watertight seal



10 011 0200 

Motori Minarelli 50 cc
 Con paraolio doppia tenuta
 e completo di disco traino
With special watertight seal including water pump plate



10 011 0080 

Motori Minarelli 50 cc Am6 • Am345



10 011 0160 

50: Sr Ditech Eu2 02-03 • Sr H2O Ditech e
 Carburatore 00-03 • Sr R Factory Motore Aprilia 05



10 011 0230 

125: Atlantic Eu3 06-08 • Scarabeo Eu3 06-07 •
 Sport City Eu3 06-08
200: Scarabeo Eu3 06-07 • Sport City Eu3 06-08



10 011 0170 

125: Leonardo 96-01 • Scarabeo Motore Rotax 99-03
150: Leonardo 96-01 • Scarabeo Motore Rotax 99-03
200: Scarabeo Motore Rotax 99-03



10 011 0300 

250: Leonardo 99-01 • Leonardo St 01





BETA

10 011 0080

Motori Minarelli 50 cc Am6 • Am345



DERBI

10 011 0320

50: Senda R Drd Pro Eu2 05-09 • Senda R Drd Racing Eu2 05-08 • Senda Rx-Race Eu2 07-09 • Senda Rx-Trem Eu2 08 • Senda Sm Drd Pro Eu2 05-08 • Senda Sm X Trem Eu2 08 • Senda Sm X-Race Eu2 07-09

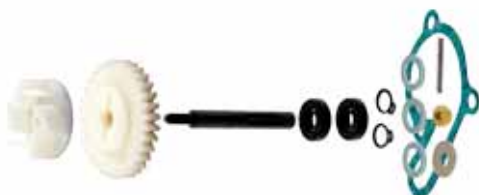

10 011 0240

50: Atlantis Lc 99-01 • Predator Lc 98-01



10 011 0250

50: Gpr Nude 04-05 • Gpr Racing 04-05 • Senda R 99-01 • Senda R Drd Racing 04-05 • Senda R Racer 03 • Senda Sm 00-01 • Senda Sm X-Race 04-05



GILERA

10 011 0230

125: Nexus Eu3 07-08 • Runner Vx 4T Eu3 07



10 011 0070

125: Dna 01 • Runner Vx Vxr 00-01
180: Dna 01-Runner Vx • Vxr 00-04





KIT REVISIONE POMPA ACQUA
WATER PUMP REPAIR KITS

GILERA

10 011 0020 

50: Dna 00-02 • Runner 97-00 • Runner Purejet 02-07 • Runner Sp 02-07

10 011 0030 

125-180: Runner Fx-Fxr 97-02



10 011 0210 

250: Nexus Eu3 06-07 • Oregon 06-08
300: Nexus Eu3 08-09



HONDA

10 011 0180 

125-150: Pantheon 2T 98-02



10 011 0190 

125-150: Chiocciola 00-06 • Sh 125 01-08



10 011 0510 

125-150: Pcx



10 011 0310 

250: Foresight 98





HONDA

10 011 0520 

300: Sh 07-14



KYMCO

10 011 0480 

50: B&W Eu2 03 • B&W 02 • Dink Lc 98-02 • Super 9 00-04



10 011 0470 

125-150: B&W Eu2 03-04 • B&W 00 • Dink 97-98 • Dink Classic 02-03 • Dink Lx 98-00 • Gran Dink 01-02
200: Dink Classic 04



10 011 0490 

200: Dntown i 10 • People Gti 10
300: Dntown Abs 10-11 9 Dntown i 11 • K-Xct i 12-14 • People Gti 10-12



10 011 0460 

250: B&W 00 • B&W Eu2 03 • Gran Dink 01-02 • Gran Dink Eu2 03-04 • People Lc 03-04 • People S 06 • People S i 07 • X-Citing 05 9 X-Citing 06-07 • Yup 03
300: People S i 08 • X-Citing i 08 • X-Citing i R 08-09



10 011 0550 

400: X Citing i 13 • X Citing i Abs 14



10 011 0500 

700: Myroad i 11





KIT REVISIONE POMPA ACQUA
WATER PUMP REPAIR KITS

MBK

10 011 0430 

50: Nitro 97-02 • Nitro Eu2 03



10 011 0010 

Motori Minarelli 50 cc
 Con paraolio doppia tenuta
With special watertight seal



10 011 0200 

Motori Minarelli 50 cc
 Con paraolio doppia tenuta
 e completo di disco traino
*With special watertight seal including water
 pump plate*



10 011 0090 

125: Skyliner 98-03
 150: Skyliner 00-02
 180: Skyliner 03



PEUGEOT

10 011 0080 

Motori Minarelli 50 cc Am6 • Am345



10 011 0530 

50: Speedfight • X Fight • X Race • X Team 2
 (R.O. 734428-743278)





PIAGGIO

10 011 0020 

PIAGGIO 50: Nrg 94-96 • Nrg Purejet 02-04
 • Quartz 92-96 • Zip Sp 96-00



10 011 0230 

125: Beverly Rst 06-07 • Vespa Granturismo
 06-07 • X8 05-06 • X9 Evolution 05-06
200: Vespa GT 06-07 • X8 05-07



10 011 0070 

125: Beverly 01-03 • Beverly Rst 04-05
 • Hexagon Gtx 00 • Vespa Gt 03-05 • X9
 01-02 • X9 Evolution 03
180: Hexagon Gtx 00
200: Beverly 01-03
 • Vespa Granturismo
 03-05



10 011 0030 

125: Hexagon 94-97 • Hexagon Lx-Lxt 98-99
150: Hexagon 94-97
180: Hexagon Lx-Lxt 98-99



10 011 0220 

250: Beverly Rst 04-05



10 011 0210 

250: Beverly 06-07 • Beverly Tourer Eu3 08-09 • Carna-
 by 08 • Mp3 06-08 • Vespa Gtv 4T Eu3 08 • X7 Eu3 08 •
 X8 Eu3 05-08 • X9 Evolution 04
300: Beverly ie Tourer 09 • Carnaby Cruiser 09 • Mp3 ie
 Mic 10 • Vespa Gts Super 08 • X7 Evo ie Eu3 09



10 011 0440 

250: Carnaby 08 • Mp3 06-09 • Vespa Gt 60 06-
 07 • Vespa Gts 05-13 • Vespa Gtv 06-09 • X7 Eu3
300: Beverly Rst 4T 4V ie 10-14 • Beverly Tourer
 Eu3 09-10 • Carnaby Cruiser 09-12 • Mp3 10-13
 • Mp3 Yourban 11-12 • Vespa Gts 08-13 • Vespa
 Gtv 10-13 • X7 Evo ie Eu3 09-10



10 011 0450 

500: Beverly Cruiser 07-12 • Mp3 Lt Business
 Abs 14-16 • Mp3 Lt Sport - Business 14-16 •
 Mp3 RL Sport - Business 11-12 • Mp3 Sport
 Abs 14-15 • X10 4T 4V ie Eu3 12-14
 (R.O. 872536)





KIT REVISIONE POMPA ACQUA
WATER PUMP REPAIR KITS

SUZUKI

10 011 0150

50: Katana I Serie 97-00

10 011 0260

125: Epicuro 99-01
150: Burgman 02-06 • Epicuro 99-01
250: Burgman 98-02 • Burgman 03-06
400: Burgman 03-06 • Burgman 99-02



10 011 0410

SUZUKI 400: Burgman 07-08

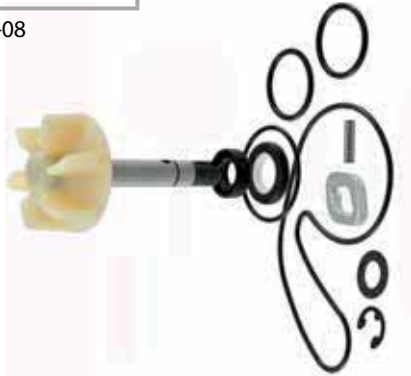

YAMAHA

10 011 0010

Motori Minarelli 50 cc
Con paraolio doppia tenuta
With special watertight seal



10 011 0200

Motori Minarelli 50 cc
Con paraolio doppia tenuta
e completo di disco traino
With special watertight seal including water pump plate



10 011 0430

50: Aerox 97-10 • Aerox Eu2 03



10 011 0080

Motori Minarelli 50 cc Am6 • Am345

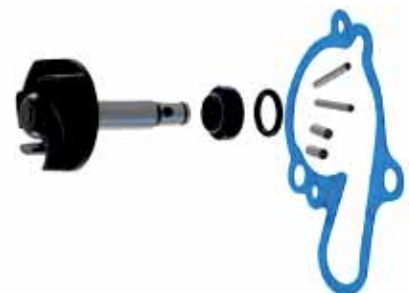



YAMAHA

10 011 0560 

50: Neo's 4T



10 011 0090 

125: Majesty 98-09
150: Majesty 00-02
180: Majesty 03-06



10 011 0350 

125: X City • X Max



10 011 0540 

125: Xenter 12-14 • Xcr 12 Majesty S
150: Xenter 12-14



10 011 0270 

250: Majesty 00-03



10 011 0280 

400: Majesty 04-08 • Majesty Abs 07-08



10 011 0290 

500: T-Max 04-11



10 011 0420 

530: T-Max 12-13





VARI
VARIOUS

10 012 0010 

TERMOSTATO - THERMOSTAT

KYMCO 50: B&W/Eu2 02-03 • Dink Lc 98-02 • Super 9/Sport Eu2 00-04

125: Dink Eu3 06-07 • Downtawn/i 09 • People Gti 10

125-150: B&W/Eu2 00-04 • Dink 07-98 • Dink Classic Eu2 02-03 • Dink Lx 98-00 • Grand Dink Eu2 01-04

200: Dink classic Eu3 i 04-07 • Downtown 10 • People Gti 10

250: B&W Eu2 00-03 • Grand Dink Eu2 01-04 • Kxr 03-04 • Mxu 05 • X Citing 05 • Yup 03

300: Downtown/i Abs 09-10 • Maxxer 05-06 • Mxu 05-06 • Mxur 10 • People S i 08 • Gti 10 • X Citing i/i R 08-09

Di primo equipaggiamento - *OEM Quality*
(R.O. 00129962)



10 012 0040 

TERMOSTATO - THERMOSTAT

KYMCO 300: Downtown Abs i 11

• Downtown i 11 • People Gti 11
(R.O. 00119113-19300-LFA7-E00)



24 640 0032 

RELÈ VENTOLA - COOLING FAN RELAY

KYMCO 125: Downtown i 09 • K-Xct i 12

200: Downtown i 10

300: Downtown i 09 • Downtown Abs i 11 • Downtown Abs 10 • Downtown i 11 • K-Xct i 12

(R.O. 0139005-39100-LEA7-E00)



24 640 0042 

RELÈ VENTOLA - COOLING FAN RELAY

KYMCO 125: G-Dink 12 • People Gti 10

200: People Gti 10

300: G-Dink 12 • People Gti 10-11 • People Abs 12

700: Myroad i 11

(R.O. 0139021-39100-KKE5-E01)



10 011 0040 

KIT DISCO TRAINO GIRANTE POMPA

WATER PUMP PLATE

MOTORI MINARELLI: YAMAHA • APRILIA

• MALAGUTI • MBK 50cc



▶ CUSCINETTI
BEARINGS

▶ KIT REVISIONE
ALBERI MOTORE
CRANKSHAFT SERVICING KIT

▶ SERIE PARAOLIO
MOTORE
OIL SEAL KIT

▶  **SKF**

▶  **NTN**®



CUSCINETTI RADIALI A SFERE

BALL BEARINGS

● Gabbia acciaio - *Steel cage*

■ Gabbia nylon - *Nylon cage*

DATI TECNICI SUI CUSCINETTI - BALL BEARINGS SPECIFICATIONS

BB1 =Cuscinetti a sfere esecuzione speciale - *Deepgrove ball bearings with special execution*

TN9 =Gabbia stampata di Poliammide 6,6 rinforzata con fibre di vetro - *Nylon cage reinforced with fiberglass*

TOLLERANZA INTERNA =C1: Tolleranza inferiore a C2 - *Clearance inferior than C2*

CLEARANCE = C2: Tolleranza inferiore al normale - *Clearance inferior than standard*-C3: Tolleranza maggiore del normale - *Clearance superior than standard*

C4: Tolleranza maggiore di C3 - *Clearance superior than C3* - C5: Tolleranza maggiore di C4 - *Clearance superior than C4*



MARCA TRADE	MISURE SIZE	CODICE RMS RMS CODE	APPLICAZIONE APPLICATION	MODELLO - TRADE MARK	CODICE ORIGINALE ORIGINAL CODE
SKF	● 10 - 30 - 9 (6200 C3)	10 020 0200	Albero primario <i>Driven pulley shaft</i>	MOTORI MINARELLI - MBK - YAMAHA: Scooter 50	007035
				PIAGGIO: Vespa 50-125 - PK XL - Rush - N - FL - FL2 HP - PK 50-125 - APE 50P - FL-FL2-FL3-Rst mix	
SKF	● 12 - 32 - 10 (6201 C3)	10 020 0020	Albero primario <i>Driven pulley shaft</i>	HONDA: Sh 50 - 100 90> NH-Sfx-Sky-X8R - Vision-Shadow - Balj 50/100	96100-62013-00
			Asse ruota post. <i>Rear wheel axle</i>	PIAGGIO: Vespa 50-125 - Pk 50-125 - Pk XL-Ape 50P - FL - FL2 - FL3 Europa-Rst mix	002800
SKF	● 12 - 37 - 12 (6301)	10 020 0230	Albero primario <i>Driven pulley shaft</i>	HONDA: Sky - Balj 100 - CH 125 Spacy - Cn 250	91003-K54-003 (R.O. 090024)
NRB	● 12 - 40 - 12	10 020 0503	Ingranaggio multiplo <i>Gearbox bearing</i>	PIAGGIO 125: Vespa Gts - Ts 150: Vespa Sprint - Veloce - Super - Px VNL2T-VLN3-VLB-VLB1T-VBC1T-VNX1T-VLX1T	097718
SKF	● 15 - 35 - 11 (6202 C3)	10 020 0240	Asse ruota post. <i>Rear wheel axle</i>	HONDA: Sfx - Sky - Vision 50 - Phanteon 125/150	96100-62023-00
			Albero motore <i>Crankshaft</i>	PIAGGIO 50: Ciao - Bravo - Boxer - Si	102258
SKF	● 15 - 42 - 13 6302	10 020 0640	Asse ruota post. <i>Rear wheel axle</i>	PIAGGIO 50-125: <i>Old Model</i>	030209
SKF	■ 17 - 40 - 12 (6203 TN9-C5H)	10 020 0080	Albero primario <i>Driven pulley shaft</i>	PIAGGIO - GILERA: Runner - Stalker 50 - Liberty 50 - Nrg Extreme - Et2 - Et2 liniezione - Velofax	002802
			Ruota anteriore <i>Front Wheel</i>	PIAGGIO: Vespa 50-90-125 Primavera	
SKF	● 17 - 40 - 12 (6203)	10 020 0250	Albero primario <i>Driven pulley shaft</i>	Motori Scooter 50: MINARELLI - MBK - YAMAHA - HONDA: Sh 100 99/00	002802
			Ruota anteriore <i>Front Wheel</i>	PIAGGIO: Vespa 50-90-125 Primavera	
SKF	● 17 - 40 - 12 (6203 C3)	10 020 0450	Carter <i>Crank-case</i>	KYMCO: 50 2T	008019
SKF	● 17 - 47 - 14 (6303)	10 020 0090	Albero motore <i>Crankshaft</i>	PIAGGIO: Vespa 50-125 - Pk 50 XL - Rush - N - FL 50-125 - FL2 HP50 PK 50-125 - PK Automatica - Ape P50 - FL - FL2 - FL3 - Rst mix	227687
			Tamburo freno ant. <i>Front brake drum</i>	PIAGGIO: Ape TM P703-P703 V Diesel/miscela-Car-Max Diesel-TM P602	227687
SKF	● 17 - 47 - 14 (6303 C3)	10 020 0430	Albero motore <i>Crankshaft</i>	PIAGGIO: 50-90-125 Primavera	227687
SKF	■ 17 - 47 - 14 (6303TN9C3)	10 020 0550	Albero motore <i>Crankshaft</i>	MINARELLI 50: AM345-AM6	-
SKF	● 20 - 42 - 9 (BB1-3573)	10 020 0650	Asse ruota post. <i>Rear wheel axle</i>	PIAGGIO 50-125: <i>Old Model</i>	012501
SKF	● 20 - 42 - 12 (6004)	10 020 0270	Asse ruota post. <i>Rear wheel axle</i>	HONDA: Sfx - Balj 50/100 - Shadow 50/90 - CH 125 Spacy	9009-GEO-003
SKF	● 20 - 47 - 14 (6204 C5)	10 020 0110	Albero motore <i>Crankshaft</i>	PIAGGIO: Vespa 50-125 - Pk 50-125 - PK XL - Rush - N - FL - FL2 50 Ape P50 - FL - FL2 - FL3 Europa - Rst mix 50	090131
SKF	● 20 - 47 - 14 (6204 C3)	10 020 0390	Albero motore lato volano <i>Crankshaft flywheel side</i>	PIAGGIO: 50-90-125 Primavera	090131



DATI TECNICI SUI CUSCINETTI - BALL BEARINGS SPECIFICATIONS

BB1 =Cuscinetti a sfere esecuzione speciale - *Deepgrove ball bearings with special execution*
 TN9 =Gabbia stampata di Poliammide 6,6 rinforzata con fibre di vetro - *Nylon cage reinforced with fiberglass*
 TOLLERANZA INTERNA =C1: Tolleranza inferiore a C2 - *Clearance inferior than C2*
 CLEARANCE = C2: Tolleranza inferiore al normale - *Clearance inferior than standard*-C3: Tolleranza maggiore del normale - *Clearance superior than standard*
 C4: Tolleranza maggiore di C3 - *Clearance superior than C3* - C5: Tolleranza maggiore di C4 - *Clearance superior than C4*



MARCA TRADE	MISURE SIZE	CODICE RMS RMS CODE	APPLICAZIONE APPLICATION	MODELLO - TRADE MARK	CODICE ORIGINALE ORIGINAL CODE
SKF	● 20 - 47 - 14 (6204)	10 020 0590	Campana frizione <i>Clutch bell</i>	PIAGGIO: Vespa 50-125 - Pk 50-125 - PK XL - Rush - N - FL - FL2 50 Ape P50 - FL - FL2 - FL3 Europa - Rst mix 50	090131
Koyo	● 20 - 47 - 14 83299-9RTCS31	10 020 0330	Albero motore <i>Crankshaft</i>	Motori Scooter 50: MINARELLI - MBK - YAMAHA	-
SKF	■ 20 - 47 - 14 (6204TN9-C4HLHT23)	10 020 0120	Albero motore <i>Crankshaft</i>	Motori Scooter 50: MINARELLI - MBK - YAMAHA FRANCO MORINI: LATO VOLANO Scooter 50-100-AH Aria-AH L Aria/ Acqua	-
NTN	● 20 - 47 - 14 6204 C4	10 020 0482	Alb. Mot. Lato volano <i>For Crankshaft flywh. Magn.</i>	MOTORI MINARELLI - YAMAHA: Scooter 50	-
SKF	● 20 - 47 - 14 6204 C4MT	10 020 0630	Albero motore-Crankshaft	PEUGEOT 50: Speed Fight 2 aria-Lc 307 Wrc Silver 05/06-Trk 2 Wrc 04/06 CPI-GENERIC	-
SKF	● 20 - 52 - 12 (BB1-3055B)	10 020 0140	Albero motore <i>Crankshaft</i>	PIAGGIO / GILERA: Scooter 50 PEUGEOT (Scooter 50): Buxy - Zenith - Speedake - SV Geo - Squab- Eliseo-SpeedFight-Trekker-Vivacity PIAGGIO: Vespa 125	(R.O. 431125) (R.O. 722483)
NTN		10 020 0142			(R.O. 610198M)
SKF	■ 20 - 52 - 12 (BB1B-447205A)	10 020 0290	Alb. Mot. Lato volano <i>For Crankshaft flywh. magn.</i>	KYMCO (Scooter 50): Heroism - Sniper - Sniper DD - People - Top boy	-
SKF	● 22 - 50 - 14 (62/22)	10 020 0420	Mozzo ruota posteriore <i>Rear wheel hub</i>	PIAGGIO: Ape TM P703V-FL2 - TM P703/P703V Diesel - TMP 602-MP P501/P601-Car P2/P3 - Car Max Diesel-Poker Benzina Diesel	(R.O.243303)
SKF	● 25 - 47 - 8 (16005)	10 020 0520	Ingranaggio Frizione <i>Clutch gear</i>	PIAGGIO: Ape 50 - Vespa 50-125-Pic 50-125-Pk XL 50-125	(R.O.007130)
SKF	■ 25 - 52 - 13 (BB1-3056 C)	10 020 0280	Albero motore <i>Crankshaft</i>	FRANCO MORINI: LATO FRIZIONE Scooter 50-100 - AH Aria - AH L aria - Acqua	-
NTN	■ 25 - 52 - 13 (BB1-3056 C)	10 020 0282	Albero motore <i>Crankshaft</i>	FRANCO MORINI: LATO FRIZIONE Scooter 50-100 - AH Aria - AH L aria - Acqua	-
SKF	■ 25 - 52 - 15 (6205-ETN9/C4)	10 020 0540	Albero motore <i>Crankshaft</i>	APPLICAZIONI VARIE - VARIOUS APPLICATIONS	-
SKF	● 25 - 56 - 12 (BB1-3096)	10 020 0150	Albero motore <i>Crankshaft</i> Albero mot. lato pul. motrice <i>For Crankshaft driving pulley side</i>	HONDA: Sh 50-100 (96>) - Sky 50 97> - Balj 100 96 - X8R PEUGEOT: Speedfight 97-98-Trekker 98-SVL 98-Vivacity 99-Eliseo 99-100 cc PIAGGIO: Liberty-Vespa 50 4T 00-02-Zip 00-04 KYMCO: Sniper 93-96-Heroism 95-97-Top Boy 97-98-People 99-50 cc	(R.O.91005-KEE-730) (R.O.736052) (R.O.00109229)
SKF	● 25 - 62 - 12 (BB1-0855)	10 020 0160	Alb. Mot. lato frizione <i>For Crankshaft clutch side</i>	PIAGGIO: Cosa 1/2-Vespa PX-PXE Arcobaleno 125-150/200-PX T5 125	(R.O. 097804)
	25 - 62 - 12	10 020 0161 NEW	Alb. Mot. lato frizione <i>For Crankshaft clutch side</i>	PIAGGIO: Cosa 1/2 - Vespa PX - PXE Arcobaleno 125-150-200 - PX T5 125 - Vespa GL-Sprint-Super-Gtr 150	(R.O. 097804)
NRB	25 - 62 - 12	10 020 0163	Alb. Mot. lato frizione <i>For Crankshaft clutch side</i>	PIAGGIO: Cosa 1/2 - Vespa PX - PXE Arcobaleno 125-150-200 - PX T5 125 - Vespa GL-Sprint-Super-Gtr 150	(R.O. 097804)
SKF	● 25 - 62 - 17 (6305-C5)	10 020 0170	Alb. Mot. lato frizione <i>For Crankshaft clutch side</i>	PIAGGIO: Ape Car P2/P3 - MP P501/P601 2ª Serie - TM P602 - P703-P703 V	(R.O. 169809)
NTN	● 25 - 68 - 12 CX (SC05B31CS37)	10 020 0182	Albero motore <i>Crankshaft</i>	PIAGGIO-GILERA: Typhoon 125-Runner FX/FXR 125/180-Liberty 125 - Sfera 125-Vespa ET4 125-Hexagon LX4 125-150-LX/LXT 125/180-Skip- per 125-150-LX 125/150	(R.O.483970)
NTN	● 35 - 72 - 17 (6207C3)	10 020 0662	Albero motore <i>Crankshaft</i>	HONDA: Sh 125/150 SUZUKI 125-150: Epicuro 99-01-Burgman 02-08-Sixteen 08 200: Burgman 07-08 - 250: Burgman 98-06 - 400: Burgman N 99-08	-
NTN	● 35 - 72 - 15 (TMSC07A87CS3PX1)	10 020 0672	Albero motore <i>Crankshaft</i>	HONDA: Sh 125-150	-



CUSCINETTI RADIALI A SFERE COPERTI DA DUE LATI 2RS1

DOUBLE RUBBER SEALS BALL BEARINGS 2RS1

● Gabbia acciaio - Steel cage

■ Gabbia nylon - Nylon cage

CUSCINETTI RADIALI A SFERE COPERTI DA DUE LATI 2Z - DOUBLE SHIELD SEALS BALL BEARINGS 2Z

DATI TECNICI SUI CUSCINETTI - BALL BEARINGS SPECIFICATIONS

2Z = Schermo in lamiera non strisciante ad entrambi i lati del cuscinetto - *Not creeping plated shield on both the sides of the bearing*
 C1: Tolleranza inferiore a C2 - *Clearance inferior than C2* - C2: Tolleranza inferiore al normale - *Clearance inferior than standard*
 C3: Tolleranza maggiore del normale - *Clearance superior than standard* - C4: Tolleranza maggiore di C3 - *Clearance superior than C3*
 C5: Tolleranza maggiore di C4 - *Clearance superior than C4*



SKF	12 - 32 - 10 (6201-2Z)	10 020 0350	Varie <i>Various</i>	-	-
	28 - 8 - 9 (638 ZZ ISB)	10 020 0803	Carter Motore <i>Crankcase</i>	Piaggio 50-100: Fly • Liberty • Nrg • Vespa Lx • Vespa S • Zip 2T/4T	82521R

DATI TECNICI SUI CUSCINETTI - BALL BEARINGS SPECIFICATIONS

2RS1 = Guarnizione strisciante di gomma sintetica, rinforzata da una rosetta di lamiera sui due lati del cuscinetto - *Double rubber seals ball bearings*
 TOLLERANZA INTERNA - *CLEARANCE*
 C1: Tolleranza inferiore a C2 - *Clearance inferior than C2* - C2: Tolleranza inferiore al normale - *Clearance inferior than standard*
 C3: Tolleranza maggiore del normale - *Clearance superior than standard* - C4: Tolleranza maggiore di C3 - *Clearance superior than C3*
 C5: Tolleranza maggiore di C4 - *Clearance superior than C4*



MARCA TRADE	MISURE SIZE	CODICE RMS RMS CODE	APPLICAZIONE APPLICATION	MODELLO - TRADE MARK	CODICE ORIGINALE ORIGINAL CODE
SKF	● 8 - 22 - 7 (608-2RSH C3LNT23)	10 020 0190	Pompa acqua <i>Water pump</i>	Motori Scooter 50: MINARELLI - MBK - YAMAHA-PIAGGIO : Scooters 50-125-150-180	(R.O.842797)
SKF	● 10 - 35 - 11 (6300-2RSH)	10 020 0220	Asse ruota anteriore <i>Front wheel axle</i>	MBK : Booster 50 (90-94) - Road - Ng (95-99) - Spirit 50 (96-99) - Track - Rocket - Ovetto - Nitro 50 (97-99) - Evolis (92-96) - Fizz - Forte YAMAHA : Axis 50 (95-96) - Aerox - Breeze - Spy - Neo'S - Bw'S Bump - Original - NG	-
SKF	● 12 - 24 - 6 (61901-2RS1-3HT)	10 020 0010	Puleggia condotta <i>Driven pulley</i>	Motori Scooter 50: MINARELLI - MBK - YAMAHA - PIAGGIO - GILERA	(R.O. 289953)
SKF	● 12 - 32 - 10 (6201-2RSH)	10 020 0360	Ruota anteriore <i>Front Wheel</i>	MBK : 125-150 YAMAHA : 50-80-125-150 PIAGGIO : Vespa Px 125-150-200	(R.O. 007135)
NTN	● 12 - 32 - 10 (6201-LL5/5KU)	10 020 0362	Ruota anteriore <i>Front Wheel</i>	MBK : 125-150 YAMAHA : 50-80-125-150 PIAGGIO : Vespa Px 125-150-200	(R.O. 007135)
SKF	● 15 - 32 - 9 (6002-2RSH)	10 020 0040	Puleggia condotta <i>Driven pulley</i>	PIAGGIO - GILERA : Sfera Base 50 (91) - Zip Base 50 (92) - Skr city 80 - Sfera 125 (95) - Liberty 125 - Hexagon Lx4 125 - Et4 125	(R.O.285007)
NTN	● 15 - 32 - 9 (6002-LLU)	10 020 0042	Puleggia condotta <i>Driven pulley</i>	PIAGGIO - GILERA : Sfera Base 50 (91) - Zip Base 50 (92) - Skr city 80 - Sfera 125 (95) - Liberty 125 - Hexagon Lx4 125 - Et4 125	-
SKF	● 15 - 35 - 11 (6202-2RSH)	10 020 0370	Tamburo anteriore <i>Front Drum</i>	PIAGGIO : Vespa Px 125-150-200 - Arcobaleno	(R.O. 177610)
SKF	● 15 - 42 - 13 (6302-2RSH)	10 020 0440	Ruota posteriore <i>Rear wheel</i>	PIAGGIO : Vespa Px 125-150-200 - Arcobaleno	(R.O. 235834)
SKF	● 17 - 30 - 7 (61903-2RS1)	10 020 0060	Puleggia condotta <i>Driven pulley</i>	PIAGGIO - GILERA : Typhoon 125 - Runner FX - Fxr 125-180 - Skipper 125-150 - Lx 125-150 - Hexagon 125-150 - Lx/Lxt 125/180	(R.O. 431069)
SKF	● 17 - 35 - 10 (6003-2RSH)	10 020 0070	Puleggia condotta <i>Driven pulley</i>	PIAGGIO - GILERA : Typhoon 125 - Runner Lx - Lxt 125-180 - Skipper 125-150 - Lx 125-150 - Hexagon 125-150 - Lx/Lxt 125/180	(R.O. 431068)
SKF	● 17 - 40 - 12 (6203-2RSH)	10 020 0380	Supporto motore <i>Engine Mounting</i>	Motori Scooter 50: MINARELLI - MBK - YAMAHA	-
SKF	● 17 - 47 - 14 (BB1-0683-2RS1)	10 020 0100	Albero primario <i>Driven pulley shaft</i>	PIAGGIO - GILERA : Typhoon 125 - Runner Fx - Fxr 125-180 - Sfera 125 - Liberty 125 - Et4 125 - Skipper 125-150 - Lx 125-150 - Hexagon Lx4 125-150 - Lx - Lxt 125-180	(R.O. 432305)
SKF	● 20 - 42 - 12 (6004-2RSH/C3)	10 020 0530	Varie <i>Various</i>	-	-
SKF	● 20 - 47 - 14 (BB1-0843)	10 020 0130	Albero ruota posteriore <i>Rear wheel axle</i>	PIAGGIO - GILERA : Scooter 50-80 - Typhoon 125 - Runner Fx/Fxr 125-180 - Hexagon Lx4 125 - Liberty 125 - Et4 - Sfera 125 - Hexagon 125-150 - Lx/Lxt 125-180 - Skipper 125-150 - Lx 125-150 PIAGGIO : Vespa 50-125-Pk XL-Rush-N-FL 50-125-Px Ts-Pxe 125-150-200-Arc-Cosa 1-2	(R.O. 434735) (R.O. 434735)
SKF	● 25 - 47 - 12 (6005 2RSH)	10 020 0800	Ruota anteriore/posteriore <i>Front/rear Wheel</i>	Moto Fuoristrada <i>Off Road Motorbikes</i>	(R.O. 434735)
SKF	● 20 - 47 - 14 (6204-2RSH)	10 020 0600	Ruota posteriore <i>Rear Wheel</i>	PIAGGIO : Ape 50 P-Tmp FL-FL2-FL3 Europa-Rst Mix-Scooter 50-100: Hexagon 125-150-180 - Liberty-Sfera 125-Skipper 125-150-Vespa Et4-FL-Pk XL 125-Vespa Px-Cosa 125-150-200	(R.O. 43473T)



DATI TECNICI SUI CUSCINETTI - <i>BALL BEARINGS SPECIFICATIONS</i>					
2RS1 = Guarnizione strisciante di gomma sintetica, rinforzata da una rosetta di lamiera sui due lati del cuscinetto - <i>Double rubber seals ball bearings</i> TOLLERANZA INTERNA - <i>CLEARANCE</i> C1: Tolleranza inferiore a C2 - <i>Clearance inferior than C2</i> - C2: Tolleranza inferiore al normale - <i>Clearance inferior than standard</i> C3: Tolleranza maggiore del normale - <i>Clearance superior than standard</i> - 4: Tolleranza maggiore di C3 - <i>Clearance superior than C3</i> C5: Tolleranza maggiore di C4 - <i>Clearance superior than C4</i>					
MARCA TRADE	MISURE SIZE	CODICE RMS RMS CODE	APPLICAZIONE APPLICATION	MODELLO - TRADE MARK	CODICE ORIGINALE ORIGINAL CODE
CUSCINETTI RADIALI A SFERE COPERTI DA UN LATO RS1 SINGLE RUBBER SEALS BALL BEARINGS RS1					
DATI TECNICI SUI CUSCINETTI - <i>BALL BEARINGS SPECIFICATIONS</i>					
RS1 = Guarnizione strisciante di gomma sintetica, rinforzata da una rosetta di lamiera ad un lato del cuscinetto - <i>Single rubber seals ball bearings</i>					

	● 10 - 30 - 9 (6200-RSH)	10 020 0210	Asse ruota anteriore <i>Front wheel axle</i>	MALAGUTI: F10 92/99 - Yesterday 97/99	
	● 12 - 32 - 10 (6201-RSH)	10 020 0030	Asse ruota anteriore <i>Front wheel axle</i>	HONDA: SH 50 (96<)- Sky - Vision - PK 50 Wallaro MALAGUTI: F12 50/100 (94/99)-Crosser - F15 (96/99) - Centro (94/99) - Ciak MBK: Flipper 50 (98/99) - Flame 125 (98/99) - Vertex 150 - Skyliner 125 YAMAHA: Why 50 (98/99)-Majesty 125 (98/99)-Cygnus 125 (95/98)-Flyone 150 (90/98)-Beluga 125 (90/95)	(R.O.96140-62000-10)
	● 15 - 35 - 11 (6202-RSH)	10 020 0050	Tamburo freno ant. e mozzo ant. <i>Front brake drum and front hub</i>	PIAGGIO: Sfera Rst 50 - Sfera 125 - Quartz 50 - Zip SP 50 - Skipper 125/150 - Hexagon LX4 125 - LX/LXT 125/180/250 - Hexagon 125/150 - ET2/ET4 125/150 - Vespa PK 50/125 - PK XL Rush - N - FL - FL2 - PX T5 125/150/200 e Arcobaleno - Cosa ½	(R.O.177610)
	● 17 - 40 - 12 (6203-RSH)	10 020 0260	Albero ruota posteriore <i>Rear wheel axle</i>	Motori Scooter 50: MINARELLI - MBK - YAMAHA	

CUSCINETTO A RULLI - <i>ROLLER BEARINGS</i>					
25 - 38 - 15	10 019 0010	Albero motore - <i>Crank shaft</i>	PIAGGIO: Cosa 1-Cosa 2-FL 125 (89) - Vespa PX -PXE Arcobaleno125-150-200	(R.O. 133068)	
25 - 38 - 15	10 015 1513 NEW	Albero motore lato volano <i>Crank shaft flywheel side</i>	PIAGGIO: Vespa PX -PXE Arcobaleno 125-150-200	(R.O. 133068)	
29,7 - 42,5 - 9,5	10 019 0033 NEW	Cuscinetto albero cambio <i>Gear shaft bearing</i>	PIAGGIO: Vespa 125 Modello 59		

10 015 1513

NEW

10 020 0870

NEW

RULLINI - ROLLERS

PIAGGIO 125-150: Vespa Px T5-Vnx2-VLX1-Vsx1-Vnx5T
(R.O. 150131)

KIT CUSCINETTI - BEARING KIT

PIAGGIO: Vespa Px 125-150 • LML
(2 Tempi - 2 Strokes)





ASTUCCI A RULLI - GABBIE A RULLI

DRAWN CUPS - ROLLER CAGES

ASTUCCI A RULLI APERTI DA UN LATO - DRAWN CUPS ONE SIDE OPEN

2RS1 = Guarnizione strisciante di gomma sintetica, rinforzata da una rosetta di lamiera sui due lati del cuscinetto - Double rubber seals ball bearings

TOLLERANZA INTERNA - CLEARANCE

C1: Tolleranza inferiore a C2 - Clearance inferior than C2 - C2: Tolleranza inferiore al normale - Clearance inferior than standard

C3: Tolleranza maggiore del normale - Clearance superior than standard - 4: Tolleranza maggiore di C3 - Clearance superior than C3

C5: Tolleranza maggiore di C4 - Clearance superior than C4

CODICE RMS RMS CODE	MODELLO - TRADE MARK	CODICE ORIGINALE ORIGINAL CODE
10 015 1000	Misura: Ø 12x18x12 Carter motore • <i>Crank case</i> : Vespa N Asse ruota post. • <i>Wheel axle</i> : Sfera Quartz • Free • Zip Fast Rider • Typhoon • Storm • Sfera Maquillage Mozzo ruota post. • <i>Wheel axle</i> : Bravo 3 • Superbravo 3	(R.O. 224309)
10 015 1190	Misura: Ø 16x14,3 Perno sospensione • <i>Suspension pin</i> : Vespa Px 125-150 • P 200e Vnx-Vlx-Vbx • Vespa Pk 125 XL Vmx6t	(R.O. 137146)
10 015 1200	Misura: Ø 12x12 Perno sospensione • <i>Suspension pin</i> : Vespa Px 125	(R.O. 174099)
ASTUCCI A RULLI APERTI DA AMBO I LATI - DRAWN CUPS TWO SIDES OPEN		
10 015 1100	Misura: Ø 12x18x12 Albero trasmissione mozzo posteriore • <i>Rear wheel axle</i> : Easy Moving • Free • Free FL • Nrg • Nrg Rst • Ntt • Quartz 50 • Sfera Rst 50	(R.O. 130491)
10 015 1110	Misura: Ø 18x24x16 Perno molleggio • <i>Pin Suspension arm</i> : Vespa 50 - 90 - 125	(R.O. 090457)
10 015 1120	Misura: Ø 22x28x12 Mozzo anteriore • <i>Front brake drum</i> : Vespa 50 - FL • Hp • Sfera 50 • Sfera Maquillage • Quartz • Zip Sp • Vespa Et4 • Skipper • Hexagon	(R.O. 177436)
10 015 1130	Misura: Ø 20x26x16 Mozzo anteriore • <i>Front brake drum</i> : Vespa 50 - FL • Hp • Vespa N • Vespa Px • Cosa • Cosa 1-2 • Sfera 50 • Maquillage • Quartz • Zip Sp Vespa Et4 • Skipper • Hexagon	(R.O. 177442)
10 015 1140	Misura: Ø 16x22x22 Campana frizione • <i>Pulley</i> : Ciao Sc • R • Px • P • Si • Boxer • Bravo	(R.O. 120668)
10 015 1150	Misura: Ø 28,5x35x12 Albero secondario • <i>Driven shaft</i> : Vespa Px 125 E • Px 150 E • Px 200 E • T5 • Ape Mp • Ape P601 prima serie	(R.O. 106956)
10 015 1153 NEW	Misura: Ø 28,5x35x12 Albero secondario • <i>Driven shaft</i> : Vespa Px 125 E • Px 150 E • Px 200 E • T5 • Ape Mp • Ape P601 prima serie	(R.O. 106956)
10 015 1170	Misura: Ø 25x33x18 Puleggia fissa frizione posteriore • <i>Driven pulley</i> : Piaggio 400: Beverly Eu 3 06-07 • Mp3 07 • X Evo 07-08 • X8 Eu 3 06-08 500 : Beverly 02-06 • Eu 3 06-08 • Cruiser 07 • X9 01-02 • Evolution 03-07 • Evolution Abs 06-07	(R.O. 829808)
10 015 1180	Misura: Ø 12x20x12 Vespa 150 GL • Sprint • Super Vla • Vlb • Vbc	(R.O. 152387)
10 015 1210	Misura: Ø 16x12 Vespa 50-90-125 Primavera Et3 • Pk • Pk XL • FL • Rush • N	(R.O. 137731)
10 015 1230	Misura: HK Ø 20x12 Mozz ruota post. • <i>Rear wheel axle</i> : Boss • Bravo • Ciao • Grillo • Si • Superbravo	(R.O. 131509)
10 015 1240	Misura: BK Ø 15x12 Mozz ruota post. • <i>Rear wheel axle</i> : Boss • Bravo • Ciao • Grillo • Si • Superbravo	(R.O. 103689)
10 015 1250	Misura: HK Ø 13x12 Mozz ruota post. • <i>Rear wheel axle</i> : Boss • Bravo • Ciao • Grillo • Si • Superbravo	(R.O. 103614)
10 015 1260	Misura: BK0912 Mozz ruota post. • <i>Rear wheel axle</i> : Boss • Bravo • Ciao • Grillo • Si • Superbravo	(R.O. 103613)
10 015 1270	Misura: HK Ø 17x12 Mozz ruota post. • <i>Rear wheel axle</i> : Bravo • Ciao • Grillo • Si	(R.O. 103696)
10 015 1280	Misura: HK Ø 14x12 Mozz ruota post. • <i>Rear wheel axle</i> : Boss • Grillo • Si Albero secondari: Vespa FL2 Aut. • Vespa Pk Aut. • Vesp Pk XL Plurimatic Dispositivo anti rollio Mp3 Ibrido 125 • Mp3 Mic 250 • Mp3 300	(R.O. 122671)
10 015 1290	Misura: HK Ø 16x16 Mozz ruota post. • <i>Rear wheel axle</i> : Vespa Px • Pe	(R.O. 174710)
GABBIE A RULLI - ROLLER CAGES		
10 015 0010	"DURKOP" per spinotto • <i>for piston pin</i> Ø 10x14x13 adatt. a: APRILIA : Amico • Sr • Scarabeo • HONDA : Vision • MALAGUTI : F10 • 12 Centro • MBK : Booster • Active Sorriso • Evolis • Fizz PEUGEOT : Rapido • Metropolis • SUZUKI : Cs • Cp 50 • YAMAHA : Ct 50 • Jog • Breeze	
10 015 0050	"DURKOP" per spinotto • <i>for piston pin</i> Ø 10x13x14,5 Ciao • Si	(R.O. 500521)
10 015 0150	"DURKOP" per spinotto • <i>for piston pin</i> Ø 12x15x15 Fantic • Minarelli • Benelli	
10 015 0250	"DURKOP" per spinotto • <i>for piston pin</i> Ø 12x17x15 Vespa	
10 015 0300	"DURKOP" per spinotto • <i>for piston pin</i> Ø 12x17x13 Vespa PK 50/XL - Sfera	(R.O. 500501)
10 015 0400	"DURKOP" per spinotto • <i>for piston pin</i> Ø 15x19x20 Vespa ET3/PX/PK - Sachs	(R.O. 500541)
10 015 0450	"DURKOP" per spinotto • <i>for piston pin</i> Ø 16x20x20 FBM 125 - Ape	(R.O. 500511)
10 015 0500	"DURKOP" per spinotto • <i>for piston pin</i> Ø 18x23x20 Ape MP / TM / Car	(R.O. 500531)
GABBIA A RULLI INGRANAGGIO AVVIAMENTO - ROLLER CAGE STARTER GEAR		
10 015 0600	MALAGUTI - MBK - YAMAHA 50	

KIT REVISIONE ALBERO MOTORE 50-125-150-200-250 CC
CRANKSHAFT SERVICING KIT 50-125-150-200-250 CC



10 020 0770 

PIAGGIO: Ape 50

1	Cuscinetto - <i>Bearing</i> SKF	17-47-14	
1	Cuscinetto - <i>Bearing</i> SKF	20-47-14	
1	Paraolio - <i>Oil seal</i>	22,7-47-7/7,5	
1	Paraolio - <i>Oil seal</i>	20-32-7	

10 020 0760 

PIAGGIO: Vespa Et3 • Primavera 125

1	Cuscinetto - <i>Bearing</i> SKF	17-47-14	
1	Cuscinetto - <i>Bearing</i> SKF	20-47-14	
1	Paraolio - <i>Oil seal</i>	22,7-47-7/7,5	
1	Paraolio - <i>Oil seal</i>	19-32-7	

10 020 0780 

PIAGGIO: Ciclomotore

2	Cuscinetti - <i>Bearings</i> SKF	15-35-11	
1	Paraolio - <i>Oil seal</i>	15-24-5	

10 020 0682 

PIAGGIO SCOOTER 125: Vespa Et4

2	Cuscinetti - <i>Bearings</i> NTN Gabbia acciaio - <i>Steel cage</i>	25-68-12	
1	Paraolio - <i>Oil seal</i>	18-28-7	
1	Paraolio - <i>Oil seal</i>	22-32-7	

10 020 0743 

PIAGGIO: Vespa GL • Sprint-Super • Gtr 150

2	Cuscinetti - <i>Bearings</i>	25-62-12	
1	Paraolio - <i>Oil seal</i>	20-40/60-6	
1	Paraolio - <i>Oil seal</i>	20-62-6,5	

10 020 0692 

HONDA 125-150: Sh

1	Cuscinetto - <i>Bearing</i> NTN Gabbia acciaio - <i>Steel cage</i>	35-72-17	
1	Cuscinetto - <i>Bearing</i> NTN Gabbia acciaio - <i>Steel cage</i>	35-72-15	
1	Paraolio - <i>Oil seal</i>	20,8-53-6,9	

10 020 0702 

SUZUKI 125-150: Epicuro 99-01 • Burgman 02-08 • Sixteen 08
200: Burgman 07-08 • **250:** Burgman 98-06 • **400:** Burgman 99-08

2	Cuscinetti - <i>Bearings</i> NTN Gabbia acciaio - <i>Steel cage</i>	35-72-17	
1	Paraolio - <i>Oil seal</i>	34-52-5,8	

10 020 0712 

GILERA 125-180: Runner 2T 97-02 • **125:** Typhoon X • Xr 95-00
PIAGGIO 125-150: Hexagon 94-97 • **125-180:** Hexagon Lx • Lxt 98-99
125-150: Skipper 94-97 • Lx 98-99

2	Cuscinetti - <i>Bearings</i> NTN Gabbia acciaio - <i>Steel cage</i>	25-68-12	
2	Paraolio - <i>Oil seal</i>	24-35-7	



KIT REVISIONE ALBERO MOTORE 50-125-150-200-250 CC
CRANKSHAFT SERVICING KIT 50-125-150-200-250 CC

10 020 0300

GILERA PIAGGIO SCOOTER 50

2	Cuscinetti - Bearings SKF gabbia in Nylon <i>Polyamid cage</i>	20-52-12	
1	Paraolio - <i>Oil seal</i>	18-28-7	
1	Paraolio - <i>Oil seal</i>	19-30-7	

10 020 0310

GILERA PIAGGIO SCOOTER 50

2	Cuscinetti - Bearings SKF Gabbia in Acciaio - <i>Steel cage</i>	20-52-12	
1	Paraolio - <i>Oil seal</i>	18-28-7	
1	Paraolio - <i>Oil seal</i>	19-30-7	

10 020 0312

GILERA PIAGGIO SCOOTER 50

2	Cuscinetti - Bearings NTN Gabbia acciaio - <i>Steel cage</i>	20-52-12	
1	Paraolio - <i>Oil seal</i>	18-28-7	
1	Paraolio - <i>Oil seal</i>	19-30-7	

10 020 0492

MINARELLI-MBK-YAMAHA 50

2	Cuscinetti - Bearings NTN Gabbia acciaio - <i>Steel cage</i>	20-47-14	
1	Paraolio - <i>Oil seal</i>	20-30/33,5-5,3-6	
1	Paraolio - <i>Oil seal</i>	20-42/43-8/9	

10 020 0320

MINARELLI - YAMAHA 50

2	Cuscinetti - Bearings SKF Gabbia in Nylon-Polyamid <i>cage</i>	20-47-14	
1	Paraolio - <i>Oil seal</i>	20-30/33,5-5,3-6	
1	Paraolio - <i>Oil seal</i>	20-42/43-8-9	

10 020 0340

MINARELLI-MBK-YAMAHA 50

2	Cuscinetti - Bearings KOYO Gabbia acciaio - <i>Steel cage</i>	20-47-14	
1	Paraolio - <i>Oil seal</i>	20-30/33,5-5,3/6	
1	Paraolio - <i>Oil seal</i>	20-42/43-8/9	

10 020 0560

MOTORI MINARELLI 50: Am 345-Am6

2	Cuscinetti - Bearings SKF SKF 6303 TN9C3	17-47-14	
1	Paraolio - <i>Oil seal</i>	17-35-8	
1	Paraolio - <i>Oil seal</i>	24-35-7	

10 020 0400

MOTORI - F. MORINI - APRILIA - ITALJET - MALAGUTI - SUZUKI

1	Cuscinetto - Bearing SKF 6204TN9 - C4HLHT23 Gabbia in Nylon - <i>Polyamid cage</i>	20-47-14	
1	Cuscinetto - Bearing SKF BB1-3056C Gabbia in Acciaio - <i>Steel cage</i>	25-52-13	
1	Paraolio - <i>Oil seals</i>	17-27-6	
1	Paraolio - <i>Oil seals</i>	25-37-6	
1	Paraolio - <i>Oil seals</i>	24-43-6	

KIT REVISIONE ALBERO MOTORE 50-125-150-200-250 CC

CRANKSHAFT SERVICING KIT 50-125-150-200-250 CC



10 020 0610

PEUGEOT 50: Buxy 94-97 • Elyseo 99 • Looxor 01-03 • Metal X 02 • Speedake 95-97 • Speed Fight acqua/aria 97-98 • Aria Kat 99 • Squab 95-97 • Sv Geo 91-95 • Trekker 98-00 • Vivacity 99 • Kat 99-02 • Vsx-Xr02-04 • X Fight 00 • X Race 03 • Zenith L 94-96 • Ln-Ls-N 97-98

2	Cuscinetti - <i>Bearings</i> SKF	20-52-12	
1	Paraolio - <i>Oil seals</i>	15,6-25,6-7	
1	Paraolio - <i>Oil seals</i>	20-30-7	

10 020 0620

PEUGEOT 50: Speed Fight 2 aria • 2LC307WRC • Silver 05-06 • TRK2WRC 04-06

1	Cuscinetto - <i>Bearing</i> SKF 6204 C4 MT Gabbia acciaio <i>Steel cage</i>	20-47-14	
1	Cuscinetto - <i>Bearing</i> SKF BB1 3055B Gabbia acciaio <i>Steel cage</i>	20-52-12	
1	Paraolio - <i>Oil seals</i>	15,6-25,6-7	
1	Paraolio - <i>Oil seals</i>	20-30-7	

10 020 0750

PIAGGIO 50-90: Vespa V5AI-V5A2T-V5BIT-V5B3T-V9AI

1	Cuscinetto - <i>Bearing</i> SKF	17-47-14	
1	Cuscinetto - <i>Bearing</i> SKF	20-47-14	
1	Paraolio - <i>Oil seals</i>	22,7-47-7/7.5	
1	Paraolio - <i>Oil seals</i>	19-32-7	

10 020 0730

PIAGGIO: Vespa Px-Pe 125-150-200

1	Cuscinetto - <i>Bearing</i> SKF Gabbia acciaio - <i>Steel cage</i>	25-62-12	
1	Cuscinetto - <i>Bearing</i>	25-38-15	
1	Paraolio - <i>Oil seals</i>	24-35-6	
1	Paraolio - <i>Oil seals</i>	31-62-4.3/5.8	

10 020 0740

PIAGGIO: Vespa Px-Pe 125-150-200

1	Cuscinetto - <i>Bearing</i> Gabbia acciaio - <i>Steel cage</i>	25-62-12	
1	Cuscinetto - <i>Bearing</i>	25-38-15	
1	Paraolio - <i>Oil seals</i>	24-35-6	
1	Paraolio - <i>Oil seals</i>	31-62-4.3/5.8	

10 020 0743

PIAGGIO: Vespa GL-Sprint-Super-Gtr 150

2	Cuscinetti - <i>Bearings</i>	25-62-12	
1	Paraolio - <i>Oil seals</i>	20-40/60-6	
1	Paraolio - <i>Oil seals</i>	20-62-6,5	

10 020 0790

PIAGGIO 50: Vespa Pk XL V5X3

1	Cuscinetto - <i>Bearing</i> SKF	17-47-14	
1	Cuscinetto - <i>Bearing</i> SKF	20-47-14	
1	Paraolio - <i>Oil seals</i>	22,7-47-7/7.5	
1	Paraolio - <i>Oil seals</i>	20-47-14	

10 020 0810

PIAGGIO 50: Vespa

1	Cuscinetto - <i>Bearing</i>	20-47-14	
1	Cuscinetto - <i>Bearing</i>	17-47-14	
1	Paraolio - <i>Oil seals</i>	22,7-47-7/7,5	
1	Paraolio - <i>Oil seals</i>	19-32-7	
1	Paraolio - <i>Oil seals</i>	27-37-7	
1	Anello - <i>O Ring</i>	15,88-2,62	
1	Anello - <i>O Ring</i>	6,75-2	
2	Anello - <i>O Ring</i>		
1	Anello - <i>O Ring</i>	8,73-1,78	



KIT REVISIONE ALBERO MOTORE 50-125-150-200-250 CC
CRANKSHAFT SERVICING KIT 50-125-150-200-250 CC

10 020 0820 

PIAGGIO 50-125: Vespa Pk

1	Cuscinetto - Bearing	20-47-14
1	Cuscinetto - Bearing	17-47-14
1	Paraolio - Oil Seal	22,7-47-7/7,5
1	Paraolio - Oil Seal	20-32-7
1	Paraolio - Oil Seal	27-37-7
1	Anello - O Ring	15,88-2,62
1	Anello - O Ring	6,75-2
2	Anello - O Ring	
1	Anello - O Ring	8,73-1,78



10 020 0830 

PIAGGIO 125: Vespa Primavera Et3

1	Cuscinetto - Bearing	20-47-14
1	Cuscinetto - Bearing	17-47-14
1	Paraolio - Oil seal	22,7-47-7/7,5
1	Paraolio - Oil seal	19-32-7
1	Paraolio - Oil seal	30-47-6
1	Anello - O Ring	15,88-2,62
1	Anello - O Ring	6,75-2
2	Anello - O Ring	
1	Anello - O Ring	8,73-1,78



10 020 0840 

PIAGGIO 125-150-200: Vespa Px

1	Cuscinetto - Bearing	25-38-15
1	Cuscinetto - Bearing	25-62-12
1	Paraolio - Oil seal	24-35-6
1	Paraolio - Oil seal	31-62-4,3/5,8
1	Paraolio - Oil seal	27-47-6
1	Anello - O Ring	15,88-2,62
1	Anello - O Ring	6,75-2
1	Anello - O Ring	11,11-1,78
1	Anello - O Ring	123-2,1



10 020 0850 

PIAGGIO: Vespa Sprint GL

2	Cuscinetti - Bearings	25-62-12
1	Paraolio - Oil seal	20-62-6,5
1	Paraolio - Oil seal	20-40/60-6
1	Paraolio - Oil seal	27-37-7
1	Anello - O Ring	15,88-2,62
1	Anello - O Ring	6,75-2
1	Anello - O Ring	11,11-1,78
1	Anello - O Ring	123-2,1



10 020 0860 

PIAGGIO: Vespa Pxe Arcobaleno

1	Cuscinetto - Bearing	25-38-15
1	Cuscinetto - Bearing	25-62-12
1	Paraolio - Oil seal	31-62-4,3/5,8
1	Paraolio - Oil seal	24-35-6
1	Paraolio - Oil seal	30-47-6
1	Anello - O Ring	15,88-2,62
1	Anello - O Ring	6,75-2
1	Anello - O Ring	11,11-1,78
1	Anello - O Ring	123-2,1





APRILIA

10 064 1010

APPLICAZIONI - APPLICATIONS	COMPOSIZIONE - COMPOSITION	MISURE - MEASURES	Q.tà	CODICE - RMS CODE
50: Amico SR 94 Motori Minarelli MY Raffreddati ad aria Motori Minarelli MA Raffreddati a liquido <i>Minarelli engine MY aircooled</i> <i>Minarelli engine MA liquid cooled</i> (Confezione 5 pz - Packaging 5 pcs)	Albero motore lato volano - <i>Flywheel side</i>	20x30/33.5x5.3/6	1	10 066 1900
	Statore volano - <i>Flywheel</i>	19x26x5	1	
	Albero motore lato frizione - <i>Clutch side</i>	20x42/43x8/9	1	10 066 2300
	Albero primario - <i>Drive shaft</i>	17x28x5.5	1	10 066 0870
	Puleggia frizione posteriore mobile - <i>Rear Pulley</i>	33x39x4	2	
	Albero trasmissione ruota posteriore <i>Rear wheel shaft</i>	22x32x6	1	
	O-Ring motorino avviamento - <i>Starter Motor</i>	21.95x1.78	1	
	O-Ring puleggia frizione posteriore mobile - <i>Rear Pulley</i>	37.82x1.78	2	
	O-Ring tappo olio motore - <i>Oil tank</i>	13.8x2.4	1	
	Ruota anteriore - <i>Front wheel</i>	40x52x6	1	
Ruota anteriore - <i>Front wheel</i>	20x35x7/11	1		

GILERA

10 064 0020

APPLICAZIONI - APPLICATIONS	COMPOSIZIONE - COMPOSITION	MISURE - MEASURES	Q.tà	CODICE - RMS CODE
50: Stalker - Runner (Confezione 5 pz - Packaging 5 pcs)	Albero motore lato volano - <i>Flywheel side</i>	18x28x7	1	10 066 1400
	Albero motore lato frizione - <i>Clutch side</i>	19x30x7	1	10 066 1600
	Puleggia frizione posteriore mobile - <i>Rear Pulley</i>	34x39x3	2	
	Albero primario - <i>Drive shaft</i>	17x28x5	1	
	Albero ruota posteriore - <i>Rear Wheel Shaft</i>	30x47x6	1	10 066 5500
	O-Ring puleggia frizione posteriore mobile - <i>Rear Pulley</i>	39,5x2	2	
	O-Ring frizione anteriore - <i>Front rear pulley</i>	88,62x1,78	1	
	O-Ring tappo olio - <i>O-Ring Oil</i>	11x1,9	1	

HONDA

10 064 1300

APPLICAZIONI - APPLICATIONS	COMPOSIZIONE - COMPOSITION	MISURE - MEASURES	Q.tà	CODICE - RMS CODE
50: Sky - Sh 96 - X8r (Confezione 10 pz - Packaging 10 pcs)	Albero motore lato volano - <i>Flywheel side</i>	15x30x7	1	
	Albero motore lato frizione - <i>Clutch side</i>	20x31x7	1	10 066 1950
	Albero primario - <i>Drive shaft</i>	17x30x6	1	
	Albero ruota posteriore - <i>Rear Wheel Shaft</i>	26x42x7	1	
	Puleggia frizione posteriore mobile - <i>Rear Pulley</i>	34x39x3	2	
	O-Ring puleggia frizione posteriore - <i>Rear Pulley</i>	36x1,5	1	
	O-Ring puleggia frizione posteriore mobile - <i>Rear Pulley</i>	39,8x2,2	1	
	O-Ring pompa olio - <i>Oil Pump</i>	18,3x2,3	1	
	O-Ring collettore aspirazione - <i>Inlet Pipes</i>	20,6x1,9	1	



SERIE PARAOLIO MOTORE - RICERCA PER MARCA
OIL SEAL KIT - ALPHABETICAL ORDER

MALAGUTI

10 064 1010 

APPLICAZIONI - APPLICATIONS	COMPOSIZIONE - COMPOSITION	MISURE - MEASURES	Q.tà	CODICE - RMS CODE
50: F10 - F12 Phantom Centro SL Raffr. Aria - F12 - F15 Raffr. Acqua (Confezione 5 pz - Packaging 5 pcs)	Albero motore lato volano - <i>Flywheel side</i>	20x30/33.5x5.3/6	1	10 066 1900
	Statore volano - <i>Flywheel</i>	19x26x5	1	
	Albero motore lato frizione - <i>Clutch side</i>	20x42/43x8/9	1	10 066 2300
	Albero primario - <i>Drive shaft</i>	17x28x5.5	1	10 066 0870
	Puleggia frizione posteriore mobile - <i>Rear Pulley</i>	33x39x4	2	
	Albero trasmissione ruota posteriore <i>Rear wheel shaft</i>	22x32x6	1	
	O-Ring motorino avviamento - <i>Starter Motor</i>	21.95x1.78	1	
	O-Ring puleggia frizione posteriore mobile - <i>Rear Pulley</i>	37.82x1.78	2	
	O-Ring tappo olio motore - <i>Oil tank</i>	13.8x2.4	1	
	Ruota anteriore - <i>Front wheel</i>	40x52x6	1	
	Ruota anteriore - <i>Front wheel</i>	20x35x7/11	1	

MBK

10 064 1010 

APPLICAZIONI - APPLICATIONS	COMPOSIZIONE - COMPOSITION	MISURE - MEASURES	Q.tà	CODICE - RMS CODE
50: Booster (Confezione 5 pz - Packaging 5 pcs)	Albero ero motore lato volano - <i>Flywheel side</i>	20x30/33.5x5.3/6	1	10 066 1900
	Statore volano - <i>Flywheel</i>	19x26x5	1	
	Albero motore lato frizione - <i>Clutch side</i>	20x42/43x8/9	1	10 066 2300
	Albero primario - <i>Drive shaft</i>	17x28x5.5	1	10 066 0870
	Puleggia frizione posteriore mobile - <i>Rear Pulley</i>	33x39x4	2	
	Albero trasmissione ruota posteriore <i>Rear wheel shaft</i>	22x32x6	1	
	O-Ring motorino avviamento - <i>Starter Motor</i>	21.95x1.78	1	
	O-Ring puleggia frizione posteriore mobile - <i>Rear Pulley</i>	37.82x1.78	2	
	O-Ring tappo olio motore - <i>Oil tank</i>	13.8x2.4	1	
	Ruota anteriore - <i>Front wheel</i>	40x52x6	1	
	Ruota anteriore - <i>Front wheel</i>	20x35x7/11	1	

PIAGGIO

10 064 0010 

APPLICAZIONI - APPLICATIONS	COMPOSIZIONE - COMPOSITION	MISURE - MEASURES	Q.tà	CODICE - RMS CODE
50: Vespa ET2 (Confezione 5 pz - Packaging 5 pcs)	Albero motore lato volano - <i>Flywheel side</i>	18x28x7	1	10 066 1400
	Albero motore lato frizione - <i>Clutch side</i>	19x30x7	1	10 066 1600
	Puleggia frizione posteriore mobile - <i>Rear Pulley</i>	34x39x3	2	
	Albero primario - <i>Drive shaft</i>	22x40x7	1	
	Albero ruota posteriore - <i>Rear Wheel Shaft</i>	30x47x6	1	10 066 5500
	O-Ring puleggia frizione posteriore mobile - <i>Rear Pulley</i>	39,5x2	2	
	O-Ring frizione anteriore - <i>Front Pulley</i>	77,5x1,5	1	



PIAGGIO

10 064 0050 

APPLICAZIONI - APPLICATIONS	COMPOSIZIONE - COMPOSITION	MISURE - MEASURES	Q.tà	CODICE - RMS CODE
50: Sfera '91-Zip '92 Raffr. Aria (Confezione 10 pz - <i>Packaging 10 pcs</i>)	Albero motore lato volano - <i>Flywheel side</i>	18x28x7	1	10 066 1400
	Albero motore lato frizione - <i>Clutch side</i>	19x30x6	1	10 066 1600
	Puleggia frizione posteriore mobile - <i>Rear Pulley</i>	40x47x4	2	10 066 8500
	Albero primario - <i>Drive shaft</i>	22x40x7	1	
	Albero ruota posteriore - <i>Rear Wheel Shaft</i>	30x47x6	1	10 066 5500

10 064 0060 

APPLICAZIONI - APPLICATIONS	COMPOSIZIONE - COMPOSITION	MISURE - MEASURES	Q.tà	CODICE - RMS CODE
50: Zip '93-95-Free '92-Quartz '92-Sfera-Nrg - Ntt (Confezione 5 pz - <i>Packaging 5 pcs</i>)	Albero motore lato volano - <i>Flywheel side</i>	18x28x7	1	10 066 1400
	Albero motore lato frizione - <i>Clutch side</i>	19x30x7	1	10 066 1600
	Puleggia frizione posteriore mobile - <i>Rear Pulley</i>	34x39x3	2	
	Albero primario - <i>Drive shaft</i>	22x40x7	1	
	Albero ruota posteriore - <i>Rear Wheel Shaft</i>	30x47x6	1	10 066 5500
	Albero pompa acqua - <i>Water Pump shaft</i>	8x16x10/11	1	10 066 0050
	O-Ring puleggia frizione posteriore mobile <i>Rear Pulley</i>		2	
	O-Ring frizione anteriore - <i>Front Pulley</i>		1	

10 064 0080 

APPLICAZIONI - APPLICATIONS	COMPOSIZIONE - COMPOSITION	MISURE - MEASURES	Q.tà	CODICE - RMS CODE
50: Liberty (Confezione 1 pz - <i>Packaging 1 pc</i>)	Albero motore lato volano - <i>Flywheel side</i>	18x28x7	1	10 066 1400
	Albero motore lato frizione - <i>Clutch side</i>	19x30x7	1	10 066 1600
	Puleggia frizione posteriore mobile - <i>Rear Pulley</i>	34x39x3	2	
	Albero primario - <i>Drive shaft</i>	17x28x6	1	
	Albero ruota posteriore - <i>Rear Wheel Shaft</i>	30x47x6	1	10 066 5500
	O-Ring puleggia frizione posteriore mobile - <i>Rear Pulley</i>	39,5x2	2	
	O-Ring frizione anteriore - <i>Front Pulley</i>	88,62x1,78	1	
O-Ring tappo olio motore - <i>Oil Tank</i>	11x1,9	1		

10 064 0100 

APPLICAZIONI - APPLICATIONS	COMPOSIZIONE - COMPOSITION	MISURE - MEASURES	Q.tà	CODICE - RMS CODE
125: Vespa ET4 (Confezione 1 pz - <i>Packaging 1 pc</i>)	Albero motore lato volano - <i>Flywheel side</i>	18x28x7	1	10 066 1400
	Albero motore lato frizione - <i>Clutch side</i>	22x32x7	1	10 066 2430
	Albero primario - <i>Drive shaft</i>	22.7x47.05x7.5/7	1	
	Albero ruota posteriore - <i>Rear Wheel Shaft</i>	30x47x6	1	10 066 5500
	O-Ring filtro olio - <i>Oil Filter</i>		1	
	O-Ring raccordo filtro olio - <i>Oil Filter Connection</i>		1	
	O-Ring coperchio pompa olio - <i>Oil Pump Cover</i>		1	
	O-Ring puleggia frizione posteriore Fissa - <i>Rear Pulley</i>		1	
	O-Ring filtro olio - <i>Oil Filter</i>		2	
	O-Ring frizione anteriore - <i>Front Pulley</i>		1	
	O-Ring tappo introduzione olio - <i>Oil tank</i>		1	



SERIE PARAOLIO MOTORE - RICERCA PER MARCA
OIL SEAL KIT - ALPHABETICAL ORDER

PIAGGIO

10 064 0110 

APPLICAZIONI - APPLICATIONS	COMPOSIZIONE - COMPOSITION	MISURE - MEASURES	Q.tà	CODICE - RMS CODE
50-90-125: Vespa Primavera 50-125: Et3-Pk (Confezione 10 pz - Packaging 10 pcs)	Albero motore lato volano - <i>Flywheel side</i>	19x32x7	1	10 066 1700
	Albero motore lato frizione - <i>Clutch side</i>	22.7x47x7/7.5	1	10 066 2700
	Albero ruota posteriore - <i>Rear Wheel Shaft</i>	27x37x7	1	10 066 4500
	Anelli O-Ring		6	

10 064 0130 

APPLICAZIONI - APPLICATIONS	COMPOSIZIONE - COMPOSITION	MISURE - MEASURES	Q.tà	CODICE - RMS CODE
50: Vespa Pk XL-FL2 (Confezione 10 pz - Packaging 10 pcs)	Albero motore lato volano - <i>Flywheel side</i>	20X32x7	1	10 066 2000
	Albero motore lato frizione - <i>Clutch side</i>	22.7x47x7/7.5	1	10 066 2700
	Albero ruota posteriore - <i>Rear Wheel Shaft</i>	27x37x7	1	10 066 4500
	Anelli O-Ring		6	

10 064 0140 

APPLICAZIONI - APPLICATIONS	COMPOSIZIONE - COMPOSITION	MISURE - MEASURES	Q.tà	CODICE - RMS CODE
150: Vespa GL - Sprint (Confezione 1 pz - Packaging 1 pcs)	Albero motore lato frizione - <i>Clutch side</i>	20x40/60x56	1	
	Albero motore lato volano - <i>Flywheel side</i>	20x62x6,5	1	10 066 2360
	Albero ruota posteriore - <i>Rear Wheel Shaft</i>	27x37x7	1	10 066 4500

10 064 0160 

APPLICAZIONI - APPLICATIONS	COMPOSIZIONE - COMPOSITION	MISURE - MEASURES	Q.tà	CODICE - RMS CODE
125-150: Vespa Px TS 200: Pe (Confezione 10 pz - Packaging 10 pcs)	Albero motore lato volano - <i>Flywheel side</i>	24x35x6	1	10 066 3000
	Albero motore lato frizione - <i>Clutch side</i>	31x62x4.3/5.8	1	10 066 6060
	Albero ruota posteriore - <i>Rear Wheel Shaft</i>	27x47x6	1	10 066 4800

10 064 0180 

APPLICAZIONI - APPLICATIONS	COMPOSIZIONE - COMPOSITION	MISURE - MEASURES	Q.tà	CODICE - RMS CODE
125: Vespa T5 Cosa (Confezione 1 pz - Packaging 1 pcs)	Albero motore lato volano - <i>Flywheel side</i>	24x35x6	1	10 066 3000
	Albero motore lato frizione - <i>Clutch side</i>	31x62x4.3/5.8	1	10 066 6000
	Albero ruota posteriore - <i>Rear Wheel Shaft</i>	27x42x10	1	10 066 4700

10 064 0170 

APPLICAZIONI - APPLICATIONS	COMPOSIZIONE - COMPOSITION	MISURE - MEASURES	Q.tà	CODICE - RMS CODE
125-150-200: Vespa-Px-Pe Arcobaleno (Confezione 10 pz - Packaging 10 pcs)	Albero motore lato volano - <i>Flywheel side</i>	24x35x6	1	10 066 3000
	Albero motore lato frizione - <i>Clutch side</i>	31x62x4.3/5.8	1	10 066 6000
	Albero ruota posteriore - <i>Rear Wheel Shaft</i>	30x47x6	1	10 066 5500



PIAGGIO

10 064 0200 

APPLICAZIONI - APPLICATIONS	COMPOSIZIONE - COMPOSITION	MISURE - MEASURES	Q.tà	CODICE - RMS CODE
125-150: Hexagon (Confezione 1 pz - Packaging 1 pcs)	Albero motore - <i>Crankshaft</i>	24x35x7	2	10 066 3050
	Albero primario - <i>Drive shaft</i>	22.7x47x7/7.5	1	10 066 2700
	Albero ruota posteriore - <i>Rear Wheel Shaft</i>	30x47x6	1	10 066 5500
	Albero pompa acqua - <i>Water Pump Shaft</i>	8x16x10/11	1	10 066 0050
	O-Ring puleggia frizione - <i>Pulley</i>	21,9x2.62	1	
	O-Ring candela - <i>Spark plug</i>	13x1,8	1	
	Anelli O-Ring	23,47x2,62	1	

10 064 0250 

APPLICAZIONI - APPLICATIONS	COMPOSIZIONE - COMPOSITION	MISURE - MEASURES	Q.tà	CODICE - RMS CODE
125-150-200: Vespa Px Arcobaleno (Confezione 10 pz - Packaging 10 pcs)	Albero motore lato volano - <i>Flywheel side</i>	24x35x6	1	10 066 3000
	Albero motore lato frizione struttura Metallo <i>Clutch side metal frame</i>	31x62x4,3/5/8	1	10 066 6010
	Albero ruota posteriore - <i>Rear Wheel Shaft</i>	30x47x6	1	10 066 5500

10 064 0260 

Blue

APPLICAZIONI - APPLICATIONS	COMPOSIZIONE - COMPOSITION	MISURE - MEASURES	Q.tà	CODICE - RMS CODE
125-150-200: Vespa Px (Confezione 10 pz - Packaging 10 pcs)	Albero motore lato volano - <i>Flywheel side</i>	24x35x6	1	
	Albero motore lato frizione struttura Metallo <i>Clutch side metal frame</i>	31x62x4,3/5/8	1	
	Albero ruota posteriore - <i>Rear Wheel Shaft</i>	27x47x6	1	

10 064 0270 

Blue

APPLICAZIONI - APPLICATIONS	COMPOSIZIONE - COMPOSITION	MISURE - MEASURES	Q.tà	CODICE - RMS CODE
125-150-200: Vespa Px Arcobaleno (Confezione 10 pz - Packaging 10 pcs)	Albero motore lato volano - <i>Flywheel side</i>	24x35x6	1	
	Albero motore lato frizione struttura Metallo <i>Clutch side metal frame</i>	31x62x4,3/5/8	1	
	Albero ruota posteriore - <i>Rear Wheel Shaft</i>	30x47x6	1	

YAMAHA

10 064 1080 

APPLICAZIONI - APPLICATIONS	COMPOSIZIONE - COMPOSITION	MISURE - MEASURES	Q.tà	CODICE - RMS CODE
MOTORI MINARELLI: Scooter 50 (Confezione 10 pz - Packaging 10 pcs)	Paraolio doppia tenuta - <i>Oil Seal special watertight</i>	10-18-5/8	1	
	Anello O-Ring	53,7x1,78	1	



PARAOLIO - RICERCA PER MISURA

OIL SEALS - SEARCH BY SIZE

MISURE SIZE	CODICE CODE	BARCODE	DESCRIZIONE DESCRIPTION	APPLICAZIONI APPLICATIONS	RIF. ORIGINALE OEM NUMBER
8-16-10/11	10 066 0050		Pompa Acqua - <i>Water Pump</i>	Aprilia-Piaggio-Gilera 50 cc	4352035
10-18-4	10 066 0200		Pompa Acqua - <i>Water Pump</i>	Motori Minarelli - Aprilia - Malaguti	-
15-24-5	10 066 0400		Albero Motore - <i>Crankshaft</i>	Piaggio: Ciao - Si - Bravo - Boss	480464
15.6-25.6-7	10 066 0600		Albero Motore - <i>Crankshaft</i>	Peugeot Kymco 50 cc	711824 0109018
17-27-6	10 066 0780		Albero Motore Lato Volano - <i>Flywheel Side</i>	Motori F. Morini Malaguti 50 cc	60118400
17-28-5.5	10 066 0870		Puleggia Fissa - Albero Primario <i>Fixed Pulley - Drive Shaft</i>	Mbk-Yamaha-Malaguti	931021734200 75311700
17-35-8	10 066 1080		Applicazioni Varie - <i>Various</i>	Applicazioni Varie	-
17-35-8	10 066 1090		Albero Motore Lato Volano - <i>Flywheel Side</i>	Fbm	-
18-28-7/7.5	10 066 1400		Albero Motore Lato Volano - <i>Flywheel Side</i>	Aprilia-Piaggio-Gilera 50 cc	482315
18-28-7/7.5	10 066 1420 Viton		Albero Motore Lato Volano - <i>Flywheel Side</i>	Aprilia-Piaggio-Gilera 50 cc	482315
19-30-7	10 066 1600		Albero Motore Lato Frizione - <i>Clutch Side</i>	Aprilia-Piaggio-Gilera 50 cc	482314
19-30-7	10 066 1610 Viton		Albero Motore Lato Frizione - <i>Clutch Side</i>	Aprilia-Piaggio-Gilera 50 cc	482314
19-32-7	10 066 1700		Albero Motore Lato Volano - <i>Flywheel Side</i>	Piaggio Vespa	430390 - 155579
19-32-7	10 066 1710 Blue		Albero Motore Lato Volano - <i>Flywheel Side</i>	Piaggio Vespa	430390 - 155579
19 - 32 - 7	10 066 1712 ROLF		Albero Motore Lato Volano - <i>Flywheel Side</i>	Piaggio Vespa 50-90 Primavera Et3 V5a1- V5b1-V5b2-V5sa1-V9a1-Vma2-Vmb1	155579
20 - 30 - 7	10 066 1850		Albero Motore Lato Frizione - <i>Clutch Side</i>	Peugeot	706450
20 - 30 - 7	10 066 1860 Viton		Albero Motore Lato Volano - <i>Flywheel Side</i>	Piaggio 125 4T: Fly - Liberty - Vespa 150 4T: Liberty-Vespa	82898R
20 -30/33.5- 5.3/6	10 066 1900		Albero Motore Lato Volano - <i>Flywheel Side</i>	Motori Minarelli Aprilia-Mbk -Yamaha	AP8206212 931012013800
20-31-7	10 066 1950 Viton		Albero Motore Lato Frizione - <i>Clutch Side</i>	Kymco 50 2T	00109139
20 -32 -7	10 066 2000		Albero Motore Lato Volano - <i>Flywheel Side</i>	Piaggio Ape-Vespa 50	289306
20 - 32 - 7	10 066 2202 ROLF		Albero Motore Lato Volano - <i>Flywheel Side</i>	Piaggio Vespa 50 Pk XL-N-FL Vn5x3T-V5x5- V5N1	289306
20 - 32 - 7	10 066 2010 Viton		Albero Trasmissione - <i>Drive shaft</i>	Piaggio 125 4T: Beverly-Carnaby-Fly-Liber- ty-Mp3-Typhoon-Vespa	82878R
20 - 40 6	10 066 2370 ROLF		Albero Motore Lato Volano - <i>Flywheel Side</i>	Piaggio Vespa 150 GL-Sprint-Super VLA- VLB-VBC Rally	084644
20-42/43-8/9	10 066 2300		Albero Motore Lato Frizione - <i>Clutch Side</i>	Mot: Minarelli- Aprilia Mbk Yamaha	AP8206213 931022037100
20-62-6,5	10 066 2360		Albero Motore Lato Frizione - <i>Clutch Side</i>	Vespa Sprint - GL 150	048290
20.8-53-6/9	10 066 2380		Albero Motore - <i>Crankshaft</i>	Honda Sh 125-150	-
22-32-7	10 066 2430		Semiasse - <i>Half Shaft</i>	Piaggio Ape Mp-Car	431044
22 - 34 - 6	10 066 2490		Albero Ruota Posteriore - <i>Rear Wheel Shaft</i>	Kymco 250 People Lc 03-04 • People S 06 • X Citing 05-07 • 300: X Citing 08-09	00125780
22-35-6	10 066 2550		Ruota Posteriore - <i>Rear Wheel</i>	Piaggio Ciao I Serie	58752
22-45-7	10 066 2650		Applicazioni Varie - <i>Various</i>	Applicazioni Varie	-

PARAOLIO - RICERCA PER MISURA
OIL SEALS - SEARCH BY SIZE



MISURE SIZE	CODICE CODE	BARCODE	DESCRIZIONE DESCRIPTION	APPLICAZIONI APPLICATIONS	RIF. ORIGINALE OEM NUMBER
22.7-47- 7/7,5	10 066 2700		Albero Motore Lato Frizione - <i>Clutch Side</i>	Piaggio Vespa 50-125 Primavera	289305
22.7-47- 7/7,5	10 066 2710 Blue		Albero Motore Lato Frizione - <i>Clutch Side</i>	Piaggio Vespa 50-125 Primavera	289305
22,7 - 47- 7/7,5	10 066 2702 ROLF		Albero Motore Lato Frizione - <i>Clutch Side</i>	Piaggio Vespa 50-90 Primavera Et3 V5a1- V5b1-V5b2-V5sa1-V9a1-Vma2-Vmb1	008731
24-35-6	10 066 3000		Albero Motore Lato Volano - <i>Flywheel Side</i>	Piaggio Vespa Pk 125 XL-Px	431121
24 - 35 - 6	10 066 3002 ROLF		Albero Motore Lato Volano - <i>Flywheel Side</i>	Piaggio Vespa Px 125-150-200 Super 150 Vbc 1T	158962
24-35-7	10 066 3050		Albero Motore - <i>Crankshaft</i>	Gilera - Piaggio Hexagon Skipper 125	4345826
24.9-45- 5.5/6.5	10 066 3400		Albero Motore Lato Volano Esterno <i>Flywheel External</i>	Piaggio Ape Mp-P601 I Serie	078002
24.9-45- 5.5/6.5	10 066 3450		Albero Motore Lato Volano Esterno <i>Flywheel External</i>	Piaggio Ape Mp-P601 I Serie	078002
25-37-6	10 066 3600		Albero Motore Lato Frizione - <i>Clutch Side</i>	F.Morini Malaguti	60118500
25 - 40 - 8	10 066 4000		Albero Motore Lato Frizione - <i>Clutch Side</i>	Kymco 125 -150 B&w Eu2 • Dink Classic Dink • 500 Xciting I/R 05-09	00121912
27-37-7	10 066 4500		Albero Ruota Posteriore - <i>Rear Wheel Shaft</i>	Piaggio Vespa 50-Et3-Pk-GL-Sprint	046699
27-37-7	10 066 4510 Blue		Albero Ruota Posteriore - <i>Rear Wheel Shaft</i>	Piaggio Vespa 50-Et3-Pk-GL-Sprint	046699
27-42-10	10 066 4700		Ruota Posteriore - <i>Rear Wheel</i>	Piaggio Ape 50	118058
27 - 42 - 10	10 066 4702 ROLF		Ruota Posteriore - <i>Rear Wheel</i>	Piaggio Vespa Px 125-150-200 Cosa 125- T5 125 Vnx5t	118058
27 - 42 - 7	10 066 4550		Ruota Posteriore - <i>Rear Wheel</i>	Kymco 50 Agility 4T R10/R12/R16 Agility 2T R16 • 125 Agility Rs • Agility R16 250-300 People S X Citing	00108209
27-47-6	10 066 4800		Ruota Posteriore - <i>Rear Wheel</i>	Piaggio Vespa Px	130536
27 - 47 - 6	10 066 4802 ROLF		Ruota Posteriore - <i>Rear Wheel</i>	Piaggio Vespa Px 125-150-200 1 Serie- Vespa GL 150 Sprint-Rally	130536
30-47-6	10 066 5500		Albero Ruota Posteriore - <i>Rear Wheel Shaft</i>	Piaggio Vespa Px-Sfera-Zip- Et4 Gilera Runner – Stalker – Typhoon	478498 – 008714
30 - 62 - 6,5	10 066 2362 ROLF		Albero Motore Lato Frizione - <i>Clutch Side</i>	Piaggio 150 GL-Sprint-Super VLA-VLB-VBC	049290
31-62- 4.3/5.8	10 066 6000		Albero Motore Lato Frizione - <i>Clutch Side</i>	Piaggio Vespa Arcobaleno – Px	431122 – 131102
31-62- 4.3/5.8	10 066 6010		Albero Motore Lato Frizione Struttura metallo - <i>Clutch Side Metal frame</i>	Piaggio Vespa Arcobaleno – Px	242550
40-47-4	10 066 8500		Puleggia Frizione posteriore mobile - <i>Pulley</i>	Piaggio : Sfera-Zip	478269



PACCHI LAMELLARI

REED VALVES

10 056 0010



APRILIA 50: Amico cilindro verticale
Amico engines with vertical cylinder
MBK: Booster Road • NG • Spirit • Track
 Rocket • Booster 90-00
YAMAHA 50: Spy • Bw's Bump original
 • NG Kat 95-00
 (R.O. 3VLE361000)



10 056 0020



Per Motori Minarelli orizzontale
For Minarelli Engine horizontal
APRILIA 50: Scooter (R.O. 8206557)
MALAGUTI: Centro SL • Base • F10 Jet Line Yesterday • F12 Phantom Aria LC • F15 Firefox
 (R.O. 76004600)
MBK: New Sorriso • Flipper • Ovetto • Nitro • Evolis • Fizz • Forte
 (R.O. 4CUE36100000)
YAMAHA 50: Aerox R • Why • Breeze • Axis
 • Neo's 94-01
 (R.O. 4CUE36100000)



10 056 0100



GILERA 50: Runner doppio disco
Twin Discs • Dna • Ice • Typhoon 01
PIAGGIO: Nrg • Rst-Mc2 • Vespa Et2
 • Diesis • Zip Sp
 (R.O. 486353)



10 056 0110



GILERA 50: Easy Moving • Stalker • Storm
 • Typhoon 50 - X - Xr
PIAGGIO 50: Free • Free FL • Free Delivery • Nrg
 • Mc3 Extreme • Liberty • Quartz • NTT • Sfera Maquillage 2 Et2 • Zip • Zip Fd • Zip Fast Rider • Zip Fast Rider Rst • Zip Rst - SP 01 • Skr Ct 80
 (R.O. 435867)



10 056 0130



PEUGEOT 50: Ludix





12 062 0070 

PIAGGIO 150: Vespa GL • Px
125: Vespa Px
(R.O. 179803-227205)



12 062 0080 

PIAGGIO 125-150-200: Vespa Px 1° Serie
Vnx-Vlx-Vbx
(R.O. 181476)



10 062 0030 

PIAGGIO: Ape Car Mp
(R.O. 133404)



10 062 0060 

PIAGGIO 50-125: Vespa 5Et3
(R.O. 71813)



10 062 0050 

PIAGGIO 50: Vespa Pk Pk XL • Rush N • FL
(R.O.178694)



12 062 0090 

PIAGGIO 150: Vespa Sprint • GL
180: Vespa Rally
(R.O. 093766)



10 062 0041 

GILERA 50: Ice 01 • Easy Moving 95-96 • Runner 97-00 • Stalker 97-01 • Storm 94-95 Typhoon 94-97 • X 98-99 • Xr 00
125: Typhoon 95-98 • X-Xr 99-00
125-180: Runner Fx • Fxr 97-02 (Mikuni)
PIAGGIO 50: Dysis 01 • Free 92-94 • FL 95-00 • Delivery 00-01 • Ntt 95-96 • Nrg 94-96 • Rst Mc2 96-98 • Extreme 99-00 • Nrg Mc3 01-02 • Sfera base 91-93 • Maquillage 2 94 • Rst 95-97 • Typhoon 01 • Vespa Et2 97-01 • Zip base 92-96 • Rst 96-99 • Fast Rider Rst 96-97 • Zip fast Rider 93-94 • Sp 96-00
80: Skr city 99
125-150: Hexagon 94-97 • Skipper 94-97 • Lx 98-99
(R.O. 436096)



12 062 0100 

PIAGGIO 160-180: Vespa Gs
(R.O.077628)



10 062 0070 

NEW

MANICOTTO CARBURATORE - FILTRO
CARBURETOR - AIRBOX MANIFOLD
APRILIA 50: Scarabeo 00-05 • **100:** Scarabeo Mot. Minarelli 00 • Scarabeo Mot. Yamaha 00
(R.O. AP8144248)





COLLETTORI ASPIRAZIONE

INLET PIPES

10 052 0010 

APRILIA 50: Amico
MBK 50: Booster 90-01 • Road • Spirit • NG
• Rocket Track
YAMAHA 50: Spy • Bw's Bump original
• NG • Kat • Slider 95-01
(R.O. 3VLE35550000)



10 052 0020 

APRILIA: Scooter 50 motori con cilindro orizzontale - *Engine with horizontal cylinder*
(R.O. 8206466)
MALAGUTI: Centro • SL Base • F10 Jet Line
• F12 Phantom LC Aria • F15 Firefox • Yesterday
(R.O. 76004500)
MBK: Ovetto • Evolis • Fizz • Forte • Nitro
Flipper • Kat 94-01
YAMAHA 50: Aerox • R • Why Kat • Breeze
Axis • Neo's 94-01
(R.O. 4CUE35550000)



10 052 0030 

GILERA 125: Runner Fx-Fxr 97-02
Typhoon 95-98 • X - XR 99-00
180: Runner Fx - Fxr 97-02
PIAGGIO 125: Hexagon 94-97
Hexagon Lx - Lxt 98-99 • Skipper 94-97
• Lx 98-99
150: Hexagon 94-97 • Skipper 94-97 • LX 98-99
(R.O. 430206)



10 052 0040 

PIAGGIO 125: Liberty 98-00 • Vespa Et4 96-99
• Sfera 95-97
(R.O. 480799)



10 052 0050 

PIAGGIO 125-150: Liberty 00-02
• Skipper 4T 00-02 • Vespa ET4 99-02
• Zip 125 00-02
(R.O. 485587)



10 052 0100 

GILERA 50: Easy Moving • Runner • Ice • Stalker
• Storm • Typhoon • X • Xr • Dna
PIAGGIO 50: Free • Delivery • Nrg Rst • Mc2
Mc3 • Extreme • Diesis-Liberty
NTT • Sfera Rst 50 • Sfera Maquillage 2
• Et2 • Zip • Zip 95 • Zip Fast Rider
Zip Sp • Zip Rst
Zip Fast Rider Rst
Zip FD (disc brake)
80: Skr City
(R.O. 436095)



10 052 0260 

PEUGEOT 50: Ludix



10 052 0340 

MOTORI MINARELLI AM6
MINARELLI ENGINE AM6
YAMAHA 50: Dt R - Dt X 06-08 • Tzr 03-08 • Tzr
Rr 05 • Dt R - Dt Rsm 03-05
(R.O. 4YVE35653000)



10 052 0243 

SUPPORTO ELASTICO CARBURATORE
INLET HOLDER CARBURETOR
PIAGGIO: Ape - Car P2-P3 - Mp • P 501 • P 601
• TM • P602 • P703 • P703V • FL2
(R.O. 566859)

NEW



10 052 0390 

KYMCO 50: Agility 4T R16 08-12 • Super 8 07-13
(R.O. 00117075)



10 052 0350 

KYMCO 50: Dink 4T 07
(R.O. 00102054)



10 052 0360 

KYMCO 50: Agility 4T R10 06-08
(R.O. 00102048)



COLLETTORI ASPIRAZIONE

INLET PIPES



10 052 0370 

KYMCO 125: Agility 4T 06 • Movie 03-07
Agility R16 08-12 • Agility 4T 06-08 • Agility Carry
11 • Agility Rs 09 • Like 09 • Like Lx 12
150: Movie 03-07 • Agility R16 08-09
(R.O. 00122198-00117091-00122116)



10 052 0400 

KYMCO 300: Downtown I 09 • Downtown Abs
10 • People Gti 10
(R.O. 00117182 - 1711A-LEA7-E00)



10 052 0410 

KYMCO 400: X-Citing I 13-15 • X-Citing I Abs 14-15
(R.O. 00117491 - 1711A-LKF5-E00)



10 052 0420 

KYMCO 125: Downtown I 09 • K-Xct I 12-14
• People Gti 10
(R.O. 0117198 - 1711A-LFA7-E00)



10 052 0430 

KYMCO 300: Downtown Abs I 11 • Downtown I
11 • K-Xct I Abs 14 • K-Xct I 12 • People Gti Abs 12-
14 • People Gti 11-14 • Downtown I Abs 15
(R.O. 00117345 - 1711ALEA7E05)



10 052 0440 

PIAGGIO 125: Vespa Lx 4T
(R.O. 849465)

NEW



10 052 0450 

NEW

PIAGGIO 125: Vespa GT-GTV 4T
(R.O. B016579)





COLLETTORI ASPIRAZIONE - SCARICO

INLET - EXHAUST PIPES

10 052 0130



PIAGGIO: Vespa 125 Primavera
per carburatore 19/19 • 19/19 carburator
(R.O.112869)



10 052 0150



PIAGGIO: Vespa 50
per carburatore 16/10 • 16/10 carburator
(R.O. 079802)



10 052 0160



PIAGGIO: Vespa 90
per carburatore 16/16 • 16/16 carburator
(R.O. 078542)



10 052 0170



PIAGGIO: Vespa 50 Pk XL
per carburatore 16/10 • 16/10 carburator
(R.O. 480831)



10 052 0200



PIAGGIO: Vespa 125 Pk XL
FL-3 fori per carburatore 19/19
3 holes carburator 19/19
(R.O. 224755)



10 052 0220



PIAGGIO 50: Ape FL-FL2 89-95 • Ape FL3 Euro-
pa 96-99 • Ape Mix 2T 98-08 • Ape P 80-85 • Ape
Rst Mix 99-03 • Ape Tm P 85-89 • Ape 09-16
Attacco 3 Fori Ø esterno 19 mm Lunghezza 115 mm
3 Pin connection Ø 19 mm Length 115 mm
(R.O. 286889)



COLLETTORI SCARICO IN ALLUMINIO PRESSOFUSO EXHAUST ALLOY CAST PIPES

10 052 0230



PIAGGIO: Ape 250 Commerciale per motori
cc 125 Tm1T 70-74
Attacco 3 Fori Ø esterno 19 mm Lunghezza 135 mm
3 Pin connection Ø 19 mm Length 135 mm
(R.O. 127183)



10 054 0010



PIAGGIO 50-90: Vespa
125: Vespa Primavera Et3
(R.O. 247033)



10 054 0020



PIAGGIO 125: Vespa Pk
(R.O. 222208)



▶ FILTRI ARIA

AIR FILTERS

▶ **NYP**SO

▶ **CHAMPION**

▶ **UFI**



FILTRI ARIA NYPSO

NYPSO AIR FILTERS

10 060 0011 

APRILIA - (R.O. AP8201378)



10 060 0021 

APRILIA - (R.O. AP8201583)



10 060 0031 

APRILIA - (R.O. AP8201683)



10 060 0041 

APRILIA - (R.O. AP8102582)



10 060 0051 

ATALA
SUZUKI - (R.O. 13780-40D40-000)



10 060 0061 

BENELLI - (R.O. R72340011A0)
BETA - MBK - YAMAHA - (R.O. 3KJ144510000)
MALAGUTI - (R.O. 06604500)



10 060 0081 

GILERA - PIAGGIO - (R.O. 478240)



10 060 0091 

GILERA - PIAGGIO - (R.O. 433437)



10 060 0111 

GILERA - PIAGGIO - (R.O. 479748)



10 060 0121 

APRILIA - (R.O. AP8102943)
GILERA - PIAGGIO - (R.O. 480084)
ITALJET



10 060 0131 

PEUGEOT - (R.O. 705260)



10 060 0141 

HONDA - (R.O. 17205GJ4760)



10 060 0171 

HONDA - (R.O. 17205GAV700)



10 060 0201 

HONDA - (R.O. 17205GBY910)



10 060 0211 

HONDA - (R.O. 17205GBM750)





10 060 0221 

HONDA



10 060 0231 

HONDA - (R.O. 17205GBM750)



10 060 0241 

ITALJET



10 060 0261 

KYMCO - (R.O. 00166204)



10 060 0271 

KYMCO - (R.O. 00163101 + 00163013)



10 060 0281 

KYMCO - (R.O. 00163892)



10 060 0291 

MALAGUTI - (R.O. 06605500)



10 060 0301 

MALAGUTI - (R.O. 06606600)



10 060 0311 

MBK - YAMAHA - (R.O. 3VLE44510100)



10 060 0331 

BENELLI - BETA - (R.O. R72317001AZ)
MALAGUTI - (R.O. 06608100)
MBK - YAMAHA - (R.O. 4HC144510000)



10 060 0351 

MBK - YAMAHA - (R.O. 5EUE44510000)



10 060 0361 

PEUGEOT - (R.O. 724064)



10 060 0371 

PEUGEOT - (R.O. 730199)



10 060 0391 

PEUGEOT - (R.O. 727905)



10 060 0401 

PIAGGIO - (R.O. 482738)





FILTRI ARIA NYPSO

NYPSO AIR FILTERS

10 060 0411 

PIAGGIO - (R.O. 257369)



10 060 0421 

BENELLI - BETA - (R.O. R72340061AO)
ITALJET (R.O. 210436478)
PIAGGIO (R.O. 436478)



10 060 0431 

GILERA - (R.O. 834741)
PIAGGIO - (R.O. 431838)



10 060 0441 

PIAGGIO - (R.O. 478536)



10 060 0451 

PIAGGIO - (R.O. B017901)



10 060 0461 

DERBI - PIAGGIO - (R.O. 431587)



10 060 0471 

PIAGGIO - (R.O. 434364+434363)



10 060 0481 

PIAGGIO - (R.O. 431780)



10 060 0501 

PIAGGIO - (R.O. 252971)



10 060 0511 

PEUGEOT



10 060 0521 

PEUGEOT
KYMCO - (R.O. 00166204-17205KEB7000)
SYM - (R.O. 17205KBN900)



10 060 0610 

PIAGGIO - (R.O. 260569)



10 060 0620 

PIAGGIO - (R.O. 248570)



UFI

10 060 0630 

PIAGGIO - (R.O. 230414)



UFI

10 060 0631 

PIAGGIO - (R.O. 230414)





10 060 0640 

PIAGGIO - (R.O. 25499)

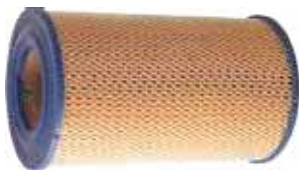

10 060 0651 

APRILIA - (R.O. AP8102832)



10 060 0661 

APRILIA - (R.O. AP8102860)



10 060 0680 

ATALA



10 060 0691 

PEUGEOT - (R.O. 737534)



10 060 0701 

PEUGEOT - (R.O. 737351)



10 060 0711 

YAMAHA - (R.O. 5DS154070100)

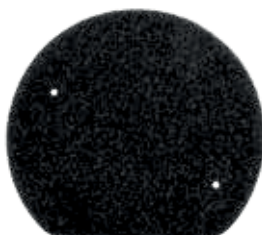

10 060 0732 

KYMCO - (R.O. 00162993)



10 060 0741 

KYMCO - (R.O. 00162475)



10 060 0752 

KYMCO - (R.O. 00162953)



10 060 0781 

HONDA - (R.O. 17210KFG010)
PEUGEOT - (R.O. 754906)
PIAGGIO - (R.O. 496406)



10 060 0791 

ITALJET
MBK - YAMAHA - (R.O. 5DSE44510000)
MALAGUTI - (R.O. 06612400)



10 060 0801 

MBK - YAMAHA - (R.O. 4CWE44510200)



10 060 0811 

HONDA - (R.O. 17205KEY900)



10 060 0821 

MALAGUTI - (R.O. 06608800)





FILTRI ARIA NYP SO
NYP SO AIR FILTERS

10 060 0831

MALAGUTI - (R.O. 06609100)



10 060 0841

SUZUKI - (R.O. 13782-35E00-000)



10 060 0851

MBK - YAMAHA - (R.O. 5SEE44510000)



10 060 0861

APRILIA - (R.O. AP8102965)



10 060 0871

MBK - YAMAHA - (R.O. 5D5154070100)



10 060 0881

GILERA - PIAGGIO - (R.O. 827936)



10 060 0891

DERBI - PIAGGIO (R.O. 487401)



10 060 0901

PIAGGIO - (R.O. 827694)



10 060 0911

PIAGGIO - (R.O. 487287)



10 060 0921

DERBI - GILERA - PIAGGIO - (R.O. 487719)



10 060 0931

PEUGEOT - (R.O. 747486)



10 060 0941

SUZUKI - (R.O. 13780-14F01-000)



10 060 0951

APRILIA - (R.O. AP8202138)



10 060 0971

CAGIVA - DERBI - (R.O. 00G03202251)



10 060 0981

PIAGGIO - (R.O. 827694)





10 060 0991 

APRILIA - DERBI - GILERA - PIAGGIO
(R.O. 829258)
MALAGUTI - (R.O. 06614100)
PEUGEOT - (R.O. 759939)



10 060 1132 

HONDA - (R.O. 17210KGF900)



10 060 1141 

GILERA - PIAGGIO - (R.O. 487845)
MALAGUTI - (R.O. 06615400)

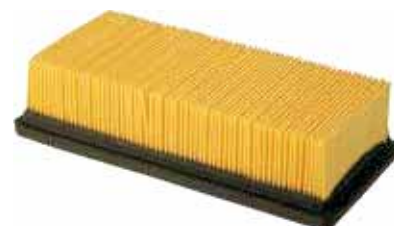

10 060 1151 

APRILIA - (R.O. AP8104242)



10 060 1161 

DERBI - PIAGGIO - (R.O. 843194)



10 060 1171 

DERBI - PIAGGIO - (R.O. 832703)



10 060 1181 

APRILIA - (R.O. AP8570092-832972)
DERBI - PIAGGIO - (R.O. 832972)



10 060 1191 

DERBI - GILERA - PIAGGIO - (R.O. 486942)



10 060 1201 

MALAGUTI - (R.O. 06610300)



10 060 1211 

MALAGUTI - (R.O. 06626100)



10 060 1221 

DERBI - PIAGGIO - (R.O. 840476)



10 060 1231 

SUZUKI - (R.O. 13780-49F00-000)



10 060 1301 

APRILIA - (R.O. AP8202302)



10 060 1311 

APRILIA - (R.O. AP8202443)



10 060 1321 

KYMCO - (R.O. 00163571-17205KEB7-900)





FILTRI ARIA NYPSO

NYPSO AIR FILTERS

10 060 1331 

KYMCO - (R.O. 00162309 - 17205-KFA6-900)



10 060 2001 

MALAGUTI - (R.O. 06607900)
YAMAHA - (R.O. 4HC15407-0000)



10 060 2011 

MBK - YAMAHA - (R.O. 4CWE54071000)



10 060 2021 

MALAGUTI - (R.O. 06611700)



10 060 2091 

APRILIA - (R.O. AP8202262)



10 060 2101 

APRILIA - (R.O. AP8202249)



10 060 2111 

PIAGGIO - (R.O. 831997)
PEUGEOT



10 060 2181 

LML



10 060 2201 

YAMAHA - (R.O. 4BH144510100)



10 060 2220 

BMW - (R.O. 13722345027)



UFI

10 060 2230 

APRILIA - (R.O. AP8102715)



UFI

10 060 2240 

GUZZI - (R.O. GU17113651)



UFI

10 060 2250 

BMW - (R.O. 13721254382)



UFI

10 060 2280 

GUZZI - (R.O. GU28113660)



UFI

10 060 2300 

GUZZI - (R.O. GU30113600)



UFI



10 060 2311 

KYMCO - (R.O. 00162377)
MALAGUTI - (R.O. 06611003)



10 060 2320 

CASALINI - LIGIER



UFI **10 060 2331** 

YAMAHA - (R.O. 5RU144512000-1SDE44510000)



10 060 2341 

YAMAHA - (R.O. 5RU144612000-1SDE44610000)



10 060 2351 

YAMAHA - (R.O. 5RU154070200)



10 060 2361 

YAMAHA - (R.O. 5GJ154070100)



10 060 2371 

YAMAHA - (R.O. 5GJ154080000)



10 060 2381 

HONDA - (R.O. 17210KTW900)



10 060 2391 

KYMCO - (R.O. 00164044)



10 060 2401 

KYMCO - (R.O. 00163126)



10 060 2411 

YAMAHA - (R.O. 1B9144510000-37PE44510000)



10 060 2421 

MBK - YAMAHA - (R.O. 5GM154070000)



10 060 2431 

KYMCO - (R.O. 00162380/1721A-LLJ3-E00)



10 060 2441 

YAMAHA - (R.O. 4B5144510000)



10 060 2451 

KYMCO - (R.O. 00101074)





FILTRI ARIA NYPSO

NYPSO AIR FILTERS

10 060 2471 

APRILIA - (R.O. JC13721X92000)



10 060 2481 

PEUGEOT - (R.O. 730199)



10 060 2491 

YAMAHA - (R.O. 4B5154070000)



10 060 2501 

MALAGUTI - (R.O. 65046700)



10 060 2511 

MALAGUTI - (R.O. 65041100)



10 060 2521 

SUZUKI - (R.O. 13782-03H-000)



10 060 2531 

SUZUKI - (R.O. 13785-20H00-000)



10 060 2541 

SUZUKI - (R.O. 13780-20H00-000)



10 060 2551 

SUZUKI - (R.O. 13780-03H00-000)



10 060 2561 

APRILIA - DERBI - GILERA - PIAGGIO
(R.O. 842093)



10 060 2571 

SYM - (R.O. 17211HMA000)



10 060 2581 

KYMCO - (R.O. 00117199-17211LFA7E00)



10 060 2591 

KYMCO - (R.O. 00117245-17211LEA7E00)



10 060 2601 

PIAGGIO - (R.O. 614945)



10 060 2611 

SUZUKI - (R.O. 13781-05H00-000)





10 060 2621 

PIAGGIO - (R.O. 1780187Z18000)



10 060 2631 

HONDA - (R.O. 17230-MCT-00)



10 060 2641 

HONDA - (R.O. 17210-KSV-J02)



10 060 2651 

HONDA - (R.O. 17210-KRJ-900)

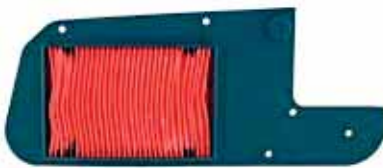

10 060 2661 

HONDA - (R.O. 17210-KWN-900)



10 060 2671 

KYMCO - (R.O. 17211-LGE5-E00 • 00117303)



10 060 2681 

SYM - (R.O. 17211H6B000)
PEUGEOT - (R.O. 801932)



10 060 2691 

SYM - (R.O. 17211-HLK-000)



10 060 2701 

KYMCO - (R.O. 00117213)



10 060 2711 

YAMAHA - (R.O. 59C-15408-00)



10 060 2721 

SUZUKI - (R.O. 13780-10G00-000)



10 060 2731 

SYM - (R.O. 17211-LEA-000)



10 060 2741 

YAMAHA
(R.O. 5TYE445110)



10 060 2753 

PIAGGIO - (R.O. 113125)



10 060 2761 

KYMCO - (R.O. 00117409)





FILTRI ARIA NYPSO
NYPSO AIR FILTERS

10 060 2771 

HONDA - (R.O. 17210-KZR-600)



10 060 2781 

SYM - (R.O. 17211HHA000)



10 060 2791 

YAMAHA - (R.O. 5C3E44510000)



10 060 2801 

KYMCO - (R.O. 00117221)



10 060 2810 

PIAGGIO - (R.O. 285352)



10 060 2821 

PIAGGIO - (R.O. B016409)



10 060 2831 

KYMCO - (R.O. 00117469)



10 060 2841 

HONDA - (R.O. 17210-KZL-930)



10 060 2851 

HONDA - (R.O. 17210-K01-900)



10 060 2861 

YAMAHA - (R.O. 52SE445100)



10 060 2871 

YAMAHA - (R.O. 52SE54080000)



10 060 2881 

YAMAHA - (R.O. 59C154070000)



10 060 2891 

SYM - (R.O. 17211-AAA-000)



10 060 2901 

HONDA - (R.O. 17210-MGS-D30)



10 060 2911 

HONDA - (R.O. 17210-KVZ-630)





10 060 2921 

KYMC O - (R.O. 00163096)



10 060 2931 

YAMAHA - (R.O. 5S9E44510000)



10 060 2961 

LML



10 060 2981 

KYMC O - (R.O. 00117492)



10 060 2991 

YAMAHA - (R.O. 2DPE44510000)



10 060 3001  **NEW**

YAMAHA - (R.O. 2CME44510000)



10 060 3011  **NEW**

PIAGGIO - (R.O. 1A005015)



10 060 3021  **NEW**

HONDA - (R.O. 17210-K04-930)



10 060 3031 

PIAGGIO - (R.O. B017901)



10 060 3041 

PIAGGIO - (R.O. B018070)



10 060 3051 

PIAGGIO - (R.O. 880001)



10 060 3063  **NEW**

PIAGGIO - (R.O. 90926)



10 060 3071  **NEW**

HONDA - (R.O. 19412-KTW-900)



10 060 3080 

BMW - 13717679366
HUSQVARNA



10 060 3090 

BMW - (R.O. 13711341528)





FILTRI ARIA NYPSO
NYPSO AIR FILTERS

10 060 3100 

HONDA - (R.O. 17210-MFN-D02)



10 060 3110 

HONDA - (R.O. 17221-KYJ-640)

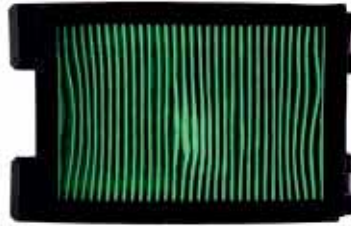

10 060 3120 

HONDA - (R.O. 17210-K40-F00)



10 060 3130 

HONDA - (R.O. 17210-KRP-980)



10 060 3140 

HONDA - (R.O. 17210-GFM-970)



10 060 3150 

HONDA - (R.O. 17211-KPC-D20)

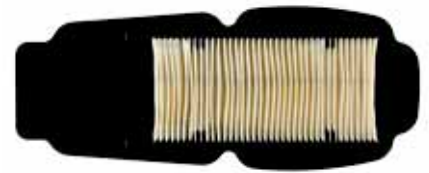

10 060 3160 

KAWASAKI - (R.O. 110290011)



10 060 3170 

KAWASAKI - (R.O. 110130713)



10 060 3180 

KAWASAKI - (R.O. 110130040)



10 060 3190 

KAWASAKI - (R.O. 11031302)



10 060 3200 

KAWASAKI - (R.O. 110130025)



10 060 3210 

KAWASAKI - (R.O. 110130041)



10 060 3220 

KAWASAKI - (R.O. 110130016)

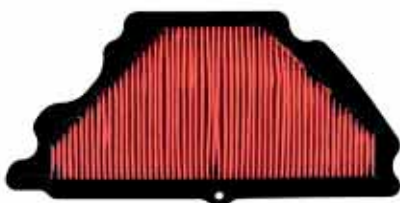

10 060 3230 

KAWASAKI - (R.O. 110130036)



10 060 3240 

KYMCO - (R.O. 00162989)





10 060 3250 

PIAGGIO - (R.O. 1A007267)



10 060 3260 

SUZUKI - (R.O. 13780-06G00-000)



10 060 3270 

SUZUKI - (R.O. 13780-40JA0-000)



10 060 3280 

SUZUKI - (R.O. 13780-27G10-000)



10 060 3290 

SUZUKI - (R.O. 13780-44H00-000)



10 060 3300 

SUZUKI - (R.O. 13780-18H00-000)



10 060 3310 

SUZUKI - (R.O. 13780-44G00-000)



10 060 3320 

SUZUKI - (R.O. 13780-47H00-000)



10 060 3330 

SUZUKI - (R.O. 13780-29G00-000)



10 060 3340 

SUZUKI - (R.O. 13780-01H00-000)



10 060 3350 

SUZUKI - (R.O. 13780-14J00-000)



10 060 3360 

SYM - (R.O. 17211L4A000)



10 060 3370 

SYM - (R.O. 17211VS1000)



10 060 3380 

YAMAHA - (R.O. 4TR144510000)



10 060 3390 

YAMAHA - (R.O. 2D1144510000)





FILTRI ARIA NYPSO

NYPSO AIR FILTERS

10 060 3400



YAMAHA - (R.O. 5WX144510000)



10 060 3410



YAMAHA - (R.O. 5VKE44510000)



10 060 3420



YAMAHA - (R.O. 1WS144500000)



10 060 3430



YAMAHA - (R.O. 5PW144510000)



10 060 3440



YAMAHA - (R.O. 5VY144510000)



10 060 3450



YAMAHA - (R.O. 4C8144510000)



10 060 3460



YAMAHA - (R.O. 14B144510000)



10 060 3470



YAMAHA - (R.O. 2C0144500100)



10 060 3480



YAMAHA - (R.O. 13S144500000)



10 060 3490



YAMAHA - (R.O. 13S144500200)



10 060 3500



YAMAHA - (R.O. 5EB144510000 • 5SL14450000)

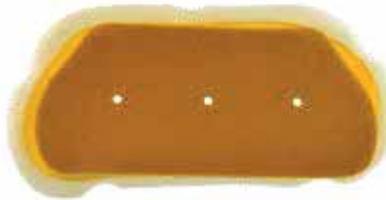

10 060 3510



YAMAHA - (R.O. 1VJ144510000)



10 060 3520



YAMAHA - (R.O. 2RW144510000)

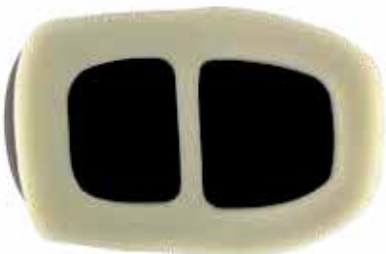

10 060 3530



YAMAHA - (R.O. 20S144510000)



10 060 3550



YAMAHA - (R.O. 5VLE44501200)





10 060 3560 

YAMAHA - (R.O. 2GV144510000)



10 060 3580 

HONDA - (R.O. 17210-MCA-A60)



10 060 3590 

900: Mt 09 / Tracer 14-16
(R.O. 1RC144510000)



10 060 4980 

PIAGGIO - (R.O. 1780187Z08)

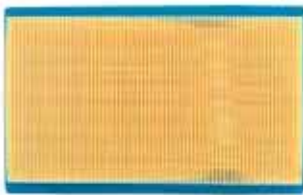

10 060 4990 

PIAGGIO - (R.O. 263703)



10 060 9341 

KYMCO - (R.O. 00163996)





FILTRI ARIA RACING
RACING AIR FILTERS

10 060 1000



Ø 32

Per carburatore - *For carburator*
PHBG

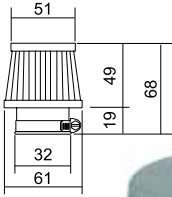

10 060 1010



Ø 35

Per carburatore - *For carburator*
PHVA-PHBN-PHBD-PHBE

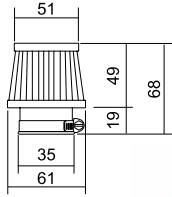

10 060 1020



Ø 38

Per carburatore - *For carburator*
PHBL

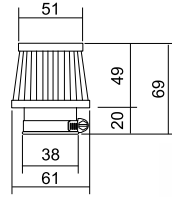

10 060 1030



Ø 35

Per carburatore - *For carburator*
PHBG-PHVA-PHBN-PHBD-PHBE

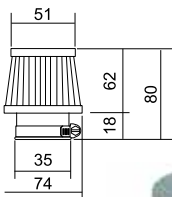

10 060 1040



Ø 38

Per carburatore - *For carburator*
PHBL

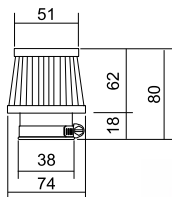

10 060 1050



Ø 32

Per carburatore - *For carburator*
PHBG

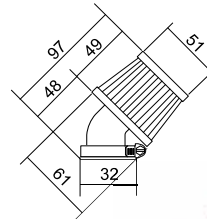

10 060 1060



Ø 35

Per carburatore - *For carburator*
PHBL

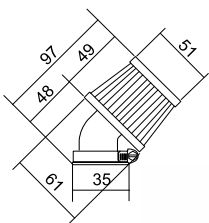

10 060 1070



Ø 35

Per carburatore - *For carburator*
PHBL

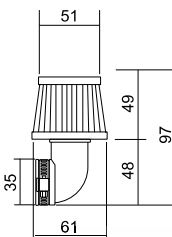

10 060 1120



Ø 35

Per carburatore - *For carburator*
PHBL

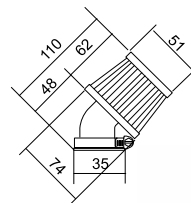



10 060 1080

Ø 32

Con cuffia protezione in plastica
anti acqua-fango-polvere
Dust water mud protection cover

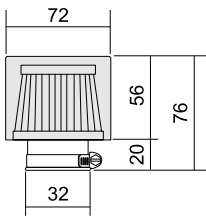

10 060 1090

Ø 35

Con cuffia protezione in plastica
anti acqua-fango-polvere
Dust water mud protection cover

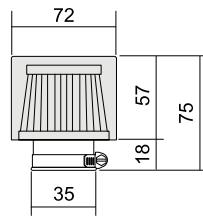

10 060 1100

Ø 38

Con cuffia protezione in plastica
anti acqua-fango-polvere
Dust water mud protection cover

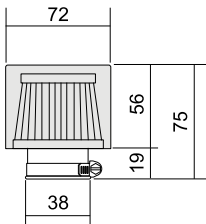

10 060 1110

Ø 35

Con cuffia protezione in plastica
anti acqua-fango-polvere
Dust water mud protection cover

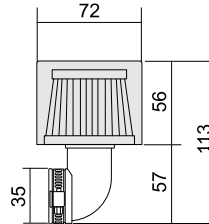



FILTRI ARIA QUAD
QUAD AIR FILTERS

10 060 1241 

KAWASAKI 750: Jet Force



10 060 1251 

HONDA 450: Trx



10 060 1271 

YAMAHA 700: Raptor



10 060 1281 

YAMAHA 450: Wolverine 4x4 06



10 060 2031 

YAMAHA 660: Raptor



10 060 2041 

YAMAHA 350: Warrior - Raptor
660: Grizzly



10 060 2051 

KAWASAKI 400: Kfx
SUZUKI 400



10 060 2071 

PANNELLO FILTRO ARIA QUAD:
Applicazioni Standard-mm 330 x 330 x 10

10 060 2081 

mm 330 x 330 x 15

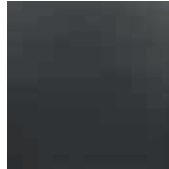

10 060 2121 

KYMCO 125-150: Maxer 02-03



10 060 2131 

KYMCO 250: Kxr 03



10 060 2141 

KAWASAKI 650-700: Prairie • 4x4 Hdw Kfx



10 060 2151 

POLARIS 330-500: Trial Boss • Predator
500-700: Scrambler 4x2-4x4
Sportman 4x4 • 4x4



10 060 2161 

YAMAHA 200: Blaster



10 060 2171 

YAMAHA 350: Yzf Banshee 2T





Modello - Model	Cc	Anno Year	Codice RMS RMS Code	Rif. Originale Orig. Ref.	Modello - Model	Cc	Anno Year	Codice RMS RMS Code	Rif. Originale Orig. Ref.
APRILIA					Leonardo	125	96-02	10 060 0041	AP8102582
Amico	50	94	10 060 0011	AP8201378	Leonardo St	125	01-04	10 060 0041	AP8102582
Amico	50	96-98	10 060 0011	AP8201378	Mojito	125	03-07	10 060 2561	AP8577006
Amico GL-GLE	50	93-95	10 060 0011	AP8201378	Mojito Retro' - Custom	125	99-01	10 060 0861	AP8102965
Amico Lx- Sport-Cat	50	92-93	10 060 0011	AP8201378	Scarabeo	125	03-06	10 060 0651	AP8102832
Area 51	50	98-00	10 060 0031	AP8201683	Scarabeo	125	04-06	10 060 2561	AP8577006
Gulliver	50	95-98	10 060 0031	AP8201683	Scarabeo le Light	125	09-10	10 060 2471	JC13721X92000
Gulliver Lc	50	96-98	10 060 0031	AP8201683	Scarabeo le Light 125	125	11-12	10 060 2471	JC13721X92000
Mojito Custom	50	99-03	10 060 0951	AP8202138	Scarabeo Light	125	07-08	10 060 2471	JC13721X92000
Mojito Retro	50	99-03	10 060 0951	AP8202138	Scarabeo Motore Piaggio Eu3	125	06	10 060 0651	AP8102832
Rally	50	95-03	10 060 0031	AP8201683	Scarabeo Motore Piaggio Eu3	125	06	10 060 2561	AP8577006
Rally Liquid Cooled	50	96-99	10 060 0031	AP8201683	Scarabeo Motore Rotax	125	99-04	10 060 0651	AP8102832
Scarabeo	50	93-05	10 060 0021	AP8201583	Sport City	125	04-06	10 060 0991	AP8104878
Scarabeo 4T	50	02-06	10 060 1181	AP8570092	Sport City	125	04-06	10 060 2561	AP8577006
Scarabeo 4T	50	02-06	10 060 2101	AP8202249	Sport City Cube	125	08-10	10 060 0991	829258
Scarabeo 4T 4V	50	14	10 060 1181	832972	Sport City Cube	125	08-10	10 060 2561	842093
Scarabeo 4T 4V	50	14	10 060 2101	AP8202249	Sport City Eu3	125	06-08	10 060 0991	AP8580172
Scarabeo 4T 4V	50	10-12	10 060 1181	832972	Sport City Eu3	125	06-08	10 060 2561	AP8577006
Scarabeo 4T 4V	50	10-12	10 060 2101	AP8202249	Sport City One 4T Eu3	125	08-11	10 060 2561	842093
Scarabeo 4T 4V Net	50	09	10 060 1181	832972	Sport City Street	125	12	10 060 0991	829258
Scarabeo 4T 4V Net	50	09	10 060 2101	AP8202249	Sport City Street	125	12	10 060 2561	842093
Scarabeo 4T 4V Net	50	10	10 060 1181	832972	Sr	125	99-01	10 060 0121	AP8102943
Scarabeo 4T 4V Net	50	10	10 060 2101	AP8202249	Sr Max	125	11-14	10 060 0991	829258
Scarabeo 4T Restyling Eu3	50	06-09	10 060 1181	832972	Sr Motard	125	12-14	10 060 2561	842093
Scarabeo 4T Restyling Eu3	50	06-09	10 060 2101	AP8202249	Scarabeo le Light 200	200	11-12	10 060 2471	JC13721X92000
Scarabeo Ditech	50	01-04	10 060 2091	AP8202262	Atlantic Eu3 250	250	06-08	10 060 0991	AP8104878
Scarabeo Quattro	50	09	10 060 1181	832972	Leonardo	250	99-04	10 060 0661	AP8102860
Scarabeo Quattro	50	09	10 060 2101	AP8202249	Leonardo St	250	01	10 060 0661	AP8102860
Sonic	50	98-07	10 060 0031	AP8201683	Scarabeo Light	250	06-08	10 060 0991	AP8104878
Sonic Gp	50	98-08	10 060 0031	AP8201683	Scarabeo Light	250	06-08	10 060 2561	AP8577006
Sr	50	93	10 060 0011	AP8201378	Sport City Cube	250	08-12	10 060 0991	829258
Sr	50	94-96	10 060 0031	AP8201683	Sport City Cube	250	08-12	10 060 2561	842093
Sr Ditech Eu 2	50	02-04	10 060 1301	AP8202302	Atlantic	300	10-11	10 060 0991	829258
Sr Ditech Eu 2	50	02-04	10 060 1301	AP8258242	Atlantic	300	10-11	10 060 2561	842093
Sr H2o Ditech e Carburatore	50	00-04	10 060 1301	AP8202281	Scarabeo Light	300	09-10	10 060 0991	829258
Sr H2o Ditech e Carburatore	50	00-04	10 060 1301	AP8249582	Scarabeo Light	300	09-10	10 060 2561	842093
Sr Iniezione e Carburatore	50	14	10 060 1301	AP8202302	Sport City Street	300	12	10 060 0991	829258
Sr Iniezione e Carburatore	50	14	10 060 1301	AP8249582	Sport City Street	300	12	10 060 2561	842093
Sr Liquid Cooled	50	94-96	10 060 0031	AP8201683	Sr Max	300	11-14	10 060 0991	829258
Sr Motard 4T 4V	50	13-14	10 060 1181	832972	Sr Max	300	11-14	10 060 2561	842093
Sr R Factory le e Carburatore	50	10-14	10 060 1301	AP8202302	Atlantic Sprint 400	400	05-08	10 060 0991	AP8580172
Sr R Factory le e Carburatore	50	10-14	10 060 1301	AP8249582	Scarabeo Light 400	400	06-08	10 060 0991	829258
Sr R Factory le e Carburatore	50	10-14	10 060 1311	AP8202443	Atlantic	500	01-04	10 060 1151	AP8104242
Sr R Factory Motore Aprilia	50	05	10 060 1311	AP8202443	Atlantic Sprint 500	500	05-08	10 060 0991	AP8580172
Sr R, R Factory	50	04-09	10 060 1301	AP8202302	Scarabeo	500	03-06	10 060 1151	AP8104242
Sr R, R Factory	50	04-09	10 060 1301	AP8249582	Pegaso 3	650	97-00	10 060 2230	AP8102715
Sr R, R Factory	50	04-09	10 060 1311	AP8202443	Pegaso le	650	01-04	10 060 2230	AP8102715
Sr Stealth Racing	50	97-00	10 060 0031	AP8201683	ATALA				
Sr Street	50	03-12	10 060 1301	AP8202302	At10 50 Ac Byte	50	97-01	10 060 0051	-
Sr Street	50	03-12	10 060 1301	AP8249582	At12 50 Ac Hacker	50	96-99	10 060 0051	-
Sr Www	50	97-01	10 060 0031	AP8201683	At12 50 Ac Hacker Racing	50	96-99	10 060 0051	-
Scarabeo 4T	100	14	10 060 1181	832972	At14 50 Lc Hacker Racing	50	97-99	10 060 0051	-
Scarabeo 4T	100	14	10 060 2101	AP8202249	Lepton	50	-	10 060 0680	-
Scarabeo 4T	100	01-05	10 060 1181	AP8570092	Skeggia 50 Ac	50	99-00	10 060 0051	-
Scarabeo 4T	100	01-05	10 060 2101	AP8202249	BENELLI				
Scarabeo 4T	100	10-12	10 060 1181	832972	491 Gt	50	98-99	10 060 0061	R72340011A0
Scarabeo 4T	100	10-12	10 060 2101	AP8202249	491 Racing	50	98-99	10 060 0061	R72340011A0
Scarabeo 4T Net	100	09	10 060 1181	832972	491 Rr	50	99-01	10 060 0061	R72340011A0
Scarabeo 4T Net	100	09	10 060 2101	AP8202249	491 Sp	50	99	10 060 0061	R72340011A0
Scarabeo 4T Net Eu3	100	10	10 060 1181	832972	491 Sport	50	98-99	10 060 0061	R72340011A0
Scarabeo 4T Net Eu3	100	10	10 060 2101	AP8202249	491 St	50	99-01	10 060 0061	R72340011A0
Scarabeo 4T Restyling	100	06-09	10 060 1181	832972	K2	50	98-01	10 060 0061	R72340011A0
Scarabeo 4T Restyling	100	06-09	10 060 2101	AP8202249	K2 Liquid Cooled	50	98-01	10 060 0061	R72340011A0
Atlantic	125	03-05	10 060 0991	AP8580172	Naked	50	02	10 060 0061	R72340011A0
Atlantic	125	03-05	10 060 2561	AP8577006	K2	100	99-01	10 060 0061	R72340011A0
Atlantic Eu3	125	10-12	10 060 0991	829258	Adiva 125	125	01-02	10 060 0421	R72340061A0
Atlantic Eu3	125	10-12	10 060 2561	842093	Adiva 150	150	01-02	10 060 0421	R72340061A0
Atlantic Eu3 125	125	06-08	10 060 0991	AP8104878	Velvet	250	99-01	10 060 0331	R72317001AZ
Atlantic Eu3 125	125	06-08	10 060 2561	AP8577006	Velvet Touring	250	02-03	10 060 0331	R72317001AZ



FILTRI ARIA - RICERCA PER MARCA

AIR FILTERS - SEARCH BY MODEL

Modello - Model	Cc	Anno Year	Codice RMS RMS Code	Rif. Originale Orig. Ref.	Modello - Model	Cc	Anno Year	Codice RMS RMS Code	Rif. Originale Orig. Ref.
BETA									
Ark 50 Ac	50	04-08	10 060 0061	-	Atlantis 4T Eu2	50	07	10 060 1181	832972
Ark 50 Lc	50	97-08	10 060 0061	-	Atlantis 50 4T	50	04-06	10 060 0461	431587
Eikon 50 Lc	50	99-06	10 060 0061	-	Atlantis 50 4T	50	04-06	10 060 1181	832972
BMW									
R 45 N	450	78-85	10 060 2250	13721254382	Atlantis Lc	50	99-01	10 060 0971	00G03202251
R 45 S	450	78-85	10 060 2250	13721254382	Atlantis O2	50	02	10 060 0921	487719
R 50 /5	500	69-73	10 060 2250	13721254382	Atlantis O2	50	02	10 060 1191	487719
R 60 /5	600	69-73	10 060 2250	13721254382	Atlantis O2 Bullet	50	03-05	10 060 0921	487719
R 60 /6	600	73-76	10 060 2250	13721254382	Atlantis O2 Bullet	50	03-05	10 060 1191	487719
R 60 /7	600	76-80	10 060 2250	13721254382	Atlantis O2 City	50	03-06	10 060 0921	487719
F 650	650	93-99	10 060 2220	13722345027	Atlantis O2 City	50	03-06	10 060 1191	487719
F 650 800 Gs	650	08-12	10 060 3080	13718529998	Atlantis O2 Red Bullet	50	03	10 060 0921	487719
F 650 800 Gs Abs	650	08-12	10 060 3080	13718529998	Atlantis O2 Red Bullet	50	03	10 060 1191	487719
F 650 St	650	97-99	10 060 2220	13722345027	Atlantis O2 Two Chic	50	05	10 060 0921	487719
R 65 1Serie	650	78-80	10 060 2250	13721254382	Atlantis O2 Two Chic	50	05	10 060 1191	487719
R 65 2Serie	650	80-85	10 060 2250	13721254382	Boulevard 2T	50	09-14	10 060 0921	487719
R 65 Ls	650	81-85	10 060 2250	13721254382	Boulevard 2T	50	09-14	10 060 1191	487719
F 700 800 Gs Abs	700	13-17	10 060 3080	13718529998	Boulevard 4T Eu2 25 Km/H	50	09	10 060 1161	843194
F 700 800 Gs Abs Esa	700	17	10 060 3080	13718529998	Boulevard 4T Eu2 25 Km/H	50	09	10 060 1181	832972
R 75 /5	750	69-73	10 060 2250	13721254382	Gp1	50	01-02	10 060 0921	487719
R 75 /6	750	73-76	10 060 2250	13721254382	Gp1	50	01-02	10 060 1191	487719
R 75 /7	750	76-79	10 060 2250	13721254382	Gp1	50	03	10 060 0921	487719
F 800 Gs	800	08-12	10 060 3080	13718529998	Gp1	50	03	10 060 1191	487719
F 800 Gs Abs	800	08-17	10 060 3080	13718529998	Gp1 E2	50	03	10 060 0921	487719
F 800 Gs Abs Esa	800	17	10 060 3080	13718529998	Gp1 E2	50	03	10 060 1191	487719
F 800 Gs Adventure Abs	800	13-17	10 060 3080	13718529998	Gp1 Open Eu2	50	06-09	10 060 0921	487719
F 800 Gs Adventure Abs Esa	800	17	10 060 3080	13718529998	Gp1 Open Eu2	50	06-09	10 060 1191	487719
F 800 Gt Abs	800	13-17	10 060 3080	13718529998	Hunter	50	96-97	10 060 0971	00G03202251
F 800 Gt Abs Esa	800	17	10 060 3080	13718529998	Paddock	50	98-99	10 060 0971	00G03202251
F 800 R	800	09-12	10 060 3080	13718529998	Predator Lc	50	98-01	10 060 0971	00G03202251
F 800 R Abs	800	09-17	10 060 3080	13718529998	Predator O2	50	98-01	10 060 0971	00G03202251
F 800 R Abs Esa	800	17	10 060 3080	13718529998	Sonar 2T	50	09	10 060 0921	487719
F 800 S	800	06-10	10 060 3080	13718529998	Sonar 2T	50	09	10 060 1191	487719
F 800 S Abs	800	07-10	10 060 3080	13718529998	Variant Sport 2T	50	12	10 060 0921	487719
F 800 St	800	06-12	10 060 3080	13718529998	Variant Sport 2T	50	12	10 060 1191	487719
F 800 St Abs	800	07-12	10 060 3080	13718529998	Atlantis	100	00-01	10 060 0971	00G03202251
R 80 /7N	800	77-80	10 060 2250	13721254382	Atlantis 100 4T	100	04-06	10 060 0461	431587
R 80 /7S	800	77-80	10 060 2250	13721254382	Atlantis 100 4T	100	04-06	10 060 1181	832972
R 80 Rt	800	82-84	10 060 2250	13721254382	Boulevard 4T	100	10-11	10 060 1161	843194
R 850 Gs	850	98-99	10 060 3090	13711341528	Boulevard 4T	100	10-11	10 060 1181	832972
R 850 Gs Abs	850	98-99	10 060 3090	13711341528	Boulevard 125	125	02-04	10 060 0891	487401
R 850 R	850	03-06	10 060 3090	13711341528	Boulevard 125	125	03-04	10 060 1171	832703
R 850 R Abs	850	03-06	10 060 3090	13711341528	Boulevard 125	125	03-04	10 060 2561	842093
R 850 R Cast Wheel	850	95-02	10 060 3090	13711341528	Boulevard 125 Eu2	125	04-07	10 060 0891	487401
R 850 R Cast Wheel Abs	850	98-00	10 060 3090	13711341528	Boulevard 125 Eu2	125	04-07	10 060 1171	832703
R 850 R Comfort	850	04-06	10 060 3090	13711341528	Boulevard 125 Eu2	125	04-07	10 060 2561	842093
R 850 R Comfort Abs	850	04-06	10 060 3090	13711341528	Boulevard 4T Eu3	125	08-12	10 060 1161	843194
R 90 /6	900	73-76	10 060 2250	13721254382	Boulevard 4T Eu3	125	08-12	10 060 1171	832703
R 90 S	900	73-76	10 060 2250	13721254382	Gp1 Eu2	125	06	10 060 0991	829258
R 100 /7	1000	76-78	10 060 2250	13721254382	Gp1 Eu2	125	06	10 060 2561	842093
R 100 Cast Wheel	1000	81-84	10 060 2250	13721254382	Gp1 Low Seat 125 Eu3	125	07-08	10 060 0991	829258
R 100 Cs Clsport	1000	80-84	10 060 2250	13721254382	Gp1 Low Seat 125 Eu3	125	07-08	10 060 2561	842093
R 100 Rs	1000	76-84	10 060 2250	13721254382	Rambla 125	125	08-09	10 060 0991	829258
R 100 Rt	1000	78-84	10 060 2250	13721254382	Rambla 125	125	08-09	10 060 2561	842093
R 100 S	1000	76-80	10 060 2250	13721254382	Rambla 125 E3 2Ver	125	08	10 060 0991	829258
R 100 Spoked Wheel	1000	81-84	10 060 2250	13721254382	Rambla 125 E3 2Ver	125	08	10 060 2561	842093
R 100 T Touren	1000	77-80	10 060 2250	13721254382	Sonar 4T	125	09-11	10 060 1171	832703
CAGIVA									
Cucciolo	50	98-99	10 060 0971	00G03202251	Sonar 4T	125	09-11	10 060 2561	842093
Progress	50	97-99	10 060 0971	00G03202251	Variant Sport 4T E3	125	12	10 060 1161	843194
Progress Lc	50	98-99	10 060 0971	00G03202251	Variant Sport 4T E3	125	12	10 060 1171	832703
DERBI									
Atlantis	50	99-01	10 060 0971	00G03202251	Variant Sport 4T E3	125	12	10 060 2561	842093
Atlantis 2T	50	10	10 060 0921	487719	Boulevard 150	150	02-04	10 060 0891	487401
Atlantis 2T	50	10	10 060 1191	487719	Boulevard 150 Eu2	150	04-07	10 060 0891	487401
Atlantis 2T Eu2	50	07-09	10 060 0921	487719	Boulevard 4T E3	150	10	10 060 1161	843194
Atlantis 2T Eu2	50	07-09	10 060 1191	487719	Boulevard 4T E3	150	10	10 060 1171	832703
Atlantis 4T Eu2	50	07	10 060 0461	431587	Rambla 250	150	08-09	10 060 0991	829258
					Sonar 4T	150	09	10 060 1171	832703
					Sonar 4T	150	09	10 060 2561	842093
					Boulevard Eu2	200	05-06	10 060 0891	487401
					Boulevard Eu2	200	05-06	10 060 1171	832703



Modello - Model	Cc	Anno Year	Codice RMS RMS Code	Rif. Originale Orig. Ref.	Modello - Model	Cc	Anno Year	Codice RMS RMS Code	Rif. Originale Orig. Ref.
Gp1	250	06-07	10 060 0991	829258	Dna 180	180	01	10 060 0881	827936
Gp1	250	06-07	10 060 1221	840476	Runner Vxr	200	05-06	10 060 0991	829258
Gp1	250	06-07	10 060 2561	842093	Runner Vxr 4T St Eu3	200	08-11	10 060 0991	829258
Gp1 Low Seat 250 Eu3	250	07-08	10 060 0991	829258	Runner Vxr Eu3	200	07	10 060 0991	829258
Gp1 Low Seat 250 Eu3	250	07-08	10 060 2561	842093	Runner Vxr Race	200	05-06	10 060 0991	829258
Rambra 250 E3 2Ver	250	08	10 060 0991	829258	Nexus Eu3	250	06	10 060 0991	829258
Rambra	300	10-11	10 060 0991	829258	Nexus Eu3	250	06	10 060 2561	842093
Rambra	300	10-11	10 060 2561	842093	Nexus Eu3	250	07	10 060 0991	829258
GILERA					Nexus Eu3	250	07	10 060 2561	842093
Dna	50	00-02	10 060 0921	487719	Nexus Sp Eu3	250	06-07	10 060 0991	829258
Dna	50	00-02	10 060 1191	486942	Nexus Sp Eu3	250	06-07	10 060 2561	842093
Dna	50	05-07	10 060 0921	487719	Nexus Eu3	300	08	10 060 0991	829258
Dna	50	05-07	10 060 1191	486942	Nexus Eu3	300	08	10 060 2561	842093
Dna Gp Experience	50	03-04	10 060 0921	487719	Nexus Eu3	300	09-11	10 060 0991	829258
Dna Gp Experience	50	03-04	10 060 1191	486942	Nexus Eu3	300	09-11	10 060 2561	842093
Easy Moving	50	95-96	10 060 0431	431838	Fuoco 4T-4V Ie E3 Lt	500	13-14	10 060 0991	829258
Ice	50	01-05	10 060 0921	487719	Fuoco Eu3	500	07-13	10 060 0991	829258
Ice	50	01-05	10 060 1191	486942	Nexus	500	03-05	10 060 1141	487845
Runner	50	97-00	10 060 0111	479748	Nexus Eu3	500	06-11	10 060 1141	487845
Runner Poggiali	50	02	10 060 0921	487719	Nexus Sp Eu3	500	06-07	10 060 1141	487845
Runner Poggiali	50	02	10 060 1191	486942	GUZZI				
Runner Purejet	50	02-07	10 060 0111	479748	Nevada 350 Club	350	98-99	10 060 2240	GU17113651
Runner Purejet	50	10-11	10 060 0111	479748	Nevada 350 Nuovo Tipo Lg12001>	350	93-97	10 060 2240	GU17113651
Runner Purejet St	50	08	10 060 0111	479748	Nevada 350 Vecchio Tipo	350	92-93	10 060 2240	GU17113651
Runner Sp	50	02-04	10 060 0921	487719	Ntx	350	86-90	10 060 2240	GU17113651
Runner Sp	50	02-04	10 060 1191	486942	V35 Carabinieri-Pa <Pd30076	350	90-91	10 060 2240	GU17113651
Runner Sp	50	05-06	10 060 0921	487719	V35 Carabinieri-Pa Pd30077>	350	92-01	10 060 2240	GU17113651
Runner Sp	50	05-06	10 060 1191	486942	V35 Florida	350	86-90	10 060 2240	GU17113651
Runner Sp	50	07	10 060 0921	487719	V35 II	350	80-85	10 060 2240	GU17113651
Runner Sp	50	07	10 060 1191	486942	V35 III	350	85-87	10 060 2240	GU17113651
Runner Sp	50	10-12	10 060 0921	487719	V35c-V50c	350	82-86	10 060 2240	GU17113651
Runner Sp	50	10-12	10 060 1191	486942	V35-V50 Accensione Elettronica	350	77-79	10 060 2240	GU17113651
Runner Sp Special Edition	50	07	10 060 0921	487719	V50 III	500	80-84	10 060 2240	GU17113651
Runner Sp Special Edition	50	07	10 060 1191	486942	V50 III Polizia-Pa Vecchio Tipo	500	82-90	10 060 2240	GU17113651
Runner Sp St & Simoncelli	50	08-09	10 060 0921	487719	V50 Pa	500	92-01	10 060 2240	GU17113651
Runner Sp St & Simoncelli	50	08-09	10 060 1191	486942	850 T3 E Derivati	850	79-85	10 060 2240	GU17113651
Stalker	50	05-06	10 060 0921	487719	850 T5 Polizia-Cc-Pa (Nc) <Vr36415	850	88-93	10 060 2280	GU28113660
Stalker	50	05-06	10 060 1191	486942	850 T5 Polizia-Cc-Pa (Nc) Vr40001>	850	95-01	10 060 2280	GU28113660
Stalker	50	07-08	10 060 0921	487719	850 T5 Polizia-Cc-Pa. Nc Vr36416-40000	850	94-95	10 060 2280	GU28113660
Stalker	50	07-08	10 060 1191	486942	Bellagio - Aquila Nera	940	07-13	10 060 2300	GU30113600
Stalker	50	09-11	10 060 0921	487719	1000 S	1000	89-94	10 060 2280	GU28113660
Stalker	50	09-11	10 060 1191	486942	1000 Sp	1000	79-83	10 060 2240	GU17113651
Stalker	50	97-04	10 060 0111	479748	1000 Sp III	1000	89-94	10 060 2280	GU28113660
Stalker	50	97-04	10 060 0921	487719	California III Carb.	1000	87-93	10 060 2280	GU28113660
Stalker	50	97-04	10 060 1191	486942	California III Carb. Carenato	1000	88-90	10 060 2280	GU28113660
Stalker Naked	50	08	10 060 0921	487719	California III Iniezione	1000	90-93	10 060 2280	GU28113660
Stalker Naked	50	08	10 060 1191	486942	Daytona	1000	92-95	10 060 2300	GU30113600
Stalker Special Edition	50	07-08	10 060 0921	487719	Daytona Racing	1000	96	10 060 2300	GU30113600
Stalker Special Edition	50	07-08	10 060 1191	486942	Daytona Rs	1000	97-98	10 060 2300	GU30113600
Storm	50	94-95	10 060 0091	433437	Le Mans	1000	84-93	10 060 2280	GU28113660
Storm Eu2	50	07	10 060 0921	487719	Quota	1000	92-97	10 060 2300	GU30113600
Storm Eu2	50	07	10 060 1191	486942	Strada	1000	93-94	10 060 2280	GU28113660
Typhoon	50	94-97	10 060 0091	433437	V10 Centauro	1000	97-99	10 060 2300	GU30113600
Typhoon X	50	98-99	10 060 0091	433437	California	1100	94-97	10 060 2300	GU30113600
Typhoon Xr	50	00	10 060 0091	433437	California Aluminium - Titanium	1100	03-04	10 060 2300	GU30113600
Dna 125	125	01	10 060 0881	827936	California Aquila Nera	1100	09-11	10 060 2300	GU30113600
Nexus Eu3	125	07-08	10 060 0991	829258	California Classic - Touring	1100	06-08	10 060 2300	GU30113600
Nexus Eur3	125	07-08	10 060 2561	842093	California Ev	1100	01-02	10 060 2300	GU30113600
Nexus Eu3 Ie	125	08-10	10 060 0991	829258	California Ev - Ev Touring	1100	03-05	10 060 2300	GU30113600
Runner 4T St Eu3	125	08-13	10 060 0991	829258	California Ev (V11 Ev Usa)	1100	97-00	10 060 2300	GU30113600
Runner Fx-Fxr 125	125	97-02	10 060 0121	480084	California Ev Pi.	1100	02	10 060 2300	GU30113600
Runner Vx	125	05-06	10 060 0991	829258	California Jackal	1100	99-01	10 060 2300	GU30113600
Runner Vx 4T Eu3	125	06-07	10 060 0991	829258	California Special	1100	99-00	10 060 2300	GU30113600
Runner Vx Race	125	06	10 060 0991	829258	California Special Sport - Aluminium	1100	02-03	10 060 2300	GU30113600
Runner Vx Sc	125	06-07	10 060 0991	829258	California Sport	1100	01-02	10 060 2300	GU30113600
Runner Vx-Vxr 125	125	00-01	10 060 0881	827936	California Stone	1100	01	10 060 2300	GU30113600
Runner Vx-Vxr 125	125	02-04	10 060 0991	829258	California Stone	1100	04-05	10 060 2300	GU30113600
Typhoon	125	95-98	10 060 0081	478240	California Stone - Metal	1100	02-03	10 060 2300	GU30113600
Typhoon X-Xr	125	99-00	10 060 0081	478240	California Vintage	1100	06-12	10 060 2300	GU30113600



FILTRI ARIA - RICERCA PER MARCA

AIR FILTERS - SEARCH BY MODEL

Modello - Model	Cc	Anno Year	Codice RMS RMS Code	Rif. Originale Orig. Ref.	Modello - Model	Cc	Anno Year	Codice RMS RMS Code	Rif. Originale Orig. Ref.
Quota 1100 Es	1100	99-01	10 060 2300	GU30113600	Nss 250 Jazz	250	01	10 060 0781	17210-KFG-010
Sport 1100 Carburatori	1100	94-96	10 060 2300	GU30113600	Nss 250 Jazz	250	03-04	10 060 0781	17210-KFG-010
Sport 1100 Iniezione	1100	96-99	10 060 2300	GU30113600	Nss 250 Jazz Es	250	01-04	10 060 0781	17210-KFG-010
Sport Corsa	1100	98-99	10 060 2300	GU30113600	Nss 250 X Forza	250	07-13	10 060 2641	17210-KSV-J02
V11 Le Mans	1100	00-01	10 060 2300	GU30113600	Nss 250 X Forza	250	08-13	10 060 2911	17210-KVZ-630
V11 Le Mans	1100	02	10 060 2300	GU30113600	Cbr 300 Ra Abs	300	14-16	10 060 3110	17221-KYJ-640
V11 Sport	1100	99-01	10 060 2300	GU30113600	Nss 300 A Forza Abs	300	13-15	10 060 3071	19412-KTW-900
HERCULES					Nss 300 A Forza Abs	300	13-16	10 060 3021	17210-K04-930
Limbo 25 Ma	25	95	10 060 0371	730199	Nss 300 A Forza Deluxe Abs	300	16	10 060 3021	17210-K04-930
Reggae 50	50	95	10 060 0371	730199	Nss 300 Forza	300	13-15	10 060 3071	19412-KTW-900
Splinter 50	50	95	10 060 0371	730199	Nss 300 Forza	300	13-16	10 060 3021	17210-K04-930
HONDA					Sh 300 A I Abs	300	07-13	10 060 2381	17210-KTW-900
Nsc 50 Mpd Vision 16/14	50	12-16	10 060 2841	17210KZL930	Sh 300 A I Abs	300	07-16	10 060 3071	19412-KTW-900
Nsc 50 R 2Wh Repsol 14	50	13-14	10 060 2841	17210KZL930	Sh 300 A I Abs	300	14-15	10 060 2381	17210-KTW-900
Nsc 50 R T2 14	50	14-16	10 060 2841	17210KZL930	Sh 300 I	300	08-10	10 060 2381	17210-KTW-900
Nsc 50 R T2 Repsol 14	50	15-16	10 060 2841	17210KZL930	Sh 300 I	300	08-10	10 060 3071	19412-KTW-900
Nsc 50 R T2 Tricolor 14	50	15-16	10 060 2841	17210KZL930	Fjs 400 A Sw-T Abs	400	09-16	10 060 2631	17230-MCT-000
Nsc 50 Wh Vision 14	50	12-13	10 060 2841	17210KZL930	Fjs 400 D Sw-T	400	09-13	10 060 2631	17230-MCT-000
Sfx 50	50	96-00	10 060 0231	17205-GBM-750	Fjs 600 A Silver Wing Abs	600	03-10	10 060 2631	17230-MCT-000
Sgx 50 Sky	50	97-00	10 060 0211	17205-GBM-750	Fjs 600 A Sw-T Abs	600	11-16	10 060 2631	17230-MCT-000
Sh 50 Scoopy	50	91-95	10 060 0141	17205-GJ4-760	Fjs 600 D Silver Wing	600	03-06	10 060 2631	17230-MCT-000
Sh 50 Scoopy	50	96-00	10 060 0201	17205-GBY-900	Fjs 600 Silver Wing	600	01-02	10 060 2631	17230-MCT-000
Sj 50 Bali	50	95-01	10 060 0171	17205-GAV-700	Ctx 700 D Dct Abs	700	14-16	10 060 2901	17210-MGS-D30
Srx 50 Shadow	50	98-99	10 060 0221	-	Ctx 700 Nd Dct Abs	700	14-16	10 060 2901	17210-MGS-D30
Scv 100 Lead	100	03-07	10 060 3130	17210-KRP-980	Nc 700 D Integra Dct Abs	700	12-13	10 060 2901	17210-MGS-D30
Sh 100 Scoopy	100	96-01	10 060 0201	17205-GBY-900	Nc 700 S	700	12-14	10 060 2901	17210-MGS-D30
Sj 100 Bali Ex	100	96-00	10 060 0171	17205-GAV-700	Nc 700 Sa Abs	700	12-14	10 060 2901	17210-MGS-D30
Nhx 110 Wh Lead	110	08-13	10 060 3140	17210-GFM-970	Nc 700 Sd Dct Abs	700	12-14	10 060 2901	17210-MGS-D30
Nsc 110 Mpd Vision Cbs	110	12-16	10 060 2841	17210KZL930	Nc 700 X	700	12-14	10 060 2901	17210-MGS-D30
Anf 125 Innova	125	05	10 060 3071	19412-KTW-900	Nc 700 Xa Abs	700	12-14	10 060 2901	17210-MGS-D30
Fes 125 A S-Wing Abs	125	07-13	10 060 2651	17210-KRJ-900	Nc 700 Xd Dct Abs	700	12-14	10 060 2901	17210-MGS-D30
Fes 125 Pantheon	125	03-06	10 060 2651	17210-KRJ-900	Nc 750 D Integra Dct Abs	750	14-16	10 060 2901	17210-MGS-D30
Fes 125 Pantheon	125	98-02	10 060 0811	17205-KEY-900	Nc 750 J Nm4 Vultus Dct Abs	750	17	10 060 2901	17210-MGS-D30
Fes 125 S-Wing	125	07-10	10 060 2651	17210-KRJ-900	Nc 750 J Nm4 Vultus Dct Abs	750	14-16	10 060 2901	17210-MGS-D30
Nss 125 Ad Forza Abs	125	15-17	10 060 3120	17210-K40-F00	Nc 750 Sa Abs	750	14	10 060 2901	17210-MGS-D30
Pcx 125 Ww125	125	13	10 060 2771	17210-KZR-600	Nc 750 Sa Abs	750	15	10 060 2901	17210-MGS-D30
Pcx 125 Ww125ex2	125	12-14	10 060 2771	17210-KZR-600	Nc 750 Sa Abs	750	16	10 060 2901	17210-MGS-D30
Pcx 125 Ww125ex2	125	10-11	10 060 2661	17210-KWN-900	Nc 750 Sd Dct Abs	750	16	10 060 2901	17210-MGS-D30
Pcx 125 Ww125ex2	125	15-16	10 060 2771	17210-KZR-600	Nc 750 Sd Dct Abs	750	14-15	10 060 2901	17210-MGS-D30
Sh 125 A I Abs	125	13	10 060 1132	17210-KGF-900	Nc 750 Xa Abs	750	16	10 060 2901	17210-MGS-D30
Sh 125 A I Abs	125	13	10 060 2851	17210-k01-900	Nc 750 Xa Abs	750	14-15	10 060 2901	17210-MGS-D30
Sh 125 A I Abs	125	16	10 060 1132	17210-KGF-900	Nc 750 Xd Dct Abs	750	16	10 060 2901	17210-MGS-D30
Sh 125 A I Abs	125	16	10 060 2851	17210-k01-900	Nc 750 Xd Dct Abs	750	14-15	10 060 2901	17210-MGS-D30
Sh 125 A I Abs	125	14-15	10 060 1132	17210-KGF-900	Cb 1000 R	1000	08-16	10 060 3100	17210-MFN-D02
Sh 125 A I Abs	125	14-15	10 060 2851	17210-k01-900	Cb 1000 Ra Abs	1000	08-16	10 060 3100	17210-MFN-D02
Sh 125 Anc I Mode	125	14-16	10 060 2771	17210-KZR-600	Cbf 1000 F	1000	10	10 060 3100	17210-MFN-D02
Sh 125 I	125	13	10 060 1132	17210-KGF-900	Cbf 1000 F	1000	11	10 060 3100	17210-MFN-D02
Sh 125 I	125	16	10 060 1132	17210-KGF-900	Cbf 1000 F	1000	12-14	10 060 3100	17210-MFN-D02
Sh 125 I	125	16	10 060 2851	17210-K01-900	Cbf 1000 Fa Abs	1000	10	10 060 3100	17210-MFN-D02
Xl 125 V Varadero	125	01-06	10 060 3150	17211-KPC-D20	Cbf 1000 Fa Abs	1000	11	10 060 3100	17210-MFN-D02
Xl 125 V Varadero 80 Km/H	125	01-06	10 060 3150	17211-KPC-D20	Cbf 1000 Fa Abs	1000	12-16	10 060 3100	17210-MFN-D02
Fes 150 A S-Wing Abs	150	07-09	10 060 2651	17210-KRJ-900	Gl 1800 A Goldwing Abs	1800	01-05	10 060 3580	17210-MCA-A60
Fes 150 Pantheon	150	03-05	10 060 2651	17210-KRJ-900	Gl 1800 B Goldwing/F6b/Bagger Abs	1800	13-16	10 060 3580	17210-MCA-A60
Fes 150 Pantheon	150	98-02	10 060 0811	17205-KEY-900	Gl 1800 C Goldwing/F6c/Valkyrie Abs	1800	14	10 060 3580	17210-MCA-A60
Fes 150 S-Wing	150	07-09	10 060 2651	17210-KRJ-900	Gl 1800 C Goldwing/F6c/Valkyrie Abs	1800	15-16	10 060 3580	17210-MCA-A60
Sh 150 A I Abs	150	13	10 060 1132	17210-KGF-900	Gl 1800 Goldwing Abs	1800	06-13	10 060 3580	17210-MCA-A60
Sh 150 A I Abs	150	13	10 060 2851	17210-k01-900	Gl 1800 Goldwing Airbag/Navi Abs	1800	07-16	10 060 3580	17210-MCA-A60
Sh 150 A I Abs	150	16	10 060 1132	17210-KGF-900	ITALJET				
Sh 150 A I Abs	150	16	10 060 2851	17210-k01-900	Formula 50 Ac Dd	50	95-97	10 060 0241	-
Sh 150 A I Abs	150	14-15	10 060 1132	17210-KGF-900	Formula 50 Ac Dd Race	50	96	10 060 0241	-
Sh 150 A I Abs	150	14-15	10 060 2851	17210-k01-900	Formula 50 Ac Dd Sport	50	98	10 060 0241	-
Cbr 250 R	250	11-14	10 060 3110	17221-KYJ-640	Formula 50 Ac Dt	50	97-03	10 060 0241	-
Cbr 250 Ra Abs	250	11-15	10 060 3110	17221-KYJ-640	Formula 50 Lc Dd	50	97-03	10 060 0241	-
Fes 250 Foresight	250	98-05	10 060 0781	17210-KFG-010	Dragster 125	125	99-03	10 060 0121	-
Nss 250 A Forza Abs	250	08-11	10 060 2911	17210-KVZ-630	Formula 125	125	97-01	10 060 0241	-
Nss 250 A Jazz Abs	250	01-04	10 060 0781	17210-KFG-010	Millennium 125	125	00-03	10 060 0791	-
Nss 250 Ex Forza Abs	250	07-13	10 060 2641	17210-KSV-J02	Torpedo 125	125	99-00	10 060 0421	240436478
Nss 250 Ex Forza Abs	250	08-13	10 060 2911	17210-KVZ-630	Dragster 180	180	99-03	10 060 0121	-
Nss 250 Ex Forza Abs	250	05-06	10 060 2641	17210-KSV-J02					



Modello - Model	Cc	Anno Year	Codice RMS RMS Code	Rif. Originale Orig. Ref.	Modello - Model	Cc	Anno Year	Codice RMS RMS Code	Rif. Originale Orig. Ref.
KAWASAKI					People	50	99-00	10 060 1331	00162309
Ninja Zx-6R P7f-P8f	600	07-08	10 060 3220	110130016	People Eu2	50	03	10 060 1331	00162309
Ninja Zx-6R R9f-Raf-Rbf-Rcf-Rdf	600	09-13	10 060 3230	110130036	People Eu2	50	08	10 060 1331	00162309
Ninja Zx-6R Ref-Rff-Rgf	600	14-16	10 060 3230	110130036	People Eu2	50	11	10 060 1331	00162309
Ninja Zx-6R Abs Fdf-Fef-Fff-Fffa	636	13-15	10 060 3230	110130036	People S	50	05-08	10 060 1331	00162309
Ninja Zx-6R Abs Fgf-Fgfa	636	16	10 060 3230	110130036	People S 4T	50	06-08	10 060 2451	00101074
Ninja Zx-6R Edf-Eef-Eff-Effa	636	13-15	10 060 3230	110130036	Sento	50	08	10 060 2451	00101074
Ninja Zx-6R Egf-Egfa	636	16	10 060 3230	110130036	Sniper	50	93	10 060 0261	00166204
Er-6F Abs D9f-Daf-Dbf	650	09-11	10 060 3160	110290011	Sniper	50	93	10 060 0521	00166204
Er-6F Abs Fcf-Fds-Fef-Fff-Fgf	650	12-16	10 060 3170	110130713	Sniper Dd	50	94-96	10 060 0261	00166204
Er-6F C9f-Caf-Cbf	650	09-11	10 060 3160	110290011	Sniper Dd	50	94-96	10 060 0521	00166204
Er-6F Ecf-Eds-Eef-Eff-Egf	650	12-16	10 060 3170	110130713	Super 8	50	07	10 060 2451	00101074
Er-6N Abs D9f-Daf-Dbf	650	09-11	10 060 3160	110290011	Super 8 2T	50	09	10 060 1331	00162309
Er-6N Abs Fcf-Fds-Fef-Fff-Fgf	650	12-16	10 060 3170	110130713	Super 8 2T	50	13	10 060 1331	00162309
Er-6N C9f-Caf-Cbf	650	09-11	10 060 3160	110290011	Super 8 4T	50	09	10 060 2451	00101074
Er-6N Ecf-Eds-Eef-Eff-Egf	650	12-16	10 060 3170	110130713	Super 8 4T	50	13	10 060 2451	00101074
Z750 Abs M7f-Maf-Mas	750	07-10	10 060 3190	110131302	Super 9	50	00	10 060 1321	00163571
Z750 Abs Mbf-Mcf	750	11-12	10 060 3190	110131302	Super 9 Sport Eu2	50	03	10 060 1321	00163571
Z750 J1h-J2h	750	04-05	10 060 3190	110131302	Super 9 Sport Eu2	50	04	10 060 1321	00163571
Z750 J6f	750	06	10 060 3190	110131302	Top Boy	50	97-00	10 060 1321	00163571
Z750 L7f-Laf-Las	750	07-10	10 060 3190	110131302	Vitality 2T	50	04	10 060 1321	00163571
Z750 Lbf-Lcf	750	11-12	10 060 3190	110131302	Vitality 4T	50	04	10 060 2391	00164044
Z750r Abs Pbf-Pcf	750	11-12	10 060 3190	110131302	Yup	50	02	10 060 1321	00163571
Z750r Nbf-Ncf	750	11-12	10 060 3190	110131302	Yup Eu2	50	03	10 060 1321	00163571
Z750s K1h	750	05	10 060 3190	110131302	Agility Plus	125	14	10 060 2311	00162377
Z750s K6f	750	06	10 060 3190	110131302	Agility Plus E4	125	16	10 060 2311	00162377
Ninja Zx-10R Abs Kbf-Kcf-Kdf-Kef	1000	11-14	10 060 3210	110130041	Agility R16	125	08	10 060 2311	00162377
Ninja Zx-10R Abs Kff-Kffa	1000	15	10 060 3210	110130041	Agility R16	125	09	10 060 2311	00162377
Ninja Zx-10R E8f-E9f	1000	08-09	10 060 3200	110130026	Agility R16	125	12	10 060 2311	00162377
Ninja Zx-10R Faf	1000	10	10 060 3200	110130026	B&W 125	125	00	10 060 3240	00162989
Ninja Zx-10R Jbf-Jcf-Jdf-Jef	1000	11-14	10 060 3210	110130041	B&W 125 Eu2	125	03-04	10 060 3240	00162989
Ninja Zx-10R Jff-Jffa	1000	15	10 060 3210	110130041	Dink 125	125	97-98	10 060 0752	00162953
Z1000 A1h-A3h	1000	03-05	10 060 3190	110131302	Dink 125 Eu3	125	06-07	10 060 0741	00162475
Z1000 A6f	1000	06	10 060 3190	110131302	Dink Classic 125	125	02	10 060 0732	00162993
Z1000 Abs C7f-C9f	1000	07-09	10 060 3190	110131302	Dink Classic 125 Eu2	125	03	10 060 0732	00162993
Z1000 Abs Eaf-Ebf-Ecf-Ecfa	1000	10-12	10 060 3180	110130040	Dink Lx 125	125	98-00	10 060 0732	00162993
Z1000 B7f-B9f	1000	07-09	10 060 3190	110131302	Downtown 125l	125	09-16	10 060 2581	00117199
Z1000 Daf-Das-Dbf-Dcf-Dcfa	1000	10-12	10 060 3180	110130040	Downtown E4	125	16	10 060 2591	00117245
KYMCO					G-Dink	125	12	10 060 2761	00117409
Agility 2T R16	50	10	10 060 1331	00162309	Grand Dink 125	125	01-02	10 060 0741	00162475
Agility 2T R16	50	12	10 060 1331	00162309	Grand Dink 125 Eu2	125	03-04	10 060 0741	00162475
Agility 4T Carry	50	11	10 060 2391	00164044	K-Xct I	125	12-14	10 060 2831	00117469
Agility 4T R10	50	06	10 060 2401	00163126	Like	125	09	10 060 2801	00117221
Agility 4T R10	50	07-08	10 060 2401	00163126	Like Lx	125	12	10 060 2801	00117221
Agility 4T R12	50	07-08	10 060 2391	00164044	Movie 125 Eu3	125	06-07	10 060 9341	00163996
Agility 4T R16	50	08	10 060 2451	00101074	Movie XL 125	125	01	10 060 9341	00163996
Agility 4T R16	50	09	10 060 2451	00101074	Movie XL 125 Eu2	125	03-04	10 060 9341	00163996
Agility 4T R16	50	12	10 060 2451	00101074	People 125	125	99-00	10 060 2311	00162377
Agility Plus 2T	50	14	10 060 1331	00162309	People 150 Eu2	125	03	10 060 2311	00162377
Agility R12	50	05	10 060 2391	00164044	People Eu3	125	07	10 060 2311	00162377
Agility Rs	50	09	10 060 2391	00164044	People Eu3	125	08	10 060 2311	00162377
B&W	50	02	10 060 1321	00163571	People Gti	125	10	10 060 2671	00117303
B&W Eu2	50	03	10 060 1321	00163571	People Gti	125	14	10 060 2671	00117303
Cx	50	93	10 060 0271	00163013	People One E4	125	16	10 060 2311	00162377
Cx Super	50	94-97	10 060 0271	00163013	People One I	125	13	10 060 2311	00162377
Dink 50 4T	50	07	10 060 2451	00101074	People One I Dd	125	15	10 060 2311	00162377
Dink Classic Eu2	50	03	10 060 1321	00163571	People S	125	05	10 060 2311	00162377
Dink Lc	50	98-02	10 060 1321	00163571	People S Dd Eu3	125	07-08	10 060 2311	00162377
Dj W	50	94-00	10 060 0271	00163013	Super 8	125	08	10 060 2311	00162377
Dj X	50	91-92	10 060 0271	00163013	Super 8	125	09	10 060 2311	00162377
Dj Y	50	93	10 060 0271	00163013	X-Town Cbs	125	16	10 060 2581	00117199
Fever Zx	50	99-00	10 060 0281	00163892	Agility R16	150	08	10 060 2311	00162377
Fever Zx Eu2	50	03-04	10 060 0281	00163892	Agility R16	150	09	10 060 2311	00162377
Heroism	50	95-97	10 060 0261	00166204	B&W 150	150	00	10 060 3240	00162989
Heroism	50	95-97	10 060 0521	00166204	B&W 150 Eu2	150	03-04	10 060 3240	00162989
K 12	50	95-00	10 060 0281	00163892	Dink 150	150	97-98	10 060 0752	00162953
Kb	50	95-00	10 060 0281	00163892	Dink Classic 150	150	02	10 060 0732	00162993
Like 4T	50	09	10 060 2701	00117213	Dink Classic 150 Eu2	150	03	10 060 0732	00162993
People	50	04	10 060 1331	00162309	Dink Lx 150	150	98-00	10 060 0732	00162993



FILTRI ARIA - RICERCA PER MARCA

AIR FILTERS - SEARCH BY MODEL

Modello - Model	Cc	Anno Year	Codice RMS RMS Code	Rif. Originale Orig. Ref.	Modello - Model	Cc	Anno Year	Codice RMS RMS Code	Rif. Originale Orig. Ref.
Grand Dink 150	150	01-02	10 060 0741	00162475	MALAGUTI				
Grand Dink 150 Eu2	150	03-04	10 060 0741	00162475	Centro Base	50	93-94	10 060 0061	06604500
Movie 150 Eu3	150	06-07	10 060 9341	00163996	Centro SL	50	94-98	10 060 0061	06604500
Movie XL 150	150	01	10 060 9341	00163996	Centro SL Kat	50	99-00	10 060 0061	06604500
Movie XL 150 Eu2	150	03-04	10 060 9341	00163996	Ciak	50	99-00	10 060 0831	06609100
People 125 Eu2	150	03	10 060 2311	00162377	Ciak Master	50	04	10 060 0831	06609100
People 150	150	99-00	10 060 2311	00162377	Ciak Master Eu2	50	06	10 060 0831	06609100
People Eu3	150	11	10 060 2311	00162377	Ciak Mono Eu2	50	03	10 060 0831	06609100
Agility 200l R16	200	10	10 060 2311	00162377	Ciak Mono Eu2 2.3	50	03	10 060 0831	06609100
Agility I Plus	200	14	10 060 2311	00162377	Ciak Td	50	00-01	10 060 0831	06609100
Agility R16	200	12	10 060 2311	00162377	Crosser Cr1	50	95-98	10 060 0291	06605500
Dink Classic	200	04	10 060 0732	00162993	F10 Ac	50	08	10 060 0061	06604500
Dink Eu3i	200	06-07	10 060 0741	00162475	F10 Ac Eco	50	09-10	10 060 0061	06604500
Downtown I	200	10	10 060 2581	00117199	F10 Jet Line	50	92-98	10 060 0061	06604500
Like 200l	200	09	10 060 2801	00117221	F10 Kat	50	99-00	10 060 0061	06604500
Like Lx	200	12	10 060 2801	00117221	F10 Restyling Eu1	50	01-02	10 060 0061	06604500
People Gti	200	10	10 060 2671	00117303	F10 Restyling Eu2-2.3	50	03-04	10 060 0061	06604500
People Gti	200	14	10 060 2671	00117303	F10 Restyling Eu2	50	02-03	10 060 0061	06604500
People S	200	05	10 060 2311	00162377	F10 Restyling Eu2	50	06	10 060 0061	06604500
People S 200l	200	07	10 060 2311	00162377	F12 Aria Restyling Eu2	50	06	10 060 0061	06604500
Grand Dink	250	01-02	10 060 0741	00162475	F12 Lc Restyling Eu2	50	06	10 060 0061	06604500
Grand Dink Eu2	250	03-04	10 060 0741	00162475	F12 Phantom	50	94-98	10 060 0061	06604500
People Lc	250	03-04	10 060 2431	00162380	F12 Phantom Eu1	50	99-00	10 060 0061	06604500
People S	250	06	10 060 2431	00162380	F12 Phantom Lc	50	94-98	10 060 0061	06604500
People S 250l	250	07	10 060 2431	00162380	F12 Phantom Lc Eu1	50	99-00	10 060 0061	06604500
X Citing	250	05	10 060 0741	00162475	F12 Phantom Lc Restyling Eu1	50	01-02	10 060 0061	06604500
X Citing I	250	06-07	10 060 0741	00162475	F12 Phantom Lc Restyling Eu2	50	02	10 060 0061	06604500
Downtown 300l	300	09	10 060 2591	00117245	F12 Phantom Lc Restyling Eu2-2.3	50	03-04	10 060 0061	06604500
Downtown Abs	300	10	10 060 2591	00117245	F12 Phantom Lc Twin Disks	50	98	10 060 0061	06604500
Downtown Abs I	300	11-16	10 060 2591	00117245	F12 Phantom Restyling Eu1	50	01-02	10 060 0061	06604500
Downtown I	300	11	10 060 2591	00117245	F12 Phantom Restyling Eu2	50	02	10 060 0061	06604500
G-Dink	300	12	10 060 2761	00117409	F12 Phantom Restyling Eu2-2.3	50	03-04	10 060 0061	06604500
K-Xct I	300	12	10 060 2831	00117469	F12r Phantom Ac	50	07-08	10 060 0061	06604500
K-Xct I Abs	300	14	10 060 2831	00117469	F12r Phantom Ac	50	09-10	10 060 0061	06604500
People Gti	300	10	10 060 2671	00117303	F12r Phantom Lc	50	07-10	10 060 0061	06604500
People Gti	300	11	10 060 2671	00117303	F15 Fire Fox	50	96-98	10 060 0301	06606600
People Gti	300	14	10 060 2671	00117303	F15 Fire Fox Air Cooled	50	05-06	10 060 0061	06604500
People Gti Abs	300	12	10 060 2671	00117303	F15 Fire Fox Eu2	50	02-03	10 060 0061	06604500
People Gti Abs	300	14	10 060 2671	00117303	F15 Fire Fox Restyling Eu2-2.3	50	03-04	10 060 0061	06604500
People Gti Abs E4	300	16	10 060 2671	00117303	F15 Fire Fox Twin Disks & Special	50	98-99	10 060 0301	06606600
People S 300l	300	08	10 060 2431	00162380	F15 Fire Fox Twin Disks Digit Kat	50	98-00	10 060 0301	06606600
X Citing 300l	300	08	10 060 0741	00162475	F15 Lc Restyling Euro 2	50	04-05	10 060 0061	06604500
X Citing 300l R	300	08	10 060 0741	00162475	F15 Lc-Tds Restyling Eu1	50	01	10 060 0301	06606600
X Citing 300l R	300	09	10 060 0741	00162475	Yesterday - Yesterday Eu	50	97-00	10 060 0061	06604500
Downtown Abs E4	350	16	10 060 2591	00117245	Ciak	100	99-00	10 060 0821	06608800
Downtown I Abs	350	15	10 060 2591	00117245	F12 Phantom	100	99-00	10 060 0821	06608800
X Citing I	400	13	10 060 2981	00117492	Blog	125	09-10	10 060 2501	65046700
X Citing I	400	15	10 060 2981	00117492	Blog	125	09-10	10 060 2511	65041100
X Citing I Abs	400	14	10 060 2981	00117492	Blog	125	11	10 060 2501	65046700
X Citing I Abs	400	15	10 060 2981	00117492	Blog	125	11	10 060 2511	65041100
X Citing	500	05	10 060 2921	00163096	Centro le	125	08-09	10 060 2501	65046700
X Citing 500 R	500	09	10 060 2921	00163096	Centro le	125	08-09	10 060 2511	65041100
X Citing 500l	500	08	10 060 2921	00163096	Centro SL	125	09-10	10 060 2501	65046700
X Citing 500l	500	06-07	10 060 2921	00163096	Centro SL	125	09-10	10 060 2511	65041100
X Citing 500l R	500	07-08	10 060 2921	00163096	Centro SL	125	11	10 060 2501	65046700
LIGIER					Centro SL	125	11	10 060 2511	65041100
Microcar	-	-	10 060 2320	-	Ciak	125	00-01	10 060 2311	06611003
LML					Ciak Master	125	04	10 060 2311	06611003
Star 125 4T Automatica	125	13-16	10 060 2181	-	Ciak Master Eu3	125	06	10 060 2311	06611003
Star 125 4T Automatica	125	13-16	10 060 2961	-	Ciak Restyling Eu2	125	03	10 060 2311	06611003
Star Lite 125 4T Automatica	125	16	10 060 2181	-	F18 Warrior	125	00-02	10 060 1201	06610300
Star Lite 125 4T Automatica	125	16	10 060 2961	-	Madison	125	99-01	10 060 0791	06612400
Star 150 4T	150	12	10 060 2181	-	Madison 3	125	06-09	10 060 0991	06614100
Star 150 4T	150	12	10 060 2961	-	Madison R Restyling	125	02	10 060 0791	06612400
Star 151 4T	150	12	10 060 2181	-	Madison R Restyling Eu2	125	03-04	10 060 0791	06612400
Star 151 4T	150	12	10 060 2961	-	Phantom Max	125	03	10 060 0791	06612400
					Ciak	150	00-02	10 060 2311	06611003
					Ciak Master	150	04	10 060 2311	06611003
					Ciak Restyling Eu2	150	03	10 060 2311	06611003



Modello - Model	Cc	Anno Year	Codice RMS RMS Code	Rif. Originale Orig. Ref.	Modello - Model	Cc	Anno Year	Codice RMS RMS Code	Rif. Originale Orig. Ref.
F18 Warrior	150	00-02	10 060 1201	06610300	Yp Skyliner	125	01-02	10 060 0871	5DS154070100
Madison T	150	99-01	10 060 0791	06612400	Yp Skyliner	125	98-00	10 060 0791	5DSE44510100
Blog	160	09-10	10 060 2501	65046700	Yp Skyliner	125	98-00	10 060 0871	5DS154070100
Blog	160	09-10	10 060 2511	65041100	Xn Doodo	150	01-02	10 060 0871	5DS154070100
Blog	160	11	10 060 2501	65046700	Xq Thunder	150	01-02	10 060 0791	5DSE44510000
Blog	160	11	10 060 2511	65041100	Xq Thunder	150	01-02	10 060 0871	5DS154070100
Centro Ie	160	08-09	10 060 2501	65046700	Yp Skyliner	150	00	10 060 0791	5DSE44510000
Centro Ie	160	08-09	10 060 2511	65041100	Yp Skyliner	150	00	10 060 0871	5DS154070100
Centro SL	160	09-10	10 060 2501	65046700	Yp Skyliner	150	01-02	10 060 0791	5DSE44510000
Centro SL	160	09-10	10 060 2511	65041100	Yp Skyliner	150	01-02	10 060 0871	5DS154070100
Centro SL	160	11	10 060 2501	65046700	Yp E Skyliner	180	03	10 060 0791	5DSE44510000
Centro SL	160	11	10 060 2511	65041100	Yp E Skyliner	180	03	10 060 0871	5DS154070100
Ciak Master Eu2	200	06	10 060 2311	06611003	Yp Skyliner	250	02-03	10 060 0331	4HC144510000
Madison S Restyling	200	02	10 060 0991	06614100	Yp Skyliner	250	02-03	10 060 2421	5GM154070000
Madison S Restyling Eu2	200	03	10 060 0991	06614100	Yp Skyliner	250	00-01	10 060 0331	4HC144510000
Phantom Max	200	03	10 060 0991	06614100	Yp Skyliner	250	00-01	10 060 2421	5GM154070000
Madison 3	250	06-09	10 060 0991	06614100	Yp Skyliner Abs	250	03	10 060 0331	4HC144510000
Madison Rs Restyling	250	04	10 060 0991	06614100	Yp Skyliner Abs	250	03	10 060 2421	5GM154070000
Madison S	250	99-01	10 060 0331	06608100	Xc Kilibre	300	03	10 060 0851	5SEE44510000
Madison S	250	99-01	10 060 2001	06607900	Xc Kilibre	300	03	10 060 2421	5GM154070000
Password	250	05-06	10 060 1211	06626100	PEUGEOT				
Password Eu3	250	07-08	10 060 1211	06626100	Zenith 25 Ma	25	95-97	10 060 0371	730199
Phantom Max	250	04	10 060 0991	06614100	Zenith 25 Na	25	98-00	10 060 0371	730199
Madison K	400	02	10 060 2021	06611700	Buxy 50	50	95-97	10 060 0371	730199
Madison K Restyling	400	02-04	10 060 2021	06611700	Buxy 50 Rs	50	96-97	10 060 0371	730199
Spidermax Gt	500	04-05	10 060 1141	06615400	Elyseo 50 45 Km/H	50	02-03	10 060 0371	730199
Spidermax Gt Eu3	500	06	10 060 1141	06615400	Elyseo 50 50 Km/H	50	01	10 060 0371	730199
Spidermax Rs	500	08	10 060 1141	06615400	Elyseo 50 50 Km/H	50	98-00	10 060 0371	730199
MBK					Elystar 50	50	10	10 060 0371	730199
Cw Booster	50	04	10 060 0311	3VLE44510100	Elystar 50	50	11	10 060 0371	730199
Cw Booster	50	01-02	10 060 0311	3VLE44510100	Elystar 50	50	12-14	10 060 0371	730199
Cw Booster	50	90-91	10 060 0311	3VLE44510100	Elystar 50 Advantage	50	06-07	10 060 0371	730199
Cw Booster (Ita)	50	92-94	10 060 0311	3VLE44510100	Elystar 50 Advantage	50	08-09	10 060 0371	730199
Cw Booster Naked	50	03	10 060 0311	3VLE44510100	Elystar 50 Sbc Tsd	50	03-07	10 060 0371	730199
Cw Booster Spirit	50	96-98	10 060 0311	3VLE44510100	Fox 50 L	50	95-97	10 060 0391	727905
Cw Booster Spirit (Ita)	50	00	10 060 0311	3VLE44510100	Looxor 50	50	02-06	10 060 0371	730199
Cw Booster Spirit (Ita)	50	99	10 060 0311	3VLE44510100	Looxor 50 Tsd	50	02-06	10 060 0371	730199
Cw Booster Spirit Eu2	50	02	10 060 0311	3VLE44510100	Metropolis Sc	50	91-97	10 060 0131	705260
Cw Booster Spirit Eu2	50	03	10 060 0311	3VLE44510100	Speedake 50	50	95-97	10 060 0371	730199
Cw L Booster	50	01-03	10 060 0311	3VLE44510100	Speedfight 1 50 Ac Dt	50	97-98	10 060 0371	730199
Cw L Booster Spirit	50	03	10 060 0311	3VLE44510100	Speedfight 1 50 Ac Dt	50	99-00	10 060 0371	730199
Cw R Booster Road (Ita)	50	94-95	10 060 0311	3VLE44510100	Speedfight 1 50 Lc Dd	50	99	10 060 0371	730199
Cw Rs Booster Ng	50	03	10 060 0311	3VLE44510100	Speedfight 1 50 Lc Dd	50	99-00	10 060 0371	730199
Cw Rs Booster Ng	50	01-02	10 060 0311	3VLE44510100	Speedfight 1 50 Lc Dt	50	97-98	10 060 0371	730199
Cw Rs Booster Ng (Ita)	50	99	10 060 0311	3VLE44510100	Speedfight 2 50 Ac Dd Ultimate Edition	50	08-09	10 060 0371	730199
Cw Rs Booster Ng (Ita)	50	95-98	10 060 0311	3VLE44510100	Speedfight 2 50 Ac Dt	50	01-09	10 060 0371	730199
Cw Rs Booster Ng Eu1	50	99-00	10 060 0311	3VLE44510100	Speedfight 2 50 Ac Dt Iron-X	50	07	10 060 0371	730199
Cw Rsp Booster Rocket (Ita)	50	97-98	10 060 0311	3VLE44510100	Speedfight 2 50 Ac Dt Motor Sport	50	07	10 060 0371	730199
Cw Rxs Booster Track (Ita)	50	96-98	10 060 0311	3VLE44510100	Speedfight 2 50 Ac Dt Rally Victories	50	06-07	10 060 0371	730199
Cw Sp Booster Spirit Eu2	50	02	10 060 0311	3VLE44510100	Speedfight 2 50 Ac Dt Rcup	50	07-09	10 060 0371	730199
Ew Stunt	50	00-02	10 060 0311	3VLE44510100	Speedfight 2 50 Ac Dt Silver Sport	50	04	10 060 0371	730199
Ye Evolis (Ita)	50	92-93	10 060 0061	3KJ144510000	Speedfight 2 50 Ac Dt Silver Sport	50	05-07	10 060 0371	730199
Ye Evolis (Ita)	50	94-95	10 060 0061	3KJ144510000	Speedfight 2 50 Ac Dt Wrc 307	50	05	10 060 0371	730199
Yh Flipper	50	98	10 060 0351	5EUE44510000	Speedfight 2 50 Lc Dd	50	01-09	10 060 0371	730199
Yh Flipper	50	01-02	10 060 0351	5EUE44510000	Speedfight 2 50 Lc Dd Furious	50	03	10 060 0371	730199
Yh Flipper Catalitico	50	99-00	10 060 0351	5EUE44510000	Speedfight 2 50 Lc Dd Iron-X	50	07	10 060 0371	730199
Yh Flipper Eu2	50	03-04	10 060 0351	5EUE44510000	Speedfight 2 50 Lc Dd Motor Sport	50	07	10 060 0371	730199
Ym Fizz (Ita)	50	94-95	10 060 0061	3KJ144510000	Speedfight 2 50 Lc Dd Rally Victories	50	06-07	10 060 0371	730199
Xc Flame F	125	00	10 060 2011	4CWE54071000	Speedfight 2 50 Lc Dd Rcup	50	07-09	10 060 0371	730199
Xc K Flame R	125	96-99	10 060 0801	4CWE44510200	Speedfight 2 50 Lc Dd Silver Sport	50	04	10 060 0371	730199
Xc K Flame R	125	96-99	10 060 2011	4CWE54071000	Speedfight 2 50 Lc Dd Silver Sport	50	05-07	10 060 0371	730199
Xc T Flame	125	95-99	10 060 0801	4CWE44510200	Speedfight 2 50 Lc Dd Ultimate Edition	50	08-09	10 060 0371	730199
Xc T Flame	125	95-99	10 060 2011	4CWE54071000	Speedfight 2 50 Lc Dd Wrc 206	50	03-04	10 060 0371	730199
Xn Doodo	125	00-01	10 060 0871	5DS154070100	Speedfight 2 50 Lc Dd Wrc 307	50	05	10 060 0371	730199
Xq Thunder	125	01-02	10 060 0791	5DSE44510000	Speedfight 2 50 Lc Dd X-Race	50	01	10 060 0371	730199
Xq Thunder	125	01-02	10 060 0871	5DS154070100	Speedfight 2 50 Lc Dd X-Race	50	02	10 060 0371	730199
Yp E Skyliner	125	03	10 060 0791	5DSE44510000	Speedfight 2 50 Lc Dd X-Race	50	03	10 060 0371	730199
Yp E Skyliner	125	03	10 060 0871	5DS154070100	Squab 50	50	96-97	10 060 0371	730199
Yp Skyliner	125	01-02	10 060 0791	5DSE44510000	Sv 50 Tt	50	93-97	10 060 0361	724064



FILTRI ARIA - RICERCA PER MARCA

AIR FILTERS - SEARCH BY MODEL

Modello - Model	Cc	Anno Year	Codice RMS RMS Code	Rif. Originale Orig. Ref.	Modello - Model	Cc	Anno Year	Codice RMS RMS Code	Rif. Originale Orig. Ref.
Sv 50 Tt Junior	50	93-96	10 060 0361	724064	Ape Rst Mix	50	99-03	10 060 0610	260569
Tkr 50	50	01-11	10 060 0371	730199	Ape Tm P	50	85-89	10 060 0610	260569
Tkr 50 12 Pollici	50	10-11	10 060 0371	730199	Bravo 3	50	87-90	10 060 3063	1834235
Tkr 50 Furious	50	03-04	10 060 0371	730199	Bravo Erre 2	50	75-81	10 060 3063	1834235
Tkr 50 Furious	50	05-08	10 060 0371	730199	Ciao	50	80-88	10 060 3063	1834235
Tkr 50 Furious	50	09-11	10 060 0371	730199	Ciao Eu1	50	99-01	10 060 3063	1834235
Tkr 50 Furious 12 Inch	50	10-11	10 060 0371	730199	Ciao Eu2	50	02-04	10 060 3063	1834235
Tkr 50 Metal-X	50	02	10 060 0371	730199	Ciao Mix Teen	50	96-01	10 060 3063	1834235
Tkr 50 Metal-X	50	03	10 060 0371	730199	Diesis	50	01	10 060 0921	487719
Tkr 50 Rally Victories	50	06-07	10 060 0371	730199	Diesis	50	01	10 060 1191	486942
Tkr 50 Rcup	50	08-09	10 060 0371	730199	Fly 2T	50	05-07	10 060 0921	487719
Tkr 50 Streetboard	50	01	10 060 0371	730199	Fly 2T	50	05-07	10 060 1191	486942
Tkr 50 Streetzone	50	03	10 060 0371	730199	Fly 2T	50	10-11	10 060 0921	487719
Tkr 50 Wrc 307	50	05	10 060 0371	730199	Fly 2T	50	10-11	10 060 1191	486942
Trekker 50 Off Road	50	98-00	10 060 0371	730199	Fly 4T	50	05-07	10 060 1161	843194
Trekker 50 Road	50	98-00	10 060 0371	730199	Fly 4T	50	05-07	10 060 1181	832972
Trekker 50 Streetboard	50	99-00	10 060 0371	730199	Fly 4T & 25-30 Km/H	50	08-11	10 060 1161	843194
V-Clic 50 4T Silver Sport	50	08	10 060 0521	-	Fly 4T & 25-30 Km/H	50	08-11	10 060 1181	832972
Vivacity 50	50	02	10 060 0371	730199	Fly 4T 2V	50	13-15	10 060 1161	843194
Vivacity 50	50	03-04	10 060 0371	730199	Fly 4T 2V	50	13-15	10 060 1181	832972
Vivacity 50	50	99-01	10 060 0371	730199	Fly 4T 2V 25-30Km-H	50	12-14	10 060 1161	843194
Vivacity 50 2	50	05-09	10 060 0371	730199	Fly 4T 2V 25-30Km-H	50	12-14	10 060 1181	832972
Vivacity 50 2 Blueline	50	05	10 060 0371	730199	Fly 4T 4V	50	12-13	10 060 1161	843194
Vivacity 50 2 Compact	50	05	10 060 0371	730199	Fly 4T 4V	50	12-13	10 060 1181	832972
Vivacity 50 2 Compact	50	06	10 060 0371	730199	Fly 4T Motore Chn	50	06-07	10 060 1161	843194
Vivacity 50 2 Compact	50	07	10 060 0371	730199	Fly 4T Motore Chn	50	06-07	10 060 1181	832972
Vivacity 50 2 Motorsport	50	07-09	10 060 0371	730199	Free	50	92-94	10 060 0461	431587
Vivacity 50 2 Rs	50	08	10 060 0371	730199	Free Delivery	50	00-01	10 060 0461	431587
Vivacity 50 2 Silver Sport	50	05	10 060 0371	730199	Free FL	50	95-02	10 060 0461	431587
Vivacity 50 2 Silver Sport	50	06	10 060 0371	730199	Grillo	50	89-93	10 060 3063	1834235
Vivacity 50 2 Silver Sport	50	07	10 060 0371	730199	Liberty	50	97-05	10 060 0401	482738
Vivacity 50 2 Sportline 4	50	06-09	10 060 0371	730199	Liberty	50	97-05	10 060 1191	486942
Vivacity 50 2T	50	09-13	10 060 2481	730199	Liberty 2T	50	06	10 060 0921	487719
Vivacity 50 Blueline	50	04	10 060 0371	730199	Liberty 2T	50	06	10 060 1191	486942
Vivacity 50 Compact	50	03-04	10 060 0371	730199	Liberty 2T	50	07-08	10 060 0921	487719
Vivacity 50 Silver Sport	50	04	10 060 0371	730199	Liberty 2T	50	07-08	10 060 1191	486942
Vivacity 50 Sportline	50	01	10 060 0371	730199	Liberty 2T Rst	50	04	10 060 0921	487719
Vivacity 50 Sportline 2	50	02	10 060 0371	730199	Liberty 2T Rst	50	04	10 060 1191	486942
Vivacity 50 Sportline 3	50	03	10 060 0371	730199	Liberty 2T Sport	50	06	10 060 0921	487719
Vivacity2 50	50	05-09	10 060 0371	730199	Liberty 2T Sport	50	06	10 060 1191	486942
Vivacity2 50 Blueline	50	05	10 060 0371	730199	Liberty 2T Sport	50	07-08	10 060 0921	487719
Vivacity2 50 Compact	50	05-07	10 060 0371	730199	Liberty 2T Sport	50	07-08	10 060 1191	486942
Vivacity2 50 Motorsport	50	07-09	10 060 0371	730199	Liberty 4T	50	05-08	10 060 0911	875525
Vivacity2 50 Rs	50	08	10 060 0371	730199	Liberty 4T	50	05-08	10 060 1181	832972
Vivacity2 50 Silver Sport	50	05-07	10 060 0371	730199	Liberty 4T	50	00-02	10 060 0911	487287
Vivacity2 50 Sportline 4	50	06-09	10 060 0371	730199	Liberty 4T Delivery - Single	50	10-14	10 060 0911	875525
Xr7 50	50	08-11	10 060 0511	-	Liberty 4T Delivery - Single	50	10-14	10 060 1181	832972
Zenith 50 Lm	50	96-97	10 060 0371	730199	Liberty 4T Delivery Tnt	50	09	10 060 0911	875525
Zenith 50 Ln	50	98	10 060 0371	730199	Liberty 4T Delivery Tnt	50	09	10 060 1181	832972
Zenith 50 M	50	95-97	10 060 0371	730199	Liberty 4T Ptt - Double - Nexive	50	09-15	10 060 0911	875525
Zenith 50 N	50	98-00	10 060 0371	730199	Liberty 4T Ptt - Double - Nexive	50	09-15	10 060 1181	832972
Elyseo 100	100	01	10 060 0701	737351	Liberty 4T Ptt (Deu)	50	07-12	10 060 0911	875525
Elyseo 100	100	98-00	10 060 0701	737351	Liberty 4T Ptt (Deu)	50	07-12	10 060 1181	832972
Speedfight 1 100	100	98-00	10 060 0701	737351	Liberty 4T Rst	50	04	10 060 0911	487287
Sv 100	100	98	10 060 0361	724064	Liberty 4T Rst	50	04	10 060 1181	832972
Trekker 100 Road	100	98-00	10 060 0701	737351	Liberty 4T Sport	50	06	10 060 0911	487287
Vivacity 100	100	99-02	10 060 0701	737351	Liberty 4T Sport	50	06	10 060 1181	832972
Elyseo 125 Dd	125	01-03	10 060 0691	737534	Liberty 4T Sport	50	07-08	10 060 0911	875525
Elyseo 125 Dt	125	98-00	10 060 0691	737534	Liberty 4T Sport	50	07-08	10 060 1181	832972
Looxor 125	125	02-06	10 060 0931	747486	Liberty Iget 4T 3V 25Km/H	50	16	10 060 3011	1A005015
Elyseo 150	150	01-03	10 060 0691	737534	Liberty Iget 4T 3V Ie	50	15-17	10 060 3011	1A005015
Looxor 150	150	02-06	10 060 0931	747486	Liberty Moc 2T & Elle	50	09-13	10 060 0921	487719
PIAGGIO					Liberty Moc 2T & Elle	50	09-13	10 060 1191	486942
Ape	50	09-16	10 060 1191	486942	Liberty Moc 4T & Elle	50	09-16	10 060 0911	875525
Ape	50	09-16	10 060 0610	260569	Liberty Moc 4T & Elle	50	09-16	10 060 1181	832972
Ape FL - FL2	50	89-95	10 060 0610	260569	Liberty Ptt Eu2	50	04-05	10 060 0921	487719
Ape FL3 Europa	50	96-99	10 060 0610	260569	Liberty Ptt Eu2	50	04-05	10 060 1191	486942
Ape Mix 2T	50	98-08	10 060 0610	295322	Nrg	50	94-96	10 060 0091	433437
Ape P	50	80-85	10 060 0610	260569	Nrg Extreme	50	99-00	10 060 0111	479748

FILTRI ARIA - RICERCA PER MARCA

AIR FILTERS - SEARCH BY MODEL



Modello - Model	Cc	Anno Year	Codice RMS RMS Code	Rif. Originale Orig. Ref.	Modello - Model	Cc	Anno Year	Codice RMS RMS Code	Rif. Originale Orig. Ref.
Nrg Mc3	50	01-04	10 060 0111	479748	Vespa S 4T-4V & College	50	08-12	10 060 1181	832972
Nrg Mc3	50	01-04	10 060 0921	487719	Vespa Sprint 2T 2V	50	14-16	10 060 0921	487719
Nrg Mc3	50	01-04	10 060 1191	486942	Vespa Sprint 2T 2V	50	14-16	10 060 1191	486942
Nrg Power Dd	50	05	10 060 0921	487719	Vespa Sprint 4T 4V	50	14-16	10 060 1161	843194
Nrg Power Dd	50	05	10 060 1191	486942	Vespa Sprint 4T 4V	50	14-16	10 060 1181	832972
Nrg Power Dd	50	06	10 060 0921	487719	Zip	50	00-04	10 060 0921	487719
Nrg Power Dd	50	06	10 060 1191	486942	Zip	50	00-04	10 060 1191	486942
Nrg Power Dd	50	07-15	10 060 0921	487719	Zip	50	92-93	10 060 0431	834741
Nrg Power Dd	50	07-15	10 060 1191	486942	Zip	50	95-96	10 060 0431	431838
Nrg Power Dd Serie Speciale	50	07-12	10 060 0921	487719	Zip 2T	50	08-13	10 060 0921	487719
Nrg Power Dd Serie Speciale	50	07-12	10 060 1191	486942	Zip 2T	50	08-13	10 060 1191	486942
Nrg Power Dt	50	06	10 060 0921	487719	Zip 4T	50	06-13	10 060 0431	834741
Nrg Power Dt	50	06	10 060 1191	486942	Zip 4T	50	06-13	10 060 1181	832972
Nrg Power Dt	50	07-15	10 060 0921	487719	Zip 4T	50	00-05	10 060 0431	834741
Nrg Power Dt	50	07-15	10 060 1191	486942	Zip 4T	50	00-05	10 060 1181	832972
Nrg Power Dt Serie Speciale	50	07-08	10 060 0921	487719	Zip Fast Raider	50	93-94	10 060 0431	431838
Nrg Power Dt Serie Speciale	50	07-08	10 060 1191	486942	Zip Fast Raider Rst	50	96-97	10 060 0441	478536
Nrg Power Purejet	50	06-11	10 060 0111	479748	Zip Rst	50	96-99	10 060 0441	478536
Nrg Purejet	50	10	10 060 0111	479748	Zip Sp	50	01-04	10 060 0921	487719
Nrg Purejet	50	02-04	10 060 0111	479748	Zip Sp	50	96-00	10 060 0441	478536
Nrg Rst Mc2	50	96-98	10 060 0091	433437	Zip Sp Eu2	50	06-13	10 060 0921	487719
Nrg Rst Mc2	50	96-98	10 060 0111	479748	Zip Sp Eu2	50	06-13	10 060 1191	486942
Ntt	50	95-96	10 060 0091	433437	Skr City	80	99	10 060 0081	478240
Quartz	50	92-96	10 060 0481	431780	Fly 4T	100	08	10 060 1161	843194
Sfera	50	91-93	10 060 0411	257369	Fly 4T	100	08	10 060 1181	832972
Sfera Maquillage 2	50	94	10 060 0411	257369	Fly 4T	100	06-07	10 060 1161	843194
Sfera Rst	50	95-97	10 060 0421	436478	Fly 4T	100	06-07	10 060 1181	832972
Si	50	79-88	10 060 3063	1834235	Free	100	02-03	10 060 0461	431587
Si FL2	50	91-97	10 060 3063	1834235	Zip 4T	100	06-10	10 060 0431	834741
Si Mix	50	96-99	10 060 3063	1834235	Zip 4T	100	06-10	10 060 1181	832972
Superbravo	50	85-90	10 060 3063	1834235	Beverly	125	01-03	10 060 0991	829258
Superbravo 3	50	87-90	10 060 3063	1834235	Beverly Eu3	125	07-08	10 060 0991	829258
Typhoon	50	01-04	10 060 0921	487719	Beverly Eu3	125	07-08	10 060 2561	842093
Typhoon	50	05-08	10 060 0921	487719	Beverly Eu3 Mic	125	07	10 060 0991	829258
Typhoon	50	05-08	10 060 1191	486942	Beverly Eu3 Mic	125	07	10 060 2561	842093
Typhoon	50	09-11	10 060 0921	487719	Beverly Eu3 Sport	125	07-08	10 060 0991	829258
Typhoon	50	09-11	10 060 1191	486942	Beverly Eu3 Sport	125	07-08	10 060 2561	842093
Typhoon 2T Eu2	50	10-16	10 060 0921	487719	Beverly Rst	125	04-05	10 060 0991	829258
Typhoon 2T Eu2	50	10-16	10 060 1191	486942	Beverly Rst	125	04-05	10 060 2561	842093
Typhoon 2T Eu3 Ch	50	11	10 060 0921	487719	Beverly Rst	125	05-07	10 060 0991	829258
Typhoon 2T Eu3 Ch	50	11	10 060 1191	486942	Beverly Rst	125	05-07	10 060 2561	842093
Vespa Et2	50	97-05	10 060 0421	436478	Beverly Rst 4T 4V le Eu3	125	10-15	10 060 0991	829258
Vespa Et2	50	97-05	10 060 1191	486942	Beverly Tourer Eu3	125	07-10	10 060 0991	829258
Vespa Et2 Iniezione	50	97-00	10 060 0421	436478	Beverly Tourer Eu3	125	07-10	10 060 2561	842093
Vespa Et4	50	00-05	10 060 0891	487401	Carnaby	125	07-10	10 060 0991	829258
Vespa Et4	50	00-05	10 060 1181	832972	Carnaby	125	07-10	10 060 2561	842093
Vespa Lx 2T	50	09-13	10 060 0921	487719	Cosa 1 125	125	88-91	10 060 0501	252971
Vespa Lx 2T	50	09-13	10 060 1191	486942	Cosa 1 125 Elestart	125	88	10 060 0501	252971
Vespa Lx 2T	50	05-08	10 060 0921	487719	Cosa 2	125	91-97	10 060 0501	252971
Vespa Lx 2T	50	05-08	10 060 1191	486942	Cosa 2	125	91-97	10 060 2810	2853525
Vespa Lx 2T Touring & 30Km	50	10-13	10 060 0921	487719	Cosa 2 125	125	91-97	10 060 0501	252971
Vespa Lx 2T Touring & 30Km	50	10-13	10 060 1191	486942	Cosa CL-CLX	125	88-91	10 060 0501	252971
Vespa Lx 4T	50	05-09	10 060 1161	843194	Cosa CL-CLX	125	88-91	10 060 2810	2853525
Vespa Lx 4T	50	05-09	10 060 1181	832972	Fly	125	05-07	10 060 1161	843194
Vespa Lx 4T-4V	50	09-13	10 060 1161	843194	Fly	125	05-07	10 060 1171	832703
Vespa Lx 4T-4V	50	09-13	10 060 1181	832972	Fly 4T 3V le E3 Dt	125	13-15	10 060 3031	B017901
Vespa Lx 4T-4V Touring	50	10-13	10 060 1161	843194	Fly 4T 3V le E3 Dt	125	13-15	10 060 0451	B017901
Vespa Lx 4T-4V Touring	50	10-13	10 060 1181	832972	Fly Eu3	125	07	10 060 1161	843194
Vespa Lxv 2T	50	06-09	10 060 0921	487719	Fly Eu3	125	07	10 060 1171	832703
Vespa Lxv 2T	50	06-09	10 060 1191	486942	Fly Eu3	125	08-11	10 060 1161	843194
Vespa Lxv 2T Navy	50	08	10 060 0921	487719	Fly Eu3	125	08-11	10 060 1171	832703
Vespa Lxv 2T Navy	50	08	10 060 1191	486942	Hexagon	125	94-97	10 060 0471	434364
Vespa Primavera 2T	50	13-16	10 060 0921	487719	Hexagon Gtx	125	00	10 060 1141	487845
Vespa Primavera 2T	50	13-16	10 060 1191	486942	Hexagon Lx4	125	98-99	10 060 0421	436478
Vespa Primavera 4T-4V	50	13-16	10 060 1161	843194	Hexagon Lx-Lxt	125	98-99	10 060 0471	434364
Vespa Primavera 4T-4V	50	13-16	10 060 1181	832972	Liberty	125	01-02	10 060 0911	487287
Vespa S 2T & College	50	07-12	10 060 0921	487719	Liberty	125	98-00	10 060 0421	436478
Vespa S 2T & College	50	07-12	10 060 1191	486942	Liberty 4T	125	06-07	10 060 0911	875525
Vespa S 4T-4V & College	50	08-12	10 060 1161	843194	Liberty 4T	125	06-07	10 060 1171	832703



FILTRI ARIA - RICERCA PER MARCA

AIR FILTERS - SEARCH BY MODEL

Modello - Model	Cc	Anno Year	Codice RMS RMS Code	Rif. Originale Orig. Ref.	Modello - Model	Cc	Anno Year	Codice RMS RMS Code	Rif. Originale Orig. Ref.
Liberty 4T	125	06-07	10 060 2561	842093	Vespa Pk 125	125	82	10 060 2753	113125
Liberty 4T 2V Eu3	125	09-12	10 060 1161	843194	Vespa Primavera 4T 3V Iget Abs	125	16	10 060 3041	B018070
Liberty 4T 2V Eu3	125	09-12	10 060 1171	832703	Vespa Px	125	11-16	10 060 1191	486942
Liberty 4T 2V Eu3	125	09-12	10 060 2561	842093	Vespa Px	125	98-01	10 060 2810	2853525
Liberty 4T 2V Ie Ptt - Ita	125	12-13	10 060 0911	487287	Vespa Px 125	125	11-16	10 060 1191	486942
Liberty 4T Eu3	125	06-08	10 060 0911	487287	Vespa Px 125	125	11-16	10 060 2753	113125
Liberty 4T Eu3	125	06-08	10 060 1171	832703	Vespa Px 125 30 Anni	125	07-08	10 060 2753	113125
Liberty 4T Eu3 Delivery - Single	125	07-15	10 060 0911	875525	Vespa Px 125 E Arcobaleno	125	83	10 060 2753	113125
Liberty 4T Eu3 Delivery - Single	125	07-15	10 060 1171	832703	Vespa Px 125 E Elestart	125	84	10 060 2753	113125
Liberty 4T Eu3 Delivery - Tnt - Nexive	125	08-15	10 060 0911	875525	Vespa Px 125 E Freno A Disco	125	98-01	10 060 2753	113125
Liberty 4T Eu3 Delivery - Tnt - Nexive	125	08-15	10 060 1171	832703	Vespa Px 125 Eu2	125	07-08	10 060 2753	113125
Liberty 4T Sport Eu3	125	06-08	10 060 0911	875525	Vespa Px 30 Anni	125	07-08	10 060 1191	486942
Liberty 4T Sport Eu3	125	06-08	10 060 1171	832703	Vespa Px Eu2	125	01-07	10 060 2810	285352
Liberty 4T Sport Eu3	125	06-08	10 060 2561	842093	Vespa Pxe Arcobaleno	125	81-97	10 060 2810	2853525
Liberty Iget 4T 3V Ie	125	15-17	10 060 3011	1A005015	Vespa S 4T 3V Ie	125	12	10 060 2821	B016409
Liberty Rst	125	04-05	10 060 0911	487287	Vespa S 4T Eu3	125	07-08	10 060 1161	843194
Liberty Rst	125	04-05	10 060 1171	832703	Vespa S 4T Eu3	125	07-08	10 060 1171	832703
Liberty Rst Ptt	125	05-11	10 060 0911	487287	Vespa S 4T Ie & College	125	09-11	10 060 1161	843194
Liberty Rst Ptt	125	05-11	10 060 1171	832703	Vespa Sprint 4T 3V Ie	125	14-15	10 060 3041	B018070
Liberty Rst Ptt	125	05-11	10 060 2561	842093	Vespa Sprint Iget 4T 3V Abs	125	16	10 060 3041	B018070
Liberty Sport	125	06	10 060 0911	875525	X Evo	125	07-16	10 060 2111	831997
Liberty Sport	125	06	10 060 1171	832703	X10 4T 4V Ie Eu3	125	12-13	10 060 0991	829258
Liberty Sport	125	06	10 060 2561	842093	X7 Eu3	125	08	10 060 0991	829258
Medley 4T Ie Abs	125	16	10 060 3250	1A005072	X7 Eu3	125	08	10 060 2561	842093
Medley 4T Ie Abs	125	16	10 060 3250	1A007267	X7 Evo Ie Eu3	125	09-10	10 060 0991	829258
Mp3	125	06-08	10 060 2111	831997	X8	125	04	10 060 2111	831997
Mp3 Ibrido	125	09-10	10 060 2111	831997	X8	125	05-06	10 060 2111	831997
Mp3 Ie	125	08-09	10 060 2111	831997	X8 Premium Eu2	125	06	10 060 2111	831997
Mp3 Ie Touring	125	11-12	10 060 2111	831997	X8 Premium Eu3	125	06-07	10 060 2111	831997
Mp3 Yourban Erl	125	11-13	10 060 0991	829258	X8 Street Eu2	125	06-07	10 060 1161	843194
Sfera	125	95-97	10 060 0421	436478	X8 Street Eu2	125	06-07	10 060 1171	832703
Skipper	125	94-97	10 060 0081	478240	X8 Street Eu2	125	06-07	10 060 2561	842093
Skipper 4T	125	00-02	10 060 0891	487401	X9	125	01-02	10 060 0881	827936
Skipper Lx	125	98-99	10 060 0121	480084	X9 Evolution	125	03	10 060 0991	829258
Super Hexagon Gtx 12	125	01-02	10 060 1141	487845	X9 Evolution	125	05-06	10 060 2111	831997
Typhoon 4T 2V Eu3	125	10-11	10 060 1161	843194	X9 Evolution Eu3	125	07	10 060 2111	831997
Typhoon 4T 2V Eu3	125	10-11	10 060 1171	832703	Zip	125	00-02	10 060 0901	827694
Typhoon 4T 2V Eu3	125	10-11	10 060 2561	842093	Zip	125	00-02	10 060 0981	827694
Vespa Et4	125	96-98	10 060 0421	436478	Cosa 1 150	150	88-91	10 060 0501	252971
Vespa Et4	125	99-02	10 060 0891	487401	Cosa 2 150	150	91-97	10 060 0501	252971
Vespa Granturismo	125	03-05	10 060 2111	831997	Fly	150	05-07	10 060 1161	843194
Vespa Granturismo	125	06-07	10 060 2111	831997	Fly	150	05-07	10 060 1171	832703
Vespa Granturismo	125	06-07	10 060 2561	842093	Fly Eu3	150	08-11	10 060 1161	843194
Vespa Granturismo Eu3	125	06-07	10 060 2111	831997	Fly Eu3	150	08-11	10 060 1171	832703
Vespa Granturismo Eu3	125	06-07	10 060 2561	842093	Liberty 4T Eu3	150	08	10 060 0911	875525
Vespa Gts 4T Ie Super	125	09-16	10 060 2111	831997	Liberty 4T Eu3	150	08	10 060 1171	832703
Vespa Gts Eu3	125	07-12	10 060 2111	831997	Liberty 4T Eu3	150	08	10 060 2561	842093
Vespa Gts Eu3	125	07-12	10 060 2561	842093	Liberty 4T Sport Eu3	150	08	10 060 0911	875525
Vespa Gtv	125	06-08	10 060 2111	831997	Liberty 4T Sport Eu3	150	08	10 060 1171	832703
Vespa Gtv	125	06-08	10 060 2561	842093	Liberty 4T Sport Eu3	150	08	10 060 2561	842093
Vespa Gtv 4T Navy Eu3	125	08	10 060 2111	831997	Liberty Iget 4T 3V Ie	150	15-17	10 060 3011	1A005015
Vespa Gtv 4T Navy Eu3	125	08	10 060 2561	842093	Liberty Moc 4T Eu3	150	09-13	10 060 1161	843194
Vespa Lx	125	05-06	10 060 1161	843194	Liberty Moc 4T Eu3	150	09-13	10 060 1171	832703
Vespa Lx	125	05-06	10 060 1171	832703	Liberty Moc 4T Eu3	150	09-13	10 060 2561	842093
Vespa Lx 4T 3V Ie - Touring	125	12-13	10 060 2821	B016409	Medley 4T Ie Abs	150	16	10 060 3250	1A005072
Vespa Lx 4T Eu3 Touring	125	10-11	10 060 1161	843194	Vespa Lt 4T 3V Ie	150	14	10 060 3041	B018070
Vespa Lx 4T FL	125	09	10 060 1161	843194	Vespa Lx	150	05-06	10 060 1161	843194
Vespa Lx 4T FL	125	09	10 060 1171	832703	Vespa Lx	150	05-06	10 060 1171	832703
Vespa Lx Eu3	125	06-08	10 060 1161	843194	Vespa Lx 4T 3V Ie - Touring	150	12-13	10 060 2821	B016409
Vespa Lx Eu3	125	06-08	10 060 1171	832703	Vespa Lx 4T 3V Ie - Touring	150	12-13	10 060 3041	B018070
Vespa Lx Eu3 Ie	125	09-11	10 060 1161	843194	Vespa Lx 4T FL	150	09	10 060 1161	843194
Vespa Lx Primavera 4T 3V Ie	125	13-16	10 060 3041	B018070	Vespa Lx 4T FL	150	09	10 060 1171	832703
Vespa Lxv 4T Eu3	125	06-09	10 060 1161	843194	Vespa Lx Eu3	150	06-08	10 060 1161	843194
Vespa Lxv 4T Eu3	125	06-09	10 060 1171	832703	Vespa Lx Eu3	150	06-08	10 060 1171	832703
Vespa Lxv 4T Navy Eu3	125	07-08	10 060 1161	843194	Vespa Lx Eu3 Ie	150	09-11	10 060 1161	843194
Vespa Lxv 4T Navy Eu3	125	07-08	10 060 1171	832703	Vespa Lx Touring	150	10-12	10 060 1161	843194
Vespa Lxv Ie 4T	125	10-13	10 060 1161	843194	Vespa P 150 X	150	78-81	10 060 2753	113125
Vespa P 125 E	125	81	10 060 2753	113125	Vespa Primavera 4T 3V Iget Abs	150	16	10 060 3041	B018070
Vespa P 125 X	125	77-82	10 060 2753	113125	Vespa Primavera 4T-3V	150	13-16	10 060 3041	B018070

FILTRI ARIA - RICERCA PER MARCA

AIR FILTERS - SEARCH BY MODEL



Modello - Model	Cc	Anno Year	Codice RMS RMS Code	Rif. Originale Orig. Ref.	Modello - Model	Cc	Anno Year	Codice RMS RMS Code	Rif. Originale Orig. Ref.
Vespa Px	150	11-16	10 060 1191	486942	Vespa Gtv	250	06-09	10 060 2561	842093
Vespa Px 150	150	11-16	10 060 1191	486942	Vespa Gtv 4T Navy Eu3	250	07	10 060 2111	831997
Vespa Px 150	150	11-16	10 060 2753	113125	Vespa Gtv 4T Navy Eu3	250	07	10 060 2561	842093
Vespa Px 150 E	150	81	10 060 2753	113125	X Evo	250	07-16	10 060 2111	831997
Vespa Px 150 E Arcobaleno	150	83	10 060 2753	113125	X7 Eu3	250	08	10 060 0991	829258
Vespa Px 150 E Elestart	150	84	10 060 2753	113125	X7 Eu3	250	08	10 060 2561	842093
Vespa Px 150 E Freno A Disco	150	98-01	10 060 2753	113125	X8 Eu3	250	05-08	10 060 2111	831997
Vespa S 4T	150	08-09	10 060 1161	843194	X9	250	00-01	10 060 0781	496406
Vespa S 4T	150	08-09	10 060 1171	832703	X9 Evolution	250	04	10 060 0991	829258
Vespa S 4T le & Colloge	150	09-12	10 060 1161	843194	X9 Evolution	250	04	10 060 1221	840476
Vespa Sprint 4T 3V le	150	15	10 060 3041	8018070	X9 Evolution	250	06	10 060 1221	840476
Vespa Sprint Sport 4T 3V Iget Abs	150	16	10 060 3041	8018070	X9 Evolution	250	06	10 060 2111	831997
X8 Street Eu2	150	06-08	10 060 1161	843194	Beverly le Abs E4	300	16	10 060 0991	829258
X8 Street Eu2	150	06-08	10 060 1171	832703	Beverly Rst 4T 4V le Eu3	300	10-15	10 060 0991	829258
X8 Street Eu2	150	06-08	10 060 2561	842093	Beverly Tourer Eu3	300	09-10	10 060 0991	829258
X9 Amalfi	180	00-03	10 060 0881	827936	Beverly Tourer Eu3	300	09-10	10 060 2561	842093
Carnaby	200	07-08	10 060 0991	829258	Carnaby Cruiser	300	09-12	10 060 0991	829258
Cosa 1 200	200	88-91	10 060 0501	252971	Carnaby Cruiser	300	09-12	10 060 2561	842093
Cosa 2 200	200	91-97	10 060 0501	252971	Mp3 300 le Lt	300	10-11	10 060 2111	831997
Liberty	200	06	10 060 0911	487287	Mp3 300 le Mic	300	10	10 060 2111	831997
Liberty	200	06	10 060 1171	832703	Mp3 300 le Mic	300	11	10 060 2111	831997
Liberty 4T Eu3	200	06-08	10 060 0911	875525	Mp3 300 Lt Business - Sport Abs - Enjoy	300	14-15	10 060 0991	829258
Liberty 4T Eu3	200	06-08	10 060 1171	832703	Mp3 4T 4V le Erl Ibrido	300	10-13	10 060 2111	831997
Liberty 4T Sport Eu3	200	06-07	10 060 0911	875525	Mp3 4T 4V le Lt Ibrido	300	10-11	10 060 2111	831997
Liberty 4T Sport Eu3	200	06-07	10 060 1171	832703	Mp3 le Lt- le Lt Sport	300	11-14	10 060 2111	831997
Liberty Rst	200	04	10 060 0911	487287	Mp3 le Lt Touring	300	11-13	10 060 2111	831997
Liberty Rst	200	04	10 060 1171	832703	Mp3 le Touring	300	11-12	10 060 2111	831997
Liberty Sport	200	06	10 060 0911	487287	Mp3 Yourban Erl	300	11-15	10 060 0991	829258
Liberty Sport	200	06	10 060 1171	832703	Mp3 Yourban Lt Erl	300	11-12	10 060 0991	829258
Vespa Granturismo	200	06-07	10 060 2111	831997	Vespa Gts le & Touring	300	12-16	10 060 2111	831997
X8	200	05-07	10 060 2111	831997	Vespa Gts le & Touring	300	12-16	10 060 2561	842093
X9	200	02-03	10 060 0991	829258	Vespa Gts le Touring	300	11-12	10 060 2111	831997
X9 Evolution	200	03	10 060 0991	829258	Vespa Gts le Touring	300	11-12	10 060 2561	842093
Ape Car P2-P3	220	78-85	10 060 0620	248570	Vespa Gts Super	300	08-16	10 060 2111	831997
Ape Mp P501-P601	220	78-96	10 060 0620	438014	Vespa Gts Super	300	08-16	10 060 2561	842093
Ape Tm	220	09-16	10 060 1191	486942	Vespa Gts Super Sport	300	10-13	10 060 2111	831997
Ape Tm	220	09-16	10 060 0620	248570	Vespa Gts Super Sport	300	10-13	10 060 2561	842093
Ape Tm P602	220	82-83	10 060 0620	438014	Vespa Gtv 4T 4V le	300	10-13	10 060 2111	831997
Ape Tm P703 Fl2	220	99-07	10 060 0620	248570	Vespa Gtv 4T 4V le	300	10-13	10 060 2561	842093
Ape Tm P703-P703v	220	84-05	10 060 0620	438014	Vespa Gtv Via Montenapoleone	300	10	10 060 2111	831997
Beverly	250	06-07	10 060 0991	829258	Vespa Gtv Via Montenapoleone	300	10	10 060 2561	842093
Beverly	250	06-07	10 060 1221	840476	X7 Evo le Eu3	300	09-10	10 060 0991	829258
Beverly	250	06-07	10 060 2561	842093	X7 Evo le Eu3	300	09-10	10 060 2561	842093
Beverly Cruiser	250	07-09	10 060 0991	829258	Beverly 4T 4V le Eu3 Sport Touring	350	11-14	10 060 3051	880001
Beverly Cruiser	250	07-09	10 060 2561	842093	Beverly 4T St le Abs	350	16	10 060 3051	880001
Beverly Eu3 Mic	250	07	10 060 0991	829258	X10 4T 4V le Eu3	350	12-15	10 060 3051	880001
Beverly Eu3 Mic	250	07	10 060 2561	842093	Beverly Eu3	400	06-07	10 060 0991	829258
Beverly le Eu3	250	06-08	10 060 0991	829258	Beverly Tourer Eu3	400	08-10	10 060 0991	829258
Beverly le Eu3	250	06-08	10 060 2561	842093	Mp3	400	07-08	10 060 0991	829258
Beverly Rst	250	04-05	10 060 0991	829258	Mp3 le Lt - Mp3 le Lt Sport	400	08-10	10 060 0991	829258
Beverly Rst	250	04-05	10 060 1221	840476	Mp3 le Lt Touring	400	11	10 060 0991	829258
Beverly Rst	250	04-05	10 060 2561	842093	Mp3 Mic	400	08-10	10 060 0991	829258
Beverly Sport	250	06-08	10 060 0991	829258	Mp3 Ri Touring	400	11	10 060 0991	829258
Beverly Sport	250	06-08	10 060 2561	842093	X Evo	400	07-11	10 060 0991	829258
Beverly Tourer Eu3	250	07-09	10 060 0991	829258	X8 Eu3	400	06-08	10 060 0991	829258
Beverly Tourer Eu3	250	07-09	10 060 2561	842093	Ape Calessino - Vme	420	07-12	10 060 2601	614945
Carnaby	250	08	10 060 0991	829258	Ape Car - Max Diesel	420	86-96	10 060 0631	230414
Carnaby	250	08	10 060 2561	842093	Ape Car - Max Diesel	420	86-96	10 060 0630	230414
Mp3	250	06-08	10 060 2111	831997	Ape Mp601 Classic	420	06-13	10 060 2601	614945
Mp3 Lt	250	08-09	10 060 2111	831997	Ape Poker Benzina	420	93	10 060 0640	254999
Mp3 Lt	250	08-09	10 060 2561	842093	Ape Poker Diesel	420	93-97	10 060 0631	230414
Mp3 Mic	250	08-09	10 060 2111	831997	Ape Poker Diesel	420	93-97	10 060 0630	230414
Vespa Gt 60 Eu3	250	06-07	10 060 2111	831997	Ape Tm Diesel Lcs	420	05-12	10 060 2601	614945
Vespa Gt 60 Eu3	250	06-07	10 060 2561	842093	Ape Tm P703-P703v Diesel	420	87-04	10 060 0631	438017
Vespa Gts	250	05-16	10 060 2111	831997	Ape Tm P703-P703v Diesel	420	87-04	10 060 0630	438017
Vespa Gts	250	05-16	10 060 2561	842093	Beverly	500	02-04	10 060 0991	829258
Vespa Gts Abs	250	05-12	10 060 2111	831997	Beverly	500	05-06	10 060 0991	829258
Vespa Gts Abs	250	05-12	10 060 2561	842093	Beverly Cruiser	500	07-12	10 060 0991	829258
Vespa Gtv	250	06-09	10 060 2111	831997	Beverly Eu3	500	06-08	10 060 0991	829258



FILTRI ARIA - RICERCA PER MARCA

AIR FILTERS - SEARCH BY MODEL

Modello - Model	Cc	Anno Year	Codice RMS RMS Code	Rif. Originale Orig. Ref.	Modello - Model	Cc	Anno Year	Codice RMS RMS Code	Rif. Originale Orig. Ref.
Mp3 Lt Business Abs	500	14-16	10 060 0991	829258	An250 Burgman K3-K6	250	03-06	10 060 0941	13780-14F01-000
Mp3 Lt Sport - Business	500	11-13	10 060 0991	829258	An250 Burgman W-K2	250	98-02	10 060 0941	13780-14F00-000
Mp3 Rl Sport - Business	500	11-12	10 060 0991	829258	An250 Burgman W-K2	250	98-02	10 060 0941	13780-14F01-000
Mp3 Sport Abs	500	14-15	10 060 0991	829258	An400 Burgman K3-K6	400	03-06	10 060 0941	13780-14F01-000
Quargo	500	05-16	10 060 2601	614945	An400 Burgman K7-L0	400	07-10	10 060 2611	13781-05H00-000
X10 4T 4V Ie Eu3	500	12-14	10 060 0991	829258	An400 Burgman L1	400	11	10 060 2611	13781-05H00-000
X9	500	01-02	10 060 1141	487845	An400 Burgman L2	400	12	10 060 2611	13781-05H00-000
X9 Evolution	500	03-05	10 060 1141	487845	An400 Burgman L3	400	13	10 060 2611	13781-05H00-000
X9 Evolution	500	06-07	10 060 1141	487845	An400 Burgman L4	400	14	10 060 2611	13781-05H00-000
X9 Evolution Abs	500	06-07	10 060 1141	487845	An400 Burgman L5	400	15	10 060 2611	13781-05H00-000
Quargo Diesel	750	04-06	10 060 2601	614945	An400 Burgman L6	400	16	10 060 2611	13781-05H00-000
Porter D120 E5	1200	11-15	10 060 4990	263703	An400 Burgman X-K2	400	99-02	10 060 0941	13780-14F01-000
Porter Diesel 1200-1400	1200	95-00	10 060 4990	263703	Gsr600 K6-L0	600	06-10	10 060 3310	13780-44G00-000
Porter Maxxi D120 Euro5	1200	11-15	10 060 4990	263703	Gsx-R600 K4-K5	600	04-05	10 060 3330	13780-29G00-000
Porter 1000-1300 Pick-Van	1300	92-09	10 060 2621	1780187Z08000	Gsx-R600 K6-K7	600	06-07	10 060 3340	13780-01H00-000
Porter 1300 Pick-Van	1300	92-09	10 060 4980	1780187Z08000	Gsx-R600 K8-L0	600	08-10	10 060 3340	13780-01H00-000
Porter 16V Pick Up-Maxxi-Gpl-4X4	1300	98-09	10 060 2621	1780187Z08000	Gsx-R600 L1	600	11	10 060 3350	13781-04J00-000
Porter 16V Pick Up-Maxxi-Gpl-4X4	1300	98-09	10 060 4980	1780187Z08000	Gsx-R600 L2	600	12	10 060 3350	13780-14J00-000
Porter 16V Van	1300	98-07	10 060 2621	1780187Z08000	Gsx-R600 L3	600	13	10 060 3350	13780-14J00-000
Porter 16V Van	1300	98-07	10 060 4980	1780187Z08000	Gsx-R600 L4	600	14	10 060 3350	13780-14J00-000
Porter Maxxi Up-Date	1300	09-10	10 060 2621	1780187Z08000	Gsx-R600 L5	600	15	10 060 3350	13780-14J00-000
Porter Maxxi Up-Date	1300	09-10	10 060 4980	1780187Z08000	Gsx-R600 L6	600	16	10 060 3350	13780-14J00-000
Porter Up-Date	1300	09-10	10 060 2621	1780187Z08000	Gsx-R600 L7	600	17	10 060 3350	13780-14J00-000
Porter Up-Date	1300	09-10	10 060 4980	1780187Z08000	An650 Burgman L4	650	14	10 060 2721	13780-10G00-000
Porter Pick Diesel	1400	98-05	10 060 4990	263703	DI650 V-Strom K4-K6	650	04-06	10 060 3260	13780-06G00-000
Porter Van Diesel	1400	98-05	10 060 4990	263703	DI650 V-Strom K7-L0	650	07-10	10 060 3280	13780-27G10-000
SACHS					DI650 V-Strom L1	650	11	10 060 3280	13780-27G10-000
Limbo 25 Ma	25	96-97	10 060 0371	730199	DI650 V-Strom L2	650	12	10 060 3280	13780-27G10-000
Limbo 25 Sa	25	98-00	10 060 0371	730199	DI650a V-Strom Abs L3	650	13	10 060 3280	13780-27G10-000
Limbo 50 Lm	50	97	10 060 0371	730199	DI650a V-Strom Abs L4	650	14	10 060 3280	13780-27G10-000
Limbo 50 M	50	96-97	10 060 0371	730199	DI650a V-Strom Abs L5	650	15	10 060 3280	13780-27G10-000
Reggae 50	50	96-97	10 060 0371	730199	DI650a(Ue)/Xa(Ue) V-Strom	650	17	10 060 3280	13780-27G10-000
Reggae 50 Rs	50	96-97	10 060 0371	730199	DI650a(Ue)/Xa(Ue)L6 V-Strom	650	16	10 060 3280	13780-27G10-000
Splinter 50	50	96-97	10 060 0371	730199	DI650xt V-Strom	650	15	10 060 3280	13780-27G10-000
Squab 50	50	97	10 060 0371	730199	Gsf Bandit K7-K8	650	07-08	10 060 3300	13780-18H00-000
SUZUKI					Gsf Bandit K9-L0	650	09-10	10 060 3300	13780-18H00-000
Ah50 Address	50	92-95	10 060 0051	13780-40D40-000	Gsf Bandit L1	650	11	10 060 3300	13780-18H00-000
Ay50ayw Katana V-Y	50	97-00	10 060 0841	13782-35E00-000	Gsf Bandit L2	650	12	10 060 3300	13780-18H00-000
Uf Estilite	50	00	10 060 0841	13782-35E00-000	Gsx F K8-L0	650	08-10	10 060 3300	13780-18H00-000
Ux Zillion	50	99	10 060 0841	13782-35E00-000	Gsx F L1	650	11	10 060 3300	13780-18H00-000
Uk110ne Address L5	110	15	10 060 3270	13780-40JA0-000	Gsx F L2	650	12	10 060 3300	13780-18H00-000
Uk110ne Address L6	110	16	10 060 3270	13780-40JA0-000	Sfv Gladius K9-L0	650	09-10	10 060 3290	13780-44H00-000
Uk110nx Address L5	110	15	10 060 3270	13780-40JA0-000	Sfv Gladius L1	650	11	10 060 3290	13780-44H00-000
Uh125 Burgman K2-K6	125	02-06	10 060 1231	13780-49F00-000	Sfv Gladius L2	650	12	10 060 3290	13780-44H00-000
Uh125 Burgman K7-L0	125	07-10	10 060 2521	13782-03H00-000	Sfv Gladius L3	650	13	10 060 3290	13780-44H00-000
Uh125 Burgman K7-L0	125	07-10	10 060 2551	13780-03H00-000	Sfv Gladius L4	650	14	10 060 3290	13780-44H00-000
Uh125 Burgman L1	125	11-12	10 060 2521	13782-03H00-000	Sfv650(U/A/Ua)Gladius L5	650	15	10 060 3290	13780-44H00-000
Uh125 Burgman L1	125	11-12	10 060 2551	13780-03H00-000	Sv650a L7	650	17	10 060 3290	13780-44H00-000
Uh125 Burgman L3	125	13	10 060 2521	13782-03H00-000	Gsr750(A)L6	750	16	10 060 3310	13780-44G00-000
Uh125 Burgman L3	125	13	10 060 2551	13780-03H00-000	Gsr750L1	750	11	10 060 3310	13780-44G00-000
Uh125 Burgman L4	125	14	10 060 2521	13782-03H00-000	Gsr750L2	750	12	10 060 3310	13780-44G00-000
Uh125 Burgman L4	125	14	10 060 2551	13780-03H00-000	Gsr750L3	750	13	10 060 3310	13780-44G00-000
Ux Sixteen K8-L0	125	08-10	10 060 2531	13785-20H00-000	Gsr750z(A)L4	750	14	10 060 3310	13780-44G00-000
Ux Sixteen K8-L0	125	08-10	10 060 2541	13780-20H00-000	Gsr750z(A)L5	750	15	10 060 3310	13780-44G00-000
Ux Sixteen L1	125	11	10 060 2531	13785-20H00-000	Gsx-R750 K4-K5	750	04-05	10 060 3330	13780-29G00-000
Ux Sixteen L1	125	11	10 060 2541	13780-20H00-000	Gsx-R750 K6-K7	750	06-07	10 060 3340	13780-01H00-000
Uh200 Burgman K2-K6	150	02-06	10 060 1231	13780-49F00-000	Gsx-R750 K8-L0	750	08-10	10 060 3340	13780-01H00-000
Ux Sixteen K8-L0	150	08-10	10 060 2531	13785-20H00-000	Gsx-R750 L1	750	11	10 060 3350	13780-14J00-000
Ux Sixteen K8-L0	150	08-10	10 060 2541	13780-20H00-000	Gsx-R750 L2	750	12	10 060 3350	13780-14J00-000
Ux Sixteen L1	150	11	10 060 2531	13785-20H00-000	Gsx-R750 L3	750	13	10 060 3350	13780-14J00-000
Ux Sixteen L1	150	11	10 060 2541	13780-20H00-000	Gsx-R750 L4	750	14	10 060 3350	13780-14J00-000
Uh200 Burgman K7-L0	200	07-10	10 060 2521	13782-03H00-000	Gsx-R750 L5	750	15	10 060 3350	13780-14J00-000
Uh200 Burgman K7-L0	200	07-10	10 060 2551	13780-03H00-000	Gsx-R750 L6	750	16	10 060 3350	13780-14J00-000
Uh200 Burgman L1	200	11-12	10 060 2521	13782-03H00-000	Gsx-R750 L7	750	17	10 060 3350	13780-14J00-000
Uh200 Burgman L1	200	11-12	10 060 2551	13780-03H00-000	Gsx-R750z(Uf) L4	750	14	10 060 3350	13780-14J00-000
Uh200 Burgman L3	200	13	10 060 2521	13782-03H00-000	Gsx-S750a(Z) L7	750	17	10 060 3310	13780-44G00-000
Uh200 Burgman L3	200	13	10 060 2551	13780-03H00-000	DI1000 V-Strom K2-K6	1000	02-06	10 060 3260	13780-06G00-000
Uh200 Burgman L4	200	14	10 060 2521	13782-03H00-000	DI1000 V-Strom K7-L0	1000	07-10	10 060 3260	13780-06G00-000
Uh200 Burgman L4	200	14	10 060 2551	13780-03H00-000	Gsx-R1000 K9-L0	1000	09-10	10 060 3320	13780-47H00-000



Modello - Model	Cc	Anno Year	Codice RMS RMS Code	Rif. Originale Orig. Ref.	Modello - Model	Cc	Anno Year	Codice RMS RMS Code	Rif. Originale Orig. Ref.
Gsx-R1000 L1	1000	11	10 060 3320	13780-47H00-000	Maxsym I Abs	400	12	10 060 3360	17211L4A000
Gsf1250 Bandit K7-L0	1250	07-10	10 060 3300	13780-18H00-000	YAMAHA				
Gsf1250 Bandit L0	1250	10	10 060 3300	13780-18H00-000	Bw's Next Generation	50	97-06	10 060 0311	3VLE44510100
Gsf1250 Bandit L1	1250	11	10 060 3300	13780-18H00-000	Bw's Original	50	97-02	10 060 0311	3VLE44510100
Gsf1250s Bandit L1	1250	11	10 060 3300	13780-18H00-000	Bw's Original Eu2	50	03	10 060 0311	3VLE44510100
Gsf1250s Bandit L2	1250	12	10 060 3300	13780-18H00-000	Bw's R	50	01	10 060 0311	3VLE44510100
Gsf1250sa Bandit L5-L6	1250	15-16	10 060 3300	13780-18H00-000	Cw Bw's Original Eu2	50	02	10 060 0311	3VLE44510100
Gsx1250fa L0	1250	10	10 060 3300	13780-18H00-000	Cw L Bw's	50	03	10 060 0311	3VLE44510100
Gsx1250fa L1	1250	11	10 060 3300	13780-18H00-000	Cw L Bw's	50	04	10 060 0311	3VLE44510100
Gsx1250fa L2	1250	12	10 060 3300	13780-18H00-000	Cw Rs Spy	50	95-98	10 060 0311	3VLE44510100
Gsx1250fa L6	1250	16	10 060 3300	13780-18H00-000	Cw Sp Bw's Original Eu2	50	02	10 060 0311	3VLE44510100
SYM					Ew Slider	50	00-02	10 060 0311	3VLE44510100
Fiddle li	50	08	10 060 2891	17211AAA000	Ns50f Aerox F	50	14-16	10 060 2791	5C3E44510000
Jet	50	99	10 060 0521	17205KBN900	Yh Why	50	01-02	10 060 0351	5EUE44510000
Jungle	50	99	10 060 0521	17205KBN900	Yh Why	50	06	10 060 0351	5EUE44510000
Red Devil	50	99	10 060 0521	17205KBN900	Yh Why	50	98	10 060 0351	5EUE44510000
Super Fancy	50	98-00	10 060 0521	17205KBN900	Yh Why Eu1	50	99-00	10 060 0351	5EUE44510000
Symphony St	50	15	10 060 2891	17211AAA000	Yh Why Eu2	50	03-05	10 060 0351	5EUE44510000
Symply	50	07-08	10 060 2891	17211AAA000	Yn F Neo's 4	50	09-10	10 060 2791	5C3E44510000
Jet	100	99-00	10 060 0521	17205KBN900	Yn F Neo's 4	50	11-12	10 060 2791	5C3E44510000
Gts Joymax	125	06-07	10 060 2691	17211HLK000	Yn F Neo's 4	50	12-15	10 060 2791	5C3E44510000
Hd Eu2	125	03-04	10 060 2781	17211HHA000	Hw Xenter	125	12-16	10 060 2861	52SE44510000
Hd Eu3	125	07-08	10 060 2781	17211HHA000	Hw Xenter	125	12-16	10 060 2871	52SE54080000
Hd Evo	125	05-06	10 060 2781	17211HHA000	Mw125 Tricity	125	14	10 060 3001	2CME44510000
Hd Evo Eu3	125	07-08	10 060 2781	17211HHA000	Nxc Cygnus X	125	04-06	10 060 2741	5TYE44510000
Hd Evo Eu3	125	10-11	10 060 2781	17211HHA000	Nxc Cygnus X	125	07-11	10 060 2741	5TYE44510000
Hd Evo Tamburo Eu3	125	08-09	10 060 2781	17211HHA000	Vp X-City	125	08-11	10 060 2411	1B9144510000
Hd2	125	11	10 060 2781	17211HHA000	Xc Cygnus R	125	00-03	10 060 2011	4CWE54071000
Hd2	125	14	10 060 2781	17211HHA000	Xc Cygnus R	125	99	10 060 0801	4CWE44510200
Joyride	125	01-02	10 060 2681	17211H6B000	Xc Cygnus R	125	99	10 060 2011	4CWE54071000
Joyride Eu2	125	03-04	10 060 2691	17211HLK000	Xc K Cygnus R	125	97-98	10 060 0801	4CWE44510200
Joyride Eu2	125	05-06	10 060 2691	17211HLK000	Xc K Cygnus R	125	97-98	10 060 2011	4CWE54071000
Joyride Eu3	125	07	10 060 2691	17211HLK000	Xc T Cygnus	125	95-98	10 060 0801	4CWE44510200
Joyride Evo	125	09-14	10 060 2691	17211HLK000	Xc T Cygnus	125	95-98	10 060 2011	4CWE54071000
Megalo	125	06-07	10 060 2681	17211HLB000	Xc125r Majesty S	125	14	10 060 2861	52SE44510000
Vs	125	06	10 060 3370	17211VS1000	Xc125r Majesty S	125	14	10 060 2871	52SE54080000
Vs Eu3	125	07-08	10 060 3370	17211VS1000	Xn Teo's	125	00	10 060 0711	5DS154070100
Attila	150	00-01	10 060 2681	17211H6B000	Xn Teo's	125	00	10 060 0871	5DS154070100
Joyride	150	01-02	10 060 2681	17211H6B000	Xq Maxster	125	01-02	10 060 0711	5DS154070100
Vs	150	06	10 060 3370	17211VS1000	Xq Maxster	125	01-02	10 060 0791	5DSE44510000
Vs Eu3	150	07-08	10 060 3370	17211VS1000	Xq Maxster	125	01-02	10 060 0871	5DS154070100
Hd Eu2	200	03-04	10 060 2781	17211HHA000	Ybr	125	05	10 060 3550	5VLE44501000
Hd Eu3 I	200	07	10 060 2781	17211HHA000	Ybr	125	07-09	10 060 3550	5VLE44501000
Hd Evo Eu2	200	05-06	10 060 2781	17211HHA000	Ybr	125	10-12	10 060 3550	5VLE44501100
Hd Evo Eu3 I	200	07	10 060 2781	17211HHA000	Ybr125ed	125	14	10 060 3550	5VLE44501200
Hd Evo I Eu3	200	10-12	10 060 2781	17211HHA000	Yp125 Majesty	125	98-02	10 060 0711	5DS154070100
Hd Evo I Tamburo Eu3	200	08-09	10 060 2781	17211HHA000	Yp125 Majesty	125	98-02	10 060 0791	5DSE44510100
Hd2 I	200	11	10 060 2781	17211HHA000	Yp125 Majesty	125	98-02	10 060 0871	5DS154070100
Hd2 I	200	14	10 060 2781	17211HHA000	Yp125e Majesty	125	03-09	10 060 0711	5DS154070100
Joyride	200	03	10 060 2681	17211H6B000	Yp125e Majesty	125	03-09	10 060 0791	5DSE44510100
Joyride Eu2	200	03-04	10 060 2691	17211HLK000	Yp125e Majesty	125	03-09	10 060 0871	5DS154070100
Joyride Eu2	200	05-06	10 060 2691	17211HLK000	Yp125r X-Max	125	06-07	10 060 2411	1B9144510000
Gts	250	07-08	10 060 2571	17211HMA000	Yp125r X-Max	125	08-09	10 060 2411	1B9144510000
Gts 250	250	06-07	10 060 2571	17211HMA000	Yp125r X-Max	125	10-12	10 060 2411	1B9144510000
Joymax	250	05-07	10 060 2571	17211HMA000	Yp125r X-Max Abs	125	11	10 060 2411	1B9144510000
Joymax Eu3 I	250	07-08	10 060 2571	17211HMA000	Yw Bw's	125	10	10 060 2931	5S9E44510000
Citycom	300	08-09	10 060 2731	17211LEA000	Yw Bw's	125	10	10 060 2991	5S9E44510000
Citycom Efi	300	10-11	10 060 2731	17211LEA000	Hw Xenter	150	12-16	10 060 2861	52SE44510000
Citycom I Cbs	300	12	10 060 2731	17211LEA000	Hw Xenter	150	12-16	10 060 2871	52SE54080000
Citycom S 300 I Cbs	300	15	10 060 2731	17211LEA000	Xn Teo's	150	01-02	10 060 0711	5DS154070100
Joymax Evo	300	09	10 060 2571	17211HMA000	Xn Teo's	150	01-02	10 060 0871	5DS154070100
Joymax Evo I	300	10	10 060 2571	17211HMA000	Xq Maxster	150	01-02	10 060 0711	5DS154070100
Joymax I	300	12	10 060 2571	17211HMA000	Xq Maxster	150	01-02	10 060 0791	5DSE44510000
Joymax I	300	14	10 060 2571	17211HMA000	Xq Maxster	150	01-02	10 060 0871	5DS154070100
Joymax I Abs	300	13	10 060 2571	17211HMA000	Yp150 Majesty	150	00	10 060 0791	5DSE44510000
Joymax I Abs	300	14	10 060 2571	17211HMA000	Yp150 Majesty	150	00	10 060 0871	5DS154070000
Maxsym 400 Abs Eu4	400	17	10 060 3360	17211L4A000	Yp150 Majesty	150	01-02	10 060 0711	5DS154070100
Maxsym I	400	11	10 060 3360	17211L4A000	Yp150 Majesty	150	01-02	10 060 0791	5DSE44510100
Maxsym I	400	12	10 060 3360	17211L4A000	Yp150 Majesty	150	01-02	10 060 0871	5DS154070100



FILTRI ARIA - RICERCA PER MARCA

AIR FILTERS - SEARCH BY MODEL

Modello - Model	Cc	Anno Year	Codice RMS RMS Code	Rif. Originale Orig. Ref.	Modello - Model	Cc	Anno Year	Codice RMS RMS Code	Rif. Originale Orig. Ref.
Yp180e Majesty	180	03-06	10 060 0711	5DS154070100	Xp T-Max	500	09-11	10 060 2491	4B5154070000
Yp180e Majesty	180	03-06	10 060 0791	5DSE44510100	Xp T-Max Abs	500	05-07	10 060 2201	4BH144510000
Yp180e Majesty	180	03-06	10 060 0871	5DS154070100	Xp T-Max Abs	500	05-07	10 060 2361	5GJ154070100
Vp X-City	250	07-12	10 060 2411	1B9144510000	Xp T-Max Abs	500	05-07	10 060 2371	5GJ154080000
Vp X-City	250	07-12	10 060 2421	5GM154070000	Xp T-Max Abs	500	08-11	10 060 2371	5GJ154080000
Vp X-City	250	13-15	10 060 2421	5GM154070000	Xp T-Max Abs	500	08-11	10 060 2441	4B5144510000
Yp250 Majesty	250	00-01	10 060 0331	4HC144510000	Xp T-Max Abs	500	08-11	10 060 2491	4B5154070000
Yp250 Majesty	250	00-01	10 060 2421	5GM154070000	Xp T-Max Abs Sv	500	10-11	10 060 2371	5GJ154080000
Yp250 Majesty	250	02-03	10 060 0331	4HC144510000	Xp T-Max Abs Sv	500	10-11	10 060 2441	4B5144510000
Yp250 Majesty	250	02-03	10 060 2421	5GM154070000	Xp T-Max Abs Sv	500	10-11	10 060 2491	4B5154070000
Yp250 Majesty	250	96-98	10 060 0331	4HC144510000	Xp T-Max Black Max	500	06	10 060 2201	4BH144510000
Yp250 Majesty	250	96-98	10 060 2001	4HC154070000	Xp T-Max Black Max	500	06	10 060 2361	5GJ154070100
Yp250 Majesty Abs	250	03	10 060 0331	4HC144510000	Xp T-Max Black Max	500	06	10 060 2371	5GJ154080000
Yp250 Majesty Abs	250	03	10 060 2421	5GM154070000	Xp T-Max Black Max-Night Max	500	07	10 060 2201	4BH144510000
Yp250 Majesty Dx	250	98	10 060 0331	4HC144510000	Xp T-Max Black Max-Night Max	500	07	10 060 2361	5GJ154070100
Yp250 Majesty Dx	250	98	10 060 2001	4HC154070000	Xp T-Max Black Max-Night Max	500	07	10 060 2371	5GJ154080000
Yp250 Majesty Dx	250	99	10 060 0331	4HC144510000	Xp T-Max Sv	500	11	10 060 2371	5GJ154080000
Yp250 Majesty Dx	250	99	10 060 2001	4HC154070000	Xp T-Max Sv	500	11	10 060 2441	4B5144510000
Yp250r Black X-Max	250	09	10 060 2411	1B9144510000	Xp T-Max Sv	500	11	10 060 2491	4B5154070000
Yp250r Black X-Max	250	09	10 060 2421	5GM154070000	Xp T-Max White Max	500	10	10 060 2371	5GJ154080000
Yp250r X-Max	250	05-06	10 060 2411	1B9144510000	Xp T-Max White Max	500	10	10 060 2441	4B5144510000
Yp250r X-Max	250	05-06	10 060 2421	5GM154070000	Xp T-Max White Max	500	10	10 060 2491	4B5154070000
Yp250r X-Max	250	07-09	10 060 2411	1B9144510000	Xp T-Max	530	12-16	10 060 2441	4B5144510000
Yp250r X-Max	250	07-09	10 060 2421	5GM154070000	Xp T-Max	530	12-16	10 060 2711	59C154080000
Yp250r X-Max	250	10-12	10 060 2411	1B9144510000	Xp T-Max	530	12-16	10 060 2881	59C154070000
Yp250r X-Max	250	10-12	10 060 2421	5GM154070000	Xp T-Max Abs	530	12-16	10 060 2441	4B5144510000
Yp250r X-Max	250	12-13	10 060 2421	5GM154070000	Xp T-Max Abs	530	12-16	10 060 2711	59C154080000
Yp250r X-Max	250	14-16	10 060 2421	5GM154070000	Xp T-Max Abs	530	12-16	10 060 2881	59C154070000
Yp250r X-Max Sport	250	11-12	10 060 2411	1B9144510000	Xp T-Max Sp	530	15	10 060 2441	4B5144510000
Yp250r X-Max Sport	250	11-12	10 060 2421	5GM154070000	Xp T-Max Sp	530	15	10 060 2711	59C154080000
Yp250ra X-Max Abs	250	11-12	10 060 2411	1B9144510000	Xp T-Max Sp	530	15	10 060 2881	59C154070000
Yp250ra X-Max Abs	250	11-12	10 060 2421	5GM154070000	Xp T-Max Sp Abs	530	15-16	10 060 2441	4B5144510000
Yp250ra X-Max Abs	250	12-13	10 060 2421	5GM154070000	Xp T-Max Sp Abs	530	15-16	10 060 2711	59C154080000
Yp250ra X-Max Abs	250	14-15	10 060 2421	5GM154070000	Xp T-Max Sp Abs	530	15-16	10 060 2881	59C154070000
Yp250ra X-Max Abs	250	16	10 060 2421	5GM154070000	Xv Dx Virago	535	00-01	10 060 3560	2GV144510000
Xc Versity	300	03	10 060 0851	5SEE44510000	Xv Dx Virago	535	99	10 060 3560	2GV144510000
Xc Versity	300	03	10 060 2421	5GM154070000	Xv Se Virago	535	88	10 060 3560	2GV144510000
Xc Versity	300	04-05	10 060 0851	5SEE44510000	Xv Virago	535	89-95	10 060 3560	2GV144510000
Xc Versity	300	04-05	10 060 2421	5GM154070000	Fz6	600	04-05	10 060 3400	5VX144510000
Xc Versity	300	06	10 060 0851	5SEE44510000	Fz6	600	06	10 060 3400	5VX144510000
Xc Versity	300	06	10 060 2421	5GM154070000	Fz6	600	07	10 060 3400	5VX144510000
Sr400	400	14-16	10 060 2441	4B5144510000	Fz6 Fazer	600	04-05	10 060 3400	5VX144510000
Yp400 Majesty	400	04-11	10 060 2331	5RU144513000	Fz6 Fazer	600	06	10 060 3400	5VX144510000
Yp400 Majesty	400	04-11	10 060 2341	5RU144612000	Fz6 Fazer	600	07	10 060 3400	5VX144510000
Yp400 Majesty	400	04-11	10 060 2351	5RU154070200	Fz6 Fazer Abs	600	06	10 060 3400	5VX144510000
Yp400 Majesty Abs	400	07	10 060 2331	5RU144513000	Fz6 Fazer Abs	600	07	10 060 3400	5VX144510000
Yp400 Majesty Abs	400	07	10 060 2341	5RU144612000	Fz6 Fazer S2	600	07	10 060 3400	5VX144510000
Yp400 Majesty Abs	400	07	10 060 2351	5RU154070200	Fz6 Fazer S2	600	08	10 060 3400	5VX144510000
Yp400 Majesty Abs	400	08	10 060 2331	5RU144513000	Fz6 Fazer S2 Abs	600	08	10 060 3400	5VX144510000
Yp400 Majesty Abs	400	08	10 060 2341	5RU144612000	Fz6 Ns	600	05-06	10 060 3400	5VX144510000
Yp400 Majesty Abs	400	08	10 060 2351	5RU154070200	Fz6 S2	600	07-08	10 060 3400	5VX144510000
Yp400 Majesty Abs	400	09-11	10 060 2331	5RU144513000	Xj6-F Diversion	600	10-11	10 060 3530	20S144510000
Yp400 Majesty Abs	400	09-11	10 060 2341	5RU144612000	Xj6-Fa Diversion Abs	600	10-11	10 060 3530	20S144510000
Yp400 Majesty Abs	400	09-11	10 060 2351	5RU154070200	Xj6-N	600	09-11	10 060 3530	20S144510000
Yp400r X-Max	400	13-14	10 060 2351	5RU154070200	Xj6-N	600	13	10 060 3530	20S144510000
Yp400r X-Max	400	15-16	10 060 2351	5RU154070200	Xj6-N Sp	600	13	10 060 3530	20S144510000
Yp400r X-Max Momodesign	400	14	10 060 2351	5RU154070200	Xj6-Na Abs	600	13-15	10 060 3530	20S144510000
Yp400ra X-Max Abs	400	14	10 060 2351	5RU154070200	Xj6-S Diversion	600	09-11	10 060 3530	20S144510000
Yp400ra X-Max Abs	400	15-17	10 060 2351	5RU154070200	Xj6-S Diversion	600	13-15	10 060 3530	20S144510000
Yp400ra X-Max Ironmax Abs	400	16	10 060 2351	5RU154070200	Xj6-S Diversion Abs	600	13-15	10 060 3530	20S144510000
Yp400ra X-Max Momodesign Abs	400	14	10 060 2351	5RU154070200	Xt Z Tenere	600	86-87	10 060 3510	1VJ144510000
Xp T-Max	500	01-07	10 060 2201	4BH144510100	Xt Z Tenere	600	88-90	10 060 3520	2RW144510000
Xp T-Max	500	01-07	10 060 2361	5GJ154070100	Yzf R6 & Limited Edition 07	600	06	10 060 3470	2C0144500000
Xp T-Max	500	01-07	10 060 2371	5GJ154080000	Yzf R6 50Th	600	12	10 060 3490	13S144502000
Xp T-Max	500	08	10 060 2371	5GJ154080000	Yzf-R6	600	07	10 060 3470	2C0144500100
Xp T-Max	500	08	10 060 2441	4B5144510000	Yzf-R6	600	08-09	10 060 3480	13S1445000000
Xp T-Max	500	08	10 060 2491	4B5154070000	Yzf-R6	600	10-15	10 060 3490	13S1445020000
Xp T-Max	500	09-11	10 060 2371	5GJ154080000	Yzf-R6	600	16	10 060 3490	13S1445020000
Xp T-Max	500	09-11	10 060 2441	4B5144510000	Yzf-R6	600	17	10 060 3480	13S1445000000



Modello - Model	Cc	Anno Year	Codice RMS RMS Code	Rif. Originale Orig. Ref.
Yzf-R6	600	99-00	10 060 3500	5EB144510000
Xvs A Drag Star Classic	650	04-06	10 060 3380	4TR144510000
Xvs A Drag Star Classic	650	98-02	10 060 3380	4TR144510000
Xvs Drag Star	650	97-02	10 060 3380	4TR144510000
Mt-03	660	06-12	10 060 3410	5VKE44510000
Xt660r	660	04-11	10 060 3410	5VKE44510000
Xt660r	660	14	10 060 3410	5VKE44510000
Xt660x	660	04-11	10 060 3410	5VKE44510000
Xt660x	660	14	10 060 3410	5VKE44510000
Mt-07	700	14-16	10 060 3420	1WS144500000
Mt-07 Mc Moto Cage	700	14	10 060 3420	1WS144500000
Mt-07A	700	17	10 060 3420	1WS144500000
Mt-07A Abs	700	14-16	10 060 3420	1WS144500000
Mt-07A Mc Moto Cage	700	14	10 060 3420	1WS144500000
Mtt690-A Tracer	700	16	10 060 3420	1WS144500000
Xsr700	700	16-17	10 060 3420	1WS144500000
Fz8-N	800	11-15	10 060 3390	2D1144510000
Fz8-Na	800	11-15	10 060 3390	2D1144510000
Fz8-S	800	11	10 060 3390	2D1144510000
Fz8-S	800	15	10 060 3390	2D1144510000
Fz8-Sa	800	11-15	10 060 3390	2D1144510000
Mt-09	850	14-15	10 060 3590	1RC144510000
Mt-09 (Mtn850-A)	850	17	10 060 3590	1RC144510000
Mt-09A Abs	850	14-16	10 060 3590	1RC144510000
Mt-09A Tracer	850	15-17	10 060 3590	1RC144510000
Xsr900	850	16	10 060 3590	1RC144510000
Fz1	1000	06-09	10 060 3390	2D1144510000
Fz1 Fazer	1000	06-12	10 060 3390	2D1144510000
Fz1 Fazer Abs	1000	07-08	10 060 3390	2D1144510000
Fz1 Fazer Abs	1000	11-12	10 060 3390	2D1144510000
Fz1-N	1000	11	10 060 3390	2D1144510000
Fz1-Na	1000	10-11	10 060 3390	2D1144510000
Gts	1000	93	10 060 2201	4BH144510000
Gts A (Abs)	1000	93	10 060 2201	4BH144510000
Yzf-R1	1000	02-03	10 060 3430	5PW144510000
Yzf-R1	1000	04-05	10 060 3440	5VY144510000
Yzf-R1	1000	06	10 060 3440	5VY144510000
Yzf-R1	1000	07-08	10 060 3450	4C8144510000
Yzf-R1	1000	09-12	10 060 3460	14B144510000
Yzf-R1	1000	13-14	10 060 3460	14B144510000
Yzf-R1sp	1000	06	10 060 3440	5VY144510000

ADIVA

10 060 2685

125-200: Ad 09-11 • Ar 09-11
(Riferimento Champion: CAF4101)

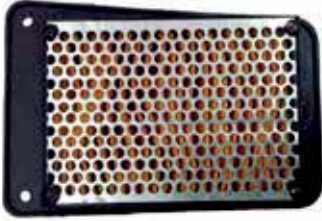

APRILIA

10 060 0045

125: Leonardo / St 96-05
150: Leonardo / St 96-05
(Riferimento Champion: Y318)



10 060 5035

450: Rxv 06-14 • Sxv 06-14
550: Rxv 06-14 • Sxv 06-14
1000: Rsv R Tuono Factory 05-10 • Rsv4 09-14
• Rsv4 Tuono 11-14
(Riferimento Champion: CAF5101)



BMW

10 060 5105

(Riferimento Champion: CAF5102)
650: Pegaso 93-99
660: Pegaso Street / Trail / Factory 05-12



10 060 2265

650: F Gs 00-04 • F Gs 05-07 • F Gs Dakar 01-04
• F Gs Dakar 05-07 • G Gs 09-13
(Riferimento Champion: CAF6601)

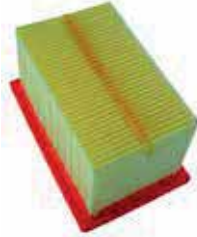

10 060 4065

650: F Cs 02-05 • G Xchallenge 07-08 • G
Xcountry 07-08 • G Xmoto 07-08
(Riferimento Champion: CAF6602)



10 060 4075

850: R GS Boxer 99 • R R 00-06 • R R Boxer 99 •
R R Classic 02-04 • R RT 99
1100: R GS 93-99 • R R 95-01 • R RS 93-01 • R RS
Special Ed. 00 • R RT 99-01
1150: R GS 99-05 • R GS Adventure 02-03 • R
GS Adventure 04-05 •
R R 01-06 •
R R Rockster 04-05 • R
R Rockster Ed. 80 04 •
R RS 02-05 • R RS SE
02-05 • R RT 02-05
(Riferimento
Champion: CAF6910)



10 060 4085

1100: R S 99-05
(Riferimento Champion: CAF6911)



10 060 4095

1200: R Gs 04-09 • R Hp2 Enduro 05-08 • R Hp2
Megamoto 07-08 • R Hp2 Sport 08-09 • R R 07-
10 • R Rt 05-09 • R S 06-09 • R St 05-08
(Riferimento Champion: CAF6912)



10 060 4105

650: F Gs 08-11
800: F Gs 07-11
(Riferimento Champion: CAF6913)

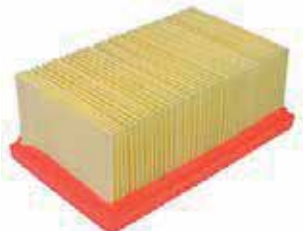

10 060 4115

1200: R Gs 10-12 • R Gs Adventure 10-13
R Gs Adventure Triple Black 12 • R Gs Rallye 12
R Gs Triple Black 12 • R R 11-13 • R R Classic 12
R RT 10-13 • R
Rt SE 10-12
(Riferimento
Champion:
CAF6914)



10 060 4735

650: F FL,St 94-98
(Riferimento Champion: Y316)



BMW

10 060 5025

NEW

10 060 5055

1200: R1200 Gs 13-14 • R1200 Gs Adventure 15-16 • R1200 Gs Adventure Te - Xe 14 • R1200 Gs Enduro 13 • R1200 Gs Lc 13-16 • R1200 Gs Te 14 • R1200 Gs R Lc 14-16 • R1200 Rs Lc 14-16 • R1200 Rt Lc 15-16
(Riferimento Champion: CAF6915)

600: C Sport 12-15
650: C Gt 12-15
(Riferimento Champion: CAF6604)

10 060 5065

1300: K Gt 09-10 • K Gt Se 10 • K R 09-13 • K R Carbon 12 • K R Dynamic 12 • K S (2 pcs) 09-15 • K S Hp (2 pcs) 12 • K S Sport (2 pcs) 12
(Riferimento Champion: CAF6917)



10 060 5075

1600: K Gt 11-15 • K Gt Se 12 • K GTL 11-15 • K GTL Exclusive 13-15 • K GTL Se 12
(Riferimento Champion: CAF6916)

10 060 5085

1000: S R 13-15 • S Rr 10-15 • S Rr Sport 10
(Riferimento Champion: CAF6918)



CAGIVA

10 060 4815

650: Raptor I.e. 00-05 • V-Raptor 01-04
(Riferimento Champion: Y334)

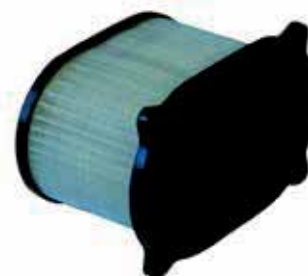

DUCATI

10 060 5095

(Riferimento Champion: CAF5002)

350: Supersport Jr

400: Monster • Ss Junior Super Sport 92-94 • Supersport 93-97

600: Monster 93-01 • Monster Chromo / Dark 93 • Ss 93-98

620: Monster Dark 06 • Monster Dark I.e. 04-05 • Sport 03

650: Indiana Custom 86-88 • Pantha SL 86-88

695: Monster 07-08

750: Monster 96-01 • Monster I.e. 02 • Sport 01-02 • Sport 01 • Ss 91-02 • Supersport (Usa) I.e. 91 • Supersport I.e. 02

800: Sport 03 • Ss 03-07

851: Strada 89-92

888: Sp5 93 • Superbike (Usa) 94-95 • Superbike Strada 94-95

900: Monster 93-01 • Monster I.e. / Dark 02 • Sport 02 • Super Light 92-97 • Super Sport 90-02 • Supersport Superlight Usa, CR Usa, FE, I 91

907: I.e. Usa 91-92 • I.e. 90-93

916: St4 99-03

944: St2 97-03

992: St3 04-07 • St3 S (Abs) (Usa) 07

996: Sport Touring 4S 01

1000: Ss 03-05 • Ss Usa 03 • St3 Usa 04



MOTO GUZZI

10 060 2275

650: 65Gt 88-89 • Ntx 86-90 • V65 83-95
750: V75 Strada-Targa-Sp-Nevada 90-02
850: Griso 06-11 • Le Mans I,II,III 75-83 • Norge 06-11 • T3 California 75-83 • T4,T5 75-88 • T5 89-05
1000: California II 82-86 • California III 87-93 • California III le 90-93 • Le Mans IV 84-87 • Le Mans V 86-92 • Mille Gt 87-94 • S 90-93 • Sp 78-83 • Sp2 84-87 • Sp3 88-96
(Riferimento Champion: U300)



10 060 5035

850: Griso 06-11
1100: Griso 05-08
1200: Griso 8V 07-14 • Griso 8V Se 10-14 • Stelvio 08-14 • Stelvio Ntx 10-14
(Riferimento Champion: CAF5101)



10 060 5115

940: Bellagio 07-12
1000: Daytona 93-01 • V10 Centauro 97-01
1100: California 94-12 • California Ev 98-05 • Sport 94-95 • Sport ie 96-00 • V11 98-05
(Riferimento Champion: CAF5401)



HONDA

10 060 1135

125: @ 00-02
125-150: Nes Chiocciola 00-07 • Psi 06-11 • Ses Dylan 02-07 • Sh 01-08 • Sh i 09-12 • Sh i Sporty 11 • Sh ie Dd - Sporty 09-10
(Riferimento Champion: CAF0112)



10 060 2385

300: Sh I Abs 07-13 • Sh I Sport Abs 08-13
(Riferimento Champion CAF0304)



10 060 2635

400: Silver Wing (Fjs) 06-09 • Sw-T (Fjs) 09-12
600: Silver Wing (Abs) (Fjs) 03-11 • Silver Wing (Fjs) 01-04 • Sw-T (Fjs) 11-12
(Riferimento Champion: CAF0617)



10 060 2645

250: Nss Forza X / Ex 05-07
(Riferimento Champion: CAF0213)



10 060 2655

125-150: Fes Pantheon 4T 03-07 • Fes S Wing 07-12
(Riferimento Champion: CAF0118)



10 060 2665

125: Pcx 11-12
(Riferimento Champion CAF0114)



10 060 2775

125: Pcx 13-14
150: Pcx 12-13
(Riferimento Champion: CAF0120)



10 060 2855

125-150: Sh 13-14
(Riferimento Champion: CAF0121)



10 060 4005

125: Cbr R 04-12
(Riferimento Champion: CAF0113)



HONDA

10 060 4135

500: Cb Cup 99 • Cb 94-02 • Cb S 98-02
(Riferimento Champion: J301)



10 060 4185

750: Cb C Custom 80-82 • Cb Custom • Cb F Bol D'or • Cb F 80-85 • Cb 79-82
900: Cb Bol D'Or 79-82 • Cb C Custom 80-82 • Cb F Supersport 79-82 • Cb 83-84 • Cb F 79-82
1000: Cb C Custom 83
1100: Cb F 83 • Cb 81 • Cb 82-83
(Riferimento Champion: J306)



10 060 4195

600: XLV Transalp 87-00
650: Xrv Africa Twin 88-90
750: Xrv Africa Twin 90-92
(Riferimento Champion: J307)



10 060 4205

600: Cbr Hurricane 91-94
(Riferimento Champion: J308)



10 060 4265

750: Xrv Africa Twin 93-02
(Riferimento Champion: J314)



10 060 4275

900: Cbr Rr Fire Blade 92-95 • Cbr Fire Blade 96-99
(Riferimento Champion: J315)



10 060 4285

1000: Cbr F Hurricane 87-95 • Cbr 87-88 • Cbr 89-92 • Cbr 93-94 • Cbr 95-99
(Riferimento Champion: J316)



10 060 4295

750: Cb F 92-00 • Cb Nighthawk 750 91-03 • Cb Seven Fifty 01-02 • Cbx F 84-86
(Riferimento Champion: J317)

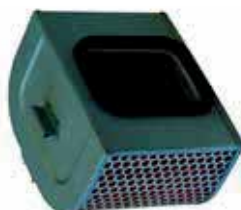

10 060 4365

400: Nt Bro's
600: Ntv 88-92
650: Nt Hawk Gt 88-91 • Ntv Bro's 88-91 • Ntv Revere 93-97
(Riferimento Champion: J324)



10 060 4385

400: Cbr Aero • Cbr Rrh
600: Cbr 87-88 • Cbr 89-90
(Riferimento Champion: J326)



10 060 4405

400: Nv Custom
600: Vt C Shadow VLX 88-93 • Vt Shadow VLX 95-98 • Vt Shadow VLX 93-95
(Riferimento Champion: J328)



10 060 4495

1500: Gold Wing Aspencade 91-00 • Black Widow 01 • Gold Wing 88-93 • Gold Wing Interstate 91-96 • Gold Wing 90-01
(Riferimento Champion: J338)



HONDA

10 060 4505

1100: Cbr Xx Black Bird 97-98
(Riferimento Champion: J339)



10 060 4515

1100: Cb S X-Eleven 00-03 • Cbr Xx Black Bird 99-06
(Riferimento Champion: J340)

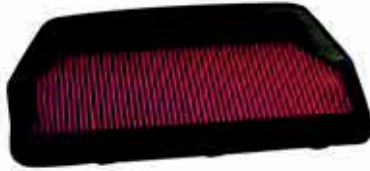

10 060 4525

650: Ntv Deauville 98-05
(Riferimento Champion: J341)



10 060 4535

1000: Vtr F Fire Storm 97-02 • Vtr F Fire Storm 03-05 • Vtr F Super Hawk 98-02 • Vtr F Super Hawk 03-05 • Xlv Varadero 99-02
(Riferimento Champion: J342)



10 060 4545

600: Cbr F 99-00
(Riferimento Champion: J343)



10 060 4555

650: Xlv Transalp 01-07
(Riferimento Champion: J345)



10 060 4565

800: Vfr F1 Interceptor 02-03 • Vfr F1 V-TEC Interceptor (Abs) 02-09 • Vfr F1 V-TEC Interceptor 04-09 • Vfr F1 Interceptor 98-99 • Vfr F1 Interceptor (Cbs & Pgm) 00-01
(Riferimento Champion: J346)



10 060 4675

650: Nx Dominator 01-02 • Nx Dominator 88-94 • Nx Dominator 95-00
(Riferimento Champion: V312)



10 060 4865

1200: Gold Wing Aspencade 84-87 • GL 84-88 • Gold Wing 84-87 • Gold Wing Interstate 84-87
(Riferimento Champion: Y339)



10 060 4875

1100: Vt C Shadow 87-88 • Vt C Shadow 89-95 • Vt C Shadow Spirit 99-07 • Vt Shadow 95-98 • Vt Shadow Sabre 99-07 • Vt Shadow Aero 98-02 • Vt Shadow American Classic Ed. 98 • Vt Shadow 99 • Vt Shadow Ace Tour 98-02
(Riferimento Champion: Y340)

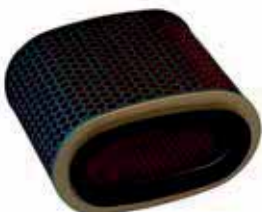

10 060 4885

500: Cbf 04-08 • Cbf Abs 04-08
600: Cb F Hornet 03-06 • Cb F Hornet 98-02 • Cb S Hornet 00-02 • Cb S Hornet 03 • Cbf N 04-07 • Cbf S Abs 04-07
(Riferimento Champion: Y341)

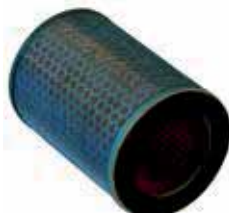

10 060 4905

100: Scv Lead 03-07
(Riferimento Champion: CAF0116)



HONDA

10 060 4915

110: Nhx Lead 08-11
(Riferimento Champion: CAF0117)



10 060 4985 **NEW**

600: Cbr 600 F-1-2-3-4-5-6-7 01-07 • Cbr 600 F4i 01-06 • Cbr 600 Fs-1-Fs-2 Sport 01-02
(Riferimento Champion CAF0619)



10 060 4995 **NEW**

600: Cbr 600 Ra-9-A-B-C-D-F (C-Abs) 09-16
• Cbr 600 Rr-7-8-9-A-B-C-D-E-F 07-16
(Riferimento Champion CAF0620)



10 060 5125

670: Nm4 Vultus 15-16
700: Nc S-Jd-X-Xd DCT 12-15 • Ctx N-DCT 14-16 • Integra DCT
750: Integra DCT 14-15 • Nc S-X DCT 14-15
(Riferimento Champion CAF0715)



10 060 5205 **NEW**

HONDA 500: Cb F-D-E-F-G 13
(Riferimento Champion: CAF0508)



10 060 5215 **NEW**

HONDA 1200: Vfr F Dct V4 10 • Vfr F V4 10
Vfr Crosstourer Dct 14 • Vfr Crosstourer Highland T 15 • Vfr X-C-D-E-F-G Crosstourer 12
(Riferimento Champion: CAF0930)



ITALJET

10 060 2425

250: Jupiter 01-03
(Riferimento Champion: CAF3203)



KAWASAKI

10 060 4015

1000: Klv 04-06
(Riferimento Champion: CAF2611)



10 060 4175

400: Zr Zephyr 89-93 • Gpz r 85-86
550: Gt 87-01 • Zr Zephyr 91-00 • Zx Unitrack Gpz 87-92
750: Zr Zephyr 91-95 • Zr Zephyr 96-99 • Zr-7S 01-03 • Zr-7 99-03
(Riferimento Champion: J305)

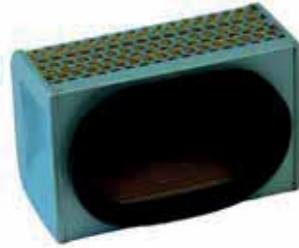

10 060 4325

400: Z (4 Cyl) (Kz j) 80-83 • Zx 84-87
500: Z 79-80 • Z (6 Speed) 81
550: Kz 80-83 • Kz 82-84 • Z 80-83 • Z 79-80 • Z Ltd 81-83 • Z Twin Shock (Gpz) 81 • Z (Gt) 83-86 • Zx Unitrack (Gpz) 84-86
600: Zx (Gpz R) 85-89
(Riferimento Champion: J320)



10 060 4355

750: Gpz R 85-88
900: ZL Eliminator 85-86 • Gpz R Ninja 84-96
1000: Zg Concours (Gtr) 86-06 • ZL Eliminator 87-88
(Riferimento Champion: J323)



10 060 4465

400: Gpz S 89-90
500: Gpz S 87-89 • Gpz S 90-93 • Gpz S 03 • Ex Ninja R 04-06 • Gpz S 94-96 • Gpz S 97-02 • Ex Ninja R 07-09
(Riferimento Champion: J335)

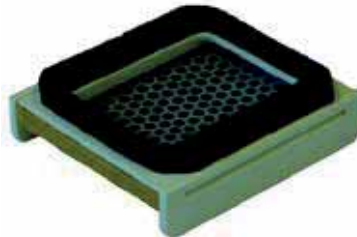

10 060 4475

900: Zx-9R Ninja 98-99 • Zx-9R Ninja 00-01 • Zx-9R Ninja 02-03
(Riferimento Champion: J336)



10 060 4485

600: Zx6-R Ninja 98-99 • Zx6-R Ninja 00-01 • Zx6-R Ninja 02 • Zxr 05-06 • Zxr 07-08
636: Zx6-R Ninja 02
(Riferimento Champion: J337)



10 060 4715

250: EL B/F 96-03 • EL Eliminator 88-96
500: Kle 91-02
600: Gpx R 88-00
750: Gpx R 86-88
(Riferimento Champion: Y308)



10 060 4725

600: Zx6-R Ninja 95-97
(Riferimento Champion: Y310)



KAWASAKI

10 060 4845

1100: Zrx Zephyr 96-00
1200: Zrx 01-03 • Zrx R 01-06 • Zrx S 01-04
(Riferimento Champion: Y337)



10 060 4855

1500: Vn Classic 96-98 • Vn Classic 99-04 • Vn Classic Tourer 98 • Vn Nomad 99-01 • Vn Drifter 99-00 • Vn Nomad Fi 00 • Vn Classic Tourer Fi 99-00 • Vn Nomad Fi 01 • Vn Classic Tourer Fi 01-03 • Vn Nomad Fi 02-04 • Vn Classic Fi 00-02 • Vn Classic 05-06 • Vn Classic 07-08 • Vn Mean Streak 02-03 • Vn Drifter 01-05
1600: Vn Mean Streak 04-06 • Vn Mean Streak 07-08
(Riferimento Champion: Y338)

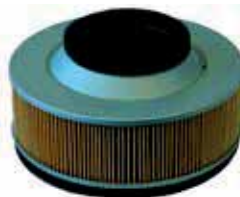

10 060 4895

500: Er-5 96-06
(Riferimento Champion: Y342)

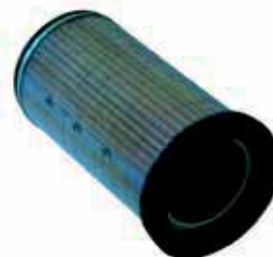

10 060 5135

650: Er-6f 13-14 • Er-6n 13-14 • Ex Ninja R (ABS) 13-16
(Riferimento Champion: CAF1608)



10 060 5145

1000: Zx-10R Ninja (ABS) 11-15
(Riferimento Champion: CAF1918)



10 060 5225 **NEW**

KAWASAKI 1000: Z Gef-Gff-Ggf-Zr Abs 14 • Z Se-Se Abs 14 • Zx Mef-Mff-Mgf-Ninja Abs 14
(Riferimento Champion: CAF1920)



10 060 5235 **NEW**

KAWASAKI 1000: Zx 10R • Zx Sgf-Sgfa-Rgf-Rgfa-Ninja Abs 16
(Riferimento Champion: CAF1921)



KTM

10 060 5045

1050: Adventure 15
1190: Adventure 13-15 • Adventure R 13-15
1290: Super Adventure 14 • Super Duke R 14
(Riferimento Champion: CAF5301)



10 060 5185

125-200-390: Duke 11-16 • RC 14-16
(Riferimento Champion: CAF5302)

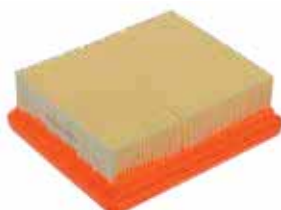

KYMCO

10 060 0745

125: Dink ie 06-13 • Gran Dink 01-11 • Gran Dink S 08-11 • Gran Dink ie 12-13
150: Gran Dink 01-11
200: Dink ie 06-13
250: Gran Dink 01-09 • Xciting 05-08
300: Xciting Ri 08-12
(Riferimento Champion: CAF4003)



10 060 2315

125: Agility City (16") 08-12 • Ciak 01-09 • People 99-12 • People S 05-12 • People S Dd le 07-12 • Super 8 08-12
150: Agility City (16") 08-10 • Ciak 01-05 • People 99-12 • People S 05-12 • People S DD i.e. 07-12 • Super 8 10-12
200: Ciak Master 06-09 • i People S 05-12 • i People S le 07-12
(Riferimento Champion: CAF4001)



10 060 2435

250: People 03-05 • People S 05-08 • People S le 07-11
300: People S i 08-12
(Riferimento Champion: CAF4006)



10 060 2585

125-200: Downtown 09-13
(Riferimento Champion: CAF4004)



10 060 4945

500: X Citing / i / ir 04-13
(Riferimento Champion: CAF4005)



10 060 4955

125: Agility 4T R12 / Carry / Rs 05-13
(Riferimento Champion: CAF4007)



MALAGUTI

10 060 9345

125: Agility (12") 06-07 • Agility (12") 08-11 • Agility RS (12") 09-11 • Movie XL 01-05 • Movie XL 06-10
150: Movie XL 01-05 • Movie XL 06-09
(Riferimento Champion: CAF4002)



10 060 2425

250: Password 05-09
(Riferimento Champion: CAF3203)



MBK

10 060 2425

250: Skyliner 00-03
300: Kilibre 03
(Riferimento Champion: CAF3203)



10 060 2915

125: Citycruiser 07-11 • Cityliner 07-13 •
Skycruiser 06-13
(Riferimento Champion CAF3104)



10 060 0425

125: Sfera 95-97 • Vespa Et4 96-99
(Riferimento Champion: Y309)



PEUGEOT

10 060 2685

50-125-150: Tweet 10-13 • Tweet Rs 4T 10-13
(Riferimento Champion: CAF4101)



10 060 4975

125-200: Lxr 09-12
(Riferimento Champion: CAF4104)



SUZUKI

10 060 2545

125-150: Sixteen 07-13
(Riferimento Champion: CAF2104)



10 060 2555

125: Burgman 07-12
200: Burgman 07-12
(Riferimento Champion: CAF2103)



10 060 2615

400: Burgman 06-13
(Riferimento Champion: CAF2401)



10 060 2725

650: Burgman 02-13
(Riferimento Champion: CAF2619)



10 060 4015

650: DL V-Strom 04-06
1000: DL V-Strom 02-10 • DL Se V-Strom 10
(Riferimento Champion: CAF2611)



10 060 4025

600: Gsr B Yoshimura 10 • Gsr 06-10
750: Gsr 11-12
(Riferimento Champion: CAF2613)



SUZUKI

10 060 4035

600: Gsx-R 04-05
750: Gsx-R 04-05
(Riferimento Champion: CAF2616)



10 060 4045

600: Gsx-R 06-10
750: Gsx-R 06-10
(Riferimento Champion: CAF2617)



10 060 4155

500: Gs E 96 • Gs E (2 Cylinders) 88-02 • Gs F 04-10
• Gs H 07-09 • Gs 03-06
700: Gv 85
1200: Gsx Inazuma 99-00 • Gv 85-86
(Riferimento Champion: J303)



10 060 4165

600: Gsf Bandit 95-99 • Gsf Bandit 96-99
• Gsx-R 92-93 • **750:** Gsx-R 92-95
1100: Gsx-R 92-97
1200: Gsf S Bandit 97-99 • Gsf Bandit 96-99
(Riferimento Champion: J304)



10 060 4255 **NEW**

600: Vs 600 GLF 98 • Vs 600 S-T-V
700: Vs 700 GLEPG 86 • Vs 700 GLFH-GLPH-
GLEFH 87-88 • Vs 700 GLPJ-GLFJ 88
750: Vs 750 GLF 85-86 • Vs 750 GLP-H-J-K-L-M
Intruder 87-91
800: S50 K5-K6-K7-K8-K9 Boulevard 05-09 • Vs
800 GL-N-P-R-S-T-V-W-X-Y-K1-K9 Intruder (S50
Intruder) 92-09
(Riferimento Champion: J313)



10 060 4335

750: Gsx-R Sling Shot 88-89 • Gsx-R Sling Shot
90-91
1100: Gsx-R 89-92
(Riferimento Champion: J321)



10 060 4345

600: Gsx F 88-89
1100: Gsx F 88-96
(Riferimento Champion: J322)



10 060 4375

600: Rf 93-97
900: Rf 94-00
(Riferimento Champion: J325)



10 060 4435

1000: TL R 98-02
(Riferimento Champion: J332)



10 060 4445

600: Gsf Bandit 00-04 • Gsf S Bandit 00-04
1200: Gsf Bandit 00-04 • Gsf S Bandit 00-04
(Riferimento Champion: J333)



10 060 4455

600: Gsx-R 01-03
750: Gsx-R 00-03
1000: Gsx R 93-00 • Gsx-R 01
(Riferimento Champion: J334)



10 060 4585

650: Ls Savage (Belt) 05-09 • Ls Savage (Belt)
01-04 • Ls Savage (Belt) 91-00 • S40 Boulevard
(Ls) 05-11
(Riferimento Champion: U308)



SUZUKI

10 060 4635 

750: Gs 79-81 • Gs Sd 83 • Gsx 79-81 • Gsx S-Ss 84-85 • Gsx 84-85 • Gsx 80-82
1000: Gs 78-80 • Gs 78-80 • Gs 79-83
1100: Gs E 80-83 • Gs 80-83 • Gs 80-81 • Gs 83 • Gsx 80-82
(Riferimento Champion: V307)



10 060 4655 

600: Vs 98 • Vs 95-97
700: Vs 86 • Vs 87-88 • Vs 88
750: Vs Intruder 90-98 • Vs 85-86 • Vs Intruder 87 • S50 Boulevard 05-09
800: Vs Intruder (S50 Intruder) 92-09
(Riferimento Champion: V310)



10 060 4685 

400: Gsf Bandit 90-95
(Riferimento Champion: Y302)



10 060 4695 

650: Dr 90-96
(Riferimento Champion: Y304)

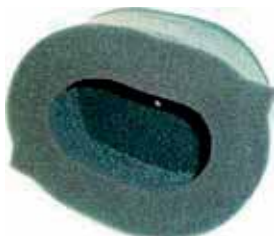

10 060 4745 

1400: Vs Intruder S83 05-09 • Vs 87-96 • Vs Intruder 97-04
(Riferimento Champion: Y320)



10 060 4815 

650: Sv 99-02
(Riferimento Champion: Y334)

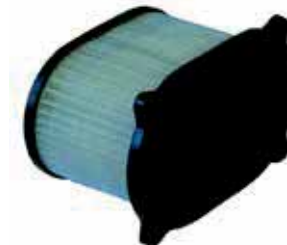

10 060 4825 

600: Gsx-R 97-00
750: Gsx-R Srad 96-99
(Riferimento Champion: Y335)

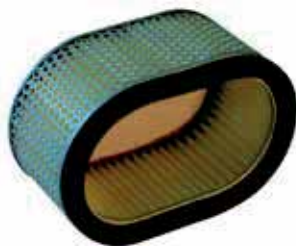

10 060 4835 

600: Gsx F 90-00 • Gsx F 01-06
750: Gsx F 89-06
(Riferimento Champion: Y336)

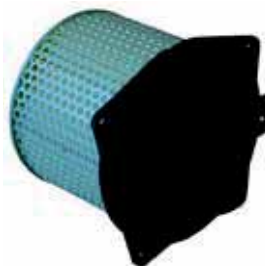

10 060 5015 

650: Svf 650 Az Gladius Special Edition 13
• Svf 650 K9-L0-L1-L2-L3-L4-L5 Gladius Abs 09-15
(Riferimento Champion: CAF2618)

NEW



10 060 5155 

600: Gsx-R 11-15
750: Gsx-R 11-15 • Gsx-R Z 14
(Riferimento Champion: CAF2620)



10 060 5165 

1000: Gsx-R 12-15 • Gsx-R Z 13-15
(Riferimento Champion: CAF2620)



10 060 5245 

650: Sv A/Sa (Abs) 07-15 • Sv 03-08
1000: Sv 03-07 • Sv S 03-07
(Riferimento Champion: CAF2612)

NEW



SUZUKI

10 060 5255

NEW

1250: Gsx
(Riferimento Champion: CAF2621)



SYM

10 060 2685

50: Symphony 4T / S 09-13
125: Symphony 4T / S 09-13 • Hd2 11-13
• Joyride 01-02 • Megalo 06-08 • Rv 01-03
150: Symphony 4T / S 09-13 • Hd2 11-13
• Joyride 01-02 • Rv 01-03
180: Rv 01-03 • **200:** Joyride 03
(Riferimento Champion: CAF4101)



10 060 2695

125: Joyride E2 03-08 • Joyride E3 07-12
• Joyride Evo E3 09-13
(Riferimento Champion: CAF4102)



10 060 2735

300: Citycom 07-12
(Riferimento Champion: CAF4105)



10 060 4965

125-150: Vs E3 06-12
(Riferimento Champion: CAF4103)



10 060 4975

125-200: Hd / Evo / Evo E3 07-13
(Riferimento Champion: CAF4104)



TRIUMPH

10 060 5195

800: Tiger-Xc-Xr 01-16
(Riferimento Champion: CAF5501)



10 060 5315

675: Daytona 06 • Daytona R 11 • Street Triple
08 • Street Triple R 10
(Riferimento Champion: CAF5502)



10 060 5325

NEW

955: Sprint Rs 02 • Sprint St 02 • Daytona i 02 •
Speed Triple 02
(Riferimento Champion: CAF5503)



10 060 5335

NEW

800: Bonneville 01-06 • Bonneville T100 03-05 •
Bonneville T100 Centennial Edition 02
865: Bonneville 07-15 • Bonneville Black 07-08 •
Bonneville Se 09-12 • Bonneville Steve McQueen
Edition 13 • Bonneville T100 07 • Bonneville T100
110h Anniversary Edition 13 • Scrambler 07 •
Thrupton 07-15
1200: Thrupton 16 • Thrupton 16
(Riferimento Champion: CAF5504)



YAMAHA

10 060 2335

PRIMO FILTRO - 1ST AIR FILTER

400: Majesty 04-12
(Riferimento Champion: CAF3404)



10 060 2345

SECONDO FILTRO - 2ND AIR FILTER

400: Majesty 04-12
(Riferimento Champion: CAF3405)



10 060 2355

CARTER - CRANKCASE FILTER

400: Majesty 04-12
(Riferimento Champion: CAF3406)



10 060 2365

LATO SINISTRO - LEFT HAND SIDE AIR FILTER

500: T-max 01-07
(Riferimento Champion: CAF3505)



10 060 2375

LATO DESTRO - RIGHT HAND SIDE V-BELT FILTER

500: T-max White Max 10-11 • T-max 01-07 •
T-max 08-11
(Riferimento Champion: CAF3506)



10 060 2425

250: X-City 07-13 • Majesty 00-07 • X Max 05-13
300: Versity 03-06
(Riferimento Champion: CAF3203)



10 060 2445

PRIMO FILTRO - 1ST AIR FILTER

500: T-max White Max 10-11 • T-max 08-11 • Xp
Tmax Tech Max Abs 11
530: Xp Tmax / Black Max 12-13
(Riferimento Champion: CAF3507)



10 060 2495

FILTRO LATO SINISTRO - LEFT SIDE FILTER

500: T-max 08-11
(Riferimento Champion: CAF3508)



10 060 2715

FILTRO LATO DESTRO - RIGHT SIDE FILTER

530: T-max 12-14
(Riferimento Champion: CAF3510)



10 060 2745

125: Nxc Cygnus X 04-13
(Riferimento Champion: CAF3107)



10 060 2885

FILTRO LATO SINISTRO - LEFT SIDE FILTER

530: T-max 12-14
(Riferimento Champion: CAF3509)



10 060 2915

125: X-City 07-13 • X-Max 06-13 • X-Max Business Abs 11 • X-Max Sport 06-13
• X-Max Abs 11-12
250: X-Max 06-13 • X-Max Sport 11-13
• X-Max Abs 11-12
(Riferimento Champion CAF3104)



YAMAHA

10 060 4055

800: Fz8 N 10-13 • Fz8 S Fazer 8 10-13
1000: Fz1 N 06-12 • Fz1 N Abs 08-12
• Fz1 S Fazer 06-12 • Fz1 S Fazer Abs 08-12
(Riferimento Champion: CAF3917)



10 060 4125

650: Xj Maxim 80-84 • Xj Midnight 81 • Xj Seca 83 • Xj Seca 82
750: Xj 81-84
(Riferimento Champion: J300)

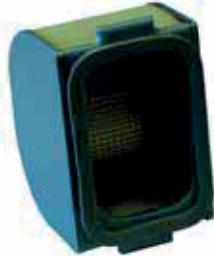

10 060 4215

700: Xv 86-87 • Xv 86-87 • Xv 84-87
750: Xv Virago 92-99
1000: Xv Se 88-89 • Xv Se Virago 83-85
1100: Xv Virago 97-00 • Xv Virago 89-96
(Riferimento Champion: J309)



10 060 4225

400: Xj
600: Fj 84-85 • Xj 84-85 • Xj 91-92 • Xj 86-91
(Riferimento Champion: J310)

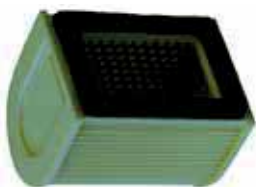

10 060 4235

1100: Fj 84-86
1200: Fj 86-95 • Fj A Abs 91-95
(Riferimento Champion: J311)

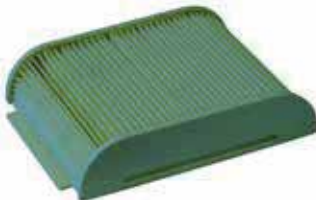

10 060 4245

900: Xj F 84-93 • Xj Seca 82-83
(Riferimento Champion: J312)

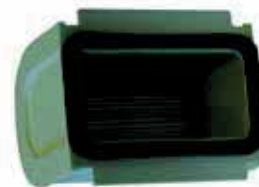

10 060 4305

750: Yzf R 93-98 • Yzf 93-98
(Riferimento Champion: J318)

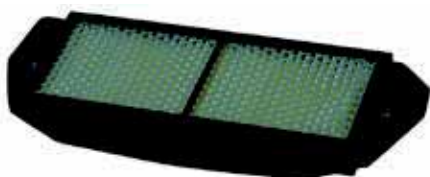

10 060 4315

750: Xv 81-83 • Xv Se 81-83
920: Xv 81-82
(Riferimento Champion: J319)



10 060 4395

750: Xtz Super Tenere 90-97
(Riferimento Champion: J327)



10 060 4415

600: Fz6
(Riferimento Champion: CAF3612)



10 060 4425

900: Tdm900 02-11 • Tdm A Abs 05-11
(Riferimento Champion: J331)



10 060 4575

600: Xt 84-90
(Riferimento Champion: J304)

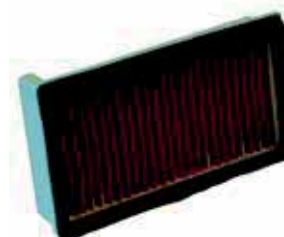

YAMAHA

10 060 4605

400: Fzr Genesis 88 • Fzr R Exup 88-89
600: Fzr600 89-90 • Fzr 91-93
(Riferimento Champion: V303)

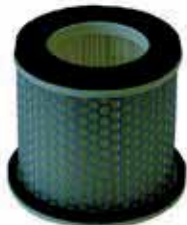

10 060 4615

535: Xv S 94-95 • Xv 87-93
(Riferimento Champion: V305)



10 060 4625

1000: Fzr (Exup) 89-90 • Fzr (Exup) 91-94
• Yzf Thunder Ace 96-02
(Riferimento Champion: V306)



10 060 4645

650: Xvs Drag Star 97-04 • Xvs A Drag Star
Classic 98-05 • Xvs A V-Star Classic
98-10 • Xvs At V-Star Silverado 02-10 • Xvs V-M
V-Star Midnight Custom 06-10
(Riferimento Champion: V308)



10 060 4665

600: Xj N Diversion 97-03 • Xj S Diversion 97-
98 • Xj S Diversion 99-03 • Xj Diversion 92-96
700: Fz7 87
750: Fz Genesis 87-94 • Fz 85-88 • Fzr Genesis
87-88
850: Tdm 91-01
900: Xj S Diversion 94-03
1000: Fzr Genesis 87-88
1100: Bt Bulldog 02-06
(Riferimento Champion: V311)

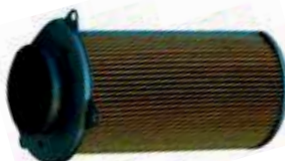

10 060 4705

500: Sr 92-00 • Sr 84-91
550: Xt 82-83
(Riferimento Champion: Y305)



10 060 4755

1000: Yzf-R1 98-01
(Riferimento Champion: Y325)



10 060 4765

600: Fzs Fazer 98-03 • Fzs Sp Fazer 00-01
(Riferimento Champion: Y327)



10 060 4775

1200: Xjr 95-98 • Xjr Sp 97-98
1300: Xjr 99-06 • Xjr Sp 99-02
(Riferimento Champion: Y328)

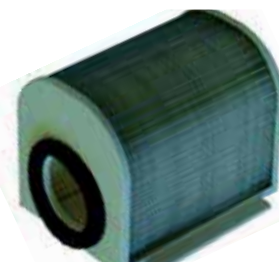

10 060 4785

1300: Xvz A Royal Star 99-02 • Xvz A Royal Star
Boulevard 99-01 • Xvz Royal Star 96-98
(Riferimento Champion: Y329)

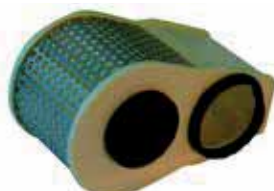

10 060 4795

1200: Vmx (V-Black Max) 96-00 • Vmx (V-Max)
85-95 • Vmx (V-Max) 01-07
(Riferimento Champion: Y330)



10 060 4805

600: Yzf-R6 99-02
(Riferimento Champion: Y331)



YAMAHA

10 060 4935

125: Ybr 4T 05-12
(Riferimento Champion: CAF3103)



10 060 5005

600: Fz6 R 09-13 • Xj6 Abs 09-14 • Xj6 Diver-
sion Abs 09-14 • Xj6 Diversion F Abs 10-14 •
Xj6 Sp 13
(Riferimento Champion CAF3615)



10 060 5175

660: Mt-03 06-12 • Xt R - X Super Motard 04-14
(Riferimento Champion CAF3613)



10 060 5285

NEW

500: Xp T-max (Primo filtro - 1St Air Filter) 01-07
1000: Gts (2Pz necessari - 2Pcs Required) 93-00
(Riferimento Champion: CAF3909)



10 060 5295

NEW

847: Fj-09 15 • Fz-09 (Usa) 14 • Mt-09 (Abs) 14
• Mt-09 Sport Tracker (Abs) 15 • Mt-09 Sr Street
Rally (Abs) 14 • Mt-09 Tracer (Abs) 15
900: Xsr G-Gc 16
(Riferimento Champion: CAF3921)



10 060 5305

NEW

1200: Xt Super Tenere Es 16 • Xt Super Tenere
Worldcrosser 13-15 • Xt Z Super Tenere Abs 11
• Xt Ze Super Tenere Abs 14
(Riferimento Champion: CAF3922)





▶ **FILTRI OLIO**
OIL FILTERS

▶ **NYPSO**

10 060 9021 	Ø 41mm h 33mm Hiflo: HF185 Champion: COF085	
APRILIA (OEM): 020450 BMW (OEM): 11-41-7-651-414 • 11-41-7-672-166 ITALJET (OEM): 210483727 PEUGEOT (OEM): 737492 (R.O. AP0256451) (R.O. AP0256450)		
10 060 9031 	Ø 33mm h 36mm Hiflo: HF181 Champion: COF081	
CAGIVA (OEM): 800092541 ITALJET (OEM): 210410229 PIAGGIO (OEM): 410229		
10 060 9041 	Ø 52mm h 65mm Hiflo: HF183 Champion: COF083	
APRILIA BENELLI / ADIVA DERBI / GILERA ITALJET (OEM): 210483727 MALAGUTI (OEM): 46400200 PEUGEOT (OEM): 756162 PIAGGIO (OEM): 483727 • 82635R		
10 060 9050 	Ø 44mm h 55mm Hiflo: HF132 Champion: COF032	
KAWASAKI (OEM): 52010-S002 SUZUKI (OEM): 16510-25C00 • 16510-19B00 • 16510-24501 SYM (OEM): 15400-L4A-000 • 15400-L4A-0002 YAMAHA (OEM): 5RU-13440-00		
10 060 9061 	Ø 44mm h 40mm Hiflo: HF131-971 Champion: COF031	
HYOSUNG SUZUKI (OEM): 16510-05240		
10 060 9071 	Ø 76mm h 57mm Hiflo: HF184 Champion: COF084	
APRILIA GILERA MALAGUTI PEUGEOT (OEM): 759749 PIAGGIO (OEM): 82658R • 82960R • 830239 • 82883R		

<p>10 060 9081 </p>	<p>Ø 68mm h 50mm Hiflo: HF147 Champion: COF047</p>	
<p>KYMCO (OEM): 1541A-LBA2-E00 YAMAHA (OEM): 5DM-13440-00</p>		
<p>10 060 9101 </p>	<p>Ø 76mm h 72mm Hiflo: HF153 Champion: COF053</p>	
<p>CAGIVA DUCATI (OEM): 444.4.003.5A • 09 054 99 6 • 444.4.017.1A • 444.4.003.4A GILERA</p>		
<p>10 060 9121 </p>	<p>Ø 76mm h 59mm Hiflo: HF552 Champion: COF452</p>	
<p>MOTO GUZZI (OEM): 14153000</p>		
<p>10 060 9131 </p>	<p>Ø 76mm h 79mm Hiflo: HF163 Champion: COF063</p>	
<p>BMW (OEM): 11-421-460-697 • 11-421-460-845 • 11-001-341-616</p>		
<p>10 060 9151 </p>	<p>Ø 76mm h 90mm Hiflo: HF551 Champion: COF451</p>	
<p>MOTO GUZZI (OEM): 30153000</p>		
<p>10 060 9171 </p>	<p>Ø 41mm h 128mm Hiflo: HF161 Champion: COF061</p>	
<p>BMW (OEM): 11-42-1-337-198 • 11-42-1-337-572 • 11-42-1-337-570</p>		

<p>10 060 9191 </p>	<p>Ø 50mm h 38mm Hiflo: HF112-113 Champion: COF013</p>	
<p>GASGAS (OEM): MFS450622565CT • MFS450622565C • MFS400122550 HONDA (OEM): 15412-KF0-305 • 15412-HM5-A10 • 15412-KF0-010 • 15410-KL3-670 • 15412-KF0-315 • 15410-KF0-010 • 15412-KF0-000 • 15412-KF0-020 • 15412-HM5-010 • 15410-KYJ-901 • 15410-KF0-020 KAWASAKI (OEM): 52010-1053 SUZUKI (OEM): K5201-01053</p>		
<p>10 060 9201 </p>	<p>Ø 56mm h 53mm Hiflo: HF151 Champion: COF051</p>	
<p>APRILIA (OEM): 0256185 BMW (OEM): 11-41-2-343-118 • 11-41-2-343-452 BOMBARDIER (OEM): 711256185 CCM MUZ KTM MOTORI ROTAX</p>		
<p>10 060 9211 </p>	<p>Ø 41mm h 69mm Hiflo: HF155 Champion: COF055</p>	
<p>BETAMOTOR HUSABERG KTM (OEM): 580.38.005.000 • 901.38.015.000 • 580.38.005.100 • 580.38.005.101 POLARIS(ATV) (OEM): 2520754</p>		
<p>10 060 9221 </p>	<p>Ø 45mm h 48mm Hiflo: HF154 Champion: COF054</p>	
<p>HUSQVARNA (OEM): 800081675</p>		
<p>10 060 9241 </p>	<p>Ø 80mm h 80mm Hiflo: HF202 Champion: COF102</p>	
<p>HONDA (OEM): 15410-MJO-003 • 15410-MB3-003 • 15410-679-013 • 15410-MG7-003 • 15410-MB0-003 KAWASAKI (OEM): 16097-1054 • 16097-1056</p>		
<p>10 060 9271 </p>	<p>Ø 72mm h 64mm Hiflo: HF133 Champion: COF033</p>	
<p>SUZUKI (OEM): 16510-45040 • 16500-45810 • 16500-45820</p>		

<p>10 060 9290 </p>	<p>Ø 41mm h 58mm Hiflo: HF145 Champion: COF045</p>	
<p>APRILIA DERBI MUZ SACHS YAMAHA (OEM): 2H0-13440-90 • 5JX-13440-00 • 4X7-13440-90 • 4X7-13440-00 • 583-13440-10 • 4X7-13440-01</p>		
<p>10 060 9321 </p>	<p>Ø 69mm h 45mm Hiflo: HF111 Champion: COF011</p>	
<p>HONDA (OEM): 154A1-413-000 • 15412-KEA-003 • 15412-413-000 • 154A1-MA6-000 • 15412-KK9-911 • 15412-413-005</p>		
<p>10 060 9351 </p>	<p>Ø 65mm h 64mm Hiflo: HF204 Champion: COF104</p>	
<p>HONDA (OEM): 15410-MFJ-D01 • 15410-MCJ-003 • 15400-PFB-014 • 15410-MCJ-505 • 15410-MCJ-000 KAWASAKI (OEM): 16097-1070 • 16097-0003 • 16097-1072 • 16097-1068 • 16097-0002 MV AGUSTA (OEM): 8000A9294 SUZUKI TRIUMPH (OEM): T1210444</p>		
<p>10 060 9370 </p>	<p>Ø 44mm h 79mm Hiflo: HF562 Champion: COF462</p>	
<p>KYMCO (OEM): 1541A-KKC3-9000</p>		
<p>10 060 9380 </p>	<p>Ø 38mm h 46mm Hiflo: HF141-142 Champion: COF041-042</p>	
<p>FANTIC MBK TM RACING (OEM): F66510 • F66508 YAMAHA (OEM): 5YP-E3440-00 • 5TA-13440-00 • 1UY-13440-01 • 1UY-13440-02</p>		
<p>10 060 9410 </p>	<p>Ø 55mm h 57mm Hiflo: HF123 Champion: COF023</p>	
<p>KAWASAKI (OEM): 16099-004</p>		

<p>10 060 9450 </p>	<p>Ø 60mm h 33mm Hiflo: HF136 Champion: COF036</p>	
<p>BETAMOTOR SUZUKI (OEM): 16510-38240</p>		
<p>10 060 9470 </p>	<p>Ø 38mm h 38mm Hiflo: HF167 Champion: COF067</p>	
<p>DAELIM (OEM): 15412-KN6-9612 LML</p>		
<p>10 060 9480 </p>	<p>Ø 44mm h 42mm Hiflo: HF566 Champion: COF466</p>	
<p>KAWASAKI (OEM): 52010-Y001 KYMCO (OEM): 1541A-LEA7-E00</p>		
<p>10 060 9490 </p>	<p>Ø 41mm h 35mm Hiflo: HF186 Champion: COF086</p>	
<p>APRILIA (OEM): 3HAA000309</p>		
<p>10 060 9501 </p>	<p>Ø 65mm h 73mm Hiflo: HF303 Champion: COF203</p>	
<p>HONDA (OEM): 15410-MM9-P00 • 15400-PFB-007 • 15410-MM9-305 • 15410-MT7-003 • 15410-MM9-003 15410-MM9-P01 • 15410-MM9-405 • 15412-MT7-003 • 15410-MM9-013 • 15410-MM9-P03 • 15410-MM5-003 KAWASAKI (OEM): 16097-1064 • 16097-1061 16097-0008 • 16097-0004 • 16097-1066 • 16097-1063 • 16097-1059 16097-1067 YAMAHA (OEM): 3FV-13440-20 • 5GH-13440-00 • 5GH-13440-30 • 5GH-13440-10 • 3FV-13440-00</p>		
<p>10 060 9511 </p>	<p>Ø 68mm h 65mm Hiflo: HF138 Champion: COF038</p>	
<p>APRILIA (OEM): 857187 CAGIVA KAWASAKI (OEM): 52010-S005 KYMCO (OEM): 1541A-PWB1-900 SUZUKI (OEM): 16510-03G00 • 16510-07L00 • 16510-06B01 • 16510-03G00-X07 • 16510-34E00 • 16510-06B00</p>		

<p>10 060 9521 </p>	<p>Ø 38mm h 36mm Hiflo: HF116 Champion: COF016</p>	
<p>HONDA(ATV) (OEM): 15412-MEB-671 • 15412-MEN-671 HUSQVARNA (OEM): 8000A7019</p>		
<p>10 060 9531 </p>	<p>Ø 76mm h 56mm Hiflo: HF401 Champion: COF301</p>	
<p>HONDA (OEM): 15410-422-004 • 15412-300-024 • 15410-426-000 • 15410-422-000 • 15412-300-325 • 15410-426-010 KAWASAKI (OEM): 16099-003 TRIUMPH (OEM): 121-00-31-T0-301 YAMAHA (OEM): 36Y-13441-00</p>		
<p>10 060 9541 </p>	<p>Ø 41mm h 52mm Hiflo: HF157 Champion: COF057</p>	
<p>KTM (OEM): 590.38.046.000 • 590.38.046.144 • 590.38.046.100 • 590.38.046.101</p>		
<p>10 060 9551 </p>	<p>Ø 76mm h 54mm Hiflo: HF164-165 Champion: COF064-065</p>	
<p>BMW (OEM): 11-42-7-673-541 • 11-42-7-719-357 • 11-42-7-707-217</p>		
<p>10 060 9561 </p>	<p>Ø 76mm h 92mm Hiflo: HF171 Champion: COF071B</p>	
<p>HARLEY DAVIDSON (OEM): 63731-99 • 63731-99A • 63798-99</p>		
<p>10 060 9571 </p>	<p>Ø 38mm h 44mm Hiflo: HF207 Champion: COF107</p>	
<p>BETA (OEM): 15.26060.000 KAWASAKI (OEM): 52010-0001 SUZUKI (OEM): 16510-35G00 • K5201-00001</p>		

<p>10 060 9581 </p>	<p>Ø 56mm h 74mm Hiflo: HF152 Champion: COF052</p>	
<p>APRILIA (OEM): 0256187</p>		
<p>10 060 9591 </p>	<p>Ø 33mm h 87mm Hiflo: HF652 Champion: COF552</p>	
<p>HUSABERG HUSQVARNA KTM (OEM): 773.38.005.100 • 773.38.005.101</p>		
<p>10 060 9601 </p>	<p>Ø 41mm h 69mm Hiflo: HF655 Champion: COF555</p>	
<p>HUSABERG HUSQVARNA KTM (OEM): 770.38.005.001 • 770.38.005.044 • 770.38.005.000</p>		
<p>10 060 9621 </p>	<p>Ø 44mm h 44mm Hiflo: HF139 Champion: COF039</p>	
<p>CCM KAWASAKI (OEM): 52010-S004 SUZUKI (OEM): 16510-29F00</p>		
<p>10 060 9641 </p>	<p>Ø 76mm h 41mm Hiflo: HF144 Champion: COF044</p>	
<p>YAMAHA (OEM): 1L9-13440-91 • 1L9-13441-11</p>		
<p>10 060 9651 </p>	<p>Ø 60mm h 37mm Hiflo: HF137 Champion: COF037</p>	
<p>SUZUKI (OEM): 16510-37440 • 16510-37450</p>		

10 060 9661 	Ø 65mm h 75mm Hiflo: HF156 Champion: COF056	
KTM (OEM): 583.38.045.100		
10 060 9671 	Ø 41mm h 130mm Hiflo: HF158 Champion: COF058	
KTM (OEM): 600.38.015.000 • 600.38.015.100		
10 060 9681 	Ø 65mm h 85mm Hiflo: HF148 Champion: COF048	
HONDA (OEM): 15400-PLM-A01PE • 15400-PLM-A02 TGB (OEM): 924153 YAMAHA (OEM): 5JW-13440-00		
10 060 9691 	Ø 76mm h 62mm Hiflo: HF160 Champion: COF060	
BMW (OEM): 11-42-7-719-357 • 11-42-7-721-779 HUSQVARNA (OEM): 7719357		
10 060 9721 	Ø 76mm h 68mm Hiflo: HF172 Champion: COF072C	
HARLEY DAVIDSON (OEM): 63782-80		
10 060 9731 	Ø 76mm h 86mm Hiflo: HF174 Champion: COF074	
HARLEY DAVIDSON (OEM): 63793-01K		

<p>10 060 9741 </p>	<p>Ø 65mm h 73mm Hiflo: HF177 Champion: COF077</p>	
<p>BUELL (OEM): 63806-00Y</p>		
<p>10 060 9751 </p>	<p>Ø 68mm h 65mm Hiflo: HF191 Champion: COF091</p>	
<p>PEUGEOT (OEM): 778117 TRIUMPH (OEM): T1210200</p>		
<p>10 060 9761 </p>	<p>Ø 65mm h 65mm Hiflo: HF553 Champion: COF453</p>	
<p>BENELLI (OEM): 018.01.07.101.000</p>		
<p>10 060 9771 </p>	<p>Ø 76mm h 58mm Hiflo: HF565 Champion: COF465</p>	
<p>APRILIA (OEM): 82883R • 82960R GILERA (OEM): 82883R PIAGGIO: 82883R</p>		
<p>10 060 9781 </p>	<p>Ø 41mm h 87mm Hiflo: HF611 Champion: COF511</p>	
<p>BMW (OEM): 11-42-7-715-456 HUSQVARNA (OEM): 7715456 SHERCO (OEM): 0116</p>		
<p>10 060 9791 </p>	<p>Ø 65mm h 65mm Hiflo: HF554 Champion: COF454</p>	
<p>MV AGUSTA (OEM): 8000A1428</p>		

10 060 9801 	Ø 45mm h 49mm Hiflo: HF563 Champion: COF082-463	
APRILIA (OEM): 9150166 • 874081 DERBI HUSQVARNA (OEM): 8000B0593 PIAGGIO (OEM): 880887		
10 060 9811 	Ø 101mm h 40mm Hiflo: HF146 Champion: COF046	
YAMAHA (OEM): 1J7-13440-90 • 1J7-13440-91 • 1J7-13441-10		
10 060 9821 	Ø 68mm h 66mm Champion: COF100180S	
PIAGGIO (OEM): 438038		
10 060 9880 	Ø 44mm h 46mm Hiflo: HF568 Champion: COF468	
KYMCO (OEM): 1541A-LEH6-E00		

10 060 9010 	Ø 96mm h 96,5mm	
PIAGGIO (OEM): 222721 • 830424		
10 060 9140 	Ø 76mm h 61,5mm	
AIXAM (OEM): 1WL098 LIGIER (OEM): 112397 MICROCAR : Lombardini motore LDW502 PIAGGIO (OEM): 850284 • 112397L		
10 060 9180 	Ø 45mm h 104,5mm	
MOTO GUZZI (OEM): 27153085		
10 060 9360 	Ø 65mm h 72mm	
AIXAM (Kubota diesel) (OEM): 15853-99170		
10 060 9420 	Ø 45mm h 89mm	
MOTO GUZZI (OEM): 19153000 • 19053099		

CROSS REFERENCES

HIFLO-NYP SO

HIFLO	NYP SO
HF111	10 060 9321
HF112	10 060 9191
HF113	10 060 9191
HF116	10 060 9521
HF123	10 060 9410
HF131	10 060 9061
HF132	10 060 9050
HF133	10 060 9271
HF136	10 060 9450
HF137	10 060 9651
HF138	10 060 9511
HF139	10 060 9621
HF141	10 060 9380
HF142	10 060 9380
HF144	10 060 9641
HF145	10 060 9290
HF146	10 060 9811
HF147	10 060 9081
HF148	10 060 9681
HF151	10 060 9201
HF152	10 060 9581
HF153	10 060 9101
HF154	10 060 9221
HF155	10 060 9211
HF156	10 060 9661
HF157	10 060 9541
HF158	10 060 9671
HF160	10 060 9691
HF161	10 060 9171
HF163	10 060 9131
HF164	10 060 9551
HF165	10 060 9551
HF167	10 060 9470
HF171	10 060 9561
HF172	10 060 9721
HF174	10 060 9731
HF177	10 060 9741
HF181	10 060 9031
HF183	10 060 9041
HF184	10 060 9071
HF185	10 060 9021
HF186	10 060 9490
HF191	10 060 9751
HF202	10 060 9241
HF204	10 060 9351
HF207	10 060 9571
HF303	10 060 9501
HF401	10 060 9531
HF551	10 060 9151
HF552	10 060 9121
HF553	10 060 9761
HF554	10 060 9791
HF562	10 060 9370
HF563	10 060 9801
HF565	10 060 9771
HF566	10 060 9480
HF568	10 060 9880
HF611	10 060 9781
HF652	10 060 9591
HF655	10 060 9601
HF971	10 060 9061

CHAMPION-NYP SO

CHAMPION	NYP SO
COF011	10 060 9321
COF013	10 060 9191
COF016	10 060 9521
COF023	10 060 9410
COF031	10 060 9061
COF032	10 060 9050
COF033	10 060 9271
COF036	10 060 9450
COF037	10 060 9651
COF038	10 060 9511
COF039	10 060 9621
COF041	10 060 9380
COF042	10 060 9380
COF044	10 060 9641
COF045	10 060 9290
COF046	10 060 9811
COF047	10 060 9081
COF048	10 060 9681
COF051	10 060 9201
COF052	10 060 9581
COF053	10 060 9101
COF054	10 060 9221
COF055	10 060 9211
COF056	10 060 9661
COF057	10 060 9541
COF058	10 060 9671
COF060	10 060 9691
COF061	10 060 9171
COF063	10 060 9131
COF064	10 060 9551
COF065	10 060 9551
COF067	10 060 9470
COF071B	10 060 9561
COF072C	10 060 9721
COF074	10 060 9731
COF077	10 060 9741
COF081	10 060 9031
COF082	10 060 9801
COF083	10 060 9041
COF084	10 060 9071
COF085	10 060 9021
COF086	10 060 9490
COF091	10 060 9751
COF102	10 060 9241
COF104	10 060 9351
COF107	10 060 9571
COF203	10 060 9501
COF301	10 060 9531
COF451	10 060 9151
COF452	10 060 9121
COF453	10 060 9761
COF454	10 060 9791
COF462	10 060 9370
COF463	10 060 9801
COF465	10 060 9771
COF466	10 060 9480
COF468	10 060 9880
COF511	10 060 9781
COF552	10 060 9591
COF555	10 060 9601
COF100180S	10 060 9821

CC	MODELLO - MODEL	ANNO YEAR	NYP SO
ADIVA			
125	AD Eu3	01-08	10 060 9041
250	AD (Piaggio) Eu2-Eu3	06-11	10 060 9041
400	AD-Cabrio (Piaggio)	09-11	10 060 9071
AIXAM			
400	Serie 400 Mac (Kubota Diesel)	UFI 92->	10 060 9360
400	Serie 400 SL (Kubota Diesel)	UFI 92->	10 060 9360
500	Serie 500.5 (Lombardini LGW523)	UFI 05->	10 060 9140
500	Serie A751 (Lombardini LGW523)	UFI 05->	10 060 9140
500	Serie Crossline MPI (Lombardini LGW523)	UFI 05->	10 060 9140
500	Serie Roadline MPI (Lombardini LGW523)	UFI 05->	10 060 9140
500	Serie Scouty GT/GT R (Lombardini LGW523)	UFI 05->	10 060 9140
APRILIA			
125	Atlantic	02-13	10 060 9041
125	Habana-Habana Custom	99-02	10 060 9031
125	Leonardo-ST	96-05	10 060 9021
125	Mojito- Mojito Custom	03-10	10 060 9041
125	Mojito Retro-Custom	99-02	10 060 9031
125	RS4	11-14	10 060 9801
125	Scarabeo (Piaggio)	03-05	10 060 9041
125	Scarabeo GT-Street (Piaggio) Eu3	03-07	10 060 9041
125	Scarabeo Light-i.e.-Net	07-13	10 060 9490
125	Scarabeo-GT (Rotax)	99-03	10 060 9021
125	Sport City Cube-One-Street	02-13	10 060 9041
125	SR Max 4T-Motard 4T	11-14	10 060 9041
150	Leonardo-ST	96-05	10 060 9021
150	Mojito-Custom	03-08	10 060 9041
150	Scarabeo-GT	99-03	10 060 9021
200	Atlantic	03-08	10 060 9041
200	Scarabeo (Piaggio)	03-05	10 060 9041
200	Scarabeo GT-Street (Piaggio) Eu3	03-07	10 060 9041
200	Scarabeo Light-i.e.-Net	07-13	10 060 9490
200	Scarabeo-GT (Rotax)	99-03	10 060 9021
200	Sport City-Cube Eu3	04-13	10 060 9041
250	Atlantic-i.e.	04-09	10 060 9041
250	Scarabeo-GT-i.e.-Light (Piaggio)	03-11	10 060 9041
250	Sport City-Cube i.e. Eu3	06-11	10 060 9041
300	Atlantic	10-13	10 060 9041
300	Scarabeo Light-Special Eu3	09-13	10 060 9041
300	Sport City Cube i.e.-Street Eu3	08-13	10 060 9041
300	SR Max	11-14	10 060 9041
311	TX-ADV-M	85-93	10 060 9201
320	TR	78-84	10 060 9201
350	ETX-Tuareg Wind	85-92	10 060 9201
400	Atlantic Sprint	06-09	10 060 9071
400	Scarabeo-Light	06-09	10 060 9071
450	RXV SXV	06-14	10 060 9801
500	Atlantic-Sprint	01-09	10 060 9071
500	Scarabeo GT-Abs-Light	02-13	10 060 9071
550	RXV SXV	06-14	10 060 9801
600	ETX-Pegaso-Tuareg	85-93	10 060 9201
650	6.5 Moto-Stark	95-01	10 060 9201
650	Pegaso	93-04	10 060 9201
660	Pegaso Street-Trail-Factory	05-13	10 060 9290
750	SL 750 Shiver-GT-Abs	07-14	10 060 9771
750	SMV 750 Dorsoduro-Abs	08-14	10 060 9771
850	Mana-GT-Abs	07-14	10 060 9771
850	SRV	12-14	10 060 9771
1000	ETV 1000 Caponord	01-08	10 060 9581
1000	RST 1000 Futura	01-06	10 060 9581
1000	RSV 1000 Mille-Tuono	99-10	10 060 9581
1000	RSV 1000 RSV4 R-Tuono V4	09-16	10 060 9511
1000	SL 1000 Falco	00-06	10 060 9581
1200	Caponord	13-14	10 060 9771
1200	Dorsoduro-Abs-ATC	11-16	10 060 9771

CC	MODELLO - MODEL	ANNO YEAR	NYP SO
BENELLI			
125	Adiva	00-03	10 060 9041
150	Adiva	00-03	10 060 9041
250	Adiva	06-08	10 060 9041
899	899-900 (Tutti - All Models) Cafe Racer-TNT-Tornado	10-11	10 060 9761
1130	1130 (tutti) Cafe Racer-TNT-Trek	04-11	10 060 9761
BETAMOTOR			
250	250 Evo 4T	09-14	10 060 9571
250	250 Rev 4T	07-08	10 060 9571
250	250 RR Enduro 4T (1°filtro -1st filter)	05-09	10 060 9211
250	250 RR Enduro 4T (2°filtro - 2nd filter)	05-09	10 060 9541
300	300 Evo 4T	09-14	10 060 9571
350	350 Alp 4.0-M4 4T-Motard 4.0	01-14	10 060 9450
400	400 RR Enduro 4T (1°filtro -1st filter)	05-09	10 060 9211
400	400 RR Enduro 4T (2°filtro - 2nd filter)	05-09	10 060 9541
450	450 RR Enduro 4T (1°filtro -1st filter)	05-09	10 060 9211
450	450 RR Enduro 4T (2°filtro - 2nd filter)	05-09	10 060 9541
525	525 RR Enduro 4T (1°filtro -1st filter)	05-09	10 060 9211
525	525 RR Enduro 4T (2°filtro - 2nd filter)	05-09	10 060 9541
BMW			
125	125 C1	01-03	10 060 9021
200	200 C1	02-03	10 060 9021
450	G450 X	09-12	10 060 9781
450	R45-N	78-80	10 060 9171
500	R50/5	69-73	10 060 9171
600	C600 Sport	12-15	10 060 9551
600	R60 (Tutti - All Models)	69-88	10 060 9171
650	C650 GT	12-15	10 060 9551
650	F650 CS-F-GS-Dakar-ST	93-07	10 060 9201
650	G650 (tutte-all models) GS-X	07-15	10 060 9201
750	K75 (Tutti - All Models)	85-97	10 060 9131
750	R75 (Tutti - All Models)		10 060 9171
800	F650 GS SE	08-11	10 060 9691
800	F700 GS	13-15	10 060 9691
800	F800 GS-Adventure	07-15	10 060 9691
800	F800 GT	13-15	10 060 9691
800	F800 R	10-15	10 060 9691
800	F800 S	06-10	10 060 9551
800	F800 ST	06-13	10 060 9551
800	F800 ST Touring	12	10 060 9551
800	R80 (Tutti - All Models)	80-95	10 060 9171
850	R850 (Tutti - All Models)	99-06	10 060 9131
900	R90 (Tutti - All Models)	73-76	10 060 9171
1000	1000 HP4	13-15	10 060 9691
1000	K 1-K100 (Tutti - All Models)	83-94	10 060 9131
1000	R100 (Tutti - All Models)	73-96	10 060 9171
1000	S1000 R-RR-RR Sport	10-15	10 060 9691
1100	K1100 (Tutti - All Models)	92-99	10 060 9131
1100	R1100 (Tutti - All Models)	93-05	10 060 9131
1150	R1150 (Tutti - All Models)	99-06	10 060 9131
1170	R nine T	14-15	10 060 9551
1200	K1200 C	99-99	10 060 9131
1200	K1200 GT	04-08	10 060 9131
1200	K1200 LT-RS-RS SE	99-08	10 060 9131
1200	K1200 R-S-RS-RS SE	05-08	10 060 9691
1200	R1200 C (Tutti - All Models)	99-05	10 060 9131
1200	R1200 CL	03-05	10 060 9131
1200	R1200 GS	04-09	10 060 9551
1200	R1200 GS-ADV	10-13	10 060 9551
1200	R1200 GS-ADV	13-14	10 060 9691
1200	R1200 HP2 Enduro-Megamoto-Sport	05-10	10 060 9551
1200	R1200 R	07-15	10 060 9551
1200	R1200 RT	05-14	10 060 9551
1200	R1200 S	06-09	10 060 9551
1200	R1200 ST	05-08	10 060 9551
1300	K1300 (Tutti - All Models) GT-GT SE-R-R-R Dynamic-S-S HP-S Sport	09-14	10 060 9691
1600	K1600 (Tutti - All Models)	11-15	10 060 9551

CC	MODELLO - MODEL	ANNO YEAR	NYP SO	CC	MODELLO - MODEL	ANNO YEAR	NYP SO
BUELL				796	796 Monster	11-14	10 060 9101
500	500 Blast	02-09	10 060 9741	800	800 Monster	03-07	10 060 9101
900	900 XB9 (tutte-all models)	02-10	10 060 9741	800	800 Sport	03-03	10 060 9101
1200	1200 Cyclone M2	97-02	10 060 9561	800	800 SS	03-07	10 060 9101
1200	1200 Lightning S1,X1	94-02	10 060 9561	820	820 Hypermotard-Hyperstrada	13-14	10 060 9101
1200	1200 Thunderbolt S2,S2T,S3,S3T	94-02	10 060 9561	848	848	08-10	10 060 9101
1200	1200 White Lightning X1W	02	10 060 9561	848	848-Evo-Streetfighter	11-14	10 060 9101
1200	1200 XB12 (tutte-all models)	04-10	10 060 9741	851	851 Strada	89-92	10 060 9101
CAGIVA				888	888 Strada	92-94	10 060 9101
125	125 Cucciolo/Nuvola	00	10 060 9031	900	900 FE	98-99	10 060 9101
350	350 Alazzurra TL,GT		10 060 9101	900	900 MH	01	10 060 9101
650	650 Alazzurra	82-88	10 060 9101	900	900 Monster	93-02	10 060 9101
650	650 Raptor i.e.-V-Raptor	00-05	10 060 9511	900	900 S2	79-85	10 060 9101
750	750 Elefant	93-97	10 060 9101	900	900 Sport	02	10 060 9101
900	900 Elefant	90-97	10 060 9101	900	900 Super Sport	90-02	10 060 9101
900	900 Grand Canyon	90-92	10 060 9101	906	906 Paso Sports	88-91	10 060 9101
1000	1000 Navigator	00-05	10 060 9511	907	907 I.E.	90-93	10 060 9101
1000	1000 Raptor-V-Raptor-Xtra-Raptor	00-05	10 060 9511	916	916 Monster S4	01-03	10 060 9101
CCM				916	916 Senna	93-99	10 060 9101
404	404 (Tutti - All Models)		10 060 9621	944	944 ST2	97-03	10 060 9101
604	604 (Tutti - All Models)		10 060 9201	989	989 Desmosedici RR	08	10 060 9101
644	644 (Tutti - All Models)		10 060 9651	992	992 S2R 1000	06	10 060 9101
CASALINI				992	992 ST3	04-07	10 060 9101
505	Sulky 505 Diesel (Lombardini LDW 502)	UFI 95->	10 060 9140	996	996	00-01	10 060 9101
505	Ydea 505 GLX Diesel (Lombardini)	UFI	10 060 9140	996	996 Biposto	99-06	10 060 9101
DAELIM				996	996 Monster S4R	04-06	10 060 9101
125	VC125	96	10 060 9470	996	996 ST4 S	02-05	10 060 9101
125	VS125 Evolution	97-05	10 060 9470	998	998	02-03	10 060 9101
125	VT125 Evolution	97-05	10 060 9470	998	998 Monster S4R Testastretta	07-08	10 060 9101
DERBI				999	999	03-06	10 060 9101
125	Boulevard Eu3	02-13	10 060 9041	1000	1000 DS-S	04-06	10 060 9101
125	GP1 E2-Low Seat E3	06-11	10 060 9041	1000	1000 GT Sportclassic	07-10	10 060 9101
125	GPR 4T	09-13	10 060 9801	1000	1000 Monster i.e.-S-S2R	03-08	10 060 9101
125	Mulhacen 4T	07-13	10 060 9801	1000	1000 Smart	06	10 060 9101
125	Rambla	08-13	10 060 9041	1000	1000 Sport	06-09	10 060 9101
125	Senda R	09-13	10 060 9801	1000	1000 SS	03-05	10 060 9101
125	Sonar	10-13	10 060 9041	1098	1098	07-08	10 060 9101
125	Terra	07-13	10 060 9801	1098	1098 R-S	07-08	10 060 9101
200	Boulevard Eu3	02-08	10 060 9041	1099	1099 Streetfighter-S	09-13	10 060 9101
250	Boulevard	02-08	10 060 9041	1100	1100 Hypermotard-S	08-12	10 060 9101
250	GP1	06-09	10 060 9041	1100	1100 Monster	08-13	10 060 9101
250	Rambla	08-10	10 060 9041	1100	1100 Multistrada-S	07-09	10 060 9101
300	Rambla i	10-13	10 060 9041	1198	1198	09-11	10 060 9101
660	Mulhacen	06-12	10 060 9290	1198	1198 Diavel	11-14	10 060 9101
DUCATI				1200	1200 Monster	14	10 060 9101
350	350 F3		10 060 9101	1200	1200 Multistrada	10-14	10 060 9101
350	350 Indiana		10 060 9101	FANTIC			
350	350 Pantah		10 060 9101	125	125 Caballero	08-13	10 060 9380
400	400 SS Junior Super Sport	92-94	10 060 9101	GAS GAS			
600	600 Monster	93-01	10 060 9101	250	EC250 F 4T	10-11	10 060 9380
600	600 SL Pantah Sports	81-85	10 060 9101	400	400 FSE-SM	03-07	10 060 9191
600	600 SS	93-98	10 060 9101	450	450 FSE-SM	03-08	10 060 9191
620	620 Monster	03-06	10 060 9101	450	450 Pampera	07-08	10 060 9191
620	620 Multistrada	06	10 060 9101	510	510 EC-SM	09	10 060 9191
620	620 Sport	03	10 060 9101	GILERA			
650	650 Indiana Custom	86-88	10 060 9101	125	Arcore		10 060 9101
695	695 Monster	07-08	10 060 9101	125	DNA	01-03	10 060 9041
696	696 Monster	09-14	10 060 9101	125	Nexus	07-13	10 060 9041
748	748	94-03	10 060 9101	125	Runner VX-VXR-SC-ST-Race Eu3	02-14	10 060 9041
749	749	03-06	10 060 9101	180	DNA	01-03	10 060 9041
750	750 F1 MKII	85-87	10 060 9101	180	Runner VXR	01-03	10 060 9041
750	750 Indiana Custom	87-88	10 060 9101	200	Runner VX-VXR-SC-ST-Race Eu3	03-13	10 060 9041
750	750 Monster	96-02	10 060 9101	250	Nexus-SP	06-08	10 060 9041
750	750 Paso	86-90	10 060 9101	300	Nexus i.e. Eu3	08-13	10 060 9041
750	750 Sport	01-02	10 060 9101	500	Fuoco	07-12	10 060 9071
750	750 Sport	88-90	10 060 9101	500	Nexus-SP	03-13	10 060 9071
750	750 SS	91-02	10 060 9101	800	GP-GP Centenario	08-14	10 060 9771
795	795 Monster	12-14	10 060 9101				
796	796 Hypermotard	10-12	10 060 9101				

CC	MODELLO - MODEL	ANNO YEAR	NYP SO	CC	MODELLO - MODEL	ANNO YEAR	NYP SO
HARLEY DAVIDSON				1200	XR1200 Sportster	09-10	10 060 9711
883	XL53C Sportster Custom 53	99-03	10 060 9711	1200	XR1200X Sportster	11-12	10 060 9711
883	XL53C Sportster Custom 53	99-03	10 060 9711	1200	XR1200X Sportster	11-12	10 060 9711
883	XL883 Sportster (EFI)	07-08	10 060 9711	1250	VRSCDX V-Rod 10th Anniversary Edition	12	10 060 9731
883	XL883 Sportster (EFI)	07-08	10 060 9711	1340	FLH	82-84	10 060 9721
883	XL883 Sportster R	02-03	10 060 9711	1340	FLHC Classic	82	10 060 9721
883	XL883 Sportster R	02-03	10 060 9711	1340	FLHP Road King Police	09	10 060 9561
883	XL883C Sportster Custom (EFI)	07-09	10 060 9711	1340	FLHR Road King	96-98	10 060 9711
883	XL883C Sportster Custom (EFI)	07-09	10 060 9711	1340	FLHR Road King	96-98	10 060 9711
883	XL883L Sportster Low (EFI)	07-15	10 060 9711	1340	FLHR Road King	99-06	10 060 9561
883	XL883L Sportster Low (EFI)	07-15	10 060 9711	1340	FLHR Road King ie	07-15	10 060 9561
883	XL883N Sportster Iron	10-15	10 060 9711	1340	FLHRCI Road King Classic	99-06	10 060 9561
883	XL883N Sportster Iron	10-15	10 060 9711	1340	FLHRI Road King ie	01-06	10 060 9561
883	XL883R Sportster R (EFI)	07->	10 060 9711	1340	FLHRS Road King Custom	04-06	10 060 9561
883	XL883R Sportster R (EFI)	07->	10 060 9711	1340	FLHRSI Road King Custom ie	04-06	10 060 9561
883	XL883R Sportster Roadster (EFI)	12->	10 060 9711	1340	FLHS	82-84	10 060 9721
883	XL883R Sportster Roadster (EFI)	12->	10 060 9711	1340	FLHS	87-94	10 060 9711
883	XLH883 (up to early 1984)	80-84	10 060 9721	1340	FLHS	87-94	10 060 9711
883	XLH883 Sportster	86-06	10 060 9711	1340	FLHT (from late 1984)	84-89	10 060 9711
883	XLH883 Sportster	86-06	10 060 9711	1340	FLHT (from late 1984)	84-89	10 060 9711
883	XLH883 Sportster Hugger	99-03	10 060 9711	1340	FLHT Electra Glide	00-01	10 060 9561
883	XLH883 Sportster Hugger	99-03	10 060 9711	1340	FLHT Electra Glide	96-99	10 060 9711
883	XLH883 Sportster R Flat Track	00->	10 060 9711	1340	FLHT Electra Glide	96-99	10 060 9711
883	XLH883 Sportster R Flat Track	00->	10 060 9711	1340	FLHT Electra Glide Standard	02-06	10 060 9561
883	XLH883C Sportster Custom	03-06	10 060 9711	1340	FLHTC Classic	84-98	10 060 9711
883	XLH883C Sportster Custom	03-06	10 060 9711	1340	FLHTC Classic	84-98	10 060 9711
883	XLH883L Sportster Low	05-06	10 060 9711	1340	FLHTC Electra Glide Classic	02-13	10 060 9561
883	XLH883L Sportster Low	05-06	10 060 9711	1340	FLHTCI Electra Glide Classic ie	03-09	10 060 9561
883	XLH883R Sportster R	06->	10 060 9711	1340	FLHTC-UI Electra Glide Ultra Classic	99-02	10 060 9561
883	XLH883R Sportster R	06->	10 060 9711	1340	FLHTC-UI Electra Glide Ultra Classic ie	03-06	10 060 9561
1000	XL1000 (from late 1984)	84-85	10 060 9711	1340	FLHTC-UI Ultra Classic	80-82	10 060 9711
1000	XL1000 (from late 1984)	84-85	10 060 9711	1340	FLHTC-UI Ultra Classic	80-82	10 060 9711
1000	XL1000 (from late 1984)	84-85	10 060 9711	1340	FLHTC-UI Ultra Classic	87-98	10 060 9711
1000	XL1000 (from late 1984)	84-85	10 060 9711	1340	FLHTC-UI Ultra Classic	87-98	10 060 9711
1000	XL1000 (up to early 1984)	80-84	10 060 9721	1340	FLHTI Electra Glide Standard ie	03-09	10 060 9561
1000	XLX1000 (from late 1984)	84-85	10 060 9711	1340	FLSTC Heritage Softail Classic	00-06	10 060 9561
1000	XLX1000 (from late 1984)	84-85	10 060 9711	1340	FLSTC Heritage Softail Classic	99->	10 060 9711
1000	XLX1000 (up to early 1984)	83-84	10 060 9721	1340	FLSTC Heritage Softail Classic	99->	10 060 9711
1100	XLH1100	86-88	10 060 9711	1340	FLSTC Softail Classic	80-98	10 060 9711
1100	XLH1100	86-88	10 060 9711	1340	FLSTC Softail Classic	80-98	10 060 9711
1100	XLH1100 (up to early 1984)	80-84	10 060 9721	1340	FLSTCI Heritage Softail Classic ie	01-06	10 060 9561
1199	XL50 50th Anniversary Sportster (EFI)	07->	10 060 9711	1340	FLSTF Fat Boy	00-06	10 060 9561
1199	XL50 50th Anniversary Sportster (EFI)	07->	10 060 9711	1340	FLSTF Fat Boy	89-99	10 060 9711
1200	XL1200C Classic Sportster	96-98	10 060 9711	1340	FLSTF Fat Boy	89-99	10 060 9711
1200	XL1200C Classic Sportster	96-98	10 060 9711	1340	FLSTFSE Screamin' Eagle Fat Boy	05-'05	10 060 9561
1200	XL1200C Sportster 1200 Custom	99-15	10 060 9711	1340	FLSTN Softail Special	96->	10 060 9711
1200	XL1200C Sportster 1200 Custom	99-15	10 060 9711	1340	FLSTN Softail Special	96->	10 060 9711
1200	XL1200L Sportster 1200 Low (EFI)	07-11	10 060 9711	1340	FLSTS Heritage Springer	00-03	10 060 9561
1200	XL1200L Sportster 1200 Low (EFI)	07-11	10 060 9711	1340	FLSTS Heritage Springer	98-99	10 060 9711
1200	XL1200N Sportster 1200 Nightster (EFI)	08-12	10 060 9711	1340	FLSTS Heritage Springer	98-99	10 060 9711
1200	XL1200N Sportster 1200 Nightster (EFI)	08-12	10 060 9711	1340	FLSTSC Softail Springer Classic	05-06	10 060 9561
1200	XL1200R Sportster 1200 Roadster	04-06	10 060 9711	1340	FLSTSCI Softail Springer Classic ie	05-06	10 060 9561
1200	XL1200R Sportster 1200 Roadster	04-06	10 060 9711	1340	FLSTSI Heritage Springer ie	03	10 060 9561
1200	XL1200R Sportster 1200 Roadster (EFI)	07-08	10 060 9711	1340	FLT	80-90	10 060 9711
1200	XL1200R Sportster 1200 Roadster (EFI)	07-08	10 060 9711	1340	FLT	80-90	10 060 9711
1200	XL1200S Sportster 1200 Sport	96-98	10 060 9711	1340	FLTC Tour Glide	80-92	10 060 9711
1200	XL1200S Sportster 1200 Sport	96-98	10 060 9711	1340	FLTC Tour Glide	80-92	10 060 9711
1200	XL1200S Sportster 1200 Sport	99-03	10 060 9711	1340	FLTC-U	87-94	10 060 9711
1200	XL1200S Sportster 1200 Sport	99-03	10 060 9711	1340	FLTC-U	87-94	10 060 9711
1200	XL1200V Sportster 1200 Seventy-Two	13-15	10 060 9711	1340	FLTC-UI Electra Glide Ultra Classic	00	10 060 9561
1200	XL1200V Sportster 1200 Seventy-Two	13-15	10 060 9711	1340	FLTR Road Glide	98->	10 060 9711
1200	XL1200X Sportster 1200 Forty-Eight	10-15	10 060 9711	1340	FLTR Road Glide	98->	10 060 9711
1200	XL1200X Sportster 1200 Forty-Eight	10-15	10 060 9711	1340	FLTRI Road Glide ie	99-06	10 060 9561
1200	XLH1200 (up to early 1984)	80-84	10 060 9721	1340	FXD Dyna Super Glide	99-05	10 060 9561
1200	XLH1200 Sportster	88-95	10 060 9711	1340	FXDC Dyna Super Glide Custom	05	10 060 9561
1200	XLH1200 Sportster	88-95	10 060 9711	1340	FXDCI Dyna Super Glide Custom ie	05-06	10 060 9561
1200	XLH1200 Sportster	99->	10 060 9711	1340	FXDL Dyna Low Rider	99-05	10 060 9561
1200	XLH1200 Sportster	99->	10 060 9711	1340	FXDL Dyna Low Rider ie	07-09	10 060 9561
1200	XR1200 Sportster	09-10	10 060 9711	1340	FXDLI Dyna Low Rider ie	04-06	10 060 9561

CC	MODELLO - MODEL	ANNO YEAR	NYP SO	CC	MODELLO - MODEL	ANNO YEAR	NYP SO
1340	FXDWG Dyna Wide Glide	99-05	10 060 9561				
1340	FXDWG Dyna Wide Glide ie	04-06	10 060 9561	1450	FLHTCUSE6 CVO SE Ultra Classic Electra Glide ie	11	10 060 9561
1340	FXDX Dyna Super Glide Sport	99-05	10 060 9561				
1340	FXDXI Dyna Super Glide Sport ie	04-05	10 060 9561	1450	FLHTCUSE7 CVO SE Ultra Classic Electra Glide ie	12	10 060 9561
1340	FXDXT Dyna Super Glide T-Sport	01-03	10 060 9561				
1340	FXE Super Glide	82-84	10 060 9721	1450	FLHTCUSE8 CVO SE Ultra Classic Electra Glide ie	13-14	10 060 9561
1340	FXEF Fat Boy	85	10 060 9721	1450	FLHTCUTG Tri Glide Ultra Classic	10-15	10 060 9561
1340	FXLR Low Rider	87-94	10 060 9711	1450	FLHTK Electra Glide Ultra Limited	10-15	10 060 9561
1340	FXLR Low Rider	87-94	10 060 9711	1450	FLHTP Electra Glide Police	09	10 060 9561
1340	FXR Super Glide	82-94	10 060 9711	1450	FLHX Street Glide ie	07-15	10 060 9561
1340	FXR Super Glide	82-94	10 060 9711	1450	FLHX/XI Street Glide ie	06	10 060 9561
1340	FXRC Low Rider	87->	10 060 9711	1450	FLHXSE CVO Street Glide ie	10	10 060 9561
1340	FXRC Low Rider	87->	10 060 9711	1450	FLHXSE2 CVO Street Glide ie	11	10 060 9561
1340	FXRD Grand Touring	86->	10 060 9711	1450	FLHXSE3 CVO Street Glide ie	12	10 060 9561
1340	FXRD Grand Touring	86->	10 060 9711	1450	FLHXXX Street Glide Trike	10-11	10 060 9561
1340	FXRS Low Glide	82-82	10 060 9711	1450	FLS Softail Slim	13-15	10 060 9561
1340	FXRS Low Glide	82-82	10 060 9711	1450	FLST Heritage Softail	06	10 060 9561
1340	FXRS Low Rider	87-94	10 060 9711	1450	FLSTC Heritage Softail Classic ie	07-15	10 060 9561
1340	FXRS Low Rider	87-94	10 060 9711	1450	FLSTF Fat Boy ie	03-15	10 060 9561
1340	FXRS Low Rider Convertible	90-94	10 060 9711	1450	FLSTFB Fat Boy Lo ie	10-15	10 060 9561
1340	FXRS Low Rider Convertible	90-94	10 060 9711	1450	FLSTFB Fat Boy Special	12	10 060 9561
1340	FXRT Sport Glide	83-89	10 060 9711	1450	FLSTI Heritage Softail ie	06	10 060 9561
1340	FXRT Sport Glide	83-89	10 060 9711	1450	FLSTN Softail Deluxe ie	07-15	10 060 9561
1340	FXSBSE CVO Breakout	13-15	10 060 9561	1450	FLSTN/NI Softail Deluxe ie	05-06	10 060 9561
1340	FXST Softail	84-85	10 060 9711	1450	FLSTSB Softail Cross Bones	09-11	10 060 9561
1340	FXST Softail	84-85	10 060 9711	1450	FLSTSC Softail Springer Classic ie	07	10 060 9561
1340	FXST Softail	87-90	10 060 9711	1450	FLSTSE CVO Softail Convertible	10	10 060 9561
1340	FXST Softail	87-90	10 060 9711	1450	FLSTSE2 CVO Softail Convertible	11	10 060 9561
1340	FXSTB Night Train	99->	10 060 9711	1450	FLSTSE3 CVO Softail Convertible	12	10 060 9561
1340	FXSTB Night Train	99->	10 060 9711	1450	FLTR Road Glide ie	07-09	10 060 9561
1340	FXSTB Night Train ie	00-06	10 060 9561	1450	FLTRSE3 CVO Road Glide	09	10 060 9561
1340	FXSTC Softail Custom	00	10 060 9561	1450	FLTRU Road Glide Ultra	11-15	10 060 9561
1340	FXSTC Softail Custom	87-99	10 060 9711	1450	FLTRUSE CVO Road Glide Ultra	11	10 060 9561
1340	FXSTC Softail Custom	87-99	10 060 9711	1450	FLTRX Road Glide Custom	10-15	10 060 9561
1340	FXSTD Softail Deuce	00-06	10 060 9561	1450	FLTRXSE CVO Road Glide Custom	12	10 060 9561
1340	FXSTDI Softail Deuce ie	01-06	10 060 9561	1450	FLTRXSE2 CVO Road Glide Custom	12-14	10 060 9561
1340	FXSTDSE Screamin' Eagle Softail Deuce	03-04	10 060 9561	1450	FXCW Softail Rocker	09	10 060 9561
1340	FXSTS Springer Softail	00-06	10 060 9561	1450	FXCWC Softail Rocker C	09-11	10 060 9561
1340	FXSTS Springer Softail	87-99	10 060 9711	1450	FXDB Street Bob ie	07-15	10 060 9561
1340	FXSTS Springer Softail	87-99	10 060 9711	1450	FXDBI Street Bob ie	06	10 060 9561
1340	FXSTSB Bad Boy	96->	10 060 9711	1450	FXDC Dyna Super Glide Custom ie	07-14	10 060 9561
1340	FXSTSB Bad Boy	96->	10 060 9711	1450	FXDF Dyna Fat Bob	09-15	10 060 9561
1340	FXSTSI Springer Softail ie	03-06	10 060 9561	1450	FXDFSE Dyna Fat Bob	09	10 060 9561
1340	FXWG Wide Glide	82-86	10 060 9721	1450	FXDFSE2 CVO Dyna Fat Bob	10	10 060 9561
1340	VRSCA V-Rod	02-06	10 060 9731	1450	FXDI Dyna Super Glide ie	04-10	10 060 9561
1340	VRSCAW V-Rod ie	07-09	10 060 9731	1450	FXDI35 35th Anniversary Dyna Super Glide ie	06	10 060 9561
1340	VRSCB V-Rod	04-05	10 060 9731				
1340	VRSCD Night Rod	06	10 060 9731	1450	FXDSE Screamin' Eagle Dyna ie	07	10 060 9561
1340	VRSCD Night Rod ie	07-08	10 060 9731	1450	FXDSE2 Screamin' Eagle Dyna ie	08	10 060 9561
1340	VRSCDX Night Rod Special ie	07-15	10 060 9731	1450	FXDWG Dyna Wide Glide ie	07-15	10 060 9561
1340	VRSCF V-Rod Muscle	09-15	10 060 9731	1450	FXST Softail Standard ie	00-07	10 060 9561
1340	VRSCR Street Rod	06	10 060 9731	1450	FXSTB Night Train ie	07-09	10 060 9561
1340	VRSCR Street Rod ie	07	10 060 9731	1450	FXSTC Softail Custom ie	07-10	10 060 9561
1340	VRSCSE Screamin' Eagle V-Rod	05	10 060 9731	1450	FXSTD Softail Deuce ie	07	10 060 9561
1340	VRSCX ie	07	10 060 9731	1450	FXSTSE SE Softail Springer ie	07	10 060 9561
1450	FLHRC Road King Classic ie	07-15	10 060 9561	1450	FXSTSE2/3 SE Softail Springer ie	08-09	10 060 9561
1450	FLHRS Road King Custom ie	07	10 060 9561	1584	FXS Blackline	12-13	10 060 9561
1450	FLHRSE3 Screamin' Eagle Road King ie	07	10 060 9561	1690	FLD Switchback	12-15	10 060 9561
1450	FLHRSE4 Screamin' Eagle Road King ie	08	10 060 9561	1690	FLHXS Street Glide Special ie	14-15	10 060 9561
1450	FLHRSE5 CVO Road King	13	10 060 9561	1690	FLRT Freewheeler	15	10 060 9561
1450	FLHTCSE Screamin' Eagle Electra Glide	04	10 060 9561	1690	FLSTN CVO Softail Deluxe ie	14-15	10 060 9561
1450	FLHTCSE2 Screamin' Eagle Electra Glide 2	05	10 060 9561	1690	FXSB Breakout	13-15	10 060 9561
1450	FLHTCU Ultra Classic Electra Glide ie	07-15	10 060 9561	1802	FLHRSE6 CVO Road King	14	10 060 9561
1450	FLHTCUSE2 SE Ultra Classic Electra Glide ie	07	10 060 9561	1802	FLHTKSE CVO SE Electra Glide Ultra Limited	10-15	10 060 9561
1450	FLHTCUSE3 SE Ultra Classic Electra Glide ie	08	10 060 9561	HONDA			
1450	FLHTCUSE4/5 CVO SE Ultra Classic Electra Glide ie	09-10	10 060 9561	125	CBF125	14	10 060 9191
				125	VT125 Shadow	99-08	10 060 9191
				125	XL125 V Varadero	01-12	10 060 9191

CC	MODELLO - MODEL	ANNO YEAR	NYP SO	CC	MODELLO - MODEL	ANNO YEAR	NYP SO
125	XL125 V Varadero De Luxe	11	10 060 9191	600	XL600	83-88	10 060 9191
150	CRF150 R	07-15	10 060 9521	600	XL600 V Transalp	87-07	10 060 9501
200	XR200 R	84-02	10 060 9191	600	XR600	85-02	10 060 9191
250	AX1		10 060 9191	650	CB650	14-15	10 060 9351
250	CB250	78-85	10 060 9321	650	CB650	79-84	10 060 9531
250	CBF250	04-06	10 060 9191	650	CB650	91-92	10 060 9501
250	CBR250	11-13	10 060 9191	650	CBR650 F	14-15	10 060 9351
250	CBX250 RS	00	10 060 9191	650	CX650	83-86	10 060 9321
250	CBX250 RSE	83-86	10 060 9191	650	FMX650	05-07	10 060 9191
250	CM250 Custom	81-85	10 060 9321	650	FX650 Vigor	99-02	10 060 9191
250	CRF250	04-15	10 060 9191	650	GL650 Silver Wing	83-86	10 060 9321
250	NSS250 Forza	08-12	10 060 9351	650	NT650 Hawk GT	88-91	10 060 9501
250	NX250	88-95	10 060 9191	650	NT650 V Deauville	98-05	10 060 9501
250	TLR250	85-87	10 060 9191	650	NTV650 Revere	93-97	10 060 9501
250	VT250	83-90	10 060 9321	650	NX650 Dominator	88-02	10 060 9191
250	VTR250	88-90	10 060 9321	650	SLR650 Vigor	97-00	10 060 9191
250	XL250	82-90	10 060 9191	650	XR650	93-15	10 060 9191
250	XR250	82-04	10 060 9191	650	XRV650 Africa Twin	88-90	10 060 9501
300	CB300	15	10 060 9191	700	700 Integra (DCT)	12-13	10 060 9351
300	CBR300	14-15	10 060 9191	700	CTX700	14-15	10 060 9351
300	NSS300 Forza	13-14	10 060 9351	700	NC700	12-15	10 060 9351
300	SH300i (Abs)	07-13	10 060 9351	700	NSA700 A	08-10	10 060 9351
350	CB350	73-74	10 060 9531	700	NT700 Deauville (Abs)	06-13	10 060 9351
350	CB350	86-89	10 060 9321	700	XL700 V Transalp	08-13	10 060 9351
350	XL350	85-87	10 060 9191	750	CB750	70-85	10 060 9531
350	XL-X350		10 060 9191	750	CB750	91-03	10 060 9501
350	XR350	83-87	10 060 9191	750	CBX750 FE,FG,F2G	84-86	10 060 9241
400	CB400	78-84	10 060 9321	750	RVF750 R	94-98	10 060 9501
400	CB400 F,F1,F2	75-79	10 060 9531	750	VF750	82-89	10 060 9241
400	CB400 F,FK (CB-1)	89-92	10 060 9501	750	VF750	93-03	10 060 9501
400	CBR400 RR		10 060 9501	750	VFR750	86-87	10 060 9241
400	CBX400 F	83-86	10 060 9321	750	VFR750	88-98	10 060 9501
400	CM400 Chopper	81-83	10 060 9321	750	VT750 C Shadow	83	10 060 9241
400	CM400 Chopper	79-80	10 060 9321	750	VT750 C Shadow	04-15	10 060 9351
400	CX400	82-84	10 060 9321	750	VT750 CD CD2 Shadow	97-07	10 060 9501
400	FSC400 Silver Wing	06-13	10 060 9351	750	XRV750 Africa Twin	90-02	10 060 9501
400	VF400 FD	83-86	10 060 9241	800	PC800 Pacific Coast	89-90	10 060 9501
400	VFR400 R	87-93	10 060 9501	800	PC800 Pacific Coast	95-98	10 060 9501
400	XR400	96-04	10 060 9191	800	VFR800	98-01	10 060 9501
440	XR440 R-SM	96-04	10 060 9191	800	VFR800 Crossrunner	11-15	10 060 9351
450	CB450 DXK	85-92	10 060 9321	800	VFR800-V TEC-(Abs)	02-11	10 060 9351
450	CM450 Custom	82-83	10 060 9321	800	VT800 Shadow	88	10 060 9241
450	CRF450 R	02-15	10 060 9521	900	CB900 F	79-84	10 060 9531
500	CB500	13-15	10 060 9351	900	CB900 F Hornet	02-07	10 060 9351
500	CB500	94-02	10 060 9501	900	CBR900 RR Fire Blade	92-99	10 060 9501
500	CB500 F Four	71-77	10 060 9531	900	CBR900 RR Fire Blade	00-03	10 060 9351
500	CB500 Twin	75-77	10 060 9321	1000	CB1000 C Custom	83	10 060 9531
500	CBF500	04-08	10 060 9501	1000	CB1000 FP,FR,FS,FT,FV BIG 1	93-97	10 060 9501
500	CBR500	13-15	10 060 9351	1000	CB1000 R/RA-8,9,A,B,C,D,E,F	08-15	10 060 9351
500	CX 500	78-84	10 060 9321	1000	CBF1000	06-15	10 060 9351
500	GB500 TT, K Clubman	89-90	10 060 9191	1000	CBR1000 F Hurricane	87-99	10 060 9501
500	GL500 I Interstate	81-82	10 060 9321	1000	CBR1000 RR Fireblade (C-Abs)	04-15	10 060 9351
500	GL500 Silver Wing	81-82	10 060 9321	1000	CBX1000	78-82	10 060 9531
500	VF500	84-87	10 060 9241	1000	GL1000 Gold Wing	75-80	10 060 9531
500	VT500 Shadow	83-88	10 060 9241	1000	VF1000 F-R-RF-Interceptor	84-86	10 060 9241
500	XBR500	85-88	10 060 9191	1000	VTR1000 F Fire Storm	03-05	10 060 9351
500	XR500	81-85	10 060 9191	1000	VTR1000 F Fire Storm	97-02	10 060 9501
550	CB550	74-83	10 060 9531	1000	VTR1000 SP-1	00	10 060 9501
550	CBX550	81-86	10 060 9321	1000	VTR1000 SP-1/ SP-2	01-06	10 060 9351
600	CB600 Hornet	03-13	10 060 9351	1000	XL1000 V Varadero-Abs	03-13	10 060 9351
600	CB600 Hornet	98-02	10 060 9501	1000	XL1000 V-X,Y,1,2 Varadero	99-02	10 060 9501
600	CBF600	04-12	10 060 9351	1050	CBX1050	79-80	10 060 9531
600	CBR600 F	11-13	10 060 9351	1100	CB1100	81-83	10 060 9531
600	CBR600 F	01-07	10 060 9351	1100	CB1100 D,E	13-14	10 060 9351
600	CBR600 F	87-00	10 060 9501	1100	CB1100 X-Eleven	00-03	10 060 9501
600	CBR600 RR	03-15	10 060 9351	1100	CBR1100 XX BlackBird	97-06	10 060 9501
600	FSC600 Silver Wing	01-13	10 060 9351	1100	GL1100 Gold Wing	80-85	10 060 9531
600	NTV600	88-92	10 060 9501	1100	ST1100 Pan European-Abs	90-02	10 060 9501
600	VT600 Shadow	88-07	10 060 9501	1100	ST1100-Abs	90-98	10 060 9501

CC	MODELLO - MODEL	ANNO YEAR	NYP SO	CC	MODELLO - MODEL	ANNO YEAR	NYP SO
1100	VF1100 C-S	82-86	10 060 9241	510	TC510	05-07	10 060 9221
1100	VT1100 Shadow	87-88	10 060 9241	510	TC510	08-10	10 060 9801
1100	VT1100 Shadow	89-07	10 060 9501	510	TCX510	08-11	10 060 9801
1200	GL1200 Gold Wing	84-90	10 060 9531	510	TE510	04-07	10 060 9221
1200	VFR1200 F V4-DCT	10-15	10 060 9351	510	TE510	08-10	10 060 9801
1200	VFR1200 X Crosstourer-DCT	12-15	10 060 9351	510	TXC510	08-09	10 060 9801
1300	CB1300 (Abs)	03-13	10 060 9351	511	SMR511	11-12	10 060 9781
1300	CTX1300	14-15	10 060 9351	511	TE511	11-14	10 060 9781
1300	ST1300 Pan European-Abs	02-15	10 060 9351	530	SM530 RR	09	10 060 9801
1300	VT1300	10-15	10 060 9351	610	SM610	98-99	10 060 9221
1300	VTX1300	03-09	10 060 9351	610	SM610 S	00-01	10 060 9221
1500	GL1500 Gold Wing	88-03	10 060 9501	610	SM610 S ie	06-08	10 060 9221
1800	GL1800 Gold Wing	01-15	10 060 9351	610	TE610 E Enduro	98-01	10 060 9221
1800	NRX1800 Valkyrie Rune	04-05	10 060 9351	610	TE610 E LT	00	10 060 9221
1800	VTX1800	02-08	10 060 9351	610	TE610 ie	06-08	10 060 9221
HUSABERG				630	SM630 IE	10	10 060 9801
250	FE250	13	10 060 9601	630	SMR630	11	10 060 9801
250	FE250	14	10 060 9591	630	SMS630	11	10 060 9801
350	FE350	13	10 060 9591	630	TE630	11	10 060 9801
390	FE390 Enduro	10-12	10 060 9601	630	TE630 IE	10	10 060 9801
450	FC450	04-06	10 060 9211	900	900 Nuda-R	11-14	10 060 9691
450	FE450 Enduro	04-14	10 060 9601	HYO-SUNG			
450	FS450	04-08	10 060 9211	125-250 (Tutti - All Models)		97-11	10 060 9061
450	FX450 Cross Country	10-11	10 060 9601	ITALJET			
501	FE501	13-14	10 060 9601	125	125 Dragster	06	10 060 9041
550	FC550	04-06	10 060 9211	125	125 Torpedo	98-99	10 060 9031
550	FE550	04-08	10 060 9211	125	125 Torpedo (Leader)	00-03	10 060 9041
550	FS550	04-08	10 060 9211	125	125/150 Jet Set	01-03	10 060 9041
570	FE570 Enduro	09-12	10 060 9601	150	150 Torpedo (Leader)	00-03	10 060 9041
650	FE650	04-08	10 060 9211	250	250 Dragster	06	10 060 9041
650	FS650	04-08	10 060 9211	KAWASAKI			
700	FS570 Supermoto	10-11	10 060 9601	110	KLX110	02-15	10 060 9191
HUSQVARNA				110	KSR110	03-08	10 060 9191
250	FC250	14-15	10 060 9591	125	BN125 Eliminator	98-09	10 060 9191
250	FE250	14-15	10 060 9591	125	KH125	03-06	10 060 9050
250	SM250 R	07	10 060 9221	125	KLX125	03-06	10 060 9050
250	TC250	08	10 060 9801	125	KLX125-D-Tracker	10-14	10 060 9191
250	TC250	09-15	10 060 9521	140	KLX140	08-15	10 060 9191
250	TC250	02-07	10 060 9221	200	Z200 A1-A6	77-83	10 060 9410
250	TC250 R	13	10 060 9521	250	BJ250 A2,A3,C2 Estrella 250	94-00	10 060 9410
250	TE250	10-14	10 060 9521	250	EL250	88-03	10 060 9531
250	TE250	02-07	10 060 9221	250	EX250R Ninja	08-15	10 060 9531
250	TE250	08-09	10 060 9801	250	GPX250R Ninja	88-05	10 060 9531
250	TE250 Meo Replica	11	10 060 9521	250	GPZ250R Ninja	86-87	10 060 9531
250	TE250 R	13	10 060 9521	250	KL250 (KLR250)	77-05	10 060 9410
250	TXC250	10-14	10 060 9521	250	KL250 Super Sherpa	09	10 060 9191
250	TXC250	08-09	10 060 9801	250	KL250 Super Sherpa	00-03	10 060 9191
250	TXC250 R	13	10 060 9521	250	KLX250	06-07	10 060 9191
310	TE310	11-14	10 060 9521	250	KLX250	90-97	10 060 9191
310	TE310	09-10	10 060 9801	250	KX250 F	04-15	10 060 9571
310	TE310 R	13	10 060 9521	250	KZ250	83	10 060 9410
310	TXC310 R	11-14	10 060 9521	250	KZ250	80-81	10 060 9410
350	FC350	15	10 060 9591	250	Z250 C1,C2,G1,G2,LTD	81-83	10 060 9410
350	FE350	14-15	10 060 9591	250	ZZR250	90-93	10 060 9531
410	TE410 E	98-01	10 060 9221	250	ZZR250	98-02	10 060 9531
449	SMR449	11-12	10 060 9781	300	J300	14-15	10 060 9480
449	TC449	11-14	10 060 9781	300	J300 SE	14-15	10 060 9480
449	TE449	11-14	10 060 9781	300	KLX300	96-07	10 060 9191
450	FE450	14-15	10 060 9601	300	Ninja 300	13-15	10 060 9501
450	SM450 R	04-07	10 060 9221	400	KLX400	03	10 060 9621
450	SM450 R-RR	08-10	10 060 9801	400	Z400	74-83	10 060 9531
450	TC450	02-07	10 060 9221	400	ZR400 (Z400F)	83-85	10 060 9531
450	TC450	08-10	10 060 9801	400	ZX400	84-87	10 060 9531
450	TE450	02-07	10 060 9221	400	ZX400 (ZX-4)	88-02	10 060 9501
450	TE450	08-10	10 060 9801	440	KZ440	80-83	10 060 9531
450	TXC450	08-11	10 060 9801	440	Z440	80-85	10 060 9531
501	FE501	14-15	10 060 9601	450	EN450 A1-A6 (454 LTD)	85-90	10 060 9241
510	SM510 R	05-07	10 060 9221	450	KLX450 R	08-14	10 060 9191
510	SM510 R	08-10	10 060 9801	450	KX450 F	06-15	10 060 9191

CC	MODELLO - MODEL	ANNO YEAR	NYP SO	CC	MODELLO - MODEL	ANNO YEAR	NYP SO
500	EN500	03-06	10 060 9351	900	ZL900 Eliminator	85-86	10 060 9531
500	EN500	07-09	10 060 9501	900	ZX900 (GPZ900R) Ninja	84-96	10 060 9531
500	EN500	90-02	10 060 9501	900	ZX900 (ZX-9R)	94-01	10 060 9501
500	ER-5	99	10 060 9501	900	ZX900 F1,F2 Ninja (ZX-9R)	02-03	10 060 9351
500	ER500	96-06	10 060 9501	1000	KLV1000	04-06	10 060 9511
500	EX500 Ninja 500R	04-06	10 060 9351	1000	KLZ1000 Versys	12-15	10 060 9501
500	EX500 Ninja 500R	07-09	10 060 9501	1000	Z1000	81-83	10 060 9531
500	GPZ500 S	03	10 060 9351	1000	Z1000 A1,A2,A3,A6F (ZR1000)	03-06	10 060 9351
500	GPZ500 S	87-89	10 060 9241	1000	Z1000 B7F,B8F (ZR1000)	07-15	10 060 9501
500	GPZ500 S	90-02	10 060 9501	1000	ZG1000 (GTR1000)	86-06	10 060 9531
500	KLE500	03-05	10 060 9351	1000	ZL1000 Eliminator	87-88	10 060 9531
500	KLE500	06-07	10 060 9501	1000	ZX1000 (GPZ1000RX)	86-89	10 060 9531
500	KLE500	91-02	10 060 9501	1000	ZX1000 (ZX10 Ninja)	88-90	10 060 9531
500	Z500	79-81	10 060 9531	1000	ZX1000 Ninja 1000	11-15	10 060 9501
500	ZZR500	90-96	10 060 9501	1000	ZX-10R Ninja	06-15	10 060 9501
550	KZ550	80-84	10 060 9531	1000	ZX-10R Ninja	04-05	10 060 9351
550	Z550	79-01	10 060 9531	1100	KZ1100	81-05	10 060 9531
550	ZR550 (Z550F)	80-83	10 060 9531	1100	Z1100	81-86	10 060 9531
550	ZR550 Zephyr	91-00	10 060 9531	1100	ZN1100	84-85	10 060 9531
550	ZX550 (GPZ550)	82-92	10 060 9531	1100	ZR1100 Zephyr	91-00	10 060 9531
600	KL600 A1,B1-B4 (KLR600)	84-90	10 060 9410	1100	ZX1100 (GPZ1100)	81-85	10 060 9531
600	ZL600	86-87	10 060 9531	1100	ZX1100 (GPZ1100)	95-97	10 060 9531
600	ZL600 Eliminator	95-98	10 060 9531	1100	ZX1100 (ZZ-R1100)	90-01	10 060 9531
600	ZX600 (GPX600R)	88-00	10 060 9531	1200	ZG1200 Voyager XIII	89-03	10 060 9531
600	ZX600 (GPZ600R)	85-89	10 060 9531	1200	ZRX1200	01-06	10 060 9531
600	ZX600 (ZX6-R Ninja)	07-13	10 060 9501	1200	ZRX1200 Daeg	09	10 060 9531
600	ZX600 (ZX6-R Ninja)	02-06	10 060 9351	1200	ZX-12R Ninja	00-05	10 060 9351
600	ZX600 (ZX6-R Ninja)	95-01	10 060 9501	1200	ZZ-R1200 (ZX1200)	02-05	10 060 9531
600	ZX600 (ZZR600)	02-04	10 060 9351	1400	ZG1400 (GTR1400)	08-15	10 060 9501
600	ZX600 (ZZR600)	90-01	10 060 9501	1400	ZX-14 Ninja (ZX1400)	06-15	10 060 9501
636	ZX636 (ZX6-R Ninja 636)-Abs	13-15	10 060 9501	1400	ZZR1400 (ZX1400)	06-13	10 060 9501
636	ZX636 (ZX6-R Ninja 636)	02-06	10 060 9351	1500	VN1500	87-98	10 060 9501
650	EN650	15	10 060 9501	1500	VN1500	99-06	10 060 9351
650	ER-6f	06	10 060 9351	1500	VN1500 L1 Nomad	00	10 060 9501
650	ER-6f A7F,A8F,B7F,B8F (EX650)	07-14	10 060 9501	1500	VN1500 L1H Classic Tourer	98-00	10 060 9501
650	ER-6n	07-14	10 060 9501	1500	VN1500 N7F,N8F Classic	07-08	10 060 9501
650	ER-6n A6F,B6F (ER650)	06	10 060 9351	1600	VN1600	03-06	10 060 9351
650	EX650 Ninja 650R	06-15	10 060 9501	1600	VN1600	07-08	10 060 9501
650	KL650 (KLR650)	87-15	10 060 9410	1700	VN1700	09-15	10 060 9501
650	KL650 (KLR650)	95-03	10 060 9410	2000	VN2000 Vulcan	04-07	10 060 9351
650	KL650 Tengai (KLR650)	89-92	10 060 9410	2000	VN2000 Vulcan	08-10	10 060 9501
650	KLE650 Versys	08-14	10 060 9501	KTM			
650	KLX650 (KLX650 R)	93-96	10 060 9410	125	125 Duke	11-15	10 060 9211
650	KLX650 C1-C5	93-97	10 060 9410	125	125 RC	14-15	10 060 9211
650	KLX650 R	93-01	10 060 9410	200	200 Duke	12-16	10 060 9211
650	KR650	93	10 060 9531	200	200 RC	14-16	10 060 9211
650	KZ650	78-80	10 060 9531	250	250 EXC Racing (1°filtro -1st filter)	03-06	10 060 9211
650	W650	99-05	10 060 9351	250	250 EXC Racing (2°filtro - 2nd filter)	03-06	10 060 9541
650	Z650	77-83	10 060 9531	250	250 EXC-F	07-12	10 060 9601
750	KZ750	80-84	10 060 9531	250	250 EXC-F	13-15	10 060 9591
750	VN750 Vulcan	04-06	10 060 9351	250	250 EXC-F Six Days	13-15	10 060 9591
750	VN750 Vulcan	84-98	10 060 9241	250	250 Freeride R	15	10 060 9591
750	VN750 Vulcan	99-03	10 060 9501	250	250 SX-F	05-12	10 060 9601
750	Z750	04-06	10 060 9351	250	250 SX-F	13-15	10 060 9591
750	Z750	07-12	10 060 9501	250	250 XC-F-XCF-W	07-12	10 060 9601
750	Z750 (GPZ750)	80-96	10 060 9531	250	250 XC-F-XCF-W	13-14	10 060 9591
750	ZR750 Zephyr ZR-7	91-03	10 060 9531	300	300 EXC-F	15	10 060 9591
750	ZX750 (GPX750R)	86-88	10 060 9531	350	350 EXC-F	12-15	10 060 9591
750	ZX750 (GPZ750)-Turbo	83-89	10 060 9531	350	350 Freeride	12-15	10 060 9591
750	ZX750 (ZX-7R)	96-03	10 060 9501	350	350 SX-F	11-15	10 060 9591
750	ZX750 (ZXR750)	91-95	10 060 9501	350	350 XC-F	12-15	10 060 9591
750	ZX750 H1 (ZXR750)	89-	10 060 9501	390	390 Duke	13-16	10 060 9211
750	ZX750 H2 (ZXR750)	90	10 060 9531	390	390 RC	14-16	10 060 9211
800	VN800 Vulcan	02-06	10 060 9351	400	400 EGS (1°filtro -1st filter)		10 060 9211
800	VN800 Vulcan	95-02	10 060 9501	400	400 EGS (2°filtro - 2nd filter)		10 060 9661
800	W800	11-15	10 060 9501	400	400 EXC	08-11	10 060 9591
800	Z800	13-15	10 060 9501	400	400 EXC (1°filtro -1st filter)	06-07	10 060 9211
900	VN900 Vulcan	06-15	10 060 9501	400	400 EXC (2°filtro - 2nd filter)	06-07	10 060 9541
900	Z900	76	10 060 9531				

CC	MODELLO - MODEL	ANNO YEAR	NYP SO	CC	MODELLO - MODEL	ANNO YEAR	NYP SO
400	400 EXE-EXE Super Competition (1°filtro -1st filter)		10 060 9211	690	690 Duke-R (2°filtro - 2nd filter)	12-13	10 060 9211
400	400 SX-MXC-EXC (1°filtro -1st filter)	04-05	10 060 9211	690	690 Duke-R (2°filtro - 2nd filter)	08-11	10 060 9541
400	400 SX-MXC-EXC (2°filtro - 2nd filter)	04-05	10 060 9541	690	690 Enduro-R (1°filtro -1st filter)	08-11	10 060 9211
400	400 XC-W	08-10	10 060 9591	690	690 Enduro-R (2°filtro - 2nd filter)	12-13	10 060 9211
400	400 XC-W (1°filtro -1st filter)	07	10 060 9211	690	690 Enduro-R (2°filtro - 2nd filter)	08-11	10 060 9541
400	400 XC-W (2°filtro - 2nd filter)	07	10 060 9541	690	690 Rally Factory Replica (2°filtro - 2nd filter)	07-08	10 060 9601
400	400/600 All Rotax		10 060 9201	690	690 Rally Factory Replica (2°filtro - 2nd filter)	09-10	10 060 9211
450	450 EXC	12-15	10 060 9601	690	690 SMC (1°filtro -1st filter)	08-11	10 060 9211
450	450 EXC	09-11	10 060 9591	690	690 SMC (2°filtro - 2nd filter)	08-11	10 060 9541
450	450 EXC (1°filtro -1st filter)	07	10 060 9211	690	690 SMC R (2°filtro - 2nd filter)	12-13	10 060 9211
450	450 EXC (2°filtro - 2nd filter)	07	10 060 9541	690	690 Supermoto R (1°filtro -1st filter)	07	10 060 9601
450	450 EXC-R	08	10 060 9591	690	690 Supermoto R (1°filtro -1st filter)	08-09	10 060 9211
450	450 SMR	08-12	10 060 9591	690	690 Supermoto R (2°filtro - 2nd filter)	07-09	10 060 9541
450	450 SMR	13-14	10 060 9601	950	950 LC8 (Tutti - All Models)	03-11	10 060 9671
450	450 SMR (1°filtro -1st filter)	05-07	10 060 9211	990	990 LC8 (Tutti - All Models)	05-13	10 060 9671
450	450 SMR (2°filtro - 2nd filter)	05-07	10 060 9541	1050	1050 Adventure	15-15	10 060 9671
450	450 SX-EXC-MXC (1°filtro -1st filter)	03-08	10 060 9211	1190	1190 Adventure-R	13-15	10 060 9671
450	450 SX-EXC-MXC (2°filtro - 2nd filter)	03-08	10 060 9541	1190	1190 RC8-R-R Track	09-15	10 060 9671
450	450 SX-F	07-12	10 060 9591	1290	1290 Super Adventure	14-14	10 060 9671
450	450 SX-F	13-15	10 060 9601	1290	1290 Super Duke R	14-14	10 060 9671
450	450 XC-F	13-15	10 060 9601		KYMCO		
450	450 XC-F-XC-WR	08-10	10 060 9591	125	125 Dink ie Eu3	06-13	10 060 9370
450	450 XC-W	12-15	10 060 9601	125	125 Dintown ie	09-13	10 060 9480
450	450 XC-W	10-11	10 060 9591	125	125 Grand Dink Eu2	01-11	10 060 9370
500	500 EXC	12-15	10 060 9601	125	125 Grand Dink S Eu3	08-11	10 060 9370
500	500 XC-W	12-15	10 060 9601	125	125 K-XCT ie	12-13	10 060 9480
505	505 SX-F	08-09	10 060 9591	125	125 Super Dink ie	09	10 060 9480
505	505 XC-F	08-09	10 060 9591	125	125 Venox		10 060 9370
520	520 SX-MXC-EXC (1°filtro -1st filter)	99-02	10 060 9211	125	125i G-Dink ie	12-13	10 060 9370
520	520 SX-MXC-EXC (2°filtro - 2nd filter)	99-02	10 060 9541	125	125i People GT ie	10-13	10 060 9480
525	525 SMR (1°filtro -1st filter)	04-06	10 060 9211	150	150 Grand Dink Eu2	01-11	10 060 9370
525	525 SMR (2°filtro - 2nd filter)	04-06	10 060 9541	150	150 People GT ie	10-11	10 060 9480
525	525 SX-MXC-EXC-XC-XC-W (1°filtro -1st filter)	03-07	10 060 9211	200	200 Dink ie Eu3	06-13	10 060 9370
525	525 SX-MXC-EXC-XC-XC-W (2°filtro - 2nd filter)	03-07	10 060 9541	200	200i Dintown ie Abs	10-13	10 060 9480
530	530 EXC	08-11	10 060 9591	200	200i People Gt	10-13	10 060 9480
530	530 XC	08-10	10 060 9591	200	200i Yager GT	10	10 060 9370
540	540 SXS (1°filtro -1st filter)		10 060 9211	300	300i Dintown ie	09-13	10 060 9480
540	540 SXS (2°filtro - 2nd filter)		10 060 9541	300	300i Dintown ie Abs	09-13	10 060 9480
560	560 SMR (1°filtro -1st filter)	07	10 060 9211	300	300i K-XCT ie	12-13	10 060 9480
560	560 SMR (2°filtro - 2nd filter)	07	10 060 9541	300	300i People GT ie	10-13	10 060 9480
620	620 Duke (1°filtro -1st filter)		10 060 9211	400	400 Xciting i	12-14	10 060 9880
620	620 Duke (2°filtro - 2nd filter)		10 060 9661	500	500 Xciting	05-09	10 060 9081
620	620 EGS (1°filtro -1st filter)		10 060 9211	500	500 Xciting RI	10-13	10 060 9081
620	620 EGS (2°filtro - 2nd filter)		10 060 9661	700	700i MyRoad	11-13	10 060 9081
620	620 EXE (1°filtro -1st filter)		10 060 9211		LIGIER		
620	620 LSK (1°filtro -1st filter)		10 060 9211	500	Tutte (Motore Lombardini LDW502)	UFI	10 060 9140
620	620 LSK (2°filtro - 2nd filter)		10 060 9661	500	Tutte (Motore Lombardini LDW523)	UFI	10 060 9140
625	625 SMC (1°filtro -1st filter)	04-05	10 060 9211		LML		
625	625 SMC (2°filtro - 2nd filter)	04-05	10 060 9661	125	125/150 Star 4T	09-13	10 060 9470
625	625 SXC (1°filtro -1st filter)	03-05	10 060 9211		MALAGUTI		
625	625 SXC (2°filtro - 2nd filter)	05	10 060 9661	125	125 Madison 3 (Piaggio)	06-11	10 060 9041
625	625 SXC (2°filtro - 2nd filter)	03-04	10 060 9541	180	180 R Madison	01-02	10 060 9041
640	640 Duke (1°filtro -1st filter)	99-06	10 060 9211	200	200 F12 Phantom Max	04-05	10 060 9041
640	640 Duke (2°filtro - 2nd filter)	99-06	10 060 9661	200	200 S Madison-Rst	02-03	10 060 9041
640	640 LC4 (1°filtro -1st filter)		10 060 9211	250	250 F12 Phantom Max	04-05	10 060 9041
640	640 LC4 (2°filtro - 2nd filter)		10 060 9661	250	250 Madison S-RS-Rst3-3 IE	04-11	10 060 9041
660	660 Rally E Factory Replica	06-07	10 060 9211	500	500 Spider Max-GT-RS	04-11	10 060 9071
660	660 Rally E Factory Replica (1°filtro -1st filter)	06-07	10 060 9661		MBK		
660	660 Rally E Factory Replica (2°filtro - 2nd filter)	06-07	10 060 9541	125	125 Citycruiser	07-11	10 060 9380
660	660 SMC (1°filtro -1st filter)	04-05	10 060 9211	125	125 Cityliner	07-13	10 060 9380
660	660 SMC (2°filtro - 2nd filter)	04-05	10 060 9541	125	125 Skycruiser	06-13	10 060 9380
660	660 Supermoto (1°filtro -1st filter)	02-03	10 060 9211		MICRO-CAR		
660	660 Supermoto (2°filtro - 2nd filter)	02-03	10 060 9541	505	Tutte (Motore Lombardini LDW502)		
690	690 Duke-R (1°filtro -1st filter)	08-13	10 060 9211		MOTO GUZZI		
				125	125 2C 4T	79-81	10 060 9121
				250	250 Quattro-254-Sport-304 4T		10 060 9121

CC	MODELLO - MODEL	ANNO YEAR	NYP SO	CC	MODELLO - MODEL	ANNO YEAR	NYP SO
350	350 Falco	UFI 01/91->	10 060 9180	125	Beverly	01-13	10 060 9041
350	350 Nevada/Nevada Club	UFI 05/88->	10 060 9180	125	Carnaby	07-12	10 060 9041
350	350 NTX	UFI 05/88->	10 060 9180	125	Fly	05-13	10 060 9041
350	V35 tutti	UFI ->04/88	10 060 9420	125	GTX Super Hexagon	01-03	10 060 9041
350	V35 tutti	UFI 05/88->	10 060 9180	125	Liberty	00-14	10 060 9041
500	V50 tutti	UFI ->04/88	10 060 9420	125	Liberty	97-00	10 060 9031
500	V50 tutti	UFI 05/88->	10 060 9180	125	LX-4 Hexagon	98-99	10 060 9031
650	V650 tutti	UFI ->04/88	10 060 9420	125	MP3	07-14	10 060 9041
650	V650 tutti	UFI 05/88->	10 060 9180	125	Sfera FL 4T	95-97	10 060 9031
750	750 NTX	UFI	10 060 9180	125	Skipper ST	00-05	10 060 9041
750	750 S3	75	10 060 9121	125	Typhoon 4T	10-12	10 060 9041
750	750 SP	UFI	10 060 9180	125	Vespa ET4	96-99	10 060 9031
750	750 Strada	UFI	10 060 9180	125	Vespa ET4-GT-GTS-GTV-LX-LXV-S	00-14	10 060 9041
750	750 Targa	UFI	10 060 9180	125	X10	12-13	10 060 9041
750	Breva V750 IE 35KW	UFI 01/03->	10 060 9180	125	X7	08-12	10 060 9041
750	Nevada 750	UFI 91-03	10 060 9180	125	X8 Premium-Street	05-07	10 060 9041
750	Nevada 750 Club	UFI 98-03	10 060 9180	125	X9	01-07	10 060 9041
750	Nevada 750 IE 35KW	UFI 04->	10 060 9180	125	X-Evo	07-08	10 060 9041
750	Nevada Classic 750 IE 35KW	UFI 04->	10 060 9180	125	Zip	02-06	10 060 9041
750	Nevada Touring 750 IE 35KW	UFI 04->	10 060 9180	150	Fly-LEM-DT	05-13	10 060 9041
750	V75	UFI	10 060 9180	150	Liberty	99-14	10 060 9041
750	V75 Polizia (750)	UFI	10 060 9180	150	Skipper ST	00-05	10 060 9041
850	850 Breva-Norge-Griso	06-11	10 060 9151	150	Vespa ET4-LX-LXV-S	00-14	10 060 9041
850	850 Le Mans I,II,III-T3-California	75-83	10 060 9121	150	X8	06-08	10 060 9041
850	850 T3,T4,T5	75-88	10 060 9121	180	GTX Super Hexagon	01	10 060 9041
850	850 T5	89-05	10 060 9151	180	X9 Amalfi	01-03	10 060 9041
940	940 Bellagio	07-12	10 060 9151	200	Beverly GT-Rst	01-03	10 060 9041
1000	1000 California II-III	82-93	10 060 9121	200	Carnaby	07-10	10 060 9041
1000	1000 Daytona	92-93	10 060 9121	200	Liberty Rst-Sport	04-09	10 060 9041
1000	1000 Daytona-RS	94-01	10 060 9151	200	Vespa GT	04-09	10 060 9041
1000	1000 Le Mans V-IV	84-92	10 060 9121	200	X8	05-06	10 060 9041
1000	1000 Mille GT	87-94	10 060 9121	200	X9	02-03	10 060 9041
1000	1000 Quota	89-93	10 060 9121	200	X9 Evolution	03-04	10 060 9041
1000	1000 Quota ie	94-97	10 060 9151	250	Beverly	04-09	10 060 9041
1000	1000 S	90-93	10 060 9121	250	Carnaby	08-09	10 060 9041
1000	1000 SP-SP2-SP3	78-96	10 060 9121	250	MP3	06-10	10 060 9041
1000	1000 V10 Centauro	97-01	10 060 9151	250	Vespa GT-GTS-GTV	05-11	10 060 9041
1000	1000 V1000 G5	78-85	10 060 9121	250	X7	08-09	10 060 9041
1000	1000 V1000 I Convert	75-84	10 060 9121	250	X8	05-08	10 060 9041
1000	MGS-01 Corsa	05-11	10 060 9151	250	X9	00-07	10 060 9041
1100	1100 V11-Corsa-Stone-Sport-Quota-Griso	94-09	10 060 9151	250	X-Evo	07-08	10 060 9041
1100	1100 California	94-13	10 060 9151	300	Beverly Rst 4T-4V i.e.	09-13	10 060 9041
1200	1200 Breva-Griso 8V-Norge-Sport-Stelvio	06-14	10 060 9151	300	Carnaby Cruiser i.e.	09-13	10 060 9041
MUZ				300	MP3	10-14	10 060 9041
125	125 RT	00-08	10 060 9201	300	Vespa GTS-GTV	08-14	10 060 9041
125	125 SM	00-08	10 060 9201	300	X7	09-12	10 060 9041
125	125 SX	00-08	10 060 9201	350	Beverly	11-14	10 060 9801
500	500 (Tutti - All Models)	91-98	10 060 9201	350	X10	12-14	10 060 9041
660	660 (Tutti - All Models)	94-00	10 060 9290	400	Beverly	06-09	10 060 9071
MV AGUSTA				400	MP3	07-12	10 060 9071
750	F4 S 750 1+1 EVO 3	03	10 060 9791	400	X8	06-08	10 060 9071
910	910 Brutale R-S	05-08	10 060 9791	400	X-Evo	07-12	10 060 9071
1000	Brutale 1000	01-05	10 060 9791	420	Ape Car Diesel	UFI	10 060 9010
1000	F4 1000 (Tutti - All Models)	00-07	10 060 9791	420	Ape Max Diesel	UFI 86-96	10 060 9010
1078	Brutale 1078RR	09	10 060 9351	420	Ape Poker	UFI 93->	10 060 9010
1078	F4 R 312	08-09	10 060 9351	420	Ape Poker Diesel	UFI	10 060 9010
PEUGEOT				420	Ape TM D LCS (Motore Lombardini)	UFI	10 060 9010
125	125 (Tutti - All Models)	99-14	10 060 9021	420	Ape TM P703 Diesel (421)	UFI	10 060 9010
150	Elyseo	01-03	10 060 9021	420	Ape TM P703/V Diesel	UFI 87-01	10 060 9010
150	Elystar	03-10	10 060 9021	500	Beverly	03-13	10 060 9071
150	Looxor	03-04	10 060 9041	500	MP3	11-14	10 060 9071
250	(Tutti - All Models)	07-12	10 060 9041	500	X10	12-14	10 060 9071
300	(Tutti - All Models)	11-13	10 060 9041	500	X9	02-10	10 060 9071
400	(Tutti - All Models)	07-13	10 060 9071	500	AL 500 Diesel (Lombardini LDW502)	UFI	10 060 9140
500	(Tutti - All Models)	07-13	10 060 9071	500	PK 500 Diesel (Lombardini LDW502)	UFI	10 060 9140
PIAGGIO				700	Quargo Diesel (Lombardini LDW702)	UFI	10 060 9140
125	B125 City Slicker	02	10 060 9041	SACHS			
				125	125 Roadster	98-01	10 060 9290

CC	MODELLO - MODEL	ANNO YEAR	NYP SO	CC	MODELLO - MODEL	ANNO YEAR	NYP SO
SHERCO				450	RM-Z450	05-15	10 060 9571
250	SE 2.5i F	08-13	10 060 9781	500	DR500	81-84	10 060 9651
250	SX 2.5i F	10	10 060 9781	500	GS500	88-10	10 060 9271
300	SE 3.0i F	10-13	10 060 9781	500	SP500	81-83	10 060 9651
450	SE 4.5i F	04-13	10 060 9781	550	GS550	77-86	10 060 9271
450	SM 4.5i F	04-10	10 060 9781	550	GSX550	83-87	10 060 9271
510	SE 5.1i F	04-13	10 060 9781	600	DR600	85-91	10 060 9651
510	SM 5.1i F	04-10	10 060 9781	600	GSF600 Bandit	95-04	10 060 9511
SUZUKI				600	GSR600-Yoshimura	06-10	10 060 9511
100	DR100	83-90	10 060 9061	600	GSX600	88-06	10 060 9511
100	SP100	83	10 060 9061	600	GSX-R600	92-93	10 060 9511
110	DR-Z110	03-05	10 060 9191	600	GSX-R600	97-15	10 060 9511
125	AN125	96-00	10 060 9061	600	RF600	93-97	10 060 9511
125	CS125 Roadie	83-87	10 060 9061	600	SP600 F	85	10 060 9651
125	DR125	80-85	10 060 9061	600	VS600	95-98	10 060 9511
125	DR125	85-00	10 060 9050	650	AN650 Burgman	02-14	10 060 9511
125	DR125 SM	07-09	10 060 9061	650	DL650 V-Strom	04-15	10 060 9511
125	DR-Z125-L	03-14	10 060 9050	650	DR650	90-14	10 060 9651
125	FL125 Address	07-10	10 060 9571	650	DS650	92-93	10 060 9651
125	GN125	82-83	10 060 9061	650	GR650	83-85	10 060 9271
125	GN125	91-00	10 060 9061	650	GS650	81-84	10 060 9271
125	GS125	79-00	10 060 9061	650	GSF650 Bandit	05-14	10 060 9511
125	GZ125 Marauder	99-10	10 060 9061	650	GSX650	08-15	10 060 9511
125	RV125 Van Van	03-14	10 060 9050	650	LS650 Savage (Belt)	86-09	10 060 9651
125	SP125	82-83	10 060 9061	650	S40 Boulevard (LS650)	05-15	10 060 9651
125	SP125	86-88	10 060 9050	650	SFV650 Gladius (Abs)	09-15	10 060 9511
125	TU125 XT	99	10 060 9061	650	SV650-S	99-10	10 060 9511
125	UC125 Epicuro	99-03	10 060 9061	650	XF650 Freewind	97-02	10 060 9651
125	UE125	01	10 060 9061	650	XN85 Turbo (650cc)	83-86	10 060 9271
125	UH125 Burgman	02-14	10 060 9061	700	GS700 EF,ESF	85	10 060 9271
125	UX125 Sixteen	08-14	10 060 9061	750	DR750 Big	88-89	10 060 9651
125	VL125 Intruder LC	00-06	10 060 9450	750	GS750	77-83	10 060 9271
150	AN150	95-00	10 060 9061	750	GSR750 (Abs)	11-14	10 060 9511
150	UC150 Epicuro	99-03	10 060 9061	750	GSX750	79-89	10 060 9271
150	UE150	01	10 060 9061	750	GSX750	89-06	10 060 9511
150	UX150 Sixteen	08-14	10 060 9061	750	GSX-R750	92-15	10 060 9511
200	DR200	96-15	10 060 9050	750	GSX-R750 Sling Shot	88-89	10 060 9511
200	DR200	86-91	10 060 9050	750	GSX-S750	15	10 060 9511
200	UH200 Burgman	07-14	10 060 9061	750	VS750 Intruder	87-91	10 060 9511
250	AN250 Burgman	99-07	10 060 9050	800	C50 Boulevard	05-15	10 060 9511
250	DR250	82-99	10 060 9450	800	C800 Intruder (VL800 Intruder)	05-15	10 060 9511
250	DR-Z250	01-07	10 060 9450	800	DR800	88-00	10 060 9651
250	GN250	82-00	10 060 9450	800	M50 Boulevard	05-15	10 060 9511
250	GS250 TT, TX	79-81	10 060 9271	800	M800 Intruder (VZ800 Marauder)	05-14	10 060 9511
250	GSX1250	10-13	10 060 9511	800	S50 Boulevard	05-09	10 060 9511
250	GSX250-Katana	80-84	10 060 9271	800	VL800 Intruder-Volusia	01-09	10 060 9511
250	GSX-R250 RCH,RH,CJ,CK	87-89	10 060 9271	800	VS800 Intruder	92-09	10 060 9511
250	GW250 Inazuma	12-14	10 060 9511	800	VX800	90-97	10 060 9511
250	GZ250 Marauder	99-10	10 060 9450	800	VZ800 Marauder	97-11	10 060 9511
250	RM-Z250	04-15	10 060 9571	850	GS850 GN,GT,GX	79-85	10 060 9271
250	SP250	82-85	10 060 9450	900	C90 Boulevard	05-15	10 060 9511
250	TU250 X	09-15	10 060 9450	900	RF900	94-00	10 060 9511
250	TU250 X	98-00	10 060 9450	1000	DL1000 V-Strom	02-15	10 060 9511
250	VL250 Intruder LC	00-04	10 060 9450	1000	GS1000	78-84	10 060 9271
300	GS300 LZ,LD,LF	82-85	10 060 9271	1000	GSX1000 Katana	82-84	10 060 9271
350	DR350	90-00	10 060 9450	1000	GSX-R1000	01-15	10 060 9511
400	AN400 Burgman	07-14	10 060 9061	1000	SV1000-S	03-07	10 060 9511
400	AN400 Burgman	99-06	10 060 9050	1000	TL1000 R-S	97-02	10 060 9511
400	DR400	80-83	10 060 9450	1100	GS1100	80-86	10 060 9271
400	DR-Z400	00-15	10 060 9621	1100	GSX1100	88-96	10 060 9511
400	GN400	80-82	10 060 9450	1100	GSX1100-Katana	80-87	10 060 9271
400	GS400 B,C,EC,EN	77-79	10 060 9271	1100	GSX-R1100	86-97	10 060 9511
400	GSF400 Bandit	90-95	10 060 9271	1150	GS1150	84-86	10 060 9271
400	GSX400	81-87	10 060 9271	1200	GSF1200 Bandit	96-06	10 060 9511
400	GSX400 (2 Cilindri)	80-85	10 060 9271	1200	GSX1200 Inazuma	99-00	10 060 9511
400	SP400	79-82	10 060 9450	1250	GSF1250 Bandit	07-14	10 060 9511
425	GS425 N,EL,EN	79-80	10 060 9271	1300	GSX1300 B-King	08-12	10 060 9511
450	GS450	80-88	10 060 9271	1300	GSX-R1300 R Hayabusa	99-15	10 060 9511
450	RMX450	10-13	10 060 9571	1365	S83 Boulevard	05-10	10 060 9511

CC	MODELLO - MODEL	ANNO YEAR	NYP SO	CC	MODELLO - MODEL	ANNO YEAR	NYP SO
1400	GSX1400	01-06	10 060 9511	955	955i Speed Triple	99-01	10 060 9751
1400	GV1400	87-88	10 060 9511	955	955i Speed Triple (VIN 141872 a 210444)	02-04	10 060 9751
1400	VS1400 Intruder	87-09	10 060 9511	1000	1000 Daytona	91-95	10 060 9531
1500	VL1500 LC Intruder	98-09	10 060 9511	1050	1050 Speed Triple (R)-Sprint GT-Tiger	06-14	10 060 9351
1500	VZ1500 Boulevard-Intruder	09-15	10 060 9511	1200	1200 Daytona	93-97	10 060 9531
1600	M95 Boulevard	05	10 060 9351	1200	1200 Tiger Explorer (xc)-Trophy	12-14	10 060 9351
1600	VZ1600 Marauder	04-05	10 060 9351	1200	1200 Trophy	91-03	10 060 9531
1800	M109R Boulevard	06-15	10 060 9511	1600	1600 Thunderbird	09-14	10 060 9351
1800	VLR1800 Intruder-Boulevard	08-13	10 060 9511	1700	1700 Thunderbird	10-14	10 060 9351
1800	VZR1800 Intruder	06-13	10 060 9511	2300	Rocket III	04-14	10 060 9351
SYM				YAMAHA			
400	400i Max	11-13	10 060 9050	125	VP125 X-City	07-13	10 060 9380
TM RACING				125	WR125 R-X	09-14	10 060 9380
250	250 4T	07-12	10 060 9380	125	XV125 S Virago	97-01	10 060 9290
450	450 4T	07-11	10 060 9380	125	XVS125 Drag Star	00-04	10 060 9290
530	530 4T	07-11	10 060 9380	125	YP125 X-Max	06-15	10 060 9380
660	660 4T	08-09	10 060 9380	125	YZF-R125	08-15	10 060 9380
TRIUMPH				180	XC180	83-85	10 060 9290
50	T509 Speed Triple	97-98	10 060 9751	200	XC200	90-91	10 060 9290
595	T595 Daytona	97-98	10 060 9751	250	SR250	79-96	10 060 9290
600	600 Daytona	03-04	10 060 9751	250	TT250	80-82	10 060 9290
600	600 Speed Four	03-04	10 060 9751	250	TT-R250	00-06	10 060 9380
600	600 Speed Four	05-06	10 060 9351	250	WR250 F-N,P	01-02	10 060 9380
600	600 TT	00-05	10 060 9751	250	XC250 ZCT	87	10 060 9290
650	650 Daytona	05	10 060 9351	250	XS250	78-82	10 060 9641
675	675 Daytona-R	06-15	10 060 9351	250	XT250	80-92	10 060 9290
675	675 Street Triple-R	08-15	10 060 9351	250	XV250	88-15	10 060 9290
750	750 Daytona	91-95	10 060 9531	250	XVS250 Drag Star	01-04	10 060 9290
750	750 Speed Triple	97	10 060 9531	250	YZ250 F-N,P	01-02	10 060 9380
750	750 Thunderbird	95	10 060 9531	300	YZF-R3	15	10 060 9351
750	750 Trident	91-98	10 060 9531	350	BW350 T	87	10 060 9290
800	800 America	02-04	10 060 9751	400	FZ400		10 060 9641
800	800 America	05-06	10 060 9351	400	FZR400 RR	90-94	10 060 9501
800	800 Bonneville	01-04	10 060 9751	400	SR400	14-15	10 060 9290
800	800 Bonneville T100	03-04	10 060 9751	400	WR400 F	99-01	10 060 9380
800	800 Bonneville-T100	05-06	10 060 9351	400	XJ400	82	10 060 9641
800	800 Speedmaster	05	10 060 9351	400	XJR400	92-98	10 060 9501
800	800 Speedmaster	03-04	10 060 9751	400	XS400	77-83	10 060 9641
800	800 Tiger-XC	11-14	10 060 9351	400	XT400	81-84	10 060 9290
865	865 America-LT	07-14	10 060 9351	400	YP400 Majesty	04-14	10 060 9050
865	865 Bonneville	07-14	10 060 9351	400	YP400 X-Max	13-15	10 060 9050
865	865 Scrambler	07-14	10 060 9351	400	YZ400 F-K,L	98-99	10 060 9380
865	865 Speedmaster	07-14	10 060 9351	426	WR426 F	01-02	10 060 9380
865	865 Thruxton	07-14	10 060 9351	426	YZ426 F	00-02	10 060 9380
900	900 Adventurer	95-01	10 060 9531	500	SR500	78-00	10 060 9290
900	900 Bonneville T100	06	10 060 9351	500	TMAX 500 (Abs)	01-11	10 060 9081
900	900 Daytona	94-97	10 060 9531	500	TT500	77-80	10 060 9290
900	900 Legend TT	99-01	10 060 9531	500	XT500	76-85	10 060 9290
900	900 Scrambler	06	10 060 9351	500	XV500 Virago	83	10 060 9290
900	900 Speed Triple	94-96	10 060 9531	530	TMAX 530 (Abs)	12-15	10 060 9081
900	900 Speedmaster	06	10 060 9351	535	XV535 Virago	82-02	10 060 9290
900	900 Sprint Sports	95-98	10 060 9531	550	XJ550	81-85	10 060 9641
900	900 Thruxton	04-06	10 060 9351	550	XZ550	82-83	10 060 9290
900	900 Thunderbird	95-03	10 060 9531	600	FJ600	84-85	10 060 9641
900	900 Thunderbolt	96	10 060 9531	600	FZ600	86-89	10 060 9641
900	900 Tiger	91-00	10 060 9531	600	FZ6-Fazer	04-06	10 060 9501
900	900 Trident	91-98	10 060 9531	600	FZ6-Fazer (Abs)	07-10	10 060 9351
900	900 Trophy	91-01	10 060 9531	600	FZR600	89-90	10 060 9641
955	955 Sprint RS	01	10 060 9751	600	FZR600	91-99	10 060 9501
955	955 Sprint RS (VIN 139277 >)	02-04	10 060 9751	600	FZS600 Fazer	98-03	10 060 9081
955	955 Sprint ST	01	10 060 9751	600	SRX600	86-89	10 060 9290
955	955 Sprint ST	05	10 060 9351	600	TT600	83-92	10 060 9290
955	955 Sprint ST (VIN 139277 a 208166)	02-04	10 060 9751	600	TT600 RE	04	10 060 9290
955	955 Tiger	01-04	10 060 9751	600	XJ600	84-85	10 060 9641
955	955 Tiger	05-06	10 060 9351	600	XJ600	86-91	10 060 9641
955	955i Daytona	05-06	10 060 9351	600	XJ600	91-03	10 060 9501
955	955i Daytona	99-01	10 060 9751	600	XJ6-Diversion-SP (Abs)	09-15	10 060 9351
955	955i Daytona (VIN 132513 >)	02-04	10 060 9751	600	XS600	92	10 060 9501
955	955i Speed Triple	05	10 060 9351				

CC	MODELLO - MODEL	ANNO YEAR	NYP SO	CC	MODELLO - MODEL	ANNO YEAR	NYP SO
600	XS600	95	10 060 9501	1300	XVZ13	85-93	10 060 9811
600	XT600 E-Z Tenere	83-05	10 060 9290	1300	XVZ13	96-13	10 060 9501
600	YX600 C-S,T,U,W,A Radian	86-90	10 060 9641	1600	XV1600	99-04	10 060 9501
600	YZF600 Thundercat	95-03	10 060 9501	1700	VMX1700 V-Max	09-15	10 060 9501
600	YZF-R6	06-15	10 060 9351	1700	XV1700	02-15	10 060 9501
600	YZF-R6	99-05	10 060 9501	1900	XV1900	06-10	10 060 9501
650	XJ650-Turbo	80-84	10 060 9641	1900	XV1900	11-15	10 060 9351
650	XVS650 A Drag Star Classic	98-05	10 060 9290				
650	XVS650 Drag Star	97-04	10 060 9290				
660	MT-03	06-12	10 060 9290				
660	SZR660	96-98	10 060 9290				
660	XT660 R-X SuperMotard-Z Tenere	04-15	10 060 9290				
660	XTZ660 Tenere	91-99	10 060 9290				
700	FZ-07 (Abs)	15	10 060 9351				
700	FZ700 T,TC	87	10 060 9531				
700	MT-07 (Abs)	14-15	10 060 9351				
700	XJ700	85-86	10 060 9641				
700	XV700	84-87	10 060 9290				
700	YZF-R7	99-01	10 060 9501				
750	FZ750 Genesis	85-94	10 060 9531				
750	FZR750 (OW01)	90-92	10 060 9501				
750	FZR750 RA,RB	91-92	10 060 9531				
750	FZX750	98	10 060 9531				
750	FZX750	86-88	10 060 9531				
750	XJ750	81-84	10 060 9641				
750	XS750	77-80	10 060 9811				
750	XTZ750 Super Tenere	90-97	10 060 9290				
750	XV750	81-99	10 060 9290				
750	YZF750	93-98	10 060 9501				
800	FZ8-Fazer	10-15	10 060 9351				
850	TDM850	91-01	10 060 9290				
850	TRX850	95-00	10 060 9290				
850	XS850	80-81	10 060 9811				
900	FJ-09	15	10 060 9351				
900	MT-09-Tracer-SportTracker-StreetRally (Abs)	14-15	10 060 9351				
900	TDM900 (Abs)	02-12	10 060 9290				
900	XJ900	82-93	10 060 9641				
900	XJ900 S Diversion	94-03	10 060 9501				
920	XV920	81-83	10 060 9290				
950	XVS950	09-15	10 060 9351				
1000	FZ1 Fazer (Abs)	06-15	10 060 9351				
1000	FZR1000	91-94	10 060 9501				
1000	FZR1000 Genesis	87-90	10 060 9531				
1000	FZS1000 Fazer	01-05	10 060 9501				
1000	GTS1000	93-00	10 060 9501				
1000	XV1000	81-85	10 060 9290				
1000	XV1000 SE-Virago	83-00	10 060 9290				
1000	YZF1000 Thunder Ace	96-02	10 060 9501				
1000	YZF-R1	07-15	10 060 9351				
1000	YZF-R1	98-06	10 060 9501				
1100	BT1100 Bulldog	02-06	10 060 9290				
1100	FJ1100	84-86	10 060 9531				
1100	XJ1100 J	82	10 060 9811				
1100	XS1100	78-84	10 060 9811				
1100	XVS1100 A Drag Star Classic	99-05	10 060 9290				
1100	XVS1100 Drag Star	99-05	10 060 9290				
1200	FJ1200	86-95	10 060 9531				
1200	VMX1200 V-Max	85-95	10 060 9811				
1200	VMX1200 V-Max	96-07	10 060 9501				
1200	XJR1200	95-98	10 060 9531				
1200	XT1200 Z Super Tenere	10-15	10 060 9351				
1200	XVZ1200	83-86	10 060 9811				
1300	FJR1300	01-12	10 060 9681				
1300	FJR1300	13-15	10 060 9351				
1300	MT-01	05-11	10 060 9501				
1300	XJR1300	99-15	10 060 9531				
1300	XVS1300	11-14	10 060 9351				
1300	XVS1300 Midnight Star	07-10	10 060 9081				



FILTRI CARBURANTE

FUEL FILTERS

10 060 7000



FILTRO BENZINA - FUEL FILTER

Attacco tubo Ø 6-8

(Elemento filtrante in carta)

Pipe attack Ø 6-8

(Paper filter)



10 060 7010



FILTRO BENZINA MIGNON - FUEL FILTER

Attacco tubo Ø 7

Pipe attack Ø 7



10 060 7020



UFI

FILTRO BENZINA - FUEL FILTER

DUCATI: 851 S-Ssl^o-Ss racing I^o- Superbike I^o-Sp/2/3 I^o- Sport Production >92

GUZZI: 1000 Daytona ie • V10 Centauro ie • Gt Sport • 1100 • V11 • Cafè Sport • Le Mans-Sport • ie



10 060 7030



UFI

FILTRO GASOLIO - DIESEL FUEL FILTER

AIXAM: Microcars Serie 3251

BELLIER: Divane 505 D • Vx 550 • S

CARLETTI: 500 SL • Top SL

CASALINI: Sulky • Ydea 505 GLX Diesel

CHATENET: Stella 214 • Passion

GRECAV: Eke • Diesel • E • L • Lm • Lp • XL • XLe Palladium

JDM: Alabiza Base L • Club • Confort L

LIGIER: Diesel • Ambra 162 GL • GLs • Sulky

MICROCAR: Lyra 505 Sprint • Txe • Virgo 505

SAVEL: Spacia 2 Re

TASSO: 505 • C1db Ts • Bingo • Ss • Domino Pick Up • Hola



10 060 7050



UFI

FILTRO GASOLIO - DIESEL FUEL FILTER

420: Tmp 703 Diesel • Poker Diesel

(R.O. 245303)



10 060 7060



UFI

FILTRO BENZINA - FUEL FILTER

BMW: 125-200 C1 • 750 K75 • C-Rt • Rt Kat • S T • Touring • 850 R • Rt abs • 1000 K1 72-74 Kw • Club • abs • 1000 K100 • Basic • Lt • Lt abs

Rs • Rt • 72-74 Kw Rs • Rs Club • Rs abs

1000 K1100 72-74 • Kw • Lt • Lt Se • Rs

1000 R 1100 Gs • Rs • R • Rsc • Rt abs • S

1150 R Gs • 1200 R • C • C Kat • 1200 K • Lt • Rs

CAGIVA: 650 Raptor • V Raptor (Suzuki)

900 Elefant • E • ie Gt • ie Lucky Explorer

900 Gran Canyon ie • 1000 Navigator

Raptor • V Raptor • Xtra Raptor (Suzuki)

DUCATI: 748 Bi Monoposto • R • S • Sp • Sps

750-800 Super Sport ie • 851 • S • Ss II^o

Ss Racing • Ss Super Bike • Sp Sp2-Sp3 II^o

851 Sport Production II^o • 888 Biposto • Sp4

5 • Racing • Strada • 900 M ie Cromo Monster

Dark Monster • Monster S ie • ie Gt-Paso ie

916 • Monster S4-St4 ie Bi Monoposto • Sen-

na • Sp • Sps • Strada • 944 St2 ie 996 Biposto

Two Seater (Usa) • Sps III^o • 998 S • Super Bike

S Super Bike Bostrom (Usa) • 1000 S. Sport ie

TRIUMPH: 900 T 509 Speed Triple • Tiger

955 Daytona • I-Sprint St • Tiger



10 060 7040



UFI

FILTRO GASOLIO - DIESEL FUEL FILTER

420: Tmp 703 Diesel • Poker Diesel

1200: Porter • Lombardini 01-95>

1400: Porter • Lombardini 01-95>

(R.O. 247444)



10 060 7070



FILTRO BENZINA - FUEL FILTER

KYMCO 50: Agility 12"

(R.O. 00159119)



10 060 7080



UFI

FILTRO GASOLIO - DIESEL FUEL FILTER

PIAGGIO 1200: Porter diesel 11





FILTRI BENZINA - FUEL FILTERS				FILTRI GASOLIO - DIESEL FILTERS			
MODELLO MODELS	CC	ANNO YEAR	CODICE CODE	MODELLO MODELS	CC	ANNO YEAR	CODICE CODE
BMW				AIXAM			
C1 K75 • C • Rt • Rt Kat • S • T • Touring	125-200 750		10 060 7060	Microcars Serie 3251			10 060 7030
R • Rt abs K1 72-74 • Kw • Club • abs	850 1000		10 060 7060	BELLIER			
K100 • Basic • Lt • Lt abs • Rs • Rt • 72-74 Kw Rs • Rs • Club • Rs abs	1000		10 060 7060	Divane -D-Vx 550 /S	505		10 060 7030
K1100 72-74 • Kw • Lt • Lt Se • Rs R 1100 Gs • Rs • R • Rsc Rt abs • S	1000		10 060 7060	CARLETTI			
R Gs R • C • C Kat • 1200 K • Lt • Rs	1150 1200		10 060 7060	SL-Top SL	500		10 060 7030
CAGIVA				CASALINI			
Raptor • V Raptor (Suzuki) • 900 Elefant • E ie Gt • le Lucky Explorer	650		10 060 7060	Sulky-Ydea Gix Diesel	505		10 060 7030
Gran Canyon Le Navigator Raptor • V Raptor • Xtra Raptor (Suzuki)	900 1000		10 060 7060	CHATENET			
DUCATI				Stella 214-Passion			10 060 7030
Bi Monoposto • R • S • Sp • Sps	748		10 060 7060	GRECAV			
Super Sport Le-851 • S • Ss II° • Ss Racing	750-800		10 060 7060	Eke-Diesel-E-L-Lm-Lp-XL-Xle Palladium			10 060 7030
Ss Super Bike Sp Sp2 • Sp3 II° • 851 Sport Production II°	851		10 060 7060	JDM			
Biposto • Sp4 • 5 • Racing-Strada	888		10 060 7060	Alabiza Base L-Club-Confort L			10 060 7030
M Le Cromo Monster Dark • Mon. • Mon. S Le • Le Gt • Paso Le	900		10 060 7060	LIGIER			
Monster S4-St4 Le Bi Monoposto • Senna • Sp • Sps • Strada	916		10 060 7060	Diesel-Ambra 162 GL-GLs-Sulky			10 060 7030
St2 Le Biposto Two Seater (Usa)	944 966		10 060 7060	MICROCAR			
Sps III° S • Super Bike S Super	998		10 060 7060	Lyra Sprint-Txe-Virgo 505	505		10 060 7030
Bike Bostrom (Usa) • S. Sport Le	1000		10 060 7060	PIAGGIO APE			
S-Ssl° • Ss racing I° • Superbike I° • Sp/2/3 I° Sport Production	851	>92	10 060 7020	703 247444 • Tmp Diesel (421) Poker Diesel			10 060 7040
GUZZI				Porter 1,2 Lombardini		01-95>	
Daytona Le V10 Centauro Le • Gt Sport	1000		10 060 7020	Porter 1,4 Lombardini		01-95>	
V11 • Cafe Sport Le Mans • Sport • Le	1100		10 060 7020	Tmp 703 Diesel (421) Con Piaggio 245303 Poker Diesel con Piaggio 245303			10 060 7050
TRIUMPH				PIAGGIO PORTER			
T 509 Speed Triple • Tiger-955 Daytona • ISprint St • Tiger	900		10 060 7060	Porter Autobus 1.2D	1200	11>	10 060 7080
				Porter Furgonato 1.2D	1200	11>	10 060 7080
				Porter Ribaltabile 1.2D	1200	11>	10 060 7080
				Porter Pianale Piatto - Telaio	1200	11>	10 060 7080
				SAVEL			
				Spacia 2 Re			10 060 7030
				TASSO			
				C1db-Ts-Bingo-Ss-Domino Pick Up-Hola	505		10 060 7030



RMS
YOUR BEST PARTNER

▶ **FILTRI OLIO**
OIL FILTERS





FILTRI OLIO

OIL FILTERS

CODICE CHAMPION CHAMPION CODE	VECCHIO CODICE CHAMPION CHAMPION OLD CODE	CODICE HF HF CODE	CODICE RMS RMS CODE	CODICE CHAMPION CHAMPION CODE	VECCHIO CODICE CHAMPION CHAMPION OLD CODE	CODICE HF HF CODE	CODICE RMS RMS CODE
COF011	X304	HF111	10 060 9325	COF071B	-	-	10 060 9975
COF013	X301 - X356	HF113	10 060 9195	COF071C	C306	HF171	10 060 9565
COF016	X319 - X357	HF116	10 060 9525	COF072C	-	HF172	10 060 9725
COF023	X310	HF123	10 060 9415	COF074C	-	HF174	10 060 9735
COF026	X314	HF126	10 060 9945	COF077	-	HF177	10 060 9745
COF031	X327	HF131	10 060 9065	COF081	X330	HF181	10 060 9035
COF032	X328	HF132	10 060 9055	COF082	-	HF182	10 060 9435
COF033	X307	HF133	10 060 9275	COF083	C320	HF183	10 060 9045
COF036	X319	HF136	10 060 9455	COF084	C316	HF184	10 060 9075
COF037	X308	HF137	10 060 9655	COF085	X325	HF185	10 060 9025
COF038	X301	HF138	10 060 9515	COF086	-	HF186	10 060 9495
COF039	X345	HF139	10 060 9625	COF091	-	HF191	10 060 9755
COF040	X354	HF140	10 060 9895	COF100118S	F118	-	10 060 8005
COF041	-	HF141	10 060 9385	COF100136S	F136	-	10 060 9995
COF042	X348	HF142	10 060 9615	COF100180F	F180	-	10 060 9985
COF043	X313	HF143	10 060 9635	COF102	F302	HF202	10 060 9245
COF044	X306	HF144	10 060 9645	COF104	F308	HF204 HF951	10 060 9355
COF045	X302	HF145	10 060 9295	COF107	X351	HF207	10 060 9575
COF046	X311	HF146	10 060 9815	COF203	F304 - F306	HF303	10 060 9505
COF047	F307	HF147 HF985	10 060 9085	COF301	X303 - X315	HF401	10 060 9535
COF048	-	HF148	10 060 9685	COF451	C305	HF551	10 060 9155
COF051	X305	HF151	10 060 9205	COF452	H302	HF552	10 060 9125
COF052	X312	HF152	10 060 9585	COF453	F310	HF553	10 060 9765
COF053	H301	HF153	10 060 9105	COF454	F305	HF554	10 060 9795
COF054	X337	HF154	10 060 9225	COF456	X347	HF556	10 060 9925
COF055	X320	HF155	10 060 9215	COF461	-	HF561	10 060 9935
COF056	F303	HF156	10 060 9665	COF462	-	HF562	10 060 9375
COF057	X335	HF157	10 060 9545	COF463	-	HF563	10 060 9805
COF059	-	HF159	10 060 8015	COF465	-	HF565	10 060 9775
COF060	-	HF160	10 060 9695	COF466	-	HF566	10 060 9485
COF061	X317	HF161	10 060 9175	COF467	-	HF567	10 060 8025
COF063	C301	HF163	10 060 9135	COF468	-	HF568	10 060 9885
COF064	C325	HF164	10 060 9555	COF469	-	HF569	10 060 8035
COF065	-	HF165	10 060 9705	COF511	-	HF611	10 060 9785
COF067	-	HF167	10 060 9475	COF531	-	HF631	10 060 9875
COF068	-	HF168	10 060 9905	COF552	-	HF652	10 060 9595
COF069	-	HF169	10 060 9915	COF555	-	HF655	10 060 9605
COF070B	-	-	10 060 9965	COF581	-	HF681	10 060 9955
COF070C	-	HF170	10 060 9715				

10 060 8005

PIAGGIO 1200: Porter Diesel 95-00
1400: Porter Diesel 95-00 • Porter Pick/Van Diesel 98-05
(Riferimento Champion: COF1001185)
R.O. 493063

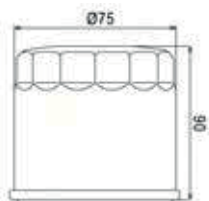

10 060 8015 **NEW**

FILTRO OLIO - OIL FILTER
DUCATI 899: Panigale 13 • **959:** Panigale 16
1199: Panigale 12 • Panigale R 13 • Panigale S 12 • Panigale Tricolore 12-14 Superleggera 15
1299: Panigale S Abs 15
(Riferimento Champion: COF059)

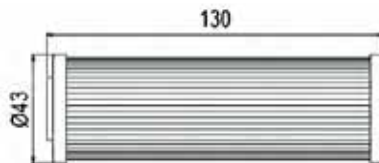

10 060 8025 **NEW**

MV AGUSTA 920: Brutale 11 • **990:** Brutale R 10-11 • **1000:** F4 10 • F4 R 12-14 • F4 Rr 12
1090: Brutale 14 • Brutale Corsa 15 • Brutale R 12-14 • Brutale Rr 10
(Riferimento Champion: COF467)



10 060 8035 **NEW**

MV AGUSTA 675: Brutale 12 • F3 11 • F3 Rc 16 V • F3 Serie Oro 12 • **800:** Brutale 13 • Brutale Dragster 15 Brutale Dragster Rr 15 Brutale Dragster Rr Lh44 16 • Brutale Rr 15 • F3 13 • F3 Ago 15 • F3 Amg Gt 16 • F3 Rc 16 • Rivale 13 • Stradale 15 • Turismo Veloce 14 • Turismo Veloce Lusso 14
(Riferimento Champion: COF469)



10 060 8045

KTM 950-1190: Tutti i modelli - *All models*
(Riferimento Champion: COF550)

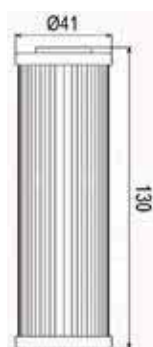

10 060 9025

APRILIA 125: Leonardo 96-05 • Scarabeo Rotax 99-05
150: Leonardo 96-05 • Scarabeo 99-03
200: Scarabeo Rotax
BMW: C1 125-200
PEUGEOT: Eliseo Elistar 125-150 • Satelis 125
(Riferimento Champion: COF085)

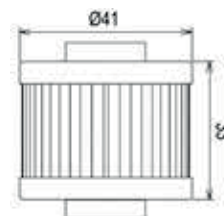

10 060 9035

APRILIA 125: Habana • Mojito
PIAGGIO 125: Liberty 97-00 • Hexagon 98-99 • Sfera 95-97 • Vespa Et4 96-99
(Riferimento Champion: COF081)



10 060 9045

APRILIA 125-150-200-250-300: Sport City Scarabeo (Mot. Piaggio)
PIAGGIO 125-150-200-250-300: Liberty • Vespa • Carnaby • Beverly • Mp3
(Riferimento Champion: COF083)

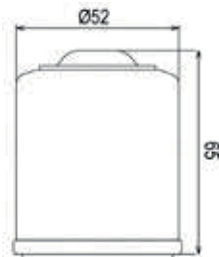

10 060 9055

SUZUKI 250: Burgman 99-07
400: Burgman 99-06
YAMAHA 400: Majesty 04-11
(Riferimento Champion: COF032)



10 060 9065

SUZUKI 125: Epicuro 99-03 • Burgman 02-10 • Sixteen 08-10 - **150:** Sixteen 08-10
200: Burgman 07-10 - **400:** Burgman 09-13
(Riferimento Champion: COF031)

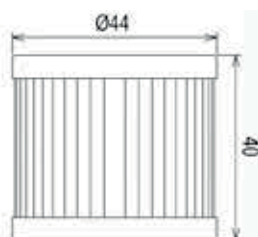

10 060 9075

APRILIA 400: Scarabeo 06-09 • Atlantic 06-09
500: Scarabeo 02-11 • Atlantic 02-09
PEUGEOT 400-500: Motori Piaggio
PIAGGIO 400: Beverly 06-09 • Mp3 08-10 • X Evo 07-09 • X8 06-08
500: Beverly 03-10 • X9 02-03 • X9 Evolution 03-10
(Riferimento Champion: COF084)

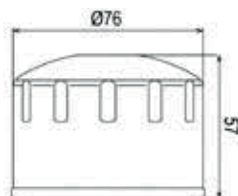

10 060 9085

KYMCO
YAMAHA
(Riferimento Champion: COF047)

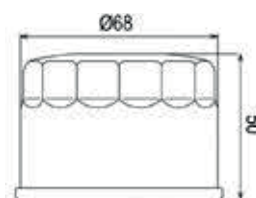

10 060 9105

DUCATI: Tutti i modelli - *All models*
(Riferimento Champion: COF053)

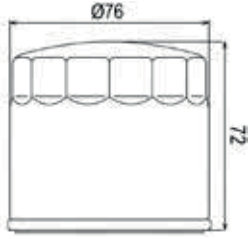

10 060 9125

MOTO GUZZI 850: Le Mans 1,2,3-California-T4-T5
1000: California 82-93 • Daytona 92-93 • Le Mans
4,5 84-92 • S • Sp • Sp2 • Sp3
(Riferimento Champion: COF452)

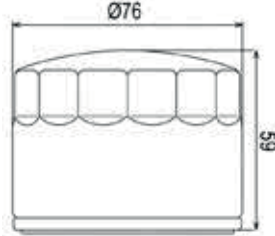

10 060 9135

BMW 750: K75 - **850:** R 850 C - Gs - R - Rt
1000: K100 • K1
1100: K1100 Lt • R 1100 Gs • R • Rs • Rt • S
1150: R1150 Gs • R • Rs • Rt
1200: K1200 • R1200 C
(Riferimento Champion: COF063)



10 060 9155

MOTO GUZZI 850:
Tutti i modelli - *All Models* >06
1000: Daytona 94-01 • V10 97-01
1100: California • V11
1200: Griso • Norge • Sport • Stelvio
(Riferimento Champion: COF451)

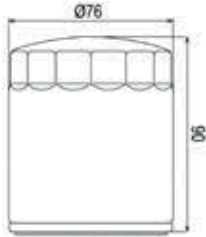

10 060 9175

BMW: R45 • R65 • R80 Gs • R • Rt • St • R90 • R100
(Riferimento Champion: COF061)

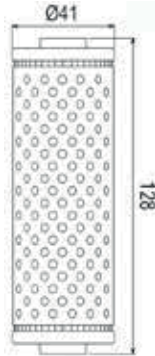

10 060 9195

HONDA 125-200-250-350-600: XL • Xr
650: Xr • Dominator
KAWASAKI 125-250-300-450: Klx
(Riferimento Champion: COF013)

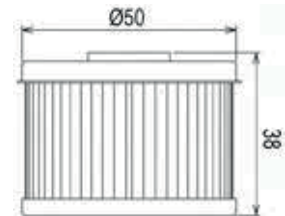

10 060 9205

BMW: F 650
KTM 400-600: Motori Rotax
(Riferimento Champion: COF051)



10 060 9215

KTM-HUSABERG:
(Riferimento Champion: COF055)

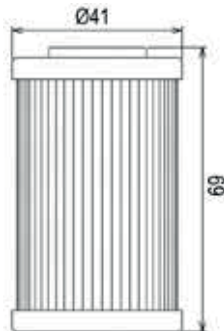

10 060 9225

HUSQVARNA 410-510-610: Te • Tc
(Riferimento Champion: COF054)

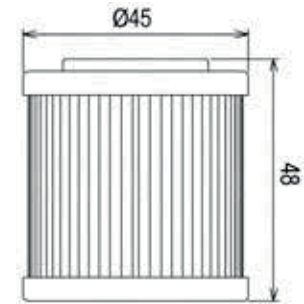

10 060 9245

HONDA 400-500-750-1000: Vf
(Riferimento Champion: COF102)

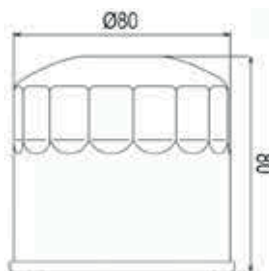

10 060 9275

SUZUKI 250-400-550-750: Gsx
250-450-550-650-750-1100: Gs
(Riferimento Champion: COF033)

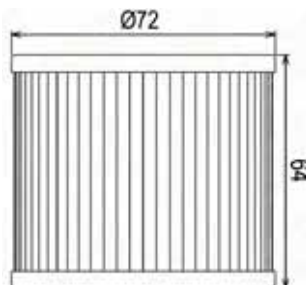

10 060 9295

YAMAHA 250: Fzr • Sr • Tt • Xt - **400:** Sr • Srx • Xt
500: Sr • Tt • Xt - **600:** Srx • Tt • Xt
660: Mt 03 • Xtr • Xtx • Xtz - **850:** Tdm - **900:** Tdm
(Riferimento Champion: COF045)

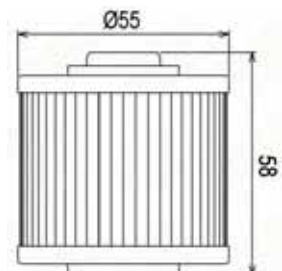

10 060 9325

HONDA 400-500-550-650: Cb • Cbx
(Riferimento Champion: COF011)

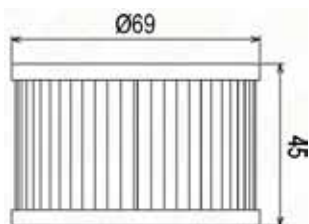

10 060 9355

**HONDA-KAWASAKI-MV AGUSTA
TRIUMPH-YAMAHA**
(Riferimento Champion: COF104)

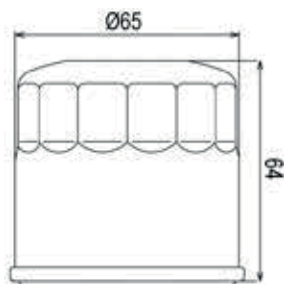

10 060 9375

KYMCO 125: Dink 06-10 • Grand Dink 01-09
150: Grand Dink 01-05
200: Dink 06-10 • Yager Gt 10-13
(Riferimento Champion: COF462)



10 060 9385

YAMAHA 125: X City 07-11 • X Max 06-13
(Riferimento Champion: COF041)



10 060 9415

KAWASAKI 250-300-600-650: KL
(Riferimento Champion: COF023)



10 060 9435

PIAGGIO 350: Beverly Sport Touring 4T 4V ie 11>
(Riferimento Champion: COF082)
R.O. 880887



10 060 9455

SUZUKI 250-350-400: Dr
(Riferimento Champion: COF036)

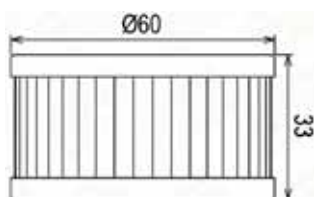

10 060 9475

LML 125-150: Star
(Riferimento Champion: COF067)

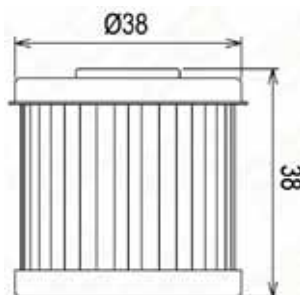

10 060 9485

KYMCO 125: Downtown 09-10 • Super Dink 09-13
150: People Gt le 10-11 - **200:** Downtown le 10-11
300: Downtown 09-13 • People Gt
(Riferimento Champion: COF466)



10 060 9495

APRILIA 125-200: Scarabeo Light
(Riferimento Champion: COF086)

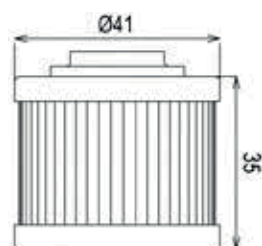

10 060 9505

HONDA-KAWASAKI-YAMAHA
(Riferimento Champion: COF203)

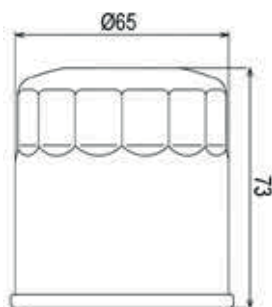

10 060 9515

APRILIA 1000: Rs V4
CAGIVA 650: Raptor • V Raptor
1000: Raptor • V Raptor
SUZUKI
(Riferimento Champion: COF038)

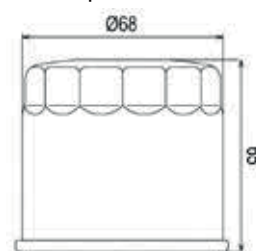

10 060 9525

HUSQVARNA 250: Te 10-12
HONDA 150-250-450: Crf
(Riferimento Champion: COF016)

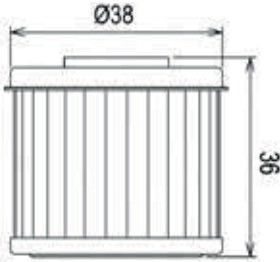

10 060 9535

HONDA-KAWASAKI-TRIUMPH-YAMAHA
(Riferimento Champion: COF301)

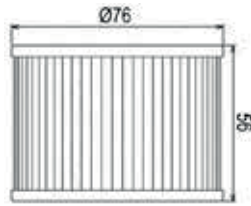

10 060 9545

KTM 250-400-450-520-525-660-690
(Riferimento Champion: COF057)

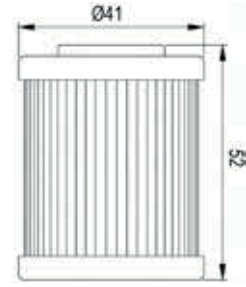

10 060 9555

BMW: F800 • K1200 Gt • Lt • R • S • Rs
• R1200 Gs 04>
K1600
(Riferimento Champion: COF064)

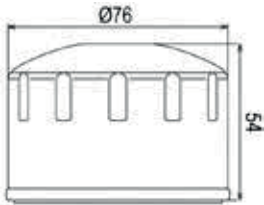

10 060 9565

BUELL 1200
HARLEY DAVIDSON 1340-1450
(Riferimento Champion: COF071C)

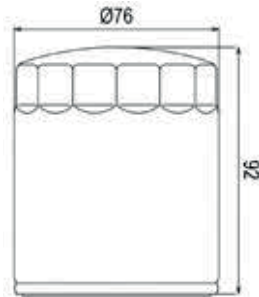

10 060 9575

BETA 250-300: Tutti i modelli - *All models*
SUZUKI 250-450: Rmz
KAWASAKI 250: Kx
(Riferimento Champion: COF107)

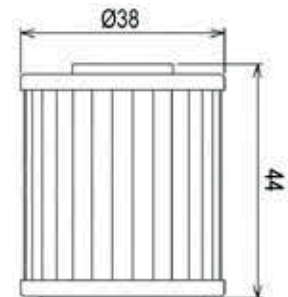

10 060 9585

APRILIA 1000: Etv • Rsv
(Riferimento Champion: COF052)

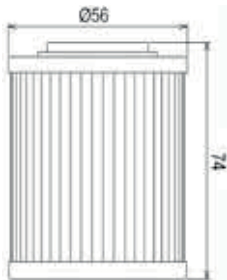

10 060 9595

KTM: Xc • Exc 08>
(Riferimento Champion: COF552)

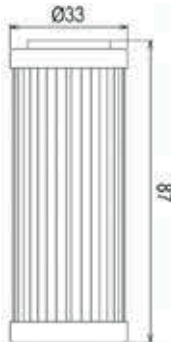

10 060 9605

HUSABERG 450 - KTM 250: 07>
Tutti i modelli - *All models*
(Riferimento Champion: COF555)

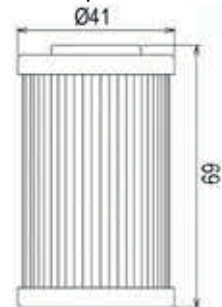

10 060 9615

YAMAHA 250-400-426: Yz • Wr 01-02
(Riferimento Champion: COF042)

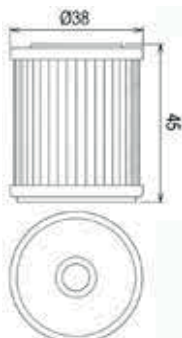

10 060 9625

KAWASAKI 450: KLX
SUZUKI 400: Drz
(Riferimento Champion: COF039)

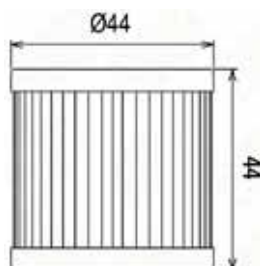

10 060 9635

MBK 125: Xc • **YAMAHA 125-250-350:** Xt
(Riferimento Champion: COF043)

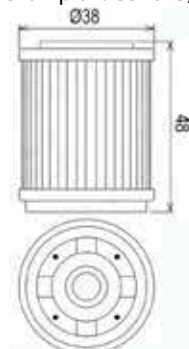

10 060 9645

YAMAHA: Xj
(Riferimento Champion: COF044)

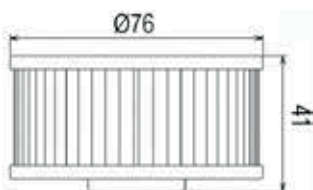

10 060 9655

SUZUKI 500-600-650-800: Dr
(Riferimento Champion: COF037)

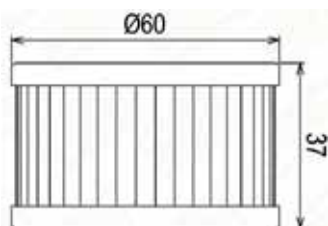

10 060 9665

KTM 620-625-640: Tutti i modelli - All models
(Riferimento Champion: COF056)

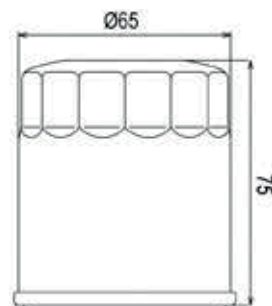

10 060 9685

YAMAHA 1300: Fjr
(Riferimento Champion: COF048)

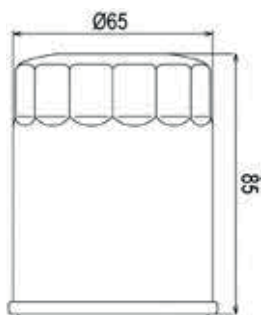

10 060 9695

BMW: S1000 RR • K 1300
(Riferimento Champion: COF060)

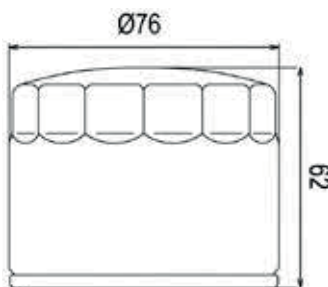

10 060 9705

BMW: F 800 S • St
(Riferimento Champion: COF065)

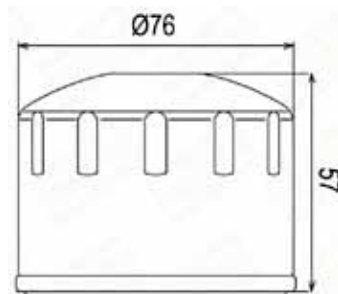

10 060 9715

HARLEY DAVIDSON
(Riferimento Champion: COF070C)

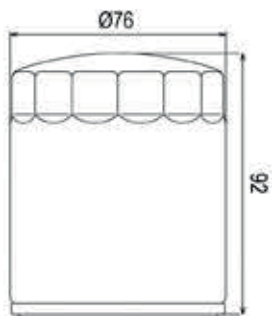

10 060 9725

HARLEY DAVIDSON
(Riferimento Champion: COF072C)

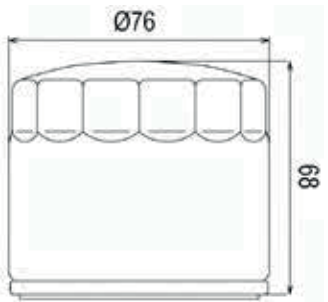

10 060 9735

HARLEY DAVIDSON: V Rod
(Riferimento Champion: COF074C)

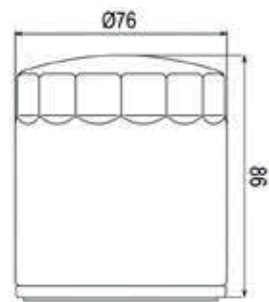

10 060 9745

BUELL 900-1200
(Riferimento Champion: COF077)

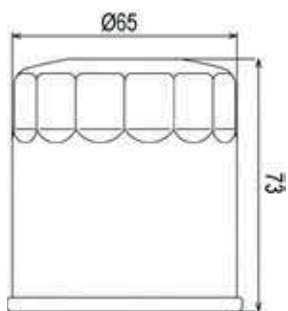

10 060 9755

TRIUMPH 600-509-595-800-955: <03
(Riferimento Champion: COF091)



10 060 9765

BENELLI 900: Tornado • 1130: Tnt
(Riferimento Champion: COF453)



10 060 9775

APRILIA 750: SL • Smv • **850:** Mana
1200: Dorso duro • **GILERA 800:** Gp
(Riferimento Champion: COF465)

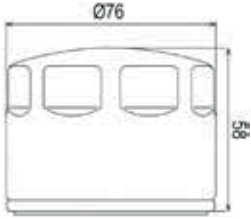

10 060 9785

BMW: G 450 X • **HUSQVARNA 449-511**
(Riferimento Champion: COF511)

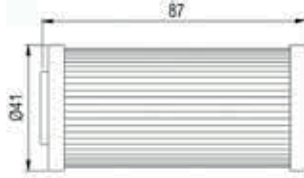

10 060 9795

MV AGUSTA 750-1000: F4
(Riferimento Champion: COF454)

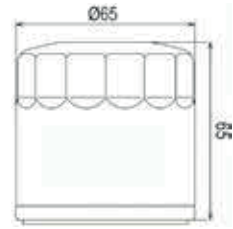

10 060 9805

APRILIA: Rxv 450-550
HUSQVARNA 250-450-510-530-630: 08>
(Riferimento Champion: COF463)

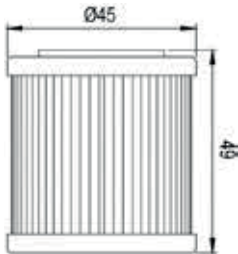

10 060 9815

YAMAHA: Xs-Xvz 1200 • Xvz 1300 • Vmx 1200
(Riferimento Champion: COF046)

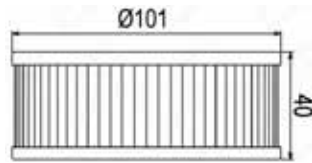

10 060 9875

BETA 350-400-450-498-520: Rr Enduro 10-12
(Riferimento Champion: COF531)

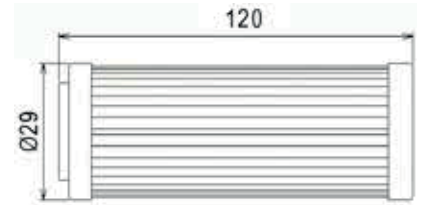

10 060 9885

KYMCO: Xciting 400 12
(Riferimento Champion COF468)

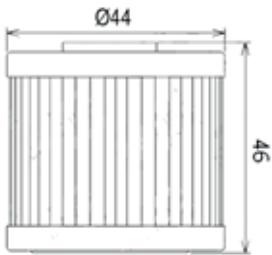

10 060 9895

YAMAHA: Wr 250 • Yz 450
(Riferimento Champion COF040)



10 060 9905

DAELIM 125: S1 Otello 07> • S2 Freewing 07Z •
Ns 07> • SL B Bone 07> • SL History 01>
(Riferimento Champion: COF068)



10 060 9915

DAELIM 125: Vj Roadwin 01> • VL Daystar 01> •
Vs Evolution 06>
(Riferimento Champion: COF069)

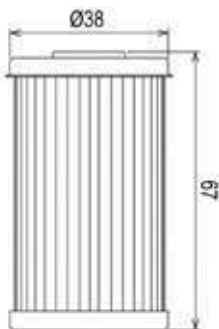

10 060 9925

BOMBARDIER ATV 500: Quest 03-04 • Traxter
Auto Cvt 05> • **650:** Quest 02-04 • Quest Max
04> • Quest Xt 02-03 • Traxter Auto Cvt 05> •
Traxter Max Auto Cvt 05>
• Trail Buck 05>
• Trail Buck Ex - Ext 05>
(Riferimento Champion: COF456)

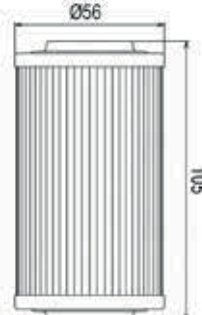

10 060 9935

KYMCO 250: Venox 02-11
(Riferimento Champion: COF461)

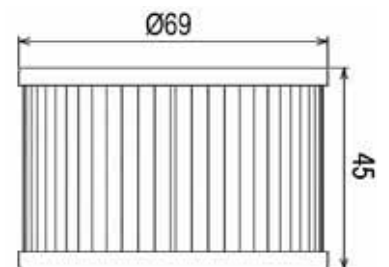

10 060 9945

KAWASAKI 750: Z B1-B4, Y1, Y2, LTD (2 Cylinders) 78-82 • Z D1 (2 Cylinders) 78> • **900:** Z Z1, Z1A, Z1B 73-75 • **1000:** Kz A1, A2, A3, A4 77-81 • Kz B1, B2, B3, B4, Ltd 77-81 • Kz C1, C2, C3, C4, C4A 78-81 • Kz D1, D2, D3 78-80 • Kz E1, E2, G1 78-80 • Z A1, A2, A3, A4 77-81 • Z D1 (Z1R) 78> • Z E1, E2, St 79-80 • Z H1, H2 74-75 • 1300: Kz A1, A2, A3, A4, A5 79-83 • Kz B2 80> • Zn A1, A6 Voyager 83-88
(Riferimento
Champion: COF026)

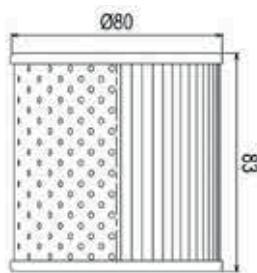

10 060 9955

HYOSUNG 650: Gt Comet 05-08 • Gt Comet Efi 09-11 • Gt Naked 04-06 • Gt Naked Se I 07-08 • Gt R Comet Efi 09-11 • Gt R Sport Fi 07-08 • Gt R Sporttouring 05-08 • Gt S Comet Efi 10-11 • Gt S Sport 05-08 • Gv Aquila 05-08 • Gv Aquila Efi 09-11 • Gv Avitar Efi 11> • Gv Se Efi 11> • St7 10-11 • **700:** Gv C Efi 10-11
(Riferimento
Champion: COF581)



10 060 9965

HARLEY DAVIDSON
(Riferimento Champion: COF070B)

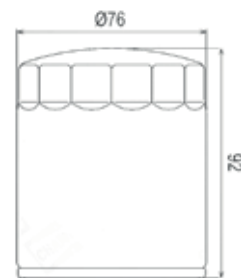

10 060 9975

BUELL 1200
HARLEY DAVIDSON 1340-1450
(Riferimento Champion: COF071B)

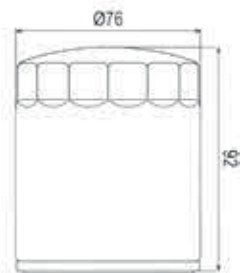

10 060 9985

PIAGGIO 1000-1300: Porter 16V
(Riferimento Champion: COF100180S)

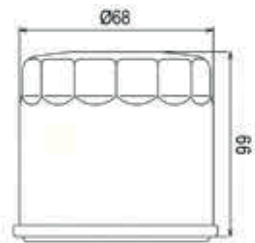

10 060 9995

PIAGGIO 500: AL Diesel 04-07
Ligier 162 Ambra 98-00
Ligier Nova 00 • M - Pk 03-10 • Quargo 05-12
750: Quargo Diesel 04-06
(Riferimento
Champion: COF100136S)
R.O. 850284

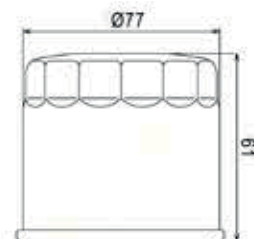



MARMITTE PIAGGIO VESPA - APE

PIAGGIO VESPA - APE SILENCERS

10 075 1000 

PIAGGIO 50: Vespa V5B1/2/3
Resistente fino a 500° verniciata trasparente
500° heat resistance transparent painting
(R.O.137655)



10 075 1010 

PIAGGIO 125: Vespa Primavera VMA2
Resistente fino a 500° verniciata trasparente
500° heat resistance transparent painting
(R.O.120218)



10 075 1020 

PIAGGIO 150: Vespa Sprint-GL-Sprint Veloce
VLB-VLB1T-VLA
Resistente fino a 500° verniciata trasparente
500° heat resistance transparent painting
(R.O.124046)



10 075 1030 

PIAGGIO 200: Vespa Pe-Px VSX-VSX2
Resistente fino a 500° verniciata nera
500° heat resistance black painting
(R.O.417809)



10 075 1040 

PIAGGIO 125-150: Vespa Px
VNX-VLX-VNX2-VLX2
(R.O.417806)



10 075 1090 

PIAGGIO 50: Ape 1° Serie
Resistente fino a 500° verniciata nera
500° heat resistance black painting
(R.O. 129246)



10 075 1110 

PIAGGIO 50: Ciao - Px
(R.O. 2472605)

10 075 1120 

Si - Si FL2
(R.O. 2144034)



10 075 1140 

PIAGGIO 50: Ape Europa
Resistente fino a 500° verniciata nera
500° heat resistance black painting
(R.O. 830452)



10 075 1150 

PIAGGIO 125-150: Vespa Px
Modello Touring - *Touring model*



10 075 1160 

PIAGGIO 200: Vespa P E
Modello Touring - *Touring model*



10 075 1170 

PIAGGIO 125-150: Vespa Super
(R.O. 131869)



Marmitte non omologate. Vietato l'uso su strade pubbliche
Only for race and show. For road legal use in your country, contact local traffic authorities



14 280 0040

TERMINALE MARMITTA-EXHAUST TERMINAL

Vari modelli Vespa - *Various Vespa models*
(R.O. 610157M)



14 280 0060

TUBETTO MARMITTA - EXHAUST TUBE

Vari modelli Vespa - *Various Vespa models*



LANA DI ROCCIA - ROCK WOOL

10 072 0010

CARTUCCIA LANA DI ROCCIA Ø 60 x 170

Silenziatore cross
Rock wool cartridge for cross silencers



10 072 0020

CARTUCCIA LANA DI ROCCIA Ø 80 x 300

Silenziatore cross
Rock wool cartridge for cross silencers



10 072 0030

FOGLIO LANA DI ROCCIA 600 x 320 x 30

Per marmitta scooter
Rock wool sheet for scooter muffler



PROTEZIONE MARMITTE
EXHAUST PLASTIC COVER

14 268 0590



NEW

PROTEZIONE MARMITTA IN PLASTICA
EXHAUST PLASTIC COVER

Verniciato nero - *Black painted*

YAMAHA 500: Xp T-Max Abs 05-06 • Xp T-Max Black Max 06 • Xp T-Max 01-07
(R.O. 5GJ1465T0000)



14 268 0600



NEW

PROTEZIONE MARMITTA IN PLASTICA
EXHAUST PLASTIC COVER

Verniciato nero - *Black painted*

YAMAHA 500: Xp T-Max Abs Sv 10-11 • Xp T-Max Abs 07-11 • Xp T-Max Black Max - Night Max 07 • Xp T-Max Sv 11 • Xp T-Max White Max 10 • Xp T-Max 07-08
530: Xp T-Max Abs 12-16 • Xp T-Max Sp Abs 15-16 • Xp T-Max Sp 15 • Xp T-Max 12-16
(R.O. 5VU1465T0000)



14 268 0610



NEW

PROTEZIONE MARMITTA IN PLASTICA
EXHAUST PLASTIC COVER

Verniciato grigio - *Grey painted*

YAMAHA 125: Yp R X-Max 14-16 • Yp Ra X-Max Abs 14-17
250: Yp R X-Max 14-16 • Yp Ra X-Max Abs 14-16
(R.O. 2DME47180000)



14 268 0620



NEW

PROTEZIONE MARMITTA IN PLASTICA
EXHAUST PLASTIC COVER

Verniciato nero grezzo - *Raw black*

HONDA: Sh 300 07-13



14 268 0630



NEW

FONDELLO MARMITTA IN PLASTICA
EXHAUST END PLASTIC COVER

Verniciato grigio - *Grey painted*

YAMAHA 500: Xp T-Max Abs 05-06 • Xp T-Max Black Man 06 • Xp T-Max 01-07
(R.O. 5GJ147990100)



14 268 0640



NEW

FONDELLO MARMITTA IN PLASTICA
EXHAUST END PLASTIC COVER

Verniciato grigio - *Grey painted*

YAMAHA 400: Yp Majesty 04-06
500: Xp T-Max Abs Sv 10-11 • Xp T-Max Abs 07-11 • Xp T-Max Black Max - Night Max 07 • Xp T-Max Sv 11 • Xp T-Max White Max 10 • Xp T-Max 07-11
(R.O. 5RU147990000)



14 268 0650



NEW

FONDELLO MARMITTA IN PLASTICA
EXHAUST END PLASTIC COVER

Verniciato grigio - *Grey painted*

YAMAHA 125: Yp R X-Max 14-16 • Yp Ra X-Max Abs 14-17
250: Yp R X-Max 14-16 • Yp Ra X-Max 14-16
(R.O. 2DME47990000)



14 268 0660



NEW

FONDELLO MARMITTA IN PLASTICA
EXHAUST END PLASTIC COVER

Verniciato nero grezzo - *Raw black*

HONDA: Sh 300 07-13





▶ CINGHIE
TRASMISSIONE
TRANSMISSION BELTS

▶ **RMS**
YOUR BEST PARTNER

▶ **DAYCO**



CINGHIE TRASMISSIONE DENTATE SCOOTER

COGGED TRANSMISSION BELTS FOR SCOOTER

CC	MODELLO - MODEL	ANNO YEAR	DAYCO			RMS YOUR BEST PARTNER	RIFERIMENTO ORIGINALE OEM NUMBER
			CODICE ORIGINALE ORIGINAL CODE	CONFEZ. INDUSTR. INDUSTRIAL PACKING	RACING POWER PLUS KEVLAR	CODICE RMS RMS CODE	
			16 375 (----)				
APRILIA							
50	Amico	94	0080	0089	0082	0081	AP8206109
50	Amico	96-98	0080	0089	0082	0081	AP8206109
50	Amico GL-GLE	93-95	0080	0089	0082	0081	AP8206109
50	Amico Lx- Sport-Cat	92-93	0080	0089	0082	0081	AP8206109
50	Area 51	98-00	0080	0089	0082	0081	AP8206109
50	Gulliver	95-98	0080	0089	0082	0081	AP8206109
50	Gulliver Lc	96-98	0080	0089	0082	0081	AP8206109
50	Mojito	04-08	0250	0259	0252	0251	436864
50	Mojito Custom	99-03	0320			0321	2MCA000014
50	Mojito Retro	99-03	0320			0321	2MCA000014
50	Rally	95-03	0080	0089	0082	0081	AP8206109
50	Rally Lc	96-99	0080	0089	0082	0081	AP8206109
50	Scarabeo	93-97	0080	0089	0082	0081	AP8206109
50	Scarabeo	98-05	0080	0089	0082	0081	AP8206109
50	Scarabeo 2T	10	0060	0069			AP8570076
50	Scarabeo 2T Net	10	0060	0069			AP8570076
50	Scarabeo 4T	02-06	0060	0069			AP8570076
50	Scarabeo 4T 4V	10	0060	0069			AP8570076
50	Scarabeo 4T Net	10	0060	0069			AP8570076
50	Scarabeo 4T Rst Eu3	06-09	0060	0069			AP8570076
50	Scarabeo Ditech	01-04	0320			0321	2MCA000014
50	Scarabeo Quattro	09	0060	0069			AP8570076
50	Scarabeo Street 2T Rst	06-09	0060	0069			AP8570076
50	Sonic	98-07	0670				AP8206818
50	Sonic Gp	98-08	0670				AP8206818
50	Sport City One 2T	08-09	0060	0069			AP8570076
50	Sport City One 4T	08	0060	0069			AP8570076
50	Sr	93-96	0080	0089	0082	0081	AP8206109
50	Sr Ditech Eu2	02-03	0320			0321	2MCA000014
50	Sr H2O Ditech E Carburatore	00-03	0320			0321	2MCA000014
50	Sr Liquid Cooled	94-96	0080	0089	0082	0081	AP8206109
50	Sr R Factory le E Carburatore	10	0250	0259	0252	0251	436864
50	Sr R Factory Mot Aprilia	05	0320			0321	2MCA000014
50	Sr R R Factory	04-09	0250	0259	0252	0251	436864
50	Sr Stealth, Racing	97-99	0080	0089	0082	0081	AP8206109
50	Sr Street	03-08	0250	0259	0252	0251	436864
50	Sr Www	97-01	0080	0089	0082	0081	AP8206109
100	Scarabeo 4T	01-04			0630		AP8551053
100	Scarabeo 4T	10			0630		AP8551053
100	Scarabeo 4T Net	10			0630		AP8551053
100	Scarabeo 4T Rst	06-09			0630		AP8551053
100	Scarabeo Mot Minarelli	00	0620				AP8510604.
100	Scarabeo Mot Yamaha	00	0620				AP8510604.
125	Atlantic	03-05		0669	0660		AP8580246
125	Atlantic	03-05			0810		AP8580261
125	Atlantic Eu3	06-08		0389	0380		841213
125	Leonardo	96-01			0580		AP0280102
125	Leonardo St	03-04			0580		AP0280102
125	Mojito	03-08		0389	0380		841213
125	Mojito Retro' - Custom	99-01	0260				AP8550363
125	Scarabeo	04-06			0790		841851
125	Scarabeo Eu3	06-07			0690		AP8575041
125	Scarabeo Mot Rotax	99-03			0580		AP0280102
125	Sport City	04-06			0690		AP8575041
125	Sport City Cube	08			0690		AP8575041
125	Sport City Eu3	06-08			0690		AP8575041
125	Sport City Eu3	06-08			0790		841851
125	Sport City One T4 Eu3	08-10		0389	0380		841213
150	Leonardo Mot.Rotax	96-03			0580		
150	Mojito	03-05			0380		
150	Scarabeo -Gt Mot.Rotax	99-03			0580		
150	Scarabeo -Gt Mot.Piaggio	03->			0600		
150	Sport City	04->			0600		

CINGHIE TRASMISSIONE DENTATE SCOOTER

COGGED TRANSMISSION BELTS FOR SCOOTER





CC	MODELLO - MODEL	ANNO YEAR	DAYCO			RMS YOUR BEST PARTNER	RIFERIMENTO ORIGINALE OEM NUMBER
			CODICE ORIGINALE ORIGINAL CODE	CONFEZ. INDUSTRIAL INDUSTRIAL PACKING	RACING POWER PLUS KEVLAR	CODICE RMS RMS CODE	
16 375 (----)							
150	Sr	99->			0300		8550130/434812
200	Atlantic	02-05		0669	0660		
200	Scarabeo-GT Mot.Piaggio	03->			0690		
200	Scarabeo -Gt Mot.Rotax	99-03			0580		
200	Sport City	04->			0690		
250	Scarabeo Light	06-08			0790		841851
250	Sport City Cube	08			0790		841851
300	Scarabeo Light	09			0790		841851
400	Atlantic Sprint	05-08			0680		AP8560188
400	Scarabeo Light	06-08			0680		AP8560188
500	Atlantic	01-04			0680		AP8560188
500	Scarabeo	03-06			0680		AP8560188
ATALA							
50	Hacker			0120			
BAOTIAN							
50	Baotian Scooter Bt 49Q 7-9-11					1211	
50	Gyg Motori 4T			1000			
BSV							
50	Ax Gz			0110			
50	Sp Dio			0130			
50	Gp Dio Zx			0210			
BENELLI							
50	Naked Mot.Minarelli	02	0080	0089	0082	0081	R16140011AO
50	491 Gt-Rr-St-Sp-Mot.Minarelli	97-02	0080	0089	0082	0081	R16140011AO
50	491 Sport-Racing-Mot.Minarelli	98-02	0080	0089	0082	0081	R16140011AO
50	K2 Air-Lc-Namur mot.Minarelli	98->	0080	0089	0082	0081	R16140011AO
50	Pepe-LX Mot.Minarelli	98->	0080	0089	0082	0081	R16140011AO
125-150	Adiva	01->		0389	0380		R13440941AO
125-150	Velvet-Touring	99->			0300		R16140631AO
250	Velvet-Touring	98->		0659	0650		R16040171AO
BETAMOTOR							
50	Tempo 13"	94-95	0080	0089	0082	0081	33-01290
50	Tempo 16"-Quadra-Chrono 502	96->	0080	0089	0082	0081	33-01290
50	Ark-Ark Lc-K	96->	0080	0089	0082	0081	33-01290
50	Eikon	99->	0080	0089	0082	0081	33-01290
125-150	Eikon	99->			0580		36-10750
BMW							
125-200	C1	00->			0580		
CPI							
50	Oliver - Popcorn - Aragon GP 03			1150			
DERBI							
50	Atlantis	99-01	0360				00G02605371
50	Atlantis 02	02	0250	0259	0252	0251	436864
50	Atlantis 02 Bullet	03-05	0250	0259	0252	0251	436864
50	Atlantis 02 City	03-06	0250	0259	0252	0251	436864
50	Atlantis 02 Red Bullet	03	0250	0259	0252	0251	436864
50	Atlantis 02 Two Chic	05	0250	0259	0252	0251	436864
50	Atlantis 2T Eu2	07-09	0250	0259	0252	0251	436864
50	Atlantis 4T Eu2	07	0840				842907
50	Atlantis 50-100 4T	04-06	0840				842907
50	Atlantis Lc	99-01	0360				00G02605371
50	Boulevard 2T	09	0060	0069			AP8570076
50	Boulevard 4T Eu2 25 Km/H	09	0840				842907
50	Gp1	01-03	0250	0259	0252	0251	436864
50	Gp1 Eu2	05	0250	0259	0252	0251	436864
50	Gp1 Open Eu2	06-09	0250	0259	0252	0251	436864
50	Gp1 Race Eu2	05-07	0250	0259	0252	0251	436864
50	Hunter	96-97	0520				00G02602371
50	Hunter	>99	0180				00G02605371
50	Predator Lc	98-01	0360				00G02605371
50	Predator O2	98-01	0360				00G02605371
50	Vamos		0170				337127204
125	Boulevard Eu3	04-07		0389	0380		841213
125	Boulevard 4T Eu3	08-09		0389	0380		841213



CINGHIE TRASMISSIONE DENTATE SCOOTER

COGGED TRANSMISSION BELTS FOR SCOOTER

CC	MODELLO - MODEL	ANNO YEAR				 <small>YOUR BEST PARTNER</small>	RIFERIMENTO ORIGINALE OEM NUMBER
			CODICE ORIGINALE ORIGINAL CODE	CONFEZ. INDUSTR. INDUSTRIAL PACKING	RACING POWER PLUS KEVLAR	CODICE RMS RMS CODE	
			16 375 (----)				
125	Gp1 Eu2	06		0389	0380		841213
125	Gp1 Low Seat 125 Eu3	07-08		0389	0380		841213
125	Rambla	08			0600		842009
200	Boulevard	05		0669	0660		840908
250	Gp1	06-07			0810		843963
250	Gp1 Low Seat 250 Eu3	07-08			0810		843963
250	Rambla	08			0790		841851
300	Rambla	10			0790		841851
GARELLI							
50	Pony			0090			
50	Big Well - Racing Sr			0110			
50	Ciclone	06-08				1211	
50	Capri - Capri Lx	06-08				1211	
GILERA							
50	Dna-Gp-Experience	00-06	0060	0069		0061	82712R
50	Ice	01-05	0250	0259	0252		436864
50	Runner	97-00	0250	0259	0252		436864
50	Runner Poggiali	02	0250	0259	0252		436864
50	Runner Purejet	02-04	0250	0259	0252		436864
50	Runner Sp	02-07	0250	0259	0252		436864
50	Runner Sp	10	0250	0259	0252		436864
50	Runner Sp Spec Edit	07	0250	0259	0252		436864
50	Runner Sp St & Simoncelli	08-09	0250	0259	0252		436864
50	Stalker	97-09	0250	0259	0252		436864
50	Stalker Naked	08	0250	0259	0252		436864
50	Stalker Spec Edit	07-08	0250	0259	0252		436864
50	Storm	94-95	0010	0019	0012		430728
50	Storm Eu2	07	0250	0259	0252		436864
50	Typhoon	94-97	0010	0019	0012		430728
50	Typhoon X	98-99	0010	0019	0012		430728
50	Typhoon Xr	00	0250	0259	0252		436864
125	Dna	01		0389	0380		841213
125	Nexus Eu3	07-08		0389	0380		841213
125	Nexus Eu3 Ie	08-09		0389	0380		841213
125	Runner Fx-Fxr	97-02	0190				434812
125	Runner Vx	05-06		0389	0380		841213
125	Runner Vx 4T Eu3	07		0389	0380		841213
125	Runner Vx 4T St Eu3	08-09		0389	0380		841213
125	Runner Vx Race	06		0389	0380		841213
125	Runner Vx Sc	06-07		0389	0380		841213
125	Runner Vx-Vxr	02-04		0389	0380		841213
125	Runner Vx-Vxr	02-04		0669	0660		840908
125	Typhoon	95-98	0190				434812
125	Typhoon X-Xr	99-00	0190				434812
180	Dna	01		0669	0660		840908
180	Runner Vxr	00-01		0669	0660		840908
180	Runner Fxr	97-00			0200		484497
200	Runner Vxr	05-06		0669	0660		840908
200	Runner Vxr 4T St Eu3	08		0669	0660		840908
200	Runner Vxr Eu3	07		0669	0660		840908
200	Runner Vxr Race	06		0669	0660		840908
500	Nexus	03-05			0680		832738
500	Nexus Eu3	09			0680		832738
500	Nexus Sp Eu3	06-07			0680		832738
HSC							
50	Sc	01		0130			
50	Sc - L - Zx	01		0210			
HONDA							
50	Gp Dio	91		0130			723590
50	Lead	87-95		0140		0141	706618
50	Sfx V	95		0150			723590
50	Sh	96				0431	23100GBY901
50	Shadow			0150			723590
50	Sj Bali	93		0150			723590

CINGHIE TRASMISSIONE DENTATE SCOOTER
COGGED TRANSMISSION BELTS FOR SCOOTER



CC	MODELLO - MODEL	ANNO YEAR	DAYCO			RMS YOUR BEST PARTNER	RIFERIMENTO ORIGINALE OEM NUMBER
			CODICE ORIGINALE ORIGINAL CODE	CONFEZ. INDUSTR. INDUSTRIAL PACKING	RACING POWER PLUS KEVLAR	CODICE RMS RMS CODE	
			16 375 (----)				
50	Sky	97				0431	
50	Sv	95	0150				723590
50	Sxr	95	0150				723590
50	Vision Prima Serie	85-87	0130				723590
125	Chiocciola	00-06	0470	0479			23100KGF9010
125	Dylan	01-06	0470	0479			23100KGF9010
125	Pantheon 2T	98-02			0310		23100KFF900
125	Pantheon 4T	05-06	0470	0479			23100KGF9010
125	Pcx	10-12			1302		23100KWN901
125	Sh 125	01-08	0470	0479			23100KGF9010
125	Sh 125l	01-08	0470	0479			23100KGF9010
150	Chiocciola	00-06	0730	0739			23100KGG911
150	Dylan	01-06	0730	0739			23100KGG911
150	Pantheon 2T	98-02			0310		23100KFF900
150	Pantheon 4T	03-06	0730	0739			23100KGG911
150	Sh - @ - Pantheon - Dylan	01-08	0730	0739			23100KGG911
250	Cn 4T		0280	0289			H.23100KM1671
250	Foresight	98			0780		23100KFG641
250	Jazz	00-04			0780		23100KFG641
300	Sh	07-08			1020		23100KTW901
300	Sh 300l Abs	07>			1020		23100KTW901
ITALJET							
50	Pista 1-Bazooka 1/2 Reporter		0090			0091	9511190
50	Pista 2 Scoop 2/3 Yankee	92-93	0080	0089	0082	0081	3351015
50	Jet Set	02->	0250	0259	0252		210436864
50	Torpedo 2T - (Mot.Morini)	97-00	0120				338127227
50	Torpedo 2T (Mot.Piaggio)	01-03	0050		0052		210480852
50	Torpedo 4T	02->	0050		0052		210480852
50	Formula Air-Lc	94->	0120				338127227
50	Velocifero	93->	0170				337127204
125	Dragster	99->	0190				210434812
125	Torpedo	99-00	0260				210825059
125-150	Millenium	00->			0300		4871702090
125-150	Jet Set	01->		0389	0380		210487170
125-150	Jupiter	02->			0300		4871702090
125-150	Torpedo Mot.Leader	00-01		0389	0380		210487170
180	Dragster	99->			0200		210484497
250	Jupiter	01->		0659	0650		4711702092
KEEWAY F-ACT							
50	Hurricane Eu2 - Matrix		1150				
KYMCO							
50	Agility 2T R16	10	0330		0332		00107541
50	Agility 4T R12	07-08	0330		0332		00107541
50	Agility 4T R16	08-09	0330		0332		00107541
50	Agility R12	05	0330		0332		00107541
50	Agility Rs	09	0330		0332		00107541
50	Agility Rs Naked 2T	10	0330		0332		00107541
50	B&W	02	0330		0332		00107541
50	B&W Eu2	03	0330		0332		00107541
50	Cx	93	0210				00107006
50	Cx Super	94-97	0210				00107006
50	Dink 50 4T	07	0330		0332		00107541
50	Dink Classic Eu2	03	0330		0332		00107541
50	Dink Lc	98-02	0330		0332		00107541
50	Dj W	94-00	0210				00107006
50	Dj X	91-92	0210				00107006
50	Djy	93	0210				00107006
50	Like 2T	09	0330		0332		00107541
50	Like 4T	09	0330		0332		00107541
50	People	04	0330		0332		00107541
50	People	99-00	0330		0332		00107541
50	People Eu2	03	0330		0332		00107541
50	People Eu2	08	0330		0332		00107541
50	People S	05-08	0330		0332		00107541



CINGHIE TRASMISSIONE DENTATE SCOOTER

COGGED TRANSMISSION BELTS FOR SCOOTER

CC	MODELLO - MODEL	ANNO YEAR					RIFERIMENTO ORIGINALE OEM NUMBER
			CODICE ORIGINALE ORIGINAL CODE	CONFEZ. INDUSTR. INDUSTRIAL PACKING	RACING POWER PLUS KEVLAR	CODICE RMS RMS CODE	
			16 375 (---)				
50	People S 4T	06-08	0330		0332		00107541
50	Super 8	07	0330		0332		00107541
50	Super 8 2T	09	0330		0332		00107541
50	Super 8 4T	09	0330		0332		00107541
50	Super 9	00	0330		0332		00107541
50	Super 9 Sport Eu2	03-04	0330		0332		00107541
50	Top Boy	97-00	0330		0332		00107541
50	Vitality 2T	04	0330		0332		00107541
50	Vitality 4T	04	0330		0332		00107541
50	Yup	02	0330		0332		00107541
50	Yup Eu2	03	0330		0332		00107541
125	Agility 4T	06			0442	0441	00127541
125	Agility 4T Eu3	06-08			0442	0441	00127541
125	Agility Carry	11			0442		00127541
125	Agility R16	08-12			0442	0441	00127541
125	Agility Rs	09			0442	0441	00127541
125	B&W	00			0580		00127985
125	B&W Eu2	03-04			0580		00127985
125	Dink	97-98			0580		00127985
125	Dink Classic	02			0580		00127985
125	Dink Classic Eu2	03			0580		00127985
125	Dink Eu3	06-07			0580		00127985
125	Dink Lx	98-00			0580		00127985
125	Grand Dink	01-02			0580		00127985
125	Grand Dink Eu2	03-04			0580		00127985
125	Like	09			0442	0441	00127541
125	Like Lx	12			0442		00127541
125	Movie	99-00			0490		00127785
125	Movie Eu3	06-07			0442	0441	00127541
125	Movie XL	01			0442	0441	00127541
125	Movie XL Eu2	03-04			0442	0441	00127541
125	People	99-00			0442	0441	00127541
125	People Eu2	03			0442	0441	00127541
125	People Eu3	07-11			0442		00127541
125	People One I	13			0442	0441	00127541
125	People S	05			0442	0441	00127541
125	People S DD Eu3	07-08			0442	0441	00127541
125	Super 8	08-09			0442		00127541
125	Vivio	00			0490		00127785
150	Agility R16	08-09			0442	0441	00127541
150	Heroism	95-97			0490		00127785
150	Movie Eu3	06-07			0442	0441	00127541
200	Dink Classic	04			1130		00127021
200	Dink Eu3I	06-07			1140		00127099
250	B&W	00			0720		00127998
250	B&W Eu2	03			0720		00127998
250	Grand Dink	01-02			0720		00127998
250	Grand Dink Eu2	03-04			0720		00127998
250	Kxr	03-04			0720		00127998
250	Mxu	05			0720		00127998
250	People Lc	03-04			0820		00127543
250	People S	06			0820		00127543
250	People S 250I	07			0820		00127543
250	X Citing	05			0820		00127543
250	Yup	03			0720		00127998
300	K-Xct I	12			1402		00123375
300	K-Xct I Abs	14			1402		00123375
300	Maxxer	05-06			0720		00127998
300	Mxu	05-06			0720		00127998
300	Mxu R	10			0720		00127998
300	People Gti Abs	12			1402		00123375
300	People S 300I	08			0820		00127543
500	X Citing	05			0880		00127038
500	X Citing 500 R	09			0880		00127038

CINGHIE TRASMISSIONE DENTATE SCOOTER

COGGED TRANSMISSION BELTS FOR SCOOTER



CC	MODELLO - MODEL	ANNO YEAR	DAYCO			RMS YOUR BEST PARTNER	RIFERIMENTO ORIGINALE OEM NUMBER
			CODICE ORIGINALE ORIGINAL CODE	CONFEZ. INDUSTR. INDUSTRIAL PACKING	RACING POWER PLUS KEVLAR	CODICE RMS RMS CODE	
16 375 (----)							
500	X Citing 500I	06-08			0880		00127038
500	X Citing 500I R	07-08			0880		00127038
LEM							
50	Flash - ghibli - tornado		0090			0091	
MALAGUTI							
50	Ciak Mono Euro 2-2.2.3.	03	0080	0089	0082	0081	71700500
50	Ciak Master 4T	05-06	0050		0052		41701400
50	Ciak master Euro 2	04-06	0080	0089	0082	0081	71701000
50	Ciak -Ciak Td	99-01	0080	0089	0082	0081	71700500
50	Centro SL	94-98	0080	0089	0082	0081	71700300
50	Centro base	93-94	0080	0089	0082	0081	71700300
50	Centro SL Kat	99-00	0080	0089	0082	0081	71700300
50	Crosser Cr1	95-98	0120				60323800
50	F10 Restyling Euro 2-2.3.	03-04	0110				71700100-600
50	F10 Jet Line	92-98	0110				71700100-600
50	F10 Restyling Euro 1	01-02	0110				71700100-600
50	F10 Kat	99-00	0110				71700100-600
50	F10 Restyling Euro 2	02-06	0110				71701300
50	F12 Phantom Restyling Euro 2-2.3	03-04	0080	0089	0082	0081	71700300
50	F12 Phantom Lc Restyling Euro 2-2.3	03-04	0080	0089	0082	0081	71700300
50	F12 Phantom Restyling Euro 2	02-06	0080	0089	0082	0081	71700300
50	F12 Phantom Lc Restyling	02	0080	0089	0082	0081	71700300
50	F12 Phantom Lc - aria	94-98	0080	0089	0082	0081	71700300
50	F12 Phantom Lc Restyling Euro 1	01-02	0080	0089	0082	0081	71700300
50	F12 Phantom Restyling Euro 1	01-02	0080	0089	0082	0081	71700300
50	F12 Phantom Lc Twin Disks	98	0080	0089	0082	0081	71700300
50	F12 Phantom Euro 1 - Lc aria	99-00	0080	0089	0082	0081	71700300
50	F12 Phantom Lc Restyling Euro 2	06	0080	0089	0082	0081	71701000
50	F12 R Aria	07-08	1150				
50	F15 Lc-Tds Restyling Euro 1	01	0080	0089	0082	0081	71700300
50	F15 Fire Fox Restyling Euro 2-2.3	03-04	0080	0089	0082	0081	71700300
50	F15 Fire Fox Euro 2	02-03	0080	0089	0082	0081	71700300
50	F15 Fire Fox Air Cooled	05-06	0080	0089	0082	0081	71701000
50	F15 Lc Restyling Euro 2	04-05	0080	0089	0082	0081	71701000
50	F15 Fire Fox	94-98	0080	0089	0082	0081	71700300
50	F15 Fire Fox Twin Disk e Special	98-99	0080	0089	0082	0081	71700300
50	F15 Fire Fox Twin Disk Digit Kat	98-00	0080	0089	0082	0081	71700300
50	Grizzly 4 Wheels	04-05	0110				71700100/71700600
50	Yesterday - Yesterday Euro	97-00	0110				71700100-600
100	F12 Phantom - Ciak	99-00			0390		60330200
125	Ciak Restyling Euro 2	03			0550		51700600
125	Ciak Master	04			0550		51700600
125	Ciak Master Euro 3	06			0550		51700600
125	Ciak	00-01			0550		51700600
125	F 18 Warrior	00-02			0580		51700300
125	Phantom Max	03			0300		71700900
125	Madison Restyling Euro 2	03-04			0300		71700700
125	Madison Restyling	02			0300		71700700
125	Madison 3	06		0389	0380		41701500
125	Madison	99-01			0300		71700700/900
125-160	Blog le	09	0730	0739			
125-160	Centro le	08-09	0730	0739			
125-160	Centro SL le	09	0730	0739			
150	Ciak Restyling Euro 2	03			0550		51700600
150	Ciak Master	04			0550		51700600
150	Ciak	00-02			0550		51700600
150	F 18 Warrior	00-02			0580		51700300
150	Madison T.	99-01			0300		71700700
180	Madison R.	01-02		0669	0660		41700300/700
200	Ciak Master Euro 2	06			0550		51700700
200	Madison S. Restyling	02		0669	0660		41700300/700
200	Madison S. Restyling Euro 2	03		0669	0660		41700700
200	Phantom Max	03		0669	0660		41700700
250	Madison 3	06	0810		0812		41700900



CINGHIE TRASMISSIONE DENTATE SCOOTER

COGGED TRANSMISSION BELTS FOR SCOOTER

CC	MODELLO - MODEL	ANNO YEAR	DAYCO			RMS YOUR BEST PARTNER	RIFERIMENTO ORIGINALE OEM NUMBER
			CODICE ORIGINALE ORIGINAL CODE	CONFEZ. INDUSTR. INDUSTRIAL PACKING	RACING POWER PLUS KEVLAR	CODICE RMS RMS CODE	
			16 375 (----)				
250	Madison RS Restyling	04	0810		0812		41700900
250	Madison S.	99-01		0659	0650		91700200
250	Phantom Max	04	0810		0812		41700900
250	Password - Password Eu 3	05-07			0560		71701100
500	Spider Max Gt - Gt Euro 3	04-06			0680		41701100
MBK							
50	Booster	01-04	0080	0089	0082	0081	5RNE76410000
50	Booster	90-91	0080	0089	0082	0081	5RNE76410000
50	Booster Naked	03	0080	0089	0082	0081	5RNE76410000
50	Booster Ng Eu1	99-00	0080	0089	0082	0081	5RNE76410000
50	Booster Road	94-95	0080	0089	0082	0081	5RNE76410000
50	Booster Rocket	97-98	0080	0089	0082	0081	5RNE76410000
50	Booster Spirit	96-98	0080	0089	0082	0081	5RNE76410000
50	Booster Spirit	99-00	0080	0089	0082	0081	5RNE76410000
50	Booster Spirit Eu2	02	0080	0089	0082	0081	5RNE76410000
50	Booster Spirit Eu2	02-03	0080	0089	0082	0081	5RNE76410000
50	Booster Track	96-98	0080	0089	0082	0081	5RNE76410000
50	Evolis	92-95	0110				3WF176410000
50	Fizz	94-95	0110				3WF176410000
50	Flipper	98-02	0080	0089	0082	0081	5RNE76410000
50	Flipper Eu2	03-04	0080	0089	0082	0081	5RNE76410000
50	Forte	94-96	0110				3WF176410000
50	Mach G Eu1	02-03	0080	0089	0082	0081	5RNE76410000
50	Mach G Eu2	02-04	0080	0089	0082	0081	5RNE76410000
50	New Sorriso	95-96	0410				3GF176410000
50	Nitro	97-04	0080	0089	0082	0081	5RNE76410000
50	Nitro Eu2	03	0080	0089	0082	0081	5RNE76410000
50	Ovetto - Eu1 - Eu2	97-04	0080	0089	0082	0081	5RNE76410000
50	Rs Booster Ng	95-03	0080	0089	0082	0081	5RNE76410000
50	Sorriso	91-95	0090				23Y176410000
50	Stunt	00-02	0080	0089	0082	0081	5RNE76410000
50	Target	91-95	0110				3WF176410000
125	Flame	95-99	0530				4CW176410200
125	Flame F	00	0530				4CW176410200
125	Flame R	96-99	0530				4CW176410200
125	Skyliner	03			0300		5NSE76410000
125-150	Doodo	00->			0300		5DS1764100
125-150	Thunder	01->			0300		5DS1764100
125-150	Skyliner	99->			0300		5DS1764100
180	Skyliner	03			0570		5XME76410000
250	Skyliner	00-03		0659	0650		5CG176410000
250	Skyliner Abs	03		0659	0650		5CG176410000
300	Kilibre	03			0560		5SEE76410000
PEUGEOT							
50	Buxy	94-97	0160	0169	0162	0161	729171
50	Elyseo	99	0160	0169	0162	0161	729171
50	Elystar Tsdì	03-05	0160	0169	0162	0161	729171
50	Jet Force	03	0160	0169	0162	0161	729171
50	Ludix 10 One	04	0160	0169	0162	0161	729171
50	Ludix 10 Sp Blaster	05-06	0160	0169	0162	0161	729171
50	Ludix 10 Trend - Snake	04	0160	0169	0162	0161	729171
50	Ludix 14 Classic	04	0160	0169	0162	0161	729171
50	Ludix 14 Elegant	04	0160	0169	0162	0161	729171
50	Metal-X	02	0160	0169	0162	0161	729171
50	Sc Metropolis Lm-Sxlm	91	0140			0141	706618
50	Speedake	95-97	0160	0169	0162	0161	729171
50	Speedfight 2 Aria	05-06	0160	0169	0162	0161	729171
50	Speedfight 2 Lc-Silversport	05-06	0160	0169	0162	0161	729171
50	Speedfight Acqua	97-98	0160	0169	0162	0161	729171
50	Speedfight Aria	97-98	0160	0169	0162	0161	729171
50	Speedfight Aria Catalitico	99	0160	0169	0162	0161	729171
50	Squab	95-97	0160	0169	0162	0161	729171
50	Sv Geo	91-95	0150				723590
50	Trekker	98-00	0160	0169	0162	0161	729171

CINGHIE TRASMISSIONE DENTATE SCOOTER

COGGED TRANSMISSION BELTS FOR SCOOTER



CC	MODELLO - MODEL	ANNO YEAR	DAYCO			RMS YOUR BEST PARTNER	RIFERIMENTO ORIGINALE OEM NUMBER
			CODICE ORIGINALE ORIGINAL CODE	CONFEZ. INDUSTRIAL PACKING	RACING POWER PLUS KEVLAR	CODICE RMS RMS CODE	
			16 375 (----)				
50	Trk2 Wrc	04-06	0160	0169	0162	0161	729171
50	Vivacity	99	0160	0169	0162	0161	729171
50	Vivacity Catalitico	99-02	0160	0169	0162	0161	729171
50	Vivacity Vsx-Xr	02-04	0160	0169	0162	0161	729171
50	X-Fight	00	0160	0169	0162	0161	729171
50	Xrace	03	0160	0169	0162	0161	729171
50	Zenith L	94-96	0150				723590
50	Zenith Ln-Ls	97-98	0130				723590
50	Zenith Ln-Ls	97-98	0150				723590
50	Zenith N	97-98	0150				723590
125	Elyseo	99-00			0420		737830
125	Elyseo 125-150	01			0420		737830
125	Elystar	02-03			0420		737830
125	Jet Force	03-04			0420		737830
150	Elyseo	01->			0420		737830
150	Elystar	02->			0420		737830
250	SV	01->			0780		
250	Geopolis				0790		
250	Satelis				0810		
500	Satelis				0680		
PGO							
50	Big max		1120				
50	Motore Morini		0170				
PIAGGIO SCOOTER							
50	Diesis	01	0250	0259	0252		436864
50	Fly 2T	10	0060	0069			82712R
50	Fly 2T	05-07	0060	0069			82712R
50	Fly 4T	05-08	0840				842907
50	Fly 4T Mot Chn	06-07	0840				842907
50	Free	92-94	0010	0019	0012		430728
50	Free Delivery	00-01	0250	0259	0252		436864
50	Free Fl	95-02	0010	0019	0012		430728
50	Free Fl	95-02	0250	0259	0252		436864
50	Liberty	97-05	0060	0069			82712R
50	Liberty 2T	06-08	0060	0069			82712R
50	Liberty 2T Rst	04	0060	0069			82712R
50	Liberty 2T Sport	06-08	0060	0069			82712R
50	Liberty 4T	05-08	0060	0069			82712R
50	Liberty 4T	00-02	0060	0069			82712R
50	Liberty 4T Delivery Tnt	09	0060	0069			82712R
50	Liberty 4T Rst	04	0060	0069			82712R
50	Liberty 4T Sport	06-08	0060	0069			82712R
50	Liberty Moc 2T	09	0060	0069			82712R
50	Liberty Moc 4T & Elle	09-10	0060	0069			82712R
50	Liberty Ptt Eu2	04-05	0060	0069			82712R
50	Liberty	-				0061	
50	Nrg	94-96	0010	0019	0012		430728
50	Nrg Extreme	99-00	0250	0259	0252		436864
50	Nrg Mc3	01-04	0250	0259	0252		436864
50	Nrg Power Dd	05-09	0250	0259	0252		436864
50	Nrg Power Dd Serie Spece	07-08	0250	0259	0252		436864
50	Nrg Power Dt	06-08	0250	0259	0252		436864
50	Nrg Power Dt Serie Spece	07-08	0250	0259	0252		436864
50	Nrg Purejet	02-04	0250	0259	0252		436864
50	Nrg Rst Mc2	98	0250	0259	0252		436864
50	Nrg Rst Mc2	96-97	0010	0019	0012		430728
50	Ntt	95-96	0010	0019	0012		430728
50	Quartz	92-96	0040	0049	0042	0041	431190
50	Sfera	91-93	0030			0031	286175
50	Sfera Maquillage 2	94	0040	0049	0042	0041	431190
50	Sfera Rst	95-97	0040	0049	0042	0041	431190
50	Typhoon	01-09	0250	0259	0252		436864
50	Vespa Et2	97-05	0040	0049	0042	0041	431190
50	Vespa Et2 Iniezione	97-00	0050		0052	0051	82645R



CINGHIE TRASMISSIONE DENTATE SCOOTER

COGGED TRANSMISSION BELTS FOR SCOOTER

CC	MODELLO - MODEL	ANNO YEAR					RIFERIMENTO ORIGINALE OEM NUMBER
			CODICE ORIGINALE ORIGINAL CODE	CONFEZ. INDUSTR. INDUSTRIAL PACKING	RACING POWER PLUS KEVLAR	CODICE RMS RMS CODE	
			16 375 (---)				
50	Vespa Et4	00-05	0050		0052	0051	82645R
50	Vespa Lx 2T	05-08	0050		0052	0051	82645R
50	Vespa Lx 2T FI	09	0050		0052	0051	82645R
50	Vespa Lx 2T Touring	10	0050		0052	0051	82645R
50	Vespa Lx 4T	05-08	0050		0052	0051	82645R
50	Vespa Lx 4T-4V	09	0050		0052	0051	82645R
50	Vespa Lx 4T-4V Touring	10	0050		0052	0051	82645R
50	Vespa Lxv 2T	06-08	0050		0052	0051	82645R
50	Vespa Lxv 2T Navy	08	0050		0052	0051	82645R
50	Vespa S 2T & College	07-10	0050		0052	0051	82645R
50	Vespa S 4T-4V	08-09	0050		0052	0051	82645R
50	Zip	00-04	0050		0052	0051	82645R
50	Zip	92-93	0030			0031	286175
50	Zip	95-96	0040	0049	0042	0041	431190
50	Zip 2T	08-09	0050		0052	0051	82645R
50	Zip 4T	00-08	0050		0052	0051	82645R
50	Zip Bimodale	94-97	0040	0049	0042	0041	431190
50	Zip Fast Raider	93-94	0040	0049	0042	0041	431190
50	Zip Fast Raider Rst	96-97	0040	0049	0042	0041	431190
50	Zip Rst	96-99	0040	0049	0042	0041	431190
50	Zip Sp	01-04	0050		0052	0051	82645R
50	Zip Sp	96-00	0040	0049	0042	0041	431190
50	Zip Sp Eu2	06-09	0050		0052	0051	82645R
100	Zip 4T	06-08	0050		0052	0051	82645R
125	Beverly	01-03			0600		842009
125	Beverly Eu3	07-08			0600		842009
125	Beverly Eu3 Mic	07			0600		842009
125	Beverly Eu3 Sport	07-08			0600		842009
125	Beverly Rst	04-07			0600		842009
125	Beverly Tourer Eu3	08-09			0600		842009
125	Carnaby	07-09			0600		842009
125	Fly	05-07		0389	0380		841213
125	Fly Eu3	07-08		0389	0380		841213
125	Hexagon	94-97			0200		431258
125	Hexagon Gtx	00		0389	0380		841213
125	Hexagon Lx4	98-99	0260				825059
125	Hexagon Lx-Lxt	98-99			0200		431258
125	Liberty	01-02		0389	0380		841213
125	Liberty	98-00	0260				825059
125	Liberty 4T	06-07		0389	0380		841213
125	Liberty 4T Eu3	07-08		0389	0380		841213
125	Liberty 4T Eu3 Delivery	08		0389	0380		841213
125	Liberty 4T Sport Eu3	06-08		0389	0380		841213
125	Liberty Moc 4T & Elle	09-10		0389	0380		841213
125	Liberty Rst	04-05		0389	0380		841213
125	Liberty Rst Ptt	05-06		0389	0380		841213
125	Liberty Sport	06		0389	0380		841213
125	Mp3	07-08		0389	0380		841213
125	Mp3 Ibrido	09		0389	0380		841213
125	Mp3 Ie	08-09		0389	0380		841213
125	Sfera Ii Serie	95-97	0070				475847
125	Skipper	94-97	0190				434812
125	Skipper 4T	00-02		0389	0380		841213
125	Skipper I Serie	94-97			0200		431258
125	Skipper Lx	98-99	0190				434812
125	Super Hexagon Gtx 12"	01-02		0389	0380		841213
125	Vespa Et4	96-98	0070				475847
125	Vespa Et4	99-02		0389	0380		841213
125	Vespa Granturismo	03-07		0389	0380		841213
125	Vespa Granturismo Eu3	06-07		0389	0380		841213
125	Vespa Gts 4T Ie Super	09		0389	0380		841213
125	Vespa Gts Eu3	07-09		0389	0380		841213
125	Vespa Gtv	07-08		0389	0380		841213
125	Vespa Gtv 4T Navy Eu3	08		0389	0380		841213

CINGHIE TRASMISSIONE DENTATE SCOOTER

COGGED TRANSMISSION BELTS FOR SCOOTER





CC	MODELLO - MODEL	ANNO YEAR	DAYCO			RMS YOUR BEST PARTNER	RIFERIMENTO ORIGINALE OEM NUMBER
			CODICE ORIGINALE ORIGINAL CODE	CONFEZ. INDUSTR. INDUSTRIAL PACKING	RACING POWER PLUS KEVLAR	CODICE RMS RMS CODE	
			16 375 (----)				
125	Vespa Lx	05-06		0389	0380	841213	
125	Vespa Lx 4T FI	09		0389	0380	841213	
125	Vespa Lx Eu3	06-08		0389	0380	841213	
125	Vespa Lx Eu3 Ie	09		0389	0380	841213	
125	Vespa Lx Touring	10		0389	0380	841213	
125	Vespa Lxv 4T Eu3	06-09		0389	0380	841213	
125	Vespa Lxv 4T Navy Eu3	08		0389	0380	841213	
125	Vespa Lxv Ie 4T	10		0389	0380	841213	
125	Vespa S 4T Eu3	07-08		0389	0380	841213	
125	Vespa S 4T Ie & College	09-10		0389	0380	841213	
125	X Evo	07		0389	0380	841213	
125	X7 Eu3	08		0389	0380	841213	
125	X7 Evo Ie Eu3	09		0389	0380	841213	
125	X8	04-06		0389	0380	841213	
125	X8 Premium Eu2	06		0389	0380	841213	
125	X8 Premium Eu3	06-07		0389	0380	841213	
125	X8 Street Eu2	06-07		0389	0380	841213	
125	X9	01-02		0389	0380	841213	
125	X9 Evolution	03-06		0389	0380	841213	
125	X9 Evolution Eu3	07		0389	0380	841213	
125	Zip	00-02		0389	0380	841213	
150	Fly	05-07		0389	0380	841213	
150	Fly Eu3	08		0389	0380	841213	
150	Liberty 4T Eu3	08		0389	0380	841213	
150	Liberty 4T Sport Eu3	08		0389	0380	841213	
150	Liberty Moc 4T	09		0389	0380	841213	
150	Vespa Lx	05-06		0389	0380	841213	
150	Vespa Lx 4T FI	09		0389	0380	841213	
150	Vespa Lx Eu3	06-08		0389	0380	841213	
150	Vespa Lx Eu3 Ie	09		0389	0380	841213	
150	Vespa Lx Touring	10		0389	0380	841213	
150	Vespa S 4T	08-09		0389	0380	841213	
150	Vespa S 4T Ie & College	09-10		0389	0380	841213	
150	X8 Street Eu2	06-08		0389	0380	841213	
180	Hexagon Gtx	00		0669	0660	840908	
180	Super Hexagon Gtx 12'''	01-02		0669	0660	840908	
180	X9 Amalfi	00-03		0669	0660	840908	
200	Beverly	01-03			0690	842011	
200	Carnaby	07-08			0690	842011	
200	Liberty	06		0669	0660	840908	
200	Liberty 4T Eu3	07-08		0669	0660	840908	
200	Liberty 4T Sport Eu3	06-07		0669	0660	840908	
200	Liberty Rst	04		0669	0660	840908	
200	Liberty Sport	06		0669	0660	840908	
200	Vespa Granturismo	06-07		0669	0660	840908	
200	X8	05-07		0669	0660	840908	
200	X9	02-03		0669	0660	840908	
200	X9 Evolution	03		0669	0660	840908	
250	Beverly	06-07			0790	841851	
250	Beverly Cruiser	07-09			0790	841851	
250	Beverly Eu3 Mic	07			0790	841851	
250	Beverly Ie Eu3	06-08			0790	841851	
250	Beverly Rst	04-05			0790	841851	
250	Beverly Sport	06-08			0790	841851	
250	Beverly Tourer Eu3	08-09			0790	841851	
250	Carnaby	08			0790	841851	
250	Mp3	06-08	0810		0812	843963-82941R	
250	Mp3 Lt - Mp3 Mic	08-09	0810		0812	843963-82941R	
250	Vespa Gt 60 Eu3	06-07	0810		0812	843963-82941R	
250	Vespa Gts	05-13	0810		0812	843963-82941R	
250	Vespa Gtv	06-09	0810		0812	843963-82941R	
250	Vespa Gtv 4T Navy Eu3	07	0810		0812	843963-82941R	
250	X7 Eu3	08	0810		0812	843963-82941R	
300	Beverly Rst 4T 4V Ie Eu3	10			0790	841851	



CINGHIE TRASMISSIONE DENTATE SCOOTER

COGGED TRANSMISSION BELTS FOR SCOOTER

CC	MODELLO - MODEL	ANNO YEAR					RIFERIMENTO ORIGINALE OEM NUMBER
			CODICE ORIGINALE ORIGINAL CODE	CONFEZ. INDUSTR. INDUSTRIAL PACKING	RACING POWER PLUS KEVLAR	CODICE RMS RMS CODE	
			16 375 (----)				
300	Beverly Tourer Eu3	09-10			0790	841851	
300	Carnaby Cruiser	09			0790	841851	
300	Mp3 4T 4V le ERL Ibrido	10-13	0810		0812	843963-82941R	
300	Mp3 4T 4V le Lt Ibrido	10-11	0810		0812	843963-82941R	
300	Mp3 le Lt	10-11	0810		0812	843963-82941R	
300	Mp3 le Lt le Lt Sport	11-13	0810		0812	843963-82941R	
300	Mp3 le Lt Touring	11-12	0810		0812	843963-82941R	
300	Mp3 le Mic	10-11	0810		0812	843963-82941R	
300	Mp3 le Touring	11-12	0810		0812	843963-82941R	
300	Mp3 Yourban ERL	11	0810		0812	843963-82941R	
300	Mp3 Yourban Lt ERL	11-12	0810		0812	843963-82941R	
300	Vespa Gts le	12-13	0810		0812	843963-82941R	
300	Vespa Gts le Touring	11-12	0810		0812	843963-82941R	
300	Vespa Gts Super	08-14	0810		0812	843963-82941R	
300	Vespa Gts Super Sport	10-13	0810		0812	843963-82941R	
300	Vespa Gtv 4T 4V le	10-13	0810		0812	843963-82941R	
300	Vespa Gtv Via Montenapoleone	10	0810		0812	843963-82941R	
300	X7 Evo le Eu3	09-10	0810		0812	843963-82941R	
400	Beverly Eu3	06-07			0680	832738	
400	Beverly Tourer Eu3	08-09			0680	832738	
400	Mp3	07-08			0680	832738	
400	Mp3 Lt	09			0680	832738	
400	Mp3 Mic	08-09			0680	832738	
400	X Evo	07-09			0680	832738	
400	X8 Eu3	06-08			0680	832738	
500	Beverly	02-06			0680	832738	
500	Beverly Eu3	06-08			0680	832738	
500	X9 Evolution	03-07			0680	832738	
500	X9 Evolution Abs	06-07			0680	832738	
SCOOTER CINESI							
50	Scooter carter corto	00			1211		
50	Scooter carter lungo	00			1231		
125	Scooter	00			1231		
150	Scooter	00			1231		
SUZUKI							
50	Address	92-95	0220			27601-09E00-000	
50	Katana V-Y	97-00	0320		0321	27601-06F01-000	
50	Street Magic	98	0320		0321	27601-06F01-000	
50	Zillion	99	0320		0321	27601-06F01-000	
250	Burgman K3-K6	03-06			0700	27601-14F11-000	
250	Burgman W-K2	98-02			0700	27601-14F11-000	
400	An Burgman X-K2	99-02			0710	0713 27601-15F03-000	
400	Burgman K7-K9	07-16			0830	27601-05H00-000	
SYM							
50	Jet	99-01	1060			1B01T5201	
50	Jet Euro X Eu2	03-07	1060			1B01T5201	
50	Jet Sportx	06-07	1060			1B01T5201	
50	Jungle	00	1060			1B01T5201	
50	Mask	00-01	1060			1B01T5201	
50	Mask Eu2	03-04	1060			1B01T5201	
50	Mio	06-09	1170			1B01A1A01	
50	Red Devil	99	1060			1B01T5201	
100	Cinderella	99-01	1190			1B01A3101	
125	Hd Eu2	03-04			1090	1B01HHB01	
125	Hd Eu3	07-08			1090	1B01HHB01	
125	Hd Evo	05-06			1090	1B01HHB01	
125	Hd Evo Eu3	07-10			1090	1B01HHB01	
125	Hd Evo Tamburo Eu3	08			1090	1B01HHB01	
125	Joymax Gts	06-07			1080	1B01HNA01	
125	Joyride	01-02			1080	1B01HNA01	
125	Joyride Eu2	03-04			1080	1B01HNA01	
125	Joyride Eu2	05-06			1080	1B01HNA01	
125	Joyride Eu3	07			1080	1B01HNA01	
125	Joyride Evo	09-14			1080	1B01HNA01	

CINGHIE TRASMISSIONE DENTATE SCOOTER

COGGED TRANSMISSION BELTS FOR SCOOTER



CC	MODELLO - MODEL	ANNO YEAR	DAYCO			RMS YOUR BEST PARTNER	RIFERIMENTO ORIGINALE OEM NUMBER
			CODICE ORIGINALE ORIGINAL CODE	CONFEZ. INDUSTRIAL PACKING	RACING POWER PLUS KEVLAR	CODICE RMS RMS CODE	
			16 375 (----)				
150	Attila	00-01			1030		1B01H7A01
150	Joyride	01-02			1070		1B01H9A01
180	Track Runner	06-07			1200		1B01RA101
200	Hd Eu2	03-04			1100		1B01HHA01
200	Hd Eu3 I	07			1100		1B01HHA01
200	Hd Evo Eu2	05-06			1100		1B01HHA01
200	Hd Evo Eu3 I	07			1100		1B01HHA01
200	Hd Evo I Eu3	10			1100		1B01HHA01
200	Hd Evo I Tamburo Eu3	08			1100		1B01HHA01
200	Joyride	03			1070		1B01H9A01
200	Joyride Eu2	03-04			1070		1B01H9A01
200	Joyride Eu2	05-06			1070		1B01H9A01
250	Gts	07-08			1110		1B01HMA01
250	Joymax	06-07			1110		1B01HMA01
250	Joymax Eu3 I	07			1110		1B01HMA01
YAMAHA							
50	Bw'S	03-04	0080	0089	0082	0081	5RNE76410000
50	Aerox	01-10	0080	0089	0082	0081	5RNE76410000
50	Aerox Eu2	03	0080	0089	0082	0081	5RNE76410000
50	Aerox R	99-00	0080	0089	0082	0081	5RNE76410000
50	Axis	95-96	0110				3WF176410000
50	Breeze	94-95	0110				3WF176410000
50	Bw'S	04-10	0080	0089	0082	0081	5RNE76410000
50	Bw'S Bump	97-98	0080	0089	0082	0081	5RNE76410000
50	Bw'S Naked	03-04	0080	0089	0082	0081	5RNE76410000
50	Bw'S Naked	09	0080	0089	0082	0081	5RNE76410000
50	Bw'S Next Generation	97-05	0080	0089	0082	0081	5RNE76410000
50	Bw'S Next Generation Cat.	99-00	0080	0089	0082	0081	5RNE76410000
50	Bw'S Original	97-02	0080	0089	0082	0081	5RNE76410000
50	Bw'S Original Eu2	03	0080	0089	0082	0081	5RNE76410000
50	Bw'S Original Eu2	02	0080	0089	0082	0081	5RNE76410000
50	Bw'S Original Eu2	02	0080	0089	0082	0081	5RNE76410000
50	Ct S	90-95	0090				23Y176410000
50	Ct Ss	92-95	0090				23Y176410000
50	Jog R	02	0080	0089	0082	0081	5RNE76410000
50	Jog R	06-10	0080	0089	0082	0081	5RNE76410000
50	Jog R Eu2	02-05	0080	0089	0082	0081	5RNE76410000
50	Jog Z	95	0410				3GF176410000
50	Neo'S	97-10	0080	0089	0082	0081	5RNE76410000
50	Neo'S Eu2	02-03	0080	0089	0082	0081	5RNE76410000
50	Slider	00-02		0089	0082	0081	5RNE76410000
50	Spy	95-98		0089	0082	0081	5RNE76410000
50	Why - Eu1 - Eu2	98-05		0089	0082	0081	5RNE76410000
100	Ya Aerox - Bw's - Yn Neo's	99-02	0620				4VP176410000
125	Cygnus	95-98	0530				4CW176410200
125	Cygnus R	97-03	0530				4CW176410200
125	Majesty	03-09			0300		5NSE76410000
125	X-City	08			0800		1B9E76410000
125	X-Max	06-10			0800		1B9E76410000
150	Maxster - Majesty - Teo's	00-02			0300		5DS176410000
180	Majesty	03-06			0570		5XME76410000
250	Majesty	96-03		0659	0650		5CG176410000
250	Majesty Abs	03		0659	0650		5CG176410000
250	Majesty Dx	98-99		0659	0650		5CG176410000
250	X-Max	05-12			0560		5SEE76410000
250	X-Cty	09-12			0560		5SEE76410000
300	Versity	03-06			0560		5SEE76410000
400	Majesty	04-06			0770		5RU176410000



CINGHIE TRASMISSIONE DENTATE SCOOTER COGGED TRANSMISSION BELTS FOR SCOOTER

TABELLA CINGHIE TRASMISSIONE IN ORDINE DI MISURA - ORDER BY LENGHT

Codice RMS RMS CODE	L	S	A	MARCA BRAND	Codice RMS RMS CODE	L	S	A	MARCA BRAND	Codice RMS RMS CODE	L	S	A	MARCA BRAND
16 375 0130	652	15,3	8	DAYCO	16 375 0580	816	18,8	9,4	DAYCO	16 375 0820	996	24	11,5	DAYCO
16 375 0170	664	16,5	8	DAYCO	16 375 0630	820	18	8,2	DAYCO	16 375 0560	1006	22,8	11,5	DAYCO
16 375 0220	665	16	8	DAYCO	16 375 0180	823	16,9	8	DAYCO	16 375 0830	1011	27,7	14,2	DAYCO
16 375 1211	669	18	8	DAYCO	16 375 0390	823	17,8	9	DAYCO	16 375 1402	1011	24,6	15	DAYCO
16 375 0210	670	18	9,7	DAYCO	16 375 0060	826	18,5	8	DAYCO	16 375 1020	1024	26,7	14	DAYCO
16 375 1000	687	17,9	9,4	DAYCO	16 375 0660	826	22	13	DAYCO	16 375 0880	1025	8,7	14,8	DAYCO
16 375 1170	688	18,1	8	DAYCO	16 375 0190	828	22	9,5	DAYCO	16 375 0680	1036	28	14,2	DAYCO
16 375 0150	700	18	8	DAYCO	16 375 0520	828	16,3	8	DAYCO					
16 375 1190	722	17,4	9	DAYCO	16 375 0300	832	22,2	9,6	DAYCO					
16 375 0040	724	17,5	8	DAYCO	16 375 0420	832	18,5	9,6	DAYCO					
16 375 1231	729	18	9,2	DAYCO	16 375 0200	834	22	9,5	DAYCO					
16 375 0140	730	15	8	DAYCO	16 375 0570	834	22	9,7	DAYCO					
16 375 0052	732	18,5	8	DAYCO	16 375 1070	834	18,7	9,5	DAYCO					
16 375 0030	734	17	8	DAYCO	16 375 0810	835	22,6	14	DAYCO					
16 375 0070	736	18	8	DAYCO	16 375 0812	835	22,5	13	DAYCO					
16 375 0332	743	18	8	DAYCO	16 375 1221	835	20	9,7	RMS YOUR BEST PARTNER					
16 375 1200	743	18,8	9	DAYCO	16 375 1302	836	21,7	10	DAYCO					
16 375 1120	746	17,7	8,5	DAYCO	16 375 0280	845	22,5	10	DAYCO					
16 375 0080	747	16,5	8	DAYCO	16 375 0289	845	22,5	10	DAYCO					
16 375 1060	747	17,5	9	DAYCO	16 375 0260	848	18	8	DAYCO					
16 375 0840	756	18	8	DAYCO	16 375 0431	860	15	8	DAYCO					
16 375 0162	765	17,5	8	DAYCO	16 375 0650	872	23	11,5	DAYCO					
16 375 1030	768	19,3	9,5	DAYCO	16 375 0659	872	23	11,5	DAYCO					
16 375 0620	770	17,5	8	DAYCO	16 375 0700	893	22,7	11,5	DAYCO					
16 375 0530	778	22	9	DAYCO	16 375 0720	907	24	11	DAYCO					
16 375 0320	782	18,4	8	DAYCO	16 375 0470	916	22	10,5	DAYCO					
16 375 0410	785	16,6	8	DAYCO	16 375 0479	916	22	10,5	DAYCO					
16 375 0110	792	16,5	8	DAYCO	16 375 0770	916	29,8	15	DAYCO					
16 375 0090	793	15	8	DAYCO	16 375 0730	918	22,3	10	DAYCO					
16 375 0441	795	20	9,8	RMS YOUR BEST PARTNER	16 375 0739	918	22,3	10	DAYCO					
16 375 0442	795	20	9,8	DAYCO	16 375 0800	923	22	9,5	DAYCO					
16 375 0670	796	16,8	8	DAYCO	16 375 1110	923	23	10,5	DAYCO					
16 375 0550	800	20	9,6	DAYCO	16 375 0310	926	22,2	10,2	DAYCO					
16 375 1150	800	17,2	9	DAYCO	16 375 1090	930	19,5	9,5	DAYCO					
16 375 0012	804	17,5	8	DAYCO	16 375 0600	937	22,3	10,8	DAYCO					
16 375 0120	808	17	9	DAYCO	16 375 0710	938	22,7	15	DAYCO					
16 375 0250	811	18,5	8	DAYCO	16 375 0713	938	22,7	15	RMS YOUR BEST PARTNER					
16 375 1130	811	19,4	10	DAYCO	16 375 0690	940	22	13,5	DAYCO					
16 375 0380	814	22,5	10,2	DAYCO	16 375 1100	940	18,7	10	DAYCO					
16 375 0389	814	22,5	10,2	DAYCO	16 375 0780	946	23,3	11	DAYCO					
16 375 1080	815	19,7	9,3	DAYCO	16 375 0790	954	22,6	13,2	DAYCO					
16 375 1140	815	19,2	10	DAYCO										

LEGENDA MISURE - MEASURES LEGEND

L = Lunghezza Cinghia - Belt length

S = Spessore Cinghia - Belt tickness

A = Altezza dente - Tooth height



(Misure Fornite dal Costruttore - Measures from supplier)

CINGHIE TRASMISSIONE DENTATE SCOOTER

COGGED TRANSMISSION BELTS FOR SCOOTER



TABELLA CINGHIE TRASMISSIONE IN ORDINE DI CODICE - ORDER BY CODE

Codice RMS RMS CODE	L	S	A	MARCA BRAND	Codice RMS RMS CODE	L	S	A	MARCA BRAND	Codice RMS RMS CODE	L	S	A	MARCA BRAND
16 375 0012	804	17,5	8	DAYCO	16 375 0470	916	22	10,5	DAYCO	16 375 1060	747	17,5	9	DAYCO
16 375 0030	734	17	8	DAYCO	16 375 0479	916	22	10,5	DAYCO	16 375 1070	834	18,7	9,5	DAYCO
16 375 0040	724	17,5	8	DAYCO	16 375 0520	828	16,3	8	DAYCO	16 375 1080	815	19,7	9,3	DAYCO
16 375 0052	732	18,5	8	DAYCO	16 375 0530	778	22	9	DAYCO	16 375 1090	930	19,5	9,5	DAYCO
16 375 0060	826	18,5	8	DAYCO	16 375 0550	800	20	9,6	DAYCO	16 375 1100	940	18,7	10	DAYCO
16 375 0070	736	18	8	DAYCO	16 375 0560	1006	22,8	11,5	DAYCO	16 375 1110	923	23	10,5	DAYCO
16 375 0080	747	16,5	8	DAYCO	16 375 0570	834	22	9,7	DAYCO	16 375 1120	746	17,7	8,5	DAYCO
16 375 0090	793	15	8	DAYCO	16 375 0580	816	18,8	9,4	DAYCO	16 375 1130	811	19,4	10	DAYCO
16 375 0110	792	16,5	8	DAYCO	16 375 0600	937	22,3	10,8	DAYCO	16 375 1140	815	19,2	10	DAYCO
16 375 0120	808	17	9	DAYCO	16 375 0620	770	17,5	8	DAYCO	16 375 1150	800	17,2	9	DAYCO
16 375 0130	652	15,3	8	DAYCO	16 375 0630	820	18	8,2	DAYCO	16 375 1170	688	18,1	8	DAYCO
16 375 0140	730	15	8	DAYCO	16 375 0650	872	23	11,5	DAYCO	16 375 1190	722	17,4	9	DAYCO
16 375 0150	700	18	8	DAYCO	16 375 0659	872	23	11,5	DAYCO	16 375 1200	743	18,8	9	DAYCO
16 375 0162	765	17,5	8	DAYCO	16 375 0660	826	22	13	DAYCO	16 375 1211	669	18	8	RMS YOUR BEST PARTNER
16 375 0170	664	16,5	8	DAYCO	16 375 0670	796	16,8	8	DAYCO	16 375 1221	835	20	9,7	RMS YOUR BEST PARTNER
16 375 0180	823	16,9	8	DAYCO	16 375 0680	1036	28	14,2	DAYCO	16 375 1231	729	18	9,2	RMS YOUR BEST PARTNER
16 375 0190	828	22	9,5	DAYCO	16 375 0690	940	22	13,5	DAYCO	16 375 1302	836	21,7	10	DAYCO
16 375 0200	834	22	9,5	DAYCO	16 375 0700	893	22,7	11,5	DAYCO	16 375 1402	1011	24,6	15	DAYCO
16 375 0210	670	18	9,7	DAYCO	16 375 0710	938	22,7	15	DAYCO					
16 375 0220	665	16	8	DAYCO	16 375 0713	938	22,7	15	RMS YOUR BEST PARTNER					
16 375 0250	811	18,5	8	DAYCO	16 375 0720	907	24	11	DAYCO					
16 375 0260	848	18	8	DAYCO	16 375 0730	918	22,3	10	DAYCO					
16 375 0280	845	22,5	10	DAYCO	16 375 0739	918	22,3	10	DAYCO					
16 375 0289	845	22,5	10	DAYCO	16 375 0770	916	29,8	15	DAYCO					
16 375 0300	832	22,2	9,6	DAYCO	16 375 0780	946	23,3	11	DAYCO					
16 375 0310	926	22,2	10,2	DAYCO	16 375 0790	954	22,6	13,2	DAYCO					
16 375 0320	782	18,4	8	DAYCO	16 375 0800	923	22	9,5	DAYCO					
16 375 0332	743	18	8	DAYCO	16 375 0810	835	22,6	14	DAYCO					
16 375 0380	814	22,5	10,2	DAYCO	16 375 0812	835	22,5	13	DAYCO					
16 375 0389	814	22,5	10,2	DAYCO	16 375 0820	996	24	11,5	DAYCO					
16 375 0390	823	17,8	9	DAYCO	16 375 0830	1011	27,7	14,2	DAYCO					
16 375 0410	785	16,6	8	DAYCO	16 375 0840	756	18	8	DAYCO					
16 375 0420	832	18,5	9,6	DAYCO	16 375 0880	1025	8,7	14,8	DAYCO					
16 375 0431	860	15	8	DAYCO	16 375 1000	687	17,9	9,4	DAYCO					
16 375 0441	795	20	9,8	RMS YOUR BEST PARTNER	16 375 1020	1024	26,7	14	DAYCO					
16 375 0442	795	20	9,8	DAYCO	16 375 1030	768	19,3	9,5	DAYCO					

LEGENDA MISURE - MEASURES LEGEND

L = Lunghezza Cinghia - Belt length

S = Spessore Cinghia - Belt thickness

A = Altezza dente - Tooth height



(Misure Fornite dal Costruttore - Measures from supplier)

CINGHIE VARIE- VARIOUS BELTS

CINGHIE MISCELATORE SCOOTER - MIXER BELTS FOR SCOOTER MARCA MODELLO - TRADEMARK MODEL	RMS	DAYCO	CODICE ORIGINALE ORIGINAL CODE
GILERA: Dna-Easy Moving • Ice • Runner • Poggiali • FL • Purejet • Storm • Stalker-Typhoon • X • Xr PIAGGIO: Free Delivery 00-01 • Ntt 95-96 • Nrg 94-96 • Diesis 01 • Free 92-94 • FL 95-00 • Liberty 97-02 • Rst Mc2 96-98 • Mc3 01-02 • Nrg Extreme 99-00 • Purejet 02 • Quartz 92-96 • Fly 2T • Sfera Maquillage 2 94 • Sfera base 91-93 • Typhoon 01 • Vespa Et2 97-01 • Zip 00 • Base 92-96 • Rst 96-99 • Zip Fast Raider 93-94 • Zip Sp 96-02 Eu 1	50	16 377 0011	286162
GILERA: Typhoon-X-Xr • Runner Fx-Fxr PIAGGIO: Hexagon 125-150 • Lx-Lxt 125-180 • Skipper-Lx 125-150 • Skr City 80	125-180	16 377 0021	431370
CINGHIE INIETTORE SCOOTER - INJECTION BELTS FOR SCOOTER PIAGGIO: Vespa Et2 iniezione 5-98>	50	16 377 0040	480135
CINGHIE PIAGGIO APE - V-BELTS APE Ape Car P2-P3 78-85 • Mp P501-P601 78-96 • Tm P602 • 82-83 • Tm P703-P703V-FL2 84-01		16 373 0021	113256
CINGHIE TRASMISSIONE CICLOMOTORE PIAGGIO-V-BELTS MOPED Ciao monomarcia Mix Teen-Px FL Kat		16 373 0071	102905
Si-Si-FL2-Mix-Boss-Boxer-monomarcia		16 373 0041	124593
Si-Boss-Boxer con variatore		16 373 0031	122192
Bravo mono		16 373 0061	130938
Bravo con variatore		16 373 0051	130937



GIRANTI FRIZIONE MAXI SCOOTER
MAXI SCOOTER CLUTCH ASSY

APRILIA

10 036 0010 

125: Mojito Retrò • Custom 99-01
(R.O. AP8550407)



10 036 0030 

125: Sr 99-01
(R.O. AP8550113)



10 036 0130 

125: Leonardo 99-01 • Leonardo St 01-04 •
Scarabeo Mot. Rotax 99-03
(R.O. AP0259739)



10 036 0380 

125: Atlantic Eu3 06-12 • Mojito 03-08
Sport City Street 12 • Sport City Cube 08-10
Sport City One 4T Eu3 >25-08-09
Sport City Eu3 06-08 • Sr Max 11
Scarabeo Light 07-08
(R.O. CM144005
B013246)



10 036 0520 

125: Sr Motard 12-13 • Sport City One 4T Eu3
25-08-09>
(R.O. CM1612015)



10 036 0140 

150: Leonardo 96-01 • Leonardo St 01-04
• Scarabeo Mot. Rotax 99-03
(R.O. AP0259738)



10 036 0330 

200: Atlantic 03-05 • Scarabeo 03 • Scarabeo
Eu3 06-07 • Sport City 04-06 • Sport City Cube
08-10 • Sport City Eu3 06-08
(R.O. CM1440075)



10 036 0410 

250: Atlantic 03-05 • Atlantic Eu3 06-08 • Sca-
rabeo 04-06 • Scarabeo Light 06-08 • Sport City
Cube 08-10 • Sport City Eu3 06-08
300: Scarabeo Light 09 • Sport City Cube 08-10
(R.O. 8722515)



10 036 0420 

400: Scarabeo Light 06-08
(R.O. 8488445)



10 036 0310 

500: Atlantic Sprint 05-08
• Scarabeo Light 06-08
(R.O. 8405775)



10 036 0320 

500: Atlantic 01-04
(R.O. AP8560053)





BENELLI

10 036 0020 

125: Adiva 01-02
(R.O. R13440631A0)



10 036 0060 

125: Velvet 99-01 • Velvet Touring 02-03
(R.O. R16141031A0)



DERBI

10 036 0380 

125: Boulevard Eu3 04-07 • Gp1 Eu2 06
Rambla 08-09 • Rambla E3 2 Ver 08
150: Boulevard Eu 3 04-07
(R.O. CM144005)



10 036 0020 

125: Boulevard 02-04
150: Boulevard 02-04
(R.O. 829184)



10 036 0520 

125: Boulevard 4T Eu3 08-12 • Sonar 4T 09-11
Variant Sport 4T E3 12
150: Sonar 4T 09
(R.O. CM1612015)



10 036 0050 

200: Boulevard 05
(R.O. CM144012)



10 036 0410 

250: Rambla 08
(R.O. 8722515)



GILERA

10 036 0030 

125: Runner Fx • Fxr 97-02
Typhoon 95-98 • Typhoon X • Xr 99-00
(R.O. 485442)



10 036 0380 

125: Runner 4T St Eu3 08-12 • Runner Vx 4T
Eu3 06-07 • Vx Race 06 • Vx Sc 06-07 • Vx 02-06
Nexus Eu3 07-08 • Nexus Eu3 le 08-10
(R.O. CM144005)

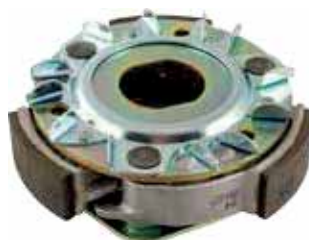

10 036 0020 

125: Dna 01 • Runner Vx • Vxr 00-01
(R.O. 829184)





GIRANTI FRIZIONE MAXI SCOOTER
MAXI SCOOTER CLUTCH ASSY

GILERA

10 036 0040 

180: Runner Fx • Fxr 97-02
(R.O. 4837595)



10 036 0050 

180: Dna 01 • Runner Vx • Vxr 00-01
(R.O. 827394)



10 036 0330 

200: Runner Vxr 05-06 • Runner Vxr 4T St Eu3
08 • Runner Vxr Eu3 07 • Runner Vxr Race 06 •
(R.O. AP8575014)



10 036 0410 

250: Nexus Eu3 06
(R.O. CM1440175)



10 036 0310 

500: Nexus Eu3 06-09
(R.O. 8405775)



HONDA

10 036 0160 

125: Chiocciola 00-06 • Dylan 01-06 • Nes 00-
07 • Sh 01-08 • Sh 125I 01-08
150: Chiocciola 00-06 • Dylan 01-06 • Nes 00-
07 • Sh 01-08 • Sh 150I 01-08



10 036 0161 

125: Chiocciola 00-06 • Dylan 01-06 • Nes 00-
07 • Sh 01-08 • Sh 125I 01-08
150: Chiocciola 00-06 • Dylan 01-06 • Nes 00-
07 • Sh 01-08 • Sh 150I 01-08



10 036 0100 

250: Foresight 98-00
300: Sh I 07-08



ITALJET

10 036 0010 

125: Torpedo 98-00
(R.O. 210483833)



10 036 0020 

125: Jet Set 4T • Torpedo (Mot. Leader) 00-03 •
(R.O. 210827981)



10 036 0040 

180: Dragster 99-03





KYMCO

10 036 0480 

50: Agility 4T R10 06-08 • Agility 4T R12 05-08 • Agility 4T R16 08-12
(R.O. 00105099)

10 036 0490 

50: B&W Eu2 03 • B&W 02 • Cx 93 • Dink Classic Eu2 03 • Dink Lc 98-02 • Dj W • Dj X • Dj Y • Fever 2X 99-00 • Fever 2X Eu2 03-04 • Maxxer 05 • Mxu 06-07 • People Eu2 03 • People S 05-08 • People S 4T 06-08 • People 04 • Super9 Eu2 03-04 • Super9 00 • Vitality 2T 04
(R.O. 00107100C)

10 036 0160 

10 036 0161 

125: Agility 4T Eu3 06-08 • Agility 4T 06 • Agility Carry 11 • Agility R16 08-12 • Agility Rs 09 • Downtown I 125 09 • Grand Dink Eu2 03-04 • Grand Dink 01-02 • Heroism 95-97 • K-Xct I 12-14 • Like Lx 12 • Like 09 • Movie Eu3 06-07 • Movie XL Eu2 03-04 • Movie XL 01 • Movie 99-00 • People Eu2 03 • People 99-00 • People Eu3 07-11 • People Eu3 08 • People Eu3 11 • People One I 13 • People S Dd Eu3 07-08 • People S 05 • Super 8 08-09 • Vivio 00 • **150:** Agility R16 08-09 • Heroism 95-97 • Movie Eu3 06-07 • **200:** Agility 200 I R16 10 • Agility I Plus 14 • Agility R16 12 • Like 2001 09 • Like Lx 12 • People S 2001 07 • People S 05
(R.O. 00127801)



10 036 0170 

125: B&W 00 • Dink 97-98 • Dink Classic 02 • Dink Classic Eu2 03 • Dink Lx 98-00 • Grand Dink 01-02 • Grand Dink Eu2 03-04
150: B&W 00 • Dink 97-98 • Dink Classic 02 • Dink Classic Eu2 03 • Dink Lx 98-00
(R.O. 127961)

10 036 0530 

125: Downtown I 09 • K-Xct I 12 • People Gti 10
125-150: B&W Eu 2 03-04
(R.O. 00122170)

10 036 0360 

200: Downtown 10 • People Gti 10-11 • Downtown Abs I 11 • Downtown I 11
250: B&W 00 • B&W Eu2 00-03 • Grand Dink 01-02 • Grand Dink Eu2 03-04 • People Lc 03-04 • People S 06 • People S I 07 • X Citing 05 • X Citing I 06-07 • Yup 03
300: People S I 08 • X Citing I 08 • X Citing I R 08-09 • Downtown 09 • Abs 10 • People Gti 10
(R.O. 127965)



MALAGUTI

10 036 0060 

125: Madison 99-01 • Madison R Rst 02
(R.O. 73503300)

10 036 0160 

10 036 0161 

125-150: Ciak 00-01 • Ciak Master 04 • Ciak Rst Eu2 03
(R.O. 53500200)

10 036 0090 

150: Madison T 99-01
(R.O. 73503600)





GIRANTI FRIZIONE MAXI SCOOTER

MAXI SCOOTER CLUTCH ASSY

MBK

10 036 0060 

125: Xq Thunder 01-02 • Yp Skyliner 98-02
(R.O. 5DSE66200000)



10 036 0090 

150: Xn Doodo 01-02 • Xq Thunder 01-02 • Yp Skyliner 00-02
(R.O. 5KDE66200000)



10 036 0070 

250: Yp Skyliner 00-03 • Yp Skyliner Abs 03
300: Xc Kilibre 03
(R.O. 5GM166200100)



PEUGEOT

10 036 0360 

125: Yp Skyliner 98-02 • Xq Thunder 01-02
(R.O. 5DSE66200000)



10 036 0300 

100: Elyseo 99-01 • Speedfight 97-00 • Vivacity 99-01 • X-Fight 00-01
(R.O. 754144)



10 036 0100 

250: Sv 01-02
(R.O. 754982)



PIAGGIO

10 036 0010 

125: Hexagon Lx4 98-99 • Liberty 98-00 • Sfera 95-97 • Vespa Et4 96-98
(R.O. 4838335)



10 036 0020 

125: Beverly 01-03 • X8 04 • X9 Evolution 03
(R.O. 829184)



10 036 0030 

125: Hexagon 94-97 • Hexagon Lx • Lxt 98-99 • Skipper 94-97 • Skipper Lx 98-99
150: Hexagon 94-97 • Skipper 94-97
(R.O. 485442)





PIAGGIO

10 036 0380 

125: Beverly Eu3 / Sport 07-08 • Beverly Rst 04-07 • Beverly Rst 4t 4V le Eu3 10-13 • Beverly Tourer Eu3 07-10 • Beverly Eu3 Mic 07 • Carnaby 07-10 • Fly Eu3 08-11 • Hexagon Gtx 00 • Liberty 4T Eu3 Delivery - Single 07-12 • Liberty 4T Eu3 Delivery - Tnt 08-09 • Liberty 01-02 • Liberty Rst 04-05 • Mp3 07-08 • Mp3 le Touring 11-12 • Mp3 Yourban ERL 11-12 • Mp3 Ibrido 09-10 • Mp3 le 08-09 • Skipper 4T 00-02 • Super Hexagon Gtx 12" 01-02 • Vespa Gts Eu3 07-12 • Vespa Gts 4T le Super 09-13 • Vespa Et4 99-02 • Vespa Gran Turismo / Eu3 03-07 • Vespa Gtv 07-08 • Vespa Gtv 4T Navy Eu3 08 • X Evo 07-12 • X10 4T 4V le Eu3 12-13 • X7 Eu3 08 • X7 Evo le Eu3 09-10 • X8 Premium Eu2/3 06-07 • X8 05-06 • X9 Evolution / Eu3 05-07 • X9 01-02 • Zip 00-02
150: Vespa Lx Eu3 le 09-11 • Vespa S4 le e College 09-12
(R.O. CM144005 - B013246)



10 036 0510 

125: Fly 4T 3V le Eu3 Lem 12 • Vespa 946 4T 3V Abs 13 • Vespa Lx 4T 3V le - Touring 12-13 • Vespa S4T 3V le 12
150: Vespa Lx 4T 3V le - Touring 12-13
(R.O. CM1672015)



10 036 0520 

125: Fly / Eu3 05-07 • Liberty 4T 06-07 • Liberty Eu3 07-08 • Liberty 4T Sport Eu3 06-08 • Liberty 4T 2V le Eu3 09-12 • Liberty Rst Ptt 05-11 • Liberty Sport 06 • Typhoon 4T 2V Eu3 10-11 • Vespa Lx 4T Eu3 Touring 10-11 • Vespa Lx 4T FL 09 • Vespa Lx Eu3 le 09-10 • Vespa Lx Eu3 06-08 • Vespa Lx 05-06 • Vespa Lx V le 4T 10-12 • Vespa Lxv 4T Eu3 06-09 • Vespa Lx 4T Navy Eu3 08 • Vespa S 4T Eu3 07-08 • Vespa S4T le e College 09-11 • X8 Street Eu2 06-07
150: Fly 05-07 • Fly Eu3 08-11 • Liberty Moc 4T Eu3 09-13 • Liberty 4T Eu3 08 • Liberty 4T Sport Eu3 08 • Vespa Lx Touring 10-12 • Vespa Lx 05-06 • Vespa Lx Eu3 06-08 • Vespa Lx 4T FL 09 • Vespa S 4T 08-09 • X8 Street Eu2 06-08
(R.O. CM1612015-CM144025)



10 036 0040 

180: Hexagon Lx • Lxt 98-99
(R.O. 4837595)



10 036 0050 

180: Hexagon Gtx 00 • S. Hexagon Gtx 12 01-02
200: Liberty 06 • Liberty 4T Eu3 07-08 • Liberty 4T Sport Eu3 06-07 • Liberty Rst 04 • Liberty Sport 06
(R.O. CM144012)



10 036 0330 

200: Beverly 01-03 • Carnaby 07-08 • Vespa Granturismo 06-07 • X8 05-07
(R.O. CM1440075)



10 036 0100 

250: X9 00-01
(R.O. 496302)



10 036 0410 

250: Beverly 06-07 • Beverly Cruiser 07-09 • Beverly Eu3 Mic 07 • Beverly le Eu3 06-08 • Beverly Rst 04-05 • Beverly Sport 06-08 • Beverly Tourer Eu3 08-09 • Carnaby 08 • Mp3 06-08 • Mp3 Lt 09 • Mp3 Mic 08-09 • Vespa Gt 60 Eu3 06-07 • Vespa Gts • Gts Abs 05-09 • Vespa Gtv 06-09 • Vespa Gtv 4T Navy Eu3 08 • X7 Eu3 08 • X8 Eu3 05-08 • X9 Evolution 06 • Xevo 07
300: Beverly 300 le Tourer 09 • Carnaby Cruiser 09 • Vespa Gts Super 08 • X7 Evo le Eu3 09
(R.O. 8722515)



10 036 0420 

400: Beverly Eu3 06-07 • Beverly Tourer Eu3 08-09 • Mp3 07-08 • X Evo 07-09 • X8 Eu3 06-08
(R.O. 8488445)





GIRANTI FRIZIONE MAXI SCOOTER
MAXI SCOOTER CLUTCH ASSY

PIAGGIO

10 036 0310

500: Beverly 02-06 • Beverly Cruiser 07-11 •
 Beverly Eu3 06-08 • X9 Evolution 06-07 • X9
 Evolution Abs 06-07
 (R.O. 8405775)



10 036 0320

500: X9 01-02
 (R.O. 826053)



SUZUKI

10 036 0370

125: Burgman K2 - K6 02-06
 (R.O. 2150120E60000)



10 036 0430

125: Burgman K7 - L0 07-10 • Burgman L1 11
 • Sixteen K8 - L0 08-10 • Sixteen L1 11
 (R.O. 21501-46G10-000)



10 036 0440

150: Sixteen K8 - L0 08-10 • Sixteen L1 11
 (R.O. 21501-46G20-000)



10 036 0450

200: Burgman 07-10
 (R.O. 21501-03H30-000)



10 036 0120

250: Burgman W - K2 98-02
 (R.O. 21501-14F02-000)



10 036 0110

400: Burgman K3 - K6 03-06 • Burgman X - K2
 99-02
 (R.O. 2150115F01000)



10 036 0460

400: Burgman 07-10
 (R.O. 21501-05H20-000)





SYM

10 036 0160 

10 036 0161 

125: Joyride Eu2 05-06 • Joyride Eu3 07
Joyride Evo 09

180: Track Runner 06-07
(R.O. 22300RA1000)



YAMAHA

10 036 0060 

125: Yp Majesty 98-02 • Xq Maxter 01-02
(R.O. 5DSE66200000)



10 036 0390 

125: Vpx-City 08 • Yp R X X-Max 06-09
(R.O. 1B9E66200000)



10 036 0090 

150: Xn Teos 01-02 • Xq Maxster 01-02 • Yp
Majesty 01-02
(R.O. 5KDE66200000)



10 036 0070 

250: Vp X City 07-10 • Yp R Black X X-Max 09
• Yp R X • Max 06-10
250: Majesty 2000 >03
300: Xc Versity 03-06
(R.O. 5GM166200100)



10 036 0350 

400: Yp Majesty 04-06
(R.O. 5RU166201000)



10 036 0400 

400: Yp Majesty 07-08 • Yp Majesty Abs 07-08
(R.O. 5RU166202000)





GIRANTI FRIZIONE RACING 50 CC
RACING CLUTCH ASSY 50 CC

10 036 0190 

RACING REGOLABILI SCOOTER 50
ADJUSTABLE SCOOTER 50 < 1998
Per motori **MINARELLI-YAMAHA**
Fino al 12/97 - Ø 105



10 036 0200 

RACING REGOLABILI SCOOTER 50
ADJUSTABLE SCOOTER 50 > 1998
Per motori **MINARELLI-YAMAHA 50** Dal '98
GILERA - PIAGGIO - Ø 107



10 036 0210 

Ø 105
RACING MASSE ALLEGGERITE
RACING LIGHT BRAKE SHOES
Per **MOTORI MINARELLI-YAMAHA**
< 1998



10 036 0220 

Ø 107
RACING MASSE ALLEGGERITE
RACING LIGHT BRAKE SHOES
Per motori **MINARELLI-YAMAHA 50**
GILERA - PIAGGIO
> 1998





10 036 0230 

MBK-YAMAHA-MINARELLI 50 >1998
GILERA PIAGGIO 50 - Ø 107



10 036 0240 

MBK-YAMAHA-MINARELLI 50
Fino al 1997 - Ø 105



10 036 0250 

MOTORI FRANCO MORINI 50 Ø 110
ATALA - CAGIVA - DERBY - ITALJET
MALAGUTI - MBK - SUZUKI - YAMAHA



SET CAMPANE GIRANTE - CLUTCH BELL KITS

10 037 0010 

HONDA 125-150: SH • Nes Chiocciola
• Dylan • Phanteon 4T
KIMCO 125: Heroism • Movie 99-00 • Movie XL
99-00 • People 99-00 • People Eu2 03 • Vivio 00
150 Heroism 95-97 • Movie XL Eu2 03 • People
99-00 • People Eu2 03 • Vivio 00
MALAGUTI 125-150: Ciak 00-02 • Ciak
Restyling Eu2 03 • Ciak Master 04



10 037 0020 

HONDA 250: Foresight 98>
300: Sh I 07-08
PEUGEOT 250: Sv 01-02
PIAGGIO 250: X9 00-01





CAMPANE FRIZIONE CLUTCH BELLS

APRILIA

10 026 0010 

50: Mojito 04-08 • Scarabeo 2T Eu2 Mot. Piaggio 10-11 • Scarabeo 2T Net 09-10 • Scarabeo 4T 4V Net 09-10 • Scarabeo 4T 4V 10 • Scarabeo 4T Restyling Eu3 06-09 • Scarabeo Quattro 09 • Scarabeo Street 2T Restyling 06-09 • Sport City One 2T 4T 08-10 • Sr R, R Factory ie e Carburatore 10-11 • Sr R, R Factory 04-09
100: Scarabeo 4T Net Eu3 10 • Scarabeo 4T Net 10 • Scarabeo 4T Restyling 06-09 • Scarabeo 4T 10 (R.O. AP8551021-289933)



10 026 0020 

50: Amico Tutti i Modelli - *All models* 90> Rally Lc 95-96 • Scarabeo 94-95 (R.O. AP8206135)



10 026 0030 

50: Sr Tutti i Modelli - *All models* 96>



10 026 0040 

125: Mojito Retrò Custom 99-01 (R.O. AP8550351)



10 026 0050 

125: Atlantic 03-05 • Scarabeo 04-06 Scarabeo Eu3 06-07 (R.O. AP8577095)



10 026 0170 

400: Atlantic Sprint 05-08 • Scarabeo Light 06-08
500: Atlantic Sprint 05-08 • Scarabeo Light 06-08 (R.O. AP8560026)



10 026 0180 

MOTORE ROTAX - ROTAX ENGINE
125: Leonardo 96-01 • Leonardo St 01-04 • Scarabeo Mot Rotax 99-03 • **150:** Leonardo St 01-04 • Scarabeo Mot Rotax 99-03
200: Scarabeo Mot Rotax 99-03 (R.O. AP0259662)



10 026 0190 

125: Atlantic Eu3 06-08 • Sport City 04-06 • Sr Max 11
200: Sport City 04-06 • Sport City Cube 08
250: Atlantic Eu3 06-08 • Sport City Cube 06-08
300: Scarabeo Light 09 • Sport City Cube 08 Sr Max 11 (R.O. 8440494)



BETA

10 026 0020 

50: Chrono 93-94 • Quadra 94>



10 026 0030 

50: Ark 96> • Chrono 96>





DERBI

10 026 0010 

50: Atlantis 2T Eu2 07-09 • Atlantis 2T 10 Atlantis 4T Eu2 07 • Atlantis 4T 04-06 • Atlantis 02 Bullet 03-05 • Atlantis 02 City 03-06 • Atlantis 02 Red Bullet 03 • Atlantis 02 Two Chic 05 Atlantis 02 • Boulevard 2T 09 • Boulevard 4T Eu2 25 Km/h 09 • Gp1 Eu2 05 • Gp1 Open Eu2 06-09 • Gp1 Race Eu2 05-07 • Gp1 01-02 • Gp1 03 • Sonar 2T 09
100: Atlantis 4T 04-06 • Boulevard 4T 10 (R.O. 289933)



10 026 0050 

125-150: Boulevard Eu3 04-07 Boulevard 02-04
200: Boulevard 05 (R.O. 82517R)



10 026 0190 

125: Boulevard 4T Eu3 08-09 • Rambla 08 • Gp1 Eu2 06 • Gp1 Low Seat Eu3 07-08
150: Boulevard 4T Eu3 10
250: Rambla 08 • Gp1 Low Seat Eu3 07-08 Gp1 06-07
300: Rambla 10 (R.O. 8440494)



GILERA

10 026 0010 

50: Dna 00-02 • Easy Moving 95-96 • Ice 01-05 • Runner 97-00 • Stalker 97-08 • Storm 94-95 • Typhoon 94-97 (R.O. 289933)



10 026 0050 

125: Dna 01 • Runner Vx-Vxr 02-04
180: Dna 01 • Runner Vx • Vxr 00-04 (R.O. 82517R)



10 026 0170 

500: Fuoco 07-09 • Nexus 03-05 (R.O. 825176)



10 026 0190 

125: Nexus Eu3 07-08 • Runner Vx Sc 06-07
200: Runner Vxr 05-06 • Runner Vxr Eu3 07
250: Nexus Eu3 06 • Oregon 06-08
300: Nexus Eu3 09 (R.O. 8440494)





CAMPANE FRIZIONE CLUTCH BELLS

HONDA

10 026 0110



125: Fes A S-Wing Abs 07-13 • Fes Pantheon 03-06 • Fes S-Wing 07-10 • Nes @/ Arobase 00-06 • Pes Ps i 06-13 • Ses Dylan 02-06 • Pes Ps i 06-10 • Sh 01-04 • Sh i 05-08 • Sh i 09-12
150: Nes @/ Arobase 00-06 • Ses Dylan 02-04 Sh 01-04 • Sh D i 09-11 • Sh i 05-08
(R.O. 22535KGF910)

10 026 0210



125: Fes Pantheon 98-02 • Nss Ao Forza Abs 15-16
150: Fes Pantheon 98-02
250: Fes Foresight 98-05
Nss Jazz 01-01 • Nss Jazz 03-04
300: Nss A Forza Abs 13-16 • Nss Forza 13-15 • Sh A I Abs 07-10 • Sh A I Abs 11-15
(R.O. 22100KFG000)



ITALJET

10 026 0020



MOTORI MINARELLI - MINARELLI ENGINE
50: Bazooka 91> • Pista 92>



KYMCO

10 026 0110



125: Agility Carry 11-11 • Agility R16 09-09 • Agility R16 12-12 • Agility Rs 09-09 • Downtown i 09-09 • K-Xct i 12-14 • Like Lx 12 • Like 09-09 • People Eu3 11 • People One i 13-13 • People S Dd Eu3 07-08 • People S 05 • Super 8 08 • Super 8 09-09 • Agility R16 08
150: Agility R16 09
200: Agility i R16 10 • Agility i Plus 14 • Agility R16 12 • Like i 09 • Like Lx 12 • People S 05



MALAGUTI

10 026 0020



MOTORI MINARELLI - MINARELLI ENGINE Ø 105
50: Centro 92> • F 10 (All Models) 92-96



10 026 0030



MOTORI MINARELLI - MINARELLI ENGINE Ø 107
50: Centro SL 98> • F 10 97>
• F 12 Phantom Aria (Da Telaio 405188) 97>
• F 15 Firefox 98> • Yesterday 97>



10 026 0110



125-150: Ciak 00-01 • Ciak Master 04 • Ciak Rst Eu2 03
(R.O. 52601300)





MBK

10 026 0020 

MOTORI MINARELLI - MINARELLI ENGINE Ø 105
50: Booster <94 • Booster Ng 95>
• Booster Spirit 96> • Rocket 96> • Sorriso <96
(R.O. 72601700)

10 026 0030 

MOTORI MINARELLI - MINARELLI ENGINE Ø 107
50: Booster All Models 97> • Nitro 97>
• Ovetto 97> • Sorriso 97>
(R.O. 72602700)

10 026 0080 

250: Yp Skyliner 00-03 • Yp Skyliner Abs 03
300: Xc Kilibre 03
(R.O. 5GM166110000)



PEUGEOT

10 026 0210 

250: Sv 01-02



PIAGGIO

10 026 0010 

50: Diesis 01 • Fly 2T-4T 05-07 • Free 92-94 • Liberty 97-05 • Nrg 94-96 • Quartz 92-96
Typhoon 01-09 • Vespa Et2-Et4 97-05 • Zip 95-04
100: Fly 4T 06-08 • Free 02-03 • Zip 4T 06-08
125: Vespa S 4T Le 09
(R.O. 289933)

10 026 0040 

125: Hexagon Lx4 98-99 • Liberty 98-00 • Sfera 95-97 • Vespa Et4 96-02
(R.O. 82503R)

10 026 0050 

125: Beverly 01-03 • X8 04-06
• X9 01-02 • X9 Evolution 03
180: X9 Amalfi 00-03
200: Beverly 01-03 • X8 04 • X9 02-03
• X9 Evolution 03
(R.O. 82517R)





CAMPANE FRIZIONE CLUTCH BELLS

PIAGGIO

10 026 0170 

400: Beverly Eu3 06-07 • Beverly Tourer Eu3 08-09 • Mp3 07-08 • X Evo 07-09 • X8 Eu3 06-08
500: Beverly 02-06 • Beverly Cruiser 07-09 • X9 01-02 • X9 Evolution 03-07
(R.O. 825176)

10 026 0190 

125: Beverly Rst 06-07 • Carnaby 07-09
150: Liberty 4T Eu3 08 • Vespa Lx 05-06
200: Carnaby 07-08 • Liberty 06 • X8 05-07
250: Beverly 06-07 • Carnaby 08 • Mp3 06-08
300: Beverly le Tourer 09 • Carnaby Cruiser 09
(R.O. 8440494)

10 026 0210 

250: X9 00-01



YAMAHA

10 026 0020 

MOTORI MINARELLI - MINARELLI ENGINE Ø 105
50: Axis 93> • Bw'S 92-96 • Jog 88>
• Jog (Italia) 93-96 • Spy <96
(R.O. 72601700)

10 026 0030 

MOTORI MINARELLI - MINARELLI ENGINE Ø 107
50: Aerox 97> • Breeze 97>
• Bw'S 97> • Jog All Models 97>
(R.O. 72602700)

10 026 0080 

250: Black X • Max 09 • Majesty 00-03 • Majesty Abs 03 • X-City 07-10 • X-Max 05-10
300: Versity 03-06
(R.O. 5GM166110000)



CAMPANE FRIZIONE VENTILATE - VENTILATED CLUTCH OUTER

10 026 0150 

MOTORI MINARELLI
MINARELLI ENGINE 50 CC Ø 107
MBK-MINARELLI-YAMAHA

10 026 0160 

MOTORI PIAGGIO
PIAGGIO ENGINE 50 CC Ø 107
GILERA - PIAGGIO





MODELLO - MODEL	ANNO YEAR	CAMPANA FRIZIONE CLUTCH OUTER	MODELLO - MODEL	ANNO YEAR	CAMPANA FRIZIONE CLUTCH OUTER
APRILIA			Runner Poggiali	02	10 026 0010
Amico Tutti I Modelli	90>	10 026 0020	Runner Purejet	02-07	10 026 0010
Amico Tutti I Modelli	96>	10 026 0030	Runner Purejet St	08	10 026 0010
Gulliver	95-96	10 026 0020	Runner Sp	02-07	10 026 0010
Gulliver	97>	10 026 0030	Runner Sp St & Simoncelli	08-09	10 026 0010
Mojito	04-08	10 026 0010	Stalker	97-09	10 026 0010
Rally Lc	95-96	10 026 0020	Stalker Naked	08	10 026 0010
Rally Liquid Cooled	96>	10 026 0030	Stalker Spec Edit	07-08	10 026 0010
Scarabeo	94-95	10 026 0020	Storm	94-95	10 026 0010
Scarabeo	96>	10 026 0030	Storm Eu2	07	10 026 0010
Scarabeo 4T Rst Eu3	06-09	10 026 0010	Typhoon	94-97	10 026 0010
Scarabeo Quattro	09	10 026 0010	Typhoon X	98-99	10 026 0010
Scarabeo Street 2T Rst	06-09	10 026 0010	Typhoon Xr	00	10 026 0010
Sonic	98>	10 026 0030	ITALJET		
Sport City One 2T	08-09	10 026 0010	Bazooka	91>	10 026 0020
Sport City One 4T	08	10 026 0010	Dragster	97>	10 026 0030
Sr Netscaper	98>	10 026 0030	Pista	92>	10 026 0020
Sr Racing	97>	10 026 0030	Reporter	90>	10 026 0020
Sr Stealth	97>	10 026 0030	Scoop	93>	10 026 0020
Sr Tutti I Modelli	93-95	10 026 0020	Yankee	94>	10 026 0020
Sr Tutti I Modelli	96>	10 026 0030	LEM		
Sr Www	97>	10 026 0030	Flash	94>	10 026 0020
Sr R R Factory	04-09	10 026 0010	Ghibli	90>	10 026 0020
Sr Street	03-08	10 026 0010	MALAGUTI		
Scarabeo 4T Rst 100cc	06-09	10 026 0010	Centro	92>	10 026 0020
BENELLI			Centro SL	98>	10 026 0030
491 Gt	97>	10 026 0030	F 10	97>	10 026 0030
491 Sport	97>	10 026 0030	F 10 (All Models)	92-96	10 026 0020
K2 (Ac)	98>	10 026 0030	F 12 Phantom	94-96	10 026 0020
K2 (Lc)	98>	10 026 0030	F 12 Phantom Ac	97>	10 026 0030
BETA			F 12 Phantom Lc	97>	10 026 0030
Ark	96>	10 026 0030	F 12 Phantom Twin Disk	98>	10 026 0030
Chrono	93-94	10 026 0020	F 15 Firefox	96-97	10 026 0020
Chrono	96>	10 026 0030	F 15 Firefox	98>	10 026 0030
Quadra	94>	10 026 0020	F 15 Firefox Twin Disk	97>	10 026 0030
Tempo	93>	10 026 0020	Yesterday	97>	10 026 0030
GARELLI			MBK		
Pony	92>	10 026 0020	Active	90>	10 026 0020
Sr	92>	10 026 0020	Booster	<94	10 026 0020
GILERA			Booster All Models	97>	10 026 0030
Dna	00-02	10 026 0010	Booster Ng	95>	10 026 0020
Dna	05-07	10 026 0010	Booster R	94>	10 026 0020
Dna Gp Experience	03-04	10 026 0010	Booster Spirit	96>	10 026 0020
Easy Moving	95-96	10 026 0010	Booster Track	96>	10 026 0020
Ice	01-05	10 026 0010	Nitro	97>	10 026 0030
Runner	97-00	10 026 0010	Ovetto	97>	10 026 0030



CAMPANE FRIZIONE 50 CC

CLUTCH BELLS 50 CC

MODELLO - MODEL	ANNO YEAR	CAMPANA FRIZIONE CLUTCH OUTER
Rocket	96>	10 026 0020
Sorriso	<96	10 026 0020
Sorriso	97>	10 026 0030
Target	92>	10 026 0020
PIAGGIO		
Diesis	01	10 026 0010
Fly 2T	05-07	10 026 0010
Fly 4T	05-08	10 026 0010
Fly 4T Mot Chn	06-07	10 026 0010
Free	92-94	10 026 0010
Free Delivery	00-01	10 026 0010
Free FL	95-02	10 026 0010
Liberty	97-05	10 026 0010
Liberty 2T	06-08	10 026 0010
Liberty 2T Rst	04	10 026 0010
Liberty 2T Sport	06-08	10 026 0010
Liberty 4T	00-02	10 026 0010
Liberty 4T	05-08	10 026 0010
Liberty 4T Delivery Tnt	09	10 026 0010
Liberty 4T Rst	04	10 026 0010
Liberty 4T Sport	06-08	10 026 0010
Liberty Moc 2T	09	10 026 0010
Liberty Moc 4T	09	10 026 0010
Liberty Ptt Eu2	04-05	10 026 0010
Nrg	94-96	10 026 0010
Nrg Extreme	99-00	10 026 0010
Nrg Mc3	01-04	10 026 0010
Nrg Power Dd	05-09	10 026 0010
Nrg Power Dd Serie Spece	07-08	10 026 0010
Nrg Power Dt	06-08	10 026 0010
Nrg Power Dt Serie Spece	07-08	10 026 0010
Nrg Power Purejet	04-08	10 026 0010
Nrg Purejet	02-04	10 026 0010
Nrg Rst Mc2	96-98	10 026 0010
Ntt	95-96	10 026 0010
Quartz	92-96	10 026 0010
Sfera Maquillage 2	94	10 026 0010
Sfera Rst	95-97	10 026 0010
Typhoon	01-09	10 026 0010
Velofax	96-99	10 026 0010
Vespa Et2	97-05	10 026 0010
Vespa Et2 Iniezione	97-00	10 026 0010
Vespa Et4	00-05	10 026 0010
Vespa Lx 2T	05-08	10 026 0010
Vespa Lx 2T FL	09	10 026 0010
Vespa Lx 4T	05-08	10 026 0010

MODELLO - MODEL	ANNO YEAR	CAMPANA FRIZIONE CLUTCH OUTER
Vespa Lx 4T-4V	09	10 026 0010
Vespa Lxv 2T	06-08	10 026 0010
Vespa Lxv 2T Navy	08	10 026 0010
Vespa S 2T	07-08	10 026 0010
Vespa S 4T-4V	08-09	10 026 0010
Zip	95-96	10 026 0010
Zip	00-04	10 026 0010
Zip 2T	08-09	10 026 0010
Zip 4T	00-08	10 026 0010
Zip Fast Raider	93-94	10 026 0010
Zip Fast Raider Rst	96-97	10 026 0010
Zip Rst	96-99	10 026 0010
Zip Sp	96-04	10 026 0010
Zip Sp Eu2	06-09	10 026 0010
YAMAHA		
Aerox	97>	10 026 0030
Axis	93>	10 026 0020
Beluga	89>	10 026 0020
Breeze	94-96	10 026 0020
Breeze	97>	10 026 0030
Bw'S	92-96	10 026 0020
Bw'S	97>	10 026 0030
Jog	88>	10 026 0020
Jog (Ita)	93-96	10 026 0020
Jog All Models	97>	10 026 0030
Neo'S	97>	10 026 0030
Spy	<96	10 026 0020
Spy	97>	10 026 0030
Target	91>	10 026 0020
Why	98>	10 026 0030
Zest	<96	10 026 0020
Zest	96>	10 026 0030
Zuma	96>	10 026 0020

GIRANTI - CAMPANE - MAXISCOOTER

CLUTCHES - OUTERS - MAXISCOOTER



MODELLO - MODEL	CC	ANNO YEAR	CAMPANA OUTER	GIRANTE CLUTCH	MODELLO - MODEL	CC	ANNO YEAR	CAMPANA OUTER	GIRANTE CLUTCH
APRILIA					DERBI				
Scarabeo 4t Rst	100	06-09	10 026 0010		Rambra	250	08		10 036 0410
Atlantic Eu3	125	06-12	10 026 0190	10 036 0380	GILERA				
Leonardo	125	96-98	10 026 0180		Dna	125	01	10 026 0050	10 036 0020
Leonardo	125	99-01	10 026 0180	10 036 0130	Nexus Eu3	125	07-08	10 026 0190	10 036 0380
Leonardo St	125	01-04	10 026 0180	10 036 0130	Nexus Eu3 le	125	08-09		10 036 0380
Mojito	125	03-08	10 026 0190	10 036 0380	Runner Fx-Fxr	125	97-02		10 036 0030
Mojito	125	08		10 036 0380	Runner Vx	125	05-06	10 026 0190	10 036 0380
Mojito Retro' - Custom	125	99-01	10 026 0040	10 036 0010	Runner Vx 4t Eu3	125	07	10 026 0190	10 036 0380
Scarabeo	125	04-06	10 026 0050		Runner Vx 4t St Eu3	125	08-09		10 036 0380
Scarabeo Eu3	125	06-07	10 026 0050		Runner Vx Race	125	06		10 036 0380
Scarabeo Light	125	07-08		10 036 0380	Runner Vx Sc	125	06-07	10 026 0190	10 036 0380
Scarabeo Mot Rotax	125	99-03	10 026 0180	10 036 0130	Runner Vx Vxr	125	00-01	10 026 0050	10 036 0020
Sport City	125	04-06	10 026 0190	10 036 0380	Runner Vx-Vxr	125	02-04	10 026 0050	10 036 0380
Sport City Cube	125	08-10	10 026 0190	10 036 0380	Typhoon	125	95-98		10 036 0030
Sport City Eu3	125	06-08	10 026 0190	10 036 0380	Typhoon X-Xr	125	99-00		10 036 0030
Sport City One 4T	125	08-09	10 026 0190	10 036 0380	Dna	180	01	10 026 0050	10 036 0050
Sr	125	99-01		10 036 0030	Runner Fx-Fxr	180	97-02		10 036 0040
Sr Max	125	11	10 026 0190		Runner Vx-Vxr	180	00-01	10 026 0050	10 036 0050
Leonardo	150	96-01		10 036 0140	Runner Vx-Vxr	180	02-04	10 026 0050	
Leonardo St	150	01-04	10 026 0180	10 036 0140	Runner Vxr	200	05-06	10 026 0190	10 036 0330
Mojito	150	03-07	10 026 0190		Runner Vxr 4t St Eu3	200	08		10 036 0330
Scarabeo Mot Rotax	150	99-03	10 026 0180	10 036 0140	Runner Vxr Eu3	200	07	10 026 0190	10 036 0330
Atlantic	200	03-05		10 036 0330	Runner Vxr Race	200	06		10 036 0330
Scarabeo	200	03		10 036 0330	Nexus Eu3	250	06	10 026 0190	10 036 0410
Scarabeo Eu3	200	06-07	10 026 0050	10 036 0330	Nexus Sp Eu3	250	06-07	10 026 0190	
Scarabeo Mot Rotax	200	99-03	10 026 0180		Oregon	250	06-08	10 026 0190	
Sport City	200	04-06	10 026 0190	10 036 0330	Nexus Eu3	300	09	10 026 0190	
Sport City Cube	200	08	10 026 0190	10 036 0330	Fuoco	500	07-09	10 026 0170	
Sport City Eu3	200	06-08	10 026 0190	10 036 0330	Nexus	500	03-05	10 026 0170	10 036 0420
Atlantic	250	03-05	10 026 0050	10 036 0410	Nexus Eu3	500	06-09	10 026 0170	10 036 0310
Atlantic Eu3	250	06-08	10 026 0190	10 036 0410	Nexus Sp Eu3	500	06-07	10 026 0170	
Scarabeo	250	04-06	10 026 0050	10 036 0410	HONDA				
Scarabeo Light	250	06-08	10 026 0190	10 036 0410	Nss Ad Forza Abs	125	15	10 026 0210	10 036 0161
Sport City Eu3	250	06-08	10 026 0190	10 036 0410	Nss Ad Forza Abs	125	16	10 026 0210	10 036 0161
Sport City Cube	250	06-08	10 026 0190	10 036 0410	Fes A S-Wing Abs	125	07-13	10 026 0110	10 036 0161
Scarabeo Light	300	09	10 026 0190	10 036 0410	Fes Pantheon	125	03-06	10 026 0110	10 036 0161
Sport City Cube	300	08	10 026 0190	10 036 0410	Fes S-Wing	125	07-10	10 026 0110	10 036 0161
Sr Max	300	11	10 026 0190		Fes Pantheon	125	98-02	10 026 0210	10 036 0161
Atlantic Sprint	400	05-08	10 026 0170		Nes @/ Arobase	125	00-06	10 026 0110	10 036 0161
Scarabeo Light	400	06-08	10 026 0170	10 036 0420	Pantheon 2t	125	98-02	10 026 0110	10 036 0161
Atlantic	500	01-04		10 036 0320	Pes Ps i	125	06-13	10 026 0110	10 036 0161
Atlantic Sprint	500	05-08	10 026 0170	10 036 0310	Pes Ps i	125	06-10	10 026 0110	10 036 0161
Scarabeo Light	500	06-08	10 026 0170	10 036 0310	Ses Dylan	125	02-06	10 026 0110	10 036 0161
ADIVA					Sh	125	01-04	10 026 0110	10 036 0161
Adiva	125	01-02		10 036 0020	Sh i	125	05-08	10 026 0110	10 036 0161
BENELLI					Sh i	125	09-12	10 026 0110	10 036 0161
Velvet	125	99-01		10 036 0060	Fes Pantheon	150	98-02	10 026 0210	10 036 0161
Velvet Touring	125	02-03		10 036 0060	Nes @/ Arobase	150	00-06	10 026 0110	10 036 0161
					Pantheon 2t	150	98-02	10 026 0110	10 036 0161



GIRANTI - CAMPANE - MAXISCOOTER

CLUTCHES - OUTERS - MAXISCOOTER

MODELLO - MODEL	CC	ANNO YEAR	CAMPANA OUTER	GIRANTE CLUTCH	MODELLO - MODEL	CC	ANNO YEAR	CAMPANA OUTER	GIRANTE CLUTCH
Ses Dylan	150	02-04	10 026 0110	10 036 0161	Vivio	125	00	10 026 0110	10 036 0160 10 036 0161
Sh	150	01-04	10 026 0110	10 036 0161	B&W	150	00		10 036 0170
Sh D i	150	09-11	10 026 0110	10 036 0161	B&W Eu2	150	03-04		10 036 0530
Sh i	150	05-08	10 026 0110	10 036 0161	Dink	150	97-98		10 036 0170
Fes Foresight	250	98-99	10 026 0210	10 036 0100	Dink Classic	150	02		10 036 0170
Fes Foresight	250	00-05	10 026 0210	10 036 0100	Dink Classic Eu2	150	03		10 036 0170
Nss Jazz	250	01	10 026 0210	10 036 0100	Dink Lx	150	98-00		10 036 0170
Nss Jazz	250	03-04	10 026 0210	10 036 0100	Heroism	150	95-97	10 026 0110	
Jazz	250	00-04	10 026 0210	10 036 0100	Movie 150 Eu3	150	06-07	10 026 0110	10 036 0160 10 036 0161
Nss A Forza Abs	300	13-15	10 026 0210	10 036 0100	Movie XI	150	01	10 026 0110	10 036 0160 10 036 0161
Nss A Forza Abs	300	16	10 026 0210	10 036 0100	Movie XI Eu2	150	03-04	10 026 0110	10 036 0160 10 036 0161
Nss Forza	300	13-15	10 026 0210	10 036 0100	People	150	99-00	10 026 0110	10 036 0160 10 036 0161
Sh A I Abs	300	07-10	10 026 0210	10 036 0100	People 0 Eu2	150	03	10 026 0110	10 036 0160 10 036 0161
Sh A I Abs	300	11-15	10 026 0210	10 036 0100	Vivio	150	00		10 036 0160 10 036 0161
ITALJET					People S 200i	200	07	10 026 0110	
Jet Set 4t	125			10 036 0020	B&W	250	00		10 036 0360
Torpedo	125	98-00		10 036 0010	B&W Eu2	250	03		10 036 0360
Torpedo (Mot Leader)	125	00-03		10 036 0020	Grand Dink	250	01-02		10 036 0360
Dragster	180	99-03		10 036 0040	Grand Dink Eu2	250	03-04		10 036 0360
KYMCO					People Lc	250	03-04		10 036 0360
Agility 4t	125	06	10 026 0110	10 036 0160 10 036 0161	People S	250	06		10 036 0360
Agility 4t Eu3	125	06-08	10 026 0110		People S 250i	250	07		10 036 0360
Agility Rs	125	09		10 036 0160 10 036 0161	X Citing	250	05		10 036 0360
B&W	125	00		10 036 0170	X Citing I	250	06-07		10 036 0360
B&W Eu2	125	03-04		10 036 0530	Yup	250	03		10 036 0360
Dink	125	97-98		10 036 0170	People S 300i	300	08		10 036 0360
Dink Classic	125	02		10 036 0170	X Citing 300i	300	08		10 036 0360
Dink Classic Eu2	125	03		10 036 0170	X Citing 300i R	300	08-09		10 036 0360
Dink Lx	125	98-00		10 036 0170	MALAGUTI				
Downtown I	125	09		10 036 0530	Ciak	125	00-01	10 026 0110	10 036 0160
Grand Dink	125	01-02		10 036 0170	Ciak Master	125	04	10 026 0110	10 036 0160
Grand Dink Eu2	125	03-04		10 036 0170	Ciak Rst Eu2	125	03	10 026 0110	10 036 0160
Heroism	125	95-97	10 026 0110	10 036 0160 10 036 0161	Madison	125	99-01		10 036 0060
K-Xct I	125	12		10 036 0530	Madison R Rst	125	02		10 036 0060
Movie	125	99-00	10 026 0110	10 036 0160 10 036 0161	Ciak	150	00-02	10 026 0110	10 036 0160
Movie 125 Eu3	125	06-07	10 026 0110	10 036 0160 10 036 0161	Ciak Master	150	04	10 026 0110	10 036 0160
Movie XI	125	01	10 026 0110	10 036 0160 10 036 0161	Ciak Rst Eu2	150	03	10 026 0110	10 036 0160
Movie XI Eu2	125	03-04	10 026 0110	10 036 0160 10 036 0161	Madison T	150	99-01		10 036 0090
People	125	99-00	10 026 0110	10 036 0160 10 036 0161	MBK				
People Eu2	125	03	10 026 0110	10 036 0160 10 036 0161	Skyliner	125	98-02		10 036 0060
People Eu3	125	07-08	10 026 0110	10 036 0160 10 036 0161	Thunder	125	01-02		10 036 0060
People Gti	125	10		10 036 0530	Doodo	150	01-02		10 036 0090
					Skyliner	150	00-02		10 036 0090



MODELLO - MODEL	CC	ANNO YEAR	CAMPANA OUTER	GIRANTE CLUTCH	MODELLO - MODEL	CC	ANNO YEAR	CAMPANA OUTER	GIRANTE CLUTCH
Thunder	150	01-02		10 036 0090	Vespa Granturismo	125	06-07	10 026 0190	10 036 0380
Skyliner	250	00-03	10 026 0080	10 036 0070	Vespa Granturismo Eu3	125	06-07	10 026 0190	10 036 0380
Skyliner Abs	250	03	10 026 0080	10 036 0070	Vespa Gts 4t le Super	125	09	10 026 0190	10 036 0380
Kilibre	300	03	10 026 0080	10 036 0070	Vespa Gts Eu3	125	07-09	10 026 0190	10 036 0380
PEUGEOT					Vespa Gtv	125	07-08	10 026 0190	10 036 0380
Elyseo	100	99-01		10 036 0300	Vespa Gtv 4t Navy Eu3	125	08	10 026 0190	10 036 0380
Speedfight	100	97-00		10 036 0300	Vespa Lx	125	05-06	10 026 0190	10 036 0520
Vivacity	100	99-01		10 036 0300	Vespa Lx 4t FL	125	09	10 026 0190	10 036 0520
X-Fight	100	00-01		10 036 0300	Vespa Lx Eu3	125	06-08	10 026 0190	10 036 0520
Sv	250	01-02	10 026 0210	10 036 0100	Vespa Lx Eu3 le	125	09	10 026 0190	
PIAGGIO					Vespa Lx 4T Eu3 Touring	125	10-11		10 036 0520
Fly 4t	100	06-08	10 026 0010		Vespa Lx 4T 3V le Touring	125	12-13		10 036 0510
Free	100	02-03	10 026 0010		Vespa 946 4T 3V Abs	125	13		10 036 0510
Zip 4t	100	06-08	10 026 0010		Vespa Lxv 4t Eu3	125	06-09	10 026 0190	10 036 0520
Beverly	125	01-03	10 026 0050	10 036 0020	Vespa Lx V le 4T	125	10-12		10 036 0520
Beverly Eu3	125	07-08		10 036 0380	Vespa Lxv 4t Navy Eu3	125	08	10 026 0190	10 036 0520
Beverly Eu3 Mic	125	07	10 026 0190	10 036 0380	Vespa Px T5	125	85-89	10 026 0140	
Beverly Eu3 Sport	125	07-08	10 026 0190	10 036 0380	Vespa S 4t Eu3	125	07-08	10 026 0190	10 036 0520
Beverly Rst	125	06-07	10 026 0190	10 036 0380	Vespa S 4t le	125	09-11	10 026 0010	10 036 0520
Beverly Rst	125	04-05		10 036 0380	X Evo	125	07	10 026 0190	10 036 0380
Beverly Tourer Eu3	125	08-09		10 036 0380	X7 Eu3	125	08	10 026 0190	10 036 0380
Carnaby	125	07-09	10 026 0190	10 036 0380	X7 Evo le Eu3	125	09	10 026 0190	10 036 0380
Cosa Cl-Clx	125	88-91	10 026 0140		X8	125	04	10 026 0050	10 036 0020
Fly	125	05-07	10 026 0190		X8	125	05-06	10 026 0190	10 036 0380
Fly Eu3	125	05-07	10 026 0190	10 036 0520	X8 Premium Eu2	125	06	10 026 0190	10 036 0380
Fly 4T 3V le Eu3	125	12		10 036 0510	X8 Premium Eu3	125	06-07	10 026 0190	10 036 0380
Hexagon	125	94-97		10 036 0030	X8 Street Eu2	125	06-07	10 026 0190	10 036 0520
Hexagon Gtx	125	00		10 036 0380	X9	125	01-02	10 026 0050	10 036 0380
Hexagon Lx-Lxt	125	98-99		10 036 0030	X9 Evolution	125	03	10 026 0050	10 036 0020
Hexagon Lx4	125	98-99	10 026 0040	10 036 0010	X9 Evolution	125	05-06	10 026 0190	10 036 0380
Liberty	125	98-00	10 026 0040	10 036 0010	X9 Evolution Eu3	125	07	10 026 0190	10 036 0380
Liberty	125	01-02		10 036 0380	Zip	125	00-02		10 036 0380
Liberty 4t	125	06-07	10 026 0190	10 036 0520	Cosa Cl-Clx	150	88-91	10 026 0140	
Liberty 4t Eu3	125	07-08	10 026 0190	10 036 0520	Fly	150	05-07	10 026 0190	10 036 0520
Liberty 4t Sport Eu3	125	06-08	10 026 0190	10 036 0520	Fly Eu3	150	08-11		10 036 0520
Liberty Moc 4t	125	09	10 026 0190		Hexagon	150	94-97		10 036 0030
Liberty Rst	125	04-05		10 036 0380	Liberty 4t Eu3	150	08	10 026 0190	10 036 0520
Liberty Rst Ptt	125	05-06		10 036 0380	Liberty 4t Sport Eu3	150	08	10 026 0190	10 036 0520
Liberty Sport	125	06-08	10 026 0190	10 036 0520	Liberty Moc 4t	150	09-13	10 026 0190	10 036 0520
Mp3	125	07-08	10 026 0190	10 036 0380	Skipper	150	94-97		10 036 0030
Mp3 Ibrido	125	09		10 036 0380	Vespa Lx	150	05-06	10 026 0190	10 036 0520
Mp3 le	125	08-09		10 036 0380	Vespa Lx Eu3	150	06-08	10 026 0190	10 036 0520
Sfera	125	95-97	10 026 0040	10 036 0010	Vespa Lx Eu3 le	150	09	10 026 0190	10 036 0520
Skipper	125	94-97		10 036 0030	Vespa Lx Touring	150	10-12		10 036 0520
Skipper 4t	125	00-02		10 036 0380	Vespa Lx 4T 3V le Touring	150	12-13		10 036 0510
Skipper Lx	125	98-99		10 036 0030	Vespa S 4t le	150	09	10 026 0190	10 036 0520
Super Hexagon Gtx 12"	125	01-02		10 036 0380	X8 Street Eu2	150	06-08	10 026 0190	10 036 0520
Typhoon 4T 2V Eu3	125	10-11		10 036 0520	Hexagon Gtx	180	00		10 036 0050
Vespa Et4	125	96-98	10 026 0040	10 036 0010	Hexagon Lx-Lxt	180	98-99		10 036 0040
Vespa Et4	125	99-02	10 026 0190	10 036 0380	Super Hexagon Gtx 12"	180	01-02		10 036 0050



GIRANTI - CAMPANE - MAXISCOOTER

CLUTCHES - OUTERS - MAXISCOOTER

MODELLO - MODEL	CC	ANNO YEAR	CAMPANA OUTER	GIRANTE CLUTCH
X9 Amalfi	180	00-03	10 026 0050	
Beverly	200	01-03	10 026 0050	10 036 0330
Carnaby	200	07-08	10 026 0190	10 036 0330
Cosa Cl-Clx	200	88-91	10 026 0140	
Liberty	200	06	10 026 0190	10 036 0050
Liberty 4t Eu3	200	07-08	10 026 0190	10 036 0050
Liberty 4t Sport Eu3	200	06-07	10 026 0190	10 036 0050
Liberty Rst	200	04		10 036 0050
Liberty Sport	200	06	10 026 0190	10 036 0050
Vespa Granturismo	200	03-07		10 036 0330
Vespa Pxe Arcobaleno	200	81-97	10 026 0140	
X8	200	05-07	10 026 0190	10 036 0330
X8 125-200	200	04	10 026 0050	
X9	200	02-03	10 026 0050	
X9 Evolution	200	03	10 026 0050	
Beverly	250	06-07	10 026 0190	10 036 0410
Beverly Cruiser	250	07-09	10 026 0190	10 036 0410
Beverly Eu3 Mic	250	07	10 026 0190	10 036 0410
Beverly Ie Eu3	250	06-08	10 026 0190	10 036 0410
Beverly Rst	250	04-05	10 026 0190	10 036 0410
Beverly Sport	250	06-08	10 026 0190	10 036 0410
Beverly Tourer Eu3	250	08-09	10 026 0190	10 036 0410
Carnaby	250	08	10 026 0190	10 036 0410
Mp3	250	06-08	10 026 0190	10 036 0410
Mp3 Lt	250	09	10 026 0190	10 036 0410
Mp3 Mic	250	08-09	10 026 0190	10 036 0410
Vespa Gt 60 Eu3	250	06-07	10 026 0190	10 036 0410
Vespa Gts, Gts Abs	250	05-09	10 026 0190	10 036 0410
Vespa Gtv	250	06-09	10 026 0190	10 036 0410
Vespa Gtv 4t Navy Eu3	250	08	10 026 0190	10 036 0410
X7 Eu3	250	08	10 026 0190	10 036 0410
X8 Eu3	250	05-08	10 026 0190	10 036 0410
X9	250	00-01	10 026 0210	10 036 0100
X9 Evolution	250	06	10 026 0190	10 036 0410
Xevo	250	07	10 026 0190	10 036 0410
Beverly 300 Ie Tourer	300	09	10 026 0190	10 036 0410
Carnaby Cruiser	300	09	10 026 0190	10 036 0410
Vespa Gts Super	300	08	10 026 0190	10 036 0410
X7 Evo Ie Eu3	300	09	10 026 0190	10 036 0410
Beverly Eu3	400	06-07	10 026 0170	10 036 0420
Beverly Tourer Eu3	400	08-09	10 026 0170	10 036 0420
Mp3	400	07-08	10 026 0170	10 036 0420
Mp3 Lt	400	09	10 026 0170	
Mp3 Mic	400	08-09	10 026 0170	
X Evo	400	07-09	10 026 0170	10 036 0420
X8 Eu3	400	06-08	10 026 0170	10 036 0420
Beverly	500	02-06	10 026 0170	10 036 0310
Beverly Cruiser	500	07-09	10 026 0170	10 036 0310
Beverly Eu3	500	06-08	10 026 0170	10 036 0310
X9	500	01-02	10 026 0170	10 036 0320

MODELLO - MODEL	CC	ANNO YEAR	CAMPANA OUTER	GIRANTE CLUTCH
X9 Evolution	500	03-07	10 026 0170	10 036 0310
X9 Evolution Abs	500	06-07	10 026 0170	10 036 0310
SUZUKI				
Burgman	125	02-06		10 036 0370
Burgman	125	07-10		10 036 0430
Sixteen	150	08-11		10 036 0440
Burgman	200	07-10		10 036 0450
Burgman	250	98-02		10 036 0120
Burgman	400	99-06		10 036 0110
Burgman	400	07-10		10 036 0460
SYM				
Joyride Eu2	125	05-06		10 036 0160
Joyride Eu3	125	07		10 036 0160
Joyride Evo	125	09		10 036 0160
Track Runner	180	06-07		10 036 0160
YAMAHA				
Majesty	125	98-02		10 036 0060
Maxster	125	01-02		10 036 0060
X-City	125	08		10 036 0390
X-Max	125	06-09		10 036 0390
Majesty	150	01-02		10 036 0090
Maxster	150	01-02		10 036 0090
Teos	150	01-02		10 036 0090
Black X-Max	250	09	10 026 0080	10 036 0070
Majesty	250	00-03	10 026 0080	
Majesty Abs	250	03	10 026 0080	
X-City	250	07-10	10 026 0080	10 036 0070
X-Max	250	05	10 026 0080	
X-Max	250	06-10	10 026 0080	10 036 0070
Versity	300	03-06	10 026 0080	10 036 0070
Majesty	400	04-06		10 036 0350
Majesty	400	07-08		10 036 0400
Majesty Abs	400	07-08		10 036 0400



APRILIA

10 032 0131 

50: Mojito Custom 2T Motore Piaggio 04-10
• Scarabeo 2T Eu2 Motore Piaggio 10-12
• Scarabeo 2T Net 09-10 • Scarabeo 2T 14
• Scarabeo 4T 4V Net 09-10 • Scarabeo 4T 4V 10-14
• Scarabeo 4T Restyling Eu3 06-09 • Scarabeo 4T 02-06
• Scarabeo Quattro 09 • Scarabeo Street 2T Restyling 06-09
• Scarabeo Street 05-06 • Sport City one 2T 08-11
• Sport City One 4T 08-10 • Sr iniezione e carburatore 14
• Sr motard 2T 12-14 • Sr Motard 4T 4V 13-14
• Sr R Factory ie e carburatore 10-14
• Sr R R Factory 04-09 • Sr Street 03-12
100: Scarabeo 4T Net Eu3 10 • Scarabeo 4T Net 09
• Scarabeo 4T Restyling 06-09 • Scarabeo 4T 01-14
(R.O. 479561)



10 032 0150 

125: Atlantic Eu3 06-12 • Atlantic 03-05 • Mojito 03-08
• Scarabeo Motore Piaggio Eu3 06 • Scarabeo 03-06
• Sport City Cube 08-10 • Sport City Eu3 06-08
• Sport City One 4T Eu3 08-11
• Sport City Street 12 • Sport City 04-06 • Sr Motard 12-14
(R.O. AP8580085)



10 032 0160 

125: Scarabeo Light 07-09 (R.O.827586)
200: Atlantic 03-05 • Scarabeo 03 • Scarabeo Eu3 06-07
• Sport City 04-06 Sport City Eu3 06-08
• Sport City Cube 08-10 (R.O. AP8575027)



10 032 0240 

400: Atlantic Sprint 05-08 • Scarabeo Light 06-08
500: Atlantic Sprint 05-08
Scarabeo 03-06 • Scarabeo Light 06-08
(R.O. 832697)



10 032 0270 

250: Atlantic Eu3 06-08 • Atlantic 03-05 • Scarabeo 04-06
• Sport City Eu3 06-08
250: Scarabeo Light 06-08 • Sport City Cube 08-12
300: Atlantic 10-11 • Scarabeo Light 09-10 • Sport City Street 12
• Sr Max 11-14 (R.O. 840193)



10 032 0311 

125: Atlantic 03-05 • Scarabeo Motore Piaggio Eu3 06
• Scarabeo 03 • Sport City Eu3 06-08 • Sport City 04-06
(R.O. AP8575027)



DERBI

10 032 0131 

50: Atlantis 2T Eu2 07-09 • Atlantis 2T 10 • Atlantis 4T Eu2 07
• Atlantis 4T 04-06 • Atlantis 02 Bullet 03-05 • Atlantis 02 City 03-06
• Atlantis 02 Red Bullet 03 • Atlantis 02 Two Chic 05 • Atlantis 02 02
• Boulevard 2T 09-14 • Boulevard 4T Eu2 25 Km/h 09
• Gp1 E2 03 • Gp1 Eu2 05 • Gp1 open Eu2 06-09
• Gp1 Race Eu2 05-07 • Gp1 01-03 • Sonar 2T 09
• Variant Sport 2T 12
100: Boulevard 4T 10-11 (R.O. 479561)



10 032 0150 

125: Boulevard Eu2 04-07 • Boulevard 02-04 • Boulevard 4T Eu3 08-12
• Gp1 Eu2 06 • Gp1 Low Seat Eu3 07-08
• Rambla E3 2Ver 08 • Rambla 08-09 • Sonar 4T 09-11
• Variant Sport 4T E3 12
150: Boulevard 4T E3 10 • Sonar 4T 09 (R.O. 845607)



10 032 0270 

125: Rambla E3 2Ver 08 • Rambla 08-09
250: Gp1 Low Seat Eu3 07-08 • Gp1 06-07
300: Rambla 10-11 (R.O. 840193)



10 032 0311 

125: Boulevard Eu2 04-07 • Boulevard 4T Eu3 08-12
• Gp1 Eu2 06 • Gp1 Low Seat Eu3 07-08 • Rambla E3 2Ver 08
• Rambla 08-09 • Sonar 4T 09-11 • Variant Sport 4T E3 12
150: Boulevard 4T E3 10 • Sonar 4T 09 (R.O. 845607)





SEMIPULEGGE MOTRICI FISSE
FIXED DRIVE HALF PULLEY

GILERA

10 032 0120



50: Easy Moving 95-96 • Storm 94-95
• Typhoon 94-97
(R.O. 289831)



10 032 0131



50: Dna Gp Experience 03-04 • Dna 00-07
• Ice 01-05 • Runner Poggiali 02 • Runner
Purejet St 08 • Runner Purejet 02-11 • Runner
Sp Special Edition 07 • Runner Sp St & Simon-
celli 08-09 • Runner Sp 02-12 • Runner 97-00 •
Stalker Naked 08 • Stalker Special Edition 07-08
• Stalker 97-11 • Storm Eu2 07 • Typhoon Xr 00
(R.O. 479561)



10 032 0150



125: Dna 01 • Runner Vx Vxr 00-01
(R.O. 485118 • 485118)



10 032 0160



180: Dna 01 • Runner Vx-Vxr 00-04
200: Runner Vxr 05-06 • Runner Vxr Eu3 07
• Runner Vxr Race 05-06 • Runner Vxr 4T St
Eu3 08-11
(R.O. 834774)



10 032 0200



125: Runner Fx-Fxr 97-02 • Typhoon X-Xr 99-00
180: Runner Fx-Fxr 97-02
(R.O. 487957)



10 032 0240



500: Fuoco 4T 4V ie Eu3 Lt 13-14 • Fuoco Eu3
07-13 • Nexus Eu3 06-11 • Nexus Sp Eu3 06-07
• Nexus 03-05
(R.O. 832697)



HONDA

10 032 0270



250: Nexus Eu3 06-07 • Oregon 06-10
300: Nexus Eu3 08-11
(R.O. 840193)



10 032 0311



125: Nexus Eu3 07-08 • Runner Vx 05-06
• Runner Vx 4t Eu3 06-13 • Runner Vx Race 06
(R.O. 845607)



10 032 0441



125: Pantheon Fes 03-05 • Silver Wing Fes 07-
12 • Pes Injection 06-10 • Sh 01-12
150: Sh 01-12
(R.O. 22102-KGF-910)



10 032 0660



125: Sh Mode 14-15 • Pcx 10-12
150: Pcx 10-14
(R.O. 22102-KZR-600 • 22102-KWN-900)



10 032 0640



125: Sh Abs 13-16
150: Sh 13-16
(R.O. 2210-K01-900)



10 032 0650



300: Sh 07-16 • Forza Abs 14-16
(R.O. 22102-KTW-900)





KYMCO

10 032 0410

125: Agility 4T Eu3 06-08 • Agility 4T 06 • Agility Carry 11 • Agility R16 08-12 • Agility Rs 09 • Like Lx 12 • Like 09 • Movie Eu3 06-07 • Movie XL Eu2 03-04 • Movie XL 01 • Movie 99-00 • People Eu2 03 • People 99-00 • People Eu3 07-11 • People One I 13 • People S Dd Eu3 0708 • People S 05 • Super 8 08 • Super 8 09 • Vivio 00 • **150:** Vivio 00 • Agility R16 08-09 • Movie Eu3 06-07 • **200:** Agility R16 10 • Agility i Plus 14 • Agility R16 12 • Like 09 • Like Lx 12 • People S 07 • People S 05
(R.O. 00126115)



MALAGUTI

10 032 0671 **NEW**

125: Madison R Restyling Eu2 03-04 • Madison R Restyling 02 • Madison 99-01 • Phantom Max 03
150: Madison T 99-01
(R.O. 76007000)



MBK

10 032 0211

50: Mach G Eu1-Eu2 02-03 • Booster 01-02 • Booster Naked 03 • Booster Spirit 96-00 • Booster Ng 95-03 • Stunt 00-02 • Evolis 92-95 • Flipper 01-02 • Flipper Cat 99-00 • Fizz 94-95 • Ovetto Eu1-Eu2 02-04
(R.O. 3VLE76110000)



10 032 0671 **NEW**

125: Xn Doodo 00-01 • Xq Thunder 01-02 • Yp Skyliner 01-03
150: Xn Doodo 01-02 • Xq Thunder 01-02 • Yp Skyliner 01-02
180: Yp Skyliner 03
(R.O. 5DSE76110000)



PEUGEOT

10 032 0300

50: Buxy 94-97 • Elyseo 99 • Looxor 01-03 • Speedake 95-97 • Speedfight Lc/Ac 97-98 • Vivacity 99 • Zenith L 94-96
100: Elyseo 99-01 • Looxor 01 • Speedfight 97-00 • Sv L 98 • Vivacity 99-01
(R.O. 732801)



PIAGGIO

10 032 0120

50: Free 92-94 • Nrg 94-96 • Ntt 95-96 • Quartz 92-96 • Sfera Rst 95-97 • Vespa Et2 97-05 • Zip 95-96 • Zip Bimodale 94-97 • Zip Fast Raider 93-97 • Zip Rst 96-99
(R.O. 289831)



10 032 0131

50: Fly 2T-4T 05-08 • Fly 4T 2V 12-15 • Fly 4T 4V 12-13 • Free FL 95-02 • Liberty 97-05 • Liberty 2T-4T 06-08 • Liberty Ptt Eu2 04-05 • Liberty 4T Ptt Double 09-15 • Liberty 4T Sport 06-08 • Liberty Iget 4T 3V ie 15-16 • Nrg Purejet 02-10 • Typhoon 01-09 • Vespa Et2 Iniezione 97-00 • Vespa Et4 00-05 • Vespa Lx 2T 05-08 • Vespa Lx 4T 4V 09-13 • Vespa Lxv 2T 06-09 • Vespa Primavera 2T 13-15 • Vespa Primavera 4T 4V 13-16 • Vespa Sprint 4T 4V 14-16 • Zip 00-04 • Zip Sp Eu2 06-13 • Zip 2T 08-13
100: Fly 4T 06-08 • Free 02-03 • Zip 4T 06-10
(R.O. 479561)



10 032 0140

125: Hexagon Lx4 98-99 • Liberty 98-00-Sfera 95-97 • Vespa Et4 96-98
(R.O. 82523R)





SEMIPULEGGE MOTRICI FISSE

FIXED DRIVE HALF PULLEY

PIAGGIO

10 032 0691



NEW

125: Liberty Iget 4T 3V Ie 15-17 • Vespa Lx Primavera 4T 3V Ie 13-17 • Vespa Primavera 4T 3V Iget Abs 16 • Vespa Sprint 4T 3V Ie 14-15 • Vespa Sprint iget 4T 3V Abs 16-17 (R.O. 1A000798)



10 032 0160



180: Hexagon Gtx 00 • Super Hexagon Gtx 12" 01-02 • X9 Amalfi 00-03
200: Beverly 01-03 • Carnaby 07-08 • Liberty 06 • Liberty 4t Eu3 07-08 • Vespa Granturismo 03-07 • X8 05-07 • X9 02-03 (R.O. 834774)



10 032 0150



125: Beverly Rst 04-05 • Beverly 01-03 • X8 04 • X9 Evolution 03 (R.O. 485118)



10 032 0200



125: Hexagon Lx • Lxt 98-99
150: Skipper Lx 98-99
180: Hexagon Lx • Lxt 98-99 (R.O. 487957)



10 032 0240



400: Beverly Eu3 06-07 • Beverly Tourer Eu3 08-10 • Mp3 ie Lt Touring 11 • Mp3 Mic 08-10 • Mp3 RL Touring 11 • Mp3 07-08 • X8 Eu3 06-08 • X Evo 07-11
500: Beverly 02-06 • Beverly Cruiser 07-12 • Beverly Eu3 06-08 • Mp3 Lt Sport 11-13 • Mp3 RL Sport 11-12 • Mp3 Lt Business Abs 14-16 • X9 Evolution 03-07 • X9 Evolution Abs 06-07 • X10 4T 4V ie Eu3 12-14 (R.O. 832697)



10 032 0270



250: Beverly 06-07 • Beverly Cruiser 07-09 • Carnaby 08 • Mp3 06-08 • Mp3 Lt 08-09 • Vespa Gts/Gts Abs 05-09 • Vespa Gt 60 Eu3 06-07 • Vespa Gtv 07-09 • X7/X8 Eu3 05-08 • X9 Evolution 04-06
300: Beverly ie Tourer 09-10 • Beverly Rst 4T 4V 10-15 • Beverly ie Abs Eu4 16 • Mp3 ie Lt 10-11 • Mp3 ie Lt Sport 11-14 • Mp3 Yourban ERL 11-15 • Carnaby Cruiser 09 • Vespa Gts Super 08-15 • Vespa Gtv 4T 4V 10-13 • Vespa Gts ie 11-16 • X7 Evo Ie Eu3 09 (R.O. 840193)



10 032 0311



125: Beverly Tourer Eu3 07-10 • Beverly Rst 04-07 • Beverly Eu3 Mic 07 • Carnaby 07-10 • Fly 05-07 • Fly Eu3 07-11 • Hexagon Gtx 00 • Liberty 01-02 • Liberty 4T 06-07 • Liberty Rst Ptt 05-11 • Liberty Sport 06 • Liberty 4T Eu3 Delivery 07-15 • Mp3 06-08 • Super Hexagon Gtx 12" 01-02 • Vespa Et4 99-02 • Vespa Lx 05-06 • Vespa Granturismo 03-07 • Vespa Gtv 06-08 • Vespa Lx Eu3 09-11 • Vespa Lx ie 4T 10-13 • X7 Eu3 08 • X8 05-06 • X8 Premium Eu2 06-07 • X9 Evolution 03-06 • Zip 00-02
150: Fly 05-07 • Fly Eu3 08-11 • Liberty 01-02 • Liberty 4T Eu3 08 • Liberty Moc 4T 09-13 • Vespa Et4 99-02 • Vespa Lx 05-06 • Vespa Lx 4T FL 09 • Vespa Lx Eu3 06-11 • Vespa S 4T ie 08-12 • X8 Street Eu2 06-08 (R.O. 845607)





YAMAHA

10 032 0211



50: Aerox 97-02 • Breeze 94-95 • Bw's Bump 97-98 • Bw's Naked 03 • Bw's Ng 97-06 • Bw's Original 97-02 • Jog R 02-05 • Neo's 02-06 • Why Eu1 99-00 • Why Eu2 03-05 • Why 98-06 (R.O. 3VLE76110000)

10 032 0671



NEW

125: Xn Teo'S 00 • Xq Maxter 01-02 • Yp Majesty 01-07
150: Xn Teo'S 01-02 • Xq Maxter 01-02 • Yp Majesty 01-02
180: Yp Majesty 03-06 (R.O. 5DSE76110000)

10 032 0681



NEW

125: Gpd-A N-Max 15-17
150: Gpd-A N-Max 17 (R.O. 5DSE76110000)





SEMIPULEGGE MOTRICI MOBILI
MOVABLE DRIVE HALF PULLEY

APRILIA

10 032 0020 

50: Scarabeo 4T Rst Eu3 06-09
Scarabeo Quattro 09 • Sr R R Factory 04-09 • Sr
Street 03-08 • Scarabeo 4T 02-06 • Scarabeo
4T 4V 09-14 • Sr Iniezione e carburatore 14 • Sr
Motard 4T 4V 13-14
(R.O. CM110304)



10 032 0030 

50: Mojito 04-10 • Sport City One 4T 08-10
• Sr R R Factory Modello Carburatore 04-09
• Sr Street Modello Carburatore 03-12
(R.O. AP8515112)



10 032 0040 

50: Scarabeo Street 05-06 • Scarabeo Street 2T
Rst 06-09 • Sport City One 2T 08-09
(R.O. CM110302)



10 032 0050 

125: Mojito Retro' • Custom 99-01
(R.O. AP8550509)



10 032 0060 

125: Atlantic 03-05 • Scarabeo 03-06 • Scarabeo
Eu3 06-07 • Atlantic Eu3 06-12 • Scarabeo Light
07-08 • Scarabeo ie Light 09-12 • Sport City
Eu3 06-08 • Sport City 04-06 • Sport City Cube
08-10 • Sport City Street 12 • Sr Max 11-14
(R.O. AP8580222-CM144403)



10 032 0170 

200: Sport City Eu3 06-08 • Sport City 04-06
• Sport City Cube 08-10 • Atlantic 03-05 •
Scarabeo 03-07
(R.O. CM144404)



10 032 0190 

125: Mojito 03-08 • Scarabeo Light 07-08
• Sport City One 08-11 • Sr Motard 12-14
(R.O. CM144402)



10 032 0230 

500: Atlantic 01-09 • Atlantic Sprint 05-08 •
Scarabeo Light 06-08 • Atlantic 01-04
(R.O. AP8560180)



10 032 0260 

250: Sport City 06-08 • Sport City Cube 08-12
• Atlantic 03-05
(R.O. CM144407)



10 032 0330 

400: Atlantic Sprint 05-08
(R.O. 849913)



10 032 0340 

250: Atlantic Eu3 06-08 • Scarabeo Light 06-08
• Sport City Cube 08-12
300: Atlantic 10-11 • Scarabeo Light 09-10 •
Sport City Street 12 • Sr Max 11-14
(R.O. CM144408)





DERBI

10 032 0030 

50: Atlantis 02-10 • Atlantis 2T Eu2 07-09 • Atlantis 4T Eu2 07 • Atlantis 50-100 4T 04-06 • Atlantis 02 Bullet 03-05 • Atlantis 02 City 03-06 • Atlantis 02 Red Bullet 03 • Atlantis 02 Two Chic 05 • Atlantis 02 02 • Gp1 01-09 • Gp1 Eu2 05 • Gp1 Race Eu2 05-07 • Gp1 Open Eu2 06-09 • Gp1 01-03
(R.O. CM110301)



10 032 0040 

50: Atlantis 03-05 • Boulevard 09-14 • Sonar 09 • Variant Sport 2T 12
(R.O. CM110302)



10 032 0060 

125: Gp1 Eu2 06-Gp1 Low Seat Eu3 07-08 • Rambla 08
(R.O. CM144403)



10 032 0070 

125: Boulevard 04-12 • Sonar 4T 09-11 • Variant Sport 12
(R.O. CM103903)



10 032 0080 

150: Boulevard 02-04
(R.O. CM103901)



10 032 0170 

200: Boulevard 05-06
(R.O. CM144404)



10 032 0180 

150: Boulevard Eu2 04-07 • Boulevard Eu3 10 • Sonar 4T 09
(R.O. CM144401)



10 032 0190 

125: Boulevard Eu3 04-07 • Boulevard 4T Eu3 08-09
(R.O. CM144402)



10 032 0260 

250: Gp1 Low Seat Eu3 07-08 • Gp1 06-07
(R.O. CM144407)

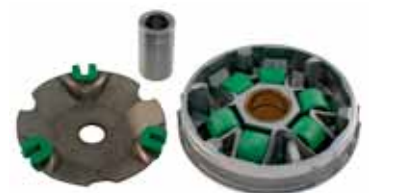

10 032 0340 

250: Rambla Eu3 08 • Rambla 08-09
300: Rambla 10-11
(R.O. CM144408)





SEMIPULEGGE MOTRICI MOBILI
MOVABLE DRIVE HALF PULLEY

GILERA

10 032 0010



50: Typhoon X 98-99 • Typhoon 94-97 • Easy Moving 95-96 • Storm 94-95
(R.O.430189)



10 032 0020



50: Dna Gp Experience 03-04 • Runner Purejet St 08 • Runner Purejet 02-11 • Runner 97-00
(R.O.CM110304)



10 032 0030



50: Dna 05-07-Runner Sp Special Edition 07 • Runner Sp St & Simoncelli 08-09 • Runner Sp 05-12 • Stalker Mod. < 03 97-04 • Storm Eu2 07 • Typhoon Xr 00
(R.O. CM110301)



10 032 0040



50: Dna 00-02-Ice 01-05 • Runner Poggiali 02 • Runner Sp 02-04 • Stalker Naked 08 • Stalker Special Edition 07-08 • Stalker Mod. 03 > 97-11
(R.O. CM110302)



10 032 0060



125: Nexus Eu3 ie 08-09 • Runner Vx 4T Eu3 07 • Runner Vx 4T St Eu3 08-13 • Runner Vx Race 06 • Runner Vx Sc 06-07 • Runner Vx-Vxr 00-07 • Runner Vx 05-06 • Dna 01
(R.O. CM103904 • CM144403)



10 032 0090



125: Runner Fx-Fxr 97-02 • Typhoon X-Xr 99-00 • Typhoon 95-98
(R.O. CM102901)



10 032 0100



200: Runner Vx-Vxr 02-04
(R.O. 832842)



10 032 0110



180: Runner Fx-Fxr 97-02
(R.O. 487954)



10 032 0170



200: Runner Vxr 4T St Eu3 08 • Runner Vxr Eu3 07 • Runner Vxr Race 06 • Runner Vxr 05-06
(R.O. CM144404)



10 032 0230



500: Fuoco 07-09 • Nexus Eu3 06-09 • Nexus Sp Eu3 06-07
(R.O. 833291)



10 032 0350



125-150: Sh



10 032 0420



125: Pcx



HONDA



KYMCO

10 032 0380 

50: Agility 4T Carry 11 • R10 06 • R12 05-08
Rs 09 Like 4T 09



10 032 0400 

125: Agility R16 08-12 • Movie 99-00 • People 99-00
• People Eu2 03 • People Eu3 07-11 • People S 05 •
People S Eu3 07-08 • Super8 08-09 • Vivio 00
150: Agility R16 08-09
200: People S 05 • People S I 07



10 032 0490 

500: X Citing 05-09



10 032 0430 

125: Agility 4T Eu3 06-08 • Agility 4T 06 • Agility
Carry 11 • Agility Rs 09 • Like Lx 12 • Like 09 • Movie
Eu3 06-07 • Movie XL Eu2 03-04 • Movie XL 01
• People One I 13
200: Agility i R16 10 • Agility R16 12 • Like i 09
• Like Lx 12



MBK

10 032 0280 

50: Scooter Vari - Motori Minarelli
Various scooter - Minarelli engine



10 032 0290 

250: Yp Skyliner 00-03 • Yp Skyliner Abs 03
(R.O. 5GM176200000)



10 032 0370 

300: Xc Kilibre 03





SEMIPULEGGE MOTRICI MOBILI
MOVABLE DRIVE HALF PULLEY

PIAGGIO

10 032 0010



50: Free FL 95-02 • Free 92-94 • Nrg 94-96 • Quartz 92-96 • Sfera Maquillage 2 94 • Sfera Rst 95-97 • Zip Rst 96-99 • Zip Bimodale 94-97 • Ntt 95-96 • Zip 95-96 • Zip Fast Raider 93-94 • Zip Fast Raider Rst 96-97
(R.O. 430189)

10 032 0020



50: Liberty 4T 00-02 • Nrg Power Purejet 04-08 • Nrg Purejet 02-04 • Nrg Rst Mc2 96-98 • Vespa Et4 00-05 • Vespa S 4T-4V 08-09 • Zip 4T Mod. 2000 00-05 • Vespa Lx 4T-4V 09
(R.O. CM110304)

10 032 0030



50: Diesel 01-Fly 4T Motore Chn 06-07 • Fly 4T 05-08 • Free Delivery 00-01 • Free FL Mod. 2002 95-02 • Liberty 4T Rst 04 • Liberty 4T Sport 06-08 • Liberty 4T 05-08 • Liberty Moc 4T 09 • Liberty 97-05 • Nrg Extreme 99-00 • Nrg Mc3 01-04 • Nrg Power Dd Serie Spec 07-08 • Nrg Power Dd 05-09 • Nrg Power Dt Serie Spec 07-08 • Nrg Power Dt 06-08 • Typhoon 01-09 • Vespa Et2 97-05 • Vespa Lx 4T 05-08 • Zip 4T 00-08 • Zip Sp Eu2 06-09 • Zip Sp 01-04
(R.O. CM110301)



10 032 0040



50: Liberty 2T Rst 04 • Liberty 2T Sport 06-08 • Liberty 2T 06-08 • Liberty Moc 2T 09 • Liberty Ptt Eu2 04-05 • Liberty Mod. Cat. 2000 97-05 • Vespa Et2 Iniez. 97-00 • Vespa Lx 2T FL 09-10 • Vespa Lx 2T 05-08 • Vespa Lxv 2T Navy 08 • Vespa Lxv 2T 06-08 • Vespa S 2T 07-08 • Zip 2T 08-09 • Zip 00-04
(R.O. CM110302)

10 032 0050



125: Hexagon Lx4 98-99 • Liberty 98-00 • Sfera 95-97 • Vespa Et4 96-98
(R.O. 82522R)

10 032 0060



125: Beverly Eu 3 Mic 07 • Beverly Eu3 07-08 • Beverly Rst 04-07 • Beverly Rst 4T 4V ie Eu3 10-13 • Beverly 01-03 • Beverly Tourer Eu3 07-10 • Carnaby 07-10 • Hexagon Gtx 00 • Mp3 ie - Ibrido - Yourban ERL 08-12 • Super Hexagon Gtx 01-02 • Vespa Gt - Eu3 03-07 • Vespa Gts 4T ie - Navy - Eu3 07-13 • Vespa Gtv 07-08 • X Evo 07-12 • X10 4T 4V ie 12-13 • X7 Eu3 08-10 • X8 - Premium Eu3 05-07 • X9 - Evolution - Eu3 01-07
(R.O. CM144403)



10 032 0070



125: Beverly 01-03
(R.O. CM103903)

10 032 0080



150: Liberty Per Modelli < 2005 01-02 • Skipper 4T Per Modelli < 2005 00-02 • Vespa Et4 Per Modelli < 2005 99-02
(R.O. CM103901)

10 032 0090



150: Skipper Lx 98-99
(R.O. 483981)

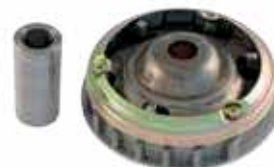



PIAGGIO

10 032 0100 

180: Hexagon Gtx 00 • Super Hexagon Gtx 12 01-02 • X9 Amalfi 00-03
(R.O. 827693)



10 032 0110 

180: Hexagon Lx-Lxt 98-99
(R.O. 487954)



10 032 0170 

200: Carnaby 07-08 • Liberty 4T Eu3 07-08 • Liberty 4T Sport Eu3 06-07 • Liberty Sport 06 • Liberty 06 • Vespa Granturismo 06-07 • X8 05-07 • Beverly 01-03
(R.O. CM144404)



10 032 0180 

150: Fly Eu3 08 • Fly 05-07 • Liberty 4T Eu3 08 • Liberty 4T Sport Eu3 08 • Liberty Moc 4T 09 • Vespa Lx 4T FL 09 • Vespa Lx Eu 3 ie 09 • Vespa Lx Eu 3 06-08 • Vespa Lx 05-06 • Vespa S 4T ie 09 • Vespa S 4T 08-09 • X8 Street Eu 2 06-08
(R.O. CM144401)



10 032 0190 

125: Fly Eu3 07-08 • Fly 05-07 • Liberty 01-02 • Liberty 4T Eu3 Delivery 08 • Liberty 4T Eu3 07-08 • Liberty 4T Sport Eu3 06-08 • Liberty 4T 06-07 • Liberty Rst Ptt 05-06 • Liberty Rst 04-05 • Liberty Sport 06 • Skipper 4T 00-02 • Vespa Et4 99-02 • Vespa Lx 4T FL 09 • Vespa Lx Eu 3 06-08 • Vespa Lx 05-06 • Vespa Lxv 4T Eu3 06-09 • Vespa Lxv 4T Navy Eu3 08 • Vespa S 4T Eu 3 07-08 • X8 Street Eu 2 06-07 • Zip 00-02 • Vespa Lxv ie 4T 10 • Vespa S 4T ie 09
(R.O. CM144402)



10 032 0230 

500: Beverly Cruiser 07-11 • Beverly Eu 3 06-08 • Beverly 02-06 • X9 Evolution Abs 06-07 • X9 Evolution 03-07 • X9 01-02
(R.O.833291)



10 032 0260 

250: Beverly Rst 04-05 • Beverly 06-07 • Mp3 Lt 09 • Mp3 Mic 08-09 • Mp3 06-08 • Vespa Gt 60 Eu 3 06-07 • Vespa Gts, Gts Abs 05-09 • Vespa Gtv 4T Navy Eu3 08 • Vespa Gtv 06-09 • Xevo 07 • X7 Eu 3 08 • X8 Eu3 05-08 • X9 Evolution 04-06
(R.O. CM144407)



10 032 0330 

400: Beverly Eu 3 06-07 • Beverly Tourer Eu3 08-09 • Mp3 Lt 09 • Mp3 Mic 08-09 • Mp3 07-08 • X Evo 07-09 • X8 Eu3 06-08
(R.O. 849913)



10 032 0340 

250: Beverly 300 ie Tourer 09 • Carnaby Cruiser 09 • Vespa Gts Super 08 • X7 Evo ie Eu 3 09
300: Beverly 300 ie Tourer 09 • Carnaby Cruiser 09 • Vespa Gts Super 08 • X7 Evo ie Eu 3 09
(R.O. CM144408)





SEMIPULEGGE MOTRICI MOBILI
MOVABLE DRIVE HALF PULLEY

YAMAHA

10 032 0280 

50: Scooter Vari Per Motori Minarelli



10 032 0290 

250: Yp Majesty Abs 03 • Yp Majesty 00-01
• Yp Majesty 02-03
(R.O. 5GM176200000)



10 032 0360 

125: Vp X-City 08-11



10 032 0370 

250: Yp R X Max 06-12
300: Xc Versity 06





APRILIA

10 034 0110 

125: Mojito Retrò • Custom 99-01
(R.O. AP8550346)



10 034 0150 

400-500: Atlantic Sprint 05-08 • Scarabeo light
06-08



10 034 0200 

200: Atlantic 03-05 • Scarabeo 03
250: Atlantic 03-05 • Scarabeo 04-06
Sport City Eu3 06-08 (R.O. AP8580208)
300: Scarabeo Light 09 • Sport City Cube 08



10 034 0210 

125: Atlantic 03-05 • Scarabeo 03- Sport City
04-06 • Sport City Street 12-13 • Sr Max 11-13
(R.O. AP8575013)



10 034 0100 

Motori Minarelli - Aprilia 50 cc
(Per frizioni Ø 107)
For Minarelli - Aprilia Engines 50 cc
(For Ø 107 clutches)



10 030 0470 

PERNO GUIDA VARIATORE - PULLEY PIN
APRILIA 50-100 • (R.O. AP8551041)
(Conf. 5 pz - 5 pcs set)



DERBI

10 034 0210 

125: Boulevard 02-04 • Gp1 Eu2 06
150: Boulevard 02-04 • Boulevard Eu3 04-07
200: Boulevard 05



10 034 0200 

250: Gp1 06-07 • Rambla 08



GILERA

10 034 0060 

50: Typhoon 94-97 • Typhoon X 98-99 • Easy
Moving 95-96 • Storm 94-95
(R.O. 430190)



10 034 0210 

125: Nexus Eu3 07-08 • Runner Vx 05-06
(R.O. 830580)



10 034 0200 

200: Runner Vxr 05-06 • Nexus Eu3 06-07
250: Nexus Sp Eu3 06-07 • Oregon 06-08
300: Nexus Eu3 08-09 • (R.O. 833669)



10 034 0150 

500: Fuoco 07-09 • Nexus 03-05 • Nexus Eu3
06-08 •
(R.O. 832774-846696)





SEMIPULEGGE CONDOTTE FISSE

FIXED DRIVEN HALF PULLEY ASSY

MBK

10 034 0100 

Motori Minarelli - MbK 50 cc
(Per frizioni Ø 107)
For Minarelli - MbK Engines 50 cc
(For Ø 107 clutches)



10 034 0230 

250: Skyliner 00-03 - Abs 03
300: Kylibre 03
(R.O. 5GM176680010)



PIAGGIO

10 034 0060 

50: Free 92-94 • Free FI 95-02 • Nrg 94-96 • Ntt 95-96 • Quartz 92-96 • Sfera Maquillage 2 94 • Vespa Et2 97-05 • Zip 95-96
(R.O. 430190)



10 034 0110 

125: Hexagon Lx4 8-99 • Liberty 98-00 • 125 Sfera 95-97 • Vespa Et4 96-98
(R.O. 4780745)



10 034 0150 

400: Mp3 Mic 08-09
500: Beverly 02-06 • Beverly Cruiser 07-09 • X9 Evolution 03-05
(R.O. 832774-846696)



10 034 0200 

200: Carnaby 07-08-X9 02-03 • Beverly 06-07
250: Carnaby 08 • Mp3 06-08 • Vespa Gt 60 Eu3 06-07
300: Beverly 300 le Tourer 09 • Carnaby Cruiser 09 • X7 Evo le Eu3 09
(R.O. 833669)



10 034 0210 

125: Beverly 01-03 • Carnaby 07-09 • Fly 05-07 • Liberty 01-02 • Mp3 07-08 • Skipper 4T 00-02 • Vespa Et4 99-02 • X7 Eu3 08-Zip 00-02
150: Fly 05-07-Liberty 4T Eu3 08 • Vespa Lx 05-06
180: X9 Amalfi 00-03
200: Liberty 06
(R.O. 830580)



10 034 0130 

PULEGGIA - PULLEY
50: Ciao • Bravo • SI Monomarcia (No Variator) Ø 90 mm
(R.O. 103049)



10 041 0010 

KIT RICAMBIO PER PULEGGIA
MOTRICE VARIATORE
REPLACEMENT KIT FOR PULLEY
PIAGGIO: Ciao • Px • FL • Teen • Ciao tre Si • Si FL2 • Bravo • Superbravo • Boss • Grillo
Composto da: 8 Rulli, 16 Semigusci
Composed by 8 rolls • 16 Half shells
(R.O. 104559-60)



YAMAHA

10 030 0470 

PERNO GUIDA VARIATORE - PULLEY PIN
PIAGGIO 50-100 • (R.O. 482766)
(Conf. 5 pz - 5 pcs set)



10 034 0100 

Motori Minarelli - Yamaha 50 cc
(Per frizioni Ø 107)
For Minarelli - Yamaha Engines 50 cc
(For Ø 107 clutches)



10 034 0230 

250: Vp X-City 07-12 • Yp Majesty Abs 03 • Yp Majesty Dx 98-99 • Yp Majesty 96-03 • Yp R Black X-Max 09 • Yp R X-Max Abs 11-12 • Yp R X-Max Sport 11-12 • Yp R X-Max 05-12
300: Xc Versity 03-06
(R.O. 5GM176680010)





APRILIA

10 034 0020

50: Mojito 04-08 • Scarabeo 4T 02-06 • Sport City One 2T-4T 08-09 • Sr Street 03-08
100: Scarabeo 4T 01-04
(R.O.AP8551055)



10 034 0050

Motori Minarelli - Aprilia 50 cc
(Per frizioni Ø 107)
For Minarelli-Aprilia Engines 50 cc
(For Ø 107 clutches)



10 034 0190

125: Scarabeo le Light 09-12 • Scarabeo Light 07-08
250: Atlantic 03-05 • Scarabeo 04-06
(R.O.AP8577055) • Sport City Eu3 • Cube 06-08
300: Scarabeo Light 09 • Sport City Street 12 • Sr Max 11-14
(R.O. 878651)



10 034 0220

125: Atlantic Eu3 06-08 • Sport City 04-06 • Mojito 03-07 • Scarabeo Mot. Piaggio Eu3 06 • Scarabeo 03-06 • Sport City Cube 08-10 • Sport City Eu3 06-08 • Sport City 04-06
200: Scarabeo Light 07-08
(R.O. 827499)



10 034 0160

400-500: Scarabeo Light 06-08
(R.O. 846696)



DERBI

10 034 0020

50: Atlantis 2T-4T Eu2 07-09 • Gp1 01-03



10 034 0220

125: Gp1 Eu2 06 • Rambla 08
150-200: Boulevard 02-05
(R.O. 87899)



10 034 0190

250: Rambla 08-09 • Gp1 06-08
(R.O. 841774)



GILERA

10 034 0160

500: Fuoco 07-09
Nexus 03-05 • Nexus Eu3 06-09 • Nexus Sp Eu3 06-07
(R.O.832808)



10 034 0190

250: Nexus Eu3 06-07 • Nexus Sp Eu3 06-07 • Oregon 06-08
300: Nexus Eu3 08-09
(R.O.841774)



10 034 0220

125: Nexus Eu3 07-08 • Runner Vx 05-06
180: Dna 01
(R.O.827499)





SEMIPULEGGE CONDOTTE SCORREVOLI

SLIDING DRIVEN HALF PULLEY

MBK

10 034 0050 

Motori Minarelli - MbK 50 cc
(Per frizioni Ø 107)
For Minarelli - MbK Engines 50 cc
(For Ø 107 clutches)



10 034 0030 

250: Skyliner 00-03 - Abs 03
300: Kylibre 03
(R.O. 4HC176701100)



PIAGGIO

10 034 0010 

50: Free FL 95-02 • Free 92-94 • Nrg Rst Mc2 96-98 • Nrg 94-96 • Ntt 95-96 • Quartz 92-96 • Sfera Maquillage 2 94 • Sfera Rst 95-97 • Vespa Et2 97-05 • Zip Bimodale 94-97 • Zip Fast Raider Rst 96-97 • Zip Fast Raider 93-94 • Zip Rst 96-99 • Zip Sp 96-00 • Zip 95-96
(R.O. 430191)



10 034 0020 

50: Fly 2T-4T 05-07 • Liberty 97-05 • Liberty 2T 06-08 • Liberty 4T 05-08 • Nrg Purejet 02-04 • Typhoon 01-09 • Vespa Et2/Et4 97-05 • Zip 00-04
100: Fly 4T 06-07 • Zip 4T 06-08
125: Vespa S 4T le 09
(R.O.827893) • (R.O.436875)



10 034 0120 

125: Hexagon Lx4 98-99 • Liberty 98-00 • Sfera 95-97 • Vespa Et4 96-98
(R.O.4780725)



10 034 0160 

400: Mp3 Mic 08-09
500: Beverly 02-06 • Beverly Cruiser 07-09
Beverly Eu3 06-08 • X9 Evolution 03-07 X9
Evolution Abs 06-07
(R.O.832808)



10 034 0190 

250: Beverly 06-07 • Beverly Cruiser 07-09 • Carnaby 08 • Mp3 06-08 • Vespa Gtv 06-09 • X7 Eu3 08 • X8 Eu3 05-08 • X9 Evolution 04-06
300: Beverly 300 le Tourer 09 • Vespa Gts Super 08 • X7 Evo le Eu3 09
(R.O.841774)



10 034 0220 

125: Beverly 01-03 • Beverly Eu3 07-08 • Carnaby 07-09 • Mp3 07-08 • Vespa Gt 03-07 • X8 04-06 (R.O.827499)
150: Fly 05-07 • Liberty 01-02 • Liberty 4T Eu3 08 • Vespa Et4 99-02 • Vespa Lx 05-06
180: Hexagon Gtx 00 • X9 Amalfi 00-03
200: Liberty 06 • Liberty 4T Eu3 07-08



YAMAHA

10 034 0050 

Motori Minarelli - Yamaha 50 cc
(Per frizioni Ø 107)
For Minarelli - Yamaha Engines 50 cc
(For Ø 107 clutches)



10 034 0030 

250: Vp X-City 07-12 • Yp Majesty Abs 03 • Yp Majesty Dx 98-99 • Yp Majesty 96-03 • Yp R Black X-Max 09 • Yp R X-Max Abs 11-12 • Yp R X-Max Sport 11-12 • Yp R X-Max 05-12
300: Xc Versity 03-06
(R.O. 4HC176701100)





KIT PULEGGIA MOTRICE + CINGHIA DAYCO
FRONT PULLEY KIT + DAYCO BELT



CODICE KIT - CODE	DESCRIZIONE DESCRIPTION	CODICE RMS RMS CODE	RIFERIMENTI ORIGINALI OEM NUMBER		
			PIAGGIO	APRILIA	GILERA
16 381 0010 	Semipuleggia Motrice - <i>Drive half pulley</i>	10 032 0280	-	-	-
	Semipuleggia fissa - <i>Fixed pulley</i>	10 032 0210	-	-	-
	Cinghia Dayco - <i>Dayco belt</i>	16 375 0082	-	-	-
16 381 0020 	Semipuleggia Motrice - <i>Drive half pulley</i>	10 032 0290	-	-	-
	Cinghia Dayco - <i>Dayco belt Kevlar</i>	16 375 0650	-	-	-
16 381 0080 	Semipuleggia Motrice - <i>Drive half pulley</i>	10 032 0060	CM144403	-	-
	Semipuleggia fissa - <i>Fixed pulley</i>	10 032 0310	PIAGGIO 125 cc	845607	-
	Cinghia Dayco - <i>Dayco belt Kevlar</i>	16 375 0600		842009	-



DISCO CONTENITORE RULLI

ROLLER WEIGHT HOUSING

10 030 0090



APRILIA 125: Mojito 03-08 • Sport City One 08
DERBI 125: Boulevard 02-04
GILERA 125-180-200: Dna 01
 • Runner Vx • Vxr 00-02
PIAGGIO 125: Beverly 01-03 • Fly 05-07
 • Liberty 01-02 • Vespa Et4 99-02 • Vespa
 Lx 05-06 • X8 Street Eu2 06-07 • Zip 00-02
 (R.O.485710)



10 030 0100



GILERA 50: Easy Moving 95-96 • Storm 94-95
 • Typhoon 94-97
PIAGGIO 50: Free 92-94 • Free FL 95-02 • Nrg
 94-96 • Quartz 92-96 • Sfera Maquillage 2 94 •
 Sfera Rst 95-97 • Zip Rst 96-99
 (R.O. 430189)



10 030 0110



APRILIA 50: Mojito 04-08 • Scarabeo 4T Rst
 Eu3 06-09 • Sport City One 2T-4T 08-09 • Sr
 Street 03-08
DERBI 50: Atlantis 02 • Atlantis 2T-4T Eu2 07-
 09 • Boulevard 2T 09 • Gp1 01-0
GILERA 50: Dna 00-07 • Ice 01-05 • Runner 97-00
 • Stalker 97-09 • Storm Eu2 07 • Typhoon Xr 00
PIAGGIO 50: Diesis 01 • Fly 2T-4T 05-07 • Free
 FL 95-02 • Liberty 97-05 • Liberty 2T 06-08
 • Liberty 4T 00-08 • Nrg Purejet 02-04
 • Typhoon 01-09 • Vespa Et2-Et4 97-05 • Vespa
 Lx 2T 05-08 • Vespa Lx 4T 05-08 • Zip 00-04 •
 Zip 2T-4T 08-09
100: Fly 4T 06-08 • Free 02-03 • Zip 4T 06-10
 (R.O. 480227)



10 030 0150



APRILIA 125: Atlantic 03-05 • Scarabeo 03-06 •
 Sport City 04-06
200: Sport City 04-06 • Sport City Cube 08 •
 Sport City Eu3 06-08
250: Sport City Eu3 06-08
DERBI 125: Gp1 Eu2 06 • Rambla 08
200: Boulevard 05 • **250:** Gp1 06-07
GILERA 125: Dna 01 • Nexus Eu3 ie 08-09
200: Runner Vxr Eu3 07
250: Nexus Eu3 07 • Oregon 06-08
PIAGGIO 125: Beverly Tourer Eu3 08-09 •
 Carnaby 07-09 • Hexagon Gtx 00 • Mp3 07-08 •
 Vespa Gt Eu3 06-07
150: Fly 05-07 • Liberty 01-02 • Liberty 4T
 Eu3 08 • Vespa Et4 99-02 • Vespa Lx 05-06 • X8
 Street Eu2 06-08
180: Hexagon Gtx 00 • Super Hexagon Gtx 12"
 01-02 • X9 Amalfi 00-03
200: Beverly 01-03 • Carnaby 07-08 • Liberty
 4T Eu3 07-08 • Vespa Gt 03-07
250: Beverly 06-07 • Mp3 06-08 • X7 • X8 Eu3
 05-08
300: Beverly Rst 4T 4V ie Eu3 10-11 • Beverly
 Tourer Eu3 09-10 • Carnaby Cruiser 09-11 •
 Mp3 ie Lt 10-11 • Mp3 ie Mic 10-11 • Mp3 4T
 4V ie Lt Ibrido 10-11 • Mp3 ie Lt Touring 11 •
 Mp3 ie Lt ie Lt Sport 11 • Mp3 ie Touring 11 •
 Mp3 Yourban Erl 11 • Mp3 Yourban Lt Erl 11
 • Vespa Gts ie Touring 11 • Vespa Gts Super
 Sport 10-11 • Vespa Gts Super 08-11 • Vespa
 Gtv 4T 4V ie 10-11 • Vespa Gtv Via Montenapo-
 leone 10 • X7 Evo ie Eu 3 09-10
 (R.O. 842204)



10 030 0120



GILERA 180: Runner Fx • Fxr 97-02
PIAGGIO 125-150-180: Hexagon Lx
 Lxt 98-99 • Skipper Lx 98-99
 (R.O. 435893)



10 030 0210



APRILIA 500: Atlantic 01-04 • Atlantic Sprint
 05-08 • Scarabeo Light 06-08
GILERA 500: Fuoco 07-09 • Nexus Eu3 06-09
 • Nexus Sp Eu3 06-07
PIAGGIO 500: Beverly 02-06 • Beverly Cruiser
 07-09 • Beverly Eu3 06-08 • X9 Evolution 03-07
 • X9 Evolution Abs 06-07
 (R.O. 829344)



10 030 0130



APRILIA 125: Mojito Retro' • Custom 99-01
PIAGGIO 125: Hexagon Lx4 98-99 • Liberty
 98-00 • Sfera 95-97 • Vespa Et4 96-98
 (R.O. 436699)



10 030 0220



APRILIA 400-500 : Atlantic Sprint 05-08
 • Scarabeo Light 06-08
GILERA 500: Fuoco 06-10 • Nexus Eu3 06-10
PIAGGIO 400 Beverly Tourer Eu3 06-07 • Mp3
 07-08 • X Evo 07-09 • X8 Eu3 06-08
500: Beverly Cruiser 07- 08 • Beverly 05-06 • X9
 Evolution 06-07
 (R.O. 830901)



10 030 0140



MINARELLI-MBK-YAMAHA 50 cc
 (R.O.3VLE76230000)



10 050 0010

MINARELLI-MBK-YAMAHA 50
 (Kit 3 pezzi - *Kit 3 pcs*)

10 050 0020

GILERA PIAGGIO 50: (Tutti i modelli-*All Models*)
PIAGGIO100: Free
 (R.O. 289931)
 (Kit 3 pezzi - *Kit 3 pcs*)

10 050 0040

PIAGGIO: Beverly 500 02-04
 X9 Evolution 500 03-04
 (Kit 3 pezzi - *Kit 3 pcs*)
 (R.O. 833293)

10 050 0050

PIAGGIO: Beverly 400-500 • X8 400
 (Kit 4 pezzi - *Kit 4 pcs*)
 (R.O. 842175)

10 050 0060

PIAGGIO: Beverly Rst 250 04-05
 Beverly Euro 3 250 • 06-X8 250 05-06
 Vespa Gts 250 05-06
 (Kit 3 pezzi - *Kit 3 pcs*)
 (R.O. 843028)

10 050 0080

CON DISTANZIALE - WITH SPACER
YAMAHA 250: Yp Majesty Abs 03 • Dx 98-00
 Yp Majesty 96-03 • Xc Versity 03-06
MBK 250-300: Yp Skyliner Abs 03 • Yp Skiliner
 00-03 • Xc Kilibre 03
 (Kit 4 pezzi - *Kit 4 pcs*)
 (R.O. 4H176530000+4HC176540000)

10 050 0090

HONDA 125-150: Sh
 (Kit 3 pezzi - *Kit 3 pcs*)

10 050 0100

PIAGGIO 125: Liberty-Beverly
 (Kit 3 pezzi - *Kit 3 pcs*)
 (R.O. 434855)

10 050 0110

GILERA 125: Runner
 (R.O. 431280)
 (Kit 6 pezzi - *Kit 6 pcs*)

10 050 0120

CON DISTANZIALE - WITH SPACER
YAMAHA 250: X Max 05-10
 (Kit 4 pezzi - *Kit 4 pcs*)

10 050 0130

YAMAHA 125: X-Max
 (Kit 3 pezzi - *Kit 3 pcs*)
 (R.O. 1B9E76530000)

10 050 0160

YAMAHA 400: Xp X/Max 13-14
 (Kit 4 pezzi - *Kit 4 pcs*)
 (R.O. 1SDF581T0000)

12 185 5070

PIASTRINA TRAINO - FIXED PULLEY
TOOTHED WASHER
MINARELLI-MBK-YAMAHA 50
 (R.O. 902141305800)

14 274 0080

VENTOLA VOLANO MODIFICATA
MODIFIED FLYWHEEL FAN
 Migliora il raffreddamento
Improve engine cooling
 MINARELLI • YAMAHA • MBK 50cc
 Cilindro verticale - *Vertical cylinder*

14 274 0060

VENTOLA PULEGGIA MOTRICE
DRIVING PULLEY FAN
GILERA 50: Dna 00-01 • Ice 01 • Stalker 97-01
 • Typhoon XR 00 • Runner 97-00 • Poggiali - FL
 - Purejet 02
PIAGGIO 50: Diesis 01 • Free Delivery 00-01
 • Liberty 97-02 • 4T 00-02 • Nrg Rst Mc2 96-98
 • Extreme 99-00 • MC3 01-02 • Purejet 02
 • Typhoon 01 • Vespa Et2 97-01 • Et4 00-02
 Zip 2/4 T 00 • Rst 96-99 • SP 01
100: Free 02

14 274 0070

VENTOLA PULEGGIA MOTRICE
DRIVING PULLEY FAN
PIAGGIO: Free 92-94 • FL 95-00 • Ntt 95-96
 • Nrg 94-96 • Rst Mc2 96-98 • Quartz 92-96
 • Sfera base 91-93 • Maquillage 2 94 • Rst 95-97
 • Vespa Et2 97-01 • Zip & Zip bimodale 94-97
 • Zip base 92-96 • Rst 96-99 • Zip fast raider
 • Rst 96-97 • Fast raider 93-94 • Sp 00



KIT RULLI PULEGGIA MOTRICE

DRIVING PULLEY ROLLER SETS

MM 15 x 12

GRAMMATURE DISPONIBILI - WEIGHTS				
CODICE	•	•	BARCODE	N° Gr.
10 041 0230				6 2,3
10 041 0330				6 3,3
10 041 0350				6 3,5
10 041 0400				6 4
10 041 0430				6 4,3
10 041 0470				6 4,7
10 041 0500				6 5
10 041 0520				6 5,2
10 041 0550				6 5,5
10 041 0580				6 5,8
10 041 0620				6 6,2
10 041 0650				6 6,5
10 041 0680				6 6,8
10 041 0700				6 7
10 041 0720				6 7,2
10 041 0750				6 7,5
10 041 0770				6 7,7
10 041 0810				6 8,1
10 041 0830				6 8,3
10 041 0860				6 8,6
10 041 0900				6 9

MODELLO - MODELS	CC	ANNO YEAR	Gr.
APRILIA			
Amico	50	92-98	6,5
Amico Lx-Sport	50	92-93	6,5
Gulliver	50	95-98	6,5
Rally	50	95-03	6,5
Scarabeo	50	93-06	6,5
Scarabeo I.E. (Di Tech)	50	02	8,6
Sr (Cil.Orizz. Raff. Aria)	50		5,2
Sr Lc Stealth Racing www	50	94-01	6,5
Scarabeo Mot Minarelli	100	00	7,5
Carosello	50		7
BENELLI			
491 Gt	50	98-99	6,5
491 Rr	50	98-01	5,5
Naked	50	02	6,5
Pepe	50	99-01	6,5
BETA			
Ark AC/LC	50	96-08	5,5
Elkon	50	99-03	6,8
Quadra Chrono 502	50	96-99	5,5
Tempo	50	94-95	7
CAGIVA			
City	50	91-94	7,5
ITALJET			
Bazooka	50		6,5
Pista	50		6,5
MALAGUTI			
Centro Base	50	93-94	7
Centro Sl-Kat	50	94-98	7
Crosser Cr1	50	95-98	5,5
F10 Kat	50	99-00	6,5
F12 Phantom	50	94-98	6,5
Yesterday - Euro	50	97-00	6,5

MODELLO - MODELS	CC	ANNO YEAR	Gr.
MBK			
Booster	50	01-02	6,2
Booster Road	50	94-95	6,5
Booster Spirit Eu2	50	02-03	6,2
Evolis	50	94-95	7
Fizz	50	94-95	7
Flipper - Cat	50	98-02	6,5
Ovetto Eu1-Eu2	50	02-04	6,5
Sorriso	50	91-92	6,5
Booster	100	99-01	8,3
Nitro	100	00-02	9
Ovetto	100	00-02	9
YAMAHA			
Aerox	50	97-12	5,5
Breeze	50	94-95	7
Bw'S	50	04-12	5,5
Bw'S-Naked	50	03-04	6,2
Bw'S-Naked	50	09-12	5,5
Bw'S Ng	50	04-06	5,5
Bw'S Original Eu2	50	02-03	6,2
Jog R	50	02-11	6,5
Neo'S	50	97-12	6,5
Slider	50	00-02	6,2
Spy	50	95-98	7
Why	50	98-02	6,5
Aerox	100	00-02	9
Bw'S	100	99-01	8,3
Neo'S	100	99-02	9



MM 16 x 13

GRAMMATURE DISPONIBILI - WEIGHTS					MODELLO - MODELS				MODELLO - MODELS								
CODICE	●	●	BARCODE	N°	Gr.	CC	ANNO YEAR	Gr.	CC	ANNO YEAR	Gr.						
10 042 0270				6	2,7	GILERA				Sniper	50	93	7,5				
10 042 0360				6	3,6	Easy Moving				50	95-96	8,5	Super 8	50	07	6,5	
10 042 0400				6	4	Storm				50	94-95	8,5	Super 8 2T	50	13	8,5	
10 042 0470				6	4,7	Typhoon				50	94-97	8,5	Super 9	50	00	8,5	
10 042 0500				6	5	HONDA				Super 9 Sport Eu2	50	03	8,5	Top Boy	50	97-00	8,5
10 042 0510				6	5,1	Gp Dio				50	91	8,5	Top Boy	50	97-00	8,5	
10 042 0550				6	5,5	Sh				50	96	9	Vitality 2T	50	04	8,5	
10 042 0570				6	5,7	Shadow				50		9	Vitality 4T	50	04	6,5	
10 042 0620				6	6,2	Sj Bali				50	93	8,5	Yup	50	02	8,5	
10 042 0650				6	6,5	Sky				50	97	5	PEUGEOT				
10 042 0670				6	6,7	Vision Prima Serie				50	85-87	7,5	Buxy	50	94-97	9	
10 042 0700				6	7	Nps Zoomer				50	-	5,5	Elyseo	50	99	9	
10 042 0750				6	7,5	Sh				100	96-99	10	Looxor	50	01-03	9	
10 042 0800				6	8	Sj Bali				100	96-99	10	Metal-X	50	02	9	
10 042 0850				6	8,5	KYMCO				Speedake (Keihin)				50	95-97	7,5	
10 042 0900				6	9	Agility 4T R10				50	06	6,5	Speedake (Mikuni)	50	95-97	9	
10 042 0950				6	9,5	Agility 4T R12				50	07-08	6,5	Speedfight AC-LC	50	97-98	9	
10 042 1000				6	10	Agility 4T R16				50	08-12	6,5	Squab	50	95-97	9	
10 042 1050				6	10,5	Agility 2T R16				50	10	8,5	Sv Geo	50	91-95	11	
10 042 1100				6	11	Agility Plus 2T				50	14	8,5	Sv Geo (Mod.94)	50	91-95	8,5	
						B&W				50	02	8,5	Trekker	50	98-00	9	
						Dink 50 4T				50	07	6,5	Vivacity	50	99	9	
						Dink Classic Eu2				50	03	8,5	Zenith L	50	94-96	8,5	
						Dink Lc				50	98-02	8,5	PGO				
						Fever Zx				50	99-00	8,5	Bic Max	50		8,5	
						Heroism				50	95-97	7,5	PIAGGIO				
						Like 2T				50	09	8,5	Free	50	95-02	8,5	
						Like 4T				50	09	6,5	Nrg	50	94-96	8,5	
						Mxer				50	02-03	7,5	Nrg Rst Mc2 (96-97)	50	96-98	7	
						People				50	99-00	8,5	Ntt	50	95-96	8,5	
						People Eu2				50	03	8,5	Quartz	50	92-96	8,5	
						People Eu2				50	08-11	8,5	Sfera Rst	50	95-97	8,5	
						People S				50	05-08	8,5	Zip Rst	50	96-99	8,5	
						Sento				50	08	6,5	Zip Fast Rider-Bimodale	50	94-97	8,5	

MM 17 x 12

GRAMMATURE DISPONIBILI - WEIGHTS					MODELLO - MODELS														
CODICE	●	●	BARCODE	N°	Gr.	CC	ANNO YEAR	Gr.											
10 043 0300				6	3	APRILIA													
10 043 0360				6	3,6	Habana Kat				50		7,5							
10 043 0400				6	4	Sr (Mod.00 Mot Suzuki)				50		7,5							
10 043 0460				6	4,6	Sr Di Tech (Mod.01)				50		7,5							
10 043 0520				6	5,2	ATALA				Hacker				50		5,5			
10 043 0550				6	5,5	CAGIVA				Progress				50	97-99	6			
10 043 0580				6	5,8	DERBI				Atlantis				50	99-01	7,2			
10 043 0600				6	6	Atlantis Kat (Raff. Aria)				50		5,8	Atlantis Lc				50	99-01	7,2
10 043 0630				6	6,3	Hunter				50	96-97	6,3	Paddock Lc				50	98-01	6
10 043 0660				6	6,6	Predator Lc				50	98-01	7,2	ITALJET						
10 043 0680				6	6,8	Formula Lc				50	97	5,5	MALAGUTI						
10 043 0720				6	7,2	Ciak				100	99-00	6,6	SUZUKI						
10 043 0750				6	7,5	Address				50	92-95	6,6	Katana V-Y				50	97-00	7,2
10 043 0830				6	8,3	Sepia S				50	95-97	6,6	Zillion				50	99	6,8
10 043 0870				6	8,7	Ay-Ajw K1-K4				50	01-04	6,6							



KIT RULLI PULEGGIA MOTRICE

DRIVING PULLEY ROLLER SETS

MM 17 x 13,5

GRAMMATURE DISPONIBILI - WEIGHTS				
CODICE	•	•	BARCODE	N° Gr.
10 044 0510				6 5,1
10 044 0520				6 5,2
10 044 0660				6 6,6
10 044 0700				6 7

GRAMMATURE DISPONIBILI - WEIGHTS				
CODICE	•	•	BARCODE	N° Gr.
10 044 0840				6 8,4
10 044 0940				6 9,4

MODELLO - MODELS	CC	ANNO YEAR	Gr.
PIAGGIO			
Sfera	50	91-93	5,2
Zip	50	92-93	5,2

MM 18 x 14

GRAMMATURE DISPONIBILI - WEIGHTS				
CODICE	•	•	BARCODE	N° Gr.
10 040 0710				6 12,7
10 040 0090				6 13
10 040 0092	•			6 13
10 040 0230				6 13,5
10 040 0720				6 14
10 040 0100				6 14,5
10 040 0240				6 15,5

MODELLO - MODELS	CC	ANNO YEAR	Gr.
HONDA			
Nsc Vision	110	-	14,5
KYMCO			
Agility 4T	125	06	13,5
Agility 4T Eu3	125	06-08	13,5
Agility R16	125	09-12	13
Agility Carry	125	11-12	13,5
Agility R16	125	09-12	13
Agility Plus	125	14	13
Downtown 125I	125	09	13
Downtown I	125	09	13
Heroism	125	95-97	13
Heroism	125	95-97	13
K-Xct I	125	12-14	13
Like	125	09	13,5
Like Lx	125	12	13,5
Movie	125	99-00	13
Movie	125	99-00	13
People	125	99-00	13
People Eu3	125	07-11	13
People S	125	05	13
People Gti	125	10-12	13
People Eu2	125	03	13
People	125	99-00	13
People Eu3	125	07-11	13
People Gti	125	10	13
People S DD Eu3	125	07-08	13
People S	125	05	13
Super 8	125	08-09	13
Super 8	125	08-09	13

MODELLO - MODELS	CC	ANNO YEAR	Gr.
Vivio	125	00	13
Vivio	125	00	13
People One I	125	13-14	13,5
Agility R16	150	08-09	13
Agility	150	08-09	13
Heroism	150	95-97	14,5
Movie 150 Eu3	150	06-07	15,5
People	150	99-00	14,5
Vivio	150	00	14,5
Agility R16	200	10-12	13,5
Like 200I	200	09	13,5
Like Lx	200	12	13,5
People S	200	05	13
People S I	200	07	13
Agility Plus	200	14	13,5
Agility I Plus	200	14	13
MALAGUTI			
Ciak	125	00-01	13
Ciak Master	125	04	13
Ciak Master Eu3	125	06	13
Ciak	150	00-02	14,5
Ciak Master	150	04	14,5
Ciak Master Eu2	200	06	13
APPLICAZIONI VARIE			
-	-	-	12,7
-	-	-	14

MM 18 x 15

GRAMMATURE DISPONIBILI - WEIGHTS				
CODICE	•	•	BARCODE	N° Gr.
10 040 0010				6 10,7

MODELLO - MODELS	CC	ANNO YEAR	Gr.
APRILIA			
Leonardo (I Serie)	125	96-98	10,7

MM 19 x 14

GRAMMATURE DISPONIBILI - WEIGHTS				
CODICE	•	•	BARCODE	N° Gr.
10 040 0130				6 12

MODELLO - MODELS	CC	ANNO YEAR	Gr.
APRILIA			
Mojito Retro' - Custom	125	99-01	12
ITALJET			
Torpedo	125	98-00	12

MODELLO - MODELS	CC	ANNO YEAR	Gr.
PIAGGIO			
Hexagon Lx4	125	98-99	12
Liberty	125	98-00	12
Sfera	125	95-97	12
Vespa Et4	125	96-98	12



MM 19 x 15,5

GRAMMATURE DISPONIBILI - WEIGHTS				
CODICE	●	●	BARCODE	N° Gr.
10 045 0370				6 3,7
10 045 0400				6 4
10 045 0430				6 4,3
10 045 0480				6 4,8
10 045 0530				6 5,3
10 045 0532 (CM1102035)	●			6 5,3
10 045 0550				6 5,5
10 045 0570				6 5,7
10 045 0600				6 6
10 045 0630				6 6,3
10 045 0642 (CM1102025)	●			6 6,4
10 045 0650				6 6,5
10 045 0680				6 6,8
10 045 0720				6 7,2
10 045 0750				6 7,5
10 045 0752 (CM1102015)	●			6 7,5
10 045 0780				6 7,8
10 045 0830				6 8,3
10 045 0870				6 8,7
10 045 0982 (CM1102045)	●			6 9,8

MODELLO - MODELS	CC	ANNO YEAR	Gr.
APRILIA			
Mojito	50	04-08	6,4
Scarabeo 4T 4V	50	10-12	5,3
Scarabeo Quattro	50	09	5,3
Scarabeo 2T	50	09-12	7,5
Scarabeo Street	50	05-06	7,5
Sport City One 2T	50	08-11	7,5
Sport City One 4T	50	08-10	6,4
Sr R Factory Carb.	50	10-12	5,3
Sr R Factory Ie	50	10-12	5,3
Sr R R Factory (Iniez)	50	04-09	5,3
Sr R R Factory Carb)	50	04-09	6,4
Sr Street (Carb.)	50	03-08	6,4
Sr Street (Iniez)	50	03-08	5,3
DERBI			
Atlantis 02 Bullet	50	03-05	6,4
Atlantis 50 4T	50	04-06	6,4
Atlantis 2T Eu2	50	07-10	6,4
Gp1	50	01-03	5,3
GILERA			
Dna	50	03-07	6,4
Dna	50	00-02	7,5
Ice	50	01-05	7,5
Runner	50	97-00	5,3
Runner Purejet	50	02-11	5,3
Stalker	50	97-11	7,5
Storm Eu2	50	07	6,4
Typhoon 2T Eu2-3	50	10-12	7,5
PIAGGIO			
Diesis	50	01	6,4
Fly 2T	50	10-11	7,5
Fly 4T	50	08-11	9,8
Fly 4T	50	12	5,3

MODELLO - MODELS	CC	ANNO YEAR	Gr.
Fly 4T 4V	50	12-13	5,3
Free Delivery	50	00-01	6,4
Liberty	50	97-05	6,4
Liberty (Cat.'00)	50	97-05	7,5
Liberty 2T	50	06-11	7,5
Liberty 4T	50	00-02	5,3
Liberty 4T	50	05-08	6,4
Liberty Ptt Eu2	50	04-11	7,5
Nrg Mc3	50	01-04	6,4
Nrg Purejet	50	10-11	5,3
Typhoon	50	01-09	6,4
Vespa Et2	50	97-05	6,4
Vespa Et2 Iniezione	50	97-00	7,5
Vespa Et4	50	00-05	5,3
Vespa Lx 2T	50	05-08	7,5
Vespa Lx 4T 4V	50	09-13	5,3
Vespa Lx 4T-4V Touring	50	10-13	5,3
Vespa S 4T-4V	50	08-09	5,3
Vespa S 4T-4V & College	50	08-12	5,3
Vespa S 2T	50	07-11	7,5
Vespa Primavera 4T-4V	50	13.15	5,3
Vespa Sprint 4T-4V	50	14	5,3
Zip	50	00-04	7,5
Zip 2T	50	08-11	7,5
Zip 4T	50	00-12	6,4
Zip 4T	100	06-10	9,8



KIT RULLI PULEGGIA MOTRICE

DRIVING PULLEY ROLLER SETS

MM 19 x 17

GRAMMATURE DISPONIBILI - WEIGHTS				
CODICE	•	•	BARCODE	N° Gr.
10 040 0250				6 7
10 040 0252 (CM1038045)	•			6 7,3
10 040 0260				6 8
10 040 0692 (CM1038035)	•			6 8,6
10 040 0272 (CM1038015)	•			6 10
10 040 0972	•			6 10,4
10 040 0270				6 9,5
10 040 0290		•		6 11
10 040 0160				6 12,5
10 040 0300				6 13
10 040 0140				6 15
10 040 0982	•			6 15,6

MODELLO - MODELS	CC	ANNO YEAR	Gr.
APRILIA			
Atlantic Eu3	125	06-08	7,3
Mojito	125	03-08	8
Scarabeo Light	125	07-09	8
Sport City	125	04-06	7,3
Sr	125	99-01	13
Sr Motard	125	12	8
Sr	150	99-01	13
DERBI			
Boulevard	125	02-04	8,6
Boulevard 4T Eu3	125	08-12	8
Gp1 Eu2	125	06	7,3
Rambla	125	08	7,3
Boulevard	150	02-04	10
GILERA			
Dna	125	01	7,3
Nexus Eu3 le	125	08-09	7,3
Runner Fx-Fxr	125	97-02	15
Runner Vx	125	05-06	7,3
Typhoon	125	95-98	13
PIAGGIO			
Beverly '02	125	02	7,3
Beverly '01 e '03	125		8,6
Beverly Eu3	125	07-08	7,3
Beverly Tourer Eu3	125	08-09	7,3
Carnaby	125	07-09	7,3
Fly	125	05-07	8
Fly 4T 3V le Eu3 Dt-Lem	125	12-13	10
Fly 4T 3V le Eu3 Lem	125	12-13	10,4
Fly 4T 3V le E3 Dt	125	13-15	10,4
Fly 4T 3V le Eu3 Lem	125	12-13	10,4
Hexagon	125	94-97	13
Hexagon Gtx	125	00	7,3

MODELLO - MODELS	CC	ANNO YEAR	Gr.
Liberty	125	01-02	8,6
Liberty 4T	125	06-07	8,6
Mp3	125	07-08	7,3
Super Hexagon Gtx 12"	125	01-02	7,3
Typhoon 4T 2V Eu3	125	10-11	8,6
Vespa Et4	125	99-02	8,6
Vespa Granturismo	125	03-07	7,3
Vespa Lx	125	05-06	8,6
Vespa Lx 4T 3V le-Touring	125	13	10
Vespa Lx 4T 3V le - Touring	125	12-13	10,4
Vespa Lx 4T 3V le - Touring	125	12-13	10,4
Vespa S 4T 3V le	125	12	10,4
Vespa S 4T 3V le	125	12	9,5
Vespa 946 4T 3V Abs	125	12-13	10
Vespa 946 4T 3V Abs	125	13-15	10,4
X8	125	04-06	7,3
X9	125	01-02	7,3
X9 Evolution	125	03-06	7,3
Zip	125	00-02	8,6
Fly	150	05-11	10
Liberty	150	01-02	10
Liberty Moc 4T	150	09-10	10
Liberty 4T 3V Lem	150	13-14	15,6
Skipper	150	94-97	12,5
Skipper Lx	150	98-99	13
Vespa Et4	150	99-02	10
Vespa Lx	150	09-11	10
Vespa Lt 3V IE	150	14	15,6
Vespa Gts Super le 4T 3V	150	14-15	15,6
Vespa Primavera 4T-3V	150	13-15	15,6
Vespa S 4T ie	150	09-11	10
Vespa Sprint 4T 3V le	150	15	15,6



MM 20 x 12

GRAMMATURE DISPONIBILI - WEIGHTS				
CODICE	●	●	BARCODE	N° Gr.
10 040 0340				6 8,5
10 040 0350				6 9
10 040 0360				6 9,6
10 040 0370				6 10,5
10 040 0220				6 12
10 040 0780				8 12,5
10 040 0952	●			8 12,5
10 040 0380				6 15,3
10 040 0760				8 10
10 040 0390				8 11,5
10 040 0770				8 12
10 040 0912 (52SE76320000)	●			6 13
10 040 0400				8 13,5
10 040 0040				8 14
10 040 0410				8 15,3

MODELLO - MODELS	CC	ANNO YEAR	Gr.
APRILIA			
Leonardo	250	99-04	14
BENELLI			
Velvet	125	99-01	9
Velvet	150	99-01	9,6
Velvet	250	99-01	14
KYMCO			
Downtown I	200	10	12,5
People Gti	200	10-14	12,5
Downtown I	300	09-11	15,3
Downtown Abs - Abs i	300	10-12	15,3
K-Xct I Abs	300	14	15,3
K-Xct I Abs	300	12	15,3
People Gti	300	14	15,3
People Gti Abs	300	12-14	15,3
ITALJET			
Jupiter 4T	125		9
Millennium	125		9
Jet Set 4T- Millennium	150		9,6
MALAGUTI			
Madison	125	99-01	8,5
Phantom Max	125	03	9,6
Madison T	150	99-01	9,6
Madison S	250	99-01	13,5
MBK			
Doodo	125	00-01	10,5
Flame - R	125	97	12
Skyliner	125	98-02	8,5

MODELLO - MODELS	CC	ANNO YEAR	Gr.
Thunder	125	01-02	10,5
Skyliner	150	00-02	9,6
Skyliner	180	03	15,3
Skyliner	250	00-03	11,5
Skyliner Abs	250	03	11,5
Kilibre	300	03	15,3
YAMAHA			
Cygnus - Cygnus R	125	95-98	12
Hw Xenter	125	12-15	13
Majesty	125	98-00	8,5
Majesty	125	01-02	14
Majesty	125	03-05	10,5
Teo'S	125	00	10,5
X-City	125	08-11	10,5
X-Max	125	06-12	10,5
Xc R Majesty S	125	14	13
Yw Bw's	125	10	12
Yp R X-Max	125	10-14	10,5
Majesty	150	00-02	9,6
Hw Xenter	150	12	13
Versity	150	03-06	15,3
Majesty	180	03-06	15,3
Majesty	250	00-03	11,5
Majesty	250	96-98	14
X-City	250	08-12	12
X-Max	250	05-09	14
X-Max	250	08-10	12

MM 20 x 15

GRAMMATURE DISPONIBILI - WEIGHTS				
CODICE	●	●	BARCODE	N° Gr.
10 040 0420				6 7,3
10 040 0430				6 11,5
10 040 0440				6 12,5
10 040 0170				6 13
10 040 0110				6 13,5
10 040 0902	●			6 14
10 040 0120				6 14,5
10 040 0450				6 15,5
10 040 0460				6 16,5
10 040 0962				6 18
10 040 0992	●			6 19,2

MODELLO - MODELS	CC	ANNO YEAR	Gr.
APRILIA			
Scarabeo 4T	100	01-04	7,3
Scarabeo 4T Rst	100	06-09	7,3
Scarabeo 4T-Net	100	10-12	7,3
HONDA			
Chiocciola	125	00-06	11,5
Dylan	125	01-06	11,5
Nes	125	00-07	11,5
Sh 125 - 125I	125	01-12	11,5
Pcx	125	10-13	16,5
Pantheon	125	03-05	12,5
Ps	125	06-10	11,5
Chiocciola	150	00-06	12,5
Dylan	150	01-06	12,5
Nes	150	00-07	12,5
Sh 150 - 150I	150	01-08	12,5
Ps	150	06-10	12,5
Pcx	150	10-14	18
KYMCO			
B&W	125	00	13,5
Dink	125	97-98	13,5
Grand Dink	125	01-02	13,5
B&W	150	97-00	14,5

MODELLO - MODELS	CC	ANNO YEAR	Gr.
B&W Eu2	150	03-04	14,5
Dink Lx	150	98-00	14,5
Grand Dink Eu2	150	01-04	16,5
Dink Classic	200	04	16,5
MALAGUTI			
Blog Ie	125	09-11	11,5
Centro Ie	125	08-11	11,5
F18 Warrior	125	00-02	11,5
F18 Warrior	150	00-02	13,5
Blog Ie	160	09-11	11,5
Centro Ie	160	08-09	11,5
PIAGGIO			
Free	100	02-03	7,3
Vespa Lx Primavera 4T 3V Ie	125	13-15	19,2
Vespa Sprint 4T 3V Ie	125	14-15	19,2
SUZUKI			
Burgman K2-K6	125	02-06	13
Burgman K7-L1	125	07-11	13
Uc Epicuro X - K1	125	99-01	14
Burgman K2-K6	150	02-06	16,5
Epicuro	150	99-01	13
Ux Sixteen K8 - L0	150	08-10	14
Ux Sixteen L1	150	11	14



KIT RULLI PULEGGIA MOTRICE

DRIVING PULLEY ROLLER SETS

MM 20 x 17

GRAMMATURE DISPONIBILI - WEIGHTS				
CODICE	•	•	BARCODE	N° Gr.
10 040 0020				6 8,5
10 040 0030				6 9,5
10 040 0470				6 10
10 040 0150				6 15

MODELLO - MODELS	CC	ANNO YEAR	Gr.
APRILIA			
Leonardo (I Serie)	125	99-01	8,5
Leonardo	150	99-01	9,5
Scarabeo Mot Rotax	200	99-03	10
GILERA			
Runner Fx-Fxr	180	97-02	15

MODELLO - MODELS	CC	ANNO YEAR	Gr.
ITALJET			
Dragster	180	99-03	15
PIAGGIO			
Hexagon Lx-Lxt	180	98-99	15
SUZUKI			
Sixteen	125	08-11	10
Sixteen	150	08-11	10

MM 21 x 17

GRAMMATURE DISPONIBILI - WEIGHTS				
CODICE	•	•	BARCODE	N° Gr.
10 040 0310		•		6 9
10 040 0320				6 10,3
10 040 0322 (832698)	•			6 10,7
10 040 0330		•		6 11
10 040 0672 (842870)	•			6 11,2
10 040 0842 (849480)	•			6 13,3

MODELLO - MODELS	CC	ANNO YEAR	Gr.
DERBI			
Gp1	250	06-07	11,2
Rambla	250	08-09	13,8
Rambla	300	10-12	13,8
GILERA			
Runner Vx-Vxr	200	02-04	10,7
Runner Vxr	200	05-11	10,7
Nexus Eu3	250	07	11,2
Nexus Eu3	250	06	13,8
Oregon	250	06-08	11,2
Nexus Eu3	300	08-12	11,2
PIAGGIO			
Beverly	125	01-03	10,7
Beverly Rst 4T 4V Eu3	125	10-12	11,2
Beverly Tourer Eu3	125	08-10	11,2
Carnaby	125	07-10	11,2
Mp3 Ibrido	125	09-10	11,2
Mp3 le Touring	125	11	11,2
Mp3 Yourban ERL	125	11-12	11,2
Vespa Granturismo	125	03-05	10,7
Vespa Gts 4T	125	07-11	11,2
X Evo	125	07-12	11,2
X7 Evo le Eu3	125	09-10	11,2
X10 4T 4V le Eu3	125	12	11,2
Hexagon Gtx	180	00	10,7
X9 Amalfi	180	00-03	10,7
Beverly	200	01-03	10,7
Carnaby	200	07-08	10,7

MODELLO - MODELS	CC	ANNO YEAR	Gr.
Liberty	200	06	10,7
Liberty 4T Eu3	200	07-08	10,7
Vespa Granturismo	200	03-07	10,7
X8	200	05-07	10,7
X9	200	02-03	10,7
Beverly	250	06-07	11,2
Beverly Tourer Eu3	250	08-09	13,8
Carnaby	250	08	13,8
Mp3	250	06-08	11,2
Vespa Gts- Abs	250	05-11	11,2
Vespa Gtv	250	06-09	11,2
X7 Eu3	250	08	11,2
X8 Eu3	250	05-08	11,2
X9 Evolution	250	04-06	11,2
Beverly 300 le Tourer	300	09-12	13,8
Carnaby Cruiser	300	09-11	13,8
Mp3 4T-Lt-Ibrido-Yourban	300	10-12	13,8
Mp3 Yourban ERL	300	11-15	13,3
Mp3 Lt Business - Sport Abs	300	14	13,3
Vespa Gts Super	300	08-12	13,8
Vespa Gts le & Touring	300	12-15	13,3
Vespa Gts Super Sport	300	10-13	13,3
Vespa Gtv 4T 4V ie	300	10-13	13,3
X7 Evo le Eu3	300	09-10	13,8

MODELLO - MODELS	CC	ANNO YEAR	Gr.
APRILIA			
Atlantic	125	03-05	11,2
Scarabeo	125	04-06	11,2
Scarabeo Light	125	09-11	11,2
Sport City Cube	125	08-10	11,2
Sr Max	125	11-12	11,2
Sport City	200	04-06	10,7
Sport City Cube	250	06-08	10,7
Sport City Cube	250	08-10	11,2
Sr Max	300	11-12	11,2

MM 23 x 18

GRAMMATURE DISPONIBILI - WEIGHTS				
CODICE	•	•	BARCODE	N° Gr.
10 040 0520		•		6 14
10 040 0050				6 15,5
10 040 0060				6 16
10 040 0942 (R.O. 122124)	•			6 17,5
10 040 0700				6 18
10 040 0530				6 19
10 040 0540				6 20
10 040 0580				3 20,8 3 20,15
10 040 0550		•		6 23
10 040 0560				6 24
10 040 0570				6 25
10 040 0080				6 27

MODELLO - MODELS	CC	ANNO YEAR	Gr.
HONDA			
Pantheon 2T	125	98-02	15,5
Pantheon 2T	150	98-02	16
Foresight	250		27
Foresight	250	98	25
Jazz	250	00-04	20,8+ 20,15
Sh I	300	07-12	19

MODELLO - MODELS	CC	ANNO YEAR	Gr.
KYMCO			
B&W	250	00	20
B&W Eu2	250	03	20
Grand Dink	250	01-02	20
People S	250	06	20
People S 250I	250	07	20
X Citing	250	05	20
Yup	250	03	20
Gran Dink	300	12	20
People S I	300	08	17,5
X Citing I	300	08-09	17,5
X Citing I R	300	08	17,5
PIAGGIO			
X9	250	00-01	24



MM 24 x 18

GRAMMATURE DISPONIBILI - WEIGHTS				
CODICE	●	●	BARCODE	N° Gr.
10 040 0892 (21650-14F60-000)	●	●		6 21
10 040 0070				6 23
10 040 0680		●		6 25
10 040 0180				6 31

MODELLO - MODELS	CC	ANNO YEAR	Gr.
HONDA			
Cn 4T	250		23
PIAGGIO			
Hexagon Gt-Gtx	250	98-00	23
SUZUKI			
Uh Burgman K7-L0	200	07-10	21
Uh Burgman L1	200	11-12	21
Uh Burgman L3	200	13	21
Burgman W-K2	250	98-02	31
Burgman K3-K6	250	03-06	31

MM 25 x 15

GRAMMATURE DISPONIBILI - WEIGHTS				
CODICE	●	●	BARCODE	N° Gr.
10 040 0660				8 15
10 040 0872	●	●		8 16
10 040 0862	●	●		8 17
10 040 0832 (5RU176322000)	●			8 18
10 040 0922 (5RU176325000)	●			8 20

MODELLO - MODELS	CC	ANNO YEAR	Gr.
YAMAHA			
Majesty	400	04-08	15
Majesty Abs	400	07-08	15
Majesty Abs	400	09-12	18
Yp X-Max	400	13-14	17
Xp T-Max	500	04-11	18
Xp T-Max	500	01-03	20
Xp T-Max Abs	530	12-13	18

MM 25 x 17

GRAMMATURE DISPONIBILI - WEIGHTS				
CODICE	●	●	BARCODE	N° Gr.
10 040 0642 (849914)	●			8 18,6
10 040 0652 (830899)	●			8 21,4

MODELLO - MODELS	CC	ANNO YEAR	Gr.
APRILIA			
Atlantic Sprint	400	05-08	18,6
Scarabeo Light	400	06-08	18,6
Atlantic Sprint	500	05-08	21,4
Scarabeo Light	500	06-08	21,4
GILERA			
Fuoco	500	07-12	21,4
Nexus Eu3	500	06-09	21,4
Nexus Sp Eu3	500	06-07	21,4
PIAGGIO			
Beverly Eu3	400	06-07	18,6
Beverly Tourer Eu3	400	08-10	18,6
Mp3	400	07-11	18,6
X Evo	400	07-09	18,6
X8 Eu3	400	06-08	18,6
Beverly	500	05-06	21,4
Beverly Cruiser	500	07-12	21,4
Beverly Eu3	500	06-08	21,4
Mp3 Lt-Rt	500	11-12	21,4
Mp3 Lt Sport - Business	500	11-13	21,4
Mp3 RL Sport - Business	500	11-12	21,4
X9 Evolution-Abs	500	06-07	21,4
X10 4T 4V Ie Eu3	500	12-14	21,4

MM 25 x 20

GRAMMATURE DISPONIBILI - WEIGHTS				
CODICE	●	●	BARCODE	N° Gr.
10 040 0742				6 17

MODELLO - MODELS	CC	ANNO YEAR	Gr.
KYMCO			
X Citing I Abs	400	14-15	17
X citing I	400	13-15	17



KIT RULLI PULEGGIA MOTRICE

DRIVING PULLEY ROLLER SETS

MM 25 x 22

GRAMMATURE DISPONIBILI - WEIGHTS				
CODICE	•	•	BARCODE	N° Gr.
10 040 0630		•		6 26
10 040 0480				6 27,3
10 040 0490				6 28,5
10 040 0500				6 29

MODELLO - MODELS	CC	ANNO YEAR	Gr.
APRILIA			
Atlantic	500	01-04	28,5
Scarabeo	500	03-06	28,5
GILERA			
Nexus	500	03-05	27,3
PIAGGIO			
Beverly	500	02-04	27,3
X9	500	01-02	29
X9 Evolution	500	03-05	27,3

MM 26 x 13

GRAMMATURE DISPONIBILI - WEIGHTS				
CODICE	•	•	BARCODE	N° Gr.
10 040 0610				8 17,5
10 040 0620		•		8 19
10 040 0190				8 21

MODELLO - MODELS	CC	ANNO YEAR	Gr.
MALAGUTI			
Madison K	400	02	17,5
Madison K Rst	400	02-04	17,5
SUZUKI			
Burgman X-K2	400	99-02	21
Burgman K3-L2	400	03-12	19

MM 28 x 20

GRAMMATURE DISPONIBILI - WEIGHTS				
CODICE	•	•	BARCODE	N° Gr.
10 040 0590		•		8 26
10 040 0600				8 27

MODELLO - MODELS	CC	ANNO YEAR	Gr.
HONDA			
Silver Wing	600		27

MM 29 x 22

GRAMMATURE DISPONIBILI - WEIGHTS				
CODICE	•	•	BARCODE	N° Gr.
10 040 0732	•			6 33,5
10 040 0752	•	•		6 31

MODELLO - MODELS	CC	ANNO YEAR	Gr.
KYMCO			
X Citing	500	05	33,5
X Citing 500 R	500	09	33,5
X Citing 500I	500	06-08	33,5



MODELLO - MODELS	CC	ANNO YEAR	STANDARD	HIGH QUALITY	DIMENSIONI DIMENSIONS	PESO WEIGHT	PEZZI PCS
APRILIA							
Amico	50	94-95	10 041 0650	-	15 x 12	6,5	6
Amico	50	96-98	10 041 0650	-	15 x 12	6,5	6
Amico Lx-Sport	50	92-93	10 041 0650	-	15 x 12	6,5	6
Area 51	50	98-00	10 041 0650	-	15 x 12	6,5	6
Gulliver / Lc	50	95-98	10 041 0650	-	15 x 12	6,5	6
Habana Kat	50		10 043 0750	-	17x12	7,5	6
Mojito	50	04-08	10 045 0630	10 045 0642	19x15,5	6,4	6
Rally /Lc	50	95-03	10 041 0650	-	15 x 12	6,5	6
Scarabeo	50	93-97	10 041 0650	-	15 x 12	6,5	6
Scarabeo 4T 4V	50	10-12	10 045 0530	10 045 0532	19x15,5	5,3	6
Scarabeo 4T Net	50	09-10	10 045 0530	10 045 0532	19x15,5	5,3	6
Scarabeo 4T Rst Eu3	50	06-09	10 045 0530	10 045 0532	19x15,5	5,3	6
Scarabeo I.E. (02 Di Tech)	50		10 041 0860	-	15x12	8,6	6
Scarabeo Quattro	50	09	10 045 0530	10 045 0532	19x15,5	5,3	6
Scarabeo Street	50	05-06	10 045 0750	10 045 0752	19x15,5	7,5	6
Scarabeo Street 2T Rst	50	06-09	10 045 0750	10 045 0752	19x15,5	7,5	6
Scarabeo 2T Eu2 Piaggio	50	10-12	10 045 0750	10 045 0752	19x15,5	7,5	6
Scarabeo 2t Net	50	09-10	10 045 0750	10 045 0752	19x15,5	7,5	6
Sonic	50	98-07	10 041 0650	-	15 x 12	6,5	6
Sport City One 2T	50	08-11	10 045 0750	10 045 0752	19x15,5	7,5	6
Sport City One 4T	50	08-10	10 045 0630	10 045 0642	19x15,5	6,4	6
Sr (Cil.Orizz. Raff. Aria)	50		10 041 0520	-	15x12	5,2	6
Sr / Lc	50	94-96	10 041 0650	-	15 x 12	6,5	6
Sr Stealth, Racing	50	97-99	10 041 0650	-	15 x 12	6,5	6
Sr www	50	97-01	10 041 0650	-	15 x 12	6,5	6
Sr (Mod.00 Mot Suzuki)	50		10 043 0750	-	17x12	7,5	6
Sr Di Tech (Mod.01)	50		10 043 0750	-	17x12	7,5	6
Sr R Factory Carb.	50	10-12	10 045 0630	10 045 0642	19x15,5	5,3	6
Sr R Factory ie	50	10-12	10 045 0530	10 045 0532	19x15,5	5,3	6
Sr R R Factory (Iniezione)	50	04-09	10 045 0530	10 045 0532	19x15,5	5,3	6
Sr R R Factory Carburatore - <i>Carburetor</i>)	50	04-09	10 045 0630	10 045 0642	19x15,5	6,4	6
Sr Street (Carburatore - <i>Carburetor</i>)	50	03-08	10 045 0630	10 045 0642	19x15,5	6,4	6
Sr Street (Iniezione)	50	03-08	10 045 0530	10 045 0532	19x15,5	5,3	6
Scarabeo 4T	100	01-04	10 040 0420	-	20x15	7,3	6
Scarabeo 4T Rst	100	06-09	10 040 0420	-	20x15	7,3	6
Scarabeo 4T / Net	100	10-12	10 040 0420	-	20x15	7,3	6
Scarabeo Motori Minarelli	100	00	10 041 0750	-	15x12	7,5	6
Atlantic	125	03-05	-	10 040 0672	21x17	11,2	6
Atlantic Eu3	125	06-08	10 040 0250	10 040 0252	19x17	7,3	6
Leonardo (I Serie)	125	96-98	10 040 0010	-	18x15	10,7	6
Leonardo (I Serie)	125	99-01	10 040 0020	-	20x17	8,5	6
Mojito	125	03-08	10 040 0260	-	19x17	8	6
Mojito Retro' - Custom	125	99-01	10 040 0130	-	19x14	12	6
Scarabeo	125	04-06	-	10 040 0672	21x17	11,2	6
Scarabeo Light	125	07-09	10 040 0260	-	19x17	8	6
Scarabeo Light	125	09-11	-	10 040 0672	21x17	11,2	6



KIT RULLI PULEGGIA MOTRICE

DRIVING PULLEY ROLLER SETS

MODELLO - MODELS	CC	ANNO YEAR	STANDARD	HIGH QUALITY	DIMENSIONI DIMENSIONS	PESO WEIGHT	PEZZI PCS
Sport City	125	04-06	10 040 0250	10 040 0252	19x17	7,3	6
Sport City Cube	125	08-10	10 040 0250	10 040 0252	19x17	7,3	6
Sport City Eu3	125	06-08	10 040 0250	10 040 0252	19x17	7,3	6
Sport City One	125	08	10 040 0260	-	19x17	8	6
Sr Motard	125	12	10 040 0260	-	19x17	8	6
Sr	125	99-01	10 040 0300	-	19x17	13	6
Sr Max	125	11-12	10 040 0250	10 040 0252	19x17	7,3	6
Leonardo	150	99-01	10 040 0030	-	20x17	9,5	6
Sr	150	99-01	10 040 0300	-	19x17	13	6
Scarabeo Mot Rotax	200	99-03	10 040 0470	-	20x17	10	6
Sport City	200	04-06	10 040 0320	10 040 0322	21x17	10,7	6
Sport City Cube	200	08	10 040 0320	10 040 0322	21x17	10,7	6
Sport City Eu3	200	06-08	10 040 0320	10 040 0322	21x17	10,7	6
Leonardo	250	99-04	10 040 0040	-	20x12	14	8
Leonardo St	250	01	10 040 0040	-	20x12	14	8
Sport City Cube	250	06-08	10 040 0320	10 040 0322	21x17	10,7	6
Sport City Cube	250	08-10	10 040 0250	10 040 0252	19x17	7,3	6
Sr Max	300	11-12	10 040 0250	10 040 0252	19x17	7,3	6
Atlantic Sprint	400	05-08	-	10 040 0642	25x17	18,6	8
Scarabeo Light	400	06-08	-	10 040 0642	25x17	18,6	8
Atlantic	500	01-04	10 040 0490	-	25x22	28,5	6
Atlantic Sprint	500	05-08	-	10 040 0652	25x17	21,4	8
Scarabeo	500	03-06	10 040 0490	-	25x22	28,5	6
Scarabeo Light	500	06-08	-	10 040 0652	25x17	21,4	8
ATALA							
Carosello	50		10 041 0700	-	15x12	7	6
Hacker	50		10 043 0550	-	17x12	5,5	6
BENELLI							
491 Gt	50	98-99	10 041 0650	-	15x12	6,5	6
491 Rr	50	98-01	10 041 0550	-	15x12	5,5	6
491 St	50		10 041 0550	-	15x12	5,5	6
K2 Liquid Cooled	50	99-01	10 041 0650	-	15x12	6,5	6
Naked	50	02	10 041 0650	-	15x12	6,5	6
Pepe	50	99-01	10 041 0650	-	15x12	6,5	6
Sport Racing	50		10 041 0650	-	15x12	6,5	6
Adiva	125	01-02	10 040 0260	-	19x17	8	6
Velvet	125	99-01	10 040 0350	-	20x12	9	6
Velvet Touring	125	02-03	10 040 0350	-	20x12	9	6
Velvet	150	99-01	10 040 0360	-	20x12	9,6	6
Velvet Touring	150	02-03	10 040 0360	-	20x12	9,6	6
Velvet	250	99-01	10 040 0040	-	20x12	14	8
Velvet Touring	250	02-03	10 040 0040	-	20x12	14	8
BETA							
Ark Air	50	96-08	10 041 0550	-	15x12	5,5	6
Ark Lc	50	96-03	10 041 0550	-	15x12	5,5	6
Elkon	50	99-03	10 041 0680	-	15x12	6,8	6

KIT RULLI PULEGGIA MOTRICE

DRIVING PULLEY ROLLER SETS



MODELLO - MODELS	CC	ANNO YEAR	STANDARD	HIGH QUALITY	DIMENSIONI DIMENSIONS	PESO WEIGHT	PEZZI PCS
Quadra Chrono 502	50	96-99	10 041 0550	-	15x12	5,5	6
Tempo	50	94-95	10 041 0700	-	15x12	7	6
CAGIVA							
City	50	91-94	10 041 0750	-	15x12	7,5	6
Progress	50	97-99	10 043 0600	-	17x12	6	6
DERBI							
Atlantis	50	99-01	10 043 0720	-	17x12	7,2	6
Atlantis 02 Bullet	50	03-05	10 045 0630	10 045 0642	19x15,5	6,4	6
Atlantis 02 City	50	03-06	10 045 0630	10 045 0642	19x15,5	6,4	6
Atlantis 02 Red Bullet	50	03	10 045 0630	10 045 0642	19x15,5	6,4	6
Atlantis 02 Two Chic	50	05	10 045 0630	10 045 0642	19x15,5	6,4	6
Atlantis 2T Eu2	50	07-10	10 045 0630	10 045 0642	19x15,5	6,4	6
Atlantis 4T Eu2	50	07	10 045 0630	10 045 0642	19x15,5	6,4	6
Atlantis 50 4T	50	04-06	10 045 0630	10 045 0642	19x15,5	6,4	6
Atlantis Kat (Raffreddato Aria)	50		10 043 0580	-	17x12	5,8	6
Atlantis Lc	50	99-01	10 043 0720	-	17x12	7,2	6
Gp1	50	01-03	10 045 0530	10 045 0532	19x15,5	5,3	6
Gp1 Eu2	50	05	10 045 0530	10 045 0532	19x15,5	5,3	6
Gp1 Open Eu2	50	06-09	10 045 0630	10 045 0642	19x15,5	6,4	6
Gp1 Race Eu2	50	05-07	10 045 0630	10 045 0642	19x15,5	6,4	6
Hunter	50	96-97	10 043 0630	-	17x12	6,3	6
Paddock Lc	50	98-01	10 043 0600	-	17x12	6	6
Predator Lc	50	98-01	10 043 0720	-	17x12	7,2	6
Boulevard	125	02-04	-	10 040 0692	19x17	8,6	6
Boulevard Eu3	125	04-07	-	10 040 0692	19x17	8,6	6
Boulevard 4T Eu3	125	08-12	10 040 0260	-	19x17	8	6
Sonar 4T	125	09-12	-	10 040 0692	19x17	8,6	6
Variant Sport 4T Eu3	125	12	-	10 040 0692	19x17	8,6	6
Gp1 Eu2	125	06	10 040 0250	10 040 0252	19x17	7,3	6
Gp1 Low Seat 125 Eu3	125	07-08	10 040 0250	10 040 0252	19x17	7,3	6
Rambla	125	08	10 040 0250	10 040 0252	19x17	7,3	6
Boulevard	150	02-04	10 040 0270	10 040 0272	19x17	10	6
Boulevard Eu3	150	04-07	10 040 0270	10 040 0272	19x17	10	6
Gp1	250	06-07	-	10 040 0672	21x17	11,2	6
Gp1 Low Seat 250 Eu3	250	07-08	-	10 040 0672	21x17	11,2	6
Rambla	250	08-09	-	10 040 0842	21x17	13,8	6
Rambla	300	10-12	-	10 040 0842	21x17	13,8	6
GILERA							
Dna	50	05-07	10 045 0630	10 045 0642	19x15,5	6,4	6
Dna	50	00-02	10 045 0750	10 045 0752	19x15,5	7,5	6
Dna Gp Experience	50	03-04	10 045 0630	10 045 0642	19x15,5	6,4	6
Easy Moving	50	95-96	10 042 0850	-	16x13	8,5	6
Ice	50	01-05	10 045 0750	10 045 0752	19x15,5	7,5	6
Runner	50	97-00	10 045 0530	10 045 0532	19x15,5	5,3	6
Runner Poggiali	50	02	10 045 0750	10 045 0752	19x15,5	7,5	6
Runner Purejet	50	02-07	10 045 0530	10 045 0532	19x15,5	5,3	6



KIT RULLI PULEGGIA MOTRICE

DRIVING PULLEY ROLLER SETS

MODELLO - MODELS	CC	ANNO YEAR	STANDARD	HIGH QUALITY	DIMENSIONI DIMENSIONS	PESO WEIGHT	PEZZI PCS
Runner Purejet St	50	08-11	10 045 0530	10 045 0532	19x15,5	5,3	6
Runner Sp	50	05-07	10 045 0630	10 045 0642	19x15,5	6,4	6
Runner Sp	50	02-04	10 045 0750	10 045 0752	19x15,5	7,5	6
Runner Sp	50	10-12	10 045 0630	10 045 0642	19x15,5	6,4	6
Runner Sp Special Edition	50	07	10 045 0630	10 045 0642	19x15,5	6,4	6
Runner Sp St & Simoncelli	50	08-09	10 045 0630	10 045 0642	19x15,5	6,4	6
Stalker	50	97-11	10 045 0750	10 045 0752	19x15,5	7,5	6
Stalker Naked	50	08	10 045 0750	10 045 0752	19x15,5	7,5	6
Stalker Special Edition	50	07-08	10 045 0750	10 045 0752	19x15,5	7,5	6
Storm	50	94-95	10 042 0850	-	16x13	8,5	6
Storm Eu2	50	07	10 045 0630	10 045 0642	19x15,5	6,4	6
Typhoon	50	94-97	10 042 0850	-	16x13	8,5	6
Typhoon X	50	98-99	10 042 0850	-	16x13	8,5	6
Typhoon Xr	50	00	10 045 0630	10 045 0642	19x15,5	6,4	6
Dna	125	01	10 040 0250	10 040 0252	19x17	7,3	6
Nexus Eu3 ie	125	08-09	10 040 0250	10 040 0252	19x17	7,3	6
Runner Fx-Fxr	125	97-02	10 040 0140	-	19x17	15	6
Runner Vx	125	05-06	10 040 0250	10 040 0252	19x17	7,3	6
Runner Vx 4T Eu3	125	07	10 040 0250	10 040 0252	19x17	7,3	6
Runner Vx 4T St Eu3	125	08-09	10 040 0250	10 040 0252	19x17	7,3	6
Runner Vx Race	125	06	10 040 0250	10 040 0252	19x17	7,3	6
Runner Vx Sc	125	06-07	10 040 0250	10 040 0252	19x17	7,3	6
Runner Vx Vxr	125	00-01	10 040 0250	10 040 0252	19x17	7,3	6
Runner Vx-Vxr	125	02-04	10 040 0250	10 040 0252	19x17	7,3	6
Typhoon	125	95-98	10 040 0300	-	19x17	13	6
Typhoon X-Xr	125	99-00	10 040 0300	-	19x17	13	6
Runner Fx-Fxr	180	97-02	10 040 0150	-	20x17	15	6
Runner Vx-Vxr	200	02-04	10 040 0320	10 040 0322	21x17	10,7	6
Runner Vxr	200	05-06	10 040 0320	10 040 0322	21x17	10,7	6
Runner Vxr 4T St Eu3	200	08-11	10 040 0320	10 040 0322	21x17	10,7	6
Runner Vxr Eu3	200	07	10 040 0320	10 040 0322	21x17	10,7	6
Runner Vxr Race	200	06	10 040 0320	10 040 0322	21x17	10,7	6
Nexus Eu3	250	07	-	10 040 0672	21x17	11,2	6
Nexus Eu3	250	06	10 040 0250	10 040 0252	19x17	7,3	6
Nexus Sp Eu3	250	06-07	10 040 0250	10 040 0252	19x17	7,3	6
Oregon	250	06-08	-	10 040 0672	21x17	11,2	6
Nexus Eu3	300	08-12	10 040 0250	10 040 0252	19x17	7,3	6
Fuoco	500	07-12	-	10 040 0652	25x17	21,4	8
Nexus	500	03-05	10 040 0480	-	25x22	27,3	6
Nexus Eu3	500	06-12	-	10 040 0652	25x17	21,4	8
Nexus Sp Eu3	500	06-07	-	10 040 0652	25x17	21,4	8
HONDA							
Gp Dio	50	91	10 042 0850	-	16x13	8,5	6
Sfx V	50	95	10 042 0900	-	16x13	9	6
Sh	50	96	10 042 0900	-	16x13	9	6
Shadow	50		10 042 0900	-	16x13	9	6

KIT RULLI PULEGGIA MOTRICE

DRIVING PULLEY ROLLER SETS



MODELLO - MODELS	CC	ANNO YEAR	STANDARD	HIGH QUALITY	DIMENSIONI DIMENSIONS	PESO WEIGHT	PEZZI PCS
Sj Bali	50	93	10 042 0850	-	16x13	8,5	6
Sky	50	97	10 042 0500	-	16x13	5	6
Vision Met-In	50		10 042 0850	-	16x13	8,5	6
Vision Prima Serie	50	85-87	10 042 0750	-	16x13	7,5	6
Nps Zoomer	50		10 042 0550	-	16x13	5,5	6
Sh	100	96-99	10 042 1000	-	16x13	10	6
Sj Bali	100	96-99	10 042 1000	-	16x13	10	6
Nsc Vision	110		10 040 0100	-	18x14	14,5	6
Chiocciola	125	00-06	10 040 0430	-	20x15	11,5	6
Dylan	125	01-06	10 040 0430	-	20x15	11,5	6
Nes	125	00-07	10 040 0440	-	20x15	12,5	6
Pantheon 2T	125	98-02	10 040 0050	-	23x18	15,5	6
Pantheon	125	03-05	10 040 0440	-	20x15	12,5	6
Sh 125 - 125i	125	01-12	10 040 0430	-	20x15	11,5	6
Pcx	125	10-13	10 040 0460	-	20x15	16,5	6
Ps	125	06-10	10 040 0430	-	20x15	11,5	6
Chiocciola	150	00-06	10 040 0440	-	20x15	12,5	6
Dylan	150	01-06	10 040 0440	-	20x15	12,5	6
Nes	150	00-07	10 040 0440	-	20x15	12,5	6
Pantheon 2T	150	98-02	10 040 0060	-	23x18	16	6
Sh 150 - 150i	150	01-08	10 040 0440	-	20x15	12,5	6
Ps	150	06-10	10 040 0440	-	20x15	12,5	6
Pcx	150	10-14	10 040 0962	-	20x15	18	6
Cn 4T	250		10 040 0070	-	24x18	23	6
Foresight	250		10 040 0080	-	23x18	27	6
Foresight	250	98	10 040 0570	-	23x18	25	6
Jazz	250	00-04	10 040 0580	-	23x18	29,8+20,15	6
Sh i	300	07-12	10 040 0530	-	23x18	19	6
Silver Wing	600		10 040 0600	-	28x20	27	8
ITALJET							
Bazooka	50		10 041 0650	-	15x12	6,5	6
Formula Lc	50	97	10 043 0550	-	17x12	5,5	6
Pista	50		10 041 0650	-	15x12	6,5	6
Reporter	50		10 041 0650	-	15x12	6,5	6
Dragster	125	99-03	10 040 0140	-	19x17	14,5	6
Jet Set 4T	125		10 040 0260	-	19x17	8	6
Jupiter 4T	125		10 040 0350	-	20x12	9	6
Millennium	125		10 040 0350	-	20x12	9	6
Torpedo	125	98-00	10 040 0130	-	19x14	12	6
Torpedo (Mot Leader)	125	00-03	10 040 0260	-	19x17	8	6
Jet Set 4T	150		10 040 0360	-	20x12	9,6	6
Millennium	150		10 040 0360	-	20x12	9,6	6
Dragster	180	99-03	10 040 0150	-	20x17	15	6
Millennium	180		10 041 0750	-	15x12	7,5	6



KIT RULLI PULEGGIA MOTRICE

DRIVING PULLEY ROLLER SETS

MODELLO - MODELS	CC	ANNO YEAR	STANDARD	HIGH QUALITY	DIMENSIONI DIMENSIONS	PESO WEIGHT	PEZZI PCS
KYMCO							
Agility 2T R16	50	10-12	10 042 0850	-	16x13	8,5	6
Agility 4T Carry	50	11-12	10 042 0650	-	16x13	6,5	6
Agility 4T R10	50	06	10 042 0650	-	16x13	6,5	6
Agility 4T R12	50	07-08	10 042 0650	-	16x13	6,5	6
Agility 4T R16	50	08-12	10 042 0650	-	16x13	6,5	6
Agility Plus 2T	50	14	10 042 0850	-	16x13	8,5	6
Agility R12	50	05	10 042 0650	-	16x13	6,5	6
Agility Rs	50	09	10 042 0650	-	16x13	6,5	6
Agility RS Naked 2T	50	10	10 042 0850	-	16x13	8,5	6
B&w	50	02	10 042 0850	-	16x13	8,5	6
B&w Eu2	50	03	10 042 0850	-	16x13	8,5	6
Cx	50	93	10 042 0850	-	16x13	8,5	6
Cx Super	50	94-97	10 042 0850	-	16x13	8,5	6
Dink 50 4T	50	07	10 042 0650	-	16x13	6,5	6
Dink Classic Eu2	50	03	10 042 0850	-	16x13	8,5	6
Dink Lc	50	98-02	10 042 0850	-	16x13	8,5	6
Dj W	50	94-00	10 042 0850	-	16x13	8,5	6
Dj X	50	91-92	10 042 0850	-	16x13	8,5	6
Djy	50	93	10 042 0850	-	16x13	8,5	6
Fever Zx	50	99-00	10 042 0850	-	16x13	8,5	6
Fever Zx Eu2	50	03-04	10 042 0750	-	16x13	7,5	6
Heroism	50	95-97	10 042 0750	-	16x13	7,5	6
K12	50	95-00	10 042 0850	-	16x13	8,5	6
Kb	50	95-00	10 042 0850	-	16x13	8,5	6
Like 2T	50	09	10 042 0850	-	16x13	8,5	6
Like 4T	50	09	10 042 0650	-	16x13	6,5	6
Mxer	50	02-03	10 042 0750	-	16x13	7,5	6
People	50	04	10 042 0850	-	16x13	8,5	6
People	50	99-00	10 042 0850	-	16x13	8,5	6
People Eu2	50	03	10 042 0850	-	16x13	8,5	6
People Eu2	50	08-11	10 042 0850	-	16x13	8,5	6
People S	50	05-08	10 042 0850	-	16x13	8,5	6
People S 4T	50	06-08	10 042 0650	-	16x13	6,5	6
Sento	50	08	10 042 0650	-	16x13	6,5	6
Sniper	50	93	10 042 0750	-	16x13	7,5	6
Sniper Dd	50	94-96	10 042 0750	-	16x13	7,5	6
Super 8	50	07	10 042 0650	-	16x13	6,5	6
Super 8 2T	50	09	10 042 0850	-	16x13	8,5	6
Super 8 2T	50	13	10 042 0850	-	16x13	8,5	6
Super 8 4T	50	09	10 042 0650	-	16x13	6,5	6
Super 9	50	00	10 042 0850	-	16x13	8,5	6
Super 9 Sport Eu2	50	03-04	10 042 0850	-	16x13	8,5	6
Top Boy	50	97-00	10 042 0850	-	16x13	8,5	6
Vitality 2T	50	04	10 042 0850	-	16x13	8,5	6
Vitality 4T	50	04	10 042 0650	-	16x13	6,5	6

KIT RULLI PULEGGIA MOTRICE

DRIVING PULLEY ROLLER SETS



MODELLO - MODELS	CC	ANNO YEAR	STANDARD	HIGH QUALITY	DIMENSIONI DIMENSIONS	PESO WEIGHT	PEZZI PCS
Yup	50	02	10 042 0850	-	16x13	8,5	6
Yup Eu2	50	03	10 042 0850	-	16x13	8,5	6
Agility 4T	125	06	10 040 0230	-	18x14	13,5	6
Agility 4T Eu3	125	06-08	10 040 0230	-	18x14	13,5	6
Agility Carry	125	11-12	10 040 0230	-	18x14	13,5	6
Agility Plus	125	14	10 040 0090	10 040 0092	18x14	13	6
Agility R16	125	09-12	10 040 0090	10 040 0092	18x14	13	6
Agility Rs	125	09	10 040 0230	-	18x14	13,5	6
B&w	125	00	10 040 0110	-	20x15	13,5	6
Dink	125	97-98	10 040 0110	-	20x15	13,5	6
Dink Classic	125	02	10 040 0110	-	20x15	13,5	6
Dink Classic Eu2	125	03	10 040 0110	-	20x15	13,5	6
Dink Lx	125	98-00	10 040 0110	-	20x15	13,5	6
Downtown 125 i	125	09	10 040 0090	10 040 0092	18x14	13	6
Grand Dink	125	01-02	10 040 0110	-	20x15	13,5	6
Grand Dink Eu2	125	03-04	10 040 0110	-	20x15	13,5	6
Heroism	125	95-97	10 040 0090	10 040 0092	18x14	13	6
K-Xct i	125	12-14	10 040 0090	10 040 0092	18x14	13	6
Like	125	09	10 040 0230	-	18x14	13,5	6
Like Lx	125	12	10 040 0230	-	18x14	13,5	6
Movie	125	99-00	10 040 0090	10 040 0092	18x14	13	6
Movie 125 Eu3	125	06-07	10 040 0230	-	18x14	13,5	6
Movie XL	125	01	10 040 0230	-	18x14	13,5	6
Movie XL Eu2	125	03-04	10 040 0230	-	18x14	13,5	6
People	125	99-00	10 040 0090	10 040 0092	18x14	13	6
People Eu2	125	03	10 040 0090	10 040 0092	18x14	13	6
People Eu3	125	07-11	10 040 0090	10 040 0092	18x14	13	6
People Gti	125	10	10 040 0090	10 040 0092	18x14	13	6
People One i	125	13-14	10 040 0230	-	18x14	13,5	6
People S	125	05	10 040 0090	10 040 0092	18x14	13	6
People S Dd Eu3	125	07-08	10 040 0090	10 040 0092	18x14	13	6
Super 8	125	08-09	10 040 0090	10 040 0092	18x14	13	6
Vivio	125	00	10 040 0090	10 040 0092	18x14	13	6
Agility R16	150	08-09	10 040 0090	10 040 0092	18x14	13	6
B&w	150	97-00	10 040 0120	-	20x15	14,5	6
B&w Eu2	150	03-04	10 040 0120	-	20x15	14,5	6
Dink Classic	150	02	10 040 0120	-	20x15	14,5	6
Dink Classic Eu2	150	03	10 040 0120	-	20x15	14,5	6
Dink Lx	150	98-00	10 040 0120	-	20x15	14,5	6
Grand Dink Eu2	150	01-02	10 040 0460	-	20x15	16,5	6
Grand Dink Eu2	150	03-04	10 040 0460	-	20x15	16,5	6
Heroism	150	95-97	10 040 0100	-	18x14	14,5	6
Movie 150 Eu3	150	06-07	10 040 0240	-	18x14	15,5	6
Movie XL	150	01	10 040 0240	-	18x14	15,5	6
Movie XL Eu2	150	03-04	10 040 0240	-	18x14	15,5	6
People	150	99-00	10 040 0100	-	18x14	14,5	6



KIT RULLI PULEGGIA MOTRICE

DRIVING PULLEY ROLLER SETS

MODELLO - MODELS	CC	ANNO YEAR	STANDARD	HIGH QUALITY	DIMENSIONI DIMENSIONS	PESO WEIGHT	PEZZI PCS
People 0 Eu2	150	03	10 040 0100	-	18x14	14,5	6
Vivio	150	00	10 040 0100	-	18x14	14,5	6
Agility 200 R16	200	10-12	10 040 0230	-	18x14	13,5	6
Agility i Plus	200	14	10 040 0090	10 040 0092	18x14	13	6
Agility Plus	200	14	10 040 0230	-	18x14	13,5	6
Dink Classic	200	04	10 040 0460	-	20x15	16,5	6
Like 200i	200	09	10 040 0230	-	18x14	13,5	6
Like Lx	200	12	10 040 0230	-	18x14	13,5	6
People S	200	05	10 040 0090	10 040 0092	18x14	13	6
People S i	200	07	10 040 0090	10 040 0092	18x14	13	6
B&w	250	00	10 040 0540	-	23x18	20	6
B&w Eu2	250	03	10 040 0540	-	23x18	20	6
Grand Dink	250	01-02	10 040 0540	-	23x18	20	6
Grand Dink Eu2	250	03-04	10 040 0540	-	23x18	20	6
People Lc	250	03-04	10 040 0540	-	23x18	20	6
People S	250	06	10 040 0540	-	23x18	20	6
People S 250i	250	07	10 040 0540	-	23x18	20	6
X Citing	250	05	10 040 0540	-	23x18	20	6
X Citing i	250	06-07	10 040 0540	-	23x18	20	6
Yup	250	03	10 040 0540	-	23x18	20	6
Downtown Abs i	300	10-12	10 040 0410	-	20x12	15,3	8
Downtown-Downtown i	300	09-11	10 040 0410	-	20x12	15,3	8
Gran Dink	300	12	10 040 0540	-	23x18	20	6
K-Xct i	300	12	10 040 0410	-	20x12	15,3	8
K-Xct i Abs	300	14	10 040 0410	-	20x12	15,3	8
People Gti	300	11-14	10 040 0410	-	20x12	15,3	8
People Gti Abs	300	12-14	10 040 0410	-	20x12	15,3	8
People S i	300	08	-	10 040 0942	23x17,5	17,5	6
X Citing i	300	08	-	10 040 0942	23x17,5	17,5	6
X Citing i R	300	08-09	-	10 040 0942	23x17,5	17,5	6
X Citing i	400	13-15	-	10 040 0742	25x20	17	6
X Citing i ABS	400	13-15	-	10 040 0742	25x20	17	6
X Citing	500	05	-	10 040 0732	29x22	33,5	6
X Citing 500 R	500	09	-	10 040 0732	29x22	33,5	6
X Citing 500i	500	06-08	-	10 040 0732	29x22	33,5	6
X Citing 500i R	500	07-08	-	10 040 0732	29x22	33,5	6
MALAGUTI							
Centro Base	50	93-94	10 041 0700	-	15x12	7	6
Centro SL	50	94-98	10 041 0700	-	15x12	7	6
Centro SL Kat	50	99-00	10 041 0700	-	15x12	7	6
Crosser Cr1	50	95-98	10 041 0550	-	15x12	5,5	6
F10 Jet Line	50	92-98	10 041 0650	-	15x12	6,5	6
F10 Kat	50	99-00	10 041 0650	-	15x12	6,5	6
F10 Rst Eu1	50	01-02	10 041 0650	-	15x12	6,5	6
F10 Rst Eu2	50	02-06	10 041 0650	-	15x12	6,5	6
F12 Aria Rst Eu2	50	06	10 041 0650	-	15x12	6,5	6
F12 Phantom	50	94-98	10 041 0650	-	15x12	6,5	6

KIT RULLI PULEGGIA MOTRICE

DRIVING PULLEY ROLLER SETS



MODELLO - MODELS	CC	ANNO YEAR	STANDARD	HIGH QUALITY	DIMENSIONI DIMENSIONS	PESO WEIGHT	PEZZI PCS
F12 Phantom Eu1	50	99-00	10 041 0650	-	15x12	6,5	6
F12 Phantom Lc	50	94-98	10 041 0650	-	15x12	6,5	6
F12 Phantom Lc Rst Eu1	50	01-02	10 041 0650	-	15x12	6,5	6
F12 Phantom Lc Rst Eu2	50	02	10 041 0650	-	15x12	6,5	6
F15 Fire Fox Air Cooled	50	05-06	10 041 0650	-	15x12	6,5	6
Yesterday – Euro	50	97-00	10 041 0650	-	15x12	6,5	6
Ciak	100	99-00	10 043 0660	-	17x12	6,6	6
Blog ie	125	09-11	10 040 0430	-	20x15	11,5	6
Centro ie	125	08-09	10 040 0430	-	20x15	11,5	6
Centro SL ie	125	09-11	10 040 0430	-	20x15	11,5	6
Ciak	125	00-01	10 040 0090	10 040 0092	18x14	13	6
Ciak Master	125	04	10 040 0090	10 040 0092	18x14	13	6
Ciak Master Eu3	125	06	10 040 0090	10 040 0092	18x14	13	6
Ciak Rst Eu2	125	03	10 040 0090	10 040 0092	18x14	13	6
F18 Warrior	125	00-02	10 040 0430	-	20x15	11,5	6
Madison	125	99-01	10 040 0340	-	20x12	8,5	6
Madison R Rst	125	02	10 040 0340	-	20x12	8,5	6
Madison R Rst Eu2	125	03-04	10 040 0360	-	20x12	9,6	6
Phantom Max	125	03	10 040 0360	-	20x12	9,6	6
Ciak	150	00-02	10 040 0100	-	18x14	14,5	6
Ciak Master	150	04	10 040 0100	-	18x14	14,5	6
Ciak Rst Eu2	150	03	10 040 0100	-	18x14	14,5	6
F18 Warrior	150	00-02	10 040 0110	-	20x15	13,5	6
Madison T	150	99-01	10 040 0360	-	20x12	9,6	6
Blog ie	160	09-11	10 040 0430	-	20x15	11,5	6
Centro ie	160	08-09	10 040 0430	-	20x15	11,5	6
Ciak Master Eu2	200	06	10 040 0090	10 040 0092	18x14	13	6
Madison S	250	99-01	10 040 0400	-	20x12	13,5	8
Madison K	400	02	10 040 0610	-	26x13	17,5	8
Madison K Rst	400	02-04	10 040 0610	-	26x13	17,5	8
MBK							
Booster	50	01-02	10 041 0620	-	15x12	6,2	6
Booster	50	92-94	10 041 0650	-	15x12	6,5	6
Booster Naked	50	03	10 041 0620	-	15x12	6,2	6
Booster Ng	50	01-03	10 041 0620	-	15x12	6,2	6
Booster Ng	50	95-98	10 041 0700	-	15x12	7	6
Booster Ng	50	99	10 041 0650	-	15x12	6,5	6
Booster Ng Eu1	50	99-00	10 041 0650	-	15x12	6,5	6
Booster Road (Ita)	50	94-95	10 041 0650	-	15x12	6,5	6
Booster Spirit	50	03	10 041 0620	-	15x12	6,2	6
Booster Spirit	50	96-98	10 041 0700	-	15x12	7	6
Booster Spirit	50	99-00	10 041 0650	-	15x12	6,5	6
Booster Spirit Eu2	50	02	10 041 0620	-	15x12	6,2	6
Booster Spirit Eu2	50	02-03	10 041 0620	-	15x12	6,2	6
Booster Track	50	96-98	10 041 0700	-	15x12	7	6
Evolis	50	94-95	10 041 0700	-	15x12	7	6



KIT RULLI PULEGGIA MOTRICE

DRIVING PULLEY ROLLER SETS

MODELLO - MODELS	CC	ANNO YEAR	STANDARD	HIGH QUALITY	DIMENSIONI DIMENSIONS	PESO WEIGHT	PEZZI PCS
Fizz	50	94-95	10 041 0700	-	15x12	7	6
Flipper	50	98-02	10 041 0650	-	15x12	6,5	6
Flipper Catalitico	50	99-00	10 041 0650	-	15x12	6,5	6
Flipper Eu2	50	03-04	10 041 0650	-	15x12	6,5	6
Forte (Che-Ita)	50	94-96	10 041 0650	-	15x12	6,5	6
Mach G Eu1	50	02-03	10 041 0650	-	15x12	6,5	6
Mach G Eu2	50	02-04	10 041 0650	-	15x12	6,5	6
Nitro	50	97-04	10 041 0550	-	15x12	5,5	6
Nitro Eu2	50	03	10 041 0550	-	15x12	5,5	6
Nitro Jaguar	50	04	10 041 0550	-	15x12	5,5	6
Ovetto (Che-Ita)	50	97-01	10 041 0650	-	15x12	6,5	6
Ovetto Eu1	50	02-04	10 041 0650	-	15x12	6,5	6
Ovetto Eu2	50	02-03	10 041 0650	-	15x12	6,5	6
Sorriso	50	91-92	10 041 0650	-	15x12	6,5	6
Sorriso	50	93-95	10 041 0650	-	15x12	6,5	6
Stunt	50	00-02	10 041 0620	-	15x12	6,2	6
Booster	100	99-01	10 041 0830	-	15x12	8,3	6
Nitro	100	00-02	10 041 0900	-	15x12	9	6
Ovetto	100	00-02	10 041 0900	-	15x12	9	6
Doodo	125	01-02	10 040 0370	-	20x12	10,5	6
Flame - R	125	95-99	10 040 0390	-	20x12	12	6
Flame F	125	00	10 040 0370	-	20x12	10,5	6
Flame R	125	96-99	10 040 0370	-	20x12	10,5	6
Skyliner	125	98-02	10 040 0340	-	20x12	8,5	6
Skyliner	125	01-02	10 040 0370	-	20x12	10,5	6
Thunder	125	01-02	10 040 0370	-	20x12	10,5	6
Thunder	150	01-02	10 040 0370	-	20x12	10,5	6
Skyliner	150	01-02	10 040 0370	-	20x12	10,5	6
Skyliner	180	03	10 040 0410	-	20x12	15,3	8
Skyliner	250	00-03	10 040 0390	-	20x12	11,5	8
Skyliner Abs	250	03	10 040 0390	-	20x12	11,5	8
Kilibre	300	03	10 040 0410	-	20x12	15,3	8
PEUGEOT							
Buxy	50	94-97	10 042 0900	-	16x13	9	6
Elyseo	50	99	10 042 0900	-	16x13	9	6
Looxor	50	01-03	10 042 0900	-	16x13	9	6
Metal-X	50	02	10 042 0900	-	16x13	9	6
Speedake (Keihin)	50	95-97	10 042 0750	-	16x13	7,5	6
Speedake (Mikuni)	50	95-97	10 042 0900	-	16x13	9	6
Speedfight AC-LC	50	97-98	10 042 0900	-	16x13	9	6
Speedfight AC Cat	50	99	10 042 0900	-	16x13	9	6
Squab	50	95-97	10 042 0900	-	16x13	9	6
St Rapido	50	85-93	10 042 0750	-	16x13	7,5	6
Sv Geo	50	91-95	10 042 1100	-	16x13	11	6
Sv Geo (Mod.'94)	50	91-95	10 042 0850	-	16x13	8,5	6
Trekker	50	98-00	10 042 0900	-	16x13	9	6
Vivacity	50	99	10 042 0900	-	16x13	9	6

KIT RULLI PULEGGIA MOTRICE

DRIVING PULLEY ROLLER SETS



MODELLO - MODELS	CC	ANNO YEAR	STANDARD	HIGH QUALITY	DIMENSIONI DIMENSIONS	PESO WEIGHT	PEZZI PCS
Vivacity Catalitico	50	99-02	10 042 0900	-	16x13	9	6
Vivacity Vsx-Xr	50	02-04	10 042 0900	-	16x13	9	6
X-Fight	50	00	10 042 0900	-	16x13	9	6
Xrace	50	03	10 042 0900	-	16x13	9	6
Zenith L	50	94-96	10 042 0850	-	16x13	8,5	6
PGO							
Big Max	50		10 042 0850	-	16x13	8,5	6
PIAGGIO							
Diesis	50	01	10 045 0630	10 045 0642	19x15,5	6,4	6
Fly 2T	50	05-07	10 045 0750	10 045 0752	19x15,5	7,5	6
Fly 2T	50	10-11	10 045 0750	10 045 0752	19x15,5	7,5	6
Fly 4T	50	08	10 045 0630	10 045 0642	19x15,5	6,4	6
Fly 4T	50	08-11		10 045 0982	19x15,5	9,8	6
Fly 4T	50	12	10 045 0530	10 045 0532	19x15,5	5,3	6
Fly 4T 4V	50	12-13	10 045 0530	10 045 0532	19x15,5	5,3	6
Fly 4T Mot Chn	50	06-07	10 045 0630	10 045 0642	19x15,5	6,4	6
Free	50	92-94	10 042 0850	-	16x13	8,5	6
Free Delivery	50	00-01	10 045 0630	10 045 0642	19x15,5	6,4	6
Free FL	50	95-02	10 042 0850	-	16x13	8,5	6
Liberty	50	97-05	10 045 0630	10 045 0642	19x15,5	6,4	6
Liberty (Cat:00)	50	97-05	10 045 0750	10 045 0752	19x15,5	7,5	6
Liberty 2T	50	06-08	10 045 0750	10 045 0752	19x15,5	7,5	6
Liberty 2T Rst	50	04	10 045 0750	10 045 0752	19x15,5	7,5	6
Liberty 2T Sport	50	06-08	10 045 0750	10 045 0752	19x15,5	7,5	6
Liberty 4T	50	00-02	10 045 0530	10 045 0532	19x15,5	5,3	6
Liberty 4T	50	05-08	10 045 0750	10 045 0752	19x15,5	7,5	6
Liberty Moc 2T	50	09-11	10 045 0750	10 045 0752	19x15,5	7,5	6
Liberty 4T Delivery	50	10-11	10 045 0750	10 045 0752	19x15,5	7,5	6
Liberty 4T PTT	50	09-11	10 045 0750	10 045 0752	19x15,5	7,5	6
Liberty 4T Sport	50	07-08	10 045 0750	10 045 0752	19x15,5	7,5	6
Liberty Ptt Eu2	50	04-05	10 045 0750	10 045 0752	19x15,5	7,5	6
Liberty 4T Rst	50	04	10 045 0630	10 045 0642	19x15,5	6,4	6
Liberty 4T Moc & Elle	50	09-11	10 045 0630	10 045 0642	19x15,5	6,4	6
Nrg	50	94-96	10 042 0850	-	16x13	8,5	6
Nrg Extreme	50	99-00	10 045 0630	10 045 0642	19x15,5	6,4	6
Nrg Mc3	50	01-04	10 045 0750	10 045 0752	19x15,5	7,5	6
Nrg Mc3 Acqua	50	01	10 045 0480	-	19x15,5	4,8	6
Nrg Power Dd	50	05-06	10 045 0630	10 045 0642	19x15,5	6,4	6
Nrg Power Dd Spec	50	07-08	10 045 0630	10 045 0642	19x15,5	6,4	6
Nrg Power Dt	50	06-11	10 045 0630	10 045 0642	19x15,5	6,4	6
Nrg Power Purejet	50	04-06	10 045 0530	10 045 0532	19x15,5	5,3	6
Nrg Power Purejet	50	10-11	10 045 0530	10 045 0532	19x15,5	5,3	6
Nrg Purejet	50	02-04	10 045 0530	10 045 0532	19x15,5	5,3	6
Nrg Purejet	50	10	10 045 0530	10 045 0532	19x15,5	5,3	6
Nrg Rst Mc2 (96-97)	50	96-98	10 042 0700	-	16x13	7	6
Nrg Rst Mc2 (98)	50	96-98	10 045 0530	10 045 0532	19x15,5	5,3	6
Ntt	50	95-96	10 042 0850	-	16x13	8,5	6



KIT RULLI PULEGGIA MOTRICE

DRIVING PULLEY ROLLER SETS

MODELLO - MODELS	CC	ANNO YEAR	STANDARD	HIGH QUALITY	DIMENSIONI DIMENSIONS	PESO WEIGHT	PEZZI PCS
Quartz	50	92-96	10 042 0850	-	16x13	8,5	6
Sfera	50	91-93	10 044 0520	-	17x13,5	5,2	6
Sfera Maquillage 2	50	94	10 042 0850	-	16x13	8,5	6
Sfera Rst	50	95-97	10 042 0850	-	16x13	8,5	6
Typhoon	50	01-09	10 045 0630	10 045 0642	19x15,5	6,4	6
Typhoon 2T E2	50	10-12	10 045 0750	10 045 0752	19x15,5	7,5	6
Typhoon 2T E3 Ch	50	11	10 045 0750	10 045 0752	19x15,5	7,5	6
Vespa Et2	50	97-05	10 045 0630	10 045 0642	19x15,5	6,4	6
Vespa Et2 Iniezione	50	97-00	10 045 0750	10 045 0752	19x15,5	7,5	6
Vespa Et4	50	00-05	10 045 0530	10 045 0532	19x15,5	5,3	6
Vespa Lx 2T	50	05-08	10 045 0750	10 045 0752	19x15,5	7,5	6
Vespa Lx 2T FL	50	09-10	10 045 0750	10 045 0752	19x15,5	7,5	6
Vespa Lx 2T Touring	50	10-11	10 045 0750	10 045 0752	19x15,5	7,5	6
Vespa Lxv 2T	50	06-08	10 045 0750	10 045 0752	19x15,5	7,5	6
Vespa Lxv 2T Navy	50	08	10 045 0750	10 045 0752	19x15,5	7,5	6
Vespa Lx 4T-4V touring	50	10-13	10 045 0530	10 045 0532	19x15,5	5,3	6
Vespa Lx 4T-4V	50	09-13	10 045 0530	10 045 0532	19x15,5	5,3	6
Vespa Primavera	50	13-15	10 045 0530	10 045 0532	19x15,5	5,3	6
Vespa S 2T	50	07-11	10 045 0750	10 045 0752	19x15,5	7,5	6
Vespa S 4T-4V & College	50	13-15	10 045 0530	10 045 0532	19x15,5	5,3	6
Vespa S 4T-4V	50	08-11	10 045 0530	10 045 0532	19x15,5	5,3	6
Vespa Sprint 4T-4V	50	14	10 045 0530	10 045 0532	19x15,5	5,3	6
Zip	50	92-93	10 044 0520	-	17x13,5	5,2	6
Zip	50	00-04	10 045 0750	10 045 0752	19x15,5	7,5	6
Zip 2T	50	08-11	10 045 0750	10 045 0752	19x15,5	7,5	6
Zip 4T	50	00-12	10 045 0630	10 045 0642	19x15,5	6,4	6
Zip Fast Raider Rst	50	96-97	10 042 0850	-	16x13	8,5	6
Zip Fast Raider	50	96-97	10 042 0850	-	16x13	8,5	6
Zip Rst	50	95-96	10 042 0850	-	16x13	8,5	6
Zip Bimodale	50	94-97	10 042 0850	-	16x13	8,5	6
Zip Rst	50	96-99	10 042 0850	-	16x13	8,5	6
Zip Sp	50	96-00	10 042 0700	-	16x13	7	6
Zip Sp	50	01-04	10 045 0630	10 045 0642	19x15,5	6,4	6
Zip Sp Eu2	50	06-12	10 045 0630	10 045 0642	19x15,5	6,4	6
Free	100	02-03	10 040 0420	-	20x15	7,3	6
Zip 4T	100	06-10	-	10 045 0982	19x15,5	9,8	6
Beverly	125	01-03	10 040 0320	10 040 0322	21x17	10,7	6
Beverly	125	01-03	-	10 040 0692	19x17	8,6	6
Beverly Eu3	125	07-08	10 040 0250	10 040 0252	19x17	7,3	6
Beverly Eu3 Mic	125	07	10 040 0250	10 040 0252	19x17	7,3	6
Beverly Eu3 Sport	125	07-08	10 040 0250	10 040 0252	19x17	7,3	6
Beverly Rst	125	04-07	10 040 0250	10 040 0252	19x17	7,3	6
Beverly Rst 4T 4V ie Eu3	125	10-12	10 040 0250	10 040 0252	19x17	7,3	6
Beverly Tourer Eu3	125	08-10	10 040 0250	10 040 0252	19x17	7,3	6
Carnaby	125	07-10	10 040 0250	10 040 0252	19x17	7,3	6
Fly	125	05-07	10 040 0260	-	19x17	8	6

KIT RULLI PULEGGIA MOTRICE

DRIVING PULLEY ROLLER SETS



MODELLO - MODELS	CC	ANNO YEAR	STANDARD	HIGH QUALITY	DIMENSIONI DIMENSIONS	PESO WEIGHT	PEZZI PCS
Fly 4T 3V ie E3 Dt	125	13-15	-	10 040 0972	19x17	10,4	6
Fly 4T 3V ie Eu3 Lem	125	12-13	-	10 040 0972	19x17	10,4	6
Fly Eu3	125	07-08	-	10 040 0692	19x17	8,6	6
Fly 4T 3V ie Eu3 Lem	125	12-13	-	10 040 0972	19x17	10,4	6
Hexagon	125	94-97	10 040 0300	-	19x17	13	6
Hexagon Gtx	125	00	10 040 0250	10 040 0252	19x17	7,3	6
Hexagon Lx-Lxt	125	98-99	10 040 0140	-	19x17	14,5	6
Hexagon Lx4	125	98-99	10 040 0130	-	19x14	12	6
Liberty	125	98-00	10 040 0130	-	19x14	12	6
Liberty	125	01-02	-	10 040 0692	19x17	8,6	6
Liberty 4T	125	06-07	-	10 040 0692	19x17	8,6	6
Liberty 4T Eu3	125	07-08	-	10 040 0692	19x17	8,6	6
Liberty 4T Eu3 Delivery	125	08	-	10 040 0692	19x17	8,6	6
Liberty 4T Sport Eu3	125	06-08	-	10 040 0692	19x17	8,6	6
Liberty Rst	125	04-05	-	10 040 0692	19x17	8,6	6
Liberty Rst Ptt	125	05-11	-	10 040 0692	19x17	8,6	6
Liberty Sport	125	06	-	10 040 0692	19x17	8,6	6
Liberty Moc 4T & Elle	125	09-12	-	10 040 0692	19x17	8,6	6
Mp3	125	07-08	10 040 0250	10 040 0252	19x17	7,3	6
Mp3 ie	125	08-09	10 040 0250	10 040 0252	19x17	7,3	6
Mp3 Ibrido	125	09-10	10 040 0250	10 040 0252	19x17	7,3	6
Mp3 ie Touring	125	11	10 040 0250	10 040 0252	19x17	7,3	6
Mp3 Yourban Erl	125	11-12	10 040 0250	10 040 0252	19x17	7,3	6
Sfera	125	95-97	10 040 0130	-	19x14	12	6
Skipper	125	94-97	10 040 0160	-	19x17	12,5	6
Skipper 4T	125	00-02	-	10 040 0692	19x17	8,6	6
Skipper Lx	125	98-99	10 040 0300	-	19x17	13	6
Typhoon 4T 2V E3	125	10-11	-	10 040 0692	19x17	8,6	6
Super Hexagon Gtx 12"	125	01-02	10 040 0250	10 040 0252	19x17	7,3	6
Vespa Et4	125	96-98	10 040 0130	-	19x14	12	6
Vespa Et4	125	99-02	-	10 040 0692	19x17	8,6	6
Vespa Granturismo	125	03-05	10 040 0320	10 040 0322	21x17	10,7	6
Vespa Granturismo Eu3	125	06-07	10 040 0250	10 040 0252	19x17	7,3	6
Vespa Gts Eu3	125	07-11	10 040 0250	10 040 0252	19x17	7,3	6
Vespa Gts 4T ie Super	125	09-12	10 040 0250	10 040 0252	19x17	7,3	6
Vespa Gtv	125	07-08	10 040 0250	10 040 0252	19x17	7,3	6
Vespa Gtv 4T Navy Eu3	125	08	10 040 0250	10 040 0252	19x17	7,3	6
Vespa Lx	125	05-06	-	10 040 0692	19x17	8,6	6
Vespa Lx 4T FL	125	09	-	10 040 0692	19x17	8,6	6
Vespa Lx 4T Eu3 Touring	125	10-11	-	10 040 0692	19x17	8,6	6
Vespa Lx Eu3	125	06-08	-	10 040 0692	19x17	8,6	6
Vespa Lxv ie 4T	125	10-12	-	10 040 0692	19x17	8,6	6
Vespa Lxv 4T Eu3	125	06-09	-	10 040 0692	19x17	8,6	6
Vespa Lxv 4T Navy Eu3	125	08	-	10 040 0692	19x17	8,6	6
Vespa Lx 4T 3V ie - Touring	125	12-13	-	10 040 0972	19x17	10,4	6
Vespa Lx 4T 3V ie - Touring	125	12-13	-	10 040 0972	19x17	10,4	6



KIT RULLI PULEGGIA MOTRICE

DRIVING PULLEY ROLLER SETS

MODELLO - MODELS	CC	ANNO YEAR	STANDARD	HIGH QUALITY	DIMENSIONI DIMENSIONS	PESO WEIGHT	PEZZI PCS
Vespa S 4T Eu3	125	07-08	-	10 040 0692	19x17	8,6	6
Vespa S 4T ie & College	125	09-11	-	10 040 0692	19x17	8,6	6
Vespa S 4T 3V ie	125	12	-	10 040 0972	19x17	10,4	6
Vespa Lx Primavera 4T 3V ie	125	13-15	-	10 040 0992	19,2	19,2	6
Vespa Sprint 4T ie	125	14-15	-	10 040 0992	19,2	19,2	6
Vespa 946 4T 3V Abs	125	13-15	-	10 040 0972	19x17	10,4	6
X Evo	125	07-12	10 040 0250	10 040 0252	19x17	7,3	6
X7 Eu3	125	08	10 040 0250	10 040 0252	19x17	7,3	6
x7 Evo ie Eu3	125	09-10	10 040 0250	10 040 0252	19x17	7,3	6
X8	125	04-06	10 040 0320	10 040 0322	21x17	10,7	6
X8 Premium Eu2	125	06	10 040 0250	10 040 0252	19x17	7,3	6
X8 Premium Eu3	125	06-07	10 040 0250	10 040 0252	19x17	7,3	6
X8 Street Eu2	125	06-07	-	10 040 0692	19x17	8,6	6
X9	125	01-02	10 040 0250	10 040 0252	19x17	7,3	6
X9 Evolution	125	03-06	10 040 0250	10 040 0252	19x17	7,3	6
X9 Evolution Eu3	125	07	10 040 0250	10 040 0252	19x17	7,3	6
X10 4T 4V ie Eu3	125	12	10 040 0250	10 040 0252	19x17	7,3	6
Zip	125	00-02	-	10 040 0692	19x17	8,6	6
Fly	150	05-07	10 040 0270	10 040 0272	19x17	10	6
Fly Eu3	150	08-11	10 040 0270	10 040 0272	19x17	10	6
Liberty	150	01-02	10 040 0270	10 040 0272	19x17	10	6
Liberty 4T Eu3 – Sport	150	08	10 040 0270	10 040 0272	19x17	10	6
Liberty Moc 4T	150	09-10	10 040 0270	10 040 0272	19x17	10	6
Liberty 4T 3V Lem	150	13-14	-	10 040 0982	19x17	15,6	6
Skipper	150	94-97	10 040 0160	-	19x17	12,5	6
Skipper 4T	150	00-02	10 040 0270	10 040 0272	19x17	10	6
Skipper Lx	150	98-99	10 040 0300	-	19x17	13	6
Vespa Et4	150	99-02	10 040 0270	10 040 0272	19x17	10	6
Vespa Lx	150	05-06	10 040 0270	10 040 0272	19x17	10	6
Vespa Lx 4T FL	150	09	10 040 0270	10 040 0272	19x17	10	6
Vespa Lx Eu3	150	06-08	10 040 0270	10 040 0272	19x17	10	6
Vespa Lx Eu3 ie	150	09-11	10 040 0270	10 040 0272	19x17	10	6
Vespa Lx Touring	150	10-11	10 040 0270	10 040 0272	19x17	10	6
Vespa Lt 4T 3V ie	150	14	-	10 040 0982	19x17	15,6	6
Vespa Gts Super ie 4T 3V	150	14-15	-	10 040 0982	19x17	15,6	6
Vespa Primavera 4T 3V	150	13-15	-	10 040 0982	19x17	15,6	6
Vespa S 4T	150	08-09	10 040 0270	10 040 0272	19x17	10	6
Vespa S 4T ie	150	09-11	10 040 0270	10 040 0272	19x17	10	6
Vespa Sprint 4T 3V ie	150	15	-	10 040 0982	19x17	15,6	6
X8 Street Eu2	150	06-08	10 040 0270	10 040 0272	19x17	10	6
Hexagon Gtx	180	00	10 040 0320	10 040 0322	21x17	10,7	6
Hexagon Lx-Lxt	180	98-99	10 040 0150	-	20x17	15	6
Super Hexagon Gtx 12"	180	01-02	10 040 0320	10 040 0322	21x17	10,7	6
X9 Amalfi	180	00-03	10 040 0320	10 040 0322	21x17	10,7	6
Beverly	200	01-03	10 040 0320	10 040 0322	21x17	10,7	6
Carnaby	200	07-08	10 040 0320	10 040 0322	21x17	10,7	6
Liberty	200	06	10 040 0320	10 040 0322	21x17	10,7	6

KIT RULLI PULEGGIA MOTRICE

DRIVING PULLEY ROLLER SETS



MODELLO - MODELS	CC	ANNO YEAR	STANDARD	HIGH QUALITY	DIMENSIONI DIMENSIONS	PESO WEIGHT	PEZZI PCS
Liberty 4T Eu3	200	07-08	10 040 0320	10 040 0322	21x17	10,7	6
Liberty 4T Sport Eu3	200	06-07	10 040 0320	10 040 0322	21x17	10,7	6
Liberty Rst	200	04	10 040 0320	10 040 0322	21x17	10,7	6
Liberty Sport	200	06	10 040 0320	10 040 0322	21x17	10,7	6
Vespa Granturismo	200	03-07	10 040 0320	10 040 0322	21x17	10,7	6
X8	200	05-07	10 040 0320	10 040 0322	21x17	10,7	6
X8 125-200	200	04	10 040 0320	10 040 0322	21x17	10,7	6
X9	200	02-03	10 040 0320	10 040 0322	21x17	10,7	6
X9 Evolution	200	03	10 040 0320	10 040 0322	21x17	10,7	6
Beverly	250	06-07	-	10 040 0672	21x17	11,2	6
Beverly Cruiser	250	07-09	-	10 040 0842	21x17	13,8	6
Beverly Eu3 Mic	250	07	-	10 040 0842	21x17	13,8	6
Beverly ie Eu3	250	06-08	-	10 040 0842	21x17	13,8	6
Beverly Rst	250	04-05	-	10 040 0672	21x17	11,2	6
Beverly Sport	250	06-08	-	10 040 0842	21x17	13,8	6
Beverly Tourer Eu3	250	08-09	-	10 040 0842	21x17	13,8	6
Carnaby	250	08	-	10 040 0842	21x17	13,8	6
Hexagon Gt-Gtx	250	98-00	10 040 0070	-	24x18	23	6
Mp3	250	06-08	-	10 040 0672	21x17	11,2	6
Mp3 Lt	250	09	-	10 040 0672	21x17	11,2	6
Mp3 Mic	250	08-09	-	10 040 0672	21x17	11,2	6
Vespa Gt 60 Eu3	250	06-07	-	10 040 0672	21x17	11,2	6
Vespa Gts- Abs	250	05-11	-	10 040 0672	21x17	11,2	6
Vespa Gtv	250	06-09	-	10 040 0672	21x17	11,2	6
Vespa Gtv 4T Navy	250	08	-	10 040 0672	21x17	11,2	6
X7 Eu3	250	08	-	10 040 0672	21x17	11,2	6
X8 Eu3	250	05-08	-	10 040 0672	21x17	11,2	6
X9	250	00-01	10 040 0560	-	23x18	24	6
X9 Evolution	250	04-06	-	10 040 0672	21x17	11,2	6
Xevo	250	07-11	-	10 040 0672	21x17	11,2	6
Beverly 300 ie Tourer	300	09-10	-	10 040 0842	21x17	13,8	6
Beverly Rst 4T 4V ie Eu3	300	10-12	-	10 040 0842	21x17	13,8	6
Carnaby Cruiser	300	09-11	-	10 040 0842	21x17	13,8	6
Mp3 ie Lt	300	10-11	-	10 040 0842	21x17	13,8	6
Mp3 ie Mic	300	10-11	-	10 040 0842	21x17	13,8	6
Mp3 4T 4V Lt Ibrido	300	10-11	-	10 040 0842	21x17	13,8	6
Mp3 ie Lt Touring	300	11	-	10 040 0842	21x17	13,8	6
Mp3 ie Lt - ie Lt Sport	300	11-13	-	10 040 0842	21x17	13,8	6
Mp3 Lt Sport - Business Abs	300	14	-	10 040 0842	21x17	13,8	6
Mp3 ie Touring	300	11	-	10 040 0842	21x17	13,8	6
Mp3 Yourban Erl	300	11-15	-	10 040 0842	21x17	13,8	6
Mp3 Yourban Lt Erl	300	11-12	-	10 040 0842	21x17	13,8	6
Vespa Gts Super	300	08-11	-	10 040 0842	21x17	13,8	6
Vespa Gts ie Touring	300	11-12	-	10 040 0842	21x17	13,8	6
Vespa Gts ie & Touring	300	12-15	-	10 040 0842	21x17	13,8	6
Vespa Gts ie	300	12	-	10 040 0842	21x17	13,8	6



KIT RULLI PULEGGIA MOTRICE

DRIVING PULLEY ROLLER SETS

MODELLO - MODELS	CC	ANNO YEAR	STANDARD	HIGH QUALITY	DIMENSIONI DIMENSIONS	PESO WEIGHT	PEZZI PCS
Vespa Gts Super Sport	300	10-13	-	10 040 0842	21x17	13,8	6
Vespa Gtv 4T ie	300	10-13	-	10 040 0842	21x17	13,8	6
Vespa Gtv Via Montenapoleone	300	10	-	10 040 0842	21x17	13,8	6
X7 Evo ie Eu3	300	09-10	-	10 040 0842	21x17	13,8	6
Beverly Eu3	400	06-07	-	10 040 0642	25x17	18,6	6
Beverly Tourer Eu3	400	08-10	-	10 040 0642	25x17	18,6	8
Mp3	400	07-08	-	10 040 0642	25x17	18,6	8
Mp3 Lt	400	09	-	10 040 0642	25x17	18,6	8
Mp3 Mic	400	08-11	-	10 040 0642	25x17	18,6	8
Mp3 ie Lt -Sport	400	08-10	-	10 040 0642	25x17	18,6	8
Mp3 ie Lt Touring	400	11	-	10 040 0642	25x17	18,6	8
Mp3 ie Rt Touring	400	11	-	10 040 0642	25x17	18,6	8
X Evo	400	07-09	-	10 040 0642	25x17	18,6	8
X8 Eu3	400	06-08	-	10 040 0642	25x17	18,6	8
Beverly	500	02-04	10 040 0480	-	25x22	27,3	8
Beverly	500	05-06	-	10 040 0652	25x17	21,4	6
Beverly Cruiser	500	07-12	-	10 040 0652	25x17	21,4	8
Beverly Eu3	500	06-08	-	10 040 0652	25x17	21,4	8
Mp3 Lt Sport – Business	500	11-13	-	10 040 0652	25x17	21,4	8
Mp3 Rl Sport – Business	500	11-12	-	10 040 0652	25x17	21,4	8
X9	500	01-02	10 040 0500	-	25x22	29	8
X9 Evolution	500	03-05	10 040 0480	-	25x22	27,3	8
X9 Evolution–Abs	500	06-07	-	10 040 0652	25x17	21,4	8
X10 4T 4V ie Eu3	500	12-14	-	10 040 0652	25x17	21,4	8
SUZUKI							
Address	50	92-95	10 043 0660	-	17x12	6,6	6
Aj Zz Sepia S	50	95-97	10 043 0660	-	17x12	6,6	6
Ap R-T (R7)	50	94-97	10 043 0660	-	17x12	6,6	6
AY AYW K1-K4	50	01-04	10 043 0660	-	17x12	6,6	6
Katana V-Y	50	97-00	10 043 0720	-	17x12	7,2	6
Zillion	50	99	10 043 0680	-	17x12	6,8	6
Burgman K2-K6	125	02-06	10 040 0170	-	20x15	13	6
Burgman K7-L0	125	07-10	10 040 0170	-	20x15	13	6
Burgman L1	125	11	10 040 0170	-	20x15	13	6
Sixteen	125	08-11	10 040 0470	-	20x17	10	6
Uc Epicuro X - K1	125	99-01	-	10 040 0902	20x15	14	6
Epicuro	150	99-01	10 040 0170	-	20x15	13	6
Ux Sixteen K8 - L0	150	08-10	-	10 040 0902	20x15	14	6
Sixteen	150	08-11	10 040 0470	-	20x17	10	6
Uh Burgman K7-L0	200	07-10	-	10 040 0892	24x17	14	6
Uh Burgman L1	200	11-12	-	10 040 0892	24x17	14	6
Uh Burgman L3	200	13	-	10 040 0892	24x17	14	6
Burgman	250	03-06	10 040 0180	-	24x18	31	6
Burgman	250	98-02	10 040 0180	-	24x18	31	6
Burgman	400	99-02	10 040 0190	-	26x13	21,4	8
Burgman	400	03-12	10 040 0620	-	26x13	19	8

KIT RULLI PULEGGIA MOTRICE

DRIVING PULLEY ROLLER SETS



MODELLO - MODELS	CC	ANNO YEAR	STANDARD	HIGH QUALITY	DIMENSIONI DIMENSIONS	PESO WEIGHT	PEZZI PCS
YAMAHA							
Aerox	50	97-12	10 041 0550	-	15x12	5,5	6
Aerox Eu2	50	03	10 041 0550	-	15x12	5,5	6
Aerox R	50	99-00	10 041 0550	-	15x12	5,5	6
Axis	50	95-96	10 041 0650	-	15x12	6,5	6
Breeze	50	94-95	10 041 0700	-	15x12	7	6
Bw'S	50	03	10 041 0620	-	15x12	6,2	6
Bw'S	50	04-05	10 041 0550	-	15x12	5,5	6
Bw'S	50	06-12	10 041 0550	-	15x12	5,5	6
Bw'S Bump	50	97-98	10 041 0700	-	15x12	7	6
Bw'S Naked	50	03	10 041 0620	-	15x12	6,2	6
Bw'S Naked	50	04	10 041 0550	-	15x12	5,5	6
Bw'S Naked	50	09-12	10 041 0550	-	15x12	5,5	6
Bw'S Next Generation	50	01-06	10 041 0620	-	15x12	6,2	6
Bw'S Next Generation	50	04-06	10 041 0550	-	15x12	5,5	6
Bw'S Next Generation	50	97-98	10 041 0700	-	15x12	7	6
Bw'S Next Generation	50	99	10 041 0650	-	15x12	6,5	6
Bw'S Next Generation Cat.	50	99-00	10 041 0650	-	15x12	6,5	6
Bw'S Original	50	01-02	10 041 0620	-	15x12	6,2	6
Bw'S Original	50	97-98	10 041 0700	-	15x12	7	6
Bw'S Original	50	99-00	10 041 0650	-	15x12	6,5	6
Bw'S Original Eu2	50	02	10 041 0620	-	15x12	6,2	6
Bw'S Original Eu2	50	03	10 041 0620	-	15x12	6,2	6
Bw'S R	50	01	10 041 0620	-	15x12	6,2	6
Cr Z	50	91-95	10 041 0650	-	15x12	6,5	6
Ct Ss	50	92-95	10 041 0650	-	15x12	6,5	6
Cts	50	90-95	10 041 0650	-	15x12	6,5	6
Jog R	50	02-11	10 041 0650	-	15x12	6,5	6
Jog R Eu2	50	02-05	10 041 0650	-	15x12	6,5	6
Neo'S	50	97-12	10 041 0650	-	15x12	6,5	6
Neo'S Eu2	50	02-03	10 041 0650	-	15x12	6,5	6
Slider	50	00-02	10 041 0620	-	15x12	6,2	6
Spy	50	95-98	10 041 0700	-	15x12	7	6
Why	50	98-02	10 041 0650	-	15x12	6,5	6
Why Eu1	50	99-00	10 041 0650	-	15x12	6,5	6
Why Eu2	50	03-05	10 041 0650	-	15x12	6,5	6
Aerox	100	00-02	10 041 0900	-	15x12	9	6
Bw'S	100	99-01	10 041 0830	-	15x12	8,3	6
Neo'S	100	99-02	10 041 0900	-	15x12	9	6
Yw Bw's	125	10	10 040 0220	-	20x12	12	6
Cygnus - Cygnus R	125	95-98	10 040 0390	-	20x12	11,5	8
Cygnus - Cygnus R	125	97	10 040 0220	-	20x12	12	6
Cygnus R	125	99-03	10 040 0370	-	20x12	10,5	6
Hw Xenter	125	12-15	-	10 040 0912	20x12	13	6
Majesty	125	98-00	10 040 0340	-	20x12	8,5	6
Majesty	125	01-02	10 040 0040	-	20x12	14	8
Majesty	125	03-05	10 040 0370	-	20x12	10,5	6



KIT RULLI PULEGGIA MOTRICE

DRIVING PULLEY ROLLER SETS

MODELLO - MODELS	CC	ANNO YEAR	STANDARD	HIGH QUALITY	DIMENSIONI DIMENSIONS	PESO WEIGHT	PEZZI PCS
Maxster	125	01-02	10 040 0370	-	20x12	10,5	6
Teo'S	125	00	10 040 0370	-	20x12	10,5	6
Xc125 Majesty S	125	14	-	10 040 0912	20x12	13	6
X-City	125	08-11	10 040 0370	-	20x12	10,5	6
X-Max	125	06-14	10 040 0370	-	20x12	10,5	6
X-Max Abs	125	13-14	10 040 0370	-	20x12	10,5	6
Hw Xenter	150	12-15	-	10 040 0912	20x12	13	6
Teo'S	150	01-02	10 040 0040	-	20x12	14	8
Maxster	150	01-02	10 040 0040	-	20x12	14	8
Majesty	150	01-02	10 040 0040	-	20x12	14	8
Majesty	180	03-06	10 040 0410	-	20x12	15,3	8
Black X-Max	250	09	10 040 0770	-	20x12	12	6
Majesty	250	00-03	10 040 0390	-	20x12	11,5	8
Majesty	250	96-98	10 040 0040	-	20x12	14	8
Majesty Abs	250	03	10 040 0390	-	20x12	11,5	8
Majesty Dx	250	98-99	10 040 0040	-	20x12	14	8
X-Max	250	05-09	10 040 0040	-	20x12	14	8
X-City	250	08-12	10 040 0770	-	20x12	12	8
X-Max -Abs- Sport	250	07-12	10 040 0770	-	20x12	12	8
Versity	300	03-06	10 040 0410	-	20x12	15,3	8
Majesty	400	04-08	10 040 0660	-	25x15	15	8
Majesty Abs	400	07-08	10 040 0660	-	25x15	15	8
Majesty - Abs	400	09-12	-	10 040 0832	25x15	18	8
Yp X-Max	400	13-14	-	10 040 0862	25x15	17	8
T-Max- Abs -Black M.-White M.-Night M.	500	04-11	-	10 040 0832	25x15	18	8
T-Max	500	01-03	-	10 040 0922	25x15	20	8
T-Max	530	12-13	-	10 040 0832	25x15	18	8
T-Max Abs	530	12-13	-	10 040 0832	25x15	18	8

KIT TAGLIANDO SCOOTER

SERVICE KIT FOR SCOOTER



RMS
MOTORCYCLE PARTS

DAYCO

CHAMPION









CODICE KIT TAGLIANDO SERVICE KIT CODE	PASTIGLIE - GANASCIA BRAKE PADS - BRAKE SHOES		FILTRO ARIA AIR FILTER	FILTRO OLIO OIL FILTER CHAMPION	CANDELA SPARK PLUG CHAMPION	CINGHIA BELT DAYCO	RULLINI ROLLERS
	ANT-FRONT	POST-REAR					
APRILIA: Scarabeo 50 4t 06-09 Scarabeo 4t 4v Net 09 Scarabeo Restyling Eu3 06-09 Scarabeo Quattro 09							
16 382 0090 	22 510 0190	22 512 0421	10 060 2100 (AP8202249) Aspirazione - Intake 10 060 1180 (832972) Carter	-	24 621 0220	16 375 0069 (480852)	10 045 0532 (CM1102035) 19 X 15,5 5,3GR
HONDA: Sh 125 02-08							
16 382 0050 	22 510 0270	22 512 0471	10 060 1131 (17210KGF900)	-	24 621 0500	16 375 0479 (23100KGF91)	10 040 0430 20 X 15 11,5GR
HONDA: Sh 125 >09							
16 382 0060 	22 510 2540	22 510 2560	10 060 1131 (17210KGF900)	-	24 621 0500	16 375 0479 (23100KGF91)	10 040 0430 20 X 15 11,5GR
HONDA: Sh 150 I							
16 382 0070 	22 510 2540	22 510 2560	10 060 1131 (17210KGF900)	-	24 621 0500	16 375 0739 (23100KGF901)	10 040 0440 20 X 15 12,5GR
HONDA: Sh 150 01-08							
16 382 0080 	22 510 0270	22 512 0471	10 060 1131 (17210KGF900)	-	24 621 0500	16 375 0739 (23100KGF901)	10 040 0440 20 X 15 12,5GR
KYMCO: 50 4t 12"							
16 382 0170 	22 510 0580	22 512 0091	10 060 2390 (0164044)	-	24 621 0400	16 375 0330 (00107541)	10 042 0650 16 x 13 6,5GR
KYMCO: 50 4t 10"							
16 382 0180 	22 510 0580	22 512 0091	10 060 2400 (0163126)	-	24 621 0400	16 375 0330 (00107541)	10 042 0650 16 x 13 6,5GR
KYMCO: Agility 125 R16							
16 382 0040 	22 510 2710	22 510 1200	10 060 2310 (0162377)	-	24 621 0400	16 375 0441 (00127541) 	10 040 0090 18 X 14 13 GR
MBK: Booster 50							
16 382 0140 	22 510 0190	22 512 0061	10 060 0310 (3VLE44510100)	-	24 621 0200	16 375 0089	10 041 0650 15 x 12 6,5GR
PEUGEOT: Tkr 50							
16 382 0160 	22 510 0080	22 512 0091	10 060 0370 (730199)	-	24 621 0130	16 375 0169	10 042 0900 16 X 13 9GR 6PZ
PIAGGIO: Zip 50 2t 08-13							
16 382 0130 	22 510 0300	22 512 0351	10 060 0920 (487719) Aspirazione - Intake 10 060 1190 (486942) Carter	-	24 621 0270	16 375 0050 (478954)	10 045 0752 (CM1102015) 19X15,5 7,5GR
PIAGGIO: Liberty 125 Ptt 05-11							
16 382 0020 	22 510 0300	22 512 0421	10 060 0910 (487287)	10 060 9045 (86235R)	24 621 0250	16 375 0389 (841213)	10 040 0692 (CM1038035) 19 X 17 8,6GR



KIT TAGLIANDO SCOOTER

SERVICE KIT FOR SCOOTER



CODICE KIT TAGLIANDO SERVICE KIT CODE	PASTIGLIE - GANASCIA BRAKE PADS - BRAKE SHOES		FILTRO ARIA AIR FILTER	FILTRO OLIO OIL FILTER CHAMPION	CANDELA SPARK PLUG CHAMPION	CINGHIA BELT DAYCO	RULLINI ROLLERS
	ANT-FRONT	POST-REAR					
PIAGGIO: Vespa Lx 125 05-11							
16 382 0100 	22 510 0300	22 512 0351	10 060 1160 (843194)	10 060 9045 (86235R)	24 621 0500	16 375 0389 (841213)	10 040 0692 (CM1038035) 19 X 17 8,6GR
PIAGGIO: Vespa Gts 125 le 07-12							
16 382 0190 	22 510 2620	22 510 0450	10 060 2560 (842093) Variatore - Pulley 10 060 2110 (831997) Aspirazione - Intake	10 060 9045 (86235R)	24 621 0210	16 375 0389 (841213)	10 040 0252 (CM1038045) 19 X 17 7,3GR
PIAGGIO: Vespa Gts 300 10-13							
16 382 0120 	22 510 2620	22 510 0450	10 060 2560 (842093) Variatore - Pulley 10 060 2110 (831997) Aspirazione - Intake	10 060 9045 (86235R)	24 621 0500	16 375 0810 (843963)	10 040 0842 (CM849480) 21 X 17 13,8GR
PIAGGIO: Mp3 400							
16 382 0030 	22 510 0300	22 510 2620	10 060 0990 (829258)	10 060 9075	24 651 0250	16 375 0680 (832738)	10 040 0642 (849914) 25 X 17 18,6GR 8PZ
YAMAHA: Aerox 50							
16 382 0150 	22 510 0190	22 510 0280	10 060 0060 (3KJ144510000)	-	24 621 0200	16 375 0089	10 041 0550 15 x 12 5,5GR
YAMAHA: X-Max 125 06-09							
16 382 0010 	22 510 0770	22 510 0490	10 060 2410 (1B9144510000)	10 060 9385	24 621 0500	16 375 0800 (B9E7641000)	10 040 0370 20 X 12 10,5GR
YAMAHA: Majesty 125 06-09							
16 382 0110 	22 510 0430	22 510 0490	10 060 0870 (SDS154070100) Variatore - Pulley 10 060 0790 (5DSE44510000) Aspirazione - Intake	-	24 621 0240	16 375 0300 (NSE7641000)	10 040 0370 20 X 12 10,5GR



10 025 0010 

50: MINARELLI - MBK - YAMAHA
(R.O. 3ES156010100)



10 025 0020 

APRILIA 50: Sonic
MALAGUTI 50: F10 • Yesterday
MBK 50: Evolis • Fizz • Forte
YAMAHA 50: Breeze • Axis
(R.O. 70104100)



10 025 0600 

GILERA 50 : Dna • Easy Moving
Ice • Runner • Stalker Storm • Typhoon • X • XR
PIAGGIO 50: Diesis • Free • FL • Delivery
• Liberty - 2/4T • Ntt • Nrg • Mc3
Rst • Mc2 • Extreme • Quartz • Sfera Rst •
Maquillage • Base • Skr City • Typhoon
Vespa Et2 • Iniez. Et4 • Zip • 2/4 T • Base
Rst • Fast • Rider Rst • Sp
(R.O. 488079)



10 025 0620 

PIAGGIO 125: Liberty 98-00 • Sfera Rst 95-97 •
Vespa Et4 • 96-99-Hexagon LX 4 98-99
(R.O. 478723)



10 025 0630 

GILERA 125: Runner Fx • Fxr-Typhoon • X • Xr •
95-00
PIAGGIO 125-150: Hexagon • Skipper
Skipper Lx 94-99
125-180: Hexagon LX • Lxt
(R.O. 434087)



10 025 0680 

KYMCO 50: Agility 4T Carry 11 • Agility 4T R12
07-08 • Agility Rs 09 • Agility R12 05 • Cx 93-97 •
Dink 4T 07 • Dj 93-00 • Fever Zx 99-04 • K12 95-
00 • Kb 95-00 • Like 4T 09 • Super 8 07 • Super 8
4T 09 • Vitality 4T 04 People S 4T 06-08
(R.O. 00106010)



10 025 0640 

PIAGGIO 125-150 : Et4 99-01 • Liberty • Zip
• Skipper 4T 00>
(R.O. 830284)



10 025 0660 

PIAGGIO 150: Vespa GL Sprint
(R.O. 140920)



10 025 0670 

PIAGGIO 50: Vespa S • Vespa R • Vespa Pk • SS
125: Vespa Et3 Primavera
(R.O. 79734)





PIGNONI MESSA IN MOTO

STARTER PINION

10 025 4610



GILERA 50: Scooter 2/4 T
PIAGGIO 50: Scooter 2/4 T
125-150: Vespa Et4 >99
(R.O. 483537)



10 025 4620



PIAGGIO 125: Hexagon Lx4 98-99 • Zip 4T 00 ET4 97>
125-150: Skipper 4T 00 • Liberty 98-01 • Vespa Et4 10-99>
(R.O. 483539)



10 025 4630



GILERA 125: Runner • Fx • Fxr >98 Typhoon 95-98 • X 99-00
PIAGGIO 125-150: Hexagon Lx • Hexagon • Skipper 94-97
(R.O. 432491)



10 025 4640



GILERA 125: Typhoon Xr
125-180: Runner - Fx - Fxr 97-02
PIAGGIO 125-150: Skipper LX 98
180: Hexagon Lxt
(R.O. 483538)



10 025 4650



50: MINARELLI-MBK-YAMAHA



10 025 4660



PIAGGIO 50: Ape FL • FL2 89-95 • Ape FL3 Europa 96-99 • Ape Rst Mix 99-05 • Ape Tm P 85-89 • Vespa FL 90 • Vespa FL2 Automatica 90-91 • Vespa FL2 Hp 91-97 • Vespa N 89-90 Vespa Pk XL Plurimatic 85-90 • Vespa Pk XL Rush 99-89 • Vespa Px XL 85-88 •
50-125: Vespa Pk 82-84 • Vespa Pk S Automatica 84-89 • Vespa FL 89-90 • Vespa Pk XL 86-89 • Vespa Px 30 Anni 07-08 • Vespa Px Eu 2 01-07
125-150-200: Cosa 2 91-97 • Cosa CL-CLX 88-91 • Vespa Pxe Arcobaleno 91-97
(R.O. 248293)



10 025 4680



Dentatura: 14/65 • Sprockets: 14/65
KYMC0 50: Agility 2T R16 10 • 4T Carry 11 • 4T R10 06-08 • 4T R12 07-08 • 4T R16 08-09 • R12 05 • Rs Naked 2T 10 • Rs 09 • Dink 4T 07 • Filly Lx 01-02 • Like 4T 09 • People Eu2 11 • People S 4T 06-08 • Sento 08 • Super 8 4T 09 • Super 8 07 • Vitality 4T 04
(R.O. 00107245)



10 025 4710



Dentatura: 13/47 • Sprockets: 13/47
PIAGGIO 125: Hexagon Lx4 98-99 • Liberty 98-00 • Sfera 95-97 • Vespa Et4 96-98
(R.O. 293799)



10 025 4720



Dentatura: 14/47 • Sprockets: 14/47
APRILIA 100: Scarabeo 4T Net Eu3 10 • Scarabeo 4T Net 10 • Scarabeo 4T Restyling 06-09 • Scarabeo 4T 10-12
DERBI 50-100: Atlantis 4T 04-06
GILERA 125-180: Runner Fx-Fxr 97-02 • Typhoon X-Xr 99-00 • Typhoon 95-98
PIAGGIO 100: Fly 4T 06-08 • Free 02-03 • Zip 4T 06-10
125: Hexagon Lx-Lxt 98-99 • Hexagon 94-97 • Skipper Lx 98-99 • Skipper 94-97
(R.O. 431321)





10 025 4670



Dentatura: 14/63 - Sprockets: 14/63

APRILIA 50: Mojito 04-08 • Scarabeo 2T Eu2 Motore Piaggio 10-12 • Scarabeo 2T Net 09-10 • Scarabeo Street 2T Restyling 06-09 • Sport City One 2T 08-11 • Sr R Factory ie e Carburatore - *Carburetor* 10-12 • Sr R Factory 04-09
DERBI 50: Atlantis 2T Eu2 07-09 • Atlantis 2T 10 • Atlantis 02 Bullet 03-05 • Atlantis 02 City 03-06 • Atlantis 02 Red Bullet 03 • Atlantis 02 Two Chic 05 • Atlantis 02 02 • Boulevard 2T 09 • Gp1 Eu2 05 • Gp1 Open Eu2 06-09 • Gp1 Race Eu2 05-07 • Gp1 01-03 • Sonar 2T 09
GILERA 50: Dna Gp Experience 03-04 • Dna 00-07 • Easy Moving 95-96 • Ice 01-05 • Runner Poggiali 02 • Runner Sp Special Edition 07 • Runner Sp St & Simoncelli 08-09 • Runner Sp 02-07 • Runner 97-00 • Stalker Naked 08 • Stalker S. E. 07-08 • Stalker 97-11 • Storm Eu2 07 • Storm 94-95 • Typhoon X 98-99 • Typhoon Xr 00 • Typhoon 94-97 • Runner Sp 10-11
PIAGGIO 50: Diesis 01 • Fly 2T 05-11 • Free Delivery 01-01 • Free FL 95-02 • Free 92-94 • Liberty 2T Rst 04 • Liberty 2T Sport 06-08 • Liberty 2T 06-08 • Liberty Ptt Eu2 04-05 • Liberty 97-05 • Nrg Extreme 99-00 • Nrg Mc3 01-04 • Nrg power Dd Serie Speciale 07-11 • Nrg Power Dd 10 • Nrg Power Dt Serie Speciale 07-08 • Nrg Power Dt 06 • Nrg Rst Mc2 96-98 • Nrg 94-96 • Ntt 95-96 • Quartz 92-95 • Sfera Maquillage 2 94 • Sfera Rst 95-97 • Sfera 91-93 • Typhoon 2T E2 10-12 • Typhoon 2T E3 Ch 11 • Typhoon 01-09 • Vespa Et2 Iniezione 97-00 • Vespa Et2 97-05 • Vespa Lx 2T FL 09-10 • Vespa Lx 2T 05-08 • Vespa Lxv 2T Navy 08 • Vespa Lxv 2T 06-08 • Zip 2T 08-11 • Zip Bimodale 94-97 • Zip fast Raider Rst 96-97 • Zip Fast Raider 93-94 • Zip Rst 96-99 • Zip Sp Eu2 06-12 • Zip Sp 96-04 • Zip 92-94 • Liberty Moc 2T & Elle 09-11 • Nrg power Dt 07-11 • Vespa Lx 2T Touring 10-11 • Vespa S 2T & College 07-11
 (R.O. 82531R)



10 025 4700



Dentatura: 14/55 - Sprockets: 14/55

APRILIA 50: Rs 06-10 • Scarabeo 4T 4V Net 09-10 • Scarabeo 4T 4V 10 • Scarabeo 4T Restyling Eu 3 06-09 • Scarabeo Quattro 09 • Sport City One 4T 08-10 • Sr Factory ie e Carburatore - *Carburetor* 10-12 • Sr R - R Factory 04-09
DERBI 50: Atlantis 4T Eu 2 07 • Atlantis 50-100 4T 04-06 • Boulevard 4T Eu 2 25 Km/h 09 • Gpr 2T Eu2 09-10 • Gpr Nude & Gpr Nude Tuning 06-08 • Gpr nude Sport 06 • Gpr R Eu2 - Gpr Replica Eu2 08 • Gpr Racing Eu2 06 • Gpr Replica & Gpr R Eu2 06 • Gpr Replica 2T malossi 07 • Gpr Replica Pesek Eu2 07 • Senda R Drd Pro Eu 2 05-11 • Senda Sm Drd Pro Eu 2 05-11
GILERA 50: Runner Purejet St 08 • Runner Purejet 02-11
PIAGGIO 50: Fly 4T Motore Chn 06-07 • Fly 4T 05-11 • Liberty 4T Delivery Tnt 09 • Liberty 4T Delivery 10-11 • Liberty Ptt 09-11 • Liberty Rst 04 • Liberty 4T Sport 06-08 • Liberty 4t 00-08 • Liberty moc 4T & Elle 09-11 • Nrg Power Purejet 04-11 • Nrg purejet 02-10 • Vespa Et4 00-05 • Vespa Lx 4T-4V Touring 10-11 • Vespa Lx 4T-4V 09-11 • Vespa Lx 4T 05-08 • Vespa S 4T-4V & College 08-11 • Zip 4T 00-10
 (R.O. 96922R)



10 025 4730



Dentatura: 14/40 - Sprockets: 14/40

APRILIA 125: Atlantic Eu3 125-250 06-08 • Atlantic Eu3 10-11 • Mojito 03-08 • Sport >City Cube 08-10 • Sport City Eu3 06-08 • Sport City One Eu3 08-10 • Sport City 04-06
DERBI 125: Boulevard 125-150 Eu3 04-07 • Boulevard 125-150 02-04 • Gp1 Eu2 06 • Gp1 Low seat Eu3 07-08 • Rambla 125-250 E3 2 vers. 08 • Rambla 125-250 08-09 • Sonar 4T 09 • **150:** Boulevard 4T E3 10
200: Boulevard 05
GILERA 125: Dna 125-180 01 • Nexus Eu 3 07-08 • Runner Vx 4T Eu3 06-07 • Runner Vx 4T St Eu 3 08-11 • Runner Vx Race 06 • Runner Vx Sc 06-07 • Runner Vx-Vxr 125-180 00-01 • Runner Vx-Vxr 125-200 02-04 • Runner Vx 05-06
200: Runner Vxr 4T St Eu3 08-11 • Runner Vxr Eu3 07 • Runner Vxr Race 06 • Runner Vxr 05-06
PIAGGIO 125: Beverly Eu3 Mic 07 • Beverly Eu3 Sport 07-08 • Beverly Eu3 07-08 • Beverly Rst 04-07 • Beverly Tourer Eu3 08-10 • Beverly 01-03 • Carnaby 07-10 • Fly Eu3 07-11 • Fly 05-07 • Hexagon Gtx 00 • Liberty 4T Eu3 Delivery 08 • Liberty 4T Eu3 07-08 • Liberty 4T Sport Eu306-08 • Liberty 4T 06-07 • liberty Moc 4T & Elle 09-12 • Liberty Rst Ptt 05-11 • Liberty Rst 04-05 • Liberty Sport 06 • Liberty 01-02 • Mp3 07-08 • Skipper 4T 00-02 • Super Hexagon Gtx 12 01-02 • Typhoon 4T 2V E3 10-11 • Vespa Et4 99-02 • Vespa Gt Eu3 06-07 • Vespa Gt 03-07 • Vespa Gts Eu3 07-11 • Vespa Gtv 4T Navy Eu3 08 • Vespa Gtv 07-08 • Vespa Lx 4T Eu3 Touring 10-11 • Vespa Lx 4T FL 09 • Vespa Lx Eu3 le 09-10 • Vespa Lx Eu3 06-08 • Vespa Lx 05-06 • Vespa Lxv 4T Eu3 06-09 • Vespa S 4T le & College 09-11 • X Evo 07-11 V X7 Eu3 08 V X8 Premium Eu2-3 06-07 • X8 Street Eu2 06-07 • X8 04-06 • X9 Evolution Eu3 07 • X9 Evolution 03-06 • X9 01-02 • Zip 00-02 • Fly Eu3 08-11
150: Fly 05-07 • Liberty 4T Eu3 08 • Liberty 4T Sport Eu3 08 • Liberty Moc 4T 09-10 • Vespa Lx Eu3 ie 09-11 • Vespa Lx Eu3 06-08 • Vespa Lx Touring 10-11 • Vespa Lx 05-06 • Vespa S 4T ie & College 09-11 • Vespa S 4T 08-09 • X8 Street Eu2 06-08
180: X9 Amalfi 00-03
200: Carnaby 07-08 • Liberty 4T Eu3 07-08 • Liberty 4T Sport Eu3 06-07 • Liberty Rst 04 • Liberty Sport 06 • Liberty 06 • Vespa GT 06-07 • X8 05-07 • X9 Evolution 03 • X9 02-03
 (R.O. 82612R)



10 025 4740



KYMC0 50: Agility 4T Carry 11 • Agility 4T R12 07-08 • Agility 4T R16 08-12 • Agility R12 05 • Agility Rs 09 • Cx 93-97 • Dink 4T 07 • Dj 93-00 • Fever Zx 99-04 • K12 95-00 • Kb 95-00 • Like 4T 09 • Super 8 07 • Super 8 4T 09 • Vitality 4T 04
 (R.O. 00106109)





BOCCOLE MESSA IN MOTO

STARTER BUSHES

10 025 1000



50: MINARELLI - MBK - YAMAHA



10 025 1030



PIAGGIO 50: Sfera Maquillage 2 • Sfera Rst Quartz • Ntt • Nrg • Nrg Rst Mc2 • Free FL Zip E Zip • Zip Base • Zip Rst v Zip Fast Rider Zip SP • Vespa Et2
GILERA 50: Typhoon • Storm • Easy Moving Spessore 4 mm - *Thickness 4 mm* (R.O. 433862)



10 025 1050



PIAGGIO 50: Diesel 01 • Free Delivery 00-01 Fly 2T/4T • Liberty 2t RST • 4t RST 04 • Liberty 97-02 • 4T 00-02 • NRG Extreme 99-00 RST Mc2 96-98 • Mc3 01-02 • Purejet 02-04 Vespa Et2 97-01 • Et2 iniezione 97-00 • Et4 00-02 • Zip Rst 96-99 • Sp 01-04 • Euro 1 00-02 • 4T 00-04
PIAGGIO 100: Free 02-03
GILERA 50: Dna 00-02 • Dna GP Experience 03-04 • Ice 01 • Runner Poggiali • FL • Purejet 97-02 • Stalker 97-04 • Typhoon XR 00 Typhoon 01-04 (R.O. 479866)



10 025 1010



FORO INTERNO Ø 15 MM
INTERNAL HOLE Ø 15 MM
PIAGGIO 125: Vespa Et4 • Sfera Rst Liberty 98 • Hexagon Lx4 (R.O. 435027)



10 025 1020



FORO INTERNO Ø 17 MM
INTERNAL HOLE Ø 17 MM
PIAGGIO 125-150: Skipper 94-97 • Skipper Lx 98-99 • Hexagon Lx • Lxt 98-99 • Hexagon 94-97 • Vespa Et4 99-01
GILERA 125: Typhoon 95-98 • Typhoon X Xr 99-00 • Runner Fx
125-180: Fxr 97-00 (R.O. 478032)



10 025 1040



PER POMPA MIKUNI - FOR MIKUNI PUMP
PEUGEOT 50: Buxy 94-97 • Eliseo 99 Elystar TSDI 03 • Looxor 01-02 • TSDI 02 Metal X 02 • Speedake 95-97 • Speedfight aria • Kat acqua 97-99 • Squab 95-97 • Vivacity 99 • Kat 99-02 • Serie speciali 02 • Trekker 98-00 • Zenith L 94-96 • LN • LS-N 97-98 • X-Fight 00 • X race 03
100: Elyseo 99-01 • Looxor 01 • SVL 98 • Speedfight 97-00 • Trekker 98 • Vivacity 99-01 • X Fight 00-01



10 025 0393



INGRANAGGIO MESSA IN MOTO
Z12 Foro 20,5 mm
KICK STARTER GEAR - Z12 Hole 20,5 mm
PIAGGIO: Vespa Px 125-150-200 • T5 • Rally 200 VNX - VLX - VSX - VNX5T - VSE1 (R.O. 113526)



10 025 0403



INGRANAGGIO MESSA IN MOTO
Z12 Foro 21,8 mm
KICK STARTER GEAR - Z12 Hole 21,8 mm
PIAGGIO: Vespa Px 125-150 Sprint • Gtr • Super VNX - VLX - VSX - VLB (R.O. 089229)



10 025 0413



INGRANAGGIO MESSA IN MOTO
Z12-13 Foro 22 mm
KICK STARTER GEAR - Z12-13 Hole 22 mm
PIAGGIO: Vespa 125-150 Super 66-79 • P150 S VNB - VNT - VNS (R.O. 058680)





10 025 0423



NEW

12 193 0010



12 193 0020



INGRANAGGIO MESSA IN MOTO

Z12 Foro 22 mm

KICK STARTER GEAR - Z12 Hole 22 mm

PIAGGIO: Vespa 125-150'59-'61

(R.O. 890026)



MOLLA MESSA IN MOTO - STARTER SPRING

PIAGGIO - GILERA: Scooter 50

(Conf. 5 Pz. - 5 Pcs. Pack)

(R.O. 289495)



MOLLA MESSA IN MOTO - STARTER SPRING

MINARELLI - MBK - YAMAHA: Scooter 50

(Conf. 5 Pz. - 5 Pcs. Pack)

(R.O. 905083260900)



12 193 0030



12 193 0050



12 193 0060

MOLLA PIGNONE SCORREV. MESSA IN MOTO
STARTER PINION SPRING

MINARELLI - MBK - YAMAHA:

Scooter 50 - (Conf. 10 Pz. - 10 Pcs. Pack)

(R.O. 3VLE56730000)



MOLLA MESSA IN MOTO - STARTER SPRING

PIAGGIO: Vespa Px 125-150-200 -T5-Pxe 125-150-200 - VNX-VLX-VBX-VNX5T-VNX2-VLX2-VSX1-VLA-VLB-VBC

(Conf. 5 Pz. - 5 Pcs. Pack)

(R.O. 47218)



MOLLA MESSA IN MOTO - STARTER SPRING

PIAGGIO: Vespa 50-90-125 Primavera -Et3 V5A1-V5B1-V5B2-V5SA1-V9A1-VMA2-VMB1-VMX1T

(Conf. 5 Pz. - 5 Pcs. Pack)

(R.O. 78478)



12 193 0070



12 187 0060



MOLLA - SPRING

PIAGGIO: Vespa px 125-150-200 -t5-pxe

125-150-200-VNX-VLX-VBX-VNX5T-VNX2-VLX2-VSX1-VLA-VLB-VBC

(Conf. 5 Pz. - 5 Pcs. Pack)

(R.O. 139100)



BUSSOLA ALBERO MESSA IN MOTO

BUSH FOR STARTER SHAFT

50: MALAGUTI - MINARELLI - MBK - YAMAHA

(R.O. 903801524000)





PEDIVELLE AVVIAMENTO

KICK STARTER LEVERS

12 153 0010



BENELLI 50: 491 Gt 98-99 • Pepe 99-01 • K2-Lc 98-01
MALAGUTI 50: Centro Base 93-94 • Centro SL 94-98 • Ciak 99-00 • F10 Rst Eu1 Eu2 01-03 • F12 Phantom 94-98 • F15 Fire Fox 96-98 • Yesterday • Yesterday Euro 97-00
(R.O.08100903)

MBK 50: Booster Track 96-98 • Evolis 92-95 • Fizz 94-95 • Forte 94-96

YAMAHA 50: Bw'S Bump 97-98 • Axis 95-96 • Breeze 94-95

Nera - Black



12 153 0011



BENELLI 50: 491 Gt 98-99 • Pepe 99-01 • K2-Lc 98-01
MALAGUTI 50: Centro Base 93-94 • Centro SL 94-98 • Ciak 99-00 • F10 Rst Eu1 • Eu2 01-03 • F12 Phantom 94-98 • F15 Fire Fox 96-98 • Yesterday • Yesterday Euro 97-00
(R.O.08100903)

MBK 50: Booster Track 96-98 • Evolis 92-95 • Fizz 94-95 • Forte 94-96

YAMAHA 50: Bw'S Bump 97-98 • Axis 95-96 • Breeze 94-95

Cromato - Chrome plated



12 153 0020



MBK 50: Booster Rocket 97-98 • Booster Spirit 96-98 • Booster Ng 95-98 • Nitro 97-98

YAMAHA 50: Bw'S Next Generation 97-98 • Bw'S Original 97-98 • Spy 95-98 • Aerox 97-98
(R.O.3VLE56200100)

Nera - Black



12 153 0021



MBK 50: Booster Rocket 97-98 • Booster Spirit 96-98 • Booster Ng 95-98 • Nitro 97-98

YAMAHA 50: Bw'S Next Generation 97-98 • Bw'S Original 97-98 • Spy 95-98 • Aerox 97-98
(R.O.3VLE56200100)

Cromato - Chrome plated



12 153 0030



PEUGEOT 50: Buxy 94-97 • Speedake 95-97 • Speedfight Ac-Lc 97-98 • Sv Geo 91-95 • Zenith L 94-96

100: Elyseo 99-01 • Speedfight 97-00 • Sv L 98 • Vivacity 99-01 • X-Fight 00-01
(R.O.723494)

Nera - Black



12 153 0040



DERBI 50: Atlantis 02 • Boulevard 2T-4T 09 • Gp1 01-03

GILERA 50: Dna 00-07 • Easy Moving 95-96 • Ice 01-05 • Runner 97-00 • Stalker 97-09 • Storm Eu2 07 • Typhoon 94-97 (R.O.286214)

125: Runner Fx-Fxr 97-02 • Typhoon 95-98

PIAGGIO 50: Diesis 01 • Fly 2T-4T 05-07 • Free 92-94 • Liberty 97-05 • Liberty 4T 00-08 • Nrg 94-96 • Quartz 92-96 • Sfera 91-93 • Typhoon 01-09 • Zip 92-04

100: Fly 4T 06-08 • Free 02-03 • Zip 4T 06-08

125: Skipper 94-97
(R.O.286214)

Nera - Black



12 153 0041



DERBI 50: Atlantis 02 • Boulevard 2T-4T 09 • Gp1 01-03

GILERA 50: Dna 00-07 • Easy Moving 95-96 • Ice 01-05 • Runner 97-00 • Stalker 97-09

• Storm Eu2 07 • Typhoon 94-97
(R.O.286214)

125: Runner Fx-Fxr 97-02 • Typhoon 95-98

PIAGGIO 50: Diesis 01 • Fly 2T-4T 05-07

• Free 92-94 • Liberty 97-05 • Liberty 4T 00-08 • Nrg 94-96 • Quartz 92-96 • Sfera 91-93

• Typhoon 01-09 • Zip 92-04

100: Fly 4T 06-08 • Free 02-03 • Zip 4T 06-08

125: Skipper 94-97
(R.O.286214)

Cromato - Chrome plated



12 153 0050



PIAGGIO: Vespa 50-90-125 • 125 Primavera • ET3 V5A1-V5B1-V5SA1-V9A1-VMA2

(R.O. 079077)

Alluminio - Aluminium



12 153 0060



PIAGGIO: Vespa 50-125 Pk - Rush - N - Pk XL 125 V5X1T-VMX1T-VMX5T-V5X5-V5X4

(R.O. 2161415)

Alluminio - Aluminium



PEDIVELLE AVVIAMENTO
KICK STARTER LEVERS



12 153 0080 

PIAGGIO 50: Vespa Et2 97-05 • Vespa Et2 Iniezione 97-00 • Vespa Et4 00-05 • Vespa Lx 2T 05-08 • Vespa S 4T-4V 08-09 (R.O.969421)
Alluminio - Aluminium



12 153 0090 

PIAGGIO 125: Vespa Et4 (R.O. 479133)
Alluminio - Aluminium



12 153 0100 

APRILIA 50: Gulliver 95-98 • Rally 95-03 • Area 51 98-00 • Gulliver Lc 96-98 • Rally Lc 96-99 • Scarabeo 93-05 • Sonic 98-07 • Sr 94-96 • Sr Lc 94-96 (R.O.AP8235073)
Alluminio - Aluminium



12 153 0170 

PIAGGIO: Vespa 150 GL • Sprint • Super Sprint Veloce VLB-VLA-VBC (R.O. 174310)
Alluminio - Aluminium



12 153 0180 

PIAGGIO: Vespa 125-150 59 VNB1/2-VBB-VBA1T (R.O. 083986)
Alluminio - Aluminium



12 153 0200 

LEVA AVVIAMENTO - STARTER LEVER
PIAGGIO: VESPA Px 125-150 • Pe 200 • Pxe Arcobaleno • Cosa 125-150-200 • Vnx-VLX-Vbx-Vnx2-VLX2-Vsx1-VLR1T-VLR-Vsr1 (R.O. 1743125)

NEW



12 153 0223 

INNOCENTI: Lambretta Li 3° Serie
Alluminio - Aluminium

NEW

12 183 0080 

GOMMINO LEVA MESSA IN MOTO
KICKSTART RUBBER
PIAGGIO: Vespa tutti i tipi - *All models* (R.O. 241004)

12 183 0900 

GOMMINO LEVA AVVIAMENTO
KICK STARTER LEVER RUBBER
PIAGGIO: Vespa 150 VBB (R.O. 49642)

NEW





RUOTE LIBERE AVVIAMENTO

STARTER WHEELS

APRILIA

10 030 0300



125: Atlantic 03-05 • Scarabeo 04-06 • Sport City 06-08 • **250:** Sport City Cube 08-12
300: Sport City Street 12 • Atlantic 10-11 • Scarabeo Light 09-10 • Sr Max 11-14 • **400:** Atlantic Sprint 05-08 • Scarabeo Light 06-08 •
500: Atlantic 01-04 • Scarabeo 03-06
(R.O. 8494905)



10 030 0400



125: SR Max 11-14 • Sport City 06-08 • Atlantic 06-08
250: Atlantic Eu3 06-08 • Sport City Cube 08-12 • Scarabeo Light 06-08
(R.O. 8477975)



DERBI

10 030 0400



125: Rambla 08-09
250: GP1 Low Seat Eu3 07-08 • Rambla 08-09 •
(R.O. 8477975)



10 030 0300



300: Rambla 10-11
(R.O. 8494905)



GILERA

10 030 0400



125: Nexus Eu3 ie 08-10
250: Nexus Eu3 06-07 • Nexus SP Eu3 06-07
(R.O. 8477975)



10 030 0300



250: Oregon 06-10
300: Nexus Eu 3 08-11
500: Fuoco Eu3 07-14 • Nexus 06-11
(R.O. 8494905)



HONDA

10 030 0260



125: Pantheon Fes 04-05 • Silver Wing Fes 07-12 • Pes 06-08 • Sh 05-12
150: Pantheon Fes 03-05 • Sh 05-12
(R.O. 31110-KRJ-901)



10 030 0290



250: Foresight 98-02 • Foresight 05
(R.O. 31110-KFG-008)





KYMCO

10 030 0260 

125: G-Dink 12
200: Dink Eu3 i 06-07 • Downtown 10 • People Gti 10-14
250: People S-Si 06-07 • X Citing i 05-07 •
300: Downtown 09-11 • G-Dink 12 • K-Xct 12-14 • Maxxer 05-06 • Mxu 05-10 • People Gti 10-14 • People Si 08 • X-Citing 08-09
350: Downtown 15-16
(R.O. 0126013)



10 030 0280 

125: Agility Carry 11 • Agility plus 14-16 • Agility R16 08-12 • Agility Rs 09 • Heroism 95-97 • Like 09-12 • Mxer 02-03 • People One 13-16 • Agility 4T 06-08 • Movie 99-04 • People 99-11 • People S 05-08 • Super 8 08-09 • Vivio 00 • Zing 97-98
150: Agility R16 08-09 • Heroism 95-97 • Vivio 00 • Zing 97-98 • Mxer 04 • Mxu 05-06
200: Agility R16 10-12 • Agility Plus 14-16 • Like 09-12 • People S 05-07
(R.O. 00128248 • 00128742)



10 030 0290 

200: Dink Classic 04 • Dink Eu 3 i 06-07 (71001292>)
250: Bew/Eu2 00-03 • Grand Dink Eu2 01-04 • KXR 03-04 • MXU 05 • People Lc 03-04 • Yup 03
300: Maxxer 05-06 (Vin 61100480 >) • Mxu 05-06 (>61000532)
(R.O. 00128935)



MBK

10 030 0010 

50: Cs Mack G 02-04 • Cw Booster 90-95 • Cw Booster Naked 03 • Cw Booster Spirit 99-03 • Cw L Booster 01-03 • Cw Rs Booster Ng 99-03 • Cw Booster Rocket 97-98 • Cw Booster Track 96-02 • Ew Stunt 00-02 • Ya R Forte 94-96 • Ye Evolis 92-95 • Yh Flipper 99-04 • Ym Fizz 94-95 • Yn R Ovetto 02-04 • Yq Nitro 97-04
(R.O. 3VL155700000)



10 030 0230 

125: Flame • Flame R 95-99 • Doodo 00-01 • Thunder 01-02 • Skyliner 98-02
150: Doodo 01-02 • Thunder 01-02 • Skyliner 00-02
(R.O. 5NSE55700000)



10 030 0390 

125-180: Skyliner 03
(R.O. 5XME55700000)



10 030 0270 

250: Skyliner 00-03 • Abs 03
300: Kilibre 03
(R.O. 4HC155900200)





RUOTE LIBERE AVVIAMENTO

STARTER WHEELS

PIAGGIO

10 030 0190 

Ciao
Ruota Libera Z 18 - *Freewheel Z 18*
(R.O. 103631)

10 030 0200 

Bravo • SI
Ruota Libera Z 16 - *Freewheel Z 16*
(R.O. 114531)

10 030 0400 

125: Beverly Rst 4T 4V 10-15 • Mp3 08-12 •
Vespa Gts 09-16 • X7 Evo 09-10
250: Beverly Cruiser 07-09 • Beverly Tourer
07-09 • Beverly 06-08 • Carnaby 08 • Mp3 06-09
• Vespa Gts 05-16 • Vespa Gtv 06-09 • X Evo 07-
16 • X7 08 • X8 05-08
(R.O. 8477975)

10 030 0300 

250: Beverly Rst 04-05 • Vespa Gts 05-12 • X9
06 • **300:** Beverly Rst 4T 4V 10-15 • Beverly
Tourer 09-10 • Carnaby Cruiser 09-12 • Mp3
10-14 • Vespa Gts 08-16 • Vespa Gtv 10-13 • X7
Evo 09-10 • **350:** Beverly 4T 4V 11-14 • X10 4T
4V 12-15 • **400:** Beverly 06-10 • Mp3 07-11 •
X Evo 07-11 • X8 06-08 • **500:** Beverly 02-12 •
Mp3 11-16 • X10 4T 4V 12-14 • X9 01-02 • X9
Evolution 03-05
(R.O. 8494905)



SUZUKI

10 030 0330 

125: Epicuro 99-01 • Burgman 02-06 • Sixteen
08-11 • **150:** Epicuro 99-01 • Burgman 02-06
• Sixteen 08-11

10 030 0290 

200: Burgman 07-14
250: Burgman 98-06

10 030 0370 

400: Burgman X-K6 99-06



10 030 0380 

400: Burgman 07-15





YAMAHA

10 030 0010 

50: Bw's Bump 97-98 • Bw's Naked 03-16 • Bw's Next Generation 97-06 • Bw's Original 97-02 • Bw's 04-16 • Cs Jog R 02-15 • Cw Bw's 95-04 • Ns Aerox 13-16 • Yh Why 99-06 • Yn Neo's 97-16 • Yq Aerox 97-12



10 030 0230 

125: Beluga 90-95 • Cygnus 95-98 • Teo's 00 • Maxster 01-02 • Majesty 98-02
150: Flyone 90-95 • Teo's 01-02 • Maxster 01-02 • Majesty 00-02
(R.O. 5NSE55700000)



10 030 0250 

125: Yp X • City 08-11 • Yp R X Max 06-16
(R.O. 1B9E55800000)



10 030 0390 

125: Majesty 03-09
180: Majesty 03-06
(R.O. 5XME55700000)



10 030 0270 

250: X City 07-15 • Majesty 96-03 • Yp R X Max 07-16
300: Versity 03-06
(R.O. 4HC155900200)



10 030 0310 

400: Majesty 04-11 • Yp R X Max 13-16
(R.O. 5RU155900000)



10 030 0320 

500: Xp T Max 01-11 • **530:** Xp T Max 12-14
1200: Xtz Super Tenere 10-11
1300: Fjr A Abs 06-11 • Fjr A 03-05 • Fjr As 06-08 • Fjr 01-04 • Xvs A Midnight Star 07-08 • Xvz Royal Star 96-00 • Xvz Tf Royal Star Venture 00
1700: V Max 09-10
(R.O. 5NK155900000)





KIT RUOTE LIBERE AVVIAMENTO CON INGRANAGGIO

STARTER WHEELS AND GEAR KITS

KYMCO

10 031 0010 

125: Agility 4T Eu3 06-08 • Agility 4T 06 • Movie Eu3 06-07

125-150: Movie XL Eu2 03-04 • Movie XL 01 • Movie 99-00 • People Eu2 03 • People 99-00 • People Eu3 07-11 • People S DD Eu3 07-08 • People S 05 • Super 8 08-09 • Vivio 00

150: Movie Eu3 06-07

Mixer Eu2 04

Mxu 05-06

200:

People Si 07

People S 05

(R.O. 00128792)

(R.O. 0128730)

(R.O. 0128728)



10 031 0020 

250: B&w Eu2 03 • B&w 00 • Grand Dink Eu2 03-04 • Grand Dink 01-02 • Kxr 03-04 • Mxu 05 •

People Lc 03-04 • Yup 03

300: Maxxer Vin 61100480 > 05-06

MXU > 6100052 05-06

(R.O. 00128935 • 00128933)



MBK

10 031 0120 

125: Xc Flame F 00 • Xck Flame R 96-99 • Xct Flame 95-99

(R.O. 5NSE55700000 • 4CWE55240100)



10 031 0070 

250: X City 07-15 • Majesty 96-03

• Yp R X Max 07-16

300: Versity 03-06

(R.O. 4HC155900200 • 4HC155170000)



SUZUKI

10 031 0040 

125-150: Sixteen 08-11

(R.O. 12649-20E02-00 • 12601-20841-000)



10 031 0060 

400: Burgman 99-06

(R.O. 12600-15824-000)





YAMAHA

10 031 0100



125: Vp X City 08-11 • Yp R X Max 06-16
(R.O. 1B9E55800000 • 5YPE55240000)



10 031 0110



125: Nxc Cygnus X 04-11
(R.O. 5TYE55240000 • 5TYE55700100)



10 031 0120



125: Xc Cygnus R 99-03 • Xck Cygnus R 97-03
Xct Cygnus 95-98
(R.O. 4CVE552400100 • 4CVE55700000)



10 031 0070



250: X City 07-11 • Majesty 96-03 • Dx 98-99 •
Abs 03 • Black X Max 09 • X Max 05-11 • X Max
Abs/Sport 11 - **300:** Versity 03-06
(R.O. 4HC155900200 • 1COE55170000)



10 031 0090



500: Xp T Max 01-11 • **530:** Xp T Max 12-16
(R.O. 5NK155900000 • 5GJ155170000)





FRIZIONI - TRASMISSIONI PRIMARIE

CLUTCHES - PRIMARY DRIVES

12 191 0060



SET 6 MOLLE FRIZIONE
6 CLUTCH SPRINGS SET
YAMAHA 500: T-Max 01-07
(R.O. 5GJ1653910)



12 191 0070



SET 6 MOLLE FRIZIONE
6 CLUTCH SPRINGS SET
YAMAHA: T-Max 08-11
(R.O. 4B51653900)



12 191 0080



SET 6 MOLLE FRIZIONE
6 CLUTCH SPRINGS SET
YAMAHA 530: T-Max 12-14
(R.O. 59C1653900)



12 195 0120



MOLLA FRIZIONE - CLUTCH SPRING
PIAGGIO 50-90-125: Vespa Primavera • Et3
V5A1-V5B1-V5B2-V9A1-VMA2-VMB1-VMX1T
(R.O. 112390)



12 195 0140



MOLLA FRIZIONE - CLUTCH SPRING
PIAGGIO 125-150-200: Vespa Px -T5-Pxe-Cosa
VNX-VLX-VBX-VNX5T-VNX2-VLX2-VSX1-VLA-
VLB-VBC-VNR-VLR-VSR
(R.O. 022821)



10 030 0070



DISCO INTERNO FRIZIONE
CLUTCH INTERNAL DISC
PIAGGIO: Vespa Px 125 E • Px 150 E
(R.O. 094425)



10 028 0100



SERIE 11 DISCHI FRIZIONE
11 CLUTCH DISCS SET
YAMAHA 500: T-Max 01-11



10 028 0110



SERIE 13 DISCHI FRIZIONE - 13 CLUTCH DISCS SET
YAMAHA 530: T Max 12-14



10 030 0050



KIT PARASTRAPPI TRASMISSIONE PRIMARIA
PRIMARY DRIVE KIT
PIAGGIO: Vespa Px 125 • Px 150
(R.O. 077370-077371- 078853)



10 030 0060



KIT PARASTRAPPI TRASMISSIONE PRIMARIA
PRIMARY DRIVE KIT
PIAGGIO: Vespa Px 200 E
(R.O. 077370-077371-078853-077372)



10 030 0080



KIT PARASTRAPPI TRASMISSIONE PRIMARIA
PRIMARY DRIVE KIT
PIAGGIO 50: Vespa • Vespa Pk
90: Vespa • **125:** Vespa Primavera • Pk
V5A1-V5B1-V5B2-V9A1-VMA2-VMB1-V5X1T-VMX1T
(R.O. 154625)





10 024 0130 

COPPIA INGRANAGGI TRASMISSIONE PRIMARIA DENTI ELICOIDALI (Z 22-63)
PRIMARY DRIVE GEARS HELICOIDAL TEETH (Z 22-63)

PIAGGIO: Vespa 50-90 - 50 Pk

10 024 0140 

COPPIA INGRANAGGI TRASMISSIONE PRIMARIA DENTI ELICOIDALI (Z 24-61)
PRIMARY DRIVE GEARS HELICOIDAL TEETH (Z 24-61)

PIAGGIO: Vespa 50-90 • Et3 • 125 Pk

10 024 0150 

COPPIA INGRANAGGI TRASMISSIONE PRIMARIA DENTI DRITTI (Z 24-72)
PRIMARY DRIVE GEARS STRAIGHT TEETH (Z 24-72)

PIAGGIO: Vespa 50-90 • 50 Pk

10 024 0160 

COPPIA INGRANAGGI TRASMISSIONE PRIMARIA DENTI DRITTI (Z 27-69)
PRIMARY DRIVE GEARS STRAIGHT TEETH (Z 27-69)

PIAGGIO: Vespa 125 • ET3 • 125 PK

10 024 0170 

COPPIA INGRANAGGI TRASMISSIONE PRIMARIA DENTI ELICOIDALI (Z 18-67) SENZA PARASTRAPPI
PRIMARY DRIVE GEARS HELICOIDAL TEETH (Z 18-67) WITHOUT SHOCK ABSORBER SPRINGS

PIAGGIO: Vespa 50 denti elicoidali Z 18-67

10 026 0130 

CAMPANA FRIZIONE - CLUTCH BOX

PIAGGIO: Vespa Px 125 E • Px 150 E • 150 Sprint-150 GL • (R.O. 059369)

10 026 0140 

CAMPANA FRIZIONE - CLUTCH BOX

PIAGGIO: Cosa CL-CLX 150-200 88-91
Vespa Px T5 125 85-89
Vespa PxeArcobaleno 200 81-97 • Rally 200
(R.O. 2458295)

10 026 0100 

MOZZETTO FRIZIONE

CLUTCH SPIDER
PIAGGIO: Vespa 50-90-125 Pk • Ape 50 Tm • P
(R.O. 2/79497)

10 026 0230 

Tipo originale - *Original Type*

Trattamento ad Induzione - *Induction Treatment*



10 026 0240 

Tipo originale - *Original Type*

Trattamento ad Induzione - *Induction Treatment*



10 026 0253 

BOCCOLA FRIZIONE - CLUTCH BUSH

PIAGGIO 200: Vespa Pe - Rally - Cosa
(R.O. 159853)

10 030 0483 

LEVA ESTERNA FRIZIONE

EXTERNAL CLUTCH LEVER
PIAGGIO: Vespa Px 125-150 • Cosa 125 • Vn1-
Vn2-Vna-Vnb-Vnx2-VLX1-Vsx1
(R.O. 0979844)

10 030 0493 

COPERCHIO FRIZIONE - COVER

PIAGGIO: Vespa Px 125-150 • Cosa 125 • Vn1-
Vn2-Vna-Vnb-Vnx2-VLX1-Vsx1
(R.O. 50100)

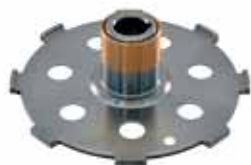



FRIZIONI - TRASMISSIONI PRIMARIE
CLUTCHES - PRIMARY DRIVES

10 030 0430



RALLINO FRIZIONE - PUSH ROAD CLUTCH
PIAGGIO: Vespa 50
(R.O. 078453)



10 030 0440



RALLINO FRIZIONE - PUSH ROAD CLUTCH
PIAGGIO: Vespa Primavera 125
(R.O. 165019)



10 030 0460



RALLINO FRIZIONE - PUSH ROAD CLUTCH
PIAGGIO: Vespa Px-Gl-Sprint-Super
Vla-Vlb-Vbc-Vnx-Vlx-Vbx
(R.O. 089858)



10 030 0040



PIATTELLO CON MOLLA RALLINO FRIZIONE
ACTUATING PLATE FOR CLUTCH
PIAGGIO: Ape Mp
(R.O. 131899 - 110957 - 131900)

10 030 0180



PIAGGIO: Vespa 50 Sp./Et3 • Pk • Pk XL • Rush
(R.O. 016821 - 014457 - 165019)



10 030 0161



PIATTELLO CON MOLLA RALLINO FRIZIONE
ACTUATING PLATE FOR CLUTCH
PIAGGIO: Vespa Px 125 • Px 150 • GL Sprint
Super • Vnx • Vlx • Vlb • VLa • Vbc
(R.O. 016821 - 014457 - 2/89858)



10 030 0171



PIATTELLO CON MOLLA RALLINO FRIZIONE
ACTUATING PLATE FOR CLUTCH
PIAGGIO: Vespa Pe 200 • Vsx • Vsx2
Made in Taiwan
(R.O. 025026 - 014457 - 2/89858)



10 036 0260



SERIE MASSETTE FRIZIONE AVVIAMENTO
STARTER CLUTCH SET WITH AUTOMATIC SPEED
(3 pz - 3 Pcs).
PIAGGIO: Ciao • Bravo • Si • Superbravo • Grillo
s/variatore - *Without variator*
(R.O. 249813)



10 026 0120



CAMPANA INTERNA
INTERNAL DRUM CLUTCH
PIAGGIO: Ciao • Si
(R.O. 2/114943)



10 030 0450



LEVETTA FRIZIONE - CLUTCH LEVER
PIAGGIO: Vespa GL • Px
(R.O. 083806)



12 189 0070



MOLLA FRIZIONE MASSETTE AVVIAMENTO
STARTER SET SPRING
PIAGGIO: Ciao • Si • Grillo • Bravo 2
Conf. 50 Pcs. - 50 Pcs bag
(R.O. 121753)



12 195 0130



MOLLA MASSETTE FRIZIONE
CLUTCH SPRING
PIAGGIO: Ciao • Si • Grillo • Bravo 2
Conf. 50 Pcs. - 50 Pcs bag
(R.O. 121537)





10 022 0020 

CROCERA INNESTO MARCE
GEAR SELECTOR

PIAGGIO 50: Pk XL 85-88 • Ape FL • FL2 85-95
Ape FL • FL2 85-95 • Ape FL3 Europa 96-98
50-90: FL • 50 (91-97)-FL 125 89
50-125: Vespa 67-96 • Pk 82-84
(R.O. 134902)



10 022 0100 

CROCERA INNESTO MARCE MM 5,5
GEAR SELECTOR MM 5,5

PIAGGIO 150: Vespa Px
Pe Serie Arcobaleno
Sprint
(R.O. 130939)



10 022 0110 

CROCERA INNESTO 4 MARCE
SELECTOR 4 GEARS

PIAGGIO 50-250: Ape 74-78
50: Vespa 50 Special
90: SS
125: Primavera Et3
(R.O. 111589)



10 022 0120 

CROCERA INNESTO 3 MARCE
SELECTOR 3 GEARS

PIAGGIO 50-90: Vespa 78-80
(R.O. 165304)



10 024 0060 

INGRANAGGIO INVERTITORE
INVERTER GEAR
Z 20 / 12 - ASSE-AXLE Ø 20 / 22
PIAGGIO: Ape car P2-P3 (78-85)
Ape Mp P501-P601 (78-96)
Ape Tm P602 (82-83)
(R.O. 169744)



10 024 0080 

INGRANAGGIO SCORREVOLE Z 21
SLIDING GEAR Z 21
PIAGGIO: Ape car P2/P3 (78-85)
Ape Mp P501-P601 (78-96)
• Ape Tm P602 (82-83)
(R.O. 118909)





PRESELETTORI CAMBIO

GEAR BOX SELECTOR

10 022 1000 

PRESELETTORE CAMBIO

GEAR BOX SELECTOR

PIAGGIO 150: Vespa GL • Sprint

VLA•VLB • VLC

(R.O. 092167)



10 022 1010 

PRESELETTORE CAMBIO

GEAR BOX SELECTOR

PIAGGIO 125: Vespa Px

150: Vespa Px • Vespa Ps

200: Vespa Px

VNX•VLX•VSX•VBX1T

(R.O. 138880)



10 022 1020 

PRESELETTORE CAMBIO CON SPIA A FOLLE

GEAR BOX SELECTOR WITH NEUTRAL INDICATOR

PIAGGIO 125: Vespa Px • Cosa

150: Vespa Px • Cosa

200: Vespa Px Arcobaleno • Cosa

VNX2T•VLX1T•VXS1T•VNR1T

(R.O. 199803)



10 022 1030 

PRESELETTORE CAMBIO

GEAR BOX SELECTOR

PIAGGIO 125-150-200: Vespa Px

VNX2T•VLX1T•VXS1T

(R.O. 196585)



14 258 0113 

COPRISELETTORE CROMATO

GEAR BOX CHROMED COVER

PIAGGIO: Vespa Px • Pe

VNX • VLX • VSX • VNX2 • VLX2 • VSX2





12 183 0160 

12 183 0163 

GIUNTO ELASTICO - COUPLING

Ape Car P2-P3 78-85 • Car Max Diesel 86-96
Tmp 703 • P703V 84-99 • Tmp703
P703V Diesel 87-98
(R.O.228302)

12 183 0250 

GIUNTO ELASTICO - COUPLING

Poker benzina Diesel 93-97
Porter Quargo 05
Fori fissaggio ø 12 - *Fixing holes ø 12*
(R.O. 268253)

12 183 0170 

GIUNTO ELASTICO - COUPLING

PIAGGIO 420: Ape Poker Benzina 93
Fori fissaggio ø 10 - *Fixing holes ø 10*
(R.O 226345)

12 183 0180 

CUFFIA TENUTA OLIO SEMIASSE APE P 50
SHAFT PROTECTION

50: FL • FL 2 89-95 • 50 FL3 Europa 96-98
Rst Mix 50 99
(R.O.119989)



12 183 0190 

CUFFIA TENUTA OLIO SEMIASSE APE MP-CAR
SHAFT PROTECTION

Car P2-P3 78-85 • Mp P501 • P601 78-96
Tm P602 82-83 • Tmp 703P 703V 84-99
(R.O.198618)





KIT ALBERO RUOTA POSTERIORE

REAR WHEEL SHAFT KIT

10 024 0090



KIT ALBERO RUOTA POSTERIORE

REAR WHEEL SHAFT KIT

GILERA 50: Easy Moving • Storm • Typhoon

PIAGGIO 50: Free • Free FL • Nrg Rst • Ntt • Quartz 50 • Sfera • Sfera Rst • Sfera Maquillage 2 • Zip • Zip 95 • Zip Fast Rider • Zip e Zip Nrg Rst Mc2 96-97q

80: Skr City • Sfera

(Albero R.O. 478155 - Scodellino R.O. 194423)
(Dado R.O. 194424 - Copiglia R.O. 012789)

10 024 0110



KIT ALBERO RUOTA POSTERIORE

REAR WHEEL SHAFT KIT

GILERA 50: Runner Runner D. Disco 97-00

Stalker • Stalker Doppio Disco 97-00

PIAGGIO 50: Liberty • Vespa Et2 • Vespa Et2 Iniez. • Zip Fast Rider Rst • Zip Freno a Disco Rst

Zip Rst • Zip Sp • Nrg RST Mc2 98

(Albero R.O. 480053 - Scodellino R.O. 194423)
(Dado R.O. 194424 - Copiglia R.O. 012789)



10 024 0050



ALBERO RUOTA POSTERIORE - REAR WHEEL AXLE

(Senza Ingranaggio - Without gear)

SCOOTER 50:

MOTORI MINARELLI • YAMAHA • APRILIA

MALAGUTI • MBK

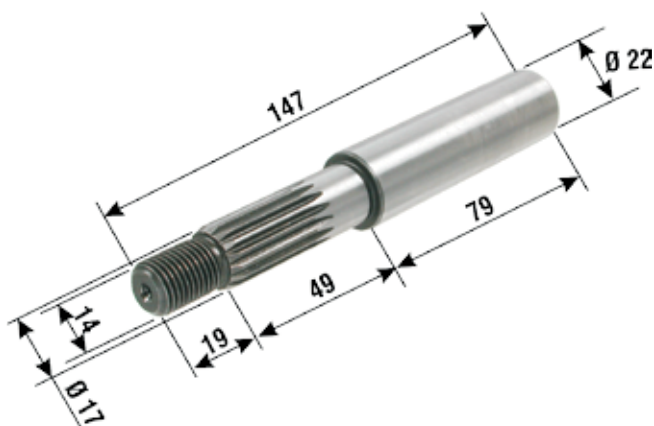

10 024 0120



ALBERO SECONDARIO - DRIVEN SHAFT

PIAGGIO 125-150-200: Vespa Px E

Px T5 - Cosa 1 - Cosa 2

(R.O. 235908)

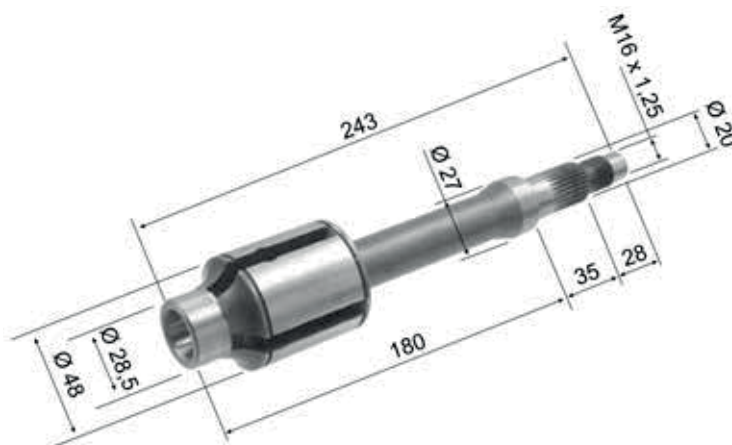

10 024 0193



ALBERO SECONDARIO - DRIVEN SHAFT

PIAGGIO 125-150-200: Vespa Px 81-97 • GL Sprint Super Rally 200

VNX - VLX - VSX - VLB1T - VNC1T - VNL1T - VSE1T

(R.O. 157800)





12 183 0060 

TAMPONE AMMORTIZZATORE
SHOCK ABSORBER RUBBER BUFFER

Vespa 50-125-Et3 • 50 Pk-125 Pk • Px • Pe
(R.O. 060536)



12 183 0130 

SUPPORTO ELASTICO X MARMITTA
RUBBER MUFFLER BRACKET

Ape 50 • FL2 • FL3 Eu • P
• Rst Mix Tmp
(R.O. 127350)



12 183 0200 

SUPPORTO ELASTICO MOTORE POST. APE
REAR RUBBER ENGINE MOUNTING

Mp Car-Car P2 • P3 78-85
Mp P501 • P601 78-96
(R.O.105976)



12 183 0270 

SUPPORTO MOTORE ANTIVIBRANTE
ENGINE MOUNT SILENTBLOCK

Vespa Primavera 50-90
(R.O. 112204)



12 183 0283 

SUPPORTO MOTORE ANTIVIBRANTE
ENGINE MOUNT SILENTBLOCK

Vespa Pe 200
(R.O. 174724)



12 183 0873 

NEW

COPPIA SILENTBLOCK
SILENTBLOCK

PIAGGIO 50-90: Vespa 50-90 • V5a1-V5b1.
V5sa1-V9a1-Vma2



12 183 0380 

TAMPONE DI SCONTRO
BUFFER

Vespa 50-90 • Primavera Et3
V5A1-V5B1-V5B2-V5SA1-V9A1-VMA2-VMB1
(R.O. 078578)



12 183 0390 

TAMPONE DI SCONTRO
BUFFER

Vespa Pk 50-125
V5X1T-V5X5T-V5S1T-VMX1T-VMX5T
(R.O. 165206)



12 183 0400 

TAMPONE DI SCONTRO
BUFFER

Vespa Px125-150 • P200E
VNX-VLX-VBX -T5 VNX5T
Vespa Pxe 125-150-200
VNX2-VLX2-VSX1
Vespa 150 GL • Sprint • Super
VLA-VLB-VBC
(R.O. 178338)



12 183 0510 

TAMPONE MOTORE
ENGINE BUFFER

Vespa Px 125-150
VNX1T-VLX1T
(R.O. 059589)



12 183 0520 

TAMPONE MOTORE
ENGINE BUFFER

Vespa Px 125-150
VNX1T-VLX1T
(R.O. 059588)





PARTICOLARI GOMMA MOTORE PIAGGIO

PIAGGIO RUBBER ENGINE PARTS

12 183 0640



SILENTBLOCK SUPPORTO MOTORE ENGINE MOUNT SILENTBLOCK

Motori Piaggio: 50-125-150-200-250-300
For Piaggio Engines: 50-125-150-200-250-300
(R.O. 272750)



12 183 0760



SILENTBLOCK SUPPORTO MOTORE ENGINE MOUNT SILENTBLOCK

KYMCO 250: People Lc 03-04 • People S I 250
07-07 • People S 06-06 • X Citing I 06-07 • X Citing
05-05 • Yup 03-03
300: G-Dink 12-12 • People S I 08-08 • X Citing I R
08-08 • X Citing I R 09-09 • X Citing I 08-08
400: X Citing I Abs 14-14 • X Citing I Abs 15-15 • X
Citing I 13-13 • X Citing I 15-15
(R.O. 00121020)



12 183 0770



SILENTBLOCK SUPPORTO MOTORE ENGINE MOUNT SILENTBLOCK

KYMCO 125: Downtown I 09 • K-Xct I 12-14 •
People Gti 10
200: Downtown I 10 • People Gti 10 • People Gti 14
250: B&w Eu2 03 • B&w 250 00 • Grand Dink Eu2
03-04 • Grand Dink 01-02
300: Downtown I 09 • Downtown Abs I 10-11 •
Downtown I 11 • G-Dink 12 • K-Xct I Abs 14 • K-
Xct I 12 • People Gti Abs 12-14 • People Gti 10-14
350: Downtown I Abs 15
(R.O. 00169989)



12 183 0740



SILENTBLOCK SUPPORTO MOTORE ENGINE MOUNT SILENTBLOCK

KYMCO 50: Agility 2TR16 10-12 • Agility 4T Carry 11
Agility 4T R10 06-08 • Agility 4T R12 07-08
Agility 4T R16 08-12 • Agility Plus 2T -4T 14
Agility R12 05 • Agility Rs Naked 2T 10 • Agility
Rs 09 • B&w Eu2 03 • B&w 02 • Dink 4T 07 • Dink
Classic Eu2 03 • Dink Lc 98-02 • Filly Lx 01-02
Filly 98-00 • Heroism 95-97 • Like 2T 09 • Like 4T 09
Mxer Eu2 02-03 • People Eu2 03-11 • People S 4T
06-08 • People S 05-08 • People 99-04 • Sento 50
08 • Sniper Dd 93-96 • Super 8 2T 09 • Super 8 2T
13 • Super 8 4T 09 • Super 8 4T 13 • Super 8 07
Super 9 Sport Eu2 03-04 • Super 9 00 • Top Boy 97-
00 • Vitality 2T-4T 04 • Yup Eu2 03 • Yup 02
125: Agility 4T Eu3 06-08 • Agility 4T 06 • Agility
Carry 11 • Agility Plus 14 • Agility R16 08-12
Agility Rs 09 • B&w 125-150 00 • Dink Eu3 06-07
Dink 125-150 97-98 • Dink Classic 125-150 Eu2 03
Dink Classic 125-150 02 • Dink Lx 125-150 98-00
G-Dink 12 • Grand Dink 125-150 Eu2 01-04
Heroism 95-97 • Like Lx 12 • Like 09 • Movie Eu3
06-07 • Movie XL 125-150 Eu2 03-04
150: Agility R16 08-09 • Agility I Plus 12 • Movie
Eu3 06-07
200: Agility R16 10-12 • Agility I Plus 14 • Dink
Classic 09 • Dink E3 I 09 • Like 09 • Like Lx 12 •
People S 05-07
250: B&w 00-03 • Gran Dink 01-09 • People Lc 03-
04 • People S 06-07 • X Citing 05 • Yup 03
300: G-Dink 12 • People S 08
(R.O. 00109202)





14 256 0110



CUFFIA MOTORE - CYLINDER COWLING

PIAGGIO 50: Vespa R • S • Special • Revival • N • FL • Pk 82-84 • Pk XL • XL Rush 85-88
(R.O. 139261)



14 256 0120



CUFFIA MOTORE - CYLINDER COWLING

PIAGGIO 200: Vespa Px • Vespa Px Arcobaleno • Cosa CL • CLX
180-200: Rally
(R.O. 431054)



14 256 0130



CUFFIA MOTORE - CYLINDER COWLING

PIAGGIO 125/150: Vespa Px-Pe Arcobaleno-Cosa / VNX-VLX-VNX2-VLX2-VLR1T-VLR-VLX1
(R.O. 843530-431056)



14 256 0160



CUFFIA MOTORE - CYLINDER COWLING

PIAGGIO 125: Vespa Et3 Primavera
(R.O.174702)



14 256 0010



CUFFIA MOTORE - CYLINDER COWLING

(Cilindro orizzontale - *Horizontal Cylinder*)
MINARELLI - YAMAHA - MBK 50
(R.O. 72105400)



14 256 0020



CUFFIA MOTORE - CYLINDER COWLING

(Cilindro verticale - *Vertical Cylinder*)
MINARELLI - YAMAHA - MBK 50
(R.O. 3VLE265100)



14 256 0180



CUFFIA CILINDRO - COOLING HOOD

PIAGGIO 220: Ape Tm P602 82-83 • Ape Tmp703 • Ape P703V FL 84-05 • Ape Tm 09-15
(R.O. 231308)



NEW

14 258 0010



CONVOGLIATORE - COPRIVOLANO

AIR CONVEYOR - FLYWHEEL COVER
(Cilindro verticale - *Vertical Cylinder*)
MINARELLI - YAMAHA - MBK 50
(R.O. 3VLE265300)



14 258 0020



CONVOGLIATORE - COPRIVOLANO

AIR CONVEYOR - FLYWHEEL COVER
(Cilindro orizzontale - *Horizontal Cylinder*)
MINARELLI - YAMAHA - MBK 50
(R.O. 72105100)





COPRIVENTOLA FLYWHEEL COVER

14 258 0090



COPRIVENTOLA IN FERRO CROMATO
CHROMED STEEL FLYWHEEL COVER

PIAGGIO: Vespa Pk • XL • Rush • N • FL •

Ape 50

(R.O. 244735)



14 258 0091



COPRIVENTOLA IN FERRO NERO
BLACK STEEL FLYWHEEL COVER

PIAGGIO: Vespa Pk-XL • Rush • N • FL •

Ape 50

(R.O. 244735)



14 258 0100



COPRIVENTOLA IN FERRO CROMATO
CHROMED STEEL FLYWHEEL COVER

PIAGGIO: Vespa Px • Pe

(Senza avv. elettrico - *Without electric starter*)

(R.O. 610236M)



14 258 0101



COPRIVENTOLA IN FERRO NERO
BLACK STEEL FLYWHEEL COVER

PIAGGIO: Vespa Px • Pe

(Senza avv. elettrico - *Without electric starter*)

(R.O. 194362)



14 258 0140



COPRIVENTOLA IN FERRO NERO
BLACK STEEL FLYWHEEL COVER

PIAGGIO 50-90-125: Vespa Primavera

(R.O. 133658)



▶ CATENE TRASMISSIONE

DRIVE CHAINS





In 35 anni di attività **KMC** è divenuta la più grande azienda produttrice di catene di trasmissione industriale e per motocicli ,offrendo prodotti di elevata qualità che soddisfano le esigenze del mercato sia come primo equipaggiamento che dell' aftermarket . Dopo anni di impegno e sforzi le fabbriche di **KMC** situate in Asia hanno ricevuto le certificazioni ISO-9001 e TS-16949.

Nelle proprie fabbriche **KMC** applica le più avanzate soluzioni tecniche ed utilizza i migliori materiali in commercio ,impegnandosi nel realizzare catene sempre più affidabili e che diano soddisfazione nella guida ai propri clienti.

KMC has become the leading chain manufacturer within the 35 years of operation. KMC offers products with superior quality, serving for global original equipment demands and aftermarket customer demands. With years of efforts, KMC now has factories in Asia with ISO-9001 & TS-16949 certificates. To achieve the most efficient production management, KMC practices the advanced engineering in its plants. KMC is committed to excel for creating the most reliable and joyful chain using experience for the customers.

LEGENDA ICONE - ICONS DESCRIPTION



Catena dedicata all'utilizzo stradale
Designed for on - Road use



Catena dedicata all'utilizzo in fuoristrada
Designed for off-Road bikes



Catena sigillata con ORing a sezione circolare
Equipped with round-shaped seal



Catena sigillata con ORing con profilo a croce
Equipped with cross-shaped seal to enhance durability



Catena con particolare sistema di chiusura che aumenta la resistenza a fatica
Equipped with four-sides - riveting pins



Catena con maglie espressamente studiate a sezione maggiorata per una resistenza superiore a fatica
With heavier plates to increase tensile strength



Catena con rulli speciali ad alta resistenza
Equipped with solid bushing to upgrade fatigue resistance



Catena con perni ad alta resistenza
Equipped with specially processed pin to increase wear resistance



Catena con trattamento al nickel per le maglie
With silver-colored nickel plating and corrosion resistance



Catena con trattamento antiusura e frizione
Chain with special treatment for low friction

CATENE TRASMISSIONE - DRIVE CHAINS



CATENA DI TRASMISSIONE

KMC offre una gamma completa di catene di trasmissione per motociclette caratterizzate da alte prestazioni, elevata durata e accurata precisione dimensionale.

Il processo produttivo rigorosamente controllato garantisce che ogni componente soddisfi i più rigidi requisiti richiesti in campo motociclistico garantendo una qualità costante nel tempo oltre al miglior rapporto qualità / prezzo.

DRIVE CHAIN

KMC offers a full range of drive chains for motorcycles characterized by high-performance, high durability and precise dimensional accuracy. The strictly controlled manufacturing process ensures that every component meets the strictest requirements in motorcycle market, ensuring consistent quality over time and the best price / quality balance.

16 371 0130 	
MODELLO - MODEL	MAGLIE - LINKS
415H	130

16 371 9010 	
GIUNTO CATENA - CONNECTING LINK	
Con molletta - With clip	



16 371 0160 	
MODELLO - MODEL	MAGLIE - LINKS
415H	140

16 371 9010 	
GIUNTO CATENA - CONNECTING LINK	
Con molletta - With clip	



16 371 0150 	
MODELLO - MODEL	MAGLIE - LINKS
420H	120

16 371 9020 	
GIUNTO CATENA - CONNECTING LINK	
Con molletta - With clip	



16 371 0170	
MODELLO - MODEL	MAGLIE - LINKS
420H	140



16 371 9020	
GIUNTO CATENA - CONNECTING LINK	
Con molletta - <i>With clip</i>	



16 371 0210	
MODELLO - MODEL	MAGLIE - LINKS
428H	140



16 371 9160	
GIUNTO CATENA - CONNECTING LINK	
Con molletta - <i>With clip</i>	



16 371 0100	
MODELLO - MODEL	MAGLIE - LINKS
520H	120



16 371 9030	
GIUNTO CATENA - CONNECTING LINK	
Con molletta - <i>With clip</i>	



16 371 0120	
MODELLO - MODEL	MAGLIE - LINKS
530H	120



16 371 9040	
GIUNTO CATENA - CONNECTING LINK	
Con molletta - <i>With clip</i>	



CODICE RMS RIMS CODE	CODICE KMC KMC CODE	P	W	D	T	T2	d	L	G	-	-
		PASSO PITCH	LARGHEZZA INTERNA ROLLER LINK WIDTH	DIAM. RULLO ROLLER DIAMETER	SPESSORE PIASTRINA EST. PIN LINK PLATE THICKNESS	SPESSORE PIASTRINA INT. ROLLER LINK PLATE THICKNESS	DIAM. PERNO PIN DIAMETER	LUNGHEZZA PERNO OVER-ALL WIDTH. RIV.	LUNGHEZZA PERNO GIUNTO OVER-ALL WIDTH. CON.	CARICO ROTTURA MINIMO MINIMUM TENSILE STRENGTH	CARICO ROTTURA MEDIO AVERAGE TENSILE STRENGTH
UNITÀ DI MISURA UNIT OF MEASURE		mm.	mm.	mm.	mm.	mm.	mm.	mm.	mm.	KGf	KGf
16 371 0130	415H	12,7	4,68	7,77	1,5	1,5	3,95	13,0	14,7	1810	1900
16 371 0160	415H	12,7	4,68	7,77	1,5	1,5	3,95	13,0	14,7	1810	1900
16 371 0150	420H	12,7	6,25	7,77	1,8	1,8	3,95	15,90	17,35	1840	2100
16 371 0170	420H	12,7	6,25	7,77	1,8	1,8	3,95	15,90	17,35	1840	2100
16 371 0210	428H	12,7	7,85	8,51	1,8	1,8	4,45	17,55	19,05	2180	2300
16 371 0100	520H	15,875	6,25	10,16	2,35	2,35	5,07	18,25	20,20	3100	3300
16 371 0120	530H	15,875	9,4	10,16	2,35	2,35	5,07	21,55	23,50	3100	3300

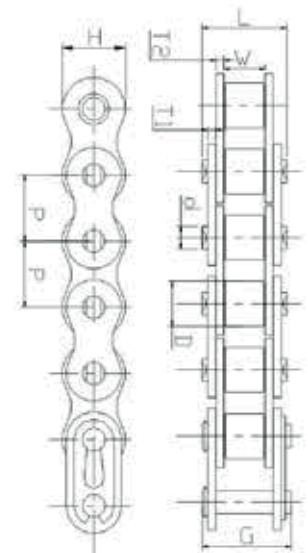

CATENE MOTOCROSS - MOTOCROSS CHAINS



CATENA MOTOCROSS

Catena per applicazioni off – road , prodotta con le migliori leghe d'acciaio e con esclusivi trattamenti termici che garantiscono una maggiore resistenza richiesta dalla guida in fuoristrada .

KMC , inoltre impiega speciali perni cromati e rullini ad alta resistenza che garantiscono un'usura minima ed elevato assorbimento degli shock caratteristici del motocross.

Queste qualità garantiscono al motociclista una guida fluida , divertente e sicura nel fuoristrada.

MOTOCROSS CHAIN

Chain for off – road applications , made from the best steel alloys and exclusive heat treatments guaranteeing greater strength required by off-road driving.

KMC also uses special chrome pins and rollers that ensure high strength , low consumption and high shocks absorption typical of motocross . These qualities provide to rider a smooth , fun and safe off-road ride .

16 371 0090	
MODELLO - MODEL	MAGLIE - LINKS
428DX	140

16 371 9120	
GIUNTO CATENA - CONNECTING LINK	
Con molletta - With clip	



16 371 0110	
MODELLO - MODEL	MAGLIE - LINKS
520DX	120

16 371 9130	
GIUNTO CATENA - CONNECTING LINK	
Con molletta - With clip	



CODICE RMS RMS CODE	CODICE KMC KMC CODE	P	W	D	T	T2	d	L	G	-	-
UNITÀ DI MISURA UNIT OF MEASURE		mm.	mm.	mm.	mm.	mm.	mm.	mm.	mm.	KGf	KGf
16 371 0090	428DX	12,7	7,85	8,51	2	2	4,51	18,80	20,00	2500	3000
16 371 0110	520DX	15,875	6,25	10,16	2	2	5,14	17,35	19,35	3500	3950

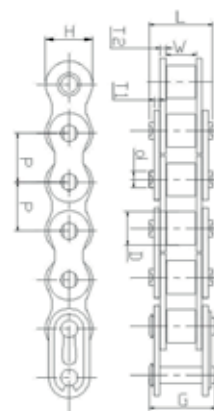

CATENE TRASMISSIONE SIGILLATE CON O-RING - O-RING SEALED DRIVE CHAINS



CATENA TRASMISSIONE SIGILLATA CON O-RING

Il disegno specifico delle catene sigillate KMC rende costante la lubrificazione prolungando la vita della catena stessa. La lega d'acciaio di qualità superiore e i trattamenti termici garantiscono una maggiore resistenza alle sollecitazioni. Inoltre, lo speciale grasso contenuto dagli anelli di tenuta, mantiene costante la lubrificazione ed elimina l'attrito durante il funzionamento, garantendo un'usura minore ed una vita della catena prolungata nel tempo.

O-RING SEALED DRIVE CHAIN

Specific design of sealed-in lubrication allows KMC sealed chain to have a longer and optimum life. Superior alloy steel and heat-treatment provides better performance in strength. In addition, special formulated grease retained by sealants ring, keeps a constant lubrication eliminating friction and prolonging chain life.

16 371 0220

MODELLO - MODEL	MAGLIE - LINKS
428UO	140



16 371 9170

GIUNTO CATENA - CONNECTING LINK
Con molletta - With clip



16 371 0030

MODELLO - MODEL	MAGLIE - LINKS
520UO	120



16 371 9080

GIUNTO CATENA - CONNECTING LINK
A Ribadire - Riveted



16 371 0180

MODELLO - MODEL	MAGLIE - LINKS
525SUO	120

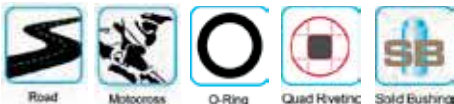

16 371 9090

GIUNTO CATENA - CONNECTING LINK
A Ribadire - Riveted



16 371 0070

MODELLO - MODEL	MAGLIE - LINKS
530SUO	120

16 371 9100

GIUNTO CATENA - CONNECTING LINK
A Ribadire - Riveted

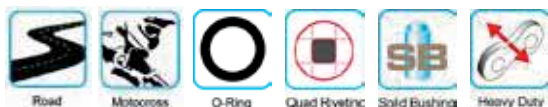

16 371 0290

MODELLO - MODEL	MAGLIE - LINKS
525SUO	130L

16 371 9090

GIUNTO CATENA - CONNECTING LINK
A Ribadire - Riveted



CODICE RMS RMS CODE	CODICE KMC KMC CODE	P	W	D	T	T2	d	L	G	-
		PASSO PITCH	LARGHEZZA INTERNA ROLLER LINK WIDTH	DIAM. RULLO ROLLER DIAMETER	SPESORE PIASTRINA EST. PIN LINK PLATE THICKNESS	SPESORE PIASTRINA INT. ROLLER LINK PLATE THICKNESS	DIAM. PERNO PIN DIAMETER	LUNGHEZZA PERNO OVER-ALL WIDTH, RIV.	LUNGHEZZA PERNO GIUNTO OVER-ALL WIDTH, CON.	CARICO ROTTURA MINIMO MINIMUM TENSILE STRENGTH
UNITÀ DI MISURA UNIT OF MEASURE		mm.	mm.	mm.	mm.	mm.	mm.	mm.	mm.	KGF
16 371 0220	428UO	12,7	7,85	8,51	1,8	1,8	4,51	20,1	21,8	2100
16 371 0030	520UO	15,875	6,25	10,16	2,2	2,2	5,24	20,55	21,85	3300
16 371 0180	525SUO	15,875	7,85	10,16	2,2	2,2	5,24	22,35	22,65	3900
16 371 0070	530SUO	15,875	9,4	10,16	2,4	2,4	5,35	24,70	25	4300
16 371 0290	525SUO	15,875	7,85	10,16	2,2	2,2	5,24	22,35	22,65	3900

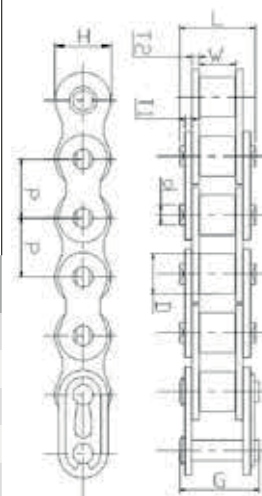

CATENE TRASMISSIONE SIGILLATE CON CROSS-RING
CROSS-RING SEALED DRIVE CHAINS



CATENA TRASMISSIONE SIGILLATA CON CROSS-RING

Il disegno specifico delle catene sigillate **KMC** rende costante la lubrificazione prolungando la vita della catena stessa. La lega d'acciaio di qualità superiore e i trattamenti termici garantiscono una maggiore resistenza alle sollecitazioni. Il grasso contenuto dagli anelli di tenuta, mantiene costante la lubrificazione ed elimina l'attrito durante il funzionamento, garantendo un'usura minore ed una vita della catena prolungata nel tempo. Inoltre lo speciale profilo degli elementi sigillanti garantisce una maggiore tenuta del lubrificante, prestazioni superiori, maggior resistenza, riducendo notevolmente gli attriti.

CROSS-RING SEALED DRIVE CHAIN

Specific design of sealed-in lubrication allows **KMC** sealed chain to have a longer and optimum life. Superior alloy steel and heat-treatment provides better performance in strength. Grease retrained by sealants ring, keeps a constant lubrication eliminating friction and prolonging chain life. In addition, special shaped sealant cross ring gives to chain best performances, more resistance and tensile strength, friction reduction.

16 371 0190



MODELLO - MODEL

MAGLIE - LINKS

525EX

120



Road

Cross Ring

Quad Riveted

Solid Bushing

16 371 9140



GIUNTO CATENA - CONNECTING LINK

A Ribadire - Riveted



CODICE RMS RMS CODE	CODICE KMC KMC CODE	P	W	D	T	T2	d	L	G	-
		PASSO PITCH	LARGHEZZA INTERNA ROLLER LINK WIDTH	DIAM. RULLO ROLLER DIAMETER	SPESORE PIASTRINA EST. PIN LINK PLATE THICKNESS	SPESORE PIASTRINA INT. ROLLER LINK PLATE THICKNESS	DIAM. PERNO PIN DIAMETER	LUNGHEZZA PERNO OVER-ALL WIDTH. RIV.	LUNGHEZZA PERNO GIUNTO OVER-ALL WIDTH. CON.	CARICO ROTTURA MINIMO MINIMUM TENSILE STRENGTH
UNITÀ DI MISURA UNIT OF MEASURE		mm.	mm.	mm.	mm.	mm.	mm.	mm.	mm.	KGF
16 371 0190	525EX	15,875	7,85	10,16	2,2	2,2	5,24	22,35	22,35	3900

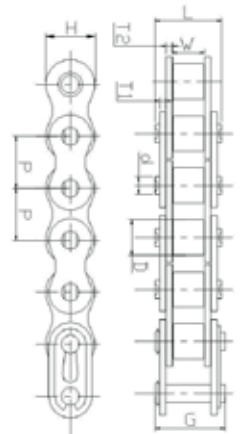

CATENE MINIMOTO - *MINIMOTO CHAINS*



16 371 0010 



MODELLO - MODEL	MAGLIE - LINKS
25HD	158

CODICE RMS RMS CODE	CODICE KMC KMC CODE	P	W	D	T	T2	d	L	-
UNITÀ DI MISURA UNIT OF MEASURE		mm.	mm.	mm.	mm.	mm.	mm.	mm.	KGF
16 371 0010	25HD	6,35	3,18	3,3	1	1	2,31	8,9	550

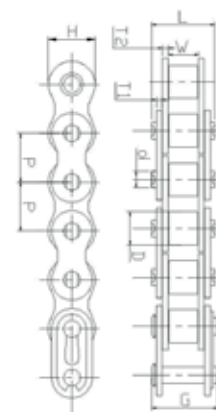



AM CHAIN è il brand più prestigioso del gruppo industriale **AMC CHAIN INDUSTRIAL CO LTD** introdotto nel mercato delle catene di trasmissione nel 2013.

Nelle catene **AM CHAIN** si è voluto confluire tutte le più avanzate tecnologie per quanto riguarda la conoscenza dei materiali, i loro trattamenti termici /galvanici e le tecnologie costruttive.

Nelle catene **AM CHAIN** troviamo trattamenti antifrizione ed antiusura, una speciale cura costruttiva di perni, rullini e maglie per garantire elevatissime caratteristiche meccaniche oltre all'utilizzo di cross ring a ridotto coefficiente d'attrito ed alta tenuta per mantenere costante la lubrificazione anche nell'uso più esasperato.

AM CHAIN is the most prestigious brand that AMC CHAIN INDUSTRIAL CO LTD introduced in the drive chain market during 2013.

AM CHAIN wants to merge all the most advanced technology and knowledge of materials, their heat treatment / plating and construction technologies.

With AM CHAIN you can find all the latest technologie concerning anti-friction and anti-wear treatments, a special design features of pins, rollers and links to ensure high mechanical characteristics as well as the use of cross ring with a low coefficient of friction and high resistance to maintain constant lubrication even in the most exasperated use.

16 371 0230

MODELLO - MODEL	MAGLIE - LINKS
520EX-GO	120

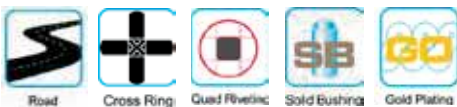

16 371 9220

GIUNTO CATENA - CONNECTING LINK
A Ribadire - Riveted



16 371 0260

MODELLO - MODEL	MAGLIE - LINKS
520EX	120



16 371 9250

GIUNTO CATENA - CONNECTING LINK
A Ribadire - Riveted



16 371 0240	
MODELLO - MODEL	MAGLIE - LINKS
525EX-GO	120



16 371 9230	
Giunto Catena • Connecting Link	
A Ribadire • Riveted	



16 371 0270	
MODELLO - MODEL	MAGLIE - LINKS
525EX	120



16 371 9260	
GIUNTO CATENA - CONNECTING LINK	
A Ribadire - Riveted	



16 371 0250	
MODELLO - MODEL	MAGLIE - LINKS
530EX-GO	120

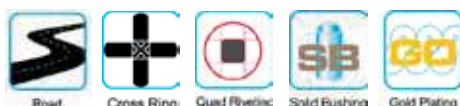

16 371 9240	
GIUNTO CATENA - CONNECTING LINK	
A Ribadire - Riveted	



16 371 0280	
MODELLO - MODEL	MAGLIE - LINKS
530EX	120



16 371 9270	
GIUNTO CATENA - CONNECTING LINK	
A Ribadire - Riveted	



CODICE RMS RMS CODE	CODICE KMC KMC CODE	P	W	D	T	T2	d	L	G	-	-
		PASSO PITCH	LARGHEZZA INTERNA ROLLER LINK WIDTH	DIAM. RULLO ROLLER DIAMETER	SPESSORE PIASTRINA EST. PIN LINK PLATE THICKNESS	SPESSORE PIASTRINA INT. ROLLER LINK PLATE THICKNESS	DIAM. PERNO PIN DIAMETER	LUNGHEZZA PERNO OVER-ALL WIDTH. RIV.	LUNGHEZZA PERNO GIUNTO OVER-ALL WIDTH. CON.	CARICO ROTTURA MINIMO MINIMUM TENSILE STRENGTH	CARICO ROTTURA MEDIO AVERAGE TENSILE STRENGTH
UNITÀ DI MISURA UNIT OF MEASURE		mm.	mm.	mm.	mm.	mm.	mm.	mm.	mm.	KGf	KGf
16 371 0230	520EX-GO	15,875	6,25	10,16	2,2	2,2	5,24	20,65	20,65	3600	3800
16 371 0240	525EX-GO	15,875	7,85	10,16	2,2	2,2	5,24	22,35	22,35	3900	4200
16 371 0250	530EX-GO	15,875	9,4	10,16	2,4	2,4	6,25	24,70	24,70	4500	4700
16 371 0260	520EX	15,875	6,25	10,16	2,2	2,2	5,24	20,65	20,65	3600	3800
16 371 0270	525EX	15,875	7,85	10,16	2,2	2,2	5,24	22,35	22,35	3900	4200
16 371 0280	530EX	15,875	9,4	10,16	2,4	2,4	6,25	24,70	24,70	4500	4700

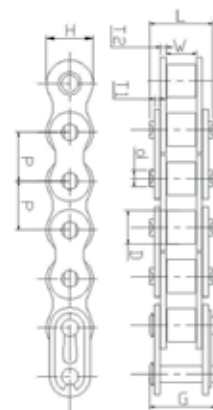



RMS
YOUR BEST PARTNER

▶ LEVE
LEVERS

▶ COMANDI GAS
PORTALEVA
GAS CONTROL

▶ **RMS**
YOUR BEST PARTNER

▶ **domino**
COMANDI MOTO



**LEVE
LEVERS**

APRILIA

18 410 0010



(SX) 50: Amico 92
(R.O. AP8218153)



18 410 0021



(SX) 50: Amico 94 • Amico 96-98 • Amico GL
GLE 93-95 • Amico Lx SportCat 92-93 • Gulliver
S 95 • Rally 94-95 • Rally 01-03 • Sr 93-95 • Sr
H2O Ditech e Carburatore - *Carburetor* 00-03
• Sr Liquid Cooled 94-95
(SX) 125: Sr 00
(R.O. AP8218153)



18 410 0031



(DX-SX) 50: Rally Lc 96-99
(R.O. AP8213279)



18 410 0041



(SX) 50: Scarabeo Tamb+Tamb • (*Drum Drum*)
93-97 • Scarabeo Disc+Tamb • (*Disc Drum*) 93-96
(R.O. AP8218176)



18 410 0051



(SX) 50: Scarabeo Disc+Tamb • (*Disc Drum*) 97
• Scarabeo Disc+Tamb • (*Disc Drum*) 99-05
(SX) 100: Scarabeo Motori Minarelli 00
(R.O. AP8218329)



18 410 0061



(SX) 50: Amico 96-98 • Gulliver – T/V/W 96-98
• Gulliver Lc 96-98 • Mojito Retro – Habana 99-
03 • Rally 96-98 • Sonic 98-07 • Sonic Gp 98-08
• Sr 96 • Sr Liquid Cooled 96 • Sr Stealth, Racing
97-99 • Sr Www 97-99
(SX) 125: Mojito Retrò 99-07 • Sr 99
(R.O. AP8218274)



18 410 0071



(SX) 50: Scarabeo Disc+Disc 98-05
• Scarabeo Ditech 01-04
(SX) 125: Leonardo 96-98
(R.O. AP8118461)



18 410 0571



Impianto Heng Tong - *Heng Tong System*
(DX-SX) 50: Sr R Factory ie e Carburatore - *Car-*
buretor 10-14 • Sr R Factory Mot Aprilia 05 • Sr
R R Factory 04-09 **(DX-SX) 125:** Sport City Eu3
06-08 • Sport City 04-06 • Sport City Street 12
(DX-SX) 200: Sport City 04-06
(DX-SX) 300: Sport City Street 12
(R.O. AP8213602)



18 410 0581



Impianto Grimeca - *Grimeca System*
(DX-SX) 50: Sr R Factory ie e Carburatore - *Car-*
buretor 10-11 • Sr R Factory Mot Aprilia 05 • Sr
R R Factory 04-09
(DX-SX) 125: Sport City Eu3 06-08
• Sport City 04-06
(R.O. AP8590035)



18 410 0771



Impianto Heng Tong - *Heng Tong System*
(DX-SX) 125: Atlantic 03-05 • Atlantic Eu3 06-12 •
Scarabeo le Light 09-12 • Scarabeo Light 07-08
Scarabeo Motore Piaggio Eu3 06 • Scarabeo 04-06 •
Sport City Cube 08-10
(DX-SX) 250: Scarabeo Light 06-08
• Sport City Cube 08-10
(DX-SX) 300: Atlantic 10-11 • Scarabeo Light 09-10
(DX-SX) 400-500: Atlantic Sprint 05-08
• Scarabeo Light 06-08
(R.O. AP8133809)



18 410 0861



(SX) 50: Sr Motard 12-13 • Sport City One 2T
08-11 • Sport City One 4T 08-10
125: Sr Motard 12-13 • Sport City One 4T Eu 3 08-11
(R.O. 564681)



18 410 1001



(SX) 50: Mojito Custom 2T Mot. Piaggio 04-10
Mojito Custom 99-03
125: Mojito Custom 99-07 • Mojito 08
(R.O. AP8218495)



● Terminale grosso - *Big end lever*
■ Colore nero - *Black*
□ Colore lucido - *Glossy*

GRI Grimeca
H.T. Heng Tong
BRE Brembo

DX Destra - *Right*
SX Sinistra - *Left*

LEVE
LEVERS



APRILIA

18 412 0010 

(DX) 50: Amico 92
(R.O. AP8218189)



18 412 0021 

Impianto Grimeca - *Grimeca System*
(DX) 50: Amico 96-98 • Amico GL GLE 93-95 • Amico Lx Sport Cat 92-93 • Rally 94-95 • Rally 01-03 • Scarabeo Disc+Tamb • (*Disc Drum*) 93-96 • Sr 93-95 • Sr Liquid Cooled 94-95
(R.O. AP8218156)



18 412 0041 

(DX) 50: Scarabeo Tamb+Tamb • (*DrumDrum*) 93-97 (R.O. AP8218172)



18 412 0051 

Impianto Grimeca - *Grimeca System*
(DX) 50: Amico 96-98 • Rally 96-98 • Scarabeo 4T 02-06 • Scarabeo 4T Rst Eu3 06-09 • Scarabeo Ditech 01-04 • Scarabeo Quattro 09 • Scarabeo Street 05-06 • Scarabeo Street 2T Rst 06-09 • Sr 96 • Sr Liquid Cooled 96
(DX) 100: Scarabeo 4T 01-04 • Scarabeo 4T Net 10 • Scarabeo 4T Rst 06-09 • Scarabeo Motore Minarelli 00
(DX) 125: Leonardo 96-98
(R.O. AP8218273)



18 412 0061 

Impianto Grimeca - *Grimeca System*
(DX) 50: Gulliver Lc 96-98 • Mojito Retro – Habana 99-03 • Sonic 98-07 • Sonic Gp 98-08 • Sr Stealth, Racing 97-99 • Sr Stealth, Racing 97 • Sr Www 97-99
(DX) 125: Mojito 03-07 • Mojito Retrò • Custom 99-01 • Sr 99
(SX) 50: Sr Stealth, Racing 97
(R.O. AP8218288)



18 412 0501 

Impianto Grimeca - *Grimeca System*
(DX-SX) 50: Sr Ditech Eu2 02-03 • Sr H2O Ditech e Carburatore - *Carburetor* 00-03 • Sr Street 03-11
(DX) 125: Sr 00
(R.O. AP8218549)



18 412 0521 

(DX-SX) 500: Atlantic 01-04 • Scarabeo 03-06
(DX-SX) 125: Scarabeo Motore Rotax 99-01
(R.O. AP8118542)



18 412 0531 

(DX-SX) 250: Leonardo 99-04
(R.O. AP8218480)



18 412 0651 

Impianto Heng Tong - *Heng Tong System*
(DX) 50: Sport City One 2T/4T 08-10
(DX) 125: Sport City One 4T Eu3 08-10
(R.O. 497041)



18 412 0661 

Impianto Heng Tong - *Heng Tong System*
(DX-SX) 50: Sr Iniezione e Carburatore 14 - *Carburetor* 14 • Sr R Factory ie e Carburatore - *Carburetor* 10-14 • Sr Street
(DX-SX) 125: Sr Max 11-14
(DX-SX) 300: Sr Max 11-14
(R.O. 600475)



18 412 0711 

Impianto Heng Tong - *Heng Tong System*
(DX) 50: Scarabeo 4T 4V Net 10 • Scarabeo 2T Net 10
(DX) 100: Scarabeo 4T 10
(R.O. 497042)



18 412 0931 

Impianto Heng Tong - *Heng Tong System*
(DX) 50: Scarabeo 2T Net 09 • Scarabeo 4T 4V Net 09 • Scarabeo 4T Restyling Eu3 06-09 • Scarabeo 4T 02-06 • Scarabeo Quattro 09 • Scarabeo Street 2T Restyling 06-09 • Scarabeo Street 05-06
(DX) 100: Scarabeo 4T Net 10 • Scarabeo 4T Restyling 06-09
(R.O. AP8218640)





LEVE
LEVERS

APRILIA

18 412 0941 

(DX) 50: Mojito Custom 99-03 • Mojito 04-08
125: Mojito Retrò Custom 99-01 • Mojito 03-08
660: Pegaso Strada (Fun) - Factory - Tr 05-09
(R.O. AP8218479)



18 412 0971 

(DX-SX) 50: Sr Street 03-12
(R.O. AP8213597)



DERBI

18 410 0571 

Impianto Heng Tong - *Heng Tong System*
(SX) 125: Rambla Eu3 – II Vers. 08-09
(SX) 300: Rambla 10-11
(R.O. AP8213601)



18 410 0581 

Impianto Grimeca - *Grimeca System*
(SX) 125: Rambla Eu3 – II Vers. 08-09
(SX) 300: Rambla 10-11
(R.O. AP8590035)



18 410 0601  ●

(SX) 50: Boulevard 2T 09-10 • Boulevard 4T 09-10 • Boulevard 2T 09-10 • Boulevard 4T 09-10 • Sonar 2T 10-11
(SX) 100: Boulevard 4T 10
(SX) 125: Sonar 4T 09
(SX) 150: Boulevard Eu3 – II Vers. 10 • Boulevard Eu3 110 • Sonar 4T 09
(R.O. 564683)



18 410 0861 

(SX) 50: Variant Sport 2T 12
125: Variant Sport 4T Eu 3 12 • Boulevard 02-07
150: Boulevard 02-07
200: Boulevard 05
(R.O. 564681)



18 412 0652 

Impianto Heng Tong - *Heng Tong System*
(DX) 50: Boulevard 2T 09-10 • Sonar 2T 10-11
(DX) 100: Boulevard 4T 10
(R.O. 646833)



18 412 0711  ●

Impianto Heng Tong - *Heng Tong System*
(DX) 50: Boulevard 4T 09-10
(DX) 125: Sonar 4T 09
(DX) 150: Boulevard Eu3 110 • Sonar 4T 09
(R.O. 497042)



GILERA

18 412 0731  ●

Impianto Grimeca - *Grimeca System*
(DX) 50: Boulevard 2T 09-10 • Boulevard 4T 09-10
(DX) 100: Boulevard 4T 10
(DX) 150: Boulevard Eu3 – II Vers. 10
(R.O. 646803)



18 410 0111 

(SX) 50: Easy Moving 95-96 • Storm 94-95 • Typhoon 94-97 • Typhoon X 98-99 • Typhoon Xr 00
(R.O. 564689)



18 410 0181 

(SX) 50: Storm Eu2 07
(SX) 125: Runner FxFxr 97-02
(R.O. 561131)



● Terminale grosso - *Big end lever*
 ■ Colore nero - *Black*
 □ Colore lucido - *Glossy*

GRI Grimeca
H.T. Heng Tong
BRE Brembo

DX Destra - *Right*
SX Sinistra - *Left*

LEVE
LEVERS



GILERA

18 410 0531 

(SX) 50: Stalker 97-06 • Stalker 07-09 • Stalker Spec Edit 07-08
 (R.O. 562450)



18 410 0591 

(SX) 50: Stalker 97-06 • Stalker 07-09 • Stalker Spec Edit 07-08
 (R.O. 564682)



18 410 0601 

(SX) 125: Runner Fx Fxr 97-02
 (R.O. 564683)



18 410 0851 

(SX) 50: Ice 01-05 • Stalker Naked 08
 (R.O. 647552)



18 412 0091 

(DX) 50: Storm 94-95 • Typhoon 94-97 • Typhoon X 98-99 • Typhoon Xr 00
 (R.O. 564690)



18 412 0101 

(DX) 125: Typhoon 95-98 • Typhoon XXr 99-00
 (R.O. 271449)



18 412 0111 

Impianto Grimeca - *Grimeca System*
(DX-SX) 50: Runner 97-00 • Runner Poggiali 02 • Runner Purejet 02-04 • Runner Sp 02-04 • Stalker 97-00
(DX-SX) 180: Runner VxVxr 00-04
(DX) 180: Runner FxFxr 97-02
(SX) 125: Runner FxFxr 97-02
 (R.O. 494952)



18 412 0231 

(DX) 50: Easy Moving 95-96
 (R.O. 494951)



18 412 0601 

Impianto Brembo - *Brembo System*
(DX-SX) 50: Dna 00-07 • Dna Gp Experience 03-04
(DX-SX) 500: Fuoco Eu3 07-11 • Nexus 03-05 • Nexus Eu3 06-11 • Nexus Sp Eu3 06-07
(SX) 125: Dna 01
 (R.O. 646829-497031)



18 412 0651 

Impianto Heng Tong - *Heng Tong System*
(DX-SX) 50: Runner Poggiali 02 • Runner Purejet 02-04
(DX-SX) 125: Runner FxFxr 97-02 • Runner VxVxr 00-01
(DX) 50: Stalker 07-09 • Stalker Spec Edit 07-08
(SX) 180: Runner FxFxr 97-02
 (R.O. 497041)



18 412 0652 

Impianto Heng Tong - *Heng Tong System*
(DX-SX) 50: Runner Purejet 05-10 • Runner Purejet St 08 • Runner Sp 05-07 • Runner Sp 10 • Runner Sp Spec Edit 07 • Storm Eu2 07
(DX-SX) 125: Runner Vx 05-06 • Runner Vx 4T Eu3 07 • Runner Vx 4T St Eu3 08-09 • Runner Vx Race 06 • Runner VxVxr 00-01
(DX-SX) 200: Runner Vxr 05-06 • Runner Vxr 4T St Eu3 08 • Runner Vxr Eu3 07
(DX-SX) 180: Runner VxVxr 00-04
 (R.O. 646833)



18 412 0661 

Impianto Heng Tong - *Heng Tong System*
(DX-SX) 50: Dna 00-07 • Dna Gp Experience 03-04
(DX-SX) 125: Nexus Eu3 07-08 • Nexus Eu3 le 08-10
(DX-SX) 250: Nexus Eu3 06-07 • Nexus Sp Eu3 06-07
(DX) 50: Stalker Naked 08 - **(SX) 300:** Nexus Eu3 08-09 - **(SX) 500:** Fuoco Eu3 07-11
 (R.O. 600475)





LEVE
LEVERS

GILERA

18 412 0711



Impianto Heng Tong - *Heng Tong System*
(DX-SX) 50: Runner Purejet 05-10 • Runner Purejet St 08 • Runner Sp 05-07 • Runner Sp 10 • Runner Sp Spec Edit 07
(DX-SX) 125: Runner FxFxr 97-02 • Runner Vx 05-06 • Runner Vx 4T Eu3 07 • Runner Vx 4T St Eu3 08-09
(DX-SX) 180: Runner FxFxr 97-02 • Runner VxVxr 00-04
(DX-SX) 200: Runner Vxr 05-06 • Runner Vxr 4T St Eu3 08 • Runner Vxr Eu3 07 • Runner Vxr Race 06
(R.O. 497042)



18 412 0721



Impianto Brembo - *Brembo System*
(DX-SX) 50: Dna 00-07 • Dna Gp Experience 03-04
(DX) 50: Ice 01-05
(SX) 125: Dna 01
(DX) 500: Fuoco Eu3 07-11
(DX-SX) 500: Nexus 03-05 • Nexus Eu3 06-11 • Nexus Sp Eu3 06-07
(R.O. 497031)



18 412 0731



Impianto Grimeca - *Grimeca System*
(DX) 50: Runner Sp Spec Edit 07
(DX-SX) 125: Runner Vx 05-06 • Runner Vx Race 06
(DX-SX) 200: Runner Vxr 05-06 • Runner Vxr Eu3 07 • Runner Vxr Race 06
(SX) 125: Runner Vx Sc 06-07
(R.O. 646803)



HONDA

18 410 0341



(SX) 50: Sh 19-95> • FiftyBalj
• Sh Freno Disco - *Brake Disc*
100: Bali



18 410 0371



(SX) 50: Sky Freno Disco - *Brake Disc*



18 410 0381



(SX) 50: Sky 96>
• Sh Freno Disco - *Brake Disc 96>*



18 410 0391



(SX) 50: Sfx Vision • Pk Wallaro



18 410 0441



(SX) 125-150: @ • Sh • Dylan



18 410 0451



(SX) 125-150-250: Pantheon • Foresight



18 410 0611



(SX) 125: Sh L 09-10
(SX) 150: Sh L 09-10
(SX) 300: Sh 07-08 • Sh L 07-08



18 412 0421



(DX) 50: Sky F.D. <96



18 412 0431



(DX) 50: Sfx • Sh Freno Disco - *Brake Disc 96>*



● Terminale grosso - Big end lever
■ Colore nero - Black
□ Colore lucido - Glossy

GRI Grimeca
H.T. Heng Tong
BRE Brembo

DX Destra - Right
SX Sinistra - Left

LEVE
LEVERS



HONDA

18 412 0441 

(DX) 50-100: Balj



18 412 0541 

(DX) 125-150: @ • Sh • Dylan



18 412 0551 

(DX) 125-150-250: Pantheon • Foresight



ITALJET

18 412 0741 

(DX) 125: Sh L 09-10
(DX) 150: Sh L 09-10
(DX) 300: Sh 07-08 • Sh I 07-08



18 410 0131 

(SX) 50: Pista • Bazoka • Scoop



KYMCO

18 410 0131 

(SX) 50: Dj W 94-00 • Dj X 91-92 • Djy 93



18 410 0461 

(SX) 50: Mixer 02-03 • Mixer Eu2 04 • Mxu 06-07 • Mxu Sr 06
(SX) 125: Dink Eu3 06-07 • Dink 97-98
(SX) 200: Dink Eu3 L 06-07
(R.O. 00153984)



18 410 0471 

(SX) 125: B&w 00 • B&w Eu2 03-04 • Dink Classic 02 • Dink Lx 98-00 • Grand Dink 01-02 • People Gti 10
(SX) 150: B&w 00 • B&w Eu2 03-04 • Dink Classic Eu2 02-03 • Dink Lx 98-00 • Grand Dink 01-02 • Grand Dink Eu2 03-04
(SX) 200: Dink Classic 04 • People Gti 10
(SX) 250: B&w 00 • B&w Eu2 03 • Grand Dink Eu2 03-04 • People Lc 03-04 • People S 06 • People S 250L 07 • Yup 03
(SX) 300: People Gti 10 • People S 300 L 08
(R.O. 00153977)



18 410 0481 

(SX) 50: Agility 4T R12 07-08 • Agility R12 05 • Fever Zx Eu2 03-04 • People 99-00 • People Eu2 08-11 • Sento 08 • Vitality 2T 04 • Vitality 4T 04 • Yup Eu2 03
(SX) 125: Agility 4T 06 • Agility 4T Eu3 06-08 • Movie 99-00 • Movie Eu3 06-07 • Movie XL Eu2 03-04 • People 99-00 • People Eu3 07-11 • People S 05 • Vivio 00
(SX) 150: Movie Eu3 06-07 • People 99-00 • People Eu2 03
(SX) 200: People S 05
(R.O. 0015216100152050)



18 410 0541 

(SX) 50: Super 9 00 • Super 9 Sport Eu2 03-04
(SX) 125: Like 09 • People S Dd Eu3 07-08
(SX) 200: Like 200L 09 • People S 20-01 07
(R.O. 00153782)



18 410 0711 

(SX) 50: Agility 4T R10 06-08 • Top Boy 97-00
(R.O. 00152580)





LEVE
LEVERS

KYMCO

18 410 0721 

(SX) 50: Agility 4T R16 08 • Agility 4T R16 09
(R.O. 00153308)



18 410 0741 

(SX) 50: People S 05-08 • People S 4T 06-08
• Super 8 07 • Super 8 2T 09 • Super 8 4T 09
(SX) 125: Super 8 08-09
(R.O. 00153759)



18 410 0751 

(SX) 125: Agility R16 08-09
(SX) 150: Agility R16 08 • Agility R16 09
(SX) 200: Agility L R16 10
(R.O. 00153414)



18 410 0761 

(SX) 125: Downtown I 09 • **200:** Downtown I
10 • **300:** Downtown I 09 • Downtown Abs I 11
• Downtown Abs 10 • Downtown I11 • X Citing
I R 08-09 • X Citing I 08 • **700:** Myroad I 11
(R.O. 00153298)



18 412 0461 

(DX) 50: Dink 50 4T 07
(DX) 125: Dink Eu3 06-07 • Dink 97-98
(DX) 200: Dink Eu3L 06-07
(R.O. 00156915)



18 412 0571 

(DX) 50: B&w 02 • B&w Eu2 03 • Dink Classic
Eu2 03 • Dink Lc 99-02
(DX) 125: B&w 00 • B&w Eu2 03-04 • Dink
Classic 02 • Dink Classic Eu2 03 • Dink Lx 98-00
• People Gti 10
(DX) 150: B&w 00 • B&w Eu2 03-04 • Grand
Dink 01-02 • Grand Dink Eu2 03-04
(DX) 200: Dink Classic 04 • People Gti 10
(DX) 250: B&w 00 • B&w Eu2 03 • Grand Dink
01-02 • People Lc 03-04 • People S 06 • People
S 250L 07 • Yup 03
(DX) 300: People Gti 10 • People S 300L 08
(R.O. 00153960)



18 412 0581 

(DX) 50: Agility 4T R12 07-08 • Agility R12 05
• Agility Rs 09 • Agility Rs Naked 2T 10 • People
99-00 • People 04 • Sento 08 • Super 8 07 •
Super 8 2T 09 • Super 8 4T 09 • Vitality 2T 04 •
Vitality 4T 04 • Yup Eu2 03
(DX) 125: Agility 4T 06 • Agility 4T Eu3 06-08
• Agility Rs 09 • People 99-00 • People Eu2 03 •
People Eu3 07-11 • Super 8 08-09
(DX) 150: People 99-00 • People Eu2 03
(R.O. 00153159)



18 412 0681 

(DX) 50: Fever Zx 99-00 • Fever Zx Eu2 03-04 •
Like 2T 09 • People S 05-08 • People S 4T 06-08
• Super 9 00 • Super 9 Sport Eu2 03-04
(DX) 125: Like 09 • Movie 99-00 • Movie 125
Eu3 06-07 • Movie XL 01 • Movie XL Eu2 03-04
• People S 05 • People S Dd Eu3 07-08 • Vivio 00
(DX) 150: Movie Eu3 06-07
(DX) 200: Like 200L 09 • People S 05 • People
S 200L 07
(R.O. 00153760)



18 412 0761 

(DX) 50: Agility 4T R10 06-08 • Agility 4T R16
08 • Agility 4T R16 09 • Top Boy 97-00
(DX) 125: Agility R16 08-09
(DX) 150: Agility R16 08 • Agility R16 09
(DX) 200: Agility I R16 10
(R.O. 00153413)



LEM

18 412 0801 

(DX) 125: Downtown I 09 • **200:** Downtown I
10 • **300:** Downtown I 09 • Downtown Abs I 11
• Downtown Abs 10 • Downtown I11 • X Citing
I R 08-09 • X Citing I 08 • **700:** Myroad I 11
(R.O. 00153297)



18 410 0131 

(SX) 50: Flash • Tornado – Centro Base 93-94 •
Centro SL 94-95 • F10 Jet Line 92-93



- Terminale grosso - *Big end lever*
- Colore nero - *Black*
- Colore lucido - *Glossy*

- GRI** Grimeca
- H.T.** Heng Tong
- BRE** Brembo

- DX** Destra - *Right*
- SX** Sinistra - *Left*

**LEVE
LEVERS**



LML

18 410 0251 

(DX-SX) 125-150: LML Freno Tamburo
Brake Shoes
(R.O. 138836)



18 410 0911 

(SX) 125-150: LML Freno Disco - *Brake Disc*
(R.O. 225340)



18 412 0791 

(DX) 125-150: LML Freno Disco - *Brake Disc*
(R.O. 494804)



MALAGUTI

18 410 0361 

(SX) 50: Centro SL 96-98 • Centro SL Kat 99-00 • Ciak 99-00 • Ciak Master 04 • Ciak Mono Eu2 2.3 03 • Crosser Cr1 95-98 • F10 Ac 08 • F10 Rst Eu1 01-02 • F10 Rst Eu2 06 • F12 Aria Rst Eu2 06 • F12 Phantom 94-98 • F12 Phantom Lc 94-98 • F12 Phantom Rst Eu2 02 • F15 Fire Fox Ac 05-06 • Yesterday Euro 97-00
(SX) 125: Ciak 00-01 • Ciak Master 04 • Ciak Master Eu3 06
(SX) 150: Ciak 00-02 • Ciak Master 04 • Ciak Rst Eu2 03
(SX) 200: Ciak Master Eu2 06
(R.O. 12113303)



18 410 0631 

(SX) 50: Ciak Td 00-01 • F12 Lc Rst Eu2 06 • F12 Phantom Lc Eu1 99-00 • F12 Phantom Lc Rst Eu2 02 • F12 Phantom Lc Twin Disks 98 • F12R Phantom Lc 07-10 • F15 Fire Fox 96-98 • F15 Fire Fox eu2 02-03 • F15 Fire Fox Rst Eu2 2.3 03-04 • F15 Fire Fox Twin Disks 98-99 • F15 Lc Rst Eu2 04-05
(SX) 100: Ciak 99-00 • F12 Phantom 99-00
(SX) 125: F18 Warrior 00-02
(R.O. 12114203)



18 410 0641 

(SX) 50: F12R Phantom Lc (Da Manubrio ZJM5883) 0710
(SX) 125: Blog 11 • Centro SI 11
(SX) 160: Blog le 11 • Centro SI 11
(R.O. 12121103)



18 410 0651 

(SX) 50: Centro 4T 08 • Centro SI 4T 10 • F12R Phantom Ac 09-10
(R.O. 12120903)



18 410 0661 

(SX) 125: Blog 09-10 • Centro le 08-09 • Centro SI 09-10
(SX) 160: Blog 09-10 • Centro le 08-09
(R.O. 12119803)



18 410 0671 

SX 50: F12R Phantom Ac 07-08
(R.O. 12120703)



18 412 0411 

DX 50: Centro SL 94-98 • Centro SL Kat 99-00 • Ciak 99-00 • Ciak Master 4T 05-06 • Ciak Master Eu2 06 • Ciak Mono Eu2 03 • Ciak Td 00-01 • Crosser Cr1 95-98 • F10 Ac 08 • F10 Jet Line 92-98 • F10 Kat 99-00 • F10 Rst Eu1 01-02 • F10 Rst Eu 22.3 03-04 • F10 Rst Eu2 02-03 • F10 Rst Eu2 06 • F12 AC/Lc Rst Eu2 06 • F12 Phantom 94-98 • F12 Phantom Lc 94-98 • F12 Phantom Lc Eu1 99-00 • F12 Phantom Lc Rst Eu1/Eu2 01-02 • F12 Phantom Lc Twin Disks 98 • F12 Phantom Rst Eu1/Eu2 01-02 • F12R Phantom Ac 07-08 • F12R Phantom Lc 07-10 • F15 Fire Fox 96-98 • F15 Fire Fox Ac 05-06 • F15 Fire Fox eu2 02-03 • F15 Fire Fox Twin Disks Kat 98-00 • F15 Lc Rst Eu2 04-05 • Yesterday Eu 97-00
(DX) 100: Ciak 99-00 • F12 Phantom 99-00
(DX) 125: Ciak 00-01 • Ciak Master 04 • Ciak Master Eu3 06 • Ciak Rst Eu2 03 • F18 Warrior 00-02
(DX) 150: Ciak 00-02 • Ciak Master 04 • Ciak Rst Eu2 03 • F18
(DX) 200: Ciak Master Eu2 06 Warrior 00-02
(R.O. 12113203)





LEVE
LEVERS

MALAGUTI

18 412 0591 

(DX-SX) 125: Madison 99-01 • Madison 3 06-09 • Madison R Rst 02 • Phantom Max 03
(DX-SX) 200: Madison S Rst 02 • Madison S Rst Eu2 03 • Phantom Max 03
(DX-SX) 250: Madison 3 06-09 • Madison S 99-01 • Password 05-06 • Password Eu3 07-08
(DX-SX) 400: Madison K 02 • Madison KRst 02-04
(DX-SX) 500: Spidermax Gt 04-05 • Spidermax Gt eu3 06
(SX) 150: Madison T 99-01
(SX) 160: Centro SI 09-10
(SX) 180: Madison R 01-02
(R.O. 12114303)



18 412 0771 

(DX) 50: Centro 4T 08 • Centro SI 4T 10 • F10 Ac Eco 09-10 • F12R Phantom Ac 09-10 • F12R Phantom Lc (Da Manubrio ZJM5883) 07-10
(DX) 125: Blog 11 • Centro SI 11
(DX) 160: Blog le 11 • Centro SI 11
(R.O. 12121003)



18 412 0781 

(DX) 125: Blog 09-10 • Centro le 08-09 Centro SL 09-10
(DX) 160: Blog 09-10 • Centro le 08-09 Centro SL 09-10
(R.O. 12119703)



MBK

18 410 0010 

(SX) 50: Booster 90-94 • Evolis 92-96
(R.O. 3VLH3912000)



18 410 0131 

(SX) 50: Ct S/Ss Sorriso 91-95 • Ct Ss New Sorriso 95-96 • Target 91-95
(R.O. 1NTH391200)



18 410 0141 

(SX) 100: Ovetto 00-02
(R.O. 5ADH391202)



18 410 0151 

(SX) 50: Booster R Road 94-95 • Booster Spirit 96-98 • Evolis 95 • Fizz 94-95 • Forte 94-95
(R.O. 4KHH391200)



18 410 0161 

(SX) 50: Booster Ng 95-98 • Booster Rocket 97-98 • Booster Spirit Special 00 • Booster Track 96-98
(R.O. 4SBH391200)



18 410 0401 

(SX) 50: Booster 01-03 • Booster L 01-03 • Booster Naked 03 • Booster Ng 01-03 • Booster Ng Eu2 01-06 • Booster Spirit Eu2 Sp 02-03 • Booster Spirit L 03 • Mach G Eu1Eu2 02-04 • Stunt 00-02
(R.O. 5JHH391200)



18 410 0411 

(SX) 50: Flipper Cat 6900 • Flipper 98-02 • Flipper Eu2 01-04
(R.O. 5EUH391200)



18 410 0421 

(SX) 50: Booster Ng 99 • Booster Spirit 99-00
(R.O. 4SBH391210)



18 410 0491 

(SX) 125: Doodo 00-02 • Skyliner 98-02
(SX) 150: Doodo 01-02 • Skyliner 00
(R.O. 5DSH391201)



- Terminale grosso - Big end lever
- Colore nero - Black
- Colore lucido - Glossy

- GRI Grimeca
- H.T. Heng Tong
- BRE Brembo

- DX Destra - Right
- SX Sinistra - Left

**LEVE
LEVERS**



MBK

18 410 0501 

(SX) 250: Skyliner Abs 00-03
(R.O. 5CG839121100)



18 410 0801 

(SX) 100: Yw Booster 99-01
(R.O. 4VPH39121000)



18 412 0010 

(DX) 50: Booster 90-94
(R.O. 3VLH39220000)



18 412 0151 

(DX) 50: Booster R Road 94-95 • Booster Spirit Special 0 • Evolis 92-96 • Evolis 95 • Fizz 94-95 • Forte 94-95 • Target 91-95
(DX) 125: Xc K Flame R 97-98
(DX) 150: Vertex 97
(R.O. 2NA839220100)



18 412 0161 

(DX) 50: Booster Spirit 96-98
(R.O. 4VVH392200)



18 412 0171 

(DX) 50: Booster Ng 95-98 • Booster Track 96-98
(R.O. 4SBH39220000)



18 412 0181 

(DX) 50: Booster Rocket 97-98
(R.O. 4TDH39220000)



18 412 0391 

(DX-SX) 50: Nitro Tutti – Jaguar Eu2 97-04
(R.O. 5BRH39120100)



18 412 0401 

(DX) 50: Ovetto Eu1Eu2 • Tutti 97-04
(DX) 100: Ovetto 00-02
(R.O. 5ADH39220100)



18 412 0471 

(DX) 50: Booster Spirit 99-00
(R.O. 4VVH39221000)



18 412 0481 

(DX) 50: Booster Ng 01-03 • Booster Ng Eu2 01-06 • Stunt 00-02
(R.O. 5JHH39220000)



18 412 0491 

(DX) 50: Flipper Cat 69-00 • Flipper 98-02 • Flipper Eu2 01-04
(R.O. 5EUH39220000)



18 412 0511 

(DX) 50: Booster Ng 99
(R.O. 4SBH39221000)



18 412 0601 

(DX) 125: Doodo 00-02 • Skyliner 98-02 • Skyline E 01-03 • Thunder 01-02
(DX) 150: Doodo 01-02 • Skyliner 00 • Skyliner 01-02 • Thunder 01-02
(SX) 125: Skyline E 01-03 • Thunder 01-02
(SX) 150: Skyliner 01-02 • Thunder 01-02
(SX) 180: Skyliner E 03-08
(SX) 300: Kilibre 03-06
(R.O. 5DSH39220100)



18 412 0611 

(DX) 250: Skyliner Abs 00-03
(R.O. 5CG839220100)





LEVE
LEVERS

PEUGEOT

18 410 0021 

(SX) 50: Looxor 01-03 • Looxor Tsdì 02 • Ludix 10 Trend • Snake 04 • Ludix 14 Elegant 04 • Speedake 95-97 • Speedfight 2 Ac 05-06 • Speedfight Lc 97-98 • Speedfight Ac 97-98 • Speedfight Ac Cat 99 • Squab 95-97 • Trekker 98-00 • Vivacity 99 • Vivacity Cat 99-02 • XFight Ac 00 • Zenith L 94-96 • Zenith LnLs 97-98
(SX) 100: Elyseo 99-01 • Trekker 98 • Vivacity 99-01
(SX) 125: Sv Tamburo/Drum 91-95 • Elyseo 99-00 • Elyseo 01
(SX) 150: Elyseo 99-00
(R.O. 754174)



18 412 0671 

Impianto AJP - *AJP System*
(DX) 50: Elyseo 99 • Jet Force 03 • Looxor 01-03 • Ludix 10 Trend • Snake 04 • Ludix 14 Elegant 04 • Speedfight Lc 97-98 • Speedfight Ac 97-98 • Trekker 98-00 • Vivacity 99 • Vivacity Cat 99-02 • XFight LcAc 00 • Zenith L 94-96 • Zenith LnLs 97-98
(DX) 100: Elyseo 99-01 • Speedfight 97-00 • Vivacity 99-01
(DX) 125: Elyseo 99-00 • Elyseo 01
(DX) 150: Elyseo 99-00
(SX) 50: Jet Force 03 • Speedfight Lc ICDICDP 97-98 • XFight Lc 00
(SX) 100: Speedfight 97-00 • XFight 00-01
(R.O. 752868)



18 412 0691 

(DX-SX) 50: Jet Force 03
(DX) 50: MetalX 02 • Trk2 Wrc 04-06
(DX-SX) 100: Looxor 01 • Speedfight 97-00 • XFight 00-01
(DX-SX) 50: Speedfight 2 LcSilversport 05-06 • Speedfight Ac 97-98 • XFight Lc 00 • Xrace 03
(R.O. 757025-754709)



18 412 0701 

Impianto Heng Tong - *Heng Tong System*
(DX) 50: Elyseo 99 • Speedfight 2 Ac 05-06 • Speedfight Lc 97-98 • Speedfight Ac ICDICDP 97-98 • Speedfight Ac 97-98 • Speedfight Ac Cat 99 • Squab 95-97 • Vivacity 99 • Vivacity Cat 99-02 • XFight Ac 00 • Zenith L 94-96 • Zenith LnLs 97-98
(DX) 100: Elyseo 99-01 • Sv L 98 • Vivacity 99-01 • XFight 00-01
(DX) 125: Elyseo 99-00
(SX) 50: Speedfight Ac ICDICDP 97-98 • XFight Lc 00
(SX) 100: XFight 00-01
(R.O. 752864)



18 412 0821 

(DX) 50: Cw Booster Naked 03 • Cw Booster Spirit Eu2 02-03 • Cw Booster 01-02 • Cw L Booster Spirit 03 • Cw L Booster 01-03 • Cw Sp Booster Spririt Eu2 02
(R.O. 5NTH39220000)



18 412 0891 

(DX) 50: Cs Mach G Eu1 02-03 • Cs Mach G Eu2 02-04
(R.O. 5RWH392200)



PGO

18 410 0131 

(SX) 50: Big Max 96



18 412 0151 

(DX) 50: Big Max 96



● Terminale grosso - Big end lever
■ Colore nero - Black
□ Colore lucido - Glossy

GRI Grimeca
H.T. Heng Tong
BRE Brembo

DX Destra - Right
SX Sinistra - Left

LEVE
LEVERS



PIAGGIO

18 410 0111 

(SX) 50: Free Delivery 00-01 • Free FL 95-02 • Nrg 94-96 • Ntt 95-96 • Quartz 92-96 • Typhon 01-04 • Zip 95-96 • Zip Fast Raider 93-94 • Zip Fast Raider Rst 96-97 • Zip Rst Freno Disc/Disc 96-99 • Zip Rst Freno Tamburo/Drum 96-99 • Zip Sp 96-00
(SX) 100: Free 02-03
(SX) 125: Skipper 94-97 • Super Hexagon Gtx 12 01-02
(R.O. 564689)



18 410 0170 

(SX) 50: Free 92-94 • Zip 92-93 • Zip Bimodale 94-97
(R.O. 269070)



18 410 0181 

(SX) 50: Fly 2T 05-07 • Fly 2T 10 • Fly 4T 05-10 • Liberty 2T 06-08 • Liberty 2T Rst 04 • Liberty 4T 05-08 • Liberty 4T Rst 04 • Liberty 4T Sport 06-08 • Vespa Lx 2T 05-08 • Vespa Lx 2T Touring 10-11 • Vespa Lx 4T 05-08 • Vespa Lx 4T4V 09-10 • Vespa Lx 4T4V Touring 10-11 • Vespa S 4T4V & Coll 08-11
(SX) 100: Fly 4T 06-07
(SX) 125: Fly 05-07 • Fly Eu3 08 • Hexagon LxLxt 98-99 • Hexagon Lx4 98-99 • Liberty 4T 06-07 • Liberty 4T Eu3 07-08 • Liberty Sport 06 • Vespa Lx 05-06 • Vespa Lx 4T FI 09 • Vespa Lx Eu3 le 09-10 • Vespa Lx Touring 10-11 • Vespa S 4T Eu3 07-08 • Vespa S 4T le & Colledge 09-11
(SX) 150: Fly 05-07 • Fly Eu3 08-10 • Liberty 4T Eu3 08 • Liberty 4T Sport Eu3 08 • Liberty Moc 4T 09-10 • Vespa Lx 05-06 • Vespa Lx 4T FI 09 • Vespa Lx Eu3 06-08 • Vespa Lx Eu3 le 09-11 • Vespa Lx Touring 10-11 • Vespa S 4T 08-09 • Vespa S 4T le & Colledge 09-11
(SX) 200: Liberty 06 • Liberty 4T Eu3 07-08 • Liberty 4T Sport Eu3 06-07 • Liberty Rst 04 • Liberty Sport 06
(R.O. 561131)



18 410 0201 

(SX) 50: Liberty 97-05 • Liberty 4T 00-02 • Liberty Ptt Eu2 04-05 • Vespa Et2 97-05 • Vespa Et2 Iniezione 97-00 • Vespa Et4 00-05
(SX) 125: Liberty 98-02 • Liberty 01-02 • Vespa Et4 96-02 • Vespa Et4 99-02
(R.O. 564642)



18 410 0211 

(DX-SX) 50: Vespa elestart 70-76 • Vespa special 70-83
(DX-SX) 125: Vespa Et3 75-83 • Vespa Gtr 69-78
(R.O. 165279)



18 410 0212 

(DX-SX) 50: Vespa L 66-70 • Vespa R 70-83 • vespa S 63 • Vespa Super Sprint 66-71
(DX-SX) 90: Vespa 63 • Vespa Racer 71-73 • Vespa Super Sprint 65-71
(DX-SX) 125: Vespa 55-60 • Vespa 61-67 • Vespa Primavera 67-83 • Vespa Super 66-74
(DX-SX) 150: Vespa 59-66 • Vespa GL 63-64 • Vespa Super 66-79 • Vespa Sprint 65-74
(R.O. 070578)



18 410 0250 

(DX-SX) 125: Vespa Px T5 85-89
(R.O. 226792)



18 410 0251 

(DX-SX) 125: Vespa Ts 75-78 • Vespa Px 77-97 • Vespa Px 11 (R.O. 138836)
(SX) 125: Vespa Px 11
(DX-SX) 150: Vespa Px 77-97 • Vespa Pxe Arcobaleno 77-97
(DX-SX) 200: Vespa Pxe 77-97
(R.O. 138836)



18 410 0261 

(SX) 50: Vespa Pk FL 90 • Vespa Pk FL 2 Autom. 90-91 • Vespa Pk FL 2 Hp 91-97
(SX) 125: Vespa Pk FL 89-90
(R.O. 274546)



18 410 0300 

(SX) 50: Si FL2
(R.O. 268015)



18 410 0310 

(SX) 50: Si 90-91
(R.O. 228967)





LEVE
LEVERS

PIAGGIO

18 410 0531



(SX) 50: Nrg Extreme 99-00 • Nrg Mc3 01-04 • Zip 00-04 • Zip 4T 00-05 • Zip 4T 06-10 • Zip Sp 01-04 • Zip Sp Eu2 06-09
(SX) 125: Zip 00-02
(R.O. 562450)



18 410 0591



(SX) 50: Zip 00-04 • Zip 2T 08-10 • Zip 4T 06-10 • Zip Sp 01-04 • Zip Sp Eu2 06-09
(SX) 100: Zip 4T 06-10
(R.O. 564682)



18 410 0601



(SX) 50: Fly 2T 05-07 • Fly 4T 05-10 • Liberty 2T 06-08 • Liberty 4T 05-08 • Liberty 4T Sport 07-08 • Nrg Power Dt Serie Spec 07-08 • Typhoon 05-08 • Typhoon 09 • Vespa Lx 2T 05-08 • Vespa Lx 4T 05-08 • Vespa Lx 4T4V 09-10 • Vespa Lx 4T4V Touring 10-11
(SX) 100: Fly 4T 06-07
(SX) 125: Fly 05-07 • Fly Eu3 07-08 • Hexagon LxLxt 98-99 • Hexagon Lx4 98-99 • Liberty 4T 06-07 • Liberty Sport 06 • Vespa Lx 05-06 • Vespa Lx 4T FL 09 • Vespa Lx Eu3 06-08 • Vespa S 4T Eu3 07-08 • X9 01-02
(SX) 150: Fly 05-07 • Fly Eu3 08-10 • Liberty 4T Eu3 08 • Vespa Lx 05-06 • Vespa Lx Eu3 06-08 • Vespa Lx Touring 10-11 • Vespa S 4T 08-09 • Vespa S 4T le & College 09-11
(SX) 180: X9 Amalfi 00-03
(SX) 200: Liberty 06 • Liberty 4T Eu3 07-08 • Liberty 4T Sport Eu3 06-07 • Liberty Rst 04 • Liberty Sport 06
(R.O. 564683)



18 410 0731



(SX) 50: Liberty 4T Ptt 09-10 • Liberty 4T Delivery Tnt 09
(SX) 125: Liberty 4T Eu3 Delivery 08 • Liberty Rst Ptt 05-06
(R.O. 648083)



18 410 0821



(SX) 50: Vespa Lxv 2T Navy 08 • Lxv 2T 06-08
125: Lxv 4T Eu 3 06-09 • Lxv 4T Navy Eu 3 08 • Lxv le 4T 10-12
(R.O. 648115)



18 410 0851



(SX) 125-150: X8 Street Eu 2 06-08
(R.O. 647552)



18 410 0861



(SX) 50: Typhoon 2T 10-12
125: Typhoon 4T 2V Eu 3 10-11 • Skipper Lx 98-99 Skipper 4T 00-02
(R.O. 564681)



18 410 0881



(DX-SX) Vespa 50-125 Primavera Vma2t
(R.O. 147319)



18 410 0891



(DX-SX) Vespa 125 Vm1t/2 Vn1t/2tVna ½ 1/2/3/4/5/6
Vespa 150 V11/2/3 Vb1Vba1Vbb1/2Vbc1
Vespa 150 Gs Vs1/2/3/4/5 Vespa 160 Gs Vsb Vespa 180 Ss Vsc
(R.O. 033882)



18 410 0901



(DX-SX) Vespa 50 V5a3V5b2/4 V5s1 Vespa Rally 180-200 VsdVse
(R.O. 120487)



18 410 0911



(SX) Vespa Px 125-150 My 11
(R.O. 2425314)



18 410 0941



(DX-SX) 50: Vespa mod. Sport Lucida
Tutti i modelli - *All Models*
(R.O. 610285M)



18 410 0951



(DX-SX) 50: Vespa mod. Sport Nera
Tutti i modelli - *All Models*
(R.O. 610286M)



18 410 0961



(SX) 50: Vespa FL 90
Vespa FL2 Automatica 90-91
Vespa FL2 Hp 91-97
(SX) 125: Vespa FL 89-90
(R.O. 265947)



- Terminale grosso - *Big end lever*
- Colore nero - *Black*
- Colore lucido - *Glossy*

- GRI Grimeca
- H.T. Heng Tong
- BRE Brembo

- DX Destra - *Right*
- SX Sinistra - *Left*

LEVE
LEVERS



PIAGGIO

18 410 0971 

(SX) 50: Vespa FL 90
Vespa FL2 Automatica 90-91
Vespa FL2 Hp 91-97
(SX) 125: Vespa FL 89-90
(R.O. 265947)



18 410 1060 

(SX-DX) 50: Ciao Sc
(R.O. 156378)



18 410 1100 

(SX) 50: Ciao Px
(R.O. 176945)



18 412 0091 

(DX) 50: Free Delivery 00-01 • Free FL 95-02
• Nrg 94-96 • Ntt 95-96 • Typhoon 01-04 • Zip
Rst Freno tamburo/*Drum* 96-99
(DX) 100: Free 02-03
(R.O. 564690)



18 412 0101 

(DX) 50: Nrg Rst Mc2 96-98
(R.O. 271449)



18 412 0111 

Impianto Grimeca - *Grimeca System*
(DX) 50: Nrg Extreme 99-00 • Nrg Mc3 01-04
• Zip 00-04 • Zip 4T 00-05 • Zip Sp 01-04
(DX) 125: Hexagon 94-97 • Hexagon Gtx 00 •
Hexagon Lx4 98-99 • Skipper 4T 00-02 • Skip-
per Lx 98-99 • Super Hexagon Gtx 12 01-02 •
Zip 00-02
(DX-SX) 50: Nrg Extreme 01-04 • Nrg Purejet
02-04 • Nrg Rst Mc2 96-98
(SX) 180: Hexagon Gtx 00
(R.O. 494952)



18 412 0231 

(DX) 50: Quartz 92-96 • Zip 95-96 • Zip Fast
Raider 93-94 • Zip Fast Raider Rst 96-97 • Zip
Rst Freno Disco/*Disc* 96-99 • Zip Sp 96-00
(DX) 125: Skipper 94-97
(R.O. 494951)



18 412 0261 

Impianto Grimeca - *Grimeca System*
(DX) 50: Liberty 97-05 • Liberty 4T 00-02
• Vespa Et2 97-05 • Vespa Et2 Iniezione 97-00
• Vespa Et4 00-05
(DX) 125: Liberty 98-02 • Vespa Et4 96-02
(R.O. 494948)



18 412 0281 

(DX) 50: Vespa Pk FL 90 • Vespa Pk FL 2
Autom. 90-91 • Vespa Pk FL 2 Hp 91-97
(R.O. 274546)



18 412 0291 

(DX) 50: Vespa Pk FL 90 • Vespa Pk FL 2
Autom. 90-91 • Vespa Pk FL 2 Hp 91-97
(DX) 125: Vespa Pk FL 88-90
(R.O. 274546)



18 412 0330 

(DX) 50: Si FL2
(R.O. 268014)



18 412 0531 

Impianto Grimeca Abs - *Grimeca Abs System*
(DX-SX) 500: X9 Evolution 03-05 • X9 Evolu-
tion Abs 06-07
(R.O. 600829)





LEVE
LEVERS

PIAGGIO

18 412 0601



Impianto Brembo - *Brembo System*

(DX-SX) 200: Beverly 01-03 • Carnaby 07-08

(DX-SX) 125: Beverly 01-03 • Beverly Eu3 07-08

• Beverly Eu3 Mic 07 • Beverly Rst 06-07

• Beverly Tourer Eu3 08-09 • Carnaby 07-09

(DX-SX) 200: X9 02-03

(DX-SX) 250: Beverly Eu3 Mic 07 • Beverly Le

Eu3 06-08 • Beverly Rst 0405

(DX-SX) 400: Beverly Eu3 0607 • Beverly

Tourer Eu3 08-09

(DX-SX) 500: Beverly 05-06 • Beverly Eu3 06-

08 • X9 Evolution 03-05

(DX) 125: Beverly Eu3 Sport 07-08

(DX) 180: X9 Amalfi 00-03

(R.O. 646829)



18 412 0641



Impianto Heng Tong - *Heng Tong System*

(DX) 50: Liberty 97-05 • Liberty 4T 00-02

• Liberty Ptt Eu2 04-05 • Vespa Et2 97-05 •

Vespa Et4 00-05

(DX) 125: Liberty 01-02 • Vespa Et4 99-02

(R.O. 497039)



18 412 0651



Impianto Heng Tong - *Heng Tong System*

(DX-SX) 50: Nrg Mc3 01-04 • Nrg Power Pu-

rejet 04-05 • Nrg Purejet 02-04

(DX) 50: Typhoon 2T Eu2 10-11 • Zip 4T 06-10

• Zip Sp 01-04 • Zip Sp Eu2 06-09

(DX) 125: Skipper 4T 00-02 • Super Hexagon

Gtx 12 01-02 • Typhoon 4T 2V Eu3 10-11

(R.O. 497041)



18 412 0652



Impianto Heng Tong - *Heng Tong System*

(DX) 50: Fly 2T 10 • Fly 4T 05-07 • Liberty 2T

06-08 • Liberty 4T 05-08 • Nrg Power Dt 06-11

• Vespa Lx 2T 05-08 • Vespa Lx 4T 05-08 • Vespa

Lx 4T 4V 09-10 • Vespa Lx 4T 4V Touring 10-11

• Vespa S 4T4V & College 08-11

(DX-SX) 50: Nrg Power Dd 07-10 • Nrg Power

Purejet 07-11 • Nrg Purejet 10

(DX) 100: Fly 4T 06-07

(DX) 125: Fly 05-07 • Fly Eu3 08 • Liberty 4T

06-07 • Liberty 4T Eu3 07-08 • Liberty Rst Ptt

05-06 • Liberty Sport 06 • Vespa Gts Eu3 07-10

• Vespa Lx 05-06 • Vespa Lx 4T FL 09 • Vespa Lx

Eu3 06-08 • Vespa Lx Touring 10-11 • Vespa S

4T Eu3 07-08

(DX) 150: Fly 05-07 • Fly Eu3 08-10 • Liberty 4T

Eu3 08 • Vespa Lx 05-06 • Vespa Lx 4T FL 09

• Vespa Lx Eu3 ie 09-11 • Vespa Lx Touring 10-

11 • Vespa S 4T 08-09

(DX) 200: Liberty 06 • Liberty 4T Eu3 07-08

• Liberty 4T Sport Eu3 06-07 • Liberty Sport 06

(DX) 300: Vespa Gts Super Sport 10

(DX-SX) 125: Vespa Granturismo 03-05

(R.O. 646833)



18 412 0661



Impianto Heng Tong - *Heng Tong System*

(DX-SX) 125: Beverly 01-03 • Beverly Eu3

07-08 • Beverly Eu3 Mic 07 • Beverly Eu3 Sport

07-08 • Beverly Rst 04-07 • Beverly Tourer Eu3

08-09 • Carnaby 07-09 • X7 Evo Ie Eu3 09-10 •

X9 Evolution 05-07 • X9 Evolution Eu3 07 • X7

Eu3 08

(SX) 125: Mp3 07-08 • Mp3 Ibrido 09-10 • Mp3

Ie 08-09 • Mp3 Yourban Erl 11

(DX-SX) 200: Beverly 01-03 • Carnaby 07-08

• X8 05-07

(DX-SX) 250: Beverly 06-07 • Beverly Eu3 Mic

07 • Beverly Ie Eu3 06-08 • Beverly Rst 04-05

• Beverly Sport 06-08 • Beverly Tourer Eu3 08-

09 • Carnaby 08

(DX-SX) 300: Beverly Tourer Eu3 09-10 • Car-

naby Cruiser 09-11 • X7 Evo Ie Eu3 09-10

(SX) 400: Beverly Eu3 06-07 • Beverly Tourer

Eu3 08-09 • Mp3 07-08 • Mp3 Ie Lt Touring 11 •

Mp3 Ie Lt Sport 08-10 • Mp3 Mic 08-11 • X Evo

07-11 • X8 Eu3 06-08

(SX) 500: Beverly 05-06 • Beverly Eu3 06-08

(R.O. 600475)



18 412 0711



Impianto Heng Tong - *Heng Tong System*

(DX) 50: Fly 2T 10 • Fly 4T 05-10 • Liberty 2T

06-08 • Liberty 4T 05-08 • Liberty 4T Ptt 09-10

• Liberty 4T Delivery Tnt 09 • Liberty 4T Sport

07-08 • Nrg Power Dt 06-11 • Typhoon 05-08

• Typhoon 09 • Vespa Lx 2T 05-08 • Vespa Lx 2T

FL 09-10 • Vespa Lx 2T Touring 10-11 • Vespa Lx

4T 05-08 • Vespa Lx 4T4V 09-10 • Vespa Lx 4T4V

Touring 10-11

(DX-SX) 50: Nrg Power Dd 05-06 • Nrg Power

Dd 07-10 • Nrg Power Dd Serie Spec 07-10 •

Nrg Power Purejet 06-08 • Nrg Purejet 10

(DX) 100: Fly 4T 06-07

(DX-SX) 125: Vespa Granturismo 06-07 •

Vespa Granturismo Eu3 06-07 • Vespa Gts 4T ie

Super 09-11 • Vespa Gts Eu3 07-10

(DX) 125: Fly 05-07 • Fly Eu3 08 • Liberty 4T 06-

07 • Liberty Moc 4T & Elle 09-10 • Liberty Sport

06 • Vespa Lx 05-06 • Vespa Lx 4T FL 09 • Vespa

Lx Eu3 06-08 • Vespa Lx Eu3 ie 09-10

• Vespa Lx Touring 10-11 • Vespa S 4T Eu3 07-08

(DX) 150: Fly 05-07 • Fly Eu3 08-10 • Liberty 4T

Eu3 08 • Liberty 4T Sport Eu3 08 • Liberty Moc

4T 09-10 • Vespa Lx 05-06 • Vespa Lx 4T FL 09

• Vespa Lx Eu3 06-08 • Vespa Lx Eu3 ie 09-11 •

Vespa Lx Touring 10-11 • Vespa S 4T 08-09

• Vespa S 4T Ie & College 09-11

(DX) 200: Liberty 06 • Liberty 4T Sport Eu3

06-07 • Liberty Rst 04 • Liberty Sport 06

(DX-SX) 300: Vespa Gts ie Touring 11 • Vespa

Gts Super 08-10

(DX-SX) 200: Vespa Granturismo 06-07

(R.O. 497042)



- Terminale grosso - *Big end lever*
- Colore nero - *Black*
- Colore lucido - *Glossy*

GRI Grimeca
H.T. Heng Tong
BRE Brembo

DX Destra - *Right*
SX Sinistra - *Left*

LEVE
LEVERS



PIAGGIO

18 412 0721

Impianto Brembo - *Brembo System*

(DX-SX) 200: Beverly 01-03 • Carnaby 07-08
(DX-SX) 125: Beverly 01-03 • Beverly Eu3 07-08 • Beverly Eu3 Mic 07 • Beverly Rst 06-07 • Beverly Tourer Eu3 08-09 • Carnaby 07-09
(DX-SX) 200: X9 02-03
(DX-SX) 250: Beverly Eu3 Mic 07 • Beverly ie Eu3 06-08 • Beverly Rst 04-05
(DX-SX) 400: Beverly Eu3 06-07 • Beverly Tourer Eu3 08-09
(DX-SX) 500: Beverly 05-06 • Beverly Eu3 06-08 • X9 Evolution 03-05
(DX) 125: Beverly Eu3 Sport 07-08
(DX) 180: X9 Amalfi 00-03
(R.O. 646829)



18 412 0731

Impianto Grimeca - *Grimeca System*

(DX) 50: Fly 2T 05-07 • Fly 2T 10 • Fly 4T 05-07 • Fly 4T Mot Chn 06-07 • Liberty 2T 06-08 • Liberty 2T Rst 04 • Liberty 2T Sport 06-08 • Liberty 4T 05-08 • Liberty 4T Rst 04 • Liberty 4T Sport 06-08 • Liberty Moc 2T 09-10 • Liberty Moc 4T & Elle 09-10 • Nrg Power Dd Serie Spec 07-10 • Nrg Power Dt 06-08 • Nrg Power Dt Serie Spec 07-08 • Vespa Lx 2T 05-08 • Vespa Lx 4T 05-08 • Vespa S 2T & College 07-11 • Vespa S 4T4V & College 08-11
(DX) 100: Fly 4T 06-07
(DX) 125: Fly 05-07 • Fly Eu3 07 • Fly Eu3 08 • Hexagon LxLxt 98-99 • Hexagon Lx4 98-99 • Liberty 4T 06-07 • Liberty 4T Eu3 07-08 • Liberty 4T Eu3 Delivery 08 • Liberty 4T Sport Eu3 06-08 • Liberty Rst Ptt 05-06 • Liberty Sport 06 • Vespa Lx 05-06 • Vespa Lx Eu3 06-08 • Vespa S 4T Eu3 07-08
(DX) 150: Fly 05-07 • Fly Eu3 08-10 • Liberty 4T Eu3 08 • Liberty 4T Sport Eu3 08 • Vespa Lx 05-06 • Vespa Lx Eu3 06-08
(DX) 200: Liberty 06 • Liberty 4T Eu3 07-08 • Liberty 4T Sport Eu3 06-07 • Liberty Sport 06
(SX) 250: Hexagon GtGtx 98-00 • Vespa Gts, Gts Abs 05-10
(R.O. 646803)



18 412 0791

(DX) 125: Vespa Px 11 • Vespa Px 11 • Vespa Px Millenium 07-08
(DX) 200: Vespa Px F. Disco 98-01
(R.O. 494804)



18 412 0911

50: Vespa Hp
(R.O. 265948)



18 412 0921

(DX-SX) 250: Beverly Cruiser 07-09
500: Beverly Cruiser 07-12
(R.O. 649196)



18 412 1001

Impianto Heng Tong - *Heng Tong System*
(DX-SX)
300: Carnaby Cruiser 09-12
(R.O. 665870)



18 412 1070

(DX) 50: Ciao Px
(R.O. 177340)



18 412 1080

(DX) 50: Si 90-91
(R.O. 228966)



18 414 0050

LEVA DECOMPRESSORE

PIAGGIO 50: Bravo Erre 2 75-81 • Ciao 80-88 • Si 79-88 • Superbravo 85-90
(R.O. 176946)



18 414 0060

LEVA DECOMPRESSORE

PIAGGIO 50: Ciao • Si
(R.O. 268099)





LEVE
LEVERS

SUZUKI

18 410 0521



(SX) 125: Uh Burgman K2K6 02-03 • Uh Burgman K7L0 07-10 • Uh Burgman L1 11 • Ux Sixteen K8L0 08-10 • Ux Sixteen L1 11

(SX) 150: Uh Burgman K2K6 02-03 • Ux Sixteen K8L0 08-10 • Ux Sixteen L1 11

(SX) 200: Uh Burgman K7L0 07-10 • Uh Burgman L1 11

(SX) 250: An Burgman K3K6 03-06 • An Burgman WK2 98-02

(SX) 400: An Burgman K3K6 03-06 • An Burgman K7L0 07-10 • An Burgman L1 11 • An Burgman XK2 99-02

(R.O. 57500-14F00-000)

18 412 0621



(DX) 50: Aj Zz Sepia S 95-97

(DX) 110: Ug Hokuto 00

(DX) 125: An SY 95-00 • Uc Epicuro XK1 99-01

(DX) 150: AntY 96-00 • Uc Epicuro XK1 99-01

(R.O. 57421-29C00-000)

18 412 0631



(DX) 125: Uh Burgman K2K6 02-03 • Uh Burgman K7L0 07-10 • Uh Burgman L1 11 • Ux Sixteen K8L0 08-10 • Ux Sixteen L1 11

(DX) 150: Uh Burgman K2K6 02-03 • Ux Sixteen K8L0 08-10 • Ux Sixteen L1 11

(DX) 200: Uh Burgman K7L0 07-10 • Uh Burgman L1 11

(DX) 250: An Burgman K3 K6 03-06 • An Burgman WK2 98-02

(DX) 400: An Burgman K3 K6 03-06 • An Burgman K7L0 07-10 • An Burgman L1 11 • An Burgman XK2 99-02

(R.O. 57421-14F00-000)



YAMAHA

18 410 0010



(SX) 50: Bw'S Tamburo - Drum
(R.O. 5JHH39121000)



18 410 0131



(SX) 50: Cr Z 91-95 • Ct S/Ss 90-95
(R.O. 1NTH39120000)



18 410 0141



(SX) 50: Yn Neo'S/Eu2 97-06
(SX) 100: Yn Neo'S 00-01
(R.O. 5ADH39120200)



18 410 0151



(SX) 50: Ya R Axis 95 • Ym Breeze 94-95
(R.O. 4KHH39120000)



18 410 0161



(SX) 50: Bw'S Bump 97-98 • Bw'S Ng 97-98 • Bw'S Original S. Special 99-00 • Cw Rs Spy 95-98
(R.O. 4SBH39120000)



18 410 0401



(SX) 50: Bw'S 04-09 • Bw'S 10-11 • Bw'S Naked 03 • Bw'S Naked 04 • Bw'S Naked 09-11 • Bw'S Ng 01-06 • Bw'S Original/Eu2 01-03 • Bw'S R 01 • Cw Bw'S L 03 • Cw Bw'S L 04 • Cw Bw'S Original Eu2 02 • Cw Bw'S Original Sp 02 • Cs Jog R 02-11 • Cs Jog R Eu2 02-09 • Ew Slider 00-02 • Yn Neo'S 07-11 • Yn F Neo's \$ 09-11
(R.O. 5JHH391200)



18 410 0411



(SX) 50: Yh Why/Eu1/Eu2 98-09
(R.O. 5EUH39120000)



18 410 0421



(SX) 50: Bw'S Ng Cat 99-00 • Bw'S Original 97-98 • Bw'S Original 99-00
(R.O. 4SBH39121000)



18 410 0491



(SX) 125: Xn Teo'S 00-01 • Yp Majesty 99-00
(SX) 150: Xn Teo'S 00-02 • Yp Majesty 00
(R.O. 5DSH39120100)



● Terminale grosso - *Big end lever*
■ Colore nero - *Black*
□ Colore lucido - *Glossy*

GRI Grimeca
H.T. Heng Tong
BRE Brembo

DX Destra - *Right*
SX Sinistra - *Left*

LEVE
LEVERS



YAMAHA

18 410 0501 

(SX) 250: Yp Majesty 00-03 • Yp Majesty
(DX) 98-00 • Yp Majesty/Abs 00-06
(R.O. 5CG8391100)



18 410 0561 

(SX) 400: Yp Majesty 04-08
(SX) 500: Xp TMax/Ie/Abs/Black 01-07
(R.O. 5GJ839120000)



18 410 0621 

(SX) 125: Vp XCity 08-10 • Yp R XMax 06-10
(SX) 250: Vp XCity 07-10 • Yp R XMax/Black
05-10
(R.O. 1B9H39220000)



18 410 0781 

(SX) 125: Nxc Cygnus X 04-11
(R.O. 5MLH39121000)



18 410 0791 

(SX) 400: Yp Majesty 09-11
500: Xp T Max 08-11
530: Xp T Max 12-13
(R.O. 4B5839120000)



18 410 0801 

(SX) Bw's 100 99-01 • Yw Bw's 125 10
(R.O. 4VPH39121000)



18 410 1051 

(SX) 400: X-Max 13>
(R.O. 1SDH39120000)



18 412 0010 

(DX) 50: Bw'S Tamburo - *Drum*
(R.O. 3VLH39221000)



18 412 0151 

(DX) 50: Cr Z 9195 • Ya R Axis 95 • Ya Za Jog Z
95-96 • Ym Breeze 94-95
(R.O. 2NA839220100)



18 412 0161 

(DX) 50: Bw'S Original 97-98
(R.O. 4VVH39220000)



18 412 0171 

(DX) 50: Bw'S Bump 97-98 • Bw'S Ng 97-98
(R.O. 4SBH39220000)



18 412 0181 

(DX) 50: Cw Rs Spy 95-98
(R.O. 4TDH39220000)



18 412 0391 

(DX-SX) 50: Yq Aerox L/R/Eu2 97-08 • Yq Aerox
R Replica 08
(R.O. 5BRH39120100)



18 412 0401 

(DX) 50: Yn Neo'S/Eu2 97-06
(DX) 100: Yn Neo'S 00-01
(R.O. 5ADH39220100)



18 412 0471 

(DX) 50: Bw'S Original 99-00
(R.O. 4VVH39221000)





LEVE
LEVERS

YAMAHA

18 412 0481



(DX) 50: Bw'S 04-09 • Bw'S 10-11 • Bw'S Naked 04 • Bw'S Naked 09-11 • Bw'S Ng 01-06 • Cw Bw'S L 04 • Ew Slider 00-02
(R.O. 5JHH39220000)



18 412 0491



(DX) 50: Yh Why/Eu1/Eu2 98-09
(R.O. 5EUH39220000)



18 412 0511



(DX) 50: Bw'S Ng Cat 99-00
(R.O. 4SBH39221000)



18 412 0561



(DX) 400: Yp Majesty 04-08
(DX) 500: Xp TMax/Ie/Abs/Black 01-07
(R.O. 5GJ839220000)



18 412 0601



(DX-SX) 125: Xq Maxster 01-02 • Yp Majesty 01-09 • Yp Majesty E 01-09
(DX-SX) 150: Xq Maxster 01-02 • Yp Majesty 01-02
(SX) 300: Vp Versity/Xc 03-08
(R.O. 5DSH39220100)



18 412 0611



(DX) 250: Yp Majesty 00-03 • Yp Majesty **(DX) 98-00:** Yp Majesty/Abs 00-06
(R.O. 5CG839220100)



18 412 0751



(DX) 125: Vp XCity 08-10 • Yp R XMax 06-10
(DX) 250: Vp XCity 07-10 • Yp R XMax/Black 05-10
(R.O. 1B9H39120000)



18 412 0821



(DX) 50: Bw's Naked 03 • Bw's Original Eu 2 03 • Bw's Original 01-02 • Bw's R 01 • Cw Bw's Original Eu 2 02 • Cw L Bw's 03 • Cw Sp Bw's Original Eu 2 02
(R.O. 5NTH39220000)



18 412 0841



(DX-SX) 50: Yq Aerox 09-12
(R.O. 3C6H39120000)



18 412 0851



(DX) 400: Yp Majesty Abs 09-11 • Yp Majesty 09-11
500: Xp TMax Abs Sv 11 • Xp TMax Abs 08-11 • Xp TMax Sv 11 • Xp TMax White Max 10 • Xp TMax 08-11
530: Xp TMax Abs 12 • Xp TMax 12
(R.O. 4B5839220000)



18 412 0871



(DX) 125: Nxc Cygnus X 04-11
(R.O. 5MLH39220000)



18 412 0891



(DX) 50: Cs Jog R Eu 2 02-05 Cs Jog R 02-11
(R.O. 5RWH39220000)



18 412 1011



(DX) 400: X-Max 13>
(R.O. 1SDH39220000)



● Terminale grosso - *Big end lever*
 ■ Colore nero - *Black*
 □ Colore lucido - *Glossy*

GRI Grimeca
 H.T. Heng Tong
 BRE Brembo

DX Destra - *Right*
 SX Sinistra - *Left*

LEVE
LEVERS



CC	MODELLO - MODEL	ANNO YEAR	COLORE - COLOUR	SINISTRA - LEFT		IMPIANTO SYSTEM	TERMINALE TERMINAL	DESTRA - RIGHT		IMPIANTO SYSTEM	TERMINALE TERMINAL
				CODICE RMS RMS CODE	RIF. ORIGINALE OEM NUMBER			CODICE RMS RMS CODE	RIF. ORIGINALE OEM NUMBER		
APRILIA											
50	Amico	92	■	18 410 0010				18 412 0010			
50	Amico	94	■	18 410 0021	AP8218153						
50	Amico	96-98	■	18 410 0021	AP8218153			18 412 0021	AP8218156	Gri.	
50	Amico	96-98	□	18 410 0061	AP8218274			18 412 0051	AP8218273	Gri.	
50	Amico Gl-Gle	93-95	■	18 410 0021	AP8218153			18 412 0021	AP8218156		
50	Amico Lx- Sport-Cat	92-93	■	18 410 0021	AP8218153			18 412 0021	AP8218156		
50	Gulliver - S	95	■	18 410 0021	AP8218153						
50	Gulliver - T/V/W	96-98	□	18 410 0061	AP8218274						
50	Gulliver Lc	96-98	□	18 410 0061	AP8218274			18 412 0061	AP8218288	Gri.	
50	Mojito Retro - Habana	99-03	□	18 410 0061	AP8218274			18 412 0061	AP8218288	Gri.	
50	Mojito Custom 2T Mot. Piaggio	04-10	□	18 410 1001	AP8218495			18 412 0941	AP8218479		
50	Mojito Custom	99-03	□	18 410 1001	AP8218495			18 412 0941	AP8218479		
50	Rally	94-95	■	18 410 0021	AP8218153			18 412 0021	AP8218156	Gri.	
50	Rally	96-98	□	18 410 0061	AP8218274			18 412 0051	AP8218273	Gri.	
50	Rally	01-03	■	18 410 0021	AP8218153			18 412 0021	AP8218156	Gri.	
50	Rally Lc	96-99	□	18 410 0031	AP8213279			18 410 0031	AP8213279		
50	Scarabeo Tamb+Tamb	93-97	■	18 410 0041	AP8218176			18 412 0041	AP8218172		
50	Scarabeo Disc+Tamb	93-96	■	18 410 0041	AP8218176			18 412 0021	AP8218156	Gri.	
50	Scarabeo Disc+Tamb	97	□	18 410 0051	AP8218329			18 412 0051	AP8218273	Gri.	
50	Scarabeo Disc+Disc	98-05	□	18 410 0071	AP8118461			18 412 0051	AP8218273	Gri.	
50	Scarabeo Disc+Tamb	99-05	□	18 410 0051	AP8218329			18 412 0051	AP8218273	Gri.	
50	Scarabeo 4T	02-06	□					18 412 0051	AP8218273	Gri.	
50	Scarabeo 4T 4V Net	10	□					18 412 0931	AP8218640	H.T.	
50	Scarabeo 4T 4V	10-12	□					18 412 0711	497042	H.T.	
50	Scarabeo 4T Rst Eu3	06-09	□					18 412 0051	AP8218273	Gri.	
50	Scarabeo 4T Rst Eu3	06-09	□					18 412 0931	AP8218640	H.T.	
50	Scarabeo Ditech	01-04	□	18 410 0071	AP8118461			18 412 0051	AP8218273	Gri.	
50	Scarabeo 2T Net	10	□					18 412 0711	497042	H.T.	
50	Scarabeo 2T Net	09	□					18 412 0051	AP8218273	Gri.	
50	Scarabeo 2T Net	09	□					18 412 0931	AP8218640	H.T.	
50	Scarabeo 2T Eu2 Mot. Piaggio	10-12	□					18 412 0711	497042	H.T.	
50	Scarabeo Quattro	09	□					18 412 0051	AP8218273	Gri.	
50	Scarabeo Quattro	09	□					18 412 0931	AP8218640	H.T.	
50	Scarabeo Street	05-06	□					18 412 0051	AP8218273	Gri.	
50	Scarabeo Street	05-06	□					18 412 0931	AP8218640	H.T.	
50	Scarabeo Street 2T Rst	06-09	□					18 412 0051	AP8218273	Gri.	
50	Scarabeo Street 2T Rst	06-09	□					18 412 0931	AP8218640	H.T.	
50	Sonic	98-07	□	18 410 0061	AP8218274			18 412 0061	AP8218288	Gri.	
50	Sonic Gp	98-08	□	18 410 0061	AP8218274			18 412 0061	AP8218288	Gri.	
50	Sport City One 2T/4T	08-11	■	18 410 0861	564681			18 412 0651	497041	H.T.	
50	Sr	93-95	■	18 410 0021	AP8218153			18 412 0021	AP8218156	Gri.	
50	Sr	96	□	18 410 0061	AP8218274			18 412 0051	AP8218273	Gri.	
50	Sr Motard	12-13	■	18 410 0861	564681			18 412 0651	497041	H.T.	
50	Sr Ditech Eu2	02-03	■	18 412 0501	AP8218549	Gri.		18 412 0501	AP8218549	Gri.	
50	Sr H2O Ditech E Carb.	00-03	■	18 410 0021	AP8218153			18 412 0501	AP8218549	Gri.	
50	Sr H2O Ditech E Carb.	00-03	■	18 412 0501	AP8218549	Gri.		18 412 0501	AP8218549	Gri.	
50	Sr Liquid Cooled	94-95	■	18 410 0021	AP8218153			18 412 0021	AP8218156	Gri.	
50	Sr Liquid Cooled	96	□	18 410 0061	AP8218274			18 412 0051	AP8218273	Gri.	



LEVE LEVERS

CC	MODELLO - MODEL	ANNO YEAR	COLORE - COLOUR	SINISTRA - LEFT		IMPIANTO SYSTEM	TERMINALE TERMINAL	DESTRA - RIGHT		IMPIANTO SYSTEM	TERMINALE TERMINAL
				CODICE RMS RMS CODE	RIF. ORIGINALE OEM NUMBER			CODICE RMS RMS CODE	RIF. ORIGINALE OEM NUMBER		
50	Sr R Factory Ie E Carb.	10-14	■	18 410 0571	AP8213601	H.T.		18 410 0571	AP8213602	H.T.	
50	Sr R Factory Ie E Carb.	10-11	■	18 410 0581	AP8590035	Gri.		18 410 0581	AP8590035	Gri.	
50	Sr R Factory Mot Aprilia	05	■	18 410 0571	AP8213601	H.T.		18 410 0571	AP8213601	H.T.	
50	Sr R Factory Mot Aprilia	05	■	18 410 0581	AP8590035	Gri.		18 410 0581	AP8590035	Gri.	
50	Sr R R Factory	04-09	■	18 410 0571	AP8213601	H.T.		18 410 0571	AP8213601	H.T.	
50	Sr R R Factory	04-09	■	18 410 0581	AP8590035	Gri.		18 410 0581	AP8590035	Gri.	
50	Sr Stealth, Racing	97-99	□	18 410 0061	AP8218274			18 412 0061	AP8218288	Gri.	
50	Sr Stealth, Racing	97	□	18 412 0061	AP8218288	Gri.		18 412 0061	AP8218288	Gri.	
50	Sr Street	03-11	■	18 412 0501	AP8218549	Gri.		18 412 0501	AP8218549	Gri.	
50	Sr Street	03-12	■	18 412 0971	AP8213597			18 412 0971	AP8213597		
50	Sr Www	97-99	□	18 410 0061	AP8218274			18 412 0061	AP8218288	Gri.	
50	Sr Iniezione/Carburatore	14	■	18 412 0661	600475	H.T.		18 412 0661	600475	H.T.	
50	Sr R Factory Iniezione/Carburatore	10-14	■	18 412 0661	600475	H.T.		18 412 0661	600475	H.T.	
50	Sr Street	03-12	■	18 412 0661	600475	H.T.		18 412 0661	600475	H.T.	
100	Scarabeo 4T	01-04	□					18 412 0051	AP8218273	Gri.	
100	Scarabeo 4T	10-12	□					18 412 0711	497042	H.T.	
100	Scarabeo 4T Net	10	□					18 412 0051	AP8218273	Gri.	
100	Scarabeo 4T Net Eu3	10	□					18 412 0931	AP8218640	H.T.	
100	Scarabeo 4T Rst	06-09	□					18 412 0711	497042	H.T.	
100	Scarabeo Mot Minarelli	00	□	18 410 0051	AP8218329			18 412 0051	AP8218273	Gri.	
125	Leonardo	96-98	□	18 410 0071	AP8118461			18 412 0051	AP8218273	Gri.	
125	Sport City Eu3	06-08	■	18 410 0571	AP8213601	H.T.		18 410 0571	AP8213602	H.T.	
125	Sport City Eu3	06-08	■	18 410 0581	AP8590035	Gri.		18 410 0581	AP8590035	Gri.	
125	Mojito	08	□	18 410 1001	AP8218495			18 412 0941	AP8218479	Gri.	
125	Mojito Custom	99-07	□	18 410 1001	AP8218495			18 412 0941	AP8218479	Gri.	
125	Mojito Retro'	99-07	□	18 410 0061	AP8218274			18 412 0061	AP8218288	Gri.	
125	Scarabeo Mot Rotax	99-01	□	18 412 0521	AP8118542			18 412 0521	AP8118542		
125	Sport City	04-06	■	18 410 0571	AP8213601	H.T.		18 410 0571	AP8213602	H.T.	
125	Sport City	04-06	■	18 410 0581	AP8590035	Gri.		18 410 0581	AP8590035	Gri.	
125	Sport City One 4T Eu3	08-11	■	18 410 0861	564681			18 412 0651	497041	H.T.	
125	Sr	00	■	18 410 0021	AP8218153			18 412 0501	AP8218549	Gri.	
125	Sr	99	□	18 410 0061	AP8218274			18 412 0061	AP8218288	Gri.	
125	Sr Motard	12-13	■	18 410 0861	564681			18 412 0651	497041	H.T.	
125	Atlantic Eu3	06-08	■	18 410 0771	AP8133809	H.T.		18 410 0771	AP8133809	H.T.	
125	Atlantic Eu3	10-12	■	18 410 0771	AP8133809	H.T.		18 410 0771	AP8133809	H.T.	
125	Atlantic	03-05	■	18 410 0771	AP8133809	H.T.		18 410 0771	AP8133809	H.T.	
125	Scarabeo Ie Light	11-12	■	18 410 0771	AP8133809	H.T.		18 410 0771	AP8133809	H.T.	
125	Scarabeo Ie Light	09-10	■	18 410 0771	AP8133809	H.T.		18 410 0771	AP8133809	H.T.	
125	Scarabeo Light	07-08	■	18 410 0771	AP8133809	H.T.		18 410 0771	AP8133809	H.T.	
125	Scarabeo Mot. Piaggio Eu3	06	■	18 410 0771	AP8133809	H.T.		18 410 0771	AP8133809	H.T.	
125	Scarabeo	04-06	■	18 410 0771	AP8133809	H.T.		18 410 0771	AP8133809	H.T.	
125	Sport City Cube	08-10	■	18 410 0771	AP8133809	H.T.		18 410 0771	AP8133809	H.T.	
125	Sr Max	11-14	■	18 412 0661	600475	H.T.		18 412 0661	600475	H.T.	
150	Leonardo	96-98	□	18 410 0071	AP8118461			18 412 0051	AP8218273	Gri.	
150	Sr	00	■	18 410 0021	AP8218153			18 412 0501	AP8218549	Gri.	
150	Sr	99	□	18 410 0061	AP8218274			18 412 0061	AP8218288	Gri.	

● Terminale grosso - Big end lever
 ■ Colore nero - Black
 □ Colore lucido - Glossy

GRI Grimeca
 H.T. Heng Tong
 BRE Brembo

DX Destra - Right
 SX Sinistra - Left

LEVE
LEVERS



CC	MODELLO - MODEL	ANNO YEAR	COLORE - COLOUR	SINISTRA - LEFT		IMPIANTO SYSTEM	TERMINALE TERMINAL	DESTRA - RIGHT		IMPIANTO SYSTEM	TERMINALE TERMINAL
				CODICE RMS RMS CODE	RIF. ORIGINALE OEM NUMBER			CODICE RMS RMS CODE	RIF. ORIGINALE OEM NUMBER		
200	Scarabeo Mot Rotax	99-01	□	18 412 0521	AP8118542			18 412 0521	AP8118542		
200	Sport City	04-06	■	18 410 0571	AP8213601	H.T.		18 410 0571	AP8213602	H.T.	
200	Sport City	04-06	■	18 410 0581	AP8590035	Gri.		18 410 0581	AP8590035	Gri.	
200	Scarabeo le Light	11-12	■	18 410 0771	AP8133809	H.T.		18 410 0771	AP8133809	H.T.	
250	Leonardo	99-04	□	18 412 0531	AP8218480			18 412 0531	AP8218480		
250	Atlantic Eu3	06-08	■	18 410 0771	AP8133809	H.T.		18 410 0771	AP8133809	H.T.	
250	Scarabeo Light	06-08	■	18 410 0771	AP8133809	H.T.		18 410 0771	AP8133809	H.T.	
250	Sport City Cube	08-10	■	18 410 0771	AP8133809	H.T.		18 410 0771	AP8133809	H.T.	
300	Sport City Street	12	■	18 410 0571	AP8213601	H.T.		18 410 0571	AP8213602	H.T.	
300	Atlantic	10-11	■	18 410 0771	AP8133809	H.T.		18 410 0771	AP8133809	H.T.	
300	Scarabeo Light	09-10	■	18 410 0771	AP8133809	H.T.		18 410 0771	AP8133809	H.T.	
300	Sr Max	11-14	■	18 412 0661	600475	H.T.		18 412 0661	600475	H.T.	
400	Atlantic Sprint	05-08	■	18 410 0771	AP8133809	H.T.		18 410 0771	AP8133809	H.T.	
400	Scarabeo Light	06-08	■	18 410 0771	AP8133809	H.T.		18 410 0771	AP8133809	H.T.	
500	Atlantic	01-04	□	18 412 0521	AP8118542			18 412 0521	AP8118542		
500	Scarabeo	03-06	□	18 412 0521	AP8118542			18 412 0521	AP8118542		
500	Atlantic Sprint	05-08	■	18 410 0771	AP8133809	H.T.		18 410 0771	AP8133809	H.T.	
500	Scarabeo Light	06-08	■	18 410 0771	AP8133809	H.T.		18 410 0771	AP8133809	H.T.	
660	Pegaso Strada (Fun) - T	05-09	□					18 412 0841	AP8218479		
DERBI											
50	Boulevard 2T	09-10	□	18 410 0601	564683		●	18 412 0731	646803	Gri.	●
50	Boulevard 4T	09-10	□	18 410 0601	564683		●	18 412 0731	646803	Gri.	●
50	Boulevard 2T	09-10	□	18 410 0601	564683		●	18 412 0652	646833	H.T.	
50	Boulevard 4T	09-10	□	18 410 0601	564683		●	18 412 0711	497042	H.T.	
50	Sonar 2T	10-11	□	18 410 0601	564683		●	18 412 0652	646833	H.T.	
50	Variant Sport 2T	12	■	18 410 0861	564681			18 412 0651	497041	H.T.	
100	Boulevard 4T	10	□	18 410 0601	564683		●	18 412 0731	646803	Gri.	●
100	Boulevard 4T	10	□	18 410 0601	564683		●	18 412 0652	646833	H.T.	
125	Variant Sport 4T Eu3	12	■	18 410 0861	564681			18 412 0651	497041	H.T.	
125	Boulevard	02-07	■	18 410 0861	564681						
125	Rambla -Eu3 - II Vers.	08-09	■	18 410 0581	AP8590035	Gri.		18 410 0581	AP8590035	Gri.	
125	Rambla -Eu3 - II Vers.	08-09	■	18 410 0571	AP8213601	H.T.		18 410 0571	AP8213602	H.T.	
125	Sonar 4T	09	□	18 410 0601	564683		●	18 412 0711	497042	H.T.	
150	Boulevard Euro 3 - II Vers.	10	□	18 410 0601	564683		●	18 412 0731	646803	Gri.	●
150	Boulevard Euro 3	10	□	18 410 0601	564683		●	18 412 0711	497042	H.T.	
150	Boulevard	02-07	■	18 410 0861	564681						
150	Sonar 4T	09	□	18 410 0601	564683		●	18 412 0711	497042	H.T.	
200	Boulevard	05	■	18 410 0861	564681						
250	Rambla -Eu3 - II Vers.	08-09	■	18 410 0581	AP8590035	Gri.		18 410 0581	AP8590035	Gri.	
250	Rambla -Eu3 - II Vers.	08-09	■	18 410 0571	AP8213601	H.T.		18 410 0571	AP8213602	H.T.	
300	Rambla	10-11	■	18 410 0581	AP8590035	Gri.		18 410 0581	AP8590035	Gri.	
300	Rambla	10-11	■	18 410 0571	AP8213601	H.T.		18 410 0571	AP8213602	H.T.	
GILERA											
50	Dna	00-07	■	18 412 0721	497031	Bre.	●	18 412 0721	497031	Bre.	●
50	Dna	00-07	■	18 412 0661	600475	H.T.	●	18 412 0661	600475	H.T.	●
50	Dna	00-07	■	18 412 0601	646829 - 497031	Bre.		18 412 0601	646829 - 497031	Bre.	
50	Dna Gp Experience	03-04	■	18 412 0721	497031	Bre.	●	18 412 0721	497031	Bre.	●



LEVE LEVERS

CC	MODELLO - MODEL	ANNO YEAR	COLORE - COLOUR	SINISTRA - LEFT		IMPIANTO SYSTEM	TERMINALE TERMINAL	DESTRA - RIGHT		IMPIANTO SYSTEM	TERMINALE TERMINAL
				CODICE RMS RMS CODE	RIF. ORIGINALE OEM NUMBER			CODICE RMS RMS CODE	RIF. ORIGINALE OEM NUMBER		
50	Dna Gp Experience	03-04	■	18 412 0661	600475	H.T.	●	18 412 0661	600475	H.T.	●
50	Dna Gp Experience	03-04	■	18 412 0601	646829 - 497031	Bre.		18 412 0601	646829 - 497031	Bre.	
50	Easy Moving	95-96	■	18 410 0111	564689			18 412 0231	494951		
50	Ice	01-05	■	18 410 0851	647552			18 412 0721	497031	Bre.	●
50	Ice	01-05	■					18 412 0601	646829 - 497031	Bre.	
50	Runner	97-00	■	18 412 0111	494952	Gri.		18 412 0111	494952	Gri.	
50	Runner Disco Ant./Tamb. Post	97-00	■					18 412 0111	494952	Gri.	
50	Runner Poggiali	02	■	18 412 0111	494952	Gri.		18 412 0111	494952	Gri.	
50	Runner Poggiali	02	■	18 412 0651	497041	H.T.		18 412 0651	497041	H.T.	
50	Runner Purejet	02-04	■	18 412 0111	494952	Gri.		18 412 0111	494952	Gri.	
50	Runner Purejet	02-04	■	18 412 0651	497041	H.T.		18 412 0651	497041	H.T.	
50	Runner Purejet	05-10	□	18 412 0711	497042	H.T.	●	18 412 0711	497042	H.T.	●
50	Runner Purejet	05-10	□	18 412 0652	646833	H.T.		18 412 0652	646833	H.T.	
50	Runner Purejet St	08	□	18 412 0711	497042	H.T.	●	18 412 0711	497042	H.T.	●
50	Runner Purejet St	08	□	18 412 0652	646833	H.T.		18 412 0652	646833	H.T.	
50	Runner Sp	02-04	■	18 412 0111	494952	Gri.		18 412 0111	494952	Gri.	
50	Runner Sp	05-07	□	18 412 0711	497042	H.T.	●	18 412 0711	497042	H.T.	●
50	Runner Sp	05-07	□	18 412 0652	646833	H.T.		18 412 0652	646833	H.T.	
50	Runner Sp	10	□	18 412 0652	646833	H.T.		18 412 0652	646833	H.T.	
50	Runner Sp	10	□	18 412 0711	497042	H.T.	●	18 412 0711	497042	H.T.	●
50	Runner Sp Spec Edit	07	□	18 412 0652	646833	H.T.		18 412 0711	497042	H.T.	
50	Runner Sp Spec Edit	07	□	18 412 0711	497042	H.T.	●	18 412 0731	646803	Gri.	●
50	Runner Sp Spec Edit	07	□	18 412 0711	497042	H.T.	●	18 412 0711	497042	H.T.	●
50	Runner Sp Spec Edit	07	□	18 412 0652	646833	H.T.		18 412 0652	646833	H.T.	
50	Runner Sp St & Simoncell	08-09	□	18 412 0652	646833	H.T.		18 412 0652	646833	H.T.	
50	Runner Sp St & Simoncell	08-09	□	18 412 0711	497042	H.T.	●	18 412 0711	497042	H.T.	●
50	Stalker	97-00	■	18 412 0111	494952	Gri.		18 412 0111	494952	Gri.	
50	Stalker	97-06	■	18 410 0531	562450			18 412 0111	494952	Gri.	
50	Stalker	97-06	■	18 410 0591	564682		●	18 412 0111	494952	Gri.	
50	Stalker	07-09	■	18 410 0591	564682		●	18 412 0651	497041	H.T.	
50	Stalker	07-09	■	18 410 0531	562450			18 412 0651	497041	H.T.	
50	Stalker Naked	08	■	18 410 0851	647552			18 412 0661	600475	H.T.	●
50	Stalker Spec Edit	07-08	■	18 410 0531	562450			18 412 0651	497041	H.T.	
50	Stalker Spec Edit	07-08	■	18 410 0591	564682		●	18 412 0651	497041	H.T.	
50	Storm	94-95	■	18 410 0111	564689			18 412 0091	564690		
50	Storm Eu2	07	□	18 410 0181	564683			18 412 0652	646833	H.T.	
50	Storm Eu2	07	□	18 410 0181	564683			18 412 0711	497042	H.T.	●
50	Typhoon	94-97	■	18 410 0111	564689			18 412 0091	564690		
50	Typhoon X	98-99	■	18 410 0111	564689			18 412 0091	564690		
50	Typhoon Xr	00	■	18 410 0111	564689			18 412 0091	564690		
125	Dna	01	■	18 412 0721	497031	Bre.	●	18 412 0721	497031	Bre.	●
125	Dna	01	■	18 412 0601	646829 - 497031	Bre.		18 412 0601	646829 - 497031	Bre.	
125	Nexus Eu3	07-08	■	18 412 0661	600475	H.T.	●	18 412 0661	600475	H.T.	●
125	Nexus Eu3 le	08-10	■	18 412 0661	600475	H.T.	●	18 412 0661	600475	H.T.	●
125	Runner Fx-Fxr	97-02	□	18 410 0181	564683			18 412 0652	646833	H.T.	
125	Runner Fx-Fxr	97-02	□	18 412 0711	497042	H.T.	●	18 412 0711	497042	H.T.	●
125	Runner Fx-Fxr	97-02	□	18 410 0601	564683		●	18 412 0711	497042	H.T.	●

● Terminale grosso - Big end lever
 ■ Colore nero - Black
 □ Colore lucido - Glossy

GRI Grimeca
 H.T. Heng Tong
 BRE Brembo

DX Destra - Right
 SX Sinistra - Left

LEVE
LEVERS



CC	MODELLO - MODEL	ANNO YEAR	COLORE - COLOUR	SINISTRA - LEFT		IMPIANTO SYSTEM	TERMINALE TERMINAL	DESTRA - RIGHT		IMPIANTO SYSTEM	TERMINALE TERMINAL
				CODICE RMS RMS CODE	RIF. ORIGINALE OEM NUMBER			CODICE RMS RMS CODE	RIF. ORIGINALE OEM NUMBER		
125	Runner Fx-Fxr	97-02	■	18 412 0651	497041	H.T.		18 412 0651	497041	H.T.	
125	Runner Fx-Fxr	97-02	■	18 412 0111	494952	Gri.		18 412 0111	494952	Gri.	
125	Runner Fx-Fxr	97-02	■					18 412 0111	494952	Gri.	
125	Runner Vx	05-06	□	18 412 0711	497042	H.T.	●	18 412 0711	497042	H.T.	●
125	Runner Vx	05-06	□	18 412 0652	646833	H.T.		18 412 0652	646833	H.T.	
125	Runner Vx	05-06	□	18 412 0731	646803	Gri.	●	18 412 0731	646803	Gri.	●
125	Runner Vx 4T Eu3	07	□	18 412 0711	497042	H.T.	●	18 412 0711	497042	H.T.	●
125	Runner Vx 4T Eu3	07	□	18 412 0652	646833	H.T.		18 412 0652	646833	H.T.	
125	Runner Vx 4T St Eu3	08-09	□	18 412 0711	497042	H.T.	●	18 412 0711	497042	H.T.	●
125	Runner Vx 4T St Eu3	08-09	□	18 412 0652	646833	H.T.		18 412 0652	646833	H.T.	
125	Runner Vx Race	06	□	18 412 0731	646803	Gri.	●	18 412 0731	646803	Gri.	●
125	Runner Vx Race	06	□	18 412 0711	497042	H.T.	●	18 412 0711	497042	H.T.	●
125	Runner Vx Race	06	□	18 412 0652	646833	H.T.		18 412 0652	646833	H.T.	
125	Runner Vx Sc	06-07	□	18 412 0731	646803	Gri.	●	18 412 0711	497042	H.T.	●
125	Runner Vx-Vxr	00-01	□	18 412 0711	497042	H.T.	●	18 412 0711	497042	H.T.	●
125	Runner Vx-Vxr	00-01	□	18 412 0652	646833	H.T.		18 412 0652	646833	H.T.	
125	Runner Vx-Vxr	00-01	■	18 412 0651	497041	H.T.		18 412 0651	497041	H.T.	
125	Typhoon	95-98	■					18 412 0101	271449		
125	Typhoon X-Xr	99-00	■					18 412 0101	271449		
180	Dna	01	■	18 412 0721	497031	Bre.	●	18 412 0721	497031	Bre.	●
180	Dna	01	■	18 412 0601	646829 - 497031	Bre.		18 412 0601	646829 - 497031	Bre.	
180	Runner Fx-Fxr	97-02	□	18 410 0181	564683			18 412 0652	646833	H.T.	
180	Runner Fx-Fxr	97-02	□	18 412 0711	497042	H.T.	●	18 412 0711	497042	H.T.	●
180	Runner Fx-Fxr	97-02	□	18 410 0601	564683		●	18 412 0711	497042	H.T.	●
180	Runner Fx-Fxr	97-02	■	18 412 0651	497041	H.T.		18 412 0651	497041	H.T.	
180	Runner Fx-Fxr	97-02	■	18 412 0111	494952	Gri.		18 412 0111	494952	Gri.	
180	Runner Fx-Fxr	97-02	■					18 412 0111	494952	Gri.	
180	Runner Vx-Vxr	00-04	□	18 412 0711	497042	H.T.	●	18 412 0711	497042	H.T.	●
180	Runner Vx-Vxr	00-04	□	18 412 0652	646833	H.T.		18 412 0652	646833	H.T.	
180	Runner Vx-Vxr	00-04	■	18 412 0111	494952	Gri.		18 412 0111	494952	Gri.	
200	Runner Vxr	05-06	□	18 412 0711	497042	H.T.	●	18 412 0711	497042	H.T.	●
200	Runner Vxr	05-06	□	18 412 0652	646833	H.T.		18 412 0652	646833	H.T.	
200	Runner Vxr	05-06	□	18 412 0731	646803	Gri.	●	18 412 0731	646803	Gri.	●
200	Runner Vxr 4T St Eu3	08	□	18 412 0711	497042	H.T.	●	18 412 0711	497042	H.T.	●
200	Runner Vxr 4T St Eu3	08	□	18 412 0652	646833	H.T.		18 412 0652	646833	H.T.	
200	Runner Vxr Eu3	07	□	18 412 0711	497042	H.T.	●	18 412 0711	497042	H.T.	●
200	Runner Vxr Eu3	07	□	18 412 0652	646833	H.T.		18 412 0652	646833	H.T.	
200	Runner Vxr Eu3	07	□	18 412 0731	646803	Gri.	●	18 412 0731	646803	Gri.	●
200	Runner Vxr Race	06	□	18 412 0711	497042	H.T.	●	18 412 0711	497042	H.T.	●
200	Runner Vxr Race	06	□	18 412 0652	646833	H.T.		18 412 0652	646833	H.T.	
200	Runner Vxr Race	06	□	18 412 0731	646803	Gri.	●	18 412 0731	646803	Gri.	●
250	Beverly Cruiser	07-09	□	18 410 0841	649196	Bre.		18 410 0841	649196	Bre.	
250	Nexus Eu3	06-07	■	18 412 0661	600475	H.T.	●	18 412 0661	600475	H.T.	●
250	Nexus Sp Eu3	06-07	■	18 412 0661	600475	H.T.	●	18 412 0661	600475	H.T.	●
300	Nexus Eu3	08-09	■	18 412 0661	600475	H.T.	●	18 412 0661	600475	H.T.	●
500	Beverly Cruiser	07-12	□	18 410 0841	649196	Bre.		18 410 0841	649196	Bre.	
500	Fuoco Eu3	07-11	■	18 412 0661	600475	H.T.	●	18 412 0601	646829 - 497031	Bre.	



LEVE LEVERS

CC	MODELLO - MODEL	ANNO YEAR	COLORE - COLOUR	SINISTRA - LEFT		IMPIANTO SYSTEM	TERMINALE TERMINAL	DESTRA - RIGHT		IMPIANTO SYSTEM	TERMINALE TERMINAL
				CODICE RMS RMS CODE	RIF. ORIGINALE OEM NUMBER			CODICE RMS RMS CODE	RIF. ORIGINALE OEM NUMBER		
500	Fuoco Eu3	07-11	■	18 412 0661	600475	H.T.	●	18 412 0721	497031	Bre.	●
500	Nexus	03-05	■	18 412 0721	497031	Bre.	●	18 412 0721	497031	Bre.	●
500	Nexus	03-05	■	18 412 0601	646829	Bre.		18 412 0601	646829	Bre.	
500	Nexus Eu3	06-11	■	18 412 0721	497031	Bre.	●	18 412 0721	497031	Bre.	●
500	Nexus Eu3	06-11	■	18 412 0601	646829	Bre.		18 412 0601	646829	Bre.	
500	Nexus Sp Eu3	06-07	■	18 412 0721	497031	Bre.	●	18 412 0721	497031	Bre.	●
500	Nexus Sp Eu3	06-07	■	18 412 0601	646829	Bre.		18 412 0601	646829	Bre.	
HONDA											
50	Sh-fifty-balj-sh - Ft	>95	■	18 410 0341							
50	Sky - Fd		■	18 410 0371				18 412 0421			
50	Sh - Fd	96>	■	18 410 0381				18 412 0431			
50	Sfx		■	18 410 0391				18 412 0431			
50	Vision Pk Wallaro		■	18 410 0391							
50	Balj		■	18 410 0341				18 412 0441			
100	Balj		■	18 410 0341				18 412 0441			
125	Chiocciola - Sh-Dylan		□	18 410 0441				18 412 0541			
125	Sh I	09-10	□	18 410 0611				18 412 0741			
125	Pantheon		■	18 410 0451				18 412 0551			
150	Chiocciola - Sh-Dylan		□	18 410 0441				18 412 0541			
150	Sh I	09-10	□	18 410 0611				18 412 0741			
150	Pantheon		■	18 410 0451				18 412 0551			
250	Foresight		■	18 410 0451				18 412 0551			
300	Sh		□	18 410 0611				18 412 0741			
ITALJET											
50	Pista		■	18 410 0131							
50	Bazooka		■	18 410 0131							
50	Scoop		■	18 410 0131							
KYMCO											
50	Agility 4T R10	06-08	■	18 410 0711	00152580			18 412 0761	00153413		
50	Agility 4T R12	07-08	□	18 410 0481	00152161-00152050			18 412 0581	00153159		
50	Agility 4T R16	08	■	18 410 0721	00153308			18 412 0761	00153413		
50	Agility 4T R16	09	■	18 410 0721	00153308			18 412 0761	00153413		
50	Agility R12	05	□	18 410 0481	00152161-00152050			18 412 0581	00153159		
50	Agility Rs	09	□					18 412 0581	00153159		
50	Agility Rs Naked 2T	10	□					18 412 0581	00153159		
50	B&W	02	□					18 412 0571	00153960		
50	B&W Euro2	03	□					18 412 0571	00153960		
50	Dink 50 4T	07	■					18 412 0461	00156915		
50	Dink Classic Euro2	03	□					18 412 0571	00153960		
50	Dink Lc	99-02	□					18 412 0571	00153960		
50	Dj W	94-00	■	18 410 0131	00152020						
50	Dj X	91-92	■	18 410 0131	00152020						
50	Djy	93	■	18 410 0131	00152020						
50	Fever Zx	99-00	□	18 410 0481	00152161-00152050			18 412 0681	00153760		
50	Fever Zx Euro2	03-04	□	18 410 0481	00152161-00152050			18 412 0681	00153760		
50	Like 2T	09	□					18 412 0681	00153760		
50	Mxer	02-03	■	18 410 0461	00153984						

● Terminale grosso - Big end lever
 ■ Colore nero - Black
 □ Colore lucido - Glossy

GRI Grimeca
 H.T. Heng Tong
 BRE Brembo

DX Destra - Right
 SX Sinistra - Left

LEVE
LEVERS



CC	MODELLO - MODEL	ANNO YEAR	COLORE - COLOUR	SINISTRA - LEFT		IMPIANTO SYSTEM	TERMINALE TERMINAL	DESTRA - RIGHT		IMPIANTO SYSTEM	TERMINALE TERMINAL
				CODICE RMS RMS CODE	RIF. ORIGINALE OEM NUMBER			CODICE RMS RMS CODE	RIF. ORIGINALE OEM NUMBER		
50	Mxer Euro2	04	■	18 410 0461	00153984						
50	Mxu	06-07	■	18 410 0461	00153984						
50	Mxu Sr	06	■	18 410 0461	00153984						
50	People	99-00	□	18 410 0481	00152161-00152050			18 412 0581	00153159		
50	People	04	□	18 410 0481	00152161-00152050			18 412 0581	00153159		
50	People Euro2	03	□	18 410 0481	00152161-00152050			18 412 0581	00153159		
50	People Euro2	08-11	□	18 410 0481	00152161-00152050			18 412 0581	00153159		
50	People S	05-08	□	18 410 0741	00153759			18 412 0681	00153760		
50	People S 4T	06-08	□	18 410 0741	00153759			18 412 0681	00153760		
50	Sento	08	□	18 410 0481	00152161-00152050			18 412 0581	00153159		
50	Super 8	07	□	18 410 0741	00153759			18 412 0581	00153159		
50	Super 8 2T	09	□	18 410 0741	00153759			18 412 0581	00153159		
50	Super 8 4T	09	□	18 410 0741	00153759			18 412 0581	00153159		
50	Super 9	00	□	18 410 0541	00153782			18 412 0681	00153760		
50	Super 9 Sport Euro2	03-04	□	18 410 0541	00153782			18 412 0681	00153760		
50	Top Boy	97-00	■	18 410 0711	00152580			18 412 0761	00153413		
50	Vitality 2T	04	□	18 410 0481	00152161-00152050			18 412 0581	00153159		
50	Vitality 4T	04	□	18 410 0481	00152161-00152050			18 412 0581	00153159		
50	Yup Euro2	03	□	18 410 0481	00152161-00152050			18 412 0581	00153159		
125	Agility 4T	06	□	18 410 0481	00152161-00152050			18 412 0581	00153159		
125	Agility 4T Euro3	06-08	□	18 410 0481	00152161-00152050			18 412 0581	00153159		
125	Agility R16	08-09	■	18 410 0751	00153414			18 412 0761	00153413		
125	Agility Rs	09	□					18 412 0581	00153159		
125	B&W	00	□	18 410 0471	00153977			18 412 0571	00153960		
125	B&W Euro2	03-04	□	18 410 0471	00153977			18 412 0571	00153960		
125	Dink Euro3	06-07	■	18 410 0461	00153984			18 412 0461	00156915		
125	Dink	97-98	■	18 410 0461	00153984			18 412 0461	00156915		
125	Dink Classic	02	□	18 410 0471	00153977			18 412 0571	00153960		
125	Dink Classic Euro2	03	□	18 410 0471	00153977			18 412 0571	00153960		
125	Dink Lx	98-00	□	18 410 0471	00153977			18 412 0571	00153960		
125	Downtown I	09	□	18 410 0761	00153298			18 412 0801	00153297		
125	Grand Dink	01-02	□	18 410 0471	00153977			18 412 0571	00153960		
125	Grand Dink Euro2	03-04	□	18 410 0471	00153977			18 412 0571	00153960		
125	Like	09	□	18 410 0541	00153782			18 412 0681	00153760		
125	Movie	99-00	□	18 410 0481	00152161-00152050			18 412 0681	00153760		
125	Movie 125 Euro3	06-07	□	18 410 0481	00152161-00152050			18 412 0681	00153760		
125	Movie XI	01	□	18 410 0481	00152161-00152050			18 412 0681	00153760		
125	Movie XI Euro2	03-04	□	18 410 0481	00152161-00152050			18 412 0681	00153760		
125	People	99-00	□	18 410 0481	00152161-00152050			18 412 0581	00153159		
125	People Euro2	03	□	18 410 0481	00152161-00152050			18 412 0581	00153159		
125	People Euro3	07-11	□	18 410 0481	00152161-00152050			18 412 0581	00153159		
125	People Gti	10	□	18 410 0471	00153977			18 412 0571	00153960		
125	People S	05	□	18 410 0481	00152161-00152050			18 412 0681	00153760		
125	People S Dd Euro3	07-08	□	18 410 0541	00153782			18 412 0681	00153760		
125	Super 8	08-09	□	18 410 0741	00153759			18 412 0581	00153159		
125	Vivio	00	□	18 410 0481	00152161-00152050			18 412 0681	00153760		
150	Agility R16	08	■	18 410 0751	00153414			18 412 0761	00153413		



LEVE LEVERS

CC	MODELLO - MODEL	ANNO YEAR	COLORE - COLOUR	SINISTRA - LEFT		IMPIANTO SYSTEM	TERMINALE TERMINAL	DESTRA - RIGHT		IMPIANTO SYSTEM	TERMINALE TERMINAL
				CODICE RMS RMS CODE	RIF. ORIGINALE OEM NUMBER			CODICE RMS RMS CODE	RIF. ORIGINALE OEM NUMBER		
150	Agility R16	09	■	18 410 0751	00153414			18 412 0761	00153413		
150	B&W	00	□	18 410 0471	00153977			18 412 0571	00153960		
150	B&W Euro2	03-04	□	18 410 0471	00153977			18 412 0571	00153960		
150	Dink	97-98	■	18 410 0461	00153984			18 412 0461	00156915		
150	Dink Classic - Eu2	02-03	□	18 410 0471	00153977			18 412 0571	00153960		
150	Dink Lx	98-00	□	18 410 0471	00153977			18 412 0571	00153960		
150	Grand Dink	01-02	□	18 410 0471	00153977			18 412 0571	00153960		
150	Grand Dink Euro2	03-04	□	18 410 0471	00153977			18 412 0571	00153960		
150	Movie Euro3	06-07	□	18 410 0481	00152161-00152050			18 412 0681	00153760		
150	People	99-00	□	18 410 0481	00152161-00152050			18 412 0581	00153159		
150	People Euro2	03	□	18 410 0481	00152161-00152050			18 412 0581	00153159		
200	Agility I R16	10	■	18 410 0751	00153414			18 412 0761	00153413		
200	Dink Classic	04	□	18 410 0471	00153977			18 412 0571	00153960		
200	Dink Euro3l	06-07	■	18 410 0461	00153984			18 412 0461	00156915		
200	Downtown I	10	□	18 410 0761	00153298			18 412 0801	00153297		
200	Like 200l	09	□	18 410 0541	00153782			18 412 0681	00153760		
200	People Gti	10	□	18 410 0471	00153977			18 412 0571	00153960		
200	People S	05	□	18 410 0481	00152161-00152050			18 412 0681	00153760		
200	People S 200l	07	□	18 410 0541	00153782			18 412 0681	00153760		
250	B&W	00	□	18 410 0471	00153977			18 412 0571	00153960		
250	B&W Euro2	03	□	18 410 0471	00153977			18 412 0571	00153960		
250	Grand Dink	01-02	□	18 410 0471	00153977			18 412 0571	00153960		
250	Grand Dink Euro2	03-04	□	18 410 0471	00153977			18 412 0571	00153960		
250	People Lc	03-04	□	18 410 0471	00153977			18 412 0571	00153960		
250	People S	06	□	18 410 0471	00153977			18 412 0571	00153960		
250	People S 250l	07	□	18 410 0471	00153977			18 412 0571	00153960		
250	Yup	03	□	18 410 0471	00153977			18 412 0571	00153960		
300	Downtown I	09	□	18 410 0761	00153298			18 412 0801	00153297		
300	Downtown Abs	10	□	18 410 0761	00153298			18 412 0801	00153297		
300	Downtown I Abs	11	□	18 410 0761	00153298			18 412 0801	00153297		
300	Downtown I	11	□	18 410 0761	00153298			18 412 0801	00153297		
300	People Gti	10	□	18 410 0471	00153977			18 412 0571	00153960		
300	People S 300l	08	□	18 410 0471	00153977			18 412 0571	00153960		
300	X Citing I R	08	□	18 410 0761	00153298			18 412 0801	00153297		
300	X Citing I R	09	□	18 410 0761	00153298			18 412 0801	00153297		
300	X Citing I	08	□	18 410 0761	00153298			18 412 0801	00153297		
700	Myroad I	11	□	18 410 0761	00153298			18 412 0801	00153297		
LEM											
50	Flash		■	18 410 0131							
50	Tornado		■	18 410 0131							
MALAGUTI											
50	Centro 4T	08	■	18 410 0651	12120903			18 412 0771	12121003		
50	Centro Base	93-94	■	18 410 0131	12112103						
50	Centro SI	94-95	■	18 410 0131	12112103			18 412 0411	12113203		
50	Centro SI	96-98	■	18 410 0361	12113303			18 412 0411	12113203		
50	Centro SI 4T	10	■	18 410 0651	12120903			18 412 0771	12121003		
50	Centro SI Kat	99-00	■	18 410 0361	12113303			18 412 0411	12113203		

● Terminale grosso - Big end lever
 ■ Colore nero - Black
 □ Colore lucido - Glossy

GRI Grimeca
 H.T. Heng Tong
 BRE Brembo

DX Destra - Right
 SX Sinistra - Left

LEVE
LEVERS



CC	MODELLO - MODEL	ANNO YEAR	COLORE - COLOUR	SINISTRA - LEFT		IMPIANTO SYSTEM	TERMINALE TERMINAL	DESTRA - RIGHT		IMPIANTO SYSTEM	TERMINALE TERMINAL
				CODICE RMS RMS CODE	RIF. ORIGINALE OEM NUMBER			CODICE RMS RMS CODE	RIF. ORIGINALE OEM NUMBER		
50	Ciak	99-00	■	18 410 0361	12113303			18 412 0411	12113203		
50	Ciak Master	04	■	18 410 0361	12113303			18 412 0411	12113203		
50	Ciak Master 4T	05-06	■	18 410 0361	12113303			18 412 0411	12113203		
50	Ciak Master Euro 2	06	■	18 410 0361	12113303			18 412 0411	12113203		
50	Ciak Mono Euro 2	03	■	18 410 0361	12113303			18 412 0411	12113203		
50	Ciak Mono Euro 2 2.3	03	■	18 410 0361	12113303			18 412 0411	12113203		
50	Ciak Td	00-01	■	18 410 0631	12114203			18 412 0411	12113203		
50	Crosser Cr1	95-98	■	18 410 0361	12113303			18 412 0411	12113203		
50	F10 Ac	08	■	18 410 0361	12113303			18 412 0411	12113203		
50	F10 Ac Eco	09-10	■	18 410 0361	12113303			18 412 0771	12121003		
50	F10 Jet Line	92-93	■	18 410 0131	12112103			18 412 0411	12113203		
50	F10 Jet Line	94-98	■	18 410 0361	12113303			18 412 0411	12113203		
50	F10 Kat	99-00	■	18 410 0361	12113303			18 412 0411	12113203		
50	F10 Rst Eu1	01-02	■	18 410 0361	12113303			18 412 0411	12113203		
50	F10 Rst Eu2-2.3	03-04	■	18 410 0361	12113303			18 412 0411	12113203		
50	F10 Rst Euro 2	02-03	■	18 410 0361	12113303			18 412 0411	12113203		
50	F10 Rst Euro 2	06	■	18 410 0361	12113303			18 412 0411	12113203		
50	F12 Aria Rst Euro 2	06	■	18 410 0361	12113303			18 412 0411	12113203		
50	F12 Lc Rst Euro 2	06	■	18 410 0631	12114203			18 412 0411	12113203		
50	F12 Phantom	94-98	■	18 410 0361	12113303			18 412 0411	12113203		
50	F12 Phantom Euro1	99-00	■	18 410 0361	12113303			18 412 0411	12113203		
50	F12 Phantom Lc	94-98	■	18 410 0361	12113303			18 412 0411	12113203		
50	F12 Phantom Lc Euro1	99-00	■	18 410 0631	12114203			18 412 0411	12113203		
50	F12 Phantom Lc Rst Eu1	01-02	■	18 410 0631	12114203			18 412 0411	12113203		
50	F12 Phantom Lc Rst Eu2	02	■	18 410 0631	12114203			18 412 0411	12113203		
50	F12 Phantom Lc Rst Eu2-2.3	03-04	■	18 410 0631	12114203			18 412 0411	12113203		
50	F12 Phantom Lc Twin Disks	98	■	18 410 0631	12114203			18 412 0411	12113203		
50	F12 Phantom Rst Eu1	01-02	■	18 410 0361	12113303			18 412 0411	12113203		
50	F12 Phantom Rst Eu2	02	■	18 410 0361	12113303			18 412 0411	12113203		
50	F12 Phantom Rst Eu2-2.3	03-04	■	18 410 0361	12113303			18 412 0411	12113203		
50	F12R Phantom Ac	07-08	■	18 410 0671	12120703			18 412 0411	12113203		
50	F12R Phantom Ac	09-10	■	18 410 0651	12120903			18 412 0771	12121003		
50	F12R Phantom Lc	07-10	■	18 410 0631	12114203			18 412 0411	12113203		
50	F12R Phantom Lc (Da Manubrio ZJM5883)	07-10	■	18 410 0641	12121103			18 412 0771	12121003		
50	F15 Fire Fox	96-98	■	18 410 0631	12114203			18 412 0411	12113203		
50	F15 Fire Fox Air Cooled	05-06	■	18 410 0361	12113303			18 412 0411	12113203		
50	F15 Fire Fox Euro2	02-03	■	18 410 0631	12114203			18 412 0411	12113203		
50	F15 Fire Fox Rst Euro2-2.3	03-04	■	18 410 0631	12114203			18 412 0411	12113203		
50	F15 Fire Fox Twin Disks & Spec.	98-99	■	18 410 0631	12114203			18 412 0411	12113203		
50	F15 Fire Fox Twin Disks Kat	98-00	■	18 410 0631	12114203			18 412 0411	12113203		
50	F15 Lc Rst Euro 2	04-05	■	18 410 0631	12114203			18 412 0411	12113203		
50	F15 Lc-Tds Rst Euro 1	01	■	18 410 0631	12114203			18 412 0411	12113203		
50	Yesterday - Yesterday Euro	97-00	■	18 410 0361	12113303			18 412 0411	12113203		
100	Ciak	99-00	■	18 410 0631	12114203			18 412 0411	12113203		
100	F12 Phantom	99-00	■	18 410 0631	12114203			18 412 0411	12113203		
125	Blog	09-10	■	18 410 0661	12119803			18 412 0781	12119703		
125	Blog	11	■	18 410 0641	12121103			18 412 0771	12121003		



LEVE LEVERS

CC	MODELLO - MODEL	ANNO YEAR	COLORE - COLOUR	SINISTRA - LEFT		IMPIANTO SYSTEM	TERMINALE TERMINAL	DESTRA - RIGHT		IMPIANTO SYSTEM	TERMINALE TERMINAL
				CODICE RMS RMS CODE	RIF. ORIGINALE OEM NUMBER			CODICE RMS RMS CODE	RIF. ORIGINALE OEM NUMBER		
125	Centro le	08-09	■	18 410 0661	12119803			18 412 0781	12119703		
125	Centro SI	11	■	18 410 0641	12121103			18 412 0771	12121003		
125	Centro SI	09-10	■	18 410 0661	12119803			18 412 0781	12119703		
125	Ciak	00-01	■	18 410 0361	12113303			18 412 0411	12113203		
125	Ciak Master	04	■	18 410 0361	12113303			18 412 0411	12113203		
125	Ciak Master Euro 3	06	■	18 410 0361	12113303			18 412 0411	12113203		
125	Ciak Rst Euro2	03	■	18 410 0361	12113303			18 412 0411	12113203		
125	F18 Warrior	00-02	■	18 410 0631	12114203			18 412 0411	12113203		
125	Madison	99-01	■	18 412 0591	12114303			18 412 0591	12114303		
125	Madison 3	06-09	■	18 412 0591	12114303			18 412 0591	12114303		
125	Madison R Rst	02	■	18 412 0591	12114303			18 412 0591	12114303		
125	Madison R Rst Euro2	03-04	■	18 412 0591	12114303			18 412 0591	12114303		
125	Phantom Max	03	■	18 412 0591	12114303			18 412 0591	12114303		
150	Ciak	00-02	■	18 410 0361	12113303			18 412 0411	12113203		
150	Ciak Master	04	■	18 410 0361	12113303			18 412 0411	12113203		
150	Ciak Rst Euro2	03	■	18 410 0361	12113303			18 412 0411	12113203		
150	F18 Warrior	00-02	■	18 410 0631	12114203			18 412 0411	12113203		
150	Madison T	99-01	■	18 412 0591	12114303			18 412 0591	12114303		
160	Blog le	11	■	18 410 0641	12121103			18 412 0771	12121003		
160	Blog	09-10	■	18 410 0661	12119803			18 412 0781	12119703		
160	Centro le	08-09	■	18 410 0661	12119803			18 412 0781	12119703		
160	Centro SI	11	■	18 410 0641	12121103			18 412 0771	12121003		
160	Centro SI	09-10	■	18 412 0591	12114303			18 412 0781	12119703		
180	Madison R	01-02	■	18 412 0591	12114303			18 412 0591	12114303		
200	Ciak Master Euro 2	06	■	18 410 0361	12113303			18 412 0411	12113203		
200	Madison S Rst	02	■	18 412 0591	12114303			18 412 0591	12114303		
200	Madison S Rst Euro2	03	■	18 412 0591	12114303			18 412 0591	12114303		
200	Phantom Max	03	■	18 412 0591	12114303			18 412 0591	12114303		
250	Madison 3	06-09	■	18 412 0591	12114303			18 412 0591	12114303		
250	Madison Rs Rst	04	■	18 412 0591	12114303			18 412 0591	12114303		
250	Madison S	99-01	■	18 412 0591	12114303			18 412 0591	12114303		
250	Password	05-06	■	18 412 0591	12114303			18 412 0591	12114303		
250	Password Eu3	07-08	■	18 412 0591	12114303			18 412 0591	12114303		
250	Phantom Max	04	■	18 412 0591	12114303			18 412 0591	12114303		
400	Madison K	02	■	18 412 0591	12114303			18 412 0591	12114303		
400	Madison K Rst	02-04	■	18 412 0591	12114303			18 412 0591	12114303		
500	Spidermax Gt	04-05	■	18 412 0591	12114303			18 412 0591	12114303		
500	Spidermax Gt Euro3	06	■	18 412 0591	12114303			18 412 0591	12114303		
500	Spidermax Rs	08	■	18 412 0591	12114303			18 412 0591	12114303		
MBK											
50	Booster	01-03	■	18 410 0401	5JH-H3912-00			18 412 0821	5NTH39220000		
50	Booster	90-94	■	18 410 0010	3VLH39120100			18 412 0010	3VLH39221000		
50	Booster L	01-03	■	18 410 0401	5JH-H3912-00			18 412 0821	5NTH39220000		
50	Booster Naked	03	■	18 410 0401	5JH-H3912-00			18 412 0821	5NTH39220000		
50	Booster Ng	95-98	□	18 410 0161	4SB-H3912-00			18 412 0171	4SB-H3922-00		
50	Booster Ng	99	■	18 410 0421	4SB-H3912-10			18 412 0511	4SB-H3922-10		
50	Booster Ng	01-03	■	18 410 0401	5JH-H3912-00			18 412 0481	5JH-H3922-00		

● Terminale grosso - *Big end lever*
 ■ Colore nero - *Black*
 □ Colore lucido - *Glossy*

GRI Grimeca
 H.T. Heng Tong
 BRE Brembo

DX Destra - *Right*
 SX Sinistra - *Left*

LEVE
LEVERS



CC	MODELLO - MODEL	ANNO YEAR	COLORE - COLOUR	SINISTRA - LEFT		IMPIANTO SYSTEM	TERMINALE TERMINAL	DESTRA - RIGHT		IMPIANTO SYSTEM	TERMINALE TERMINAL
				CODICE RMS RMS CODE	RIF. ORIGINALE OEM NUMBER			CODICE RMS RMS CODE	RIF. ORIGINALE OEM NUMBER		
50	Booster Ng Eu2	01-06	■	18 410 0401	5JH-H3912-00			18 412 0481	5JH-H3922-00		
50	Booster R Road	94-95	■	18 410 0151	4KH-H3912-00			18 412 0151	2NA-83922-01		
50	Booster Rocket	97-98	□	18 410 0161	4SB-H3912-00			18 412 0181	4TD-H3922-00		
50	Booster Spirit	96-98	■	18 410 0151	4KH-H3912-00			18 412 0161	4VV-H3922-00		
50	Booster Spirit	99-00	■	18 410 0421	4SB-H3912-10			18 412 0471	4VV-H3922-10		
50	Booster Spirit Special		□	18 410 0161	4SB-H3912-00			18 412 0151	2NA-83922-01		
50	Booster Spirit Eu2-Sp	02-03	■	18 410 0401	5JH-H3912-00			18 412 0821	5NTH39220000		
50	Booster Spirit L	03	■	18 410 0401	5JH-H3912-00			18 412 0821	5NTH39220000		
50	Booster Track	96-98	□	18 410 0161	4SB-H3912-00			18 412 0171	4SB-H3922-00		
50	Ct S/Ss Sorriso	91-95	■	18 410 0131	1NT-H3912-00						
50	Ct Ss New Sorriso	95-96	■	18 410 0131	1NT-H3912-00						
50	Evolis	92-96	■	18 410 0010	3VLH39120100			18 412 0151	2NA-83922-01		
50	Evolis	95	■	18 410 0151	4KH-H3912-00			18 412 0151	2NA-83922-01		
50	Fizz	94-95	■	18 410 0151	4KH-H3912-00			18 412 0151	2NA-83922-01		
50	Flipper Cat	69-00	□	18 410 0411	5EU-H3912-00			18 412 0491	5EU-H3922-00		
50	Flipper	98-02	□	18 410 0411	5EU-H3912-00			18 412 0491	5EU-H3922-00		
50	Flipper Eu2	01-04	□	18 410 0411	5EU-H3912-00			18 412 0491	5EU-H3922-00		
50	Forte	94-95	■	18 410 0151	4KH-H3912-00			18 412 0151	2NA-83922-01		
50	Mach G Eu1-Eu2	02-04	■	18 410 0401	5JH-H3912-00			18 412 0891	5RWH392200		
50	Nitro Tutti - Jaguar Eu2	97-04		18 412 0391	5BRH39120100			18 412 0391	5BRH39120100		
50	Ovetto Eu1-Eu2 - Tutti	97-04	□	18 410 0141	5AD-H3912-02			18 412 0401	5AD-H3922-01		
50	Stunt	00-02	■	18 410 0401	5JH-H3912-00			18 412 0481	5JH-H3922-00		
50	Target	91-95	■	18 410 0131	1NT-H3912-00			18 412 0151	2NA-83922-01		
100	Ovetto	00-02	□	18 410 0141	5AD-H3912-02			18 412 0401	5AD-H3922-01		
125	Doodo	00-02	■	18 410 0491	5DS-H3912-01			18 412 0601	5DS-H3922-01		
125	Skyliner	98-02	■	18 410 0491	5DS-H3912-01			18 412 0601	5DS-H3922-01		
125	Skyline E	01-03	■	18 412 0601	5DS-H3922-01			18 412 0601	5DS-H3922-01		
125	Thunder	01-02	■	18 412 0601	5DS-H3922-01			18 412 0601	5DS-H3922-01		
125	Xc K Flame R	97-98	■					18 412 0151	2NA-83922-01		
150	Doodo	01-02	■	18 410 0491	5DS-H3912-01			18 412 0601	5DS-H3922-01		
150	Skyliner	00	■	18 410 0491	5DS-H3912-01			18 412 0601	5DS-H3922-01		
150	Skyliner	01-02	■	18 412 0601	5DS-H3922-01			18 412 0601	5DS-H3922-01		
150	Thunder	01-02	■	18 412 0601	5DS-H3922-01			18 412 0601	5DS-H3922-01		
150	Vertex	97	■					18 412 0151	2NA-83922-01		
180	Skyliner E	03-08	■	18 412 0601	5DS-H3922-01			18 412 0601	5DS-H3922-01		
250	Skyliner Abs	00-03	■	18 410 0501	5CG-83912-11			18 412 0611	5CG-83922-01		
300	Kilibre	03-06	■	18 412 0601	5DS-H3922-01			18 412 0601	5DS-H3922-01		
PEUGEOT											
50	Elyseo	99	■					18 412 0671	752868		AJP
50	Elyseo	99	■					18 412 0701	752864		H.T.
50	Jet Force	03	■	18 412 0671	752868		AJP	18 412 0671	752868		AJP
50	Jet Force	03	□	18 412 0691	757025-754709			18 412 0691	757025-754709		
50	Looxor	01-03	■	18 410 0021	754174			18 412 0671	752868		AJP
50	Looxor Tsdì	02	■	18 410 0021	754174			18 412 0671	752868		AJP
50	Ludix 10 Sp Blaster	05-06	■					18 412 0671	752868		AJP
50	Ludix 10 Trend - Snake	04	■	18 410 0021	754174			18 412 0671	752868		AJP
50	Ludix 14 Elegant	04	■	18 410 0021	754174			18 412 0671	752868		AJP



LEVE LEVERS

CC	MODELLO - MODEL	ANNO YEAR	COLORE - COLOUR	SINISTRA - LEFT		IMPIANTO SYSTEM	TERMINALE TERMINAL	DESTRA - RIGHT		IMPIANTO SYSTEM	TERMINALE TERMINAL
				CODICE RMS RMS CODE	RIF. ORIGINALE OEM NUMBER			CODICE RMS RMS CODE	RIF. ORIGINALE OEM NUMBER		
50	Metal-X	02	□					18 412 0691	757025-754709		
50	Speedake	95-97	■	18 410 0021	754174						
50	Speedfight 2 Aria	05-06	■	18 410 0021	754174			18 412 0671	752868	AJP	
50	Speedfight 2 Aria	05-06	■	18 410 0021	754174			18 412 0701	752864	H.T.	
50	Speedfight 2 Lc-Silversport	05-06	□	18 412 0691	757025-754709			18 412 0691	757025-754709		
50	Speedfight Acqua	97-98	■	18 410 0021	754174			18 412 0671	752868	AJP	
50	Speedfight Acqua	97-98	■	18 410 0021	754174			18 412 0701	752864	H.T.	
50	Speedfight Acqua ICD-ICDP	97-98	■	18 412 0671	752868	AJP		18 412 0671	752868	AJP	
50	Speedfight Acqua ICD-ICDP	97-98	■	18 412 0701	752864	H.T.		18 412 0701	752864	H.T.	
50	Speedfight Acqua ICD-ICDP	97-98	□	18 412 0691	757025-754709			18 412 0691	757025-754709		
50	Speedfight Aria	97-98	■	18 410 0021	754174			18 412 0671	752868	AJP	
50	Speedfight Aria	97-98	■	18 410 0021	754174			18 412 0701	752864	H.T.	
50	Speedfight Aria Catalitico	99	■	18 410 0021	754174			18 412 0671	752868	AJP	
50	Speedfight Aria Catalitico	99	■	18 410 0021	754174			18 412 0701	752864	H.T.	
50	Sv Geo Freno Tamb.-Drum	95-97	■	18 410 0021	754174						
50	Sv Geo Freno disco/Disc Grim.	91-95	■	18 410 0021	754174						
50	Squab	95-97	■	18 410 0021	754174			18 412 0671	752868	AJP	
50	Squab	95-97	■	18 410 0021	754174			18 412 0701	752864	H.T.	
50	Trekker	98-00	■	18 410 0021	754174			18 412 0671	752868	AJP	
50	Trekker	98-00	■	18 410 0021	754174			18 412 0701	752864	H.T.	
50	Trk2 Wrc	04-06	□					18 412 0691	757025-754709		
50	Vivacity	99	■	18 410 0021	754174			18 412 0671	752868	AJP	
50	Vivacity	99	■	18 410 0021	754174			18 412 0701	752864	H.T.	
50	Vivacity Catalitico	99-02	■	18 410 0021	754174			18 412 0671	752868	AJP	
50	Vivacity Catalitico	99-02	■	18 410 0021	754174			18 412 0701	752864	H.T.	
50	Vivacity Vsx-Xr	02-04	■					18 412 0671	752868	AJP	
50	Vivacity X-Race		■					18 412 0701	752864	H.T.	
50	Vivacity X-Race		■					18 412 0671	752868	AJP	
50	X-Fight Lc	00	■	18 412 0671	752868	AJP		18 412 0671	752868	AJP	
50	X-Fight Lc	00	■	18 412 0701	752864	H.T.		18 412 0701	752864	H.T.	
50	X-Fight Lc	00	□	18 412 0691	757025-754709			18 412 0691	757025-754709		
50	X-Fight Ac	00	■	18 410 0021	754174			18 412 0671	752868	AJP	
50	X-Fight Ac	00	■	18 410 0021	754174			18 412 0701	752864	H.T.	
50	Xrace	03	□	18 412 0691	757025-754709			18 412 0691	757025-754709		
50	Zenith L	94-96	■	18 410 0021	754174			18 412 0671	752868	AJP	
50	Zenith L	94-96	■	18 410 0021	754174			18 412 0701	752864	H.T.	
50	Zenith Ln-Ls	97-98	■	18 410 0021	754174			18 412 0671	752868	AJP	
50	Zenith Ln-Ls	97-98	■	18 410 0021	754174			18 412 0701	752864	H.T.	
50	Zenith FD Grimeca	97-98	■	18 410 0021	754174						
100	Elyseo	99-01	■	18 410 0021	754174			18 412 0671	752868	AJP	
100	Elyseo	99-01	■	18 410 0021	754174			18 412 0701	752864	H.T.	
100	Looxor	01	□	18 412 0691	757025-754709			18 412 0691	757025-754709		
100	Speedfight	97-00	■	18 412 0671	752868	AJP		18 412 0671	752868	AJP	
100	Speedfight	97-00	□	18 412 0691	757025-754709			18 412 0691	757025-754709		
100	Sv L	98	■					18 412 0701	752864	H.T.	
100	Trekker	98	■	18 410 0021	754174			18 412 0671	752868	AJP	
100	Trekker	98	■	18 410 0021	754174			18 412 0701	752864	H.T.	

● Terminale grosso - Big end lever
 ■ Colore nero - Black
 □ Colore lucido - Glossy

GRI Grimeca
 H.T. Heng Tong
 BRE Brembo

DX Destra - Right
 SX Sinistra - Left

LEVE
LEVERS



CC	MODELLO - MODEL	ANNO YEAR	COLORE - COLOUR	SINISTRA - LEFT		IMPIANTO SYSTEM	TERMINALE TERMINAL	DESTRA - RIGHT		IMPIANTO SYSTEM	TERMINALE TERMINAL
				CODICE RMS RMS CODE	RIF. ORIGINALE OEM NUMBER			CODICE RMS RMS CODE	RIF. ORIGINALE OEM NUMBER		
100	Vivacity	99-01	■	18 410 0021	754174			18 412 0671	752868	AJP	
100	Vivacity	99-01	■	18 410 0021	754174			18 412 0701	752864	H.T.	
100	X-Fight	00-01	■	18 412 0671	752868	AJP		18 412 0671	752868	AJP	
100	X-Fight	00-01	■	18 412 0701	752864	H.T.		18 412 0701	752864	H.T.	
100	X-Fight	00-01	□	18 412 0691	757025-754709			18 412 0691	757025-754709		
125	Sv Tamburo - Drum	91-95	■	18 410 0021	754174						
125	Elyseo	99-00	■	18 410 0021	754174			18 412 0671	752868	AJP	
125	Elyseo	99-00	■	18 410 0021	754174			18 412 0701	752864	H.T.	
125	Elyseo	01	■	18 410 0021	754174			18 412 0671	752868	AJP	
150	Elyseo	99-00	■	18 410 0021	754174			18 412 0671	752868	AJP	
150	Elyseo	99-00	■	18 410 0021	754174			18 412 0701	752864	H.T.	
PGO											
50	Big Max	96	■	18 410 0131				18 412 0151			
PIAGGIO											
50	Ciao Sc	-	□	18 410 1060	156378			18 410 1060	156378		
50	Ciao Px	-	■	18 410 1100	176945			18 412 1070	177340		
50	Fly 2T	05-07	□	18 410 0181	561131			18 412 0731	646803	Gri.	●
50	Fly 2T	05-07	□	18 410 0601	564683		●	18 412 0731	646803	Gri.	●
50	Fly 2T	10	□	18 410 0181	561131			18 412 0731	646803	Gri.	●
50	Fly 2T	10	□	18 410 0601	564683		●	18 412 0731	646803	Gri.	●
50	Fly 2T	10	□	18 410 0181	561131			18 412 0652	646833	H.T.	
50	Fly 2T	10	□	18 410 0601	564683		●	18 412 0711	497042	H.T.	●
50	Fly 4T	05-07	□	18 410 0181	561131			18 412 0731	646803	Gri.	●
50	Fly 4T	05-07	□	18 410 0601	564683		●	18 412 0731	646803	Gri.	●
50	Fly 4T	05-07	□	18 410 0181	561131			18 412 0652	646833	H.T.	
50	Fly 4T	05-07	□	18 410 0601	564683		●	18 412 0711	497042	H.T.	●
50	Fly 4T	08-10	□	18 410 0181	561131			18 412 0731	646803	Gri.	●
50	Fly 4T	08-10	□	18 410 0601	564683		●	18 412 0711	497042	H.T.	●
50	Fly 4T Mot Chn	06-07	□	18 410 0181	561131			18 412 0731	646803	Gri.	●
50	Fly 4T Mot Chn	06-07	□	18 410 0601	564683		●	18 412 0731	646803	Gri.	●
50	Fly 4T Mot Chn	06-07	□	18 410 0601	564683		●	18 412 0652	646833	H.T.	
50	Fly 4T Mot Chn	06-07	□	18 410 0601	564683		●	18 412 0711	497042	H.T.	●
50	Free	92-94	■	18 410 0170	269070						
50	Free Delivery	00-01	■	18 410 0111	564689			18 412 0091	564690		
50	Free Fl	95-02	■	18 410 0111	564689			18 412 0091	564690		
50	Liberty	97-05	□	18 410 0201	564642			18 412 0261	494948	Gri.	
50	Liberty	97-05	□	18 410 0201	564642			18 412 0641	497039	H.T.	
50	Liberty 2T	06-08	□	18 410 0181	561131			18 412 0731	646803	Gri.	●
50	Liberty 2T	06-08	□	18 410 0601	564683		●	18 412 0731	646803	Gri.	●
50	Liberty 2T	06-08	□	18 410 0601	564683		●	18 412 0652	646833	H.T.	
50	Liberty 2T	06-08	□	18 410 0601	564683		●	18 412 0711	497042	H.T.	●
50	Liberty 2T Rst	04	□	18 410 0181	561131			18 412 0731	646803	Gri.	●
50	Liberty 2T Rst	04	□	18 410 0601	564683		●	18 412 0731	646803	Gri.	●
50	Liberty 2T Sport	06-08	□	18 410 0181	561131			18 412 0731	646803	Gri.	●
50	Liberty 2T Sport	06-08	□	18 410 0601	564683		●	18 412 0731	646803	Gri.	●
50	Liberty 2T Sport	06-08	□	18 410 0181	561131			18 412 0652	646833	H.T.	
50	Liberty 2T Sport	06-08	□	18 410 0601	564683		●	18 412 0711	497042	H.T.	●



LEVE LEVERS

CC	MODELLO - MODEL	ANNO YEAR	COLORE - COLOUR	SINISTRA - LEFT		IMPIANTO SYSTEM	TERMINALE TERMINAL	DESTRA - RIGHT		IMPIANTO SYSTEM	TERMINALE TERMINAL
				CODICE RMS RMS CODE	RIF. ORIGINALE OEM NUMBER			CODICE RMS RMS CODE	RIF. ORIGINALE OEM NUMBER		
50	Liberty 4T	00-02	□	18 410 0201	564642			18 412 0261	494948	Gri.	
50	Liberty 4T	00-02	□	18 410 0201	564642			18 412 0641	497039	H.T.	
50	Liberty 4T	05-08	□	18 410 0181	561131			18 412 0731	646803	Gri.	●
50	Liberty 4T	05-08	□	18 410 0601	564683		●	18 412 0731	646803	Gri.	●
50	Liberty 4T	05-08	□	18 410 0181	561131			18 412 0652	646833	H.T.	
50	Liberty 4T	05-08	□	18 410 0601	564683		●	18 412 0711	497042	H.T.	●
50	Liberty 4T Ptt	09-10	□	18 410 0731	648083			18 412 0711	497042	H.T.	●
50	Liberty 4T Delivery Tnt	09	□	18 410 0731	648083			18 412 0711	497042	H.T.	●
50	Liberty 4T Rst	04	□	18 410 0181	561131			18 412 0731	646803	Gri.	●
50	Liberty 4T Rst	04	□	18 410 0601	564683		●	18 412 0731	646803	Gri.	●
50	Liberty 4T Sport	06-08	□	18 410 0181	561131			18 412 0731	646803	Gri.	●
50	Liberty 4T Sport	06-08	□	18 410 0601	564683		●	18 412 0731	646803	Gri.	●
50	Liberty 4T Sport	07-08	□	18 410 0181	561131			18 412 0652	646833	H.T.	
50	Liberty 4T Sport	07-08	□	18 410 0601	564683		●	18 412 0711	497042	H.T.	●
50	Liberty Moc 2T	09	□	18 410 0601	564683		●	18 412 0711	497042	H.T.	●
50	Liberty Moc 2T	09-10	□	18 410 0181	561131			18 412 0652	646833	H.T.	
50	Liberty Moc 2T	09-10	□	18 410 0601	564683		●	18 412 0731	646803	Gri.	●
50	Liberty Moc 2T	09-10	□	18 410 0181	561131			18 412 0731	646803	Gri.	●
50	Liberty Moc 4T & Elle	09-10	□	18 410 0181	561131			18 412 0652	646833	H.T.	
50	Liberty Moc 4T & Elle	09-10	□	18 410 0601	564683		●	18 412 0711	497042	H.T.	●
50	Liberty Moc 4T & Elle	09-10	□	18 410 0181	561131			18 412 0731	646803	Gri.	●
50	Liberty Moc 4T & Elle	09-10	□	18 410 0601	564683		●	18 412 0731	646803	Gri.	●
50	Liberty Ptt Eu2	04-05	□	18 410 0201	564642			18 412 0641	497039	H.T.	
50	Nrg	94-96	■	18 410 0111	564689			18 412 0091	564690		
50	Nrg Extreme	99-00	■	18 410 0531	562450			18 412 0111	494952	Gri.	
50	Nrg Extreme	01-04	■	18 412 0111	494952	Gri.		18 412 0111	494952	Gri.	
50	Nrg Mc3	01-04	■	18 410 0531	562450			18 412 0111	494952	Gri.	
50	Nrg Mc3	01-04	■	18 412 0651	497041	H.T.		18 412 0651	497041	H.T.	
50	Nrg Power Dd	05-06	□	18 412 0711	497042	H.T.	●	18 412 0711	497042	H.T.	●
50	Nrg Power Dd	07-10	□	18 412 0711	497042	H.T.	●	18 412 0711	497042	H.T.	●
50	Nrg Power Dd	07-10	□	18 412 0652	646833	H.T.		18 412 0652	646833	H.T.	
50	Nrg Power Dd Serie Spec	07-10	□	18 412 0711	497042	H.T.	●	18 412 0731	646803	Gri.	●
50	Nrg Power Dd Serie Spec	07-10	□	18 412 0711	497042	H.T.	●	18 412 0711	497042	H.T.	●
50	Nrg Power Dt	06-08	□	18 410 0181	561131			18 412 0731	646803	Gri.	●
50	Nrg Power Dt	06-08	□	18 410 0601	564683		●	18 412 0731	646803	Gri.	●
50	Nrg Power Dt	06-11	□	18 410 0181	561131			18 412 0652	646833	H.T.	
50	Nrg Power Dt	06-11	□	18 410 0601	564683		●	18 412 0711	497042	H.T.	●
50	Nrg Power Dt Serie Spec	07-08	□	18 410 0181	561131			18 412 0731	646803	Gri.	●
50	Nrg Power Dt Serie Spec	07-08	□	18 410 0601	564683		●	18 412 0731	646803	Gri.	●
50	Nrg Power Dt Serie Spec	07-08	□	18 410 0181	561131			18 412 0652	646833	H.T.	
50	Nrg Power Dt Serie Spec	07-08	□	18 410 0601	564683		●	18 412 0711	497042	H.T.	●
50	Nrg Power Purejet	04-05	■	18 412 0651	497041	H.T.		18 412 0651	497041	H.T.	
50	Nrg Power Purejet	06-08	□	18 412 0711	497042	H.T.	●	18 412 0711	497042	H.T.	●
50	Nrg Power Purejet	07-11	□	18 412 0652	646833	H.T.		18 412 0652	646833	H.T.	
50	Nrg Purejet	02-04	■	18 412 0651	497041	H.T.		18 412 0651	497041	H.T.	
50	Nrg Purejet	02-04	■	18 412 0111	494952	Gri.		18 412 0111	494952	Gri.	
50	Nrg Purejet	10	□	18 412 0711	497042	H.T.	●	18 412 0711	497042	H.T.	●

● Terminale grosso - Big end lever
 ■ Colore nero - Black
 □ Colore lucido - Glossy

GRI Grimeca
 H.T. Heng Tong
 BRE Brembo

DX Destra - Right
 SX Sinistra - Left

LEVE
LEVERS



CC	MODELLO - MODEL	ANNO YEAR	COLORE - COLOUR	SINISTRA - LEFT		IMPIANTO SYSTEM	TERMINALE TERMINAL	DESTRA - RIGHT		IMPIANTO SYSTEM	TERMINALE TERMINAL
				CODICE RMS RMS CODE	RIF. ORIGINALE OEM NUMBER			CODICE RMS RMS CODE	RIF. ORIGINALE OEM NUMBER		
50	Nrg Purejet	10	□	18 412 0652	646833	H.T.		18 412 0652	646833	H.T.	
50	Nrg Rst Mc2	96-98	■					18 412 0101	271449		
50	Nrg Rst Mc2	96-98	■	18 412 0111	494952	Gri.		18 412 0111	494952	Gri.	
50	Ntt	95-96	■	18 410 0111	564689			18 412 0091	564690		
50	Quartz	92-96	■	18 410 0111	564689			18 412 0231	494951		
50	Si	90-91	■	18 410 0310	228967			18 412 1080	228966		
50	Si FL 2	-	■	18 410 0300	268015			18 412 0330	268014		
50	Typhoon	01-04	■	18 410 0111	564689			18 412 0091	564690		
50	Typhoon	05-08	□	18 410 0601	564683		●	18 412 0711	497042	H.T.	●
50	Typhoon	09	□	18 410 0601	564683		●	18 412 0711	497042	H.T.	●
50	Typhoon 2T Eu2	10-12	■	18 410 0861	564681			18 412 0651	497041	H.T.	
50	Typhoon 2T Eu3 Ch	11	■	18 410 0861	564681			18 412 0651	497041	H.T.	
50	Vespa Et2	97-05	□	18 410 0201	564642			18 412 0261	494948	Gri.	
50	Vespa Et2	97-05	□	18 410 0201	564642			18 412 0641	497039	H.T.	
50	Vespa Et2 Iniezione	97-00	□	18 410 0201	564642			18 412 0261	494948	Gri.	
50	Vespa Et4	00-05	□	18 410 0201	564642			18 412 0261	494948	Gri.	
50	Vespa Et4	00-05	□	18 410 0201	564642			18 412 0641	497039	H.T.	
50	Vespa FL2 Automatica	90-91	■					18 412 0280	265947		
50	Vespa FL2 Hp	91-97	■					18 412 0280	265947		
50	Vespa Lx 2T	05-08	□	18 410 0181	561131			18 412 0731	646803	Gri.	●
50	Vespa Lx 2T	05-08	□	18 410 0601	564683		●	18 412 0731	646803	Gri.	●
50	Vespa Lx 2T	05-08	□	18 410 0181	561131			18 412 0652	646833	H.T.	
50	Vespa Lx 2T	05-08	□	18 410 0601	564683		●	18 412 0711	497042	H.T.	●
50	Vespa Lx 2T FL	09-10	□	18 410 0181	561131			18 412 0652	646833	H.T.	
50	Vespa Lx 2T FL	09-10	□	18 410 0601	564683		●	18 412 0711	497042	H.T.	●
50	Vespa Lx 2T Touring	10-13	□	18 410 0181	561131			18 412 0652	646833	H.T.	
50	Vespa Lx 2T Touring	10-13	□	18 410 0601	564683		●	18 412 0711	497042	H.T.	●
50	Vespa Lxv 2T	06-09	□	18 410 0821	648115						
50	Vespa Lx 4T	05-08	□	18 410 0181	561131			18 412 0731	646803	Gri.	●
50	Vespa Lx 4T	05-08	□	18 410 0601	564683		●	18 412 0731	646803	Gri.	●
50	Vespa Lx 4T	05-08	□	18 410 0181	561131			18 412 0652	646833	H.T.	
50	Vespa Lx 4T	05-08	□	18 410 0601	564683		●	18 412 0711	497042	H.T.	●
50	Vespa Lx 4T-4V	09-13	□	18 410 0181	561131			18 412 0652	646833	H.T.	
50	Vespa Lx 4T-4V	09-13	□	18 410 0601	564683		●	18 412 0711	497042	H.T.	●
50	Vespa Lx 4T-4V Touring	10-13	□	18 410 0181	561131			18 412 0652	646833	H.T.	
50	Vespa Lx 4T-4V Touring	10-13	□	18 410 0601	564683		●	18 412 0711	497042	H.T.	●
50	Vespa Primavera 2T	13-14	□	18 410 0601	564683		●	18 412 0711	497042	H.T.	●
50	Vespa Primavera 4T-4V	13-14	□	18 410 0601	564683		●	18 412 0711	497042	H.T.	●
50	Vespa S 2T & College	07-12	□	18 410 0181	561131			18 412 0731	646803	Gri.	●
50	Vespa S 2T & College	07-12	□	18 410 0601	564683		●	18 412 0731	646803	Gri.	●
50	Vespa S 2T & College	07-12	□	18 410 0181	561131			18 412 0652	646833	H.T.	
50	Vespa S 2T & College	07-12	□	18 410 0601	564683		●	18 412 0711	497042	H.T.	●
50	Vespa S 4T-4V & College	08-12	□	18 410 0181	561131			18 412 0731	646803	Gri.	●
50	Vespa S 4T-4V & College	08-12	□	18 410 0601	564683		●	18 412 0731	646803	Gri.	●
50	Vespa S 4T-4V & College	08-12	□	18 410 0181	561131			18 412 0652	646833	H.T.	
50	Vespa S 4T-4V & College	08-12	□	18 410 0601	564683		●	18 412 0711	497042	H.T.	●
50	Vespa Pk FL	90	□	18 410 0261	274546						



LEVE LEVERS

CC	MODELLO - MODEL	ANNO YEAR	COLORE - COLOUR	SINISTRA - LEFT		IMPIANTO SYSTEM	TERMINALE TERMINAL	DESTRA - RIGHT		IMPIANTO SYSTEM	TERMINALE TERMINAL
				CODICE RMS RMS CODE	RIF. ORIGINALE OEM NUMBER			CODICE RMS RMS CODE	RIF. ORIGINALE OEM NUMBER		
50	Vespa Pk FL 2 Automatico	90-91	□	18 410 0261	274546						
50	Vespa Pk FL 2 Hp	91-97	□	18 410 0261	274546						
50	Vespa Sprint 2T 2V	14	□	18 410 0601	564683		●	18 412 0711	497042	H.T.	●
50	Vespa Sprint 4T 4V	14	□	18 410 0601	564683		●	18 412 0711	497042	H.T.	●
50	Zip	92-93	■	18 410 0170	269070						
50	Zip	95-96	■	18 410 0111	564689			18 412 0231	494951		
50	Zip	00-04	■	18 410 0591	564682		●	18 412 0111	494952	Gri.	
50	Zip	00-04	■	18 410 0531	562450						
50	Zip 2T	08-10	■	18 410 0591	564682		●	18 412 0651	497041	H.T.	
50	Zip 4T	00-05	■	18 410 0531	562450			18 412 0111	494952	Gri.	
50	Zip 4T	06-10	■	18 410 0531	562450			18 412 0651	497041	H.T.	
50	Zip 4T	06-10	■	18 410 0591	564682		●				
50	Zip Bimodale	94-97	■	18 410 0170	269070						
50	Zip Fast Raider	93-94	■	18 410 0111	564689			18 412 0231	494951		
50	Zip Fast Raider Rst	96-97	■	18 410 0111	564689			18 412 0231	494951		
50	Zip Rst Freno Disco/Disc	96-99	■	18 410 0111	564689			18 412 0231	494951		
50	Zip Rst Freno tamb./Drum	96-99	■	18 410 0111	564689			18 412 0091	564690		
50	Zip Sp	96-00	■	18 410 0111	564689			18 412 0231	494951		
50	Zip Sp	01-04	■	18 410 0531	562450			18 412 0651	497041	H.T.	
50	Zip Sp	01-04	■	18 410 0591	564682		●	18 412 0111	494952	Gri.	
50	Zip Sp Eu2	06-09	■	18 410 0531	562450			18 412 0651	497041	H.T.	
50	Zip Sp Eu2	06-09	■	18 410 0591	564682		●				
100	Fly 4T	06-07	□	18 410 0181	561131			18 412 0731	646803	Gri.	●
100	Fly 4T	06-07	□	18 410 0601	564683		●	18 412 0731	646803	Gri.	●
100	Fly 4T	06-07	□	18 410 0181	561131			18 412 0652	646833	H.T.	
100	Fly 4T	06-07	□	18 410 0601	564683		●	18 412 0711	497042	H.T.	●
100	Free	02-03	■	18 410 0111	564689			18 412 0091	564690		
100	Zip 4T	06-10	■	18 410 0591	564682		●				
125	Beverly	01-03	■	18 412 0601	646829	Bre.		18 412 0601	646829	Bre.	
125	Beverly	01-03	■	18 412 0721	497031	Bre.	●	18 412 0721	497031	Bre.	●
125	Beverly	01-03	■	18 412 0661	600475	H.T.	●	18 412 0661	600475	H.T.	●
125	Beverly Eu3	07-08	■	18 412 0721	497031	Bre.	●	18 412 0721	497031	Bre.	●
125	Beverly Eu3	07-08	■	18 412 0601	646829	Bre.		18 412 0601	646829	Bre.	
125	Beverly Eu3	07-08	■	18 412 0661	600475	H.T.	●	18 412 0661	600475	H.T.	●
125	Beverly Eu3 Mic	07	■	18 412 0721	497031	Bre.	●	18 412 0721	497031	Bre.	●
125	Beverly Eu3 Mic	07	■	18 412 0601	646829	Bre.		18 412 0601	646829	Bre.	
125	Beverly Eu3 Mic	07	■	18 412 0661	600475	H.T.	●	18 412 0661	600475	H.T.	●
125	Beverly Eu3 Sport	07-08	■	18 412 0661	600475			18 412 0601	646829	Bre.	
125	Beverly Eu3 Sport	07-08	■	18 412 0661	600475	H.T.	●	18 412 0661	600475	H.T.	●
125	Beverly Rst	04-07	■	18 412 0661	600475	H.T.	●	18 412 0661	600475	H.T.	●
125	Beverly Rst	06-07	■	18 412 0601	646829	Bre.		18 412 0601	646829	Bre.	
125	Beverly Rst	06-07	■	18 412 0721	497031	Bre.	●	18 412 0721	497031	Bre.	●
125	Beverly Rst 4T 4V Ie Eu3	10-11	■	18 412 0661	600475	H.T.	●	18 412 0721	497031	Bre.	●
125	Beverly Tourer Eu3	08-09	■	18 412 0601	646829	Bre.		18 412 0601	646829	Bre.	
125	Beverly Tourer Eu3	08-09	■	18 412 0721	497031	Bre.	●	18 412 0721	497031	Bre.	●
125	Beverly Tourer Eu3	08-09	■	18 412 0661	600475	H.T.	●	18 412 0661	600475	H.T.	●
125	Carnaby	07-09	■	18 412 0601	646829	Bre.		18 412 0601	646829	Bre.	

● Terminale grosso - *Big end lever*
 ■ Colore nero - *Black*
 □ Colore lucido - *Glossy*

GRI Grimeca
 H.T. Heng Tong
 BRE Brembo

DX Destra - *Right*
 SX Sinistra - *Left*

LEVE
LEVERS



CC	MODELLO - MODEL	ANNO YEAR	COLORE - COLOUR	SINISTRA - LEFT		IMPIANTO SYSTEM	TERMINALE TERMINAL	DESTRA - RIGHT		IMPIANTO SYSTEM	TERMINALE TERMINAL
				CODICE RMS RMS CODE	RIF. ORIGINALE OEM NUMBER			CODICE RMS RMS CODE	RIF. ORIGINALE OEM NUMBER		
125	Carnaby	07-09	■	18 412 0721	497031	Bre.	●	18 412 0721	497031	Bre.	●
125	Carnaby	07-09	■	18 412 0661	600475	H.T.	●	18 412 0661	600475	H.T.	●
125	Fly	05-07	□	18 410 0181	561131			18 412 0731	646803	Gri.	●
125	Fly	05-07	□	18 410 0601	564683		●	18 412 0731	646803	Gri.	●
125	Fly	05-07	□	18 410 0181	561131			18 412 0652	646833	H.T.	
125	Fly	05-07	□	18 410 0601	564683		●	18 412 0711	497042	H.T.	●
125	Fly Eu3	07	□	18 410 0181	561131			18 412 0731	646803	Gri.	●
125	Fly Eu3	07	□	18 410 0601	564683		●	18 412 0731	646803	Gri.	●
125	Fly Eu3	08	□	18 410 0181	561131			18 412 0731	646803	Gri.	●
125	Fly Eu3	08	□	18 410 0601	564683		●	18 412 0731	646803	Gri.	●
125	Fly Eu3	08	□	18 410 0181	561131			18 412 0652	646833	H.T.	
125	Fly Eu3	08	□	18 410 0601	564683		●	18 412 0711	497042	H.T.	●
125	Hexagon	94-97	■					18 412 0111	494952	Gri.	
125	Hexagon Gtx	00	■					18 412 0111	494952	Gri.	
125	Hexagon Lx-Lxt	98-99	□	18 410 0181	561131			18 412 0731	646803	Gri.	●
125	Hexagon Lx-Lxt	98-99	□	18 410 0601	564683		●	18 412 0731	646803	Gri.	●
125	Hexagon Lx4	98-99	□	18 410 0181	561131			18 412 0731	646803	Gri.	●
125	Hexagon Lx4	98-99	□	18 410 0601	564683		●	18 412 0731	646803	Gri.	●
125	Hexagon Lx4	98-99	■					18 412 0111	494952	Gri.	
125	Liberty	98-02	□	18 410 0201	564642			18 412 0261	494948	Gri.	
125	Liberty	01-02	□	18 410 0201	564642			18 412 0641	497039	H.T.	
125	Liberty 4T	06-07	□	18 410 0181	561131			18 412 0731	646803	Gri.	●
125	Liberty 4T	06-07	□	18 410 0601	564683		●	18 412 0731	646803	Gri.	●
125	Liberty 4T	06-07	□	18 410 0181	561131			18 412 0652	646833	H.T.	
125	Liberty 4T	06-07	□	18 410 0601	564683		●	18 412 0711	497042	H.T.	●
125	Liberty 4T Eu3	07-08	□	18 410 0181	561131			18 412 0731	646803	Gri.	●
125	Liberty 4T Eu3	07-08	□	18 410 0601	564683		●	18 412 0731	646803	Gri.	●
125	Liberty 4T Eu3	07-08	□	18 410 0181	561131			18 412 0652	646833	H.T.	
125	Liberty 4T Eu3	07-08	□	18 410 0601	564683		●	18 412 0711	497042	H.T.	●
125	Liberty 4T Eu3 Delivery	08	□	18 410 0731	648083			18 412 0731	646803	Gri.	●
125	Liberty 4T Eu3 Delivery	08	□	18 410 0731	648083			18 412 0652	646833	H.T.	
125	Liberty 4T Sport Eu3	06-08	□	18 410 0181	561131			18 412 0711	497042	H.T.	
125	Liberty 4T Sport Eu3	06-08	□	18 410 0601	564683		●	18 412 0731	646803	Gri.	●
125	Liberty 4T Sport Eu3	06-08	□	18 410 0181	561131			18 412 0652	646833	H.T.	
125	Liberty 4T Sport Eu3	06-08	□	18 410 0601	564683		●	18 412 0711	497042	H.T.	●
125	Liberty Moc 4T & Elle	09-10	□	18 410 0181	561131			18 412 0652	646833	H.T.	
125	Liberty Moc 4T & Elle	09-10	□	18 410 0601	564683		●	18 412 0711	497042	H.T.	●
125	Liberty Rst	04-05	□	18 410 0181	561131			18 412 0652	646833	H.T.	
125	Liberty Rst	04-05	□	18 410 0601	564683		●	18 412 0711	497042	H.T.	●
125	Liberty Rst Ptt	05-06	□	18 410 0731	648083			18 412 0731	646803	Gri.	●
125	Liberty Rst Ptt	05-06	□	18 410 0731	648083			18 412 0652	646833	H.T.	
125	Liberty Sport	06	□	18 410 0181	561131			18 412 0711	497042	H.T.	
125	Liberty Sport	06	□	18 410 0601	564683		●	18 412 0731	646803	Gri.	●
125	Liberty Sport	06	□	18 410 0181	561131			18 412 0652	646833	H.T.	
125	Liberty Sport	06	□	18 410 0601	564683		●	18 412 0711	497042	H.T.	●
125	Mp3	07-08	■	18 412 0661	600475	H.T.	●	18 412 0721	497031	Bre.	●
125	Mp3 Ibrido	09-10	■	18 412 0661	600475	H.T.	●	18 412 0721	497031	Bre.	●



LEVE LEVERS

CC	MODELLO - MODEL	ANNO YEAR	COLORE - COLOUR	SINISTRA - LEFT		IMPIANTO SYSTEM	TERMINALE TERMINAL	DESTRA - RIGHT		IMPIANTO SYSTEM	TERMINALE TERMINAL
				CODICE RMS RMS CODE	RIF. ORIGINALE OEM NUMBER			CODICE RMS RMS CODE	RIF. ORIGINALE OEM NUMBER		
125	Mp3 le	08-09	■	18 412 0661	600475	H.T.	●	18 412 0721	497031	Bre.	●
125	Mp3 Yourban Erl	11	■	18 412 0661	600475	H.T.	●	18 412 0721	497031	Bre.	●
125	Skipper	94-97	■	18 410 0111	564689			18 412 0231	494951		
125	Skipper 4T	00-02	■					18 412 0111	494952	Gri.	
125	Skipper 4T	00-02	■					18 412 0651	497041	H.T.	
125	Skipper Lx	98-99	■					18 412 0111	494952	Gri.	
125	Skipper Lx	98-99	■	18 410 0861	564681			18 412 0651	497041	H.T.	
125	Super Hexagon Gtx 12	01-02	■	18 410 0111	564689			18 412 0111	494952	Gri.	
125	Super Hexagon Gtx 12	01-02	■	18 410 0111	564689			18 412 0651	497041	H.T.	
125	Typhoon 4T 2V Eu3	10-11	■								
125	Typhoon 4T 2V Eu3	10-11	■	18 410 0861	564681			18 412 0651	497041	H.T.	
125	Skipper 4T	00-02	■	18 410 0861	564681			18 412 0651	497040	H.T.	
125	Vespa Et4	96-02	□	18 410 0201	564642			18 412 0261	494948	Gri.	
125	Vespa Et4	99-02	□	18 410 0201	564642			18 412 0641	497039	H.T.	
125	Vespa FL	89-90	■					18 412 0280	265947		
125	Vespa Granturismo	03-05	□	18 412 0652	646833	H.T.		18 412 0652	646833	H.T.	
125	Vespa Granturismo	06-07	□	18 412 0711	497042	H.T.	●	18 412 0711	497042	H.T.	●
125	Vespa Granturismo Eu3	06-07	□	18 412 0711	497042	H.T.	●	18 412 0711	497042	H.T.	●
125	Vespa Gts 4T le Super	09-11	□	18 412 0711	497042	H.T.	●	18 412 0711	497042	H.T.	●
125	Vespa Gts Eu3	07-12	□	18 412 0711	497042	H.T.	●	18 412 0711	497042	H.T.	●
125	Vespa Gts Eu3	07-12	□	18 412 0652	646833	H.T.		18 412 0652	646833	H.T.	
125	Vespa Lx	05-06	□	18 410 0601	564683		●	18 412 0731	646803	Gri.	●
125	Vespa Lx	05-06	□	18 410 0181	561131			18 412 0652	646833	H.T.	
125	Vespa Lx	05-06	□	18 410 0601	564683		●	18 412 0711	497042	H.T.	●
125	Vespa Lx 4T FL	09	□	18 410 0181	561131			18 412 0652	646833	H.T.	
125	Vespa Lx 4T FL	09	□	18 410 0601	564683		●	18 412 0711	497042	H.T.	●
125	Vespa Lx 4T 3V le - Touring	12-13	□	18 410 0601	564683		●	18 412 0711	497042	H.T.	●
125	Vespa Lx Eu3	06-08	□	18 410 0181	561131			18 412 0731	646803	Gri.	●
125	Vespa Lx Eu3	06-08	□	18 410 0601	564683		●	18 412 0731	646803	Gri.	●
125	Vespa Lx Eu3	06-08	□	18 410 0181	561131			18 412 0652	646833	H.T.	
125	Vespa Lx Eu3	06-08	□	18 410 0601	564683		●	18 412 0711	497042	H.T.	●
125	Vespa Lx Eu3 le	09-10	□	18 410 0601	564683		●	18 412 0711	497042	H.T.	●
125	Vespa Lx Eu3 le	09-10	□	18 410 0181	561131			18 412 0652	646833	H.T.	
125	Vespa Lx Touring	10-11	□	18 410 0181	561131			18 412 0652	646833	H.T.	
125	Vespa Lx Touring	10-11	□	18 410 0601	564683		●	18 412 0711	497042	H.T.	●
125	Vespa Lxv 4T	06-12	□	18 410 0821	648115						
125	Vespa Lx Primavera 4T 3V le	13-14	□	18 410 0601	564683		●	18 412 0711	497042	H.T.	●
125	Vespa Lxv le 4T	10-13	□	18 410 0821	648115						
125	Vespa S 4T 3V le	12	□	18 410 0601	564683		●	18 412 0711	497042	H.T.	●
125	Vespa S 4T Eu3	07-08	□	18 410 0181	561131			18 412 0731	646803	Gri.	●
125	Vespa S 4T Eu3	07-08	□	18 410 0601	564683		●	18 412 0731	646803	Gri.	●
125	Vespa S 4T Eu3	07-08	□	18 410 0181	561131			18 412 0652	646833	H.T.	
125	Vespa S 4T Eu3	07-08	□	18 410 0601	564683		●	18 412 0711	497042	H.T.	●
125	Vespa S 4T le & College	09-11	□	18 410 0181	561131			18 412 0652	646833	H.T.	
125	Vespa S 4T le & College	09-11	□	18 410 0601	564683		●	18 412 0711	497042	H.T.	●
125	Vespa Sprint 4T 3V le	14	□	18 410 0601	564683		●	18 412 0711	497042	H.T.	●
125	X Evo	07-12	■	18 412 0661	600475	H.T.	●	18 412 0661	600475	H.T.	●

● Terminale grosso - *Big end lever*
 ■ Colore nero - *Black*
 □ Colore lucido - *Glossy*

GRI Grimeca
 H.T. Heng Tong
 BRE Brembo

DX Destra - *Right*
 SX Sinistra - *Left*

LEVE
LEVERS



CC	MODELLO - MODEL	ANNO YEAR	COLORE - COLOUR	SINISTRA - LEFT		IMPIANTO SYSTEM	TERMINALE TERMINAL	DESTRA - RIGHT		IMPIANTO SYSTEM	TERMINALE TERMINAL
				CODICE RMS RMS CODE	RIF. ORIGINALE OEM NUMBER			CODICE RMS RMS CODE	RIF. ORIGINALE OEM NUMBER		
125	X7 Eu3	08	■	18 412 0661	600475	H.T.	●	18 412 0661	600475	H.T.	●
125	X7 Evo Ie Eu3	09-10	■	18 412 0661	600475	H.T.	●	18 412 0661	600475	H.T.	●
125	X8	04	■	18 412 0661	600475	H.T.	●	18 412 0661	600475	H.T.	●
125	X8	05-06	■	18 412 0661	600475	H.T.	●	18 412 0661	600475	H.T.	●
125	X8 Premium Eu2	06	■	18 412 0661	600475	H.T.	●	18 412 0661	600475	H.T.	●
125	X8 Premium Eu3	06-07	■	18 412 0661	600475	H.T.	●	18 412 0661	600475	H.T.	●
125	X8 Street Eu2	06-07	■	18 410 0851	647552			18 412 0661	600475	H.T.	●
125	X9	01-02	■	18 410 0601	564683		●	18 412 0601	646829	Bre.	
125	X9 Evolution	03	■	18 412 0721	497031	Bre.	●	18 412 0721	497031	Bre.	●
125	X9 Evolution	05-07	■	18 412 0661	600475	H.T.	●	18 412 0661	600475	H.T.	●
125	X9 Evolution Eu3	07	■	18 412 0661	600475	H.T.	●	18 412 0661	600475	H.T.	●
125	Zip	00-02	■	18 410 0531	562450			18 412 0111	494952	Gri.	
150	Fly	05-07	□	18 410 0181	561131			18 412 0731	646803	Gri.	●
150	Fly	05-07	□	18 410 0601	564683		●	18 412 0731	646803	Gri.	●
150	Fly	05-07	□	18 410 0181	561131			18 412 0652	646833	H.T.	
150	Fly	05-07	□	18 410 0601	564683		●	18 412 0711	497042	H.T.	●
150	Fly Eu3	08-10	□	18 410 0181	561131			18 412 0731	646803	Gri.	●
150	Fly Eu3	08-10	□	18 410 0601	564683		●	18 412 0731	646803	Gri.	●
150	Fly Eu3	08-10	□	18 410 0181	561131			18 412 0652	646833	H.T.	
150	Fly Eu3	08-10	□	18 410 0601	564683		●	18 412 0711	497042	H.T.	●
150	Liberty 4T Eu3	08	□	18 410 0601	564683		●	18 412 0731	646803	Gri.	●
150	Liberty 4T Eu3	08	□	18 410 0181	561131			18 412 0731	646803	Gri.	●
150	Liberty 4T Eu3	08	□	18 410 0181	561131			18 412 0652	646833	H.T.	
150	Liberty 4T Eu3	08	□	18 410 0601	564683		●	18 412 0711	497042	H.T.	●
150	Liberty 4T Sport Eu3	08	□	18 410 0181	561131			18 412 0731	646803	Gri.	●
150	Liberty 4T Sport Eu3	08	□	18 410 0601	564683		●	18 412 0731	646803	Gri.	●
150	Liberty 4T Sport Eu3	08	□	18 410 0181	561131			18 412 0652	646833	H.T.	
150	Liberty 4T Sport Eu3	08	□	18 410 0601	564683		●	18 412 0711	497042	H.T.	●
150	Liberty Moc 4T	09-10	□	18 410 0181	561131			18 412 0652	646833	H.T.	
150	Liberty Moc 4T	09-10	□	18 410 0601	564683		●	18 412 0711	497042	H.T.	●
150	Vespa Lx	05-06	□	18 410 0181	561131			18 412 0731	646803	Gri.	●
150	Vespa Lx	05-06	□	18 410 0601	564683		●	18 412 0731	646803	Gri.	●
150	Vespa Lx	05-06	□	18 410 0181	561131			18 412 0652	646833	H.T.	
150	Vespa Lx	05-06	□	18 410 0601	564683		●	18 412 0711	497042	H.T.	●
150	Vespa Lx 4T FL	09	□	18 410 0181	561131			18 412 0652	646833	H.T.	
150	Vespa Lx 4T FL	09	□	18 410 0601	564683		●	18 412 0711	497042	H.T.	●
150	Vespa Lx 4T 3V Ie - Touring	12-13	□	18 410 0601	564683		●	18 412 0711	497042	H.T.	●
150	Vespa Lx Eu3	06-08	□	18 410 0181	561131			18 412 0731	646803	Gri.	●
150	Vespa Lx Eu3	06-08	□	18 410 0601	564683		●	18 412 0731	646803	Gri.	●
150	Vespa Lx Eu3	06-08	□	18 410 0181	561131			18 412 0652	646833	H.T.	
150	Vespa Lx Eu3	06-08	□	18 410 0601	564683		●	18 412 0711	497042	H.T.	●
150	Vespa Lx Eu3 Ie	09-11	□	18 410 0181	561131			18 412 0652	646833	H.T.	
150	Vespa Lx Eu3 Ie	09-11	□	18 410 0601	564683		●	18 412 0711	497042	H.T.	●
150	Vespa Lx Touring	10-12	□	18 410 0181	561131			18 412 0652	646833	H.T.	
150	Vespa Lx Touring	10-12	□	18 410 0601	564683		●	18 412 0711	497042	H.T.	●
150	Vespa Primavera 4T-3V	13-14	□	18 410 0601	564683		●	18 412 0711	497042	H.T.	●
150	Vespa S 4T	08-09	□	18 410 0181	561131			18 412 0731	646803	Gri.	●



LEVE LEVERS

CC	MODELLO - MODEL	ANNO YEAR	COLORE - COLOUR	SINISTRA - LEFT		IMPIANTO SYSTEM	TERMINALE TERMINAL	DESTRA - RIGHT		IMPIANTO SYSTEM	TERMINALE TERMINAL
				CODICE RMS RMS CODE	RIF. ORIGINALE OEM NUMBER			CODICE RMS RMS CODE	RIF. ORIGINALE OEM NUMBER		
150	Vespa S 4T	08-09	□	18 410 0601	564683		●	18 412 0711	497042	H.T.	●
150	Vespa S 4T	08-09	□	18 410 0181	561131			18 412 0652	646833	H.T.	
150	Vespa S 4T	08-09	□	18 410 0601	564683		●	18 412 0711	497042	H.T.	●
150	Vespa S 4T Ie & College	09-12	□	18 410 0181	561131			18 412 0652	646833	H.T.	
150	Vespa S 4T Ie & College	09-12	□	18 410 0601	564683		●	18 412 0711	497042	H.T.	●
150	X8 Street Eu2	06-08	■	18 410 0851	647552			18 412 0661	600475	H.T.	●
180	Hexagon Gtx	00	■	18 412 0111	494952	Gri.		18 412 0111	494952	Gri.	
180	X9 Amalfi	00-03	■	18 410 0601	564683		●	18 412 0601	646829	Bre.	
200	Beverly	01-03	■	18 412 0601	646829	Bre.		18 412 0601	646829	Bre.	
200	Beverly	01-03	■	18 412 0661	600475	H.T.	●	18 412 0661	600475	H.T.	●
200	Carnaby	07-08	■	18 412 0721	497031	Bre.	●	18 412 0721	497031	Bre.	●
200	Carnaby	07-08	■	18 412 0601	646829	Bre.		18 412 0601	646829	Bre.	
200	Carnaby	07-08	■	18 412 0661	600475	H.T.	●	18 412 0661	600475	H.T.	●
200	Liberty	06	□	18 412 0601	646829	Bre.		18 412 0731	646803	Gri.	●
200	Liberty	06	□	18 410 0181	561131			18 412 0731	646803	Gri.	●
200	Liberty	06	□	18 410 0181	561131			18 412 0652	646833	H.T.	
200	Liberty	06	□	18 410 0601	564683		●	18 412 0711	497042	H.T.	●
200	Liberty 4T Eu3	07-08	□	18 410 0181	561131			18 412 0731	646803	Gri.	●
200	Liberty 4T Eu3	07-08	□	18 410 0601	564683		●	18 412 0731	646803	Gri.	●
200	Liberty 4T Eu3	07-08	□	18 410 0181	561131			18 412 0652	646833	H.T.	
200	Liberty 4T Eu3	07-08	□	18 410 0601	564683		●	18 412 0652	646833	H.T.	
200	Liberty 4T Sport Eu3	06-07	□	18 410 0181	561131			18 412 0731	646803	Gri.	●
200	Liberty 4T Sport Eu3	06-07	□	18 410 0601	564683		●	18 412 0731	646803	Gri.	●
200	Liberty 4T Sport Eu3	06-07	□	18 410 0181	561131			18 412 0652	646833	H.T.	
200	Liberty 4T Sport Eu3	06-07	□	18 410 0601	564683		●	18 412 0711	497042	H.T.	●
200	Liberty Rst	04	□	18 410 0181	561131			18 412 0731	646803	Gri.	●
200	Liberty Rst	04	□	18 410 0601	564683		●	18 412 0711	497042	H.T.	●
200	Liberty Sport	06	□	18 410 0181	561131			18 412 0731	646803	Gri.	●
200	Liberty Sport	06	□	18 410 0601	564683		●	18 412 0731	646803	Gri.	●
200	Liberty Sport	06	□	18 410 0181	561131			18 412 0652	646833	H.T.	
200	Liberty Sport	06	□	18 410 0601	564683		●	18 412 0711	497042	H.T.	●
200	Vespa Granturismo	06-07	□	18 412 0711	497042	H.T.	●	18 412 0711	497042	H.T.	●
200	X8	05-07	■	18 412 0661	600475	H.T.	●	18 412 0661	600475	H.T.	●
200	X9	02-03	■	18 412 0601	646829	Bre.		18 412 0601	646829	Bre.	
200	X9 Evolution	03	■	18 412 0721	497031	Bre.	●	18 412 0721	497031	Bre.	●
250	Beverly	06-07	■	18 412 0721	497031	Bre.	●	18 412 0721	497031	Bre.	●
250	Beverly	06-07	■	18 412 0661	600475	H.T.	●	18 412 0661	600475	H.T.	●
250	Beverly Eu3 Mic	07	■	18 412 0721	497031	Bre.	●	18 412 0721	497031	Bre.	●
250	Beverly Eu3 Mic	07	■	18 412 0601	646829	Bre.		18 412 0601	646829	Bre.	
250	Beverly Eu3 Mic	07	■	18 412 0661	600475	H.T.	●	18 412 0661	600475	H.T.	●
250	Beverly Ie Eu3	06-08	■	18 412 0601	646829	Bre.		18 412 0601	646829	Bre.	
250	Beverly Ie Eu3	06-08	■	18 412 0721	497031	Bre.	●	18 412 0721	497031	Bre.	●
250	Beverly Ie Eu3	06-08	■	18 412 0661	600475	H.T.	●	18 412 0661	600475	H.T.	●
250	Beverly Rst	04-05	■	18 412 0601	646829	Bre.		18 412 0601	646829	Bre.	
250	Beverly Rst	04-05	■	18 412 0661	600475	H.T.	●	18 412 0661	600475	H.T.	●
250	Beverly Rst	04-05	■	18 412 0721	497031	Bre.	●	18 412 0721	497031	Bre.	●
250	Beverly Sport	06-08	■	18 412 0721	497031	Bre.	●	18 412 0721	497031	Bre.	●

● Terminale grosso - Big end lever
 ■ Colore nero - Black
 □ Colore lucido - Glossy

GRI Grimeca
 H.T. Heng Tong
 BRE Brembo

DX Destra - Right
 SX Sinistra - Left

LEVE
LEVERS



CC	MODELLO - MODEL	ANNO YEAR	COLORE - COLOUR	SINISTRA - LEFT		IMPIANTO SYSTEM	TERMINALE TERMINAL	DESTRA - RIGHT		IMPIANTO SYSTEM	TERMINALE TERMINAL
				CODICE RMS RMS CODE	RIF. ORIGINALE OEM NUMBER			CODICE RMS RMS CODE	RIF. ORIGINALE OEM NUMBER		
250	Beverly Sport	06-08	■	18 412 0661	600475	H.T.	●	18 412 0661	600475	H.T.	●
250	Beverly Tourer Eu3	08-09	■	18 412 0721	497031	Bre.	●	18 412 0721	497031	Bre.	●
250	Beverly Tourer Eu3	08-09	■	18 412 0661	600475	H.T.	●	18 412 0661	600475	H.T.	●
250	Beverly Cruiser	07-09	□	18 412 0921	649196			18 412 0921	649196		
250	Carnaby	08	■	18 412 0721	497031	Bre.	●	18 412 0721	497031	Bre.	●
250	Carnaby	08	■	18 412 0661	600475	H.T.	●	18 412 0661	600475	H.T.	●
250	Hexagon Gtx	00	■	18 412 0111	494952	Gri.		18 412 0111	494952	Gri.	
250	Hexagon Gt-Gtx	98-00	□					18 412 0731	646803	Gri.	●
250	Hexagon Gt-Gtx	98-00	□	18 412 0731	646803	Gri.	●	18 412 0731	646803	Gri.	●
250	Mp3	06-08	■	18 412 0661	600475	H.T.	●	18 412 0601	646829	Bre.	
250	Mp3 Lt	09	■	18 412 0661	600475	H.T.	●	18 412 0721	497031	Bre.	●
250	Mp3 Mic	08-09	■	18 412 0661	600475	H.T.	●	18 412 0721	497031	Bre.	●
250	Vespa Gts, Gts Abs	05-13	□	18 412 0731	646803	Gri.	●	18 412 0731	646803	Gri.	●
250	Vespa Gts, Gts Abs	05-13	□	18 412 0711	497042	H.T.	●	18 412 0711	497042	H.T.	●
250	Vespa Gts, Gts Abs	05-13	□	18 412 0652	646833	H.T.		18 412 0652	646833	H.T.	
250	X Evo	07-13	■	18 412 0661	600475	H.T.	●	18 412 0661	600475	H.T.	●
250	X7 Eu3	08	■	18 412 0661	600475	H.T.	●	18 412 0661	600475	H.T.	●
250	X8 Eu3	05-08	■	18 412 0661	600475	H.T.	●	18 412 0661	600475	H.T.	●
250	X9	00-01	■	18 412 0721	497031	Bre.	●	18 412 0721	497031	Bre.	●
250	X9	00-01	■	18 412 0601	646829	Bre.		18 412 0601	646829	Bre.	
250	X9 Evolution	04-06	■	18 412 0661	600475	H.T.	●	18 412 0661	600475	H.T.	●
300	Beverly Tourer Eu3	09-10	■	18 412 0721	497031	Bre.	●	18 412 0721	497031	Bre.	●
300	Beverly Tourer Eu3	09-10	■	18 412 0661	600475	H.T.	●	18 412 0661	600475	H.T.	●
300	Beverly Rst 4T 4V le Eu3	10-14	■	18 412 0661	600475	H.T.	●	18 412 0721	497031	Bre.	●
300	Carnaby Cruiser	09-12	■	18 412 0661	600475	H.T.	●	18 412 0661	600475	H.T.	●
300	Canrnaby Cruiser	09-12	□	18 412 1001	665870	H.T.	●	18 412 1001	665870	H.T.	●
300	Mp3 le LT	10-11	■	18 412 0661	600475	H.T.	●	18 412 0721	497031	Bre.	●
300	Mp3 le Mic	10-11	■	18 412 0661	600475	H.T.	●	18 412 0721	497031	Bre.	●
300	Mp3 4T 4V le Lt Ibrido	10 -13	■	18 412 0661	600475	H.T.	●	18 412 0721	497031	Bre.	●
300	Mp3 Yourban Erl	11	■	18 412 0661	600475	H.T.	●	18 412 0721	497031	Bre.	●
300	Vespa Gts le	12-14	□	18 412 0711	497042	H.T.	●	18 412 0711	497042	H.T.	●
300	Vespa Gts le Touring	11-12	□	18 412 0711	497042	H.T.	●	18 412 0711	497042	H.T.	●
300	Vespa Gts Super	08-10	□	18 412 0711	497042	H.T.	●	18 412 0711	497042	H.T.	●
300	Vespa Gts Super	08-10	□	18 412 0652	646833	H.T.		18 412 0652	646833	H.T.	
300	Vespa Gts Super Sport	10-13	□	18 412 0711	497042	H.T.	●	18 412 0652	646833	H.T.	
300	X7 Evo le Eu3	09-10	■	18 412 0661	600475	H.T.	●	18 412 0661	600475	H.T.	●
350	Beverly 4T 4V le	11-14	■	18 412 0601	646829	Bre.		18 412 0601	646829	Bre.	
400	Beverly Eu3	06-07	■	18 412 0601	646829	Bre.		18 412 0601	646829	Bre.	
400	Beverly Eu3	06-07	■	18 412 0721	497031	Bre.	●	18 412 0721	497031	Bre.	●
400	Beverly Eu3	06-07	■	18 412 0661	600475	H.T.	●	18 412 0721	497031	Bre.	●
400	Beverly Tourer Eu3	08-10	■	18 412 0721	497031	Bre.	●	18 412 0721	497031	Bre.	●
400	Beverly Tourer Eu3	08-09	■	18 412 0601	646829	Bre.		18 412 0601	646829	Bre.	
400	Beverly Tourer Eu3	08-09	■	18 412 0661	600475	H.T.	●	18 412 0721	497031	Bre.	●
400	Mp3	07-08	■	18 412 0661	600475	H.T.	●	18 412 0721	497031	Bre.	●
400	Mp3 le Lt Touring	11	■	18 412 0661	600475	H.T.	●	18 412 0721	497031	Bre.	●
400	Mp3 le Lt Sport	08-10	■	18 412 0661	600475	H.T.	●	18 412 0721	497031	Bre.	●
400	Mp3 Mic	08-11	■	18 412 0661	600475	H.T.	●	18 412 0721	497031	Bre.	●



LEVE LEVERS

CC	MODELLO - MODEL	ANNO YEAR	COLORE - COLOUR	SINISTRA - LEFT		IMPIANTO SYSTEM	TERMINALE TERMINAL	DESTRA - RIGHT		IMPIANTO SYSTEM	TERMINALE TERMINAL
				CODICE RMS RMS CODE	RIF. ORIGINALE OEM NUMBER			CODICE RMS RMS CODE	RIF. ORIGINALE OEM NUMBER		
400	X Evo	07-11	■	18 412 0661	600475	H.T.	●	18 412 0721	497031	Bre.	●
400	X8 Eu3	06-08	■	18 412 0661	600475	H.T.	●	18 412 0721	497031	Bre.	●
500	Beverly	02-04	■	18 412 0721	497031	Bre.	●	18 412 0721	497031	Bre.	●
500	Beverly	05-06	■	18 412 0601	646829	Bre.		18 412 0601	646829	Bre.	
500	Beverly	05-06	■	18 412 0661	600475	H.T.	●	18 412 0721	497031	Bre.	●
500	Beverly Eu3	06-08	■	18 412 0721	497031	Bre.	●	18 412 0721	497031	Bre.	●
500	Beverly Eu3	06-08	■	18 412 0601	646829	Bre.		18 412 0601	646829	Bre.	
500	Beverly Eu3	06-08	■	18 412 0661	600475	H.T.	●	18 412 0721	497031	Bre.	●
500	Beverly Cruiser	07-12	□	18 412 0921	649196			18 412 0921	649196		
500	X9	01-02	■	18 412 0721	497031	Bre.	●	18 412 0601	646829	Bre.	
500	X9 Evolution Abs	03-05	□	18 412 0531	600829	Gri.		18 412 0531	600829	Gri.	
500	X9 Evolution	03-05	■	18 412 0601	646829	Bre.		18 412 0601	646829	Bre.	
500	X9 Evolution	06-07	■	18 412 0721	497031	Bre.	●	18 412 0721	497031	Bre.	●
500	X9 Evolution Abs	06-07	□	18 412 0531	600829			18 412 0531	600829		
SUZUKI											
50	Aj Zz Sepia S	95-97	□					18 412 0621	57421-29C00-000		
110	Ug Hokuto	00	□					18 412 0621	57421-29C00-000		
125	An S-Y	95-00	□					18 412 0621	57421-29C00-000		
125	Uc Epicuro X-K1	99-01	□					18 412 0621	57421-29C00-000		
125	Uh Burgman K2-K6	02-03	□	18 410 0521	57500-14F00-000			18 412 0631	57421-14F00-000		
125	Uh Burgman K7-L0	07-10	□	18 410 0521	57500-14F00-000			18 412 0631	57421-14F00-000		
125	Uh Burgman L1	11	□	18 410 0521	57500-14F00-000			18 412 0631	57421-14F00-000		
125	Ux Sixteen K8-L0	08-10	□	18 410 0521	57500-14F00-000			18 412 0631	57421-14F00-000		
125	Ux Sixteen L1	11	□	18 410 0521	57500-14F00-000			18 412 0631	57421-14F00-000		
150	Ant-Y	96-00	□					18 412 0621	57421-29C00-000		
150	Uc Epicuro X-K1	99-01	□					18 412 0621	57421-29C00-000		
150	Uh Burgman K2-K6	02-03	□	18 410 0521	57500-14F00-000			18 412 0631	57421-14F00-000		
150	Ux Sixteen K8-L0	08-10	□	18 410 0521	57500-14F00-000			18 412 0631	57421-14F00-000		
150	Ux Sixteen L1	11	□	18 410 0521	57500-14F00-000			18 412 0631	57421-14F00-000		
200	Uh Burgman K7-L0	07-10	□	18 410 0521	57500-14F00-000			18 412 0631	57421-14F00-000		
200	Uh Burgman L1-L3-L4	11-14	□	18 410 0521	57500-14F00-000			18 412 0631	57421-14F00-000		
250	An Burgman K3-K6	03-06	□	18 410 0521	57500-14F00-000			18 412 0631	57421-14F00-000		
250	An Burgman W-K2	98-02	□	18 410 0521	57500-14F00-000			18 412 0631	57421-14F00-000		
400	An Burgman K3-K6	03-06	□	18 410 0521	57500-14F00-000			18 412 0631	57421-14F00-000		
400	An Burgman K7-L0	07-10	□	18 410 0521	57500-14F00-000			18 412 0631	57421-14F00-000		
400	An Burgman L1-L2-L3	11-13	□	18 410 0521	57500-14F00-000			18 412 0631	57421-14F00-000		
400	An Burgman X-K2	99-02	□	18 410 0521	57500-14F00-000			18 412 0631	57421-14F00-000		
YAMAHA											
50	Bw'S	04-09	■	18 410 0401	5JH-H3912-00			18 412 0481	5JH-H3922-00		
50	Bw'S	10-11	■	18 410 0401	5JH-H3912-10			18 412 0481	5JH-H3922-00		
50	Bw'S Tamburo/Drum		■	18 410 0010				18 412 0010	3VLH39221000		
50	Bw'S Bump	97-98	□	18 410 0161	4SB-H3912-00			18 412 0171	4SB-H3922-00		
50	Bw'S Naked	03	■	18 410 0401	5JH-H3912-00			18 412 0821	5NTH39220000		
50	Bw'S Naked	04	■	18 410 0401	5JH-H3912-00			18 412 0481	5JH-H3922-00		
50	Bw'S Naked	09-11	■	18 410 0401	5JH-H3912-00			18 412 0481	5JH-H3922-00		
50	Bw'S Ng	97-98	□	18 410 0161	4SB-H3912-00			18 412 0171	4SB-H3922-00		
50	Bw'S Ng	01-06	■	18 410 0401	5JH-H3912-00			18 412 0481	5JH-H3922-00		

● Terminale grosso - Big end lever
 ■ Colore nero - Black
 □ Colore lucido - Glossy

GRI Grimeca
 H.T. Heng Tong
 BRE Brembo

DX Destra - Right
 SX Sinistra - Left

LEVE
LEVERS



CC	MODELLO - MODEL	ANNO YEAR	COLORE - COLOUR	SINISTRA - LEFT		IMPIANTO SYSTEM	TERMINALE TERMINAL	DESTRA - RIGHT		IMPIANTO SYSTEM	TERMINALE TERMINAL
				CODICE RMS RMS CODE	RIF. ORIGINALE OEM NUMBER			CODICE RMS RMS CODE	RIF. ORIGINALE OEM NUMBER		
50	Bw'S Ng Cat	99-00	■	18 410 0421	4SB-H3912-10			18 412 0511	4SB-H3922-10		
50	Bw'S Original	97-98	■	18 410 0421	4SB-H3912-10			18 412 0161	4VV-H3922-00		
50	Bw'S Original	99-00	■	18 410 0421	4SB-H3912-10			18 412 0471	4VV-H3922-10		
50	Bw'S Original S. Special	99-00	□	18 410 0161	4SB-H3912-00						
50	Bw'S Original/Eu2	01-03	■	18 410 0401	5JH-H3912-00			18 412 0821	5NTH39220000		
50	Bw'S R	01	■	18 410 0401	5JH-H3912-00			18 412 0821	5NTH39220000		
50	Cw Bw'S L	03	■	18 410 0401	5JH-H3912-00			18 412 0821	5NTH39220000		
50	Cw Bw'S L	04	■	18 410 0401	5JH-H3912-00			18 412 0481	5JH-H3922-00		
50	Cw Bw'S Original Eu2	02	■	18 410 0401	5JH-H3912-00			18 412 0821	5NTH39220000		
50	Cw Bw'S Original Sp	02	■	18 410 0401	5JH-H3912-00			18 412 0821	5NTH39220000		
50	Cw Rs Spy	95-98	□	18 410 0161	4SB-H3912-00			18 412 0181	4TD-H3922-00		
50	Cr Z	91-95	■	18 410 0131	1NT-H3912-00			18 412 0151	2NA-83922-01		
50	Cs Jog R	02-11	■	18 410 0401	5JH-H3912-00			18 412 0891	5RWH392200		
50	Cs Jog R Eu2	02-09	■	18 410 0401	5JH-H3912-00			18 412 0891	5RWH392200		
50	Ct S/Ss	90-95	■	18 410 0131	1NT-H3912-00						
50	Ew Slider	00-02	■	18 410 0401	5JH-H3912-00			18 412 0481	5JH-H3922-00		
50	Ya R Axis	95	■	18 410 0151	4KH-H3912-00			18 412 0151	2NA-83922-01		
50	Ya Za Jog Z	95-96	■					18 412 0151	2NA-83922-01		
50	Yh Why/Eu1/Eu2	98-09	□	18 410 0411	5EU-H3912-00			18 412 0491	5EU-H3922-00		
50	Yq Aerox L/R/Eu2	97-08	□	18 412 0391	5BR-H3912-01			18 412 0391	5BR-H3912-01		
50	Yq Aerox R Replica	08	□	18 412 0391	5BR-H3912-01			18 412 0391	5BR-H3912-01		
50	Yq Aerox	09-12	■	18 412 0841	3C6H3912000			18 412 0841	3C6H3912000		
50	Ym Breeze	94-95	■	18 410 0151	4KH-H3912-00			18 412 0151	2NA-83922-01		
50	Yn Neo'S/Eu2	97-06	□	18 410 0141	5AD-H3912-02			18 412 0401	5AD-H3922-01		
50	Yn Neo'S	07-11	■	18 410 0401	5JH-H3912-00						
50	Yn F Neo's \$	09-11	■	18 410 0401	5JH-H3912-00						
100	Yn Neo'S	00-01	□	18 410 0141	5AD-H3912-02			18 412 0401	5AD-H3922-01		
100	BW'S	99-01	□	18 410 0801	4VPH39121000						
125	BW'S	10	□	18 410 0801	4VPH39121000						
125	NXC CYGNUS	04-11	□	18 410 0781	5MLH39121000			18 412 0871	5MLH39122000		
125	Vp X-City	08-10	■	18 410 0621	1B9-H3922-00			18 412 0751	1B9-H3912-00		
125	Xn Teo'S	00-01	■	18 410 0491	5DS-H3912-01			18 412 0601	5DS-H3922-01		
125	Xq Maxster	01-02	■	18 412 0601	5DS-H3922-01			18 412 0601	5DS-H3922-01		
125	Yp Majesty	99-00	■	18 410 0491	5DS-H3912-01			18 412 0601	5DS-H3922-01		
125	Yp Majesty	01-09	■	18 412 0601	5DS-H3922-01			18 412 0601	5DS-H3922-01		
125	Yp Majesty E	01-09	■	18 412 0601	5DS-H3922-01			18 412 0601	5DS-H3922-01		
125	Yp R X-Max	06-10	■	18 410 0621	1B9-H3922-00			18 412 0751	1B9-H3912-00		
150	Xn Teo'S	00-02	■	18 410 0491	5DS-H3912-01			18 412 0601	5DS-H3922-01		
150	Xq Maxster	01-02	■	18 412 0601	5DS-H3922-01			18 412 0601	5DS-H3922-01		
150	Yp Majesty	00	■	18 410 0491	5DS-H3912-01			18 412 0601	5DS-H3922-01		
150	Yp Majesty	01-02	■	18 412 0601	5DS-H3922-01			18 412 0601	5DS-H3922-01		
180	Yp Majesty E	03-08	■	18 412 0601	5DS-H3922-01			18 412 0601	5DS-H3922-01		
250	Vp X-City	07-10	■	18 410 0621	1B9-H3922-00			18 412 0751	1B9-H3912-00		
250	Yp Majesty	00-03	■	18 410 0501	5CG-83912-10			18 412 0611	5CG-83922-01		
250	Yp Majesty Dx	98-00	■	18 410 0501	5CG-83912-10			18 412 0611	5CG-83922-01		
250	Yp Majesty/Abs	00-06	■	18 410 0501	5CG-83912-10			18 412 0611	5CG-83922-01		
250	Yp R X-Max/Black	05-10	■	18 410 0621	1B9-H3922-00			18 412 0751	1B9-H3912-00		



LEVE LEVERS

CC	MODELLO - MODEL	ANNO YEAR	COLORE - COLOUR	SINISTRA - LEFT		IMPIANTO SYSTEM	TERMINALE TERMINAL	DESTRA - RIGHT		IMPIANTO SYSTEM	TERMINALE TERMINAL
				CODICE RMS RMS CODE	RIF. ORIGINALE OEM NUMBER			CODICE RMS RMS CODE	RIF. ORIGINALE OEM NUMBER		
300	Vp Versity/Xc	03-08	■	18 412 0601	5DS-H3922-01			18 412 0601	5DS-H3922-01		
400	Yp Majesty	04-08	■	18 410 0561	5GJ-83912-00			18 412 0561	5GJ-83922-00		
400	Majesty	09-11	■	18 410 0791	4B5839120000			18 412 0851	4B5839220000		
500	Xp T-Max/Ie/Abs/Black	01-07	■	18 410 0561	5GJ-83912-00			18 412 0561	5GJ-83922-00		
500	Xp T-Max	08-12	■	18 410 0791	4B5839120000			18 412 0851	4B5839220000		
530	Xp T-Max	12-14	■	18 410 0791	4B5839120000			18 412 0851	4B5839220000		
530	Xp T-Max Abs	12-14	■	18 410 0791	4B5839120000			18 412 0851	4B5839220000		

18 404 0020

APRILIA 50: Amico Sport • Lk • Lx • GL • GLE • Amico Yunger • Sr Replica • Urban Kid • Viper
PEUGEOT 50: Sv 125 • Sv



18 404 0040

APRILIA 50: Scarabeo
Freno Disco - *Brake Disc*



18 404 0050

APRILIA 50: Scarabeo 03



18 404 0060

APRILIA 50: Habana • Sr 96 • Sr Wwww



18 404 0590

APRILIA 50: Scarabeo < 05 • Scarabeo 4T < 05
100: Scarabeo 4T 05
Leva nera - *Black lever*



18 404 0580

APRILIA 100: Scarabeo 00-04
Leva nera - *Black lever*



18 404 0570

DERBI 50: Fenix • Senda R Drd • X-Treme Racer • Xrace Sm 06 • X-Treme R • 50m 06
GILERA 50: Rcr • Smt 03



18 404 0090

GILERA 50: Typhoon • Storm 97
Leva in alluminio pressofuso, fulcro leva 29 mm
Die cast aluminium lever, lever fulcrum 29 mm
(R.O. 272002)



18 404 0600

GILERA 50: Typhoon < 05 • Liberty 2T < 05 • Liberty 4T < 05 • Nrg < 02 • Vespa Lx 4T < 05 • Vespa 4T 4V < 08 • Vespa Lx 4T < 05 • Vespa S 2T < 07 • Vespa S-Lx 2T < 05 • Fly 4t < 06
100: Fly 4t < 04
125: Fly 05-08 • Liberty 4T 04-08
150: Fly < 05 • Liberty 4T < 08 Vespa S-Lx < 05 • Vespa S 4T < 08
200: Liberty 4T < 07 • Liberty St < 04 • Leva nera - *Black lever*
(R.O. CM063804)



18 404 0140

MBK 50: Ovetto
YAMAHA 50: Neo's



18 404 0160

MBK 50: Booster R Spirit



18 404 0520

MBK 50: Booster Next G 00 • Booster Spirit 00
YAMAHA 50: Bw's 00 • Bw's N.G. 00



18 404 0190

PEUGEOT 50: Buxy • Speedake • Zenith
(Destro-Right)



18 404 0100

PIAGGIO 50: Ntt • Nrg • Typhoon Martini
• Typhoon Street



18 404 0110

PIAGGIO 50: Nrg • Thyphoon 97
Leva in alluminio pressofuso, fulcro leva 29 mm
Die cast aluminium lever, lever fulcrum 29 mm
(R.O. 274998)



18 404 0210

PIAGGIO 50: Free 98-99 • Free F1 97
(R.O. 564704 - Ex 560026)



18 404 0240

PIAGGIO 50: Quartz • Zip Fast Rider
125-150: Skipper
(R.O. 267955)



18 404 0300

PIAGGIO 50: Liberty 2T 97-05 • Liberty 4T 00-02
Vespa ET2 97-05 • Vespa ET2 Iniezione 97-05
50-125: Vespa ET4 90-05
(R.O. 274211)



18 404 0410 

PIAGGIO 50: Ciao Px
(R.O. 188056)
Leva in plastica - *Plastic lever*



18 404 0430 

PIAGGIO 50: Si 90-91
(R.O. 229004)
Leva in alluminio - *Aluminium lever*



18 404 0470 

PIAGGIO 50: Zip Rst 98-99
125: Skipper 94-97
(R.O. 274496)



18 404 0640 

PIAGGIO 50: Liberty 4T Delivery - Single 10-14
125: Liberty 4T Eu3 Delivery - Single 07-12
Modello poste Italiane
(R.O. 601652)



18 404 0650 

PIAGGIO 50: Liberty 4T Delivery Tnt 09 • Liberty 4T Ptt (Deu) 07-12 • Liberty 4T Ptt - Double 09-12 • **125:** Liberty 4T Eu3 Delivery - Tnt 08-09 • Liberty Rst Ptt 05-11
(R.O. 601013)



18 404 0660 

PIAGGIO 50: Ciao Sc 78
(R.O. 162806)
Leva in acciaio - *Steel lever*



COMANDI PORTALEVA  - LEVER SUPPORT

18 404 0631 

KYMCO 50: Agility Carry 11
(R.O. 00153431)



18 408 0020

APRILIA 50: Amico Sport • Lx • Sr 92-93
(R.O. AP8218137)



18 408 0030

APRILIA 50: Scarabeo 97
(R.O. AP8218214)



18 408 0050

APRILIA 50: Scarabeo
Freno Disco - Brake disc



18 408 0110

APRILIA 50: Sonic • Derbi Atlantis • Italjet
Torpedo • Torpedo • **MBK 50:** Ovetto
PIAGGIO 50-100: Diesis
YAMAHA 50: Neo's **APRILIA 125:** Leonardo
125 St Post 99
150: Leonardo Post 99
250: Leonardo Post 99



18 408 0140

DERBI 50: Vamos
PEUGEOT 50: Buxy • Speedake • Zenith
50-125: Sv
RIZZATO 50: Scooter
Corsa Filo Gas mm 20/70°
Throttle stroke mm 20/70°



18 408 0510

DERBI 125: Senda Sr 4T • Sm R 06
RIEJU 50: Enduro Smx • Smx Pro > 06 • Mrx •
Mrx Pro 06 • Rr 06 • Smx • Mrx < 06 • Spike 06
1 cavo - 1cable



18 408 0080

GILERA 50: Typhoon
PIAGGIO 50: Ape Mix
(R.O. 566485)



18 408 0740

KTM Off Road
HUSQVARNA: 4T



18 408 0750

COMANDO GAS KRK EVO
THROTTLE HANDLES KRK EVO
KTM: 4T 16>
HUSQVARNA: 4T 16>



NEW

18 408 0130

MBK 50: Booster R



18 408 0430

MBK 50: Booster Next G 00 • Booster R 04 •
Mbk Booster Spirit 00 • Stunt
YAMAHA 50: Bw's 00 • Bw's N.G. 00 • Slider •
RIEJU 50: Rs2 Matrix Pro 07 • Rs2 Nkd 07
Senza Manopole - *Without grip*



18 408 0680

MOTO GUZZI 750: Brevia • Nevada • V7 Cafè
Classic • Cafè Racer
(R.O. GU32603310)



18 408 0090

PIAGGIO 50: Nrg 94-96 • Ntt 95-96
(R.O. 564703)



18 408 0100

PIAGGIO 50: Nrg • Typhoon 97
Leva In Alluminio Pressofuso
Die cast aluminium lever
(R.O. 957270)



18 408 0200

PIAGGIO 50: Zip 95
(R.O. 274531)



18 408 0330

PIAGGIO 50: Ciao Px 88
Leva in plastica - *Plastic lever*
(R.O. 188057 Ex 178583)



18 408 0350

PIAGGIO 50: Si 90-91
Leva in alluminio - *Aluminium lever*
(R.O. 228969)



18 408 0400

PIAGGIO 50: Free 98-99 • Free F1 97
(R.O. 560026)



18 408 0490

PIAGGIO 50: Nrg • Vespa Lx 4T
125: Beverly
200: Carnaby • Beverly
Senza manopole e trasmissione
Without grip and trasmission
(R.O. CM060915)



18 408 0500

PIAGGIO 50: Vespa Lx 4T
125: Vespa Lx 4T
Lunghezza tubo 112 mm
Tube lenght 112 mm
(R.O. CM060977)



18 408 0650

PIAGGIO 50: Ciao Sc
Leva in acciaio - *Steel lever*
(R.O. 162804)



18 408 0470

PIAGGIO 125: Liberty 4T (Universale)
250: Mp3 Rst • X9 • X7 ie
300: Vespa Gts
400: Beverly
500: X9
(R.O. CM079724)



18 408 0480

PIAGGIO 125-150: Beverly • Mp3 • Vespa Gts
X9 • X Evo
Lunghezza tubo 124 mm
Tube lenght 124 mm
(R.O. CM060975)



18 408 0520

Standard Scooter - *Scooter standard*
2 cavi - *2 cables*



18 408 0530

Modello Moped - *Moped model*
Corsa massima - *Max stroke*
mm 43 (36 mm/148°) • Monocavo



18 408 0540

Modello Commandos - *Commandos model*
Corsa massima - *Max stroke*
Senza manopole - *Without grip*
mm 42 (36 mm/79°)



18 408 0560

Modello Commandos - *Commandos model*
Senza manopole - *Without grip*
Corsa massima - *Max stroke*
mm 47 (36 mm/75°)



18 408 0570

Racing
Corsa massima - *Max stroke mm 44 (36 mm/90°)*
Ghiera Bianca apertura - *White ring opening 55°*
Ghiera Rossa apertura - *Red ring opening 53°*
Ghiera Verde apertura - *Green ring opening 60°*
Senza manopola - *Without grip*



18 408 0580

Gas Cross Con Carrucola
Throttle Controls With Pulley
Modello HR Cross
2T, completo di coprigas
2 strokes, with throttle covering
Corsa massima - *Max stroke*
mm 48,5 (36 mm/66°)



18 408 0590

Modello HR Cross - *HR Cross model*
2T, senza manopola
Cross 2 strokes - Without grip
Corsa massima - *Max stroke*
mm 48,5 (36 mm/66°)



18 408 0610

Modello Endross - *Endross Model*
con movimento orizzontale,
ghiera doppia corsa
with horizontal run, dual stroke ring nut
Corsa massima - *Max stroke mm 48*
(versione cross - *cross version 36 mm/67°*)
(versione enduro - *enduro version 36 mm/78°*)



18 408 0620

Modello Commandos - *Commandos model*
Corsa massima - *Max stroke*
mm 42 (36 mm/79°)
Monocavo - *Single cable*



18 408 0630

Modello da Trial - *Trial Model*
Corsa massima - *Max stroke*
mm 44 (28 mm/124°)



18 408 0640

Acceleratore elettrico con potenziometro
5 KΩ - durata media 350.000 cicli
Electric accelerator with potentiometer 5KΩ
average life 350.000 actions



18 408 0660

Moto Rally Cafè racer
Rally Cafè racer Motorcycle
Monocavo - *Single cable*
Corsa massima 25 - *Max stroke mm 25*



18 408 0670

Moto Modello Lario - *Lario Model*
Monocavo - *Single cable*
Corsa massima 25 - *Max stroke mm 25*



12 195 0010 

MOLLA RITORNO LEVA
LEVER RETURN SPRING
Conf. 50 pz. - 50 pcs



12 195 0020 

MOLLA RITORNO LEVA SX
LEVER RETURN SPRING LH
Conf. 50 pz. - 50 pcs



12 185 8250 

REGOLATORE MM 8
MM 8 ADJUSTING SCREW
Conf 10 pz - 10 pcs



12 185 8260 

REGOLATORE MM 5
MM 5 ADJUSTING SCREW
Conf 50 pz - 50 pcs



12 185 8270 

REGOLATORE MM 6
MM 6 ADJUSTING SCREW
Conf 50 pz - 50 pcs



12 185 8280 

NOTTOLINO PER LEVA CROSS
CROSS LEVER RATCHET
Conf 50 pz - 50 pcs



12 185 8290 

NOTTOLINO PER LEVA NYLON
NYLON LEVER RATCHET
Conf 50 pz - 50 pcs



12 185 8480 

CORSOIO CON VITE
SLIDING BLOCK WITH SCREW
PIAGGIO 50: Ciao • Si
(R.O. 229935)



12 186 0310 

SDOPPIATORE - SPLITTER
PIAGGIO 50: Ape • Liberty • Nrg • Typhoon •
Vespa • Zip • Sr • **150:** Hexagon • Skipper
GILERA 50: Runner • Stalker
DERBI 50: Boulevard 2T • Sonar 2T
(R.O. 269571)



18 414 0010 

LEVA STARTER - STARTER LEVER
MBK 50: Boster 92 Booster R • Spirit 96
(F.d. Grimeca)



18 414 0020 

COMANDO STARTER - STARTER CONTROL
APRILIA 50: Rally 96 LC (Fd. Grimeca) • Sr 96
• Sr Viper 93 • Urban Kid 93



18 414 0070 

COMANDO STARTER - STARTER CONTROL
STANDARD



16 362 0210 

TRASMISSIONE COMANDO GAS
KRR 03 UNIVERSALE
KRR 03 UNIVERSAL THROTTLE CABLE SET
Per comando gas 18 408 0570
For throttle control 18 408 0570



12 186 0300 

KIT PIPETTE GUIDAFILO UNIVERSALI
PER COMANDI GAS XM2
KIT OF UNIVERSAL CABLE BENDS
FOR XM2 THROTTLE CONTROLS
Per comando gas 18 408 0570
For throttle control 18 408 0570



▶ MANOPOLE

HAND GRIPS

▶ **RMS**
YOUR BEST PARTNER

▶ **domino**
COMANDI MOTO

18 416 0700



HONDA 300: Sh 07-14
700: Integra 12-13
Nera - *Black*



18 416 0040



PIAGGIO 50: Ciao 80-88 • Si 79-88 • Ape P 80-85 • Ape Tmp 85-89 • Bravo 3 87-90 • Bravo Erre 2 75-81
Nero - *Black*
(R.O. 185256)



18 416 0050



PIAGGIO 50: Ciao Tre 71-99 • Ciao 80-88 Superbravo 85-90 • Ape Tmp 85-89 • Superbravo 3 87-90
Nero - *Black*
(R.O. 233072/5)



18 416 0060



PIAGGIO 50: Sfera Maquillage 2 94 • Sfera 91-03 • Si FL2 91-97
Nero - *Black*
(R.O. 267205/6)



18 416 0070



PIAGGIO 50: Diesis 01 • Fly 05-11 • Free FL 95-02 • Nrg 94-17 • Ntt 95-96 • Sfera Rst 95-97 • Typhoon 01-04 • Vespa Lx 05-08 • Vespa S 07-12 • Zip 95-16
100: Fly 06-14 • Free 02-03 • Zip 06-10
125: Fly 05-11 • Sfera 95-97 • Skipper 94-97 • Vespa Lx 05-08 • Zip 00-02
150: Fly 05-11 • Vespa Lx 05-08 • Vespa S 08-09
Nero - *Black*
(R.O. 274489 - 274490)

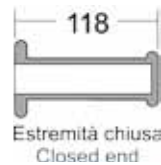

18 416 0080



PIAGGIO 50: Vespa 50 - FL - Hp
Nero - *Black*
(R.O.274489)

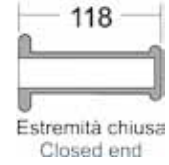

18 416 0580



PIAGGIO 50: Nrg
125-200: Vespa Granturismo • X Evo • X8 • X9
125-200-250: Carnaby • X9
250-300: Gts • Hexagon • 125-200 • X9
400-500: Beverly • X9
Nera - *Black*
(R.O. 271452/3)



18 416 0590



PIAGGIO: Vespa Gt - Gtv
Nera - *Black*
(R.O. 648550/1)



18 416 0600



PIAGGIO 125-250: Beverly Eu3 - Sport - Mic - Rst - Tourer 07-10 • Beverly 01-03
300: Beverly Tourer Eu3 09-10
Nera - *Black*
(R.O. 583255/6)



18 416 0750

SUZUKI
Nera - Black



18 416 0720

YAMAHA SCOOTER
Nera - Black



18 416 0150

Mod. **SCOOTER**
Nero - Black



18 416 0020

Mod. **GP**
Nero - Black

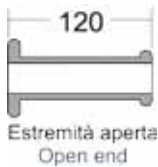

18 416 0420

Mod. **XM2**
Nero - Blu - Black - Blue



18 416 0400

Mod. **XM2**
Nero - Grigio - Black - Grey

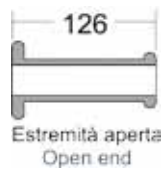

18 416 0410

Mod. **XM2**
Nero - Rosso - Black - Red



18 416 0430



Mod. **CROSS**
Nero - Rosso - *Black - Red*



18 416 0440



Mod. **CROSS**
Nero - Giallo - *Black - Yellow*



18 416 0450



Mod. **CROSS**
Nero - Grigio - *Black - Grey*

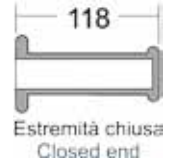

18 416 0460



Mod. **CROSS/ENDURO**
Nero - *Black*



18 416 0470



Mod. **CROSS/ENDURO**
Azzurra - *Blue*



18 416 0480



Mod. **CROSS/ENDURO**
Rossa - *Red*



18 416 0500



Mod. **TRIAL**
Grigio - Nera - *Grey - Black*

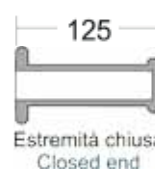

18 416 0510



Mod. **TRIAL**
Nera - Rossa - *Black - Red*



18 416 0520



Mod. **TRIAL**
Nera - Grigia - *Black - Grey*



18 416 0530 

Mod. **DAKAR**
Nera - Black



18 416 0540 

Mod. **DAKAR**
Nera - Black



18 416 0570 

Mod. **INDOOR**
Nera - Black

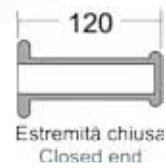

18 416 0900 

Mod. **DAYTONA**
Nera - Black

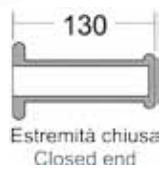

18 416 0910 

Mod. **DAYTONA**
Para Compound

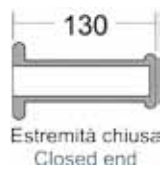

18 416 0710 

Mod. **RETRÒ**
Para Compound

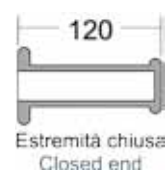

18 416 0930 

Mod. **CAFE' RACER**
Para Compound

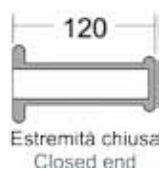

18 416 0730 

Mod. **DSH SOFT PLUS**
Grigio - Grey

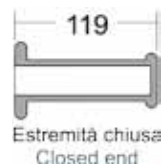

18 416 0740 

Mod. **DSH SOFT PLUS**
Verde - Green



18 416 0620



Mod. **DSH**
Nera-Rossa - *Black-Red*



18 416 0630



Mod. **DSH**
Nera-Verde - *Black-Green*



18 416 0640



Mod. **DSH**
Nera-Arancio - *Black-Orange*



18 416 0650



Mod. **DSH**
Grigio-Arancio - *Grey-Orange*

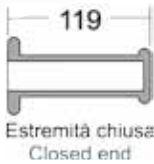

18 416 0660



Mod. **DSH**
Nera-Grigio - *Black-Grey*

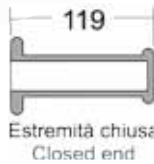

18 416 0760



Mod. **DSH DESERT**

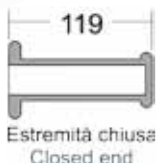

18 416 0770



Mod. **DSH JUNGLE**

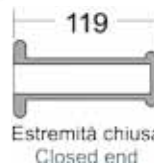

18 416 0780



Mod. **DSH URBAN**

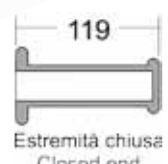

18 416 0790

Mod. **DSH SNAKE**
Giallo - Nera - *Yellow - Black*

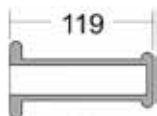

Estremità chiusa
Closed end

18 416 0800

Mod. **DSH SNAKE**
Blu - Bianco - *Blue - White*

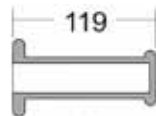

Estremità chiusa
Closed end

18 416 0810

Mod. **DSH SNAKE**
Arancio - Nera - *Orange - Black*

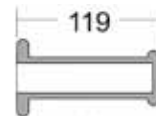

Estremità chiusa
Closed end

18 416 0820

Mod. **DSH SNAKE**
Verde - Nera - *Green - Black*

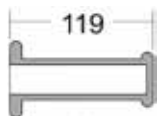

Estremità chiusa
Closed end

18 416 0830

Mod. **DSH SNAKE**
Rosso - Nera - *Red - Black*

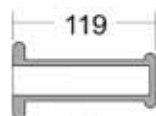

Estremità chiusa
Closed end

18 416 0940

NEW

Mod. **TURISMO**
Antracite - Grigio - *Grey - Anthracite*

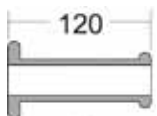

Estremità aperta
Open end

18 416 0950

NEW

Mod. **TURISMO**
Argento - Antracite - *Silver - Anthracite*

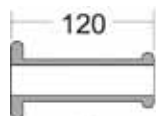

Estremità aperta
Open end

18 416 0960

NEW

Mod. **TURISMO**
Rosso - Nero - *Red - Black*

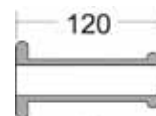

Estremità aperta
Open end

18 416 0970



NEW

18 416 0980



NEW

18 416 0990



NEW

Mod. **TURISMO**

Antracite - Rosso - *Anthracite - Red*

Mod. **TURISMO**

Verde - Nero - *Green - Black*

Mod. **TURISMO**

Antracite - Verde - *Anthracite - Green*

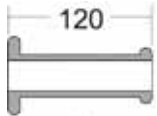

Estremità aperta
Open end

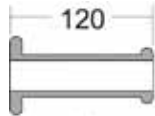

Estremità aperta
Open end

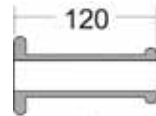

Estremità aperta
Open end

18 417 0000



NEW

18 417 0010



NEW

18 417 0020



NEW

Mod. **TURISMO**

Blu - Nero - *Blue - Black*

Mod. **TURISMO**

Antracite - Blu - *Anthracite - Blue*

Mod. **TURISMO**

Antracite - Giallo - *Anthracite - Yellow*

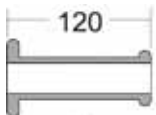

Estremità aperta
Open end

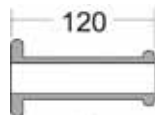

Estremità aperta
Open end

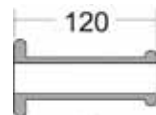

Estremità aperta
Open end

18 417 0030



NEW

18 417 0040



NEW

18 417 0050



NEW

Mod. **TURISMO**

Antracite - Arancio - *Anthracite - Orange*

Mod. **TURISMO**

Marrone - Nero - *Brown - Black*

Mod. **TURISMO**

Argento - Marrone - *Silver - Brown*

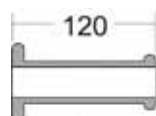

Estremità aperta
Open end

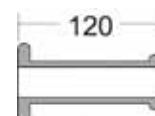

Estremità aperta
Open end

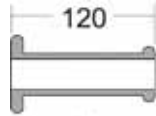

Estremità aperta
Open end

18 417 0060



NEW

18 417 0070



NEW

18 416 0610



Mod. **TURISMO**
Marrone - Grigio - *Brown - Silver*

Mod. **JAPAN STYLE**
Nero - *Black*

KIT COPERTINA COPRIMANOPOLA
GRIP COVER

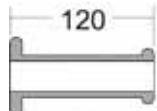

Estremità aperta
Open end

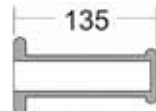

Estremità chiusa
Closed end





MANOPOLE

GRIPS

18 416 0180 

Mod. **STRONG GRIP**
Nero - *Black*

18 416 0280 

Mod. **STRONG GRIP**
Nero - *Black*
Gomma morbida - *Soft compound*

18 416 0190 

Mod. **CUSTOM**
Nero - *Black*
Estremità cromate - *Chromed ends*

18 416 0200 

Mod. **CUSTOM**
Carbon look
Estremità cromate - *Chromed ends*

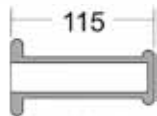

Estremità chiusa
Closed end

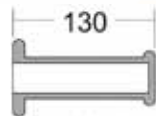

Estremità chiusa
Closed end

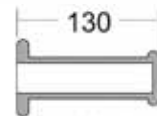

Estremità chiusa
Closed end

18 416 0240 

Mod. **CUSTOM**
Nero - *Black*
Estremità cromate - *Chromed ends*

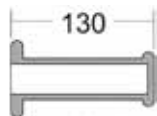

Estremità chiusa
Closed end

18 416 0210 

Mod. **AIR GRIP**
Nero - *Black*

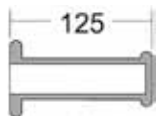

Estremità chiusa
Closed end

18 416 0220 

Mod. **EASY GRIP**
Nero - *Black*

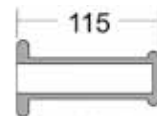

Estremità chiusa
Closed end

18 416 0230 

Mod. **SUPER GRIP**
Nero - *Black*

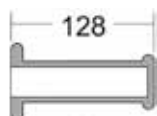

Estremità chiusa
Closed end

18 416 0250 

Nero - *Black*

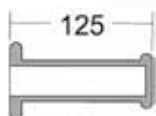

Estremità chiusa
Closed end

18 416 0260 

Nero - *Black*

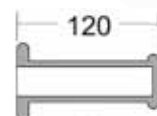

Estremità chiusa
Closed end



18 416 0670 

Nero - *Black*
Inserito in alluminio Silver - *Silver Alloy ends*



18 416 0680 

Nero - *Black*
Inserito in alluminio Rosso - *Red Alloy ends*



18 416 0690 

Nero - *Black*
Inserito in alluminio Blu - *Blue Alloy ends*

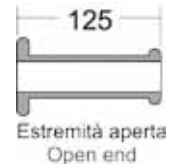

18 416 0290 

Trasparente - *Transparent*
Terminale Carbon ed anelli Silver
Carbon End - Silver Rings

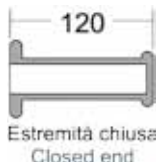

18 416 0300 

Trasparente - *Transparent*
Terminale ed anelli Rosso
Red End - Red Rings

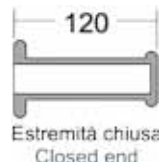

18 416 0310 

Trasparente - *Transparent*
Terminale ed anelli Blu
Blue End - Blue Rings

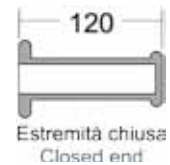

18 416 0330 

Nero - *Black*
Terminale ed anelli Silver
Silver End - Silver Rings

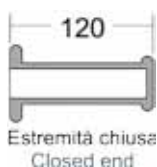

18 416 0340 

Nero - *Black*
Terminale ed anelli Rosso
Red End - Red Rings

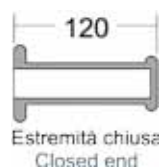

18 416 0350 

Nero - *Black*
Terminale ed anelli Blu
Blue End - Blue Rings

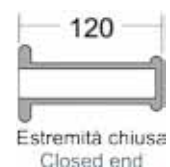



MANOPOLE

GRIPS

48 404 0020



Spugna Nera - *Black Foam*

18 416 0090



PIAGGIO 50: Vespa Pk 82 • Vespa Pk XL 85
125: Vespa Pk 82 • Vespa Pk XL 86
Nero - *Black*
(R.O.227077)

18 416 0100



PIAGGIO 50: Vespa Special 69-83 • Vespa Special Elestart 69-75
125: Vespa Primavera 67-83 • Vespa Et3 76
Nero - *Black*
(R.O.141924)

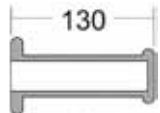

Estremità chiusa
Closed end

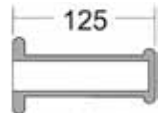

Estremità chiusa
Closed end

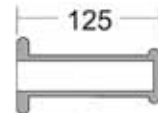

Estremità chiusa
Closed end

18 416 0110



PIAGGIO 125: Vespa Px 77-82 • Vespa Gt 68-88 • Vespa Gtr 66-76 • Vespa Super 64
150: Vespa Px 78-91 • Vespa Sprint 65-79 Vespa Super 74
180: Vespa Rally 68-73
200: Vespa Pe 77-91 • Rally 72-79
Nero - *Black*
(R.O.141923)

18 416 0120



PIAGGIO 125-150-200: Vespa Px Arcobaleno 83>
125: Vespa Px T5 85
Nero - *Black*
(R.O.179833)

18 416 0390



PIAGGIO 125-150-200: Vespa Px Freno a disco 98-01
125: Vespa Px Millenium
Nero - *Black*
(R.O. 582234)

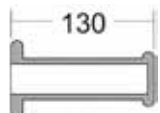

Estremità chiusa
Closed end

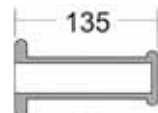

Estremità chiusa
Closed end

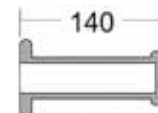

Estremità chiusa
Closed end

18 416 0140



PIAGGIO 125: Vespa Px 77-82 • Vespa Gt 68-88 • Vespa Gtr 66-76 • Vespa Super 64
150: Vespa Px 78-91 • Vespa Sprint 65-79 Vespa Super 74
180: Vespa Rally 68-73
200: Vespa Pe 77-91 • Rally 72-79
Grigio - *Gray*

18 416 0550



PIAGGIO 50: Vespa Special 69-83 • Vespa Special Elestart 69-75
125: Vespa Primavera 67-83 • Vespa Et3 76
Grigio - *Gray*

18 416 0560



PIAGGIO 50: Vespa 50 Rush 88 • Vespa N 90
Grigio - *Gray*
(R.O. 248317)

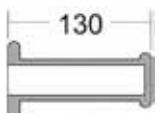

Estremità chiusa
Closed end

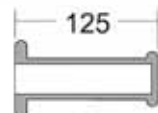

Estremità chiusa
Closed end

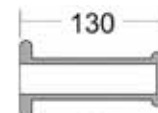

Estremità chiusa
Closed end



18 416 0270 

Nero - *Black*

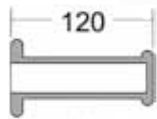

Estremità chiusa
Closed end

18 416 0840 

Mod. **VINTAGE**
Nero - *Black*

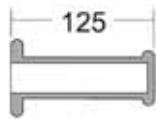

Estremità chiusa
Closed end

18 416 0850 

Mod. **VINTAGE**
Marrone - *Brown*

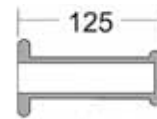

Estremità chiusa
Closed end

18 416 0860 

Mod. **VINTAGE**
Caffè - *Coffee*

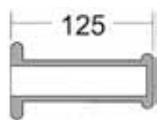

Estremità chiusa
Closed end

18 416 0870 

Mod. **VINTAGE**
Nero - *Black*

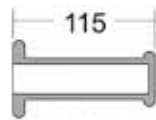

Estremità chiusa
Closed end

18 416 0880 

Mod. **VINTAGE**
Marrone - *Brown*

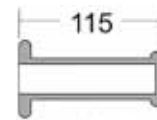

Estremità chiusa
Closed end

18 416 0890 

Mod. **VINTAGE**
Caffè - *Coffee*

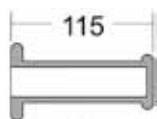

Estremità chiusa
Closed end



RMS
YOUR BEST PARTNER

▶ TRASMISSIONI SCOOTER

SCOOTER TRANSMISSIONS

▶ **RMS**
YOUR BEST PARTNER



TRASMISSIONI CONTACHILOMETRI

SPEEDOMETER TRANSMISSIONS

CC	MODELLO MODEL	ANNI YEARS	COD. ORIG. ORIG. CODE	COD. RMS RMS CODE	CC	MODELLO MODEL	ANNI YEARS	COD. ORIG. ORIG. CODE	COD. RMS RMS CODE
APRILIA					GILERA				
50	Amico (Freno a Disco - Disc Brake)	94	(AP8214110)	16 363 0030	50	Easy Moving	95-96	(574331)	16 363 0190
50	Amico (Freno a Tamburo- Brake Drum)	94	(AP8214169)	16 363 0020	50	Runner	97-00	(561710)	16 363 0220
50	Amico Gl-Gle (Freno a Disco - Disc Brake)	93-95	(AP8214110)	16 363 0030	50	Stalker	97-04	(561152)	16 363 0210
50	Amico Gl-Gle (Freno a Tamburo- Brake Drum)	93-95	(AP8214169)	16 363 0020	50	Stalker	05-06	(561152)	16 363 0210
50	Amico Lx-Sport-Cat (Freno Disco-Disc Brake)	92-93	(AP8214110)	16 363 0030	50	Stalker	07-08	(561152)	16 363 0210
50	Gulliver	95-98	(AP8214142)	16 363 0060	50	Stalker	09-11	(561152)	16 363 0210
50	Gulliver Lc	96-98	(AP8214142)	16 363 0060	50	Stalker Special Edition	07-08	(561152)	16 363 0210
50	Mojito Custom	99-03	(AP8214194)	16 363 1350	50	Storm	94-95	(563621)	16 363 0180
50	Mojito Custom 2T Motore Piaggio	04-10	(AP8114472)	16 363 1350	50	Typhoon (Dal-From Tec1t 0065089)	94-97	(563621)	16 363 0180
50	Mojito Retro	99-03	(AP8214186)	16 363 1360	50	Typhoon (Fino Al - Till Tec1t 0065088)	94-97	(272353)	16 363 0200
50	Mojito Retro	99-03	(AP8214186)	16 363 1380	50	Typhoon X	98-99	(563621)	16 363 0180
50	Rally Liquid Cooled	96-99	(AP8214165)	16 363 0080	50	Typhoon Xr	00	(563621)	16 363 0180
50	Scarabeo	93-97	(AP8214126)	16 363 0070	125	Runner Fx-Fxr 125-180	97-02	(563412)	16 363 1240
50	Scarabeo	98	(AP8214126)	16 363 0070	125	Runner Vx-Vxr 125-180	00-01	(582413)	16 363 1690
50	Scarabeo	99	(AP8214126)	16 363 0070	125	Runner Vx-Vxr 125-200	02-04	(582413)	16 363 1690
50	Scarabeo	00-05	(AP8214126)	16 363 0070	125	Typhoon	95-98	(563621)	16 363 0180
50	Scarabeo Street	05-06	(AP8214126)	16 363 0070	125	Typhoon X-Xr	99-00	(563621)	16 363 0180
50	Scarabeo Street 2T Restyling	06-09	(AP8214126)	16 363 0070	HONDA				
50	Sonic	98-07	(AP8214173)	16 363 0100	50	Bali	93-96	(44830-GAV-700)	16 363 0290
50	Sonic Gp	98-08	(AP8214173)	16 363 0100	50	Sfx	97-99	(44830-GBM-750)	16 363 0300
50	Sr	93	(AP8214130)	16 363 0050	50	Sh	85-95	(44830-GJ3-600)	16 363 0260
50	Sr	94-96	(AP8214142)	16 363 0060	50	Sh	96>	(44830-GBJ-910)	16 363 1230
50	Sr Ditech Eu 2	02-04	(AP8214163)	16 363 0090	50	Sky	99-01	(44830-GCG-930)	16 363 0310
50	Sr H2o Ditech E Carburatore	00-04	(AP8214163)	16 363 0090	50	Vision	-	(44830-GN2-030)	16 363 0320
50	Sr Liquid Cooled	94-96	(AP8214142)	16 363 0060	100	Bali	96-98	(44830-GAV-700)	16 363 0290
50	Sr Stealth, Racing	97-00	(AP8214163)	16 363 0090	125	Chiocciola	02-10	(44830-KGF-900)	16 363 1490
50	Sr Street	03-12	(AP8214163)	16 363 0090	125	Sh	-	(44830-KPR-900)	16 363 1530
50	Sr Www	97-01	(AP8214163)	16 363 0090	150	Chiocciola	02-10	(44830-KGF-900)	16 363 1490
125	Leonardo	96-98	(AP8114357)	16 363 0110	150	Sh	-	(44830-KPR-900)	16 363 1530
125	Leonardo	99-02	(AP8114357)	16 363 0110	250	Foresight	98	(44830-KFG-000)	16 363 0240
125	Leonardo St	01-04	(AP8114357)	16 363 0110	250	Jazz	01-04	(44830-KS4-010)	16 363 1500
125	Mojito	03-07	(AP8114472)	16 363 1350	ITALJET				
125	Mojito	08	(AP8114472)	16 363 1350	50	Formula	-		16 363 0380
125	Mojito - Custom	99-01	(AP8214194)	16 363 1350	KYMCO				
125	Mojito Retro'	99-01	(AP8214186)	16 363 1360	50	Agility 2T R16	10	(00151323)	16 363 1720
125	Mojito Retro - Custom	99-01	(AP8214186)	16 363 1380	50	Agility 2T R16	12	(00151323)	16 363 1720
125	Scarabeo	03	(AP8114357)	16 363 0110	50	Agility 4T Carry	11	(00151080)	16 363 1710
125	Scarabeo	04-06	(AP8114357)	16 363 0110	50	Agility 4T R10	06	(00151100)	16 363 1700
125	Scarabeo Motore Piaggio Eu3	06	(AP8114357)	16 363 0110	50	Agility 4T R10	07-08	(00151100)	16 363 1700
125	Scarabeo Motore Rotax	99-04	(AP8114357)	16 363 0110	50	Agility 4T R12	07-08	(00151080)	16 363 1710
125	Sr	99-01	(AP8214163)	16 363 0090	50	Agility 4T R16	08	(00151323)	16 363 1720
BENELLI					50	Agility 4T R16	09	(00151323)	16 363 1720
50	491 Gt	98-99	(R53410011A0)	16 363 1200	50	Agility 4T R16	12	(00151323)	16 363 1720
50	491 Racing	98-99	(R53410011A0)	16 363 1200	50	Agility Plus 2T	14	(00151323)	16 363 1720
50	491 Rr	99-01	(R53410011A0)	16 363 1200	50	Agility Plus 4T	14	(00151323)	16 363 1720
50	491Sp	99	(R53410011A0)	16 363 1200	50	Agility R12	05	(00151080)	16 363 1710
50	491 Sport	98-99	(R53410011A0)	16 363 1200	50	Dink Classic Eu2	03	(00151914)	16 363 1420
50	491 St	99-01	(R53410011A0)	16 363 1200	50	Dink Lc	98-02	(00151914)	16 363 1420
50	491 Rr Morini	03-04	(R53410021A0)	16 363 1190	50	Heroism	95-97	(44830-KLF-9010 00151720)	16 363 0680
50	491 St Morini	03	(R53410021A0)	16 363 1190	50	Like 2T	09	(00151080)	16 363 1710
50	K2 Liquid Cooled	98-01	(R53410021A0)	16 363 1190	50	Like 4T	09	(00151080)	16 363 1710
50	K2	98-01	(R53410021A0)	16 363 1190	50	People	99-00	(00151303)	16 363 1430
50	K2	99-01	(R53410021A0)	16 363 1190	50	People	04	(00151303)	16 363 1430
BETA					50	People Eu2	03	(00151303)	16 363 1430
50	Eikon	-	(2914221052)	16 363 1210	50	People Eu2	08	(00151303)	16 363 1430
50	Ark Lc	-	(2914220052)	16 363 1220	50	People Eu2	11	(00151303)	16 363 1430
DERBI					50	People S	05-08	(00151323)	16 363 1720
50	Atlantis	99-00	(00G01605021)	16 363 1520	50	People S 4T	06-08	(00151323)	16 363 1720
50	Atlantis	01	(00G01605021)	16 363 1520	50	Super 8	07	(00151323)	16 363 1720
50	Atlantis 2T	10	(00G01605021)	16 363 1520	50	Super 8 2T	09	(00151323)	16 363 1720
50	Atlantis 2T Eu2	07-09	(00G01605021)	16 363 1520	50	Super 8 2T	13	(00151323)	16 363 1720
50	Atlantis 4T Eu2	07	(00G01605021)	16 363 1520	50	Super 8 4T	09	(00151323)	16 363 1720
50	Atlantis 50-100 4T	04-06	(00G01605021)	16 363 1520	50	Super 8 4T	13	(00151323)	16 363 1720
50	Atlantis Lc	99-01	(00G01605021)	16 363 1520	50	Super 9	00	(00151310)	16 363 1540
50	Atlantis O2	02	(00G01605021)	16 363 1520	50	Super 9 Sport Eu2	03	(00151310)	16 363 1540
50	Atlantis O2 Bullet	03-05	(00G01605021)	16 363 1520	50	Super 9 Sport Eu2	04	(00151310)	16 363 1540
50	Atlantis O2 City	03-06	(00G01605021)	16 363 1520	125	Agility 4T	06	(00151080)	16 363 1710
50	Atlantis O2 Red Bullet	03	(00G01605021)	16 363 1520	125	Agility 4T Eu3	06-08	(00151080)	16 363 1710
50	Atlantis O2 Two Chic	05	(00G01605021)	16 363 1520					
50	Gp1	01-02	(00G01606021)	16 363 1600					
50	Gp1	03	(00G01606021)	16 363 1600					
50	Gp1 E2	03	(00G01606021)	16 363 1600					
50	Predator Lc	98-01	(00G01604021)	16 363 1600					

TRASMISSIONI CONTACHILOMETRI

SPEEDOMETER TRANSMISSIONS



CC	MODELLO MODEL	ANNI YEARS	COD. ORIG. ORIG. CODE	COD. RMS RMS CODE	CC	MODELLO MODEL	ANNI YEARS	COD. ORIG. ORIG. CODE	COD. RMS RMS CODE
125	Agility Carry	11	(00151080)	16 363 1710	50	F15 Fire Fox	96-98	(17811400)	16 363 0400
125	Agility Plus	14	(00151323)	16 363 1720	50	F15 Fire Fox Air Cooled	05-06	(17813300)	16 363 0440
125	Agility R16	08	(00151323)	16 363 1720	50	F15 Fire Fox Twin Disks & Special	98-99	(17811400)	16 363 0400
125	Agility R16	09	(00151323)	16 363 1720	100	Ciak	99-00	(17814400)	16 363 0510
125	Agility R16	12	(00151323)	16 363 1720	100	F12 Phantom	99-00	(17813300)	16 363 0440
125	Dink 125-150	97-98	(00151914)	16 363 1420	125	Ciak	00-01	(17814400)	16 363 0510
125	Dink Classic 125-150	02	(00151914)	16 363 1420	125	Ciak Master	04	(17814400)	16 363 0510
125	Dink Classic 125-150 Eu2	03	(00151914)	16 363 1420	125	Ciak Master Eu 3	06	(17814400)	16 363 0510
125	Dink Lx 125-150	98-00	(00151914)	16 363 1420	125	Ciak Restyling Eu2	03	(17814400)	16 363 0510
125	Grand Dink 125-150	01-02	(00151171)	16 363 1570	125	Madison	99-01	(17814300)	16 363 0500
125	Grand Dink 125-150 Eu2	03-04	(00151171)	16 363 1570	125	Madison R Restyling	02	(17814300)	16 363 0500
125	Heroism	95-97	(44830-KLF-9010 00151720)	16 363 0680	125	Madison R Restyling Eu2	03-04	(17814300)	16 363 0500
125	Like	09	(00151080)	16 363 1710	150	Ciak	00-02	(17814400)	16 363 0510
125	Like Lx	12	(00151080)	16 363 1710	150	Ciak Master	04	(17814400)	16 363 0510
125	Movie	99-00	(00151117)	16 363 1440	150	Ciak Restyling Eu2	03	(17814400)	16 363 0510
125	People 125-150	99-00	(00151303)	16 363 1430	150	Madison T	99-01	(17814300)	16 363 0500
125	People 125-150 Eu2	03	(00151303)	16 363 1430	200	Ciak Master Eu 2	06	(17814400)	16 363 0510
125	People Eu3	07	(00151303)	16 363 1430	MBK				
125	People Eu3	08	(00151303)	16 363 1430	50	Cw Booster	90-91	(3VLH35500000)	16 363 0540
125	People Eu3	11	(00151303)	16 363 1430	50	Cw Booster	01-02	(4PAH35500200)	16 363 1280
125	People S	05	(00151323)	16 363 1720	50	Cw Booster (ITA)	92-94	(3VLH35500000)	16 363 0540
125	People S Dd Eu3	07-08	(00151323)	16 363 1720	50	Cw Booster Spirit	96-98	(4PAH35500200)	16 363 1280
125	Super 8	08	(00151323)	16 363 1720	50	Cw Booster Spirit (ITA)	99	(4PAH35500200)	16 363 1280
125	Super 8	09	(00151323)	16 363 1720	50	Cw Booster Spirit (ITA)	00	(4PAH35500200)	16 363 1280
125	Vivio 125-150	00	(00151117)	16 363 1440	50	Cw Booster Spirit Eu2	02	(4PAH35500200)	16 363 1280
150	Agility R16	08	(00151323)	16 363 1720	50	Cw Booster Spirit Eu2	03	(4PAH35500200)	16 363 1280
150	Agility R16	09	(00151323)	16 363 1720	50	Cw L Booster	01-03	(4PAH35500200)	16 363 1280
150	Heroism	95-97	(44830-KLF-9010 00151720)	16 363 0680	50	Cw L Booster Spirit	03	(4PAH35500200)	16 363 1280
200	Agility 200l R16	10	(00151323)	16 363 1720	50	Cw R Booster Road (ITA)	94-95	(4PAH35500200)	16 363 1280
200	Agility I Plus	14	(00151323)	16 363 1720	50	Cw Rs Booster Ng	01-02	(4SBH35500300)	16 363 1270
200	Agility R16	12	(00151323)	16 363 1720	50	Cw Rs Booster Ng	03	(4SBH35500300)	16 363 1270
200	Dink Classic	04	(00151914)	16 363 1420	50	Cw Rs Booster Ng (ITA)	95-98	(4SBH35500300)	16 363 1270
200	Like 200l	09	(00151080)	16 363 1710	50	Cw Rs Booster Ng (ITA)	99	(4SBH35500300)	16 363 1270
200	Like Lx	12	(00151080)	16 363 1710	50	Cw Rs Booster Ng Eu1	99-00	(4SBH35500300)	16 363 1270
200	People S	05	(00151323)	16 363 1720	50	Cw Rsp Booster Rocket (ITA)	97-98	(4SBH35500300)	16 363 1270
200	People S 200l	07	(00151323)	16 363 1720	50	Cw Sp Booster Spirit Eu2	02	(4PAH35500200)	16 363 1280
250	B&W Eu2	03	(00151171)	16 363 1570	50	Ew Stunt	00-02	(4SBH35500300)	16 363 1270
250	Grand Dink	01-02	(00151171)	16 363 1570	50	Ya R Forte (Che- ITA)	94-96	(4PCH35500000)	16 363 0610
250	People Lc	03-04	(00156398)	16 363 1730	50	Yh Flipper	98	(5EUH35500000)	16 363 0620
250	People S	06	(00156398)	16 363 1730	50	Yh Flipper	01-02	(5EUH35500000)	16 363 0620
250	Venox	02-03	(00152059)	16 363 1740	50	Yh Flipper Catalitico	99-00	(5EUH35500000)	16 363 0620
250	Venox Eu2	04	(00152059)	16 363 1740	50	Yh Flipper Eu2	03-04	(5EUH35500000)	16 363 0620
250	Venox Eu3	07	(00152059)	16 363 1740	50	Ym Fizz (ITA)	94-95	(4PAH35500200)	16 363 1280
300	People S 300l	08	(00156398)	16 363 1730	50	Yq L Ni Tro Jaguar	04	(5PUH35500100)	16 363 1140
MALAGUTI					50	Yq Ni Tro (5Pe2-5Pe4)	01-02	(5BRH35500200)	16 363 0520
50	Centro SL	94-98	(17808900)	16 363 0450	50	Yq Ni Tro (5Pe6)	01-02	(5PUH35500200)	16 363 1140
50	Centro SL Kat	99-00	(17808900)	16 363 0450	50	Yq Ni Tro	04	(5BRH35500200)	16 363 0520
50	Ciak	99-00	(17814400)	16 363 0510	50	Yq Ni Tro (ITA)	97-98	(5BRH35500200)	16 363 0520
50	Ciak Master	04	(17814400)	16 363 0510	50	Yq Ni Tro (ITA)	99-00	(5BRH35500200)	16 363 0520
50	Ciak Master 4T	05-06	(17814400)	16 363 0510	50	Yq Ni Tro Eu2	03	(5PUH35500100)	16 363 1140
50	Ciak Master Eu 2	06	(17814400)	16 363 0510	100	Yq Ni Tro (5Me7)	00-02	(5PUH35500200)	16 363 1140
50	Ciak Mono Eu 2	03	(17814400)	16 363 0510	100	Yq Ni Tro (5Me2-5Me5)	00-02	(5BRH35500200)	16 363 0520
50	Ciak Mono Eu 2.2.3	03	(17814400)	16 363 0510	100	Yw Booster	99-01	(4VPH35500100)	16 363 1290
50	Ciak Td	00-01	(17814400)	16 363 0510	125	Yp Skyli Ner	98-00	(5DSH35500000)	16 363 1340
50	Crosser Cr1	95-98	(17810700)	16 363 0480	150	Yp Skyli Ner	00	(5DSH35500000)	16 363 1340
50	F10 Ac	08	(17811600)	16 363 0430	PEUGEOT				
50	F10 Ac Eco	09-10	(17811600)	16 363 0430	50	Buxi	-	(732615)	16 363 0740
50	F10 Jet Line (Modelli V/W)	98	(17811600)	16 363 0430	50	Elise	-	(740993)	16 363 0790
50	F10 Jet Line (Modelli N/P/R/S/T)	92-97	(17808100)	16 363 0460	50	Geo	-	(724335)	16 363 0730
50	F10 Kat	99-00	(17811600)	16 363 0430	50	Ludix 10	-	(762744)	16 363 1660
50	F10 Restyling Eu1	01-02	(17811600)	16 363 0430	50	Ludix 14	-	(762745)	16 363 1670
50	F10 Restyling Eu2-2.3	03-04	(17811600)	16 363 0430	50	Speedake	-	(732615)	16 363 0740
50	F10 Restyling Eu2	02-03	(17811600)	16 363 0430	50	Speedfight	-	(736610)	16 363 0770
50	F10 Restyling Eu2	06	(17811600)	16 363 0430	50	Trekker	-	(736721)	16 363 0800
50	F12 Aria Restyling Eu 2	06	(17813300)	16 363 0440	50	Viva City	-	(739602)	16 363 0810
50	F12 Phantom	94-98	(17809400)	16 363 0470	50	Zenith (Freno Tamburo/Drum)	-	-	16 363 0760
50	F12 Phantom Eu1	99-00	(17813300)	16 363 0440	125	Sv	-	(724335)	16 363 0730
50	F12 Phantom Lc	94-98	(17809400)	16 363 0470	PGO				
50	F12 Phantom Lc Eu1	99-00	(17813300)	16 363 0440	50	Big Max	-	(1544001000)	16 363 0820
50	F12 Phantom Lc Restyling Eu1	01-02	(17813300)	16 363 0440	PIAGGIO				
50	F12 Phantom Lc Restyling Eu2	02	(17813300)	16 363 0440	50	Boss	88-89	(187423)	16 363 0990
50	F12 Phantom Lc Restyling Eu2-2.3	03-04	(17813300)	16 363 0440	50	Ciao	80-88	(187423)	16 363 0990
50	F12 Phantom Lc Twin Disks	98	(17809400)	16 363 0470	50	Fly 2T	05-07	(600315)	16 363 1650



TRASMISSIONI CONTACHILOMETRI

SPEEDOMETER TRANSMISSIONS

CC	MODELLO MODEL	ANNI YEARS	COD. ORIG. ORIG. CODE	COD. RMS RMS CODE	CC	MODELLO MODEL	ANNI YEARS	COD. ORIG. ORIG. CODE	COD. RMS RMS CODE
50	Fly 2T	10-11	(600315)	16 363 1650	125	Liberty	98-00	(560973)	16 363 0960
50	Fly 4T	05-07	(600315)	16 363 1650	125	Liberty	01-02	(560973)	16 363 0960
50	Fly 4T & 25-30 Km/H	08-11	(600315)	16 363 1650	125	Liberty 4T	06-07	(647803)	16 363 1630
50	Fly 4T Motore Chn	06-07	(600315)	16 363 1650	125	Liberty 4T Eu3	06-08	(647803)	16 363 1630
50	Free	92-94	(272352)	16 363 0950	125	Liberty 4T Eu3 Delivery - Single	07-15	(647803)	16 363 1630
50	Free Delivery	00-01	(582414)	16 363 1580	125	Liberty 4T Eu3 Delivery - Tnt	08-09	(647803)	16 363 1630
50	Free Fl	95-02	(272352)	16 363 0950	125	Liberty Rst Ptt	05-11	(647803)	16 363 1630
50	Grillo	89-93	(187423)	16 363 0990	125	Sfera	95-97	(562403)	16 363 0880
50	Liberty	97-05	(560973)	16 363 0960	125	Skipper	94-97	(268263)	16 363 0890
50	Liberty 2T	06	(647804)	16 363 1640	125	Typhoon 4T 2V Eu3	10-11	(858542)	16 363 2050
50	Liberty 2T	07-08	(647804)	16 363 1640	125	Vespa Et4	96-98	(56116R)	16 363 1020
50	Liberty 4T	00-02	(560973)	16 363 0960	125	Vespa Et4	99-02	(56116R)	16 363 1020
50	Liberty 4T	05-08	(647804)	16 363 1640	125	Vespa Granturismo	03-05	(651072)	16 363 2100
50	Liberty 4T Delivery - Single	10-14	(647804)	16 363 1640	125	Vespa Granturismo	06-07	(651072)	16 363 2100
50	Liberty 4T Ptt (Deu)	07-12	(647803)	16 363 1630	125	Vespa Granturismo Eu 3	06-07	(599350)	16 363 1610
50	Liberty Moc 2T & Elle	09-13	(647804)	16 363 1640	125	Vespa Gts 4T le Super	09-15	(650849)	16 363 2090
50	Liberty Moc 4T & Elle	09-13	(647804)	16 363 1640	125	Vespa Gts Eu3	07-12	(599350)	16 363 1610
50	Nrg	94-96	(563621)	16 363 0180	125	Vespa Gtv	06-08	(650837)	16 363 2070
50	Nrg Extreme	99-00	(581287)	16 363 0970	125	Vespa Gtv 4T Navy Eu3	08	(650837)	16 363 2070
50	Nrg Mc3	01-04	(581287)	16 363 0970	125	Vespa Lx	05-06	(649347)	16 363 2110
50	Nrg Purejet	02-04	(581287)	16 363 0970	125	Vespa Lx 4T 3V le - Touring	12-13	(649347)	16 363 2110
50	Nrg Rst Mc2	96-98	(563621)	16 363 0180	125	Vespa Lx 4T Eu3 Touring	10-11	(649347)	16 363 2110
50	Ntt	95-96	(563621)	16 363 0180	125	Vespa Lx 4T FL	09	(649347)	16 363 2110
50	Quartz	92-96	(268263)	16 363 0890	125	Vespa Lx Eu 3	06-08	(649347)	16 363 2110
50	Sfera Maquillage 2	94	(266848)	16 363 0870	125	Vespa Lx Eu 3 le	09-11	(649347)	16 363 2110
50	Sfera	91-93	(266848)	16 363 0870	125	Vespa Lxv 4T Eu3	06-09	(650838)	16 363 2080
50	Sfera Rst	95-97	(562403)	16 363 0880	125	Vespa Lxv 4T Navy Eu3	07-08	(650838)	16 363 2080
50	Typhoon	01-04	(563621)	16 363 0180	125	Vespa Lxv le 4T	10-13	(650838)	16 363 2080
50	Typhoon 2T Eu2	10-12	(858542)	16 363 2050	125	Vespa S 4T 3V le	12	(650836)	16 363 2060
50	Typhoon 2T Eu3 Ch	11	(858542)	16 363 2050	125	Vespa S 4T Eu 3	07-08	(650836)	16 363 2060
50	Vespa Et2	97-05	(56116R)	16 363 1020	125	X8	05-06	(648572)	16 363 1790
50	Vespa Et2 Iniezione	97-00	(56116R)	16 363 1020	125	X8 Premium Eu 2	06	(648572)	16 363 1790
50	Vespa Et4	00-05	(56116R)	16 363 1020	125	X8 Premium Eu 3	06-07	(648572)	16 363 1790
50	Vespa Lx 2T	05-08	(649347)	16 363 2110	125	X8 Street Eu 2	06-07	(648572)	16 363 1790
50	Vespa Lx 2T	09-13	(649347)	16 363 2110	125	Zip	00-02	(582507)	16 363 0930
50	Vespa Lx 2T Touring & 30Km	10-13	(649347)	16 363 2110	150	Fly	05-07	(600315)	16 363 1650
50	Vespa Lx 4T	05-08	(649347)	16 363 2110	150	Fly Eu3	08-11	(600315)	16 363 1650
50	Vespa Lx 4T-4V	09-13	(649347)	16 363 2110	150	Liberty 4T Eu3	08	(647803)	16 363 1630
50	Vespa Lx 4T-4V Touring	10-13	(649347)	16 363 2110	150	Vespa Gts Super le 4T 3V	14	(650849)	16 363 2090
50	Vespa Lxv 2T	06-09	(650838)	16 363 2080	150	Vespa Lx	05-06	(649347)	16 363 2110
50	Vespa Lxv 2T Navy	08	(650838)	16 363 2080	150	Vespa Lx 4T 3V le - Touring	12-13	(649347)	16 363 2110
50	Vespa S 2T & College	07-12	(650836)	16 363 2060	150	Vespa Lx 4T FL	09	(649347)	16 363 2110
50	Vespa S 4T-4V & College	08-12	(650836)	16 363 2060	150	Vespa Lx Eu 3	06-08	(649347)	16 363 2110
50	Zip	92-93	(574331)	16 363 0190	150	Vespa Lx Eu 3 le	09-11	(649347)	16 363 2110
50	Zip	95-96	(574331)	16 363 0190	150	Vespa Lx Touring	10-12	(649347)	16 363 2110
50	Zip	00-04	(581321)	16 363 1300	150	Vespa S 4T	08-09	(650836)	16 363 2060
50	Zip 2T	08-13	(581321)	16 363 1300	150	Vespa S 4T le & College	09-12	(650836)	16 363 2060
50	Zip 4T	00-05	(581321)	16 363 1300	200	Carnaby	07-08	(648929)	16 363 1780
50	Zip 4T	06-13	(581321)	16 363 1300	200	Liberty	06	(647803)	16 363 1630
50	Zip Bimodale	94-97	(574331)	16 363 0190	200	Liberty Rst	04	(647803)	16 363 1630
50	Zip Fast Raider	93-94	(574331)	16 363 0190	200	Vespa Granturismo	06-07	(651072)	16 363 2100
50	Zip Fast Raider Rst	96-97	(581682)	16 363 0920	200	X8	05-07	(648572)	16 363 1790
50	Zip Rst	96-99	(581682)	16 363 0920	250	Beverly	06-07	(648992)	16 363 1620
50	Zip Sp	96-00	(582507)	16 363 0930	250	Beverly Eu 3 Mic	07	(648992)	16 363 1620
50	Zip Sp	01-04	(582507)	16 363 0930	250	Beverly Rst	04-05	(599866)	16 363 1620
50	Zip Sp Eu2	06-13	(649335)	16 363 0930	250	Beverly Tourer Eu3	07-09	(648992)	16 363 1620
80	Skr City	99	(266848)	16 363 0870	250	Carnaby	08	(648929)	16 363 1780
100	Fly 4T	06-07	(600315)	16 363 1650	250	Hexagon Gt-Gtx	98-00	(561279)	16 363 1090
100	Fly 4T	08	(600315)	16 363 1650	250	Vespa Gt 60 Eu 3	06-07	(650837)	16 363 2070
100	Zip 4T	06-10	(581321)	16 363 1300	250	Vespa Gts	05-14	(650849)	16 363 2090
125	Beverly Eu 3	07-08	(648992)	16 363 1620	250	Vespa Gts Abs	05-12	(601321)	16 363 2090
125	Beverly Eu 3 Mic	07	(648992)	16 363 1620	250	Vespa Gtv	06-09	(650837)	16 363 2070
125	Beverly Eu 3 Sport	07-08	(648992)	16 363 1620	250	Vespa Gtv 4T Navy Eu3	07	(650837)	16 363 2070
125	Beverly Rst	04-05	(599866)	16 363 1620	250	X8 Eu3	05-08	(648572)	16 363 1790
125	Beverly Rst	05-07	(648992)	16 363 1620	300	Carnaby Cruiser	09-12	(650950)	16 363 2010
125	Beverly Tourer Eu3	07-10	(648992)	16 363 1620	300	Vespa Gts le & Touring	12-14	(650849)	16 363 2090
125	Carnaby	07-10	(648929)	16 363 1780	300	Vespa Gts le Touring	11-12	(650849)	16 363 2090
125	Fly	05-07	(600315)	16 363 1650	300	Vespa Gts Super	08-14	(650849)	16 363 2090
125	Fly Eu3	07	(600315)	16 363 1650	300	Vespa Gts Super Sport	10-13	(650849)	16 363 2090
125	Fly Eu3	08-11	(600315)	16 363 1650	300	Vespa Gtv 4T 4V le	10-13	(650837)	16 363 2070
125	Hexagon	94-97	(274643)	16 363 0980	300	Vespa Gtv Via Montnapoleone	10	(650837)	16 363 2070
125	Hexagon Gtx	00	(561279)	16 363 1090	400	Beverly Eu 3	06-07	(599685)	16 363 1770
125	Hexagon Lx4	98-99	(561279)	16 363 1090	400	Beverly Tourer Eu3	08-10	(599685)	16 363 1770
125	Hexagon Lx-Lxt	98-99	(561279)	16 363 1090	400	X8 Eu3	06-08	(648572)	16 363 1790

TRASMISSIONI CONTACHILOMETRI

SPEEDOMETER TRANSMISSIONS



CC	MODELLO MODEL	ANNI YEARS	COD. ORIG. ORIG. CODE	COD. RMS RMS CODE	CC	MODELLO MODEL	ANNI YEARS	COD. ORIG. ORIG. CODE	COD. RMS RMS CODE
500	Beverly	02-04	(599685)	16 363 1770	200	Joyride	03	(44830H9A000)	16 363 1870
500	Beverly	05-06	(599685)	16 363 1770	200	Joyride Eu2	03-04	(44830H9A000)	16 363 1870
500	Beverly Cruiser	07-12	(649268)	16 363 2020	TGB				
500	Beverly Eu 3	06-08	(599685)	16 363 1770	50	303-303 Rs-Hauk	-		16 363 1890
SCOOTER CINESI					YAMAHA				
50	Gy6	-		16 363 2030	50	Bw's	04-05	(5WWH3550000)	16 363 0530
SUZUKI					50	Bw's	06-07	(5WWH3550000)	16 363 0530
50	Ay A K5-K6	05-06	(34910-35E00-000)	16 363 1160	50	Bw's	08-12	(5WWH3550000)	16 363 0530
50	Ay Ayw K1-K4	01-04	(34910-35E00-000)	16 363 1160	50	Bw's	13-15	(5WWH3550000)	16 363 0530
50	Ay Ayw Katana V-Y	97-00	(34910-35E00-000)	16 363 1160	50	Bw's Next Generation	97-98	(45BH35500300)	16 363 1270
SYM					50	Bw's Next Generation	99	(45BH35500300)	16 363 1270
50	Dd	02	(44830T47000)	16 363 1810	50	Bw's Next Generation	01-02	(45BH35500300)	16 363 1270
50	Dd Eu2	03-07	(44830T47000)	16 363 1810	50	Bw's Next Generation	03	(45BH35500300)	16 363 1270
50	Fiddle Iii	14	(44830ABA000)	16 363 1880	50	Bw's Next Generation	04-06	(45BH35500300)	16 363 1270
50	Jet	99	(44830E69000)	16 363 1840	50	Bw's Next Generation Cat.	99-00	(45BH35500300)	16 363 1270
50	Jet	00-01	(44830E69000)	16 363 1840	50	Bw's Original	97-98	(4PAH35500200)	16 363 1280
50	Jet Eu X Eu2	03-07	(44830E69000)	16 363 1840	50	Bw's Original	99	(4PAH35500200)	16 363 1280
50	Jet4	09-10	(44830ABA000)	16 363 1880	50	Bw's Original	99-00	(4PAH35500200)	16 363 1280
50	Jet4 R 2T	11	(44830ABA000)	16 363 1880	50	Bw's Original	01-02	(4PAH35500200)	16 363 1280
50	Jet4 R 2T	12-14	(44830ABA000)	16 363 1880	50	Bw's Original Eu2	03	(4PAH35500200)	16 363 1280
50	Jungle	99	(44830E69000)	16 363 1840	50	Cw Bw's Original Eu2	02	(4PAH35500200)	16 363 1280
50	Jungle	00	(44830E69000)	16 363 1840	50	Cw L Bw's	03	(4PAH35500200)	16 363 1280
50	Mask	00-01	(44830E69000)	16 363 1840	50	Cw L Bw's	04	(5WWH3550000)	16 363 0530
50	Mask Eu2	03-04	(44830E69000)	16 363 1840	50	Cw Rs Spy	95-98	(45BH35500300)	16 363 1270
50	Mio	06-07	(44830T47000)	16 363 1810	50	Cw Sp Bw's Original Eu2	02	(4PAH35500200)	16 363 1280
50	Mio	09	(44830T47000)	16 363 1810	50	Ew Slider	00-02	(45BH35500300)	16 363 1270
50	Red Devil	99	(44830E69000)	16 363 1840	50	Yh Why	98	(5EUH35500000)	16 363 0620
50	Simply Ii	14	(44830ABA000)	16 363 1880	50	Yh Why	01-02	(5EUH35500000)	16 363 0620
50	Super Fancy	98-00	(44830H09000)	16 363 1800	50	Yh Why	06	(5EUH35500000)	16 363 0620
50	Symply	07-08	(44830ABA000)	16 363 1880	50	Yh Why Eu1	99-00	(5EUH35500000)	16 363 0620
50	Symply Ii	09	(44830ABA000)	16 363 1880	50	Yh Why Eu2	03-05	(5EUH35500000)	16 363 0620
50	X Pro	13	(44830ABA000)	16 363 1880	50	Ym Breeze	94-95	(4PAH35500200)	16 363 1280
100	Jet	99-00	(44830E69000)	16 363 1840	50	Yq Aerox	97-98	(5BRH35500200)	16 363 0520
100	Mio Eu2	05-06	(44830T47000)	16 363 1810	50	Yq Aerox	01-02	(5BRH35500200)	16 363 0520
100	Mio Eu3	07-08	(44830T47000)	16 363 1810	50	Yq Aerox	04	(5PUH35500200)	16 363 1140
125	Attila	99-00	(44830M91000)	16 363 1840	50	Yq Aerox	05	(5PUH35500200)	16 363 1140
125	Eu Mx	02	(44830H3A600)	16 363 1860	50	Yq Aerox	06	(5PUH35500200)	16 363 1140
125	Eu Mx E2	03-04	(44830H3A600)	16 363 1860	50	Yq Aerox	07	(5PUH35500200)	16 363 1140
125	Fiddle Ii	08	(44830ABA000)	16 363 1880	50	Yq Aerox	08	(5PUH35500200)	16 363 1140
125	Fiddle Ii	09	(44830ABA000)	16 363 1880	50	Yq Aerox	09	(5PUH35500200)	16 363 1140
125	Fiddle Ii	10-13	(44830ABA000)	16 363 1880	50	Yq Aerox	10-12	(5PUH35500200)	16 363 1140
125	Fiddle Iii	14	(44830ABA000)	16 363 1880	50	Yq Aerox R	99	(5BRH35500200)	16 363 0520
125	Hd Eu2	03-04	(44830M96000)	16 363 1820	50	Yq Aerox R	99-00	(5BRH35500200)	16 363 0520
125	Hd Eu3	07-08	(44830HHA000)	16 363 1850	50	Yq L Aerox Eu2	03	(5PUH35500200)	16 363 1140
125	Hd Evo	05-06	(44830HHA000)	16 363 1850	100	Bw's	99-01	(4VPH35500300)	16 363 1290
125	Hd Evo Eu3	07-08	(44830HHA000)	16 363 1850	100	Yn Neo's	99-02	(5ADH355010000)	16 363 0570
125	Hd Evo Eu3	10-11	(44830HHA000)	16 363 1850	100	Yq Aerox	00-02	(5BRH355002000)	16 363 0520
125	Hd Evo Tamburo Eu3	08-09	(44830HHA000)	16 363 1850	125	Nxc Cygnus X	04-06	(5MLH35500000)	16 363 0550
125	Jet V	11	(44830E69000)	16 363 1840	125	Nxc Cygnus X	07-11	(5MLH355010000)	16 363 0560
125	Jet4	09-10	(44830ABA000)	16 363 1880	125	Yp125 Majesty	98-00	(5DSH35500000)	16 363 1340
125	Joyride	01-02	(44830H9A000)	16 363 1870	150	Yp150 Majesty	00	(5DSH35500000)	16 363 1340
125	Joyride Eu2	05-06	(44830H9A000)	16 363 1870	250	Yp250 Majesty	96-98	(4HC835500000)	16 363 0630
125	Megalò	06-07	(44830E69000)	16 363 1840	250	Yp250 Majesty Dx	98	(4HC835500000)	16 363 0630
125	New Duke	00-01	(44830M91000)	16 363 1840	250	Yp250 Majesty Dx	99	(4HC835500000)	16 363 0630
125	Super Duke	99-02	(44830H08010)	16 363 1800					
125	Symply	07-08	(44830ABA000)	16 363 1880					
125	Symply Ii	09-10	(44830ABA000)	16 363 1880					
125	Symply Ii	14	(44830ABA000)	16 363 1880					
125	Vs	06	(44830VS1100)	16 363 1830					
125	Vs Eu3	07-08	(44830VS1100)	16 363 1830					
150	Attila	00-01	(44830M91000)	16 363 1840					
150	Eu Mx	02	(44830H3A600)	16 363 1860					
150	Eu Mx Eu2	03-04	(44830H3A600)	16 363 1860					
150	Joyride	01-02	(44830H9A000)	16 363 1870					
150	Shark	00-01	(44830H3A600)	16 363 1860					
150	Vs	06	(44830VS1100)	16 363 1830					
150	Vs Eu3	07-08	(44830VS1100)	16 363 1830					
200	Hd Eu2	03-04	(44830E69000)	16 363 1840					
200	Hd Eu3 I	07	(44830HHA000)	16 363 1850					
200	Hd Evo Eu2	05-06	(44830HHA000)	16 363 1850					
200	Hd Evo Eu3 I	07	(44830HHA000)	16 363 1850					
200	Hd Evo I Eu3	10-12	(44830HHA000)	16 363 1850					
200	Hd Evo I Tamburo Eu3	08-09	(44830HHA000)	16 363 1850					



TRASMISSIONI FRENO

BRAKE TRANSMISSIONS

CC	MODELLO - MODEL	ANNI YEARS	FRENO ANTERIORE FRONT BRAKE	RIFERIM. ORIGINALE ORIGINAL CODE	FRENO POSTERIORE REAR BRAKE	RIFERIM. ORIGINALE ORIGINAL CODE
APRILIA						
50	Amico	94			16 355 5020	(AP8214104)
50	Amico	96-98			16 355 5020	(AP8214104)
50	Amico GL-GLE	93-95			16 355 5020	(AP8214104)
50	Amico Lx- Sport-Cat	92-93			16 355 5020	(AP8214104)
50	Gulliver	95-98			16 355 5030	(AP8214131)
50	Gulliver Lc	96-98			16 355 5030	(AP8214131)
50	Rally	95-03			16 355 5030	(AP8214131)
50	Scarabeo	93-97			16 355 5040	(AP8214123)
50	Scarabeo	98			16 355 5040	(AP8214123)
50	Scarabeo	99			16 355 5040	(AP8214123)
50	Scarabeo	00-05			16 355 5040	(AP8214123)
50	Sonic	98-07			16 355 5680	(AP8214174)
50	Sonic Gp	98-08			16 355 5680	(AP8214174)
50	Sr	93			16 355 5020	(AP8214104)
50	Sr	94-96			16 355 5030	(AP8214131)
50	Sr Liquid Cooled	94-96			16 355 5030	(AP8214131)
50	Sr Stealth, Racing	97-00			16 355 5030	(AP8214131)
50	Sr Www	97-01			16 355 5030	(AP8214131)
100	Scarabeo Mot. Minarelli	00			16 355 5770	(AP8114395)
100	Scarabeo Mot. Yamaha	00			16 355 5770	(AP8114395)
DERBI						
50	Sonar 2T	09			16 355 5370	(600561)
125	Sonar 4T	09-11			16 355 5370	(600561)
150	Sonar 4T	09			16 355 5370	(600561)
GILERA						
50	Easy Moving	95-96			16 355 5100	(271853)
50	Runner	97-00			16 355 5090	(562424)
50	Stalker	97-04			16 355 5080	(561151)
50	Stalker	05-06			16 355 5080	(561151)
50	Stalker	07-08			16 355 5080	(561151)
50	Stalker	09-11			16 355 5080	(561151)
50	Stalker Special Edition	07-08			16 355 5080	(561151)
50	Storm	94-95			16 355 5070	(270993)
50	Storm Eu2	07			16 355 5070	(270993)
50	Typhoon	94-97			16 355 5070	(270993)
50	Typhoon X	98-99			16 355 5070	(270993)
125	Runner Fx-Fxr 125-180	97-02			16 355 5710	(563753)
125	Typhoon	95-98			16 355 5690	(560711)
125	Typhoon X-Xr	99-00			16 355 5690	(560711)
HONDA						
125	Sh				16 355 5910	(43450-KPR-900)
150	Sh				16 355 5910	(43450-KPR-900)
MALAGUTI						
50	F12 Aria Restyling Eu2	06			16 355 5140	(04802903)
50	F12 Phantom	94-98			16 355 5140	(04802903)
50	F12 Phantom Eu1	99-00			16 355 5140	(04802903)
50	F12 Phantom Lc	94-98			16 355 5140	(04802903)
50	F12 Phantom Restyl. Eu1	01-02			16 355 5140	(04802903)
50	F12 Phantom Restyl. Eu2	02			16 355 5140	(04802903)
50	F12 Phantom R. Eu2-2.3	03-04			16 355 5140	(04802903)
50	F15 Fire Fox	96-98			16 355 5170	(04803103)
50	F15 Fire Fox Air Cooled	05-06			16 355 5170	(04803103)
MBK						
50	Cw Booster	90-91			16 355 5180	(3VLF63510000)
50	Cw Booster	01-02			16 355 5670	(5JHF63510100)
50	Cw Booster	04			16 355 5250	(5WWF63510000)
50	Cw Booster (ITA)	92-94			16 355 5180	(3VLF63510000)
50	Cw Booster Spirit	96-98			16 355 5180	(3VLF63510000)
50	Cw Booster Spirit (ITA)	99			16 355 5180	(3VLF63510000)
50	Cw Booster Spirit (ITA)	00			16 355 5180	(3VLF63510000)
50	Cw Booster Spirit Eu2	02			16 355 5670	(5JHF63510100)
50	Cw Booster Spirit Eu2	03			16 355 5670	(5JHF63510100)
50	Cw L Booster	01-03			16 355 5670	(5JHF63510100)
50	Cw L Booster Spirit	03			16 355 5670	(5JHF63510100)
50	Cw R Booster Road (ITA)	94-95			16 355 5180	(3VLF63510000)
50	Cw Rs Booster Ng (ITA)	95-98			16 355 5190	(4SBF63510000)
50	Cw Rs Booster Ng (ITA)	99			16 355 5190	(4SBF63510000)
50	Cw Rs Booster Ng Eu1	99-00			16 355 5190	(4SBF63510000)
50	Cw Rsp Booster Rocket (Ita)	97-98			16 355 5190	(4SBF63510000)
50	Cw Rsx Booster Track (Ita)	96-98			16 355 5190	(4SBF63510000)
50	Cw Sp Booster Spirit Eu2	02			16 355 5670	(5JHF63510100)
50	Ew Stunt	00-02			16 355 5670	(5JHF63510100)
50	Yn R Ovetto (Che- ITa)	97-01			16 355 5220	(5ADF63510000)

TRASMISSIONI FRENO

BRAKE TRANSMISSIONS



CC	MODELLO - MODEL	ANNI YEARS	FRENO ANTERIORE FRONT BRAKE	RIFERIM. ORIGINALE ORIGINAL CODE	FRENO POSTERIORE REAR BRAKE	RIFERIM. ORIGINALE ORIGINAL CODE
50	Yn R Ovetto Eu1	02-04			16 355 5220	(5ADF63510000)
50	Yn R Ovetto Eu2	02-03			16 355 5220	(5ADF63510000)
100	Yn Ovetto	00-02			16 355 5220	(5ADF63510000)
PEUGEOT						
50	Metal-X	02			16 355 5880	(736927)
50	Speedfight 2 Aria	05-06			16 355 5880	(736927)
50	Speedfight 2 Lc-Silversport	05-06			16 355 5880	(736927)
50	Speedfight Acqua	97-98			16 355 5880	(736927)
50	Speedfight Aria	97-98			16 355 5880	(736927)
50	Speedfight Aria Catalitico	99			16 355 5880	(736927)
50	Trekker	98-00			16 355 5880	(736927)
50	Trk2 Wrc	04-06			16 355 5880	(736927)
50	Vivacity	99			16 355 5880	(736927)
50	Vivacity Catalitico	99-02			16 355 5880	(736927)
50	Vivacity Vsx-Xr	02-04			16 355 5880	(736927)
50	X-Fight	00			16 355 5880	(736927)
100	Trekker	98			16 355 5880	(736927)
100	Vivacity	99-01			16 355 5880	(736927)
PIAGGIO						
50	Fly 2T	05-07			16 355 5930	(648078)
50	Fly 2T	10-11			16 355 5930	(648078)
50	Fly 4T	05-07			16 355 5930	(648078)
50	Fly 4T & 25-30 Km/H	08-11			16 355 5930	(648078)
50	Fly 4T Motore Chn	06-07			16 355 5930	(648078)
50	Free Delivery	00-01			16 355 5300	(597383)
50	Free Fl	95-02			16 355 5300	(597383)
50	Liberty	97-05			16 355 5300	(597383)
50	Liberty 2T	06			16 355 5370	(600561)
50	Liberty 2T	07-08			16 355 5370	(600561)
50	Liberty 2T Rst	04			16 355 5300	(597383)
50	Liberty 2T Sport	06			16 355 5370	(600561)
50	Liberty 2T Sport	07-08			16 355 5370	(600561)
50	Liberty 4T	00-02			16 355 5300	(597383)
50	Liberty 4T	05-08			16 355 5370	(600561)
50	Liberty 4T Delivery- Single	10-14			16 355 5370	(600561)
50	Liberty 4T Delivery Tnt	09			16 355 5370	(600561)
50	Liberty 4T Ptt - Double	09-12			16 355 5370	(600561)
50	Liberty 4T Ptt (Deu)	07-12			16 355 5370	(600561)
50	Liberty 4T Rst	04			16 355 5730	(564217)
50	Liberty 4T Sport	06			16 355 5370	(600561)
50	Liberty 4T Sport	07-08			16 355 5370	(600561)
50	Liberty Moc 2T & Elle	09-13			16 355 5370	(600561)
50	Liberty Moc 4T & Elle	09-13			16 355 5370	(600561)
50	Liberty Ptt Eu2	04-05			16 355 5300	(597383)
50	Nrg	94-96			16 355 5070	(270993)
50	Nrg Extreme	99-00			16 355 5690	(560711)
50	Nrg Mc3	01-04			16 355 5690	(560711)
50	Nrg Power Dt	06			16 355 5730	(564217)
50	Nrg Power Dt	07-11			16 355 5730	(564217)
50	Nrg Power Dt Serie Speciale	07-08			16 355 5730	(564217)
50	Nrg Rst Mc2	96-98			16 355 5070	(270993)
50	Ntt	95-96			16 355 5070	(270993)
50	Quartz	92-96			16 355 5310	(266213)
50	Sfera	91-93	16 355 0100	(268195)	16 355 5310	(266213)
50	Sfera Maquillage 2	94	16 355 0100	(268195)	16 355 5310	(266213)
50	Sfera Rst	95-97			16 355 5090	(562424)
50	Typhoon	01-04			16 355 5070	(270993)
50	Typhoon	05-08			16 355 5070	(270993)
50	Typhoon	09-11			16 355 5070	(270993)
50	Typhoon 2T Eu2	10-12			16 355 5940	(666930)
50	Typhoon 2T Eu3 Ch	11			16 355 5940	(666930)
50	Vespa Et2	97-05			16 355 5090	(562424)
50	Vespa Et2 Iniezione	97-00			16 355 5090	(562424)
50	Vespa Et4	00-05			16 355 5730	(564217)
50	Vespa Lx 2T	05-08			16 355 5090	(665912)
50	Vespa Lx 2T	09-13			16 355 5090	(665912)
50	Vespa Lx 2T Touring & 30Km	10-13			16 355 5090	(665912)
50	Vespa Lx 4T	05-08			16 355 5730	(564217)
50	Vespa Lx 4T-4V	09-13			16 355 5730	(564217)
50	Vespa Lx 4T-4V Touring	10-13			16 355 5730	(564217)
50	Vespa S 2T & College	07-12			16 355 5090	(665912)
50	Vespa S 4T-4V & College	08-10			16 355 5730	(564217)
50	Vespa S 4T-4V & College	11-12			16 355 5090	(665912)
50	Zip	92-93	16 355 0110	(269657)	16 355 5330	(269656)



TRASMISSIONI FRENO

BRAKE TRANSMISSIONS

CC	MODELLO - MODEL	ANNI YEARS	FRENO ANTERIORE FRONT BRAKE	RIFERIM. ORIGINALE ORIGINAL CODE	FRENO POSTERIORE REAR BRAKE	RIFERIM. ORIGINALE ORIGINAL CODE
50	Zip	95-96	16 355 0110	16 355 0110 (269657)	16 355 5330	(269656)
50	Zip	02			16 355 5920	(564988)
50	Zip	00-04			16 355 5360	(560781)
50	Zip 2T	08-13			16 355 5920	(564988)
50	Zip 4T	00-05			16 355 5840	(597141)
50	Zip 4T	06-13			16 355 5840	(597141)
50	Zip Bimodale	94-97	16 355 0110	(269657)	16 355 5330	(269656)
50	Zip Fast Raider	93-94			16 355 5100	(271853)
50	Zip Fast Raider Rst	96-97			16 355 5360	(560781)
50	Zip Rst	96-99	16 355 0130	(560752)	16 355 5360	(560781)
50	Zip Sp	96-00			16 355 5360	(560781)
50	Zip Sp	01-04			16 355 5920	(564988)
50	Zip Sp Eu2	06-13			16 355 5920	(564988)
80	Skr City	99	16 355 0100	(268195)		
100	Fly 4T	06-07			16 355 5930	(648078)
100	Fly 4T	08			16 355 5930	(601736)
100	Free	02-03			16 355 5300	(597383)
100	Zip 4T	06-10			16 355 5840	(597141)
125	Fly	05-07			16 355 5930	(648078)
125	Fly Eu3	07			16 355 5930	(648078)
125	Fly Eu3	08-11			16 355 5930	(648078)
125	Hexagon	94-97			16 355 5700	(564107)
125	Hexagon Lx4	98-99			16 355 5700	(564107)
125	Hexagon Lx-Lxt	98-99			16 355 5700	(564107)
125	Liberty	98-00			16 355 5740	(597320)
125	Liberty	01			16 355 5850	(564847)
125	Liberty	02			16 355 5730	(564217)
125	Liberty 4T	06-07			16 355 5370	(600561)
125	Liberty 4T 2V Eu3	09-12			16 355 5370	(600561)
125	Liberty 4T 2V Ie Ptt - Ita	12			16 355 5370	(600561)
125	Liberty 4T Eu3	06-08			16 355 5370	(600561)
125	Liberty 4T Eu3 Delivery - Single	07-15			16 355 5370	(600561)
125	Liberty 4T Eu3 Delivery - Tnt	08-09			16 355 5370	(600561)
125	Liberty 4T Sport Eu3	06-08			16 355 5370	(600561)
125	Liberty Rst	04-05			16 355 5730	(564217)
125	Liberty Rst Ptt	05-11			16 355 5370	(600561)
125	Liberty Sport	06			16 355 5370	(600561)
125	Skipper	94-97			16 355 5310	(266213)
125	Skipper 4T	00-02			16 355 5750	(564474)
125	Typhoon 4T 2V Eu3	10-11			16 355 5940	(666930)
125	Vespa Et4	96-98			16 355 5090	(562424)
125	Vespa Et4	99-02			16 355 5730	(564217)
125	Vespa Lx	05-06			16 355 5730	(564217)
125	Vespa Lx 4T Eu3 Touring	10-11			16 355 5730	(564217)
125	Vespa Lx 4T FL	09			16 355 5730	(564217)
125	Vespa Lx Eu3	06-08			16 355 5730	(564217)
125	Vespa Lx Eu3 Ie	09-11			16 355 5730	(564217)
125	Vespa S 4T Euro 3	07-08			16 355 5730	(564217)
125	Vespa S 4T Ie & College	09-11			16 355 5730	(564217)
125	Zip	00-02			16 355 5840	(597141)
150	Fly	05-07			16 355 5930	(648078)
150	Fly Eu3	08-11			16 355 5930	(648078)
150	Liberty 4T Eu3	08			16 355 5370	(600561)
150	Liberty 4T Sport Eu3	08			16 355 5370	(600561)
150	Liberty Moc 4T Eu3	09-13			16 355 5370	(600561)
150	Vespa Lx	05-06			16 355 5730	(564217)
150	Vespa Lx 4T FL	09			16 355 5730	(564217)
150	Vespa Lx Eu3	06-08			16 355 5730	(564217)
150	Vespa Lx Euro 3 Ie	09-11			16 355 5730	(564217)
150	Vespa Lx Touring	10-12			16 355 5730	(564217)
150	Vespa S 4T	08-09			16 355 5730	(564217)
150	Vespa S 4T Ie & College	09-12			16 355 5730	(564217)
200	Liberty	06			16 355 5370	(600561)
200	Liberty 4T Eu3	06-08			16 355 5370	(600561)
200	Liberty 4T Sport Eu3	06-07			16 355 5370	(600561)
200	Liberty Rst	04			16 355 5730	(564217)
200	Liberty Sport	06			16 355 5370	(600561)
250	Hexagon Gt-Gtx	98-00			16 355 5700	(564107)

TRASMISSIONI FRENO

BRAKE TRANSMISSIONS



CC	MODELLO - MODEL	ANNI YEARS	FRENO ANTERIORE FRONT BRAKE	RIFERIM. ORIGINALE ORIGINAL CODE	FRENO POSTERIORE REAR BRAKE	RIFERIM. ORIGINALE ORIGINAL CODE
YAMAHA						
50	Bw's	04-05			16 355 5250	(5WWF63510000)
50	Bw's	06-07			16 355 5250	(5WWF63510000)
50	Bw's	08-12			16 355 5250	(5WWF63510000)
50	Bw's	13-15			16 355 5250	(5WWF63510000)
50	Bw's Bump	97-98			16 355 5190	(4SBF63510000)
50	Bw's Easy	13			16 355 5250	(5WWF63510000)
50	Bw's Naked	04			16 355 5240	(2B7F63510000)
50	Bw's Naked	09-12			16 355 5240	(2B7F63510000)
50	Bw's Naked	13			16 355 5240	(2B7F63510000)
50	Bw's Next Generation	97-98			16 355 5190	(4SBF63510000)
50	Bw's Next Generation	99			16 355 5190	(4SBF63510000)
50	Bw's Next Generation Cat.	99-00			16 355 5190	(4SBF63510000)
50	Bw's Original	97-98			16 355 5180	(3VLF63510000)
50	Bw's Original	99			16 355 5180	(3VLF63510000)
50	Bw's Original	99-00			16 355 5180	(3VLF63510000)
50	Bw's Original	01-02			16 355 5670	(5JHF63510200)
50	Bw's Original Eu2	03			16 355 5670	(5JHF63510100)
50	Cw Bw's Original Eu2	02			16 355 5670	(5JHF63510100)
50	Cw L Bw's	03			16 355 5670	(5JHF63510100)
50	Cw L Bw's	04			16 355 5670	(5JHF63510100)
50	Cw Rs Spy	95-98			16 355 5190	(4SBF63510000)
50	Cw Sp Bw's Original Eu2	02			16 355 5670	(5JHF63510100)
50	Ew Slider	00-02			16 355 5670	(5JHF63510200)
50	Yn Neo's	04-06			16 355 5220	(5ADF63510000)
50	Yn Neo's Eu2	02-03			16 355 5220	(5ADF63510000)
50	Yn R Neo's	97-01			16 355 5220	(5ADF63510000)
50	Yn R Neo's	02			16 355 5220	(5ADF63510000)
100	Yn Neo's	99-02			16 355 5220	(5ADF63510000)



TRASMISSIONI GAS

THROTTLE TRANSMISSIONS

CC	MODELLO MODEL	ANNI YEARS	CAVO GAS THROTTLE	COMANDO SDOPPIATORE CONTROL SPLITTER	SDOPPIATORE MISCELATORE SPLITTER MIX	SDOPPIATORE CARBURATORE CARBURATOR SPLITTER
APRILIA						
50	Amico	94	16 359 0020 (AP8214109)			
50	Amico	96-98	16 359 0020 (AP8214109)			
50	Amico GL-GLE	93-95	16 359 0020 (AP8214109)			
50	Amico Lx- Sport-Cat	92-93	16 359 0020 (AP8214109)			
50	Gulliver	95-98	16 359 0050 (AP8214160)			
50	Gulliver Lc	96-98	16 359 0050 (AP8214160)			
50	Rally	95-03	16 359 0050 (AP8214160)			
50	Rally Liquid Cooled	96-99	16 359 0040 (AP8214167)			
50	Scarabeo	93-97	16 359 0030 (AP8214125)			
50	Scarabeo	98	16 359 0030 (AP8214125)			
50	Scarabeo	99	16 359 0030 (AP8214125)			
50	Scarabeo	00-05	16 359 0030 (AP8214125)			
NEW 50	Scarabeo 2T Eu2 Motore Piaggio	10-12	16 359 7340 (AP8214242)			
NEW 50	Scarabeo 2T Net	09	16 359 7340 (AP8214242)			
NEW 50	Scarabeo 2T Net	10	16 359 7340 (AP8214242)			
NEW 50	Scarabeo Street 2T Restyling	06-09	16 359 7340 (AP8214242)			
NEW 50	Scarabeo Street	05-06	16 359 7340 (AP8214242)			
50	Sonic	98-07	16 359 0330 (AP8214172)			
50	Sonic Gp	98-08	16 359 0330 (AP8214172)			
50	Sr	93	16 359 0020 (AP8214109)			
50	Sr	94-96	16 359 0020 (AP8214109)			
50	Sr Liquid Cooled	94-96	16 359 0020 (AP8214109)			
50	Sr Stealth, Racing	97-00	16 359 0060 (AP8214162)			
50	Sr Www	97-01	16 359 0060 (AP8214162)			
125	Leonardo	96-98	16 359 0200 (AP8114299)			
125	Leonardo	99-02	16 359 0660 (AP8114388)			
125	Leonardo St	01-04	16 359 0660 (AP8114388)			



CC	MODELLO MODEL	ANNI YEARS	CAVO GAS THROTTLE	COMANDO SDOPPIATORE CONTROL SPLITTER	SDOPPIATORE MISCELATORE SPLITTER MIX	SDOPPIATORE CARBURATORE CARBURATOR SPLITTER
125	Scarabeo Motore Rotax	99-04	16 359 0370 (AP8114382)			
125	Sr	99-01	16 359 2220 (AP8114380)			
250	Leonardo	99-01	16 359 0440 (AP8114369)			
250	Leonardo	02-04	16 359 0440 (AP8114369)			
250	Leonardo St	01	16 359 0440 (AP8114369)			
GILERA						
50	Dna	00-02			16 359 5150 (582449)	
50	Dna	05-07			16 359 5150 (582449)	
50	Dna Gp Experience	03-04			16 359 5150 (582449)	
50	Easy Moving	95-96	16 359 2150 (268435)		16 359 5040 (271829)	16 359 7020 (268402)
50	Ice	01-05				16 359 7300 (583334)
50	Runner	97-00	16 359 2030 (562583) 16 359 2270 Freno a Disco <i>Brake disc</i> (563878)		16 359 5030 (268403)	16 359 7030 (581173)
50	Runner Poggiali	02	16 359 2270 (563878)			
50	Runner Purejet	02-04	16 359 2270 (563878)		16 359 5030 (268403)	
50	Runner Sp	02-04	16 359 2270 (563878)		16 359 5030 (268403)	
50	Runner Sp Special Edition	07			16 359 5030 (268403)	
50	Stalker	97-04	16 359 2450 (561149)		16 359 5030 (268403)	
50	Stalker	05-06	16 359 2450 (561149)		16 359 5030 (268403)	
50	Stalker	07-08	16 359 2450 (561149)		16 359 5030 (268403)	
50	Stalker	09-11	16 359 2450 (561149)		16 359 5030 (268403)	
50	Stalker Naked	08			16 359 5030 (268403)	
50	Stalker Special Edition	07-08	16 359 2450 (561149)			
50	Storm	94-95			16 359 5010 (272290)	16 359 7010 (272289)
50	Storm Eu2	07		16 359 2240 (581539)	16 359 5150 (582449)	
50	Typhoon	94-97			16 359 5010 (272290)	16 359 7010 (272289)
50	Typhoon X	98-99			16 359 5010 (272290)	16 359 7010 (272289)



TRASMISSIONI GAS

THROTTLE TRANSMISSIONS

CC	MODELLO MODEL	ANNI YEARS	CAVO GAS THROTTLE	COMANDO SDOPPIATORE CONTROL SPLITTER	SDOPPIATORE MISCELATORE SPLITTER MIX	SDOPPIATORE CARBURATORE CARBURATOR SPLITTER
50	Typhoon Xr	00			16 359 5010 (272290)	16 359 7010 (272289)
125	Runner Fx-Fxr 125	97-02	16 359 2270 (563878)		16 359 5150 (582449)	16 359 7210 Dell'Orto (563213) 16 359 7200 Mikuni (563213)
125	Runner Fx-Fxr 125-180	01-02	16 359 2030 (562583)		16 359 5150 (582449)	16 359 7210 Dell'Orto (563213)
125	Typhoon	95-98			16 359 5010 (272290)	
125	Typhoon X-Xr	99-00			16 359 5010 (272290)	
180	Runner Fx-Fxr 180	97-02	16 359 2270 (563878)		16 359 5150 (582449)	16 359 7210 Dell'Orto (563213) 16 359 7200 Mikuni (563213)
HONDA						
50	Sgx Sky	-	16 359 0160 (17910GCG930)			
125	Sh	-	16 359 0460 (17910KFG900)			
125	Chiocciola Nes	-	16 359 0460 (17910KFG900)			
150	Sh	-	16 359 0460 (17910KFG900)			
150	Chiocciola Nes	-	16 359 0460 (17910KFG900)			
MALAGUTI						
50	Ciak Master	04		16 359 2060 (03407803)		
50	Ciak Mono Eu2 2.3	03		16 359 2060 (03407803)		
50	F10 Jet Line	92-98	16 359 0080 (03408003)			
50	F10 Kat	99-00	16 359 0080 (03408003)			
50	F10 Restyling Eu1	01-02	16 359 0080 (03408003)			
50	F10 Restyling Eu2	02-03	16 359 0080 (03408003)			
50	F10 Restyling Eu2	06	16 359 0080 (03408003)			
50	F12 Aria Restyling Eu2	06	16 359 0080 (03408003)			
50	F12 Lc Restyling Eu2	06	16 359 0080 (03408003)			
50	F12 Phantom	94-98	16 359 0080 (03408003)	16 359 2060 (03407803)		
50	F12 Phantom Eu1	99-00	16 359 0080 (03408003)			
50	F12 Phantom Lc	94-98	16 359 0080 (03408003)	16 359 2060 (03407803)		
50	F12 Phantom Lc Eu1	99-00	16 359 0080 (03408003)			
50	F12 Phantom Lc Restyling Eu1	01-02	16 359 0080 (03408003)			
50	F12 Phantom Lc Restyling Eu2	02		16 359 2060 (03407803)		



CC	MODELLO MODEL	ANNI YEARS	CAVO GAS THROTTLE	COMANDO SDOPPIATORE CONTROL SPLITTER	SDOPPIATORE MISCELATORE SPLITTER MIX	SDOPPIATORE CARBURATORE CARBURATOR SPLITTER
50	F12 Phantom Lc Restyling Eu2-2.3	03-04		16 359 2060 (03407803)		
50	F12 Phantom Lc Twin Disks	98	16 359 0080 (03408003)			
50	F12 Phantom Restyling Eu1	01-02	16 359 0080 (03408003)			
50	F12 Phantom Restyling Eu2	02	16 359 0080 (03408003)			
50	F12 Phantom Restyling Eu2-2.3	03-04		16 359 2060 (03407803)		
50	F15 Fire Fox	96-98	16 359 0080 (03408003)			
50	F15 Fire Fox Air Cooled	05-06	16 359 0080 (03408003)			
50	F15 Fire Fox Eu2	02-03		16 359 2060 (03407803)		
50	F15 Fire Fox Restyling Eu2-2.3	03-04		16 359 2060 (03407803)		
50	F15 Fire Fox Twin Disks & Special	98-99	16 359 0080 (03408003)			
50	F15 Fire Fox Twin Disks Digit Kat	98-00	16 359 0080 (03408003)			
50	F15 Lc Restyling Eu2	04-05	16 359 0080 (03408003)			
50	F15 Lc-Tds Restyling Eu1	01	16 359 0080 (03408003)			
50	Yesterday - Yesterday Eu	97-00	16 359 0080 (03408003)			
MBK						
50	Cr Z Target	91-95				16 359 7100 (3GFF63120000)
50	Ct S Sorri So	91-92		16 359 2090 (1NTF63110000)		
50	Ct Ss Sorri So	93-95		16 359 2090 (1NTF63110000)		
50	Cw Booster	90-91		16 359 2070 (3VLF63110100)		16 359 7060 (3VFL63120100)
50	Cw Booster	01-02		16 359 2070 (3VLF63110100)		16 359 7060 (3VFL63120100)
50	Cw Booster	04	16 359 7320 (5WWF63120000)	16 359 2070 (3VLF63110100)		
50	Cw Booster (Ita)	92-94		16 359 2070 (3VLF63110100)		16 359 7060 (3VFL63120100)
50	Cw Booster Naked	03		16 359 2070 (3VLF63110100)		16 359 7060 (3VFL63120100)
50	Cw Booster Spirit	96-98		16 359 2070 (3VLF63110100)		16 359 7060 (3VFL63120100)
50	Cw Booster Spirit (Ita)	99		16 359 2070 (3VLF63110100)		16 359 7060 (3VFL63120100)
50	Cw Booster Spirit (Ita)	00		16 359 2070 (3VLF63110100)		16 359 7060 (3VFL63120100)
50	Cw Booster Spirit Eu2	02		16 359 2070 (3VLF63110100)		16 359 7060 (3VFL63120100)
50	Cw Booster Spirit Eu2	03		16 359 2070 (3VLF63110100)		16 359 7060 (3VFL63120100)
50	Cw L Booster	01-03		16 359 2070 (3VLF63110100)		16 359 7060 (3VFL63120100)



TRASMISSIONI GAS

THROTTLE TRANSMISSIONS

CC	MODELLO MODEL	ANNI YEARS	CAVO GAS THROTTLE	COMANDO SDOPPIATORE CONTROL SPLITTER	SDOPPIATORE MISCELATORE SPLITTER MIX	SDOPPIATORE CARBURATORE CARBURATOR SPLITTER
50	Cw L Booster Spirit	03		16 359 2070 (3VLF63110100)		16 359 7060 (3VFL63120100)
50	Cw R Booster Road (Ita)	94-95		16 359 2070 (3VLF63110100)		16 359 7060 (3VFL63120100)
50	Cw Rs Booster Ng	01-02		16 359 2070 (3VLF63110100)		16 359 7060 (3VFL63120100)
50	Cw Rs Booster Ng	03		16 359 2070 (3VLF63110100)		16 359 7060 (3VFL63120100)
50	Cw Rs Booster Ng (Ita)	95-98		16 359 2070 (3VLF63110100)		16 359 7060 (3VFL63120100)
50	Cw Rs Booster Ng (Ita)	99		16 359 2070 (3VLF63110100)		16 359 7060 (3VFL63120100)
50	Cw Rs Booster Ng Euro1	99-00		16 359 2070 (3VLF63110100)		16 359 7060 (3VFL63120100)
50	Cw Rsp Booster Rocket (Ita)	97-98		16 359 2070 (3VLF63110100)		16 359 7060 (3VFL63120100)
50	Cw Rsx Booster Track (Ita)	96-98		16 359 2070 (3VLF63110100)		16 359 7060 (3VFL63120100)
50	Cw Sp Booster Spirit Eu2	02		16 359 2070 (3VLF63110100)		16 359 7060 (3VFL63120100)
50	Ew Stunt	00-02		16 359 2230 (4UYF63110000)		16 359 7180 (4UYF63120000)
50	Yh Flipper	98	16 359 2210 (5EUF63110000)			16 359 7180 (4UYF63120000)
50	Yh Flipper	01-02	16 359 2210 (5EUF63110000)			16 359 7180 (4UYF63120000)
50	Yh Flipper Catali Ti Co	99-00	16 359 2210 (5EUF63110000)			16 359 7180 (4UYF63120000)
50	Yh Flipper Eu2	03-04	16 359 2210 (5EUF63110000)			16 359 7180 (4UYF63120000)
50	Yn R Ovetto (Che- Ita)	97-01		16 359 2100 (5ADF63110100)		16 359 7090 (5RNF63122000)
50	Yn R Ovetto Eu1	02-04		16 359 2100 (5ADF63110100)		16 359 7090 (5RNF63122000)
50	Yn R Ovetto Eu2	02-03		16 359 2100 (5ADF63110100)		16 359 7090 (5RNF63122000)
50	Yq L Nitro Jaguar	04	16 359 2110 (5BRF63110000)			16 359 7060 (3VFL63120100)
50	Yq Nitro	01-02	16 359 2110 (5BRF63110000)			16 359 7060 (3VFL63120100)
50	Yq Nitro	04	16 359 2110 (5BRF63110000)			16 359 7060 (3VFL63120100)
50	Yq Nitro (Ita)	97-98	16 359 2110 (5BRF63110000)			16 359 7060 (3VFL63120100)
50	Yq Nitro (Ita)	99-00	16 359 2110 (5BRF63110000)			16 359 7060 (3VFL63120100)
50	Yq Nitro Eu2	03				16 359 7060 (3VFL63120100)
125	Yp Skyliner	98-00	16 359 0190 (5DSF63110000)			
125	Yp Skyliner	01-02	16 359 0190 (5DSF63110000)			
150	Yp Skyliner	00	16 359 0190 (5DSF63110000)			
150	Yp Skyliner	01-02	16 359 0190 (5DSF63110000)			



CC	MODELLO MODEL	ANNI YEARS	CAVO GAS THROTTLE	COMANDO SDOPPIATORE CONTROL SPLITTER	SDOPPIATORE MISCELATORE SPLITTER MIX	SDOPPIATORE CARBURATORE CARBURATOR SPLITTER
PIAGGIO						
50	Fly 2T	05-07		16 359 2240 (581539)	16 359 5030 (268403)	16 359 7300 (583334)
50	Fly 2T	10-11		16 359 2240 (581539)	16 359 5030 (268403)	
50	Fly 4T	05-07	16 359 2520 (601113)			
50	Fly 4T & 25-30 Km/H	08-11	16 359 2520 (601113)			
50	Fly 4T Motore Chn	06-07	16 359 2520 (601113)			
50	Free	92-94		16 359 2140 (581132)	16 359 5050 (268597)	16 359 7120 (269064)
50	Free Delivery	00-01		16 359 2140 (581132)	16 359 5050 (268597)	16 359 7120 (269064)
50	Free FL	95-02		16 359 2140 (581132)	16 359 5050 (268597)	16 359 7120 (269064)
50	Liberty	97-05		16 359 2150 (268435)	16 359 5080 (560448) 16 359 5030 MY02 (268403)	16 359 7030 (581173)
50	Liberty 2T	06			16 359 5030 (268403)	16 359 7300 (583334)
50	Liberty 2T	07-08			16 359 5030 (268403)	16 359 7300 (583334)
50	Liberty 2T Rst	04			16 359 5030 (268403)	16 359 7300 (583334)
50	Liberty 2T Sport	06			16 359 5030 (268403)	16 359 7300 (583334)
50	Liberty 2T Sport	07-08			16 359 5030 (268403)	16 359 7300 (583334)
50	Liberty 4T	00-02	16 359 2390 (582426)			
50	Liberty 4T Rst	04	16 359 2390 (582426)			
50	Liberty Moc 2T & Elle	09-13			16 359 5030 (268403)	16 359 7300 (583334)
50	Liberty Ptt Eu2	04-05			16 359 5030 (268403)	16 359 7300 (583334)
50	Nrg	94-96		16 359 2010 (270995)	16 359 5010 (272290)	16 359 7010 (272289)
50	Nrg Extreme Aria Tamburo - <i>Ac Brake Drum</i>	99-00		16 359 2240 (581539)	16 359 5080 (560448)	16 359 7020 (268402)
50	Nrg Extreme Liquido Doppio Disco <i>Lc Brake Disc</i>	99-00		16 359 2240 (581539)	16 359 5140 (583808)	16 359 7030 (581173)
50	Nrg Mc3 Tamburo - <i>Brake Drum</i>	01-04		16 359 2240 (581539)	16 359 5080 (560448)	16 359 7030 (581173)
50	Nrg Mc3 Disco - <i>Brake Drum</i>	01-04		16 359 2240 (581539)	16 359 5140 (583808)	
50	Nrg Power Dd	05		16 359 2240 (581539)		
50	Nrg Power Dd	06		16 359 2240 (581539)		
50	Nrg Power Dd Serie Speciale	07-12		16 359 2240 (581539)		
50	Nrg Power Dt	06		16 359 2240 (581539)		



TRASMISSIONI GAS

THROTTLE TRANSMISSIONS

CC	MODELLO MODEL	ANNI YEARS	CAVO GAS THROTTLE	COMANDO SDOPPIATORE CONTROL SPLITTER	SDOPPIATORE MISCELATORE SPLITTER MIX	SDOPPIATORE CARBURATORE CARBURATOR SPLITTER
50	Nrg Power Dt	07-11		16 359 2240 (581539)		
50	Nrg Power Dt Serie Speciale	07-08		16 359 2240 (581539)		
50	Nrg Power Purejet	06		16 359 2240 (581539)		
50	Nrg Power Purejet	07-09		16 359 2240 (581539)		
50	Nrg Purejet	02-04		16 359 2240 (581539)	16 359 5080 (560448)	
50	Nrg Rst Mc2	96-98		16 359 2280 (563902)	16 359 5140 (583808)	16 359 7030 (581173)
50	Ntt	95-96		16 359 2010 (270995)	16 359 5010 (272290)	16 359 7010 (272289)
50	Quartz	92-96		16 359 2150 (268435)	16 359 5030 (268403)	16 359 7020 (268402)
50	Sfera Maquillage 2	94			16 359 5070 (268812)	16 359 7140 (268811)
50	Sfera Rst	95-97		16 359 2150 (268435)	16 359 5080 (560448)	16 359 7020 (268402)
50	Sfera	91-93		16 359 2160 (267981)	16 359 5060 (267018)	
50	Typhoon	01-04			16 359 5080 (560448)	16 359 7300 (583334)
50	Typhoon	05-08		16 359 2240 (581539)	16 359 5150 (563276)	16 359 7300 (583334)
50	Typhoon	09-11		16 359 2240 (581539)	16 359 5150 (563276)	16 359 7300 (583334)
50	Typhoon 2T Eu2	10-12			16 359 5030 (268403)	
50	Typhoon 2T Eu3 Ch	11			16 359 5030 (268403)	
50	Vespa Et2	97-05		16 359 2200 (581883)	16 359 5110 (562408)	16 359 7170 (582908)
50	Vespa Et2 Iniezione	97-00		16 359 2200 (581883)	16 359 5110 (562408)	
50	Vespa Et4	00-05	16 359 2390 (582426)			
50	Zip	92-93		16 359 2180 (269059)	16 359 5070 (268812)	16 359 7140 (268811)
50	Zip (Freno A Disco- <i>Brake Disc</i>)	95-96		16 359 2150 (268435)	16 359 5040 (271829)	16 359 7020 (268402)
50	Zip (Freno A Disco- <i>Brake Disc</i>)	95-96		16 359 2180 (269059)	16 359 5070 (268812)	16 359 7140 (268811)
50	Zip	00-04		16 359 2450 (561149)	16 359 5080 (560448)	16 359 7300 (583334)
50	Zip 2T	08-13		16 359 2450 (561149)	16 359 5080 (560448)	16 359 7300 (583334)
50	Zip 4T	00-05		16 359 2490 (582663)		
50	Zip 4T	06-13		16 359 2480 (646791)		
50	Zip Bimodale	94-97			16 359 5070 (268812)	16 359 7140 (268811)
50	Zip Fast Raider	93-94		16 359 2150 (268435)	16 359 5040 (271829)	16 359 7020 (268402)
50	Zip Fast Raider Rst	96-97		16 359 2150 (268435)	16 359 5080 (560448)	16 359 7020 (268402)

TRASMISSIONI GAS
THROTTLE TRANSMISSIONS



CC	MODELLO MODEL	ANNI YEARS	CAVO GAS THROTTLE	COMANDO SDOPPIATORE CONTROL SPLITTER	SDOPPIATORE MISCELATORE SPLITTER MIX	SDOPPIATORE CARBURATORE CARBURATOR SPLITTER
50	Zip Rst (Freno A Disco- <i>Brake Disc</i>)	96-99		16 359 2150 (268435)	16 359 5080 (560448)	16 359 7020 (268402)
50	Zip Rst (Freno A Tamburo- <i>Brake Drum</i>)	96-99		16 359 2180 (269059)	16 359 5070 (268812)	16 359 7140 (268811)
50	Zip Sp	96-00		16 359 2150 (268435)	16 359 5080 (560448)	16 359 7020 (268402)
50	Zip Sp	01-04		16 359 2450 (561149)	16 359 5080 (560448)	
50	Zip Sp Eu2	06-13		16 359 2450 (561149)	16 359 5080 (560448)	
100	Fly 4T	06-07	16 359 2520 (601113)			
100	Fly 4T	08	16 359 2520 (601113)			
100	Free	02-03		16 359 2140 (581132)		
100	Zip 4T	06-10		16 359 2480 (646791)		
125	Fly	05-07	16 359 2500 (CM073305)			
125	Fly Eu3	07	16 359 2520 (601113)			
125	Fly Eu3	08-11	16 359 2510 (649603) <i>Chiude-Close</i> 16 359 2530 (649602) <i>Apri - Open</i>			
125	Liberty	1998	16 359 0130 (561804)			
125	Liberty	99-00	16 359 2260 (CM065903)			
125	Liberty	01-02	16 359 2350 (CM065904)			
125	Sfera	95-97	16 359 0130 (561804)			
125	Skipper	94-97		16 359 2150 (268435)		
125	Skipper 4T	00-02	16 359 0390 (CM065912)			
125	Typhoon 4T 2V Eu3	10-11	16 359 2510 (649603) <i>Chiude-Close</i> 16 359 2530 (649602) <i>Apri - Open</i>			
125	Vespa Et4	8/96-98	16 359 0130 (561804)			
125	Vespa Et4	9/98-99	16 359 2260 (CM065903)			
125	Vespa Et4	99-02	16 359 0360 (CM065907)			
125	X9	01-02		16 359 0690 (CM065911)		
125	X9 Evolution	03		16 359 0690 (CM065911)		
150	Fly	05-07	16 359 2500 (CM073305)			



TRASMISSIONI GAS

THROTTLE TRANSMISSIONS

CC	MODELLO MODEL	ANNI YEARS	CAVO GAS THROTTLE	COMANDO SDOPPIATORE CONTROL SPLITTER	SDOPPIATORE MISCELATORE SPLITTER MIX	SDOPPIATORE CARBURATORE CARBURATOR SPLITTER
150	Fly Eu3	08-11	16 359 2510 (649603) Chiude- <i>Close</i> 16 359 2530 (649602) Apri - <i>Open</i>			
180	X9 Amalfi	00-03		16 359 0690 (CM065911)		
200	X9 Evolution	03		16 359 0690 (CM065911)		
250	X9 Evolution	04		16 359 0690 (CM065911)		
YAMAHA						
50	Bw's	04-05		16 359 2070 (3VLF63110100)		
50	Bw's	06-07		16 359 2070 (3VLF63110100)		
50	Bw's	08-12		16 359 2070 (3VLF63110100)		
50	Bw's Bump	97-98		16 359 2070 (3VLF63110100)		
50	Bw's Naked	03		16 359 2070 (3VLF63110100)		
50	Bw's Naked	04		16 359 2470 (2B7F6311000)		
50	Bw's Naked	09-12		16 359 2470 (2B7F6311000)		
50	Bw's Next Generation	97-98		16 359 2070 (3VLF63110100)		
50	Bw's Next Generation	99		16 359 2070 (3VLF63110100)		
50	Bw's Next Generation	01-02		16 359 2070 (3VLF63110100)		
50	Bw's Next Generation	03		16 359 2070 (3VLF63110100)		
50	Bw's Next Generation	04-06		16 359 2070 (3VLF63110100)		
50	Bw's Next Generation Cat.	99-00		16 359 2070 (3VLF63110100)		
50	Bw's Original	97-98		16 359 2070 (3VLF63110100)		
50	Bw's Original	99		16 359 2070 (3VLF63110100)		
50	Bw's Original	99-00		16 359 2070 (3VLF63110100)		
50	Bw's Original	01-02		16 359 2070 (3VLF63110100)		
50	Bw's Original Eu2	03		16 359 2070 (3VLF63110100)		
50	Bw's R	01		16 359 2070 (3VLF63110100)		
50	Ct S	90-95		16 359 2090 (1NTF63110000)		
50	Ct Ss	92-95		16 359 2090 (1NTF63110000)		
50	Cw Bw's Original Eu2	02		16 359 2070 (3VLF63110100)		

TRASMISSIONI GAS
THROTTLE TRANSMISSIONS



CC	MODELLO MODEL	ANNI YEARS	CAVO GAS THROTTLE	COMANDO SDOPPIATORE CONTROL SPLITTER	SDOPPIATORE MISCELATORE SPLITTER MIX	SDOPPIATORE CARBURATORE CARBURATOR SPLITTER
50	Cw L Bw's	03		16 359 2070 (3VLF63110100)		
50	Cw L Bw's	04		16 359 2070 (3VLF63110100)		
50	Cw Rs Spy	95-98		16 359 2070 (3VLF63110100)		
50	Cw Sp Bw's Original Eu2	02		16 359 2070 (3VLF63110100)		
50	Ew Slider	00-02		16 359 2230 (4UYF63110000)		
50	Yh Why	98		16 359 2210 (5EUF63110000)		
50	Yh Why	01-02		16 359 2210 (5EUF63110000)		
50	Yh Why	06		16 359 2210 (5EUF63110000)		
50	Yh Why Eu1	99-00		16 359 2210 (5EUF63110000)		
50	Yh Why Eu2	03-05		16 359 2210 (5EUF63110000)		
50	Yn Neo's	04-06		16 359 2100 (5ADF63110100)		
50	Yn Neo's Eu2	02-03		16 359 2100 (5ADF63110100)		
50	Yn R Neo's	97-01		16 359 2100 (5ADF63110100)		
50	Yn R Neo's	02		16 359 2100 (5ADF63110100)		
50	Yq Aerox	97-98		16 359 2110 (5BRF63110000)		
50	Yq Aerox	01-02		16 359 2110 (5BRF63110000)		
50	Yq Aerox	04		16 359 2110 (5BRF63110000)		
50	Yq Aerox	05		16 359 2110 (5BRF63110000)		
50	Yq Aerox	06		16 359 2110 (5BRF63110000)		
50	Yq Aerox	07		16 359 2110 (5BRF63110000)		
50	Yq Aerox	08		16 359 2110 (5BRF63110000)		
50	Yq Aerox	09		16 359 2070 (3VLF63110100)		
50	Yq Aerox	10-12		16 359 2070 (3VLF63110100)		
50	Yq Aerox R	99		16 359 2110 (5BRF63110000)		
50	Yq Aerox R	99-00		16 359 2110 (5BRF63110000)		
50	Yq L Aerox Eu2	03		16 359 2110 (5BRF63110000)		
125	Yp125 Majesty	98-00	16 359 0190 (5DSF63110000)			
150	Yp150 Majesty	00	16 359 0190 (5DSF63110000)			



TRASMISSIONI STARTER

STARTER TRANSMISSIONS

CC	MODELLO MODEL	ANNI YEARS	STARTER SUPERIORE STARTER UPPER CABLE	STARTER INFERIORE STARTER LOWER CABLE
APRILIA				
50	Amico	94	16 361 0010 (AP8214108)	
50	Amico	96-98	16 361 0010 (AP8214108)	
50	Amico GL-GLE	93-95	16 361 0010 (AP8214108)	
50	Amico Lx- Sport-Cat	92-93	16 361 0010 (AP8214108)	
50	Gulliver	95-98	16 361 0030 (AP8214159)	
50	Gulliver Lc	96-98	16 361 0030 (AP8214159)	
50	Rally	95-03	16 361 0030 (AP8214159)	
50	Rally Liquid Cooled	96-99	16 361 0100 (AP8214166)	
50	Scarabeo	93-97	16 361 0020 (AP8214124)	
50	Scarabeo	98	16 361 0020 (AP8214124)	
50	Scarabeo	99	16 361 0020 (AP8214124)	
50	Scarabeo	00-05	16 361 0020 (AP8214124)	
50	Sonic	98-07	16 361 0090 (AP8214171)	
50	Sonic Gp	98-08	16 361 0090 (AP8214171)	
50	Sr	93	16 361 0010 (AP8214108)	
50	Sr	93	16 361 0010 (AP8214108)	
50	Sr Liquid Cooled	94-96	16 361 0010 (AP8214108)	
50	Sr Stealth, Racing	97-00	16 361 0030 (AP8214159)	
50	Sr Www	97-01	16 361 0030 (AP8214159)	
MBK				
50	Cw Booster	90-91	16 361 3010 (3VLF63310000)	16 361 6010 (3VLF63340200)
50	Cw Booster	01-02	16 361 3010 (3VLF63310000)	16 361 6010 (3VLF63340200)
50	Cw Booster (ITA)	92-94	16 361 3010 (3VLF63310000)	16 361 6010 (3VLF63340200)
50	Cw Booster Naked	03		16 361 6010 (3VLF63340200)
50	Cw Booster Spirit	96-98	16 361 3010 (3VLF63310000)	16 361 6010 (3VLF63340200)
50	Cw Booster Spirit (ITA)	99	16 361 3010 (3VLF63310000)	16 361 6010 (3VLF63340200)
50	Cw Booster Spirit (ITA)	00	16 361 3010 (3VLF63310000)	16 361 6010 (3VLF63340200)

CC	MODELLO MODEL	ANNI YEARS	STARTER SUPERIORE STARTER UPPER CABLE	STARTER INFERIORE STARTER LOWER CABLE
50	Cw Booster Spirit Eu2	02	16 361 3010 (3VLF63310000)	16 361 6010 (3VLF63340200)
50	Cw Booster Spirit Eu2	03	16 361 3010 (3VLF63310000)	16 361 6010 (3VLF63340200)
50	Cw L Booster	01-03	16 361 3010 (3VLF63310000)	16 361 6010 (3VLF63340200)
50	Cw L Booster Spirit	03	16 361 3010 (3VLF63310000)	16 361 6010 (3VLF63340200)
50	Cw R Booster Road (ITA)	94-95	16 361 3010 (3VLF63310000)	16 361 6010 (3VLF63340200)
50	Cw Rs Booster Ng	01-02		16 361 6010 (3VLF63340200)
50	Cw Rs Booster Ng	03		16 361 6010 (3VLF63340200)
50	Cw Rs Booster Ng (ITA)	95-98		16 361 6010 (3VLF63340200)
50	Cw Rs Booster Ng (ITA)	99		16 361 6010 (3VLF63340200)
50	Cw Rs Booster Ng Eu1	99-00		16 361 6010 (3VLF63340200)
50	Cw Rsp Booster Rocket (ITA)	97-98		16 361 6010 (3VLF63340200)
50	Cw Rsx Booster Track (ITA)	96-98		16 361 6010 (3VLF63340200)
50	Cw Sp Booster Spirit Eu2	02	16 361 3010 (3VLF63310000)	16 361 6010 (3VLF63340200)
50	Ew Stunt	00-02		16 361 6010 (3VLF63340200)
50	Yn R Ovetto (Che- ITA)	97-01	16 361 3030 (5ADF63310000)	
50	Yq Nitro	01-02		16 361 6010 (3VLF63340200)
50	Yq Nitro	04		16 361 6010 (3VLF63340200)
50	Yq Nitro (ITA)	97-98		16 361 6010 (3VLF63340200)
50	Yq Nitro (ITA)	99-00		16 361 6010 (3VLF63340200)
100	Yn Ovetto	00-02	16 361 3030 (5ADF63310000)	
YAMAHA				
50	Bw's Bump	97-98		16 361 6010 (3VLF63340200)
50	Bw's Naked	03		16 361 6010 (3VLF63340200)
50	Bw's Next Generation	97-98		16 361 6010 (3VLF63340200)
50	Bw's Next Generation	99		16 361 6010 (3VLF63340200)
50	Bw's Next Generation	01-02		16 361 6010 (3VLF63340200)
50	Bw's Next Generation	03		16 361 6010 (3VLF63340200)



CC	MODELLO MODEL	ANNI YEARS	STARTER SUPERIORE STARTER UPPER CABLE	STARTER INFERIORE STARTER LOWER CABLE
50	Bw's Next Gene- ration	04-06		16 361 6010 (3VLF63340200)
50	Bw's Next Generation Cat.	99-00		16 361 6010 (3VLF63340200)
50	Bw's Original	97-98	16 361 3010 (3VLF63310000)	16 361 6010 (3VLF63340200)
50	Bw's Original	99	16 361 3010 (3VLF63310000)	16 361 6010 (3VLF63340200)
50	Bw's Original	99-00	16 361 3010 (3VLF63310000)	16 361 6010 (3VLF63340200)
50	Bw's Original	01-02	16 361 3010 (3VLF63310000)	16 361 6010 (3VLF63340200)
50	Bw's Original Eu2	03	16 361 3010 (3VLF63310000)	16 361 6010 (3VLF63340200)
50	Bw's R	01	16 361 3010 (3VLF63310000)	16 361 6010 (3VLF63340200)
50	Cw Bw's Original Eu2	02	16 361 3010 (3VLF63310000)	16 361 6010 (3VLF63340200)
50	Cw L Bw's	03	16 361 3010 (3VLF63310000)	16 361 6010 (3VLF63340200)
50	Cw Rs Spy	95-98		16 361 6010 (3VLF63340200)
50	Cw Sp Bw's Original Eu2	02	16 361 3010 (3VLF63310000)	16 361 6010 (3VLF63340200)
50	Ew Slider	00-02		16 361 6010 (3VLF63340200)
50	Yn R Neo's	97-01	16 361 3030 (5ADF63310000)	
50	Yq Aerox	97-98		16 361 6010 (3VLF63340200)
50	Yq Aerox	01-02		16 361 6010 (3VLF63340200)
50	Yq Aerox	04		16 361 6010 (3VLF63340200)
50	Yq Aerox	05		16 361 6010 (3VLF63340200)
50	Yq Aerox	06		16 361 6010 (3VLF63340200)
50	Yq Aerox	07		16 361 6010 (3VLF63340200)
50	Yq Aerox	08		16 361 6010 (3VLF63340200)
50	Yq Aerox R	99		16 361 6010 (3VLF63340200)
50	Yq Aerox R	99-00		16 361 6010 (3VLF63340200)
100	Yn Neo's	99-02	16 361 3030 (5ADF63310000)	





RMS
YOUR BEST PARTNER



CAVI GAS - THROTTLE CABLES					
	CODICE CODE	OEM	MODELLO MODEL	CC	ANNO YEAR
 1,2x3200	16 351 0041	118307	Ape FL-FL2	50	89-95
			Ape FL3-Europa		96-99
			Ape P		80-85
			Ape Tm P		85-89
 1,2x3200	16 351 0051	1,2x3200	Ape Mp 501-601	220	
	16 351 0060		Ape Mp 501-601	220	
	16 351 0070		Ape P602 Mix	220	
CAVI FRIZIONE - CLUTCH CABLES					
	CODICE - CODE	OEM	MODELLO - MODEL	CC	ANNO YEAR
 1,9x2800	16 351 4061	118313	Ape Tm P	50	85-89
			Ape Rst Mix		99-03
			Ape P		80-85
			Ape Mix 2 tempi		98-08
			Ape FL3-Europa		96-99
			Ape FL- FL2		89-95
 2,5x3000	16 351 4090	136507	Ape Car P2-P3	220	78-85



CAVI TRASMISSIONI APE
APE TRANSMISSION CABLES

 1,9x3000	16 351 4071	1,9x3000	Ape P 602	220	82-83
	16 351 4101		Ape Tm P703	220	84-05
			Ape P 703 V		84-05
			Ape FL2		84-05
			Ape Tm P 602		82-83

CAVI CAMBIO - GEAR SHIFT CABLES

	CODICE - CODE	OEM	MODELLO - MODEL	CC	ANNO YEAR
	16 351 6031		Ape FL-FL2	50	89-95
			Ape FL3-Europa		96-99
			Ape P		80-85
			Ape Tm P		85-89
 1,6x3000	16 351 6041		Ape Tm P 602	220	82-83
	16 351 6050	177920	Ape Tm P 602	220	82-83
			Ape P 703	420	87-04
			Ape P 703 V Diesel		87-04

CAVI STARTER - STARTER CABLES

	CODICE - CODE	OEM	MODELLO - MODEL	CC	ANNO YEAR
	16 351 2010	214168	Ape Tm P703	220	84-05
			Ape P 703 V		84-05
			Ape P 703 FL2		84-05
			Ape Tm P602		82-83
			Ape Tm		09-15
			Ape Mp P501		09-15
			Ape Mp P601		78-96



TRASMISSIONI GAS - THROTTLE TRANSMISSIONS					
	CODICE - CODE	OEM	MODELLO - MODEL	CC	ANNO YEAR
	16 359 0630	177128	Ape P 602 Versione manubrio	220	82-83
			Ape P 703		84-05
			Ape P 703 V		84-05
			Ape P 703 FL2		84-05
TRASMISSIONI FRIZIONE - CLUTCH TRANSMISSIONS					
	CODICE - CODE	OEM	MODELLO - MODEL	CC	ANNO YEAR
	16 357 0020	177150	Ape P 602	220	82-83
			Ape P 703		84-05
			Ape P 703 V		84-05
			Ape P 703 FL2		84-05
	16 357 0040	266494	Ape Poker Benzina	420	93-93
			Ape Poker Diesel		93-97
	16 357 0060	228715	Ape Tm P 703	420	87-04
			Ape P 703 V Diesel		87-04



TRASMISSIONI CAMBIO - GEAR SHIFT TRANSMISSIONS					
	CODICE - CODE	OEM	MODELLO - MODEL	CC	ANNO YEAR
	16 358 0020	197097	Ape Tm	220	09-15
			Ape Tm P703		84-05
			Ape P703 V		84-05
			Ape P 703 FL2		84-05
	16 358 0040	228712	Ape Tm Diesel LCS	420	05-12
			Ape Tm P703		87-04
			Ape P 703 V		87-04
			Ape P 703 Diesel		87-04
TRASMISSIONI STARTER - STARTER TRANSMISSIONS					
	CODICE - CODE	OEM	MODELLO - MODEL	CC	ANNO YEAR
	16 361 0080	118456	Ape P	50	80-85
	16 361 0110	194821	Ape FL2	50	89-95
			Ape FL3 Europa		96-99
			Ape Rst Mix		99-03
TRASMISSIONI SDOPPIATORE MISCELATORE - SPLITTER MIXER TRANSMISSIONS					
	CODICE - CODE	OEM	MODELLO - MODEL	CC	ANNO YEAR
	16 359 5190	567104	Ape	50	09-15
			Ape Mix 2 tempi		98-08
			Ape Rst Mix		99-03



	16 359 5120	133441	Ape Mp 501 1 serie	220	78-96
			Ape P 601		78-96
	16 359 5130	224979	Ape Car P2-P3 2 Serie	220	78-85
			Ape Mp 501		78-96
			Ape P 601		78-96
			Ape Tm		09-15
			Ape Tm P 602		82-83
			Ape P 703		84-05
			Ape P 703 V		84-05
			Ape P 703 FL2		84-05
TRASMISSIONI SDOPPIATORE CARBURATORE - <i>SPLITTER CARBURATOR TRANSMISSIONS</i>					
	CODICE - CODE	OEM	MODELLO - MODEL	CC	ANNO YEAR
	16 359 7290	567103	Ape	50	09-15
			Ape Mix 2 tempi		98-08
			Ape Rst Mix		99-03
TRASMISSIONI RETROMARCIA - <i>REVERSE TRANSMISSIONS</i>					
	CODICE - CODE	OEM	MODELLO - MODEL	CC	ANNO YEAR
	16 358 5000	117309	Ape Tm P	50	85-89
			Ape P		80-85
	16 358 5010	258646	Ape Rst Mix	50	99-03
			Ape Mix 2 tempi		98-08
			Ape FL3-Europa		96-99
			Ape FL- FL2		89-95
			Ape		09-15
	16 358 5030	159693	Ape Mp 501	220	78-96
			Ape P 601		78-96



CAVI TRASMISSIONI APE
APE TRANSMISSION CABLES

	16 358 5040	266596	Ape Tm P703	220	84-05
			Ape P 703 V		84-05
			Ape FL2		84-05
			Ape Tm		09-15
	16 358 5050	197069	Ape Tm P602	220	82-83

TRASMISSIONI FRENO A MANO - HANDBRAKE TRANSMISSIONS

	CODICE - CODE	OEM	MODELLO - MODEL	CC	ANNO YEAR
	16 355 5460	140247	Ape Mp P 501	220	82-83
			Ape P 601		82-83
	16 355 5470	189752	Ape Tm P703	220	84-05
			Ape Tm 602		82-83
			Ape P 703 V Diesel	420	87-04
	16 355 5480	214153	Ape Tm P 703	220	84-05
			Ape P 703 V		84-05
			Ape FL2		84-05
			Ape Tm P 602	420	82-83
			Ape Tm P703		87-04
			Ape P 703 V Diesel		87-04

TRASMISSIONI CONTACHILOMETRI - SPEEDOMETER TRANSMISSIONS

	CODICE - CODE	OEM	MODELLO - MODEL	CC	ANNO YEAR
	16 363 1080	188636	Ape	50	09-15
			Ape FL-FL2		89-95
			Ape FL3-Europa		96-99
			Ape Mix 2 tempi		98-08
			Ape P		80-85
			Ape Rst Mix		99-03
			Ape Tm P		85-89
	16 363 0850	194371	Ape Tm P 602	220	82-83
			Ape Tm		84-05
			Ape P 703 V		84-05
			Ape P 703 FL2		84-05



KIT TRASMISSIONI GUAINE GRIGIE E CAVI COMPLETO VESPA - VESPA TRANSMISSIONS KIT

MODELLO MODEL	CC	CODICE RMS RMS CODE	CODICE A BARRE BARCODE	CODICE ORIGINALE - OEM CODE						
				GAS THROTTLE	CAMBIO GEAR	FRIZIONE CLUTCH	FRENO ANT. FRONT BRAKE	FRENO POST. REAR BRAKE	STARTER CHOKE	CONTAKM SPEEDOMETER
Vespa	50-90	16 362 0010		139403	139402	192681	174164	174701	098221	071059
Vespa Primavera Et3	125	16 362 0020		139403	139402	192681	174164	174701	152391	071059
Vespa GL-Sprint	125-150	16 362 0030		139403	139402	192681	174164	174701	092370	099011
Vespa Px 1 Serie Tamburo	125-150-200	16 362 0040		139403	139402	192681	174164	174701	092370	174161
Vespa Px Arcobaleno	125-150-200	16 362 0050		139403	139402	192681	179642	191804	104292	179271
Vespa Px Disco	125-150-200	16 362 0060		139403	139402	192681	-	191804	104292	563796
Vespa	50-90	16 362 0190		139403	139402	192681	174164	174701	098221	-
Vespa Special	50	16 362 0220		139403	139402	192681	174164	191804	098221	071059
Vespa Px 2 Serie	125-150-200	16 362 0170		139403	139402	192681	174164	191804	092370	174161

KIT TRASMISSIONI GUAINE IN TEFLON® E CAVI COMPLETO VESPA - VESPA TEFLON® TRANSMISSION KIT

MODELLO MODEL	CC	CODICE RMS RMS CODE	CODICE A BARRE BARCODE	CODICE ORIGINALE - OEM CODE						
				GAS THROTTLE	CAMBIO GEAR	FRIZIONE CLUTCH	FRENO ANT. FRONT BRAKE	FRENO POST. REAR BRAKE	STARTER CHOKE	CONTAKM SPEEDOMETER
Vespa	50-90	16 362 0070		139403	139402	192681	174164	174701	098221	071059
Vespa Primavera Et3	125	16 362 0080		139403	139402	192681	174164	174701	152391	071059
Vespa GL-Sprint	125-150	16 362 0090		139403	139402	192681	174164	174701	092370	099011
Vespa Px 1 Serie	125-150-200	16 362 0100		139403	139402	192681	174164	174701	092370	174161
Vespa Px Arcobaleno	125-150-200	16 362 0110		139403	139402	192681	179642	191804	104292	179271
Vespa Px Freno Disco	125-150-200	16 362 0120		139403	139402	192681	-	191804	104292	563796
Vespa Px 2 Serie	125-150-200	16 362 0180		139403	139402	192681	174164	191804	092370	174161
Vespa	50-90	16 362 0200		139403	139402	192681	174164	174701	098221	-
Vespa Special	50	16 362 0230		139403	139402	192681	174164	191804	098221	071059



TRASMISSIONI STARTER - CHOKE TRANSMISSIONS



CC	MODELLO - MODEL	CODICE RMS - RMS CODE	RIF. ORIGINALE - OEM CODE
50	Pk-N-R-Special	16 361 0040	098221
90	Ss-Sprint	16 361 0040	098221
125	Pk	16 361 0040	098221
125	Et3-Primavera	16 361 0060	152391
150	Sprint '59-Gl'64-'65	16 361 0120	092370
160	Gs	16 361 0120	092370
180	Ss	16 361 0120	092370
200	Rally	16 361 0120	092370
125-150-200	Px Tamburo/Drum	16 361 0120	092370
125-150-200	Px Arcobaleno Px Freno A Disco/Disc	16 361 0130	104292



TRASMISSIONI CONTACHILOMETRI - SPEEDOMETER TRANSMISSIONS



CC	MODELLO - MODEL	CODICE RMS - RMS CODE	RIF. ORIGINALE - OEM CODE
50	Ciao	16 363 0990	187423
50	N - R - Special	16 363 1010	071059
50	Pk	16 363 1040	195407
50	Hp	16 363 1030	266231
90	Ss -Sprint	16 363 1010	071059
125	Primavera	16 363 1010	071059
125	Primavera Att. Rapido	16 363 1960	183582
125	Et3	16 363 1010	071059
125	Pk	16 363 1040	195407
125	FL2	16 363 1030	266231
125	Vespa V30 - V33	16 363 2120 NEW	021151
125-150-200	Px 1° Serie	16 363 1050	174261
125-150-200	Px Arcobaleno	16 363 1060	179271
125-150-200	Px Freno a Disco	16 363 1250	563796
125-150-200	Cosa 1 - 2	16 363 1070	229358
125-150-200	Lambretta Li 3° Serie	16 363 1970	00611068
125-150-200	Lambretta DL	16 363 1980	00611125
150	Sprint	16 363 1900	099011
150	GL 64	16 363 1910	097713
150	65	16 363 1920	098641
150	59	16 363 1930	-
150	Vespa Gs	16 363 2130 NEW	024190
160	Gs	16 363 1940	057045
180	Ss	16 363 1050	090525
200	Rally	16 363 1950	090525

TRASMISSIONI PER KIT CONTACHILOMETRI - TRANSMISSIONS FOR SPEEDOMETER KIT

CC	MODELLO - MODEL	CODICE RMS - RMS CODE	RIF. ORIGINALE - OEM CODE
50-90-125	Vespa Primavera Modifica-Modified Per contaKm-For Speedometer: 16 368 0004 - 16 368 0014 16 368 0074 - 16 368 0104	16 363 1011 NEW	-
125-150-200	Vespa Px + Vespa Px 1° serie Modifica-Modified Per ContaKm-For Speedometer: 16 368 0093 - 16 368 0094	16 363 1051 NEW	-
150	Vespa GL Modifica-Modified Per ContaKm-For Speedometer: 16 368 0114 - 16 368 0044	16 363 1901 NEW	-
150	Vespa Gs Modifica-Modified Per ContaKm-For Speedometer: 16 368 0123	16 363 2131 NEW	-



CAVI VESPA - VESPA CABLES

CONFEZIONE 1 Pz - 1 PC. PACK

CC	MODELLO MODEL	CAVO GAS NIPPLO PICCOLO THROTTLE CABLE SMALL NIPPLE	CAVO GAS BARILOTTO THROTTLE CABLE	CAVO FRIZIONE CLUTCH CABLE	CAVO CAMBIO SHIFT CABLE	CAVO FRENO POST. REAR BRAKE CABLE
50	N-R-Special	16 351 0011 (Ø 1.2 x 2000 mm) 16 351 0091 (Ø 1.2 x 3200 mm)	16 351 0021 (Ø 1.2 x 2000 mm)	16 351 4011 (Ø 1.9 x 2500 mm)	16 351 6011 (Ø 1.6 x 2000 mm)	16 351 8021 (Ø 3 x 1000 mm)
50	Pk FL				16 351 6020	16 351 8021 (Ø 3 x 1000 mm)
50	Hp			16 351 4021 (Ø 1.9 x 2000 mm)	16 358 0010 Trasmissione Completa <i>Complete Transmission</i>	16 351 8021 (Ø 3 x 1000 mm)
50-125	Pk			16 351 4021 (Ø 1.9 x 2000 mm)		16 351 8021 (Ø 3 x 1000 mm)
90	Ss-Srint	16 351 0011 (Ø 1.2 x 2000 mm) 16 351 0091 (Ø 1.2 x 3200 mm)	16 351 0021 (Ø 1.2 x 2000 mm)	16 351 4011 (Ø 1.9 x 2500 mm)	16 351 6011 (Ø 1.6 x 2000 mm)	16 351 8021 (Ø 3 x 1000 mm)
125	Primavera	16 351 0011 (Ø 1.2 x 2000 mm) 16 351 0091 (Ø 1.2 x 3200 mm)	16 351 0021 (Ø 1.2 x 2000 mm)	16 351 4011 (Ø 1.9 x 2500 mm)	16 351 6011 (Ø 1.6 x 2000 mm)	16 351 8021 (Ø 3 x 1000 mm)
125	T5	16 351 0011 (Ø 1.2 x 2000 mm) 16 351 0091 (Ø 1.2 x 3200 mm)	16 351 0021 (Ø 1.2 x 2000 mm)	16 351 4011 (Ø 1.9 x 2500 mm)		16 355 0090 Trasmissione Freno Ant. <i>Front BrakeCable</i>
150	'59-Sprint GL '64-'65	16 351 0011 (Ø 1.2 x 2000 mm) 16 351 0091 (Ø 1.2 x 3200 mm)	16 351 0021 (Ø 1.2 x 2000 mm)	16 351 4011 (Ø 1.9 x 2500 mm)	16 351 6011 (Ø 1.6x2000mm)	
160	Gs	16 351 0011 (Ø 1.2 x 2000 mm) 16 351 0091 (Ø 1.2 x 3200 mm)	16 351 0021 (Ø 1.2x2000mm)	16 351 4011 (Ø 1.9x2500mm)	16 351 6011 (Ø 1.6x2000mm)	
180	Ss	16 351 0011 (Ø 1.2 x 2000 mm) 16 351 0091 (Ø 1.2 x 3200 mm)	16 351 0021 (Ø 1.2 x 2000 mm)	16 351 4011 (Ø 1.9 x 2500 mm)	16 351 6011 (Ø 1.6 x 2000 mm)	
125-150-200	Px	16 351 0011 (Ø 1.2 x 2000 mm) 16 351 0091 (Ø 1.2 x 3200 mm)	16 351 0021 (Ø 1.2 x 2000 mm)	16 351 4011 (Ø 1.9 x 2500 mm)	16 351 6011 (Ø 1.6 x 2000 mm)	16 351 8021 (Ø 3 x 1000 mm)

CONFEZIONE 50 Pz - 50 PCS.PACK

CAVO GAS A NIPPLES THROTTLE CABLE	CAVO GAS A BARILOTTO THROTTLE CABLE	CAVO FRIZIONE CLUTCH CABLE	CAVO CAMBIO SHIFT CABLE	CAVO FRENO POST. REAR BRAKE CABLE
16 351 0019 Conf. 50pz. - 50 Pcs. Pack (Ø 1.2 x 2000 mm) Niplo Piccolo - Small Nipple	16 351 0029 Conf. 50pz. - 50 Pcs. Pack (Ø 1.2 x 2000 mm)	16 351 4019 Conf. 50pz. - 50 Pcs. Pack (Ø 1.9 x 2500 mm)	16 351 6019 Conf. 50pz. - 50 Pcs. Pack (Ø 1.6 x 2000 mm)	16 351 8029 (Ø 3 x 1000 mm)
16 351 4029 Conf. 50pz. - 50 Pcs. Pack (Ø 1.9 x 2000 mm)				



KIT TRASMISSIONI CICLOMOTORI PIAGGIO
TRANSMISSION KIT PIAGGIO MOPED

16 362 0130 

Colore grigio - Gray color

Ciao Sc

Trasmissione gas - *Throttle transmission*

Trasmissione freno anteriore - *Front brake transmission*

Trasmissione freno posteriore - *Rear brake transmission*

Trasmissione freno decompressore - *Decompressor transmission*



16 362 0140 

Colore grigio - Gray color

Ciao Px

Trasmissione gas - *Throttle transmission*

Trasmissione freno anteriore - *Front brake transmission*

Trasmissione freno posteriore - *Rear brake transmission*

Trasmissione freno decompressore - *Decompressor transmission*



16 362 0150 

Colore nero - Black color

Ciao Px

Trasmissione gas - *Throttle transmission*

Trasmissione freno anteriore - *Front brake transmission*

Trasmissione freno posteriore - *Rear brake transmission*

Trasmissione freno decompressore - *Decompressor transmission*



16 362 0160 

Colore nero - Black color

Si - Si FL2

Trasmissione gas - *Throttle transmission*

Trasmissione freno anteriore - *Front brake transmission*

Trasmissione freno posteriore - *Rear brake transmission*

Trasmissione freno decompressore - *Decompressor transmission*



TRASMISSIONI MICROVETTURE - MICROCAR TRANSMISSIONS

CC	MODELLO - MODEL	CONTACHILOMETRI - SPEEDOMETER
-	Ligier Nova	16 363 1750 - (980622)



**MORSETTI
CLAMPS**

12 185 8010 

MORSETTO CON VITE LATERALE
CLAMPS WITH SIDE SCREW
per cavo frizione Ø 1,9
for clutch cable Ø 1,9
Conf. 10 pz. - 10 Pcs Packing



12 185 8020 

MORSETTO CON VITE LATERALE
CLAMPS WITH SIDE SCREW
per cavo frizione Ø 2,5
for clutch cable Ø 2,5
Conf. 10 pz. - 10 Pcs Packing



12 185 8030 

MORSETTO CON VITE LATERALE
CLAMPS WITH SIDE SCREW
per cavo frizione Ø 3
for clutch cable Ø 3
Conf. 10 pz. - 10 Pcs Packing



12 185 8040 

MORSETTO CAVO GAS (tipo magura)
THROTTLE CABLE CLAMPS
Conf. 10 pz. - 10 Pcs Packing



12 185 8050 

MORSETTO CAVO GAS (super pratic)
THROTTLE CABLE CLAMPS
Conf. 10 pz. - 10 Pcs Packing



12 185 8060 

MORSETTO CILINDRICO CAVO GAS
per carburatore Vespa
THROTTLE CABLE CLAMPS
Conf. 10 pz. - 10 Pcs Packing



12 185 8070 

MORSETTO CAVO CAMBIO VESPA
Lunghezza 11 mm
GEAR CABLE CLAMPS 11 MM
Conf. 10 pz. - 10 Pcs Packing
(R.O. 153198)



12 185 8080 

MORSETTO CAVO CAMBIO
Lunghezza 16 mm
GEAR CABLE CLAMPS 16 MM
Ape • TM P703 • P703V Diesel
Car • Max diesel • Poker diesel
MP P501 • P601 78>2001
Conf. 10 pz. - 10 Pcs Packing
(R.O. 153513)



12 185 8120 

MORSETTO REGOLATORE FILO FRENO
FRIZIONE
TERMINAL ADJUSTING SCREW
applicazioni varie
Conf. 5 pz. - 5 Pcs Packing



12 185 8130 

REGISTRO Ø 5 applicazioni varie mm 20
ADJUSTING SCREW
Conf. 10 pz. - 10 Pcs Packing
(R.O. 090527 - 020105)



12 185 8150 

REGISTRO Ø 8 applicazioni varie
ADJUSTING SCREW
Conf. 10 pz. - 10 Pcs Packing



12 185 8170 

BARILOTTO LEVA FRENO AL MANUBRIO
PIVOT PINS FOR BRAKE LEVER
applicazioni varie
Conf. 50 pz. - 50 Pcs Packing





12 185 8180 

CAPOGUAINA PER GUAINA Ø 5,5 x 9,5
CABLE ENDS Ø 5,5 x 9,5
Conf. 50 pz. - 50 Pcs Packing



12 185 8190 

CAPOGUAINA PER GUAINA Ø INTERNO 6 x 10
CABLE ENDS INSIDE Ø 6 x 10
Conf. 50 pz. - 50 Pcs Packing



12 185 8200 

CAPOGUAINA PER GUAINA Ø INTERNO 7 x 11
CABLE ENDS INSIDE Ø 7 x 11
Conf. 50 pz. - 50 Pcs Packing



12 185 8210 

BUSSOLETTA PER GUAINA Ø 4,5
CABLE AND CENTRING BUSHES Ø 4,5
Conf. 200 pz. - 200 Pcs Packing



12 185 8240 

CAPOGUAINA PER GUAINA
Ø 5 x 9,5 mm NICHELATI
NICHEL - PLATED CABLE ENDS Ø 5 x 9,5 mm
Conf. 50 pz. - 50 Pcs Packing



12 186 0323 

KIT SERRACAVO FRENO ANTERIORE
FRONT CABLE PLATE
Vari Modelli Vespa - Various Vespa Models
Conf. 5 pz. - 5 Pcs Packing
(R.O. 177271)



12 186 0343 

NIPPLIO
NIPPLE
Vari Modelli Vespa - Various Vespa Models
Conf. 10 pz. - 10 Pcs Packing
(R.O. 018699)





RINVII CONTACHILOMETRI SPEEDOMETER GEARS

RINVII CONTACHILOMETRI COMPLETI - COMPLETE SPEEDOMETER GEARS

16 369 0110

PIAGGIO 50-100: Zip 2T-4T
(R.O. 56143R)



16 369 0120

PIAGGIO 50-125-150-200-250-300-400-500
(R.O. 56147R)



16 369 0130

PIAGGIO 50-125: Typhoon 2T-4T 10-12
(R.O. 56434R)



MODELLO - MODEL	CC	ANNI YEARS	CODICE RMS RMS CODE	RIF. ORIGINALE ORIGINAL NUMBER
PIAGGIO				
Fly 2T	50	05-07	16 369 0120	56147R
Fly 2T	50	10-11	16 369 0120	56147R
Fly 4T	50	05-07	16 369 0120	56147R
Fly 4T & 25- 30 Km/h	50	08-11	16 369 0120	56147R
Fly 4T 2V	50	13-13	16 369 0140	CM075505
Fly 4T 2V 25- 30Km/h	50	12-14	16 369 0140	CM075505
Fly 4T 4V	50	12-13	16 369 0140	CM075505
Fly 4T Motore Chn	50	06-07	16 369 0120	56147R
Liberty 2T	50	06-08	16 369 0120	56147R
Liberty 2T Rst	50	04-04	16 369 0120	56147R
Liberty 2T Sport	50	06-08	16 369 0120	56147R
Liberty 4T	50	05-08	16 369 0120	56147R
Liberty 4T Delivery-Single	50	10-12	16 369 0120	56147R
Liberty 4T Delivery Tnt	50	09-09	16 369 0120	56147R
Liberty 4T Ptt-Double	50	09-12	16 369 0120	56147R
Liberty 4T Ptt (Deu)	50	07-12	16 369 0120	56147R
Liberty 4T Rst	50	04-04	16 369 0120	56147R
Liberty 4T Sport	50	06-08	16 369 0120	56147R
Liberty Moc 2T & Elle	50	09-13	16 369 0120	56147R
Liberty Moc 4T & Elle	50	09-13	16 369 0120	56147R
Nrg Extreme	50	99-00	16 369 0120	56147R
Nrg Mc3	50	01-04	16 369 0120	56147R
Typhoon 2T Eu2	50	10-12	16 369 0130	56434R
Typhoon 2T Eu3 Ch	50	11-11	16 369 0130	56434R
Zip	50	00-04	16 369 0110	56143R
Zip 2T	50	08-13	16 369 0110	56143R
Zip 4T	50	00-13	16 369 0110	56143R
Fly 4T	100	06-08	16 369 0120	56147R
Zip 4T	100	06-10	16 369 0110	56143R
Beverly Eu3	125	07-08	16 369 0120	56147R
Beverly Eu3 Mic	125	07-07	16 369 0120	56147R
Beverly Eu3 Sport	125	07-08	16 369 0120	56147R
Beverly Rst	125	04-07	16 369 0120	56147R
Beverly Tourer Eu3	125	07-10	16 369 0120	56147R
Carnaby	125	07-10	16 369 0120	56147R
Fly	125	05-07	16 369 0120	56147R
Fly 4T 3V IE E3 Dt	125	13-13	16 369 0140	CM075505
Fly 4T 3V IE Eu3 Lem	125	12-13	16 369 0140	CM075505
Fly Eu3	125	07-07	16 369 0120	56147R
Fly Eu3	125	08-11	16 369 0120	56147R
Liberty 4T	125	06-07	16 369 0120	56147R
Liberty 4T 2V Eu3	125	09-12	16 369 0120	56147R
Liberty 4T 2V IE Ptt	125	12-12	16 369 0120	56147R
Liberty 4T Eu3	125	07-08	16 369 0120	56147R
Liberty 4T Eu3 Delivery	125	07-12	16 369 0120	56147R
Liberty 4T Sport Eu3	125	06-08	16 369 0120	56147R
Liberty Rst	125	04-05	16 369 0120	56147R
Liberty Rst Ptt	125	05-11	16 369 0120	56147R
Liberty Sport	125	06-06	16 369 0120	56147R

16 369 0140

PIAGGIO 50-125: Fly 4T 4V - 3V 12-14
(R.O. CM075505)



MODELLO - MODEL	CC	ANNI YEARS	CODICE RMS RMS CODE	RIF. ORIGINALE ORIGINAL NUMBER
Skipper 4T	125	00-02	16 369 0120	56147R
Skipper Lx	125	98-99	16 369 0120	56147R
Super Hexagon Gtx 12	125	01-02	16 369 0120	56147R
Typhoon 4T 2V Eu3	125	10-11	16 369 0130	56434R
Fly	150	05-07	16 369 0120	56147R
Fly Eu3	150	08-11	16 369 0120	56147R
Liberty 4T Eu3	150	08-08	16 369 0120	56147R
Liberty 4T Sport Eu3	150	08-08	16 369 0120	56147R
Liberty Moc 4T Eu3	150	09-13	16 369 0120	56147R
Carnaby	200	07-08	16 369 0120	56147R
Liberty	200	06-06	16 369 0120	56147R
Liberty 4T Eu3	200	06-08	16 369 0120	56147R
Liberty 4T Sport Eu3	200	06-07	16 369 0120	56147R
Liberty Rst	200	04-04	16 369 0120	56147R
Liberty Sport	200	06-06	16 369 0120	56147R
Beverly	250	06-07	16 369 0120	56147R
Beverly Cruiser	250	07-09	16 369 0120	56147R
Beverly Eu3 Mic	250	07-07	16 369 0120	56147R
Beverly IE Eu3	250	06-08	16 369 0120	56147R
Beverly Rst	250	04-05	16 369 0120	56147R
Beverly Sport	250	06-08	16 369 0120	56147R
Beverly Tourer Eu3	250	08-09	16 369 0120	56147R
Carnaby	250	08-08	16 369 0120	56147R
Beverly Tourer Eu3	300	09-10	16 369 0120	56147R
Carnaby Cruiser	300	09-12	16 369 0120	56147R
Beverly Eu3	400	06-07	16 369 0120	56147R
Beverly Tourer Eu3	400	08-10	16 369 0120	56147R
Beverly	500	02-04	16 369 0120	56147R
Beverly	500	05-06	16 369 0120	56147R
Beverly Cruiser	500	07-12	16 369 0120	56147R
Beverly Eu3	500	06-08	16 369 0120	56147R







PIGNONI RINVIO CONTACHILOMETRI - CAVI GUAINA

SPEEDOMETER PINIONS - CABLES



MODELLO MODEL	CODICE RMS RMS CODE	CODICE A BARRE BARCODE	COD. ORIGINALE ORIGINAL CODE
HONDA: 125-150 Sh	16 369 0100		Per Rinvio 44800KPR900
PIAGGIO: Vespa Px 125-150-200 Vnx, VLX, Vsx	16 369 0030		174048
PIAGGIO: Vespa Pxe 125-150-200 Vnx 2, VLX 2, Vsx 2	16 369 0040		177508
PIAGGIO: Vespa 50-90-125 Primavera, V5a 2T, V5b 1T, V5b 3T, V9a1, Vma 2, Vmb 1	16 369 0050		151614
PIAGGIO: Vespa Pk 50-125 V5x 1T, V5x 2T, V5s 1T, Vmx 1T, Vmx 5t	16 369 0060		217128
PIAGGIO: Vespa 150 Super Vbc 1T	16 369 0070		93535
PIAGGIO: Vespa 150 Sprint VLB-VLB 1T-VLA	16 369 0080		98652
PIAGGIO: Vespa 50-90-125 Primavera-Et3 V5a 1T-V5sa 1T-V5ss-V5b1/2/3-V9a 1T-V9ss-Vma 1T/2T-Vmb 1T	16 369 0090		151615

CAVI MOTO - MOTORCYCLE CABLES

CAVI MOTO TIPO SVEDESI - MOTORCYCLES CABLE SWEDISH TYPE		CAVI CICLOMOTORE MOTO - MOPED AND MOTORCYCLE CABLES WIRE		
GAS - THROTTLE	FRIZIONE - CLUTCH	GAS - THROTTLE	FRIZIONE - CLUTCH	FRENO - BRAKE
 16 351 0081 (cavo int. 1.24 x 2000) Testina Cilindrica Ø 2,73 x 2,96	 16 351 4111 (cavo int. 1.86 x 2200) Barilotto (Ø 7,86 x 7,82)	 16 351 0031 (cavo int. 1.2x1300)	 16 351 4011 (cavo int. 1.9x2000) 16 351 4050 (cavo int. 2.5x2000)	 16 351 8030 (cavo int. 1.9x1800)
	16 351 4121 (cavo int. 1,86 x 220) Nottolino movib.		 16 351 4041 (cavo int. 2.5x1600)	

GUAINA CON SPIRALE IN ACCIAIO TONDO (TIPO ITALIA) - OUTER CABLE ROUND WIRE (ITALIAN TYPE)

CODICE RMS RMS CODE	CODICE A BARRE BARCODE	COLORE COLOUR	MISURA SIZE	FORO INTERNO INSIDE HOLE mm	DIAMETRO ESTERNO OUTSIDE DIAMETER mm	DIAMETRO ESTERNO CON RIVESTIMENTO OUTSIDE HOLE WITH RUBBER mm
16 353 0400		nero - black	50/mtrs roll	2,5	4,5	5,2
16 353 0401		grigio - gray	50/mtrs roll	2,5	4,5	5,2
16 353 0411		grigio millerighe gray grooved	50/mtrs roll	2,5	4,5	5,2
16 353 0500		nero - black	50/mtrs roll	3	5	5,8
16 353 0600		nero - black	25/mtrs roll	3,5	6	7
16 353 0700		nero - black	25/mtrs roll	4,2	7	8



GUAINA A FILO PIATTO CON INSERTO IN PVC - OUTER CABLE FLAT TYPE

16 353 0510		nero - black	50/mtrs roll	2,00/2,10	3,95/4,00	4,91/5,00
-------------	--	--------------	--------------	-----------	-----------	-----------





TUBO COMANDO CAMBIO - GAS PIAGGIO VESPA

PIAGGIO VESPA THROTTLE CONTROL AND GEAR TUBE

18 408 0270



NEW

18 408 0290



18 408 0320



NEW

TUBO COMANDO GAS - THROTTLE CONTROL

PIAGGIO: Vespa 50-90

3/4 Velocità/3/4 Speed

(R.O. 70690)



TUBO COMANDO GAS - THROTTLE CONTROL

PIAGGIO 50: Vespa Rush N • FL 88-90

50-125-150: Vespa Px • Pe • Pk • Pk XL • Rush

• N 95-99

125-150-200: Vespa Px Arcobaleno 84

(R.O. 139778)



TUBO COMANDO GAS - THROTTLE CONTROL

PIAGGIO: Vespa 50-90 >'77

(R.O. 138013)

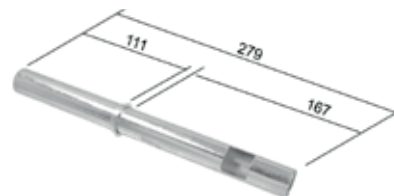

18 408 0690



NEW

18 408 0753



NEW

TUBO COMANDO GAS - THROTTLE CONTROL

PIAGGIO: Vespa 125-150 '64

TUBO COMANDO GAS - THROTTLE CONTROL

PIAGGIO: Vespa 125 T5 Vnx5t

(R.O. 226161))

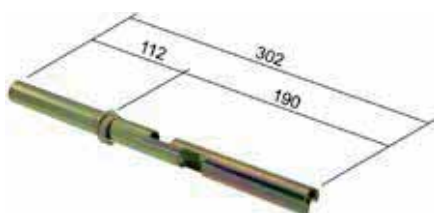

18 404 0320



NEW

18 404 0330



18 404 0370



NEW

TUBO COMANDO CAMBIO - SHIFT CONTROL

PIAGGIO: Vespa 50 SV5sa1t

4 Velocità/4 Speed

(R.O. 138223)

TUBO COMANDO CAMBIO - SHIFT CONTROL

PIAGGIO 50: Vespa Special 4 marce 72

(R.O. 135935)

TUBO COMANDO CAMBIO - SHIFT CONTROL

PIAGGIO: Vespa 50-90 3 VV5A1T/V9A1T

3 Velocità/3 Speed

(R.O. 71063)

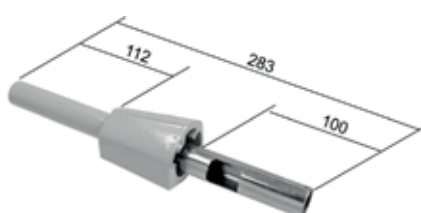
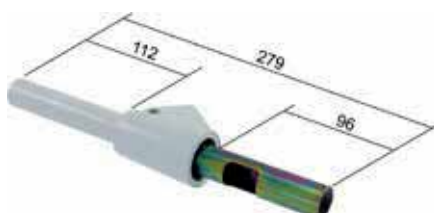

TUBO COMANDO CAMBIO - GAS PIAGGIO VESPA
PIAGGIO VESPA THROTTLE CONTROL AND GEAR TUBE



18 404 0380 

TUBO COMANDO CAMBIO - SHIFT CONTROL
PIAGGIO 150: Vespa GL • Sprint • Gs
 VLA-VLB-VSB1T
 (R.O. 090538)

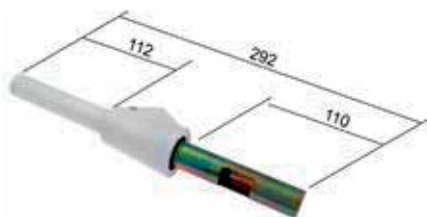

18 404 0390 

TUBO COMANDO CAMBIO - SHIFT CONTROL
PIAGGIO 125: Vespa Px 30 anni 07
125-150-200: Vespa Px Arcobaleno 84
 Freno a disco - *Brake disc*
 (R.O. 219356)



18 404 0400 

NEW

TUBO COMANDO CAMBIO - SHIFT CONTROL
PIAGGIO: Vespa 50-90 V5a1t/V9a1t
 3 Velocità/3 *Speed*
 (R.O. 138011)

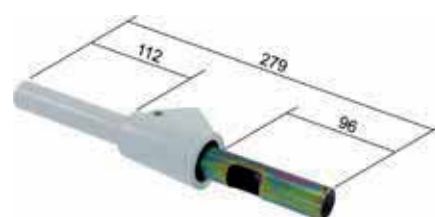

18 404 0700 

NEW

TUBO COMANDO CAMBIO - SHIFT CONTROL
PIAGGIO: Vespa 125 4V
 (R.O. 60555)



18 404 0720 

NEW

TUBO COMANDO CAMBIO - SHIFT CONTROL
PIAGGIO: Vespa 125 Primavera (Vmat2)
 125 Et3 (Vmb1t) • Ts 125 (Vnlbt) • Gtr 125
 (Vnl2t) • Rally 200 (Vse1t) • Sprint (Vlb1t)
 Super 125-150 (Vbc1t)
 (R.O. 137840)
 4 Velocità/4 *Speed*
 (R.O. 138223)

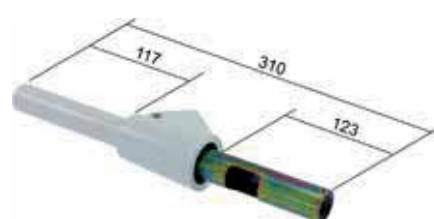

18 404 0610 

PULEGGIA CAMBIO - GEAR PULLEY
PIAGGIO 50-125: Pxe Arcobaleno • Pk
125-150-200: Vespa PX
125: T5
 VNX - VLX - VSX - VNX2 - VLX2 - VSX2
 (R.O. 139796)



18 404 0620 

PULEGGIA GAS - THROTTLE GEAR
PIAGGIO 50-125: Pxe Arcobaleno • Pk
125-150-200: Vespa PX
125: T5
 VNX - VLX - VSX - VNX2 - VLX2 - VSX2
 (R.O. 139797)



18 404 0673 

BUSSOLA CAVO - BUSH
PIAGGIO 125-150-200: Vespa Px • Pxe •
 Arcobaleno
 VNX-VLX-VSX-VNX2-VLX2-VSX2
 (R.O. 133912)



18 404 0683 

BUSSOLA CAVO - BUSH
PIAGGIO 125-150-200: Vespa Px • Pxe
 Arcobaleno
 VNX-VLX-VSX-VNX2-VLX2-VSX2
 (R.O. 133913)





RMS
YOUR BEST PARTNER

▶ SPECCHI RETROVISORI SCOOTER E MOTO

*SCOOTER AND MOTORCYCLE
REAR VIEW MIRRORS*

▶ **RMS**
YOUR BEST PARTNER





SPECCHI RETROVISORI



REAR VIEW MIRRORS

APRILIA



50: Amico • GL • GLE 93-98 • Gulliver aria - Lc 95-98 • Sr • Wwww • Street • Stealth Racing • Liquid Cooled • H2o Ditech e carburatore • Ditech Eu 2 93-11
125: Sr 93-01

 E-MARK	CODICE RMS - RMS CODE	COLORE COLOR	LATO SIDE	PASSO THREAD
	12 277 0080	Nero Black	Destro Right	Foro Passante Passing Hole
				
	R.O. AP 8201975			
	12 276 0080			
				
R.O. AP 8201976	Sinistro Left			



50: RS 96-10 • 125: RS 98-10 • 250: RS 98-03 • 1000: Rsv 00-03 • SL Falco 00-03

 E-MARK NEW	CODICE RMS - RMS CODE	COLORE COLOR	LATO SIDE	PASSO THREAD
	12 277 0120	Nero Black	Destro Right	2 Fori passanti 2 Passing holes
				
	R.O. AP8102632			
	12 276 0120			
				
R.O. AP8102633	Sinistro Left			





50: Mojito retrò 99-03 • Mx 04 • Rally 96-99 • Rx 95-06 • Scarabeo 93-14 • Sonic 98-08 • 100: Scarabeo 4T 01-14 • Scarabeo Motori Minarelli 00 • Scarabeo Motori Yamaha 00 • 125: Mojito retrò 99-01 • Mojito 03-07 • Mx 04-06 • Rx 94-10 • Sx 08-10

 E-MARK	CODICE RMS - RMS CODE	COLORE COLOR	LATO SIDE	PASSO THREAD
	12 276 0130	Nero Black	Destro Right Sinistro Left	Perno Cilindrico 10 mm Pin Cylindrical 10 mm
				
	12 276 0160			
				
R.O. AP8201984				

50: Sr R 04-14

 E-MARK	CODICE RMS - RMS CODE	COLORE COLOR	LATO SIDE	PASSO THREAD
	12 277 0320	Nero Black	Destro Right	2 Fori passanti 6 mm 2 Passing holes 6 mm
				
	R.O. AP8202394			
	12 276 0320			
				
R.O. AP8202395	Sinistro Left			



50: Mojito Custom 99-10 • 125: Mojito 03-08 • Mojito retrò Custom 99-01

 E-MARK	CODICE RMS - RMS CODE	COLORE COLOR	LATO SIDE	PASSO THREAD
	12 277 0870	Cromato Chromed	Destro Right	10 x 1,25 
				
	R.O. AP8202166			
	12 276 0870			
				
R.O. AP8202170	Sinistro Left	10 X 1,25 		





APRILIA



50-125: Tuono 03-04 • **660:** Pegaso - Strada (Fun) - Factory - Trail 05-09 • **1000:** Rsv R Tuono 02-05

 <p>E-MARK NEW</p>	CODICE RMS - RMS CODE	COLORE COLOR	LATO SIDE	PASSO THREAD
	12 277 1230	Nero Black	Destro Right Sinistro Left	10 x 1,25 
	 R.O. AP8104566			





50: Scarabeo 2T 14 • Scarabeo 4T 4V 14

 <p>E-MARK</p>	CODICE RMS - RMS CODE	COLORE COLOR	LATO SIDE	PASSO THREAD
	12 277 2240	Nero Black	Destro Right	Perno Cilindrico 10 mm Pin Cylindrical 10 mm
	 R.O. CM260002			
	12 276 2240		Sinistro Left	
				
R.O. CM260001				





50: Scarabeo 2T 14 • Scarabeo 4T 4V 14

 <p>E-MARK</p>	CODICE RMS - RMS CODE	COLORE COLOR	LATO SIDE	PASSO THREAD
	12 277 2360	Cromato Chromed	Destro Right	Perno Cilindrico 10 mm Pin Cylindrical 10 mm
	 R.O. CM260002			
	12 276 2360		Sinistro Left	
				
R.O. CM260001				

125: Scarabeo Rotax 99-04

 <p>E-MARK</p>	CODICE RMS - RMS CODE	COLORE COLOR	LATO SIDE	PASSO THREAD
	12 277 0090	Cromato Chromed	Destro Right	10 x 1,25 
	 R.O. AP8102835			
	12 276 0090		Sinistro Left	10 x 1,25 
				
R.O. AP8102836				

125: Sport City Cube 08-10 • Sport City Eu3 06-08 • Sport City Street 12 • Sport City 04-06 • **250:** Sport City Cube 08-12 • **300:** Sport City Street 12

 <p>E-MARK</p>	CODICE RMS - RMS CODE	COLORE COLOR	LATO SIDE	PASSO THREAD
	12 277 0200	Nero Black	Destro Right	8 x 1,25 
	 R.O. CM180902			
	12 276 0200		Sinistro Left	8 X 1,25 
				
R.O. CM180901				







SPECCHI RETROVISORI





REAR VIEW MIRRORS

APRILIA





125: Scarabeo Light 07-10 • Scarabeo Piaggio Eu3 06 • 250: Scarabeo Light 06-08 • 300: Scarabeo Light 09-10 • 400: Scarabeo Light 06-08 • 500: Scarabeo Light 06-08 • Scarabeo 03-06

 E-MARK	CODICE RMS - RMS CODE		COLORE COLOR	LATO SIDE	PASSO THREAD
	12 277 0230		Nero Black	Destro Right	10 x 1,25 
					
	R.O. AP8104526				
	12 276 0230			Sinistro Left	10 x 1,25 
					
R.O. AP8104527					



125: Scarabeo Piaggio Eu3 06 • Scarabeo Rotax 99-04 • Scarabeo 03-06 • 250: Scarabeo Light 06-08 • 400: Scarabeo Light 06-08 • 500: Scarabeo Light 06-08

 E-MARK	CODICE RMS - RMS CODE		COLORE COLOR	LATO SIDE	PASSO THREAD
	12 277 0260		Nero Black	Destro Right	10 x 1,25 
					
	R.O. AP8104518				
	12 276 0260			Sinistro Left	10 x 1,25 
					
R.O. AP8104519					



125: Scarabeo 99-06

 E-MARK	CODICE RMS - RMS CODE		COLORE COLOR	LATO SIDE	PASSO THREAD
	12 277 0290		Nero Black	Destro Right	10 X 1,25 
					
	R.O. AP8104491				
	12 276 0290			Sinistro Left	10 X 1,25 
					
R.O. AP8104492					

125: Leonardo 99-04 • 250: Leonardo 99-04

 E-MARK	CODICE RMS - RMS CODE		COLORE COLOR	LATO SIDE	PASSO THREAD
	12 277 0300		Nero Black	Destro Right	Foro passante Passing hole
					
	R.O. AP8102866-AP8104864				
	12 276 0300			Sinistro Left	
					
R.O. AP8102867-AP8104865					

125: Sr Max 11-14 • 300: Sr Max 11-14

 E-MARK	CODICE RMS - RMS CODE		COLORE COLOR	LATO SIDE	PASSO THREAD
	12 277 0650		Nero Black	Destro Right	Perno Cilindrico 10 mm Pin Cylindrical 10 mm
					
	R.O. CM175006				
	12 276 0650			Sinistro Left	
					
R.O. CM175005					

- Filetto sinistro - *Left Thread*
- Filetto destro - *Right Thread*



SPECCHI RETROVISORI

REAR VIEW MIRRORS





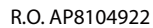
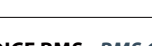

APRILIA

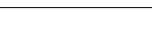

450-550: Rxv 06-11 • Sxv 06-11 • **660:** Pegaso Strada (Fun) - Factory Trail 05-09 • **750:** Dorsoduro 08-16 • Shiver 07-16 • Shiver Gt 07-09
850: Mana 07-11 • Mana Gt 09-16

	E-MARK	CODICE RMS - RMS CODE	COLORE <i>Black</i>	LATO <i>Right</i>	PASSO <i>Thread</i>
	NEW	12 277 1540			
		R.O. AP8104921			
	12 276 1540				
	R.O. AP8104922				
	R.O. AP8104922				



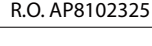
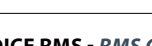

500: Atlantic 01-04

 <p style="text-align: center; font-size: small;">snodo 360° - Junction 360°</p>	E-MARK	CODICE RMS - RMS CODE	COLORE <i>Black</i>	LATO <i>Right</i>	PASSO <i>Thread</i>
	12 277 0240				
	R.O. AP8104453	12 276 0240			
		R.O. AP8104454			
	R.O. AP8104454				
	R.O. AP8104454				

650: Pegaso 3 97-00 • Pegaso le 01-04 • Pegaso 92-96

	E-MARK	CODICE RMS - RMS CODE	COLORE <i>Black</i>	LATO <i>Right</i>	PASSO <i>Thread</i>
	NEW	12 277 2020			
		R.O. AP8102324			
	12 276 2020				
	R.O. AP8102325				
	R.O. AP8102325				

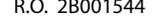
1000: Rsv4 Racing Factory Le 15-16 • Rsv4 Rr Racer Pack 15 • Rsv4 Rr 15

	E-MARK	CODICE RMS - RMS CODE	COLORE <i>Black</i>	LATO <i>Right</i>	PASSO <i>Thread</i>
	NEW	12 277 2350			
		R.O. 2B001543			
	12 276 2350				
	R.O. 2B001544				
	R.O. 2B001544				



SPECCHI RETROVISORI

REAR VIEW MIRRORS

BMW

650: F 650 Gs 08> • G 650 Gs 11> • G 650 X Challenge 09> • **800:** F 800 Gs 08> • F 800 R 08> • **1200:** R 1200 Gs 11-13 • R 1200 Gs Adv 11-13

E-MARK 	CODICE RMS - RMS CODE		COLORE COLOR	LATO SIDE	PASSO THREAD
	12 277 1330				
	R.O. 51-167-715-864				
	12 276 1330				
R.O. 51-167-715-863					
		Nero Black	Destro Right	10 x 1,25 	
			Sinistro Left	10 x 1,25 	

750: K75 83-88 • K75 C 85-91 • **800:** R80 80-92 • R80 Gs 85-95 • R80 R 91-94 • **1000:** K100 83-88 • K100 Gs 76-84 • K100 R 91-94

E-MARK 	CODICE RMS - RMS CODE		COLORE COLOR	LATO SIDE	PASSO THREAD
	12 277 1280				
R.O. 51-161-451-523		Nero Black	Destro Right Sinistro Left	8 x 1,25 	

800: F800 S 01-10

E-MARK 	CODICE RMS - RMS CODE		COLORE COLOR	LATO SIDE	PASSO THREAD
	12 277 1880				
	R.O. 51-16-7-714-112 51-16-8-528				
	12 276 1880				
R.O. 51-16-7-714-111 51-16-8-528		Nero Black	Destro Right Sinistro Left	2Fori passanti 6 mm Passing holes 6 mm	

1000: S 1000 Rr 09>

E-MARK 	CODICE RMS - RMS CODE		COLORE COLOR	LATO SIDE	PASSO THREAD
	12 277 2370				
	R.O. 51-16-7-718-514				
	12 276 2370				
R.O. 51-16-7-718-513		Nero Black	Destro Right Sinistro Left	2 Pemi 6 mm 2 Pins 6 mm	

1200: R 1200 Gs 02> • R 1200 Gs Adv 05> • R 1200 R 05>

E-MARK 	CODICE RMS - RMS CODE		COLORE COLOR	LATO SIDE	PASSO THREAD
	12 277 1320				
R.O. 51-167-697-241 R.O. 51-167-699-791		Nero Black	Destro Right Sinistro Left	Perno Cilindrico 10 mm Pin Cylindrical 10 mm	

- Filetto sinistro - *Left Thread*
- Filetto destro - *Right Thread*

SPECCHI RETROVISORI

REAR VIEW MIRRORS



BMW

1200: K 1200 R 09> • K 1200 R 07> • **1300:** K 1300 R 08>

E-MARK 	CODICE RMS - RMS CODE	COLORE COLOR	LATO SIDE	PASSO THREAD
	12 277 1350	Nero <i>Black</i>	Destro <i>Right</i> Sinistro <i>Left</i>	10 x 1,25
R.O. 51-16-7-685-505				

1200: R 1200

E-MARK 	CODICE RMS - RMS CODE	COLORE COLOR	LATO SIDE	PASSO THREAD
	12 277 1870	Nero <i>Black</i>	Destro <i>Right</i>	Perno Cilindrico 10 mm <i>Pin Cylindrical 10 mm</i>
	R.O. 51-16-7-688-655		Sinistro <i>Left</i>	
	12 276 1870			
R.O. 51-16-7-688-656				

1200: K 1200 R 09-07

E-MARK 	CODICE RMS - RMS CODE	COLORE COLOR	LATO SIDE	PASSO THREAD
	12 277 2200	Nero <i>Black</i>	Destro <i>Right</i>	Perno Cilindrico 10 mm <i>Pin Cylindrical 10 mm</i>
R.O. 71-60-7-699-091				

1200: R 1200 R 09 • **1300:** K 1300 R

E-MARK 	CODICE RMS - RMS CODE	COLORE COLOR	LATO SIDE	PASSO THREAD
	12 277 2220	Cromato <i>Chromed</i>	Destro <i>Right</i>	Perno Cilindrico 10 mm <i>Pin Cylindrical 10 mm</i>
R.O. 51-16-7-686-618				

1200: R 1200 Rs 14>

E-MARK 	CODICE RMS - RMS CODE	COLORE COLOR	LATO SIDE	PASSO THREAD
	12 277 2380	Nero <i>Black</i>	Destro <i>Right</i>	3 Fori 6 mm <i>3 Holes 6 mm</i>
	R.O. 51-16-8-556-084		Sinistro <i>Left</i>	
	12 276 2380			
R.O. 51-16-8-556-083				





SPECCHI RETROVISORI



REAR VIEW MIRRORS

DERBI

50: Boulevard 09-14 • 100: Boulevard 4T 10-11 • 125: Boulevard 4T Eu3 08-12 • 150: Boulevard 4T Eu3 10



	CODICE RMS - RMS CODE		COLORE COLOR	LATO SIDE	PASSO THREAD
	12 277 0530				
					
	R.O. CM027002				
	12 276 0530				
					
R.O. CM027001					

125: Sonar 4T 09-11 • 150: Sonar 4T 09

	CODICE RMS - RMS CODE		COLORE COLOR	LATO SIDE	PASSO THREAD
	12 277 0830				
					
	R.O. CM020408				
	12 276 0830				
					
R.O. CM020407					

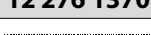

DUCATI

400: Monster Dark Jap 05 • Monster Dark 05 • Monster 04-08 • 620: Monster Dark Single Disc 05 • Monster Dark Usa 05-06 • Monster Dark 05-06 • Monster Usa 05-06 • Monster 04-06 • 695: Monster Usa 07-08 • Monster 07-08 • 800: Monster 04 • Monster S2R Dark Usa 05-06 • Monster S2R Dark 05-06 • Monster S2R Usa 05-07 • Monster S2R 05-07 • 996: Monster S4R Usa 05-06 • Monster S4R 03-06 • 1000: Monster S Usa 05 • Monster S 05 • Monster Usa 05 • Monster 04-05 • Monster S2R Usa 06-08 • Monster S2R 06-08 • Monster S4R Usa 07-08 • Monster S4R 07-08 • Monster S4rs Tricolore Usa 08 • Monster S4rs Tricolore 08 • Monster S4rs Usa 06-08 • Monster S4rs 06-08

	CODICE RMS - RMS CODE		COLORE COLOR	LATO SIDE	PASSO THREAD
	12 277 1370				
					
	R.O. 52340143A				
	12 276 1370				
					
R.O. 52340153A					

660: Monster 659 Abs Australia 12 • Monster 659 Australia 12 • 700: Monster 696 Abs Usa 10-12 • Monster 696 Abs 10-12 • Monster 696 Usa 08-12 • Monster 696 08-12 • 800: Monster 795 Thai 12 • Monster 795 12 • Monster 796 Abs Usa 11-12 • Monster 796 Abs 11-12 • Monster 796 Usa 11-12 • Monster 796 11-12 • 821: Hypermotard Bra 14 • Hypermotard Hyperstrada Bra 14 • Hypermotard Hyperstrada Usa 13-14 • Hypermotard Hyperstrada 13-14 • Hypermotard Sp Usa 13-14 • Hypermotard Sp 13-14 • Hypermotard Usa 13-14 • Hypermotard13-14





848: Streetfighter 848 Usa 12-14 • Streetfighter 848 12-14 • 1098: Streetfighter S Usa 13 • Streetfighter S 13 • 1100: Monster Abs Usa 10 • Monster Abs 10 • Monster Evo Abs Usa 12 • Monster Evo Abs 12 • Monster S Abs Usa 10 • Monster S Abs 10 • Monster S Usa 09-10 • Monster S 09-10 • Monster Usa 09-10 • Monster 09-10 • Streetfighter S Usa 10-12 • Streetfighter S 10-12 • Streetfighter Usa • Streetfighter10-11

	CODICE RMS - RMS CODE		COLORE COLOR	LATO SIDE	PASSO THREAD
	12 277 1380				
					
	R.O. 52340222A				
	12 276 1380				
					
R.O. 52340232A					





DUCATI



800: Scrambler 15-16 (Tutti i modelli - *All Version*)

 E-MARK	CODICE RMS - <i>RMS CODE</i>		COLORE COLOR	LATO SIDE	PASSO THREAD
	12 277 2400		Nero Black	Destro Right	10 x 1,25 
					
	R.O. 52310491B				
	12 276 2400			Sinistro Left	
					
R.O. 52310481B					



821: Monster 15-16 • **1200:** Monster S 15

 E-MARK	CODICE RMS - <i>RMS CODE</i>		COLORE COLOR	LATO SIDE	PASSO THREAD
	12 277 2390		Nero-Grigio Grey-Black	Destro Right	Foro Passante 8 mm Passing Hole 8 mm
					
	R.O. 52310442A				
	12 276 2390			Sinistro Left	
					
R.O. 52310452A					



899: Panigale Abs 14-15 • **1199:** Panigale S, R 12-15

 E-MARK	CODICE RMS - <i>RMS CODE</i>		COLORE COLOR	LATO SIDE	PASSO THREAD
	12 277 2420		Nero Black	Destro Right	2 Fori 6 mm 2 Holes 6 mm
					
	R.O. 523S0281A - 523S0282B 523S0283B				
	12 276 2420			Sinistro Left	
					
R.O. 523S0291A - 523S0292B 523S0293B					

1200: Multistrada 10-14

 E-MARK	CODICE RMS - <i>RMS CODE</i>		COLORE COLOR	LATO SIDE	PASSO THREAD
	12 277 1900		Nero Black	Destro Right	Foro passante 8 mm Passing Hole 8 mm
					
	R.O. 52310351A				
	12 276 1900			Sinistro Left	
					
R.O. 52310341A					

1200: Multistrada S 15-16 • Multistrada Abs 15-16 • Multistrada S Abs 15-16 • Multistrada Touring 15-16 • Multistrada S Touring 15-16

 E-MARK	CODICE RMS - <i>RMS CODE</i>		COLORE COLOR	LATO SIDE	PASSO THREAD
	12 277 2410		Nero Black	Destro Right	Foro 10 mm Hole 10 mm
					
	R.O. 52310462A				
	12 276 2410			Sinistro Left	
					
R.O. 52310472A					



SPECCHI RETROVISORI
REAR VIEW MIRRORS

GENERIC

50: Ideo 50

E-MARK	CODICE RMS - RMS CODE		COLORE COLOR	LATO SIDE	PASSO THREAD
		12 277 1590			
12 276 1590			Sinistro Left	8 x 1,25 	

GILERA

50: Storm 94-95 • Typhoon 94-97 • 125: Typhoon 95-00

E-MARK	CODICE RMS - RMS CODE		COLORE COLOR	LATO SIDE	PASSO THREAD
		12 277 0060			
		R.O. 271018			
12 276 0060			Sinistro Left	8 x 1,25 	
		R.O. 271022			

50: Runner 97-00 • Runner Sp 02-04 • Runner Purejet 02-04 • Runner Poggiali 02 • 125-180: Fx • Fxr 97-02 • Vx • Vxr 00-01 • 125-200: Vx • Vxr 02-04

E-MARK	CODICE RMS - RMS CODE		COLORE COLOR	LATO SIDE	PASSO THREAD
		12 277 0330			
		R.O. CM068002			
12 276 0330			Sinistro Left	8 x 1,25 	
		R.O. CM068001			

50: Stalker Naked 08 • 500: Fuoco 07-13

E-MARK	CODICE RMS - RMS CODE		COLORE COLOR	LATO SIDE	PASSO THREAD
		12 277 0630			
		R.O. CM175007			
12 276 0630			Sinistro Left	10 x 1,25 	
		R.O. CM175008			

- Filetto sinistro - *Left Thread*
- Filetto destro - *Right Thread*

SPECCHI RETROVISORI REAR VIEW MIRRORS



GILERA

50: Stalker 97-11 • Stalker Spec Ed. 07-08

	CODICE RMS - RMS CODE	COLORE COLOR	LATO SIDE	PASSO THREAD
	12 277 0730			
	R.O. 561168			
	12 276 0730			
	R.O. 560897	Nero <i>Black</i>	Destro <i>Right</i>	10x1,25
			Sinistro <i>Left</i>	10x1,25

50: Runner 08-09 • **125:** Runner 4T St 08-13 • Runner Vxr 4T St 08-11

	CODICE RMS - RMS CODE	COLORE COLOR	LATO SIDE	PASSO THREAD
	12 277 0750			
	R.O. CM175017			
	12 276 0750			
	R.O. CM175016	Nero <i>Black</i>	Destro <i>Right</i>	Perno Cilindrico 10 mm <i>Pin Cylindrical 10 mm</i>
			Sinistro <i>Left</i>	

50: Ice 01-05

	CODICE RMS - RMS CODE	COLORE COLOR	LATO SIDE	PASSO THREAD
	12 277 0940			
	R.O. CM066001			
	12 276 0940			
	R.O. CM066002	Nero <i>Black</i>	Destro <i>Right</i>	10 x 1,25
			Sinistro <i>Left</i>	10 x 1,25

50: Dna 00-02 • Dna Gp Experience 03-04 • Dna 05-07 • **125-180:** Dna 01

	CODICE RMS - RMS CODE	COLORE COLOR	LATO SIDE	PASSO THREAD
	12 276 0980			
	R.O. 583111			
		Nero <i>Black</i>	Destro <i>Right</i> Sinistro <i>Left</i>	10 X 1,25

125-250: Nexus Eu 3 07-08



	CODICE RMS - RMS CODE	COLORE COLOR	LATO SIDE	PASSO THREAD
	12 277 0640			
	R.O. CM175003			
	12 276 0640			
	R.O. CM175002	Nero <i>Black</i>	Destro <i>Right</i>	10x1,25
			Sinistro <i>Left</i>	10x1,25





SPECCHI RETROVISORI REAR VIEW MIRRORS

GILERA

125: Nexus Eu 3 le 08-10 • 300-500: Nexus Eu 3 08-11



 E-MARK	CODICE RMS - RMS CODE		COLORE COLOR	LATO SIDE	PASSO THREAD
	12 277 0650				
					
	R.O. CM175006				
	12 276 0650				
					
R.O. CM175005					

50: Runner 05-11 • Runner Sp 05-12 • Storm 07 • 125: Runner 4T St 08-13 • Runner Vx 05-07 • Runner Vxr 05-11



 E-MARK	CODICE RMS - RMS CODE		COLORE COLOR	LATO SIDE	PASSO THREAD
	12 277 0420				
					
	R.O. CM073002				
	12 276 0420				
					
R.O. CM073001					

HONDA



110: Vision

 E-MARK	CODICE RMS - RMS CODE		COLORE COLOR	LATO SIDE	PASSO THREAD
	12 277 1050				
					
	R.O. 82210-GFM-B20				
	12 276 1050				
					
R.O. 82220-GFM-B20					

125-150: Sh >12

 E-MARK	CODICE RMS - RMS CODE		COLORE COLOR	LATO SIDE	PASSO THREAD
	12 277 0030				
					
	R.O. 88210KPR900				
	12 276 0030				
					
R.O. 88220KPR900					





HONDA 125-150: Sh 09-12 • 300: Sh 07-16

 E-MARK NEW	CODICE RMS - RMS CODE		COLORE COLOR	LATO SIDE	PASSO THREAD
	12 277 0030				
					
	R.O. 88210-KPR-900				
	12 276 2720				
					
R.O. 88220-KTW-900					







HONDA



125-150: Pcx

 E-MARK	CODICE RMS - RMS CODE		COLORE COLOR	LATO SIDE	PASSO THREAD
	12 277 1060				
					
	R.O. 88210-KWN-900				
	12 276 1060				
					
R.O. 88220-KWN-900					
		Nero Black	Destro Right	10 x 1,25 	
			Sinistro Left	10 x 1,25 	





125-150: Sh 13>

 E-MARK	CODICE RMS - RMS CODE		COLORE COLOR	LATO SIDE	PASSO THREAD
	12 277 1130				
					
	R.O. 88210-K01-D01				
	12 276 1130				
					
R.O. 88220-K01-D01					
		Nero Black	Destro Right	8 x 1,25 	
			Sinistro Left	8 x 1,25 	





125: Varadero 01-06 • Xr 07 • 250: Ftr • Xr 87-99 • Xr R 86-06 • 400: Xr R 96-06 • 600: XL R 94-97 • 650: Nx Dominator 93-99
Transalp 07 • 750: XL V

 E-MARK	CODICE RMS - RMS CODE		COLORE COLOR	LATO SIDE	PASSO THREAD
	12 277 1340				
					
	R.O. 88110-KW4-600				
		Nero Black	Destro Right Sinistro Left	10 x 1,25 	

125: Shadow • 250: Hornet • Vtr 03 • Jazz 04 • 400: Cb Sf • 500: Cbf 04 • 600: Cb F 03-06 • Cbf F Hornet 03-06 • Cbf N • 750 Cb • 1300: Cb Sf

 E-MARK	CODICE RMS - RMS CODE		COLORE COLOR	LATO SIDE	PASSO THREAD
	12 277 1500				
					
	R.O. 88210-MBZ-K00				
	12 276 1500				
					
R.O. 88220-MBZ-K00					
		Cromato Chromed	Destro Right	10 x 1,25 	
			Sinistro Left	10 x 1,25 	

125: Sh Mode 13-14



 E-MARK	CODICE RMS - RMS CODE		COLORE COLOR	LATO SIDE	PASSO THREAD
	12 277 1550				
					
	R.O. 88210-K29-901				
	12 276 1550				
					
R.O. 88220-K29-901					
		Nero Black	Destro Right	M8 	
			Sinistro Left	M8 	





SPECCHI RETROVISORI
REAR VIEW MIRRORS

HONDA



125: Cb F 09>

E-MARK 	CODICE RMS - RMS CODE		COLORE COLOR	LATO SIDE	PASSO THREAD
	12 277 2270				
					
	R.O. 88110-KWF-951				
	12 276 2270				
					
R.O. 88120-KWF-951					



125: Cb F 15

E-MARK 	CODICE RMS - RMS CODE		COLORE COLOR	LATO SIDE	PASSO THREAD
	12 277 2590				
					
	R.O. 88210-KPN-A71				
	12 276 2590				
					
R.O. 88220-KPN-A71					



250: Xr R 96-06 • 400: Xr R/Sm 96-06 • 600: Transalp XL V 87-96 • Xr R 85-00 • 650: Africa Twin 88-89 • Dominator 88-92 • 750: Africa Twin 90-92

E-MARK 	CODICE RMS - RMS CODE		COLORE COLOR	LATO SIDE	PASSO THREAD
	12 277 1400				
					
	R.O. 88110-MN9-003				

250: Cbr R 14-16 • 300: Cbr R 15-16

E-MARK 	CODICE RMS - RMS CODE		COLORE COLOR	LATO SIDE	PASSO THREAD
	12 277 2430				
					
	R.O. 88110-K33-D01				
	12 276 2430				
					
R.O. 88120-K33-D01					

300: Forza 13>

E-MARK 	CODICE RMS - RMS CODE		COLORE COLOR	LATO SIDE	PASSO THREAD
	12 277 1190				
					
	R.O. 88210-K04-930				
	12 276 1190				
					
R.O. 88220-K04-930					

- Filetto sinistro - *Left Thread*
- Filetto destro - *Right Thread*

SPECCHI RETROVISORI

REAR VIEW MIRRORS



HONDA

400: Silverwing 02-05 • **600:** Cb F Hornet • Abs 07-10 • Silverwing 03-09

E-MARK	CODICE RMS - RMS CODE	COLORE COLOR	LATO SIDE	PASSO THREAD
	12 277 0280	Nero <i>Black</i>	Destro <i>Right</i>	Con adattatore <i>With adaptor</i> 10 x 1,25
	R.O. 88210-MCT-013 88110-MFG-D00			
	12 276 0280			
	R.O. 88220-MCT-013 88120-MFG-D00			
			Sinistro <i>Left</i>	Con adattatore <i>With adaptor</i> 10 x 1,25

500: Cb S 98-02

E-MARK	CODICE RMS - RMS CODE	COLORE COLOR	LATO SIDE	PASSO THREAD
	12 277 1930	Cromato <i>Chromed</i>	Destro <i>Right</i>	10 x 1,25
	R.O. 88210-MY5-F10			
	12 276 1930			
	R.O. 88220-MY5-F10			
			Sinistro <i>Left</i>	10 x 1,25

500: Cbr R 13-15

E-MARK	CODICE RMS - RMS CODE	COLORE COLOR	LATO SIDE	PASSO THREAD
	12 277 2460	Nero <i>Black</i>	Destro <i>Right</i>	2 Fori 6 mm <i>2 Holes 6 mm</i>
	R.O. 88110-MGZ-J01			
	12 276 2460			
	R.O. 88120-MGZ-J01			
			Sinistro <i>Left</i>	

600: Cbr F 06 • Cb F Hornet S 02 • **1000:** Vtr Sp1

E-MARK	CODICE RMS - RMS CODE	COLORE COLOR	LATO SIDE	PASSO THREAD
	12 277 1250	Nero <i>Black</i>	Destro <i>Right</i>	2 Fori M6 <i>2 Holes M6</i>
	R.O. 88110-MBW-003			
	12 276 1250			
	R.O. 88120-MBW-003			
			Sinistro <i>Left</i>	

600: Cbr RR 07-13 • Cbr F/FA 11 • **1000:** Cbr RR 04-07



E-MARK	CODICE RMS - RMS CODE	COLORE COLOR	LATO SIDE	PASSO THREAD
	12 277 1310	Nero <i>Black</i>	Destro <i>Right</i>	2 Fori M6 <i>2 Holes M6</i>
	R.O. 88110-MEL-003/013			
	12 276 1310			
	R.O. 88120-MEL-003/013			
			Sinistro <i>Left</i>	





SPECCHI RETROVISORI
REAR VIEW MIRRORS

HONDA



600: Cbf S 04-05

 E-MARK	CODICE RMS - RMS CODE		COLORE COLOR	LATO SIDE	PASSO THREAD
	12 277 2040				
					
	R.O. 88110-MER-D00				
	12 276 2040				
					
R.O. 88120-MER-D00					



600: Cbf S 08-10 • **1000:** Cbf Sf 07-11

 E-MARK	CODICE RMS - RMS CODE		COLORE COLOR	LATO SIDE	PASSO THREAD
	12 277 2170				
					
	R.O. 88110-MER-R01				
	12 276 2170				
					
R.O. 88120-MER-R01					



650: Cb Fa 14>

 E-MARK	CODICE RMS - RMS CODE		COLORE COLOR	LATO SIDE	PASSO THREAD
	12 277 2440				
					
	R.O. 88210-MJE-D40				
	12 276 2440				
					
R.O. 88220-MJE-D40					

650: Cbr F 14>

 E-MARK	CODICE RMS - RMS CODE		COLORE COLOR	LATO SIDE	PASSO THREAD
	12 277 2450				
					
	R.O. 88110-MJE-D01				
	12 276 2450				
					
R.O. 88120-MJE-D01					

700: Nc Integra 11-13 • **750:** Nc Integra 14

 E-MARK	CODICE RMS - RMS CODE		COLORE COLOR	LATO SIDE	PASSO THREAD
	12 277 1100				
					
	R.O. 88210-MGS-D30				
	12 276 1100				
					
R.O. 88220-MGS-D30					



HONDA

700: Deauville 10-11 • Nt V 06-08

E-MARK 	CODICE RMS - RMS CODE		COLORE COLOR	LATO SIDE	PASSO THREAD
	12 277 2180		Nero Black	Destro Right	2 Fori passanti 6 mm 2 Passing holes 6 mm
	R.O. 88110-MEW-921				
	12 276 2180				
R.O. 88120-MEW-921		Sinistro Left			

750: Africa Twin Xrv 93-02 • **1000:** Varadero XLV 99-10

E-MARK 	CODICE RMS - RMS CODE		COLORE COLOR	LATO SIDE	PASSO THREAD
	12 277 1390		Nero Black	Destro Right	10 x 1,25
	R.O. 88210-MY1-003				
	12 276 1390				
R.O. 88220-MY1-003		Sinistro Left		10 x 1,25 	

750: Vt S 10 • Vt Sb 11 • **1300:** Vt Csa 11

E-MARK 	CODICE RMS - RMS CODE		COLORE COLOR	LATO SIDE	PASSO THREAD
	12 277 2080		Cromato Chromed	Destro Right	10 x 1,25
	R.O. 88210-MGR-641				
	12 276 2080				
R.O. 88220-MGR-641		Sinistro Left		10 x 1,25 	

800: Vfr 02-09

E-MARK 	CODICE RMS - RMS CODE		COLORE COLOR	LATO SIDE	PASSO THREAD
	12 277 1940		Nero Black	Destro Right	2 Fori passanti 6 mm 2 Passing holes 6 mm
	R.O. 88110-MCW-D01				
	12 276 1940				
R.O. 88120-MCW-D01		Sinistro Left			

800: Vfr 00-01



E-MARK 	CODICE RMS - RMS CODE		COLORE COLOR	LATO SIDE	PASSO THREAD
	12 277 2120		Nero Black	Destro Right	2 Fori passanti 6 mm 2 Passing holes 6 mm
	R.O. 88110-MBG-D01				
	12 276 2120				
R.O. 88120-MBG-D01		Sinistro Left			





SPECCHI RETROVISORI
REAR VIEW MIRRORS

HONDA





900: Cbr R 00-01

E-MARK 	CODICE RMS - RMS CODE		COLORE COLOR	LATO SIDE	PASSO THREAD
	12 277 2140				
					
	R.O. 88110-MCJ-003				
	12 276 2140				
					
R.O. 88120-MCJ-003					
			Nero Black	Destro Right	2 Fori passanti 6 mm 2 Passing holes 6 mm
				Sinistro Left	

1000: Cbr Rr 08-13



E-MARK 	CODICE RMS - RMS CODE		COLORE COLOR	LATO SIDE	PASSO THREAD
	12 277 1810				
					
	R.O. 88110-MFL-003				
	12 276 1810				
					
R.O. 88120-MFL-003					
			Nero Black	Destro Right	2 Fori passanti 6 mm 2 Passing holes 6 mm
				Sinistro Left	

1200: Vfr X Crosstourer 13-14

E-MARK 	CODICE RMS - RMS CODE		COLORE COLOR	LATO SIDE	PASSO THREAD
	12 277 1410				
					
	R.O. 88210-MGH-640				
	12 276 1410				
					
R.O. 88220-MGH-640					
			Nero Black	Destro Right	12 x 1,25 
				Sinistro Left	12 x 1,25 

HUSQVARNA



125: Wre - Sm S 00-08

E-MARK 	CODICE RMS - RMS CODE		COLORE COLOR	LATO SIDE	PASSO THREAD
	12 277 2210				
					
R.O. 8000-58378			Nero Black	Destro Right	10 x 1,25 





KAWASAKI





250: Ninja R 08-10 • Ninja R 11-12

 E-MARK	CODICE RMS - RMS CODE	COLORE COLOR	LATO SIDE	PASSO THREAD			
	12 277 2150				Nero Black	Destro Right	2 Perni M6 2 M6 Pins
							
	R.O. 56001-0099				Nero Black	Sinistro Left	
	12 276 2150						
	R.O. 56001-0098						



250: Ninja SL Abs 15 • Ninja SL 15 • **300:** Ninja Abs 13-16 • Ninja 13-15

 E-MARK	CODICE RMS - RMS CODE	COLORE COLOR	LATO SIDE	PASSO THREAD			
	12 277 2500				Nero Black	Destro Right	2 Fori passanti 6 mm 2 Passing holes 6 mm
							
	R.O. 560010240				Nero Black	Sinistro Left	
	12 276 2500						
	R.O. 560010239						



250: Z SL Abs 15 • Z SL 15 • **800:** Z Abs 13-16 • Z 13-16 • Z E Abs 13-16 • Z E 13-16

 E-MARK	CODICE RMS - RMS CODE	COLORE COLOR	LATO SIDE	PASSO THREAD			
	12 277 2510				Nero Black	Destro Right	10x1,25 
							
	R.O. 560010244				Nero Black	Sinistro Left	
	12 276 2510						
	R.O. 560010243						

600: Ninja Zx-6R 09-16

 E-MARK	CODICE RMS - RMS CODE	COLORE COLOR	LATO SIDE	PASSO THREAD			
	12 277 2300				Nero Black	Destro Right	2 Fori 6mm 2 Holes 6 mm
							
	R.O. 560010147				Nero Black	Sinistro Left	
	12 276 2300						
	R.O. 560010146						

636: Ninja Zx-6R Abs 13-16 • Ninja Zx-6R 13-16

 E-MARK	CODICE RMS - RMS CODE	COLORE COLOR	LATO SIDE	PASSO THREAD			
	12 277 2470				Nero Black	Destro Right	2 Fori 6mm 2 Holes 6 mm
							
	R.O. 560010246				Nero Black	Sinistro Left	
	12 276 2470						
	R.O. 560010245						







SPECCHI RETROVISORI



REAR VIEW MIRRORS

KAWASAKI



650: Er-6N 06-08 • Er-6N Abs 06-08 • KLE Versys 07-09 • KLE Versys Abs 07-09

 E-MARK	CODICE RMS - RMS CODE		COLORE COLOR	LATO SIDE	PASSO THREAD
	12 277 1290				
					
	R.O. 560010145				
	12 276 1290				
					
R.O. 560010144					
		Nero Black	Destro Right	10 x 1,25 	
			Sinistro Left	10 x 1,25 	





650: Er 6F Abs 09-11 • Er 6F 09-11

 E-MARK	CODICE RMS - RMS CODE		COLORE COLOR	LATO SIDE	PASSO THREAD
	12 277 1850				
					
	R.O. 560010142				
	12 276 1850				
					
R.O. 560010143					
		Nero Black	Destro Right	2 Perni M6 2 M6 Pins	
			Sinistro Left		





650: Er 6F 06-08 • Er 6F Abs 06-08



 E-MARK	CODICE RMS - RMS CODE		COLORE COLOR	LATO SIDE	PASSO THREAD
	12 277 1910				
					
	R.O. 560010044				
	12 276 1910				
					
R.O. 560010043					
		Nero Black	Destro Right	2 Perni M6 2 M6 Pins	
			Sinistro Left		

650: Er-6N Abs 12-16 • Er-6N 12-16

 E-MARK	CODICE RMS - RMS CODE		COLORE COLOR	LATO SIDE	PASSO THREAD
	12 277 2480				
					
	R.O. 560010273				
	12 276 2480				
					
R.O. 560010272					
		Nero Black	Destro Right	10 x 1,25 	
			Sinistro Left	10 x 1,25 	

650: KLE Versys Abs 11-16 • KLE Versys 11-16

 E-MARK	CODICE RMS - RMS CODE		COLORE COLOR	LATO SIDE	PASSO THREAD
	12 277 2490				
					
	R.O. 560010195				
	12 276 2490				
					
R.O. 560010194					
		Nero Black	Destro Right	10 x 1,25 	
			Sinistro Left	10 x 1,25 	

-  Filetto sinistro - *Left Thread*
-  Filetto destro - *Right Thread*



SPECCHI RETROVISORI

REAR VIEW MIRRORS







KAWASAKI





650: Er 6F Abs 12-16 • Er 6F 12-16

	CODICE RMS - RMS CODE	COLORE COLOR Nero <i>Black</i>	LATO SIDE	PASSO THREAD
	12 277 2630			
				
	R.O. 560010275			
	12 276 2630			
				
R.O. 560010274				
Destro <i>Right</i>	2 Pemi 6 mm 2 Pins 6 mm			
Sinistro <i>Left</i>				





750: Z 750 Abs 07-10 • Z 750 07-10 • **1000:** Z 1000 Abs 07-09 • Z 1000 07-09

	CODICE RMS - RMS CODE	COLORE COLOR Nero <i>Black</i>	LATO SIDE	PASSO THREAD
	12 277 1270			
				
	R.O. 560010118			
	12 276 1270			
				
R.O. 560010117				
Destro <i>Right</i>	10 x 1,25 			
Sinistro <i>Left</i>	10 x 1,25 			



750: Z 750 04-05 • Z 750 06 • **1000:** Z 1000 03-05 • Z 1000 06

	CODICE RMS - RMS CODE	COLORE COLOR Nero <i>Black</i>	LATO SIDE	PASSO THREAD
	12 277 1300			
				
	R.O. 560010031			
	12 276 1300			
				
R.O. 560010030				
Destro <i>Right</i>	10 x 1,25 			
Sinistro <i>Left</i>	10 x 1,25 			

800: Z 800 13-16

	CODICE RMS - RMS CODE	COLORE COLOR Nero <i>Black</i>	LATO SIDE	PASSO THREAD
	12 277 2730			
				
	R.O. 560010299			
	12 276 2730			
				
R.O. 560010300				
Destro <i>Right</i>	10 x 1,25 			
Sinistro <i>Left</i>	10 x 1,25 			

1000: Ninja Zx-10R Abs 11-15 • Ninja Zx-10R 11-15

	CODICE RMS - RMS CODE	COLORE COLOR Nero <i>Black</i>	LATO SIDE	PASSO THREAD
	12 277 2310			
				
	R.O. 560010289			
	12 276 2310			
				
R.O. 560010288				
Destro <i>Right</i>	2 Fori 6 mm 2 Holes 6 mm			
Sinistro <i>Left</i>				



SPECCHI RETROVISORI

REAR VIEW MIRRORS

KAWASAKI

1000: Z Sx Abs 14-16 • Z Sx 14-16

E-MARK 	CODICE RMS - RMS CODE		COLORE COLOR	LATO SIDE	PASSO THREAD
	12 277 2520		Nero Black	Destro Right	2 Pemi 6 mm 2 Pins 6 mm
	R.O. 560010260				
	12 276 2520				
R.O. 560010259		Sinistro Left			

1000: KLZ Versys 15-16

E-MARK 	CODICE RMS - RMS CODE		COLORE COLOR	LATO SIDE	PASSO THREAD
	12 277 2600		Nero Black	Destro Right	10 x 1,25
	R.O. 560010298				
	12 276 2600				
				Sinistro Left	10 x 1,25
R.O. 560010297					

1000: Z Abs 10-13 • Z 10-13



E-MARK 	CODICE RMS - RMS CODE		COLORE COLOR	LATO SIDE	PASSO THREAD
	12 277 2610		Nero Black	Destro Right	10 x 1,25
	R.O. 560010216				
	12 276 2610				
				Sinistro Left	10 x 1,25
R.O. 560010215					

1000: Z Sx Abs 11-13 • Z 11-13

E-MARK 	CODICE RMS - RMS CODE		COLORE COLOR	LATO SIDE	PASSO THREAD
	12 277 2620		Nero Black	Destro Right	2 Pemi 6 mm 2 Pins 6 mm
	R.O. 560010232				
	12 276 2620				
				Sinistro Left	
R.O. 560010231					

1400: Zzr 12-17

E-MARK NEW 	CODICE RMS - RMS CODE		COLORE COLOR	LATO SIDE	PASSO THREAD
	12 277 2690		wNero Black	Destro Right	2 Viti M6 2 M6 Bolts
	R.O. 560010234				
	12 276 2690				
				Sinistro Left	
R.O. 560010233					

-  Filetto sinistro - *Left Thread*
-  Filetto destro - *Right Thread*





SPECCHI RETROVISORI

REAR VIEW MIRRORS







KEEWAY

50: Hurricane





E-MARK	CODICE RMS - RMS CODE	COLORE COLOR	LATO SIDE	PASSO THREAD
	12 277 1590	Nero <i>Black</i>	Destro <i>Right</i>	8 x 1,25 
				
	R.O. 801200			
	12 276 1590			
				
	R.O. 801201		Sinistro <i>Left</i>	8 x 1,25 

KYMCO





50: People 99-11 • **125:** People 97-11

E-MARK	CODICE RMS - RMS CODE	COLORE COLOR	LATO SIDE	PASSO THREAD
	12 277 0310	Cromato <i>Chromed</i>	Destro <i>Right</i>	8 x 1,25 
				
	R.O. 00152304			
	12 276 0310			
				
	R.O. 00152305		Sinistro <i>Left</i>	8 x 1,25 



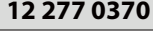
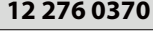

50: Agility R16 08-12 • Super 8 07-09 • **125:** Agility R16 08-12 • **150:** Agility R16 08-09 • **200:** Agility R16 10-12

E-MARK	CODICE RMS - RMS CODE	COLORE COLOR	LATO SIDE	PASSO THREAD
	12 277 0360	Nero <i>Black</i>	Destro <i>Right</i>	8 x 1,25 
				
	R.O. 00188000			
	12 276 0360			
				
	R.O. 00188001		Sinistro <i>Left</i>	8 x 1,25 

50: Kb • K12 95-00 • Fever Zx 99-00 • Zx Eu 2 03-04

E-MARK	CODICE RMS - RMS CODE	COLORE COLOR	LATO SIDE	PASSO THREAD
	12 277 0370	Nero <i>Black</i>	Destro <i>Right</i>	8 x 1,25 
				
	R.O. 00152866			
	12 276 0370			
				
	R.O. 00152867		Sinistro <i>Left</i>	8 x 1,25 

50: Filly 98-00 • Super 9 00-04 • Top Boy 97-00 • Yup 02-03

E-MARK	CODICE RMS - RMS CODE	COLORE COLOR	LATO SIDE	PASSO THREAD
	12 277 0380	Nero <i>Black</i>	Destro <i>Right</i>	8 x 1,25 
				
	R.O. 00152500 – 88110-KEB7-E000			
	12 276 0380	Nero <i>Black</i>	Sinistro <i>Left</i>	8 x 1,25 
				
	R.O. 00152521 – 88120-KEB7-E000			







SPECCHI RETROVISORI





REAR VIEW MIRRORS

KYMCO





50: People S 2t-4t 05-10 • Vitality 2t-4t 04-08 • 125: People S Dd Eu3 07-08 • People S 05 - 200: People Si 07 • People S 06

E-MARK 	CODICE RMS - RMS CODE		COLORE COLOR	LATO SIDE	PASSO THREAD
	12 277 0610				
					
	R.O. 00153132				
	12 276 0580				
					
R.O. 00153133					
		Nero Black	Destro Right	8 x 1,25 	
			Sinistro Left	8 x 1,25 	





50: B&w Eu 2 03 • 125: B&w 00-04 • 150: B&w 00-04 • 250: B&w 00-03

E-MARK 	CODICE RMS - RMS CODE		COLORE COLOR	LATO SIDE	PASSO THREAD
	12 277 0820				
					
	R.O. 00152910N				
	12 276 0820				
					
R.O. 00152913N					
		Nero Black	Destro Right	10 x 1,25 	
			Sinistro Left	10 x 1,25 	





50: Agility 4T Carry, R10, R12 05-11 • 125: Agility 4T, Carry 06-11

E-MARK 	CODICE RMS - RMS CODE		COLORE COLOR	LATO SIDE	PASSO THREAD
	12 277 0910				
					
	R.O. 00152115				
	12 276 0910				
					
R.O. 00152116					
		Nero Black	Destro Right	8 x 1,25 	
			Sinistro Left	8 x 1,25 	

50-125-200: Like 09-13

E-MARK 	CODICE RMS - RMS CODE		COLORE COLOR	LATO SIDE	PASSO THREAD
	12 277 1150				
					
	R.O. 00188024				
	12 276 1150				
					
R.O. 00188023					
		Cromato Chromed	Destro Right	8 x 1,25 	
			Sinistro Left	8 x 1,25 	

50: Dink 4T 07 - 125: Dink Eu3 06-07 - 200: Dink Eu3 I 06-07

E-MARK 	CODICE RMS - RMS CODE		COLORE COLOR	LATO SIDE	PASSO THREAD
	12 277 1210				
					
	R.O. 00152956				
	12 276 1210				
					
R.O. 00152957					
		Nero Black	Destro Right	10 x 1,25 	
			Sinistro Left	10 x 1,25 	

- Filetto sinistro - Left Thread
- Filetto destro - Right Thread

SPECCHI RETROVISORI

REAR VIEW MIRRORS



KYMCO

125: Downtown 09-14 • K-Xct I 12-14 • **200:** Downtown I 10 • **300:** Downtown 09-11 • K-Xct I 12-14

E-MARK 	CODICE RMS - RMS CODE	COLORE COLOR	LATO SIDE	PASSO THREAD
	12 277 1650			
	R.O. 00188025			
	12 276 1650			
R.O. 00188026				

125: People One 13-16

E-MARK 	CODICE RMS - RMS CODE	COLORE COLOR	LATO SIDE	PASSO THREAD
	12 277 1700			
	R.O. 00188057			
	12 276 1700			
R.O. 00188058				

125: People Gti 10-14 • **200:** People Gti 10-14 • **300:** People Gti 10-14

E-MARK 	CODICE RMS - RMS CODE	COLORE COLOR	LATO SIDE	PASSO THREAD
	12 277 1720			
	R.O. 00188031			
	12 276 1720			
R.O. 00188034				

MALAGUTI

50: F10 Jet Line Kat 92-00 • F12 Mod. 94-02 • Centro 93-00 • **50-100:** Ciak 99-01 • Crosser 95-98-Yesterday • Euro 97-00 • **125-150:** F18 Warrior

E-MARK 	CODICE RMS - RMS CODE	COLORE COLOR	LATO SIDE	PASSO THREAD
	12 277 0040			
	R.O. 08803424			
	12 276 0040			
R.O. 08803524				

50: Centro 4T 08-10 • **125:** Centro 08-11 • **160:** Centro 08-11 • **250:** Password 05-08

E-MARK 	CODICE RMS - RMS CODE	COLORE COLOR	LATO SIDE	PASSO THREAD
	12 277 0390			
	R.O. 08804903			
	12 276 0390			
R.O. 08804803				





SPECCHI RETROVISORI

REAR VIEW MIRRORS



MALAGUTI

50: F12 R Phantom Ac 07-10 • F12 R Phantom Lc 07-10 • 125: Blog 09-11 • 160: Blog 09-11



E-MARK 	CODICE RMS - RMS CODE		COLORE COLOR	LATO SIDE	PASSO THREAD
	12 277 1610				
					
	R.O. 08805203				
	12 276 1610				
					
R.O. 08805303					

MBK



50: Cw L Booster Spirit 03 • Cw L Booster 01-03 • Cw Rs Booster Ng (Ita) 95-99 • Cw Rs Booster Ng Eu1 99-00 • Cw Rs Booster Ng 01-03 • Cw Rsp Booster Rocket (Ita) 97-98 • Cw Rxs Booster Track (Ita) 96-98 • Cw Sp Booster Spirit Eu2 02

E-MARK 	CODICE RMS - RMS CODE		COLORE COLOR	LATO SIDE	PASSO THREAD
	12 277 0030				
					
	R.O. 4SBF62800000				
	12 276 0030				
					
R.O. 4SBF62900000					



50: Booster Spirit 00 • Nitro 99-04

E-MARK 	CODICE RMS - RMS CODE		COLORE COLOR	LATO SIDE	PASSO THREAD
	12 277 0050				
					
	R. O. 5BRF62801000				
	12 276 0050				
					
R. O. 5BRF62901000					

50: Ovetto 97-01 • 100: Ovetto

E-MARK 	CODICE RMS - RMS CODE		COLORE COLOR	LATO SIDE	PASSO THREAD
	12 277 0580				
					
	R.O. 5ADF62901000				
	12 276 0580				
					
R.O. 5ADF62801000					

50: Booster Spirit 03 • Booster 01-03 • Booster Ng 95-03 • Booster Rocket 97-98 • Booster Track 96-98

E-MARK 	CODICE RMS - RMS CODE		COLORE COLOR	LATO SIDE	PASSO THREAD
	12 277 0800				
					
	R.O. 4SBF62900000				
	12 276 0800				
					
R.O. 4SBF62800000					

- Filetto sinistro - *Left Thread*
- Filetto destro - *Right Thread*





SPECCHI RETROVISORI

REAR VIEW MIRRORS







MBK

250: Yp Skyliner Abs 03 • Yp Skyliner 00-03





E-MARK	CODICE RMS - RMS CODE	COLORE COLOR	LATO SIDE	PASSO THREAD
	12 277 0560	Nero <i>Black</i>	Destro <i>Right</i>	10 X 1,25 
				
	R.O. 5CG262901000			
	12 276 0560		Sinistro <i>Left</i>	10 X 1,25 
				
	R.O. 5CG262801000			

300: Xc Kilibre 03

E-MARK	CODICE RMS - RMS CODE	COLORE COLOR	LATO SIDE	PASSO THREAD
	12 277 1640	Nero <i>Black</i>	Destro <i>Right</i>	8 x 1,25 
				
	R.O. 5SEF62900000			
	12 276 1640		Sinistro <i>Left</i>	8 x 1,25 
				
	R.O. 5SEF62800000			



MOTO GUZZI

750: Nevada Classic 09-13 • Nevada S 10-12 • V7 09-16 • **850:** V9 Roamer 16 • **940:** Bellagio 07-13 • **1100:** California 03-12 • **1200:** Brevia 07 • Griso 07-13 • Norge 06-08

E-MARK	CODICE RMS - RMS CODE	COLORE COLOR	LATO SIDE	PASSO THREAD
	12 277 0250	Cromato <i>Chromed</i>	Destro <i>Right</i>	10 x 1,25  con adattatore <i>With adapter</i>
				
	R.O. 978570			
	12 276 0250		Sinistro <i>Left</i>	10 x 1,25  con adattatore <i>With adapter</i>
				
	R.O. 978570			

MV AGUSTA

900: Brutale 989R-1078Rr 08 • **910:** Brutale 05-08

E-MARK	CODICE RMS - RMS CODE	COLORE COLOR	LATO SIDE	PASSO THREAD
	12 277 2090	Nero <i>Black</i>	Destro <i>Right</i>	Foro passante 8 mm <i>Passing Hole 8 mm</i>
				
	R.O. 80B098338			
	12 276 2090		Sinistro <i>Left</i>	
				
	R.O. 80B098339			





SPECCHI RETROVISORI



REAR VIEW MIRRORS

MV AGUSTA

920: Brutale 920-990R-1090Rr 10-11





 E-MARK	CODICE RMS - RMS CODE		COLORE COLOR	LATO SIDE	PASSO THREAD			
	12 277 1820							
	R.O. 8000B1658							
	12 276 1820					Nero Black	Destro Right	Foro passante 8 mm Passing Hole 8 mm
							Sinistro Left	
R.O. 8000B1659								

1000: F4 04-06





 E-MARK	CODICE RMS - RMS CODE		COLORE COLOR	LATO SIDE	PASSO THREAD			
	12 277 1920							
	R.O. 80B0A3229							
	12 276 1920					Nero Black	Destro Right	2 Fori 6 mm 2 Holes 6 mm
							Sinistro Left	
R.O. 80B0A3228								

PEUGEOT





50: Speedfight acqua Dt 97-98 • Speedfight aria 97 • Speedfight acqua Dd 97-98 • Speedfight aria-cat. 98-99 • X-Fight 00-> • Trekker Road 98-00 • Vivacity Cat. 99-02 • 100: Speedfight 97 • Vivacity Cat. 99-02 • X-Fight 00-01 • Speedfight 98-00 • Trekker



 E-MARK	CODICE RMS - RMS CODE		COLORE COLOR	LATO SIDE	PASSO THREAD			
	12 277 0150							
	R.O. 738998							
	12 276 0150					Nero Black	Destro Right	8 x 1,25 
							Sinistro Left	8 x 1,25 
R.O. 738997								

50: Jet Force • Speedfight 2 Ac 05-08 • Jet C • Tech 07-10 • 125: Jet Force

 E-MARK	CODICE RMS - RMS CODE		COLORE COLOR	LATO SIDE	PASSO THREAD			
	12 277 0400							
	R.O. 748212							
	12 276 0400					Nero Black	Destro Right	8 x 1,25 
							Sinistro Left	8 x 1,25 
R.O. 748211								

50: Speedfight acqua Dt 97-98 • Speedfight aria 97 • 100: Speedfight 97 • 50-100: Vivacity Cat. 99-02 • 100: X-Fight 00-01

	CODICE RMS - RMS CODE		COLORE COLOR	LATO SIDE	PASSO THREAD			
	12 277 0810							
	R.O. 735175							
	12 276 0810					Nero Black	Destro Right	8 x 1,25 
							Sinistro Left	8 x 1,25 
R.O. 735174								

-  Filetto sinistro - *Left Thread*
-  Filetto destro - *Right Thread*



SPECCHI RETROVISORI

REAR VIEW MIRRORS







PEUGEOT





50: Kisbee u-X • Kisbee • Viva 3 L 2T/4T • **125:** Viva 3 L 4T

E-MARK	CODICE RMS - RMS CODE	COLORE COLOR	LATO SIDE	PASSO THREAD
	12 277 1570	Nero Black	Destro Right	-
				
	R.O. 772582			
	12 276 1570		Sinistro Left	-
				
	R.O. 772581			





50: E Vivacity • Ludix 10L Trend • Ludix 10 Or Snake • Ludix 10 RBP2 • Ludix 10 RL Trend • Ludix 12RL2/3 • Ludix 14L Elegance • Ludix 14RL2 • Tkr2 E • Tkr2 R12 • Tkr2 R • Viva 2 Eu • Viva 2 Co • Viva 2 R • Viva 2 SL4 Eu • **125:** Looxor Adv2 • **150:** Looxor Adv2

E-MARK	CODICE RMS - RMS CODE	COLORE COLOR	LATO SIDE	PASSO THREAD
	12 277 1660	Nero Black	Destro Right	8 x 1,25 
				
	R.O. 761701			
	12 276 1660		Sinistro Left	8 x 1,25 
				
	R.O. 761702			





50 Looxor 2 • Looxor Niu2 • Looxor N • Tkr Eu1 • Tkr2 Eu

E-MARK	CODICE RMS - RMS CODE	COLORE COLOR	LATO SIDE	PASSO THREAD
	12 277 1670	Nero Black	Destro Right	8 x 1,25 
				
	R.O. 746781			
	12 276 1670		Sinistro Left	8 x 1,25 
				
	R.O. 746782			

125: Geo C - Es - E - Sc • **250:** Geo C - Sc - S • **300:** Geo St - Ev 2D - Ev • **400:** C - Sc - S • **500:** Geo

E-MARK	CODICE RMS - RMS CODE	COLORE COLOR	LATO SIDE	PASSO THREAD
	12 277 1560	Nero Black	Destro Right	10 x 1,25 
				
	R.O. 774987			
	12 276 1560		Sinistro Left	10 x 1,25 
				
	R.O. 774986			

125-200: Lxr

E-MARK	CODICE RMS - RMS CODE	COLORE COLOR	LATO SIDE	PASSO THREAD
	12 277 1590	Nero Black	Destro Right	8 x 1,25 
				
	R.O. 881200			
	12 276 1590		Sinistro Left	8 x 1,25 
				
	R.O. 881201			



SPECCHI RETROVISORI

REAR VIEW MIRRORS

PEUGEOT

125: Geopolis C / E / Es / Sc / S - 250: Geopolis C / Sc / S - 400: Geopolis C / Sc / S - 500: Geopolis

	CODICE RMS - RMS CODE		COLORE COLOR Nero Black	LATO SIDE Destro Right	PASSO THREAD 10 x 1,25
	12 277 1630				
	R.O. 770022				
	12 276 1630				
R.O. 770021		LATO SIDE Sinistro Left	PASSO THREAD 10 x 1,25 		

PIAGGIO

Ape

	CODICE RMS - RMS CODE	
	12 276 0010	
	<ul style="list-style-type: none"> • Vetro convesso - <i>Convex glass</i> • Asta semplice Ø 8 mm. - <i>Shaft Ø 8 mm</i> • Attacco come l'originale - <i>Attack same as original</i> • Applicazione Ape tutti i modelli - <i>All Ape models</i> 	

50: Nrg 94-98 • Ntt 95-96 • Typhoon 01-04



	CODICE RMS - RMS CODE		COLORE COLOR Nero Black	LATO SIDE Destro Right	PASSO THREAD 8 x 1,25
	12 277 0060				
	R.O. 271018				
	12 276 0060				
R.O. 271022		LATO SIDE Sinistro Left	PASSO THREAD 8 x 1,25 		

50: Liberty 97-05 • Liberty 4T 00-02 • 125: Liberty 01-02

	CODICE RMS - RMS CODE		COLORE COLOR Nero Black	LATO SIDE Destro Right	PASSO THREAD 8 x 1,25
	12 277 0070				
	R.O. 583033				
	12 276 0070				
R.O. 583031		LATO SIDE Sinistro Left	PASSO THREAD 8 x 1,25 		

Vespa: Attacco con piastra - *Mounting plate* • Predisposto per Vespa - *For Vespa*

	CODICE RMS - RMS CODE	
	12 276 0110	
R.O. 244141		

-  Filetto sinistro - *Left Thread*
-  Filetto destro - *Right Thread*



SPECCHI RETROVISORI

REAR VIEW MIRRORS







PIAGGIO





50: Vespa S 2T 07-12 • Vespa S 4T-4V 08-12 • **125:** Vespa S 4T 07-12 • **150:** Vespa S 4T 08-12

E-MARK	CODICE RMS - RMS CODE	COLORE COLOR	LATO SIDE	PASSO THREAD
	12 277 0270	Cromato <i>Chromed</i>	Destro <i>Right</i>	Perno Cilindrico Ø 10
				
	R.O. CM178902			
	12 276 0270			
				
	R.O. CM178901			





50: Nrg Power 04-15 • Nrg Purejet 05-10 • Typhoon 05-11

E-MARK	CODICE RMS - RMS CODE	COLORE COLOR	LATO SIDE	PASSO THREAD
	12 277 0420	Nero <i>Black</i>	Destro <i>Right</i>	Ø8x1,25 
				
	R.O. CM073002			
	12 276 0420			
				
	R.O. CM073001			





50: Vespa Lxv 2t 06-09 • **125:** Vespa Gtv 06-08 • Vespa Gts 07-16 • Vespa Lxv 06-13 • **250:** Vespa Gt 60 06-07 • Vespa Gtv 07-09 • Vespa Gts 05-16
300: Vespa Gtv 06-13 • Vespa Gts 10-15

E-MARK	CODICE RMS - RMS CODE	COLORE COLOR	LATO SIDE	PASSO THREAD
	12 277 0460	Cromato <i>Chromed</i>	Destro <i>Right</i>	8 x 1,25 
				
	R.O. CM073411			
	12 276 0460			
				
	R.O. CM073410			

50: Vespa Et2 97-05 • **125:** Vespa Et4 96-98

E-MARK	CODICE RMS - RMS CODE	COLORE COLOR	LATO SIDE	PASSO THREAD
	12 277 0490	Nero grigio <i>Black Gray</i>	Destro <i>Right</i>	8 x 1,25 
				
	R.O. 563865			
	12 276 0490			
				
	R.O. 563866			

50: Vespa Et2 97-05 • Vespa Et4 00-05 • **125:** Vespa Et4 99-02

E-MARK	CODICE RMS - RMS CODE	COLORE COLOR	LATO SIDE	PASSO THREAD
	12 277 0510	Nero <i>Black</i>	Destro <i>Right</i>	8 x 1,25 
				
	R.O. 581555			
	12 276 0510			
				
	R.O. 581554			







SPECCHI RETROVISORI





REAR VIEW MIRRORS

PIAGGIO





50: Zip 4T 00-13 • Zip Sp 01-13 • Zip 00-04 • 100: Zip 4T 06-10 • 125: Zip 00-02

E-MARK 	CODICE RMS - RMS CODE		COLORE COLOR	LATO SIDE	PASSO THREAD
	12 277 0520		Nero Black	Destro Right	8 x 1,25 
					
	R.O. CM063902				
	12 276 0520				
					
R.O. CM063901		Sinistro Left	8 x 1,25 		





50: Fly 08-11 • 100: Fly 4T 06-08 • 125: Fly 05-11 • 150: Fly 05-07

E-MARK 	CODICE RMS - RMS CODE		COLORE COLOR	LATO SIDE	PASSO THREAD
	12 277 0530		Nero Black	Destro Right	8 x 1,25 
					
	R.O. CM027002				
	12 276 0530				
					
R.O. CM027001		Sinistro Left	8 x 1,25 		





50: Vespa Lx 2t 05-13 • Vespa Lx 4T 05-13 • 125: Vespa Lx 05-13 • 150: Vespa Lx 05-13

E-MARK 	CODICE RMS - RMS CODE		COLORE COLOR	LATO SIDE	PASSO THREAD
	12 277 0590		Cromato Chromed	Destro Right	8 x 1,25 
					
	R.O. CM020405CM027605				
	12 276 0590				
					
R.O. CM020404-CM027604		Sinistro Left	8 x 1,25 		

50: Vespa Lx 2T 09-13 • Vespa Lx 4T-4V 09-13 • 125: Vespa Gts 09-16 • Vespa Lx 09-12

E-MARK 	CODICE RMS - RMS CODE		COLORE COLOR	LATO SIDE	PASSO THREAD
	12 277 0660		Cromato Chromed	Destro Right	Cilindrico Ø 10
					
	R.O. CM179802				
	12 276 0660				
					
R.O. CM179801		Sinistro Left	8 x 1,25 		

50: Liberty 4T Delivery - Ptt - Tnt 09-15 • Liberty Moc 2T & Elle 09-13 • 125: Liberty 4T 07-15 • Liberty Rst 04-11 • 150: Liberty 4T 08-14
• 200: Liberty 4T - Rst 04-08

E-MARK 	CODICE RMS - RMS CODE		COLORE COLOR	LATO SIDE	PASSO THREAD
	12 277 0670		Cromato Chromed	Destro Right	8x1,25 
					
	R.O. 57325R - CM020402				
	12 276 0670				
					
R.O. 57325R - CM020401		Sinistro Left	8x1,25 		

- Filetto sinistro - *Left Thread*
- Filetto destro - *Right Thread*





SPECCHI RETROVISORI

REAR VIEW MIRRORS







PIAGGIO





50: Vespa Lxv 2T 06-09 • **125:** Vespa Gtv 06-08 • Vespa Lxv 4T 06-13 • **250:** Vespa Gtv 07-09 • Vespa Gt 60 06-07 • **300:** Vespa Gtv 10-13

	E-MARK	CODICE RMS - RMS CODE	COLORE COLOR	LATO SIDE	PASSO THREAD
	12 277 0680	Cromato <i>Chromed</i>			
					
	R.O. CM073414				
	12 276 0680				
					
R.O. CM073413	Destro <i>Right</i>		8 x 1,25 		
R.O. CM073413	Sinistro <i>Left</i>	8 x 1,25 			





50: Nrg Extreme 99-00 • Nrg Mc3 01-04 • Nrg Purejet 02-04 • Nrg Rst Mc2 96-98 • Quartz 92-96 • Zip Fast Rider Rst 96-97 • Zip Fast Rider 93-94 • Zip Rst 96-99 • Zip 95-96 • **80:** Skr City 99 • **125:** Skipper 94-97

	E-MARK	CODICE RMS - RMS CODE	COLORE COLOR	LATO SIDE	PASSO THREAD
	12 277 0700	Nero <i>Black</i>			
					
	R.O. 563496				
	12 276 0700				
					
R.O. 563492	Destro <i>Right</i>		8 x 1,25 		
R.O. 563492	Sinistro <i>Left</i>	8 x 1,25 			





50: Ape FL3 Europa 96-99 • Rst Mix 99-03

	E-MARK	CODICE RMS - RMS CODE	COLORE COLOR	LATO SIDE	PASSO THREAD
	12 277 0710	Nero <i>Black</i>			
					
	R.O. 565062				
	12 276 0710				
					
R.O. 565061	Destro <i>Right</i>		8 x 1,25 		
R.O. 565061	Sinistro <i>Left</i>	8 x 1,25 			

50: Liberty 2T Sport 06 • Liberty 4T Sport 06 • **125:** Liberty Sport 06-08 • **200:** Liberty Sport 06-07

	E-MARK	CODICE RMS - RMS CODE	COLORE COLOR	LATO SIDE	PASSO THREAD
	12 277 0830	Nero <i>Black</i>			
					
	R.O. CM020408				
	12 276 0830				
					
R.O. CM020407	Destro <i>Right</i>		8 x 1,25 		
R.O. CM020407	Sinistro <i>Left</i>	8 x 1,25 			

50: Liberty 4T Delivery 10-14 • **125:** Liberty 4T Delivery 07-15

	E-MARK	CODICE RMS - RMS CODE	COLORE COLOR	LATO SIDE	PASSO THREAD
	12 277 0840	Nero <i>Black</i>			
					
	R.O. 599361				
	12 276 0840				
					
R.O. 622830	Destro <i>Right</i>		8 x 1,25 		
R.O. 622830	Sinistro <i>Left</i>	8 x 1,25 			







SPECCHI RETROVISORI





REAR VIEW MIRRORS

PIAGGIO





50: Free FL 95-02 • Free Delivery 00-01 • 100: Free 02-03

 E-MARK	CODICE RMS - RMS CODE		COLORE COLOR	LATO SIDE	PASSO THREAD
	12 277 0950		Nero Black	Destro Right	8 x 1,25 
					
	R.O. 582892				
	12 276 0950			Sinistro Left	8 x 1,25 
					
R.O. 582891					





50: Liberty Elettrico Ppt 11 • Liberty Moc & Elle 09-16 • Liberty 4T Ptt 07-15 • Liberty 4T Delivery 10-14 • 125: Liberty 4T 07-15

 E-MARK	CODICE RMS - RMS CODE		COLORE COLOR	LATO SIDE	PASSO THREAD
	12 277 1160		Cromato Chromed	Destro Right	8 x 1,25 
					
	R.O. CM020402				
	12 276 1160			Sinistro Left	8 x 1,25 
					
R.O. CM020401					





50: Vespa Lx 4T 4V 09-13 • Vespa Lx 2T 09-13 • 125: Vespa Lx 4T 09-13 • 150: Vespa Lx 4T 12-13

 E-MARK	CODICE RMS - RMS CODE		COLORE COLOR	LATO SIDE	PASSO THREAD
	12 277 1170		Cromato Chromed	Destro Right	8 x 1,25 
					
	R.O. CM020405				
	12 276 1170			Sinistro Left	8 x 1,25 
					
R.O. CM020412					

50: Vespa Primavera 2T-4T 13-16 • 125: Vespa Primavera 4T 3V Iget 16 • Vespa Lx Primavera 4T 3V 13-16 • 150: Vespa Primavera 4T 3V 13-16 • Vespa Primavera 4T 3V Iget 16

 E-MARK	CODICE RMS - RMS CODE		COLORE COLOR	LATO SIDE	PASSO THREAD
	12 277 1200		Cromato Chromed	Destro Right	8 x 1,25 
					
	R.O. CM182102-CM261902				
	12 276 1200			Sinistro Left	8 x 1,25 
					
R.O. CM182101-CM261901					

50-125-150: Liberty Iget 4T 3V le 15

 E-MARK	CODICE RMS - RMS CODE		COLORE COLOR	LATO SIDE	PASSO THREAD
	12 277 2530		Cromato Chromed	Destro Right	8x1,25 
					
	R.O. CM020418				
	12 276 2530			Sinistro Left	8x1,25 
					
R.O. CM020417					

- Filetto sinistro - Left Thread
- Filetto destro - Right Thread

SPECCHI RETROVISORI REAR VIEW MIRRORS



PIAGGIO

50: Vespa Sprint 4T 4V 14 • **125:** Vespa Sprint 4T 3V ie 14-15 • **150:** Vespa Sprint 4T 3V ie 15

	CODICE RMS - RMS CODE	COLORE COLOR	LATO SIDE	PASSO THREAD
	12 277 2540			
	R.O. CM262002			
	12 276 2540			
	Cromato Chromed	Destro Right	8x1,25 	
R.O. CM262001				Sinistro Left

125-200-250: Carnaby 07-10

	CODICE RMS - RMS CODE	COLORE COLOR	LATO SIDE	PASSO THREAD
	12 277 0410			
	R.O. CM174706			
	12 276 0410			
	Nero Black	Destro Right	10x1,25 	
R.O. CM174705				Sinistro Left

125: Mp3 06-08 • Mp3 Ibrido 09-10 • Mp3 Lt Touring 11-12 • **250-300:** Mp3 Lt 06-14 • **400:** Mp3 RL • Lt 07-11 • **500:** Mp3 RL • Lt 11-16

	CODICE RMS - RMS CODE	COLORE COLOR	LATO SIDE	PASSO THREAD
	12 277 0430			
	R.O. CM174709			
	12 276 0430			
	Nero Black	Destro Right	8 x 1,25 	
R.O. CM174708				Sinistro Left

125: Beverly Tourer Eu3 07-10 • **250:** Beverly Tourer Eu3 07-09 • **300:** Beverly Tourer Eu3 09-10 • **400:** Beverly Tourer Eu3 08-10
• **500:** Beverly 02-06 • Beverly Eu3 06-08

	CODICE RMS - RMS CODE	COLORE COLOR	LATO SIDE	PASSO THREAD
	12 277 0440			
	R.O. CM071905			
	12 276 0440			
	Cromato Chromed	Destro Right	10 X 1,25 	
R.O. CM071904				Sinistro Left

125: Beverly Rst 04-07 • Beverly Eu3 07-08 • **250:** Beverly Rst 04-05 • Beverly ie Eu3 06-08 • Beverly 06-07



	CODICE RMS - RMS CODE	COLORE COLOR	LATO SIDE	PASSO THREAD
	12 277 0450			
	R.O. CM025502			
	12 276 0450			
	Cromato Chromed	Destro Right	10 X 1,25 	
R.O. CM025501				Sinistro Left





SPECCHI RETROVISORI
REAR VIEW MIRRORS

PIAGGIO





125: X8 04-08 • X8 Eu 2 • Premium-Street 06-08 • **150:** X8 Eu 2 • Premium-Street 06-08 • **200-250:** X8 04-08 • **400:** X8 06-08
Applicabile anche a: - *Applicable also to:* **125:** X Evo 07-12 • **250:** X Evo 07-11 • **400:** X Evo 07-11

 E-MARK	CODICE RMS - RMS CODE		COLORE COLOR	LATO SIDE	PASSO THREAD
	12 277 0470		Nero Opaco <i>Matt Black</i>	Destro <i>Right</i>	2 Fori passanti <i>2 Passing Holes</i>
					
	R.O. CM073901-174801				
	12 276 0470				
					
R.O. CM073902-174802					





125: X9 01-02 • **180:** X9 180 Amalfi 00-03 • **200:** X9 02-03 • **250:** X9 Motore Honda 00-03

 E-MARK	CODICE RMS - RMS CODE		COLORE COLOR	LATO SIDE	PASSO THREAD
	12 277 0480		Nero <i>Black</i>	Destro <i>Right</i>	2 Fori passanti <i>2 Passing Holes</i>
					
	R.O. 581500				
	12 276 0480				
					
R.O. 581501					





125: Vespa Granturismo Eu 3 06-07 • Granturismo 03-07 • **200:** Granturismo 06-07

 E-MARK	CODICE RMS - RMS CODE		COLORE COLOR	LATO SIDE	PASSO THREAD
	12 277 0690		Cromato <i>Chromed</i>	Destro <i>Right</i>	8x1,25 
					
	R.O. CM073402				
	12 276 0690				
					
R.O. CM073401					

125: X7 Eu 3 08 • X7 Evo Ie Eu 3 09-10 • **250:** X7 Eu 3 08 • **300:** X7 Evo Ie Eu 3 09-10

 E-MARK	CODICE RMS - RMS CODE		COLORE COLOR	LATO SIDE	PASSO THREAD
	12 277 0760		Nero <i>Black</i>	Destro <i>Right</i>	10x1,25 
					
	R.O. CM175012				
	12 276 0760				
					
R.O. CM175011					



125: Beverly Rst 4T 4V Ie Eu3 10-15 • **300:** Beverly Rst 4T 4V Ie Eu3 10-15 • Beverly Ie E4 16

 E-MARK	CODICE RMS - RMS CODE		COLORE COLOR	LATO SIDE	PASSO THREAD
	12 277 0770		Cromato <i>Chromed</i>	Destro <i>Right</i>	10x1,25 
					
	R.O. CM179905				
	12 276 0770				
					
R.O. CM179904					





PIAGGIO





125: Vespa Px 30 anni 07-08 • Vespa Px 11-16 • Vespa Px 98-01 • **150:** Vespa Px 11-16

E-MARK 	CODICE RMS - RMS CODE		COLORE COLOR	LATO SIDE	PASSO THREAD
	12 277 0790		Cromato Chromed	Destro Right	Cilindrico Ø 10
					
	R.O. CM181302				
	12 276 0790				
					
R.O. CM181301		Sinistro Left	Cilindrico Ø 10		





125-250: X Evo 07-16 • **400:** X Evo 07-11

E-MARK 	CODICE RMS - RMS CODE		COLORE COLOR	LATO SIDE	PASSO THREAD
	12 277 0960		Nero Black	Destro Right	2 Fori passanti 2 Passing Holes
					
	R.O. CM180301				
	12 276 0960				
					
R.O. CM180302		Sinistro Left			





125: Mp3 Yourban ERL 11-13 • **300:** Mp3 Yourban ERL 11-15 • Mp3 Lt 11-14 • **500:** Mp3 Sport RL 14-15 • Mp3 Sport Lt 11-12 • Mp3 Lt 11-13

E-MARK 	CODICE RMS - RMS CODE		COLORE COLOR	LATO SIDE	PASSO THREAD
	12 277 0970		Nero Black	Destro Right	8 x 1,25 
					
	R.O. CM175020				
	12 276 0970				
					
R.O. CM175019		Sinistro Left	8 x 1,25 		

125: X10 4T 4V ie 12-13 • **350:** X10 4T 4V ie 12-15 • **500:** X10 4T 4V ie 12-14

E-MARK 	CODICE RMS - RMS CODE		COLORE COLOR	LATO SIDE	PASSO THREAD
	12 277 1120		Nero Black	Destro Right	8x1,25 
					
	R.O. CM 182003 - CM182006				
	12 276 1120				
					
R.O. CM182002 - CM182005		Sinistro Left	8x1,25 		

125: Vespa Lxv Ie 4T 10-13 • **300:** Vespa Gtv 4T 4V ie 10-13

E-MARK 	CODICE RMS - RMS CODE		COLORE COLOR	LATO SIDE	PASSO THREAD
	12 277 2050		Cromato Chromed	Destro Right	8 x 1,25 
					
	R.O. CM073419				
	12 276 2050				
					
R.O. CM073418		Sinistro Left	8 x 1,25 		



SPECCHI RETROVISORI
REAR VIEW MIRRORS

PIAGGIO

125-150-300: Vespa Gts Abs E4 16-17

<p>E-MARK NEW</p>	CODICE RMS - RMS CODE		COLORE COLOR	LATO SIDE	PASSO THREAD
	12 277 2740		Cromato Chromed	Destro Right	8 x 1,25
	R.O. CM073428				
	12 276 2740				
R.O. CM073427		Sinistro Left		8 x 1,25 	

250: Beverly Cruiser 07-09 • **500:** Beverly Cruiser 07-12

<p>E-MARK</p>	CODICE RMS - RMS CODE		COLORE COLOR	LATO SIDE	PASSO THREAD
	12 277 0740		Cromato Chromed	Destro Right	Perno Cilindrico Ø 10
	R.O. CM178801				
	12 276 0740				
R.O. CM178802		Sinistro Left			

250: Beverly Cruiser 07-09 • **500:** Beverly Cruiser 07-12

<p>E-MARK</p>	CODICE RMS - RMS CODE		COLORE COLOR	LATO SIDE	PASSO THREAD
	12 277 0930		Cromato Chromed	Destro Right	10x1,25
	R.O. CM071914				
	12 276 0930				
R.O. CM071913		Sinistro Left		10x1,25 	

300: Carnaby Cruiser 09-12

<p>E-MARK</p>	CODICE RMS - RMS CODE		COLORE COLOR	LATO SIDE	PASSO THREAD
	12 277 0780		Cromato Chromed	Destro Right	10x1,25
	R.O. CM179902				
	12 276 0780				
R.O. CM179901		Sinistro Left		10x1,25 	

400: Beverly Eu 3 06-07

<p>E-MARK</p>	CODICE RMS - RMS CODE		COLORE COLOR	LATO SIDE	PASSO THREAD
	12 277 0340		Cromato Chromed	Destro Right	10x1,25
	R.O. CM071908				
	12 276 0340				
R.O. CM071907		Sinistro Left		10x1,25 	



- Filetto sinistro - Left Thread
- Filetto destro - Right Thread

SPECCHI RETROVISORI REAR VIEW MIRRORS





PIAGGIO



Specchio Vintage per Vespa Ø 105 - Vintage rear view mirror for Vespa Ø 105

	CODICE RMS - RMS CODE	COLORE COLOR	LATO SIDE	PASSO THREAD
	12 277 0920			
				
	12 276 0920			
				
Cromato <i>Chromed</i>	Destro <i>Right</i>	Attacco con Piastra <i>Mounting Plate</i>		
Sinistro <i>Left</i>				



Specchio Vintage regolabile per Vespa Ø 105 - Adjustable Vintage rear view mirror for Vespa Ø 105

	CODICE RMS - RMS CODE	COLORE COLOR	LATO SIDE	PASSO THREAD
	12 277 1580			
				
Cromato <i>Chromed</i>	Destro <i>Right</i> Sinistro <i>Left</i>	8 x 1,25 		

Specchio Vintage regolabile rettangolare per Vespa - Adjustable rectangular rear view mirror for Vespa





	CODICE RMS - RMS CODE	COLORE COLOR	LATO SIDE	PASSO THREAD
	12 277 1780			
				
Cromato <i>Chromed</i>	Destro <i>Right</i> Sinistro <i>Left</i>	8 X 1,25 		

Specchio Vintage regolabile trapezoidale per Vespa - Adjustable trapezoidal rear view mirror for Vespa

	CODICE RMS - RMS CODE	COLORE COLOR	LATO SIDE	PASSO THREAD
	12 277 1790			
				
Cromato <i>Chromed</i>	Destro <i>Right</i> Sinistro <i>Left</i>	8 X 1,25 		

SUZUKI

SUZUKI 110: Address 15-16



	CODICE RMS - RMS CODE	COLORE COLOR	LATO SIDE	PASSO THREAD
	12 277 2670			
				
	R.O. 56500-10JF0-000			
	12 276 2670			
	Nero <i>Black</i>	Destro <i>Right</i>	10 x 1,25 	
R.O. 56600-10JF0-000	Sinistro <i>Left</i>	10 x 1,25 		





SPECCHI RETROVISORI
REAR VIEW MIRRORS

SUZUKI



125-150: Sixteen 08-11

 E-MARK	CODICE RMS - RMS CODE		COLORE COLOR	LATO SIDE	PASSO THREAD
	12 277 1020				
					
	R.O. 56500-39CF0-000				
	12 276 1020				
					
R.O. 56600-39CF0-000					



125-200: Uh Burgman 07-13

 E-MARK	CODICE RMS - RMS CODE		COLORE COLOR	LATO SIDE	PASSO THREAD
	12 277 1680				
					
	R.O. 56500-49F10-000				
	12 276 1680				
					
R.O. 56600-49F10-000					



125: Uh Burgman 14 • **200:** Uh Burgman 14

 E-MARK	CODICE RMS - RMS CODE		COLORE COLOR	LATO SIDE	PASSO THREAD
	12 277 2580				
					
	R.O. 56500-12J00-000				
	12 276 2580				
					
R.O. 56600-12J00-000					

250: An Burgman W-K2 98-02 • **400:** An Burgman X-K2 99-02

	CODICE RMS - RMS CODE		COLORE COLOR	LATO SIDE	PASSO THREAD
	12 277 0890				
					
	R.O. 56500-03F00-000				
	12 276 0890				
					
R.O. 56600-0F00-000					

SUZUKI 250: Inazuma 15-17

 E-MARK NEW	CODICE RMS - RMS CODE		COLORE COLOR	LATO SIDE	PASSO THREAD
	12 277 2660				
					
	R.O. 56500-48H10-000				
	12 276 2660				
					
R.O. 56660-48H10-000					



- Filetto sinistro - *Left Thread*
- Filetto destro - *Right Thread*

SPECCHI RETROVISORI REAR VIEW MIRRORS







SUZUKI



Specchio braccio corto adattabile Suzuki Burgman 400 - *Short arm mirror suitable for Suzuki Burgman 400*

	CODICE RMS - RMS CODE	COLORE COLOR	LATO SIDE	PASSO THREAD
	12 276 0990			
				
	Cromato <i>Chromed</i>	Destro <i>Right</i> Sinistro <i>Left</i>	10 X 1,25 	



600: Gsr 06-10 - **650:** Gsf Bandit 05-06

	CODICE RMS - RMS CODE	COLORE COLOR	LATO SIDE	PASSO THREAD
	12 277 1440			
				
	R.O. 56500-38G10-11			
	12 276 1440			
				
	Nero <i>Black</i>	Destro <i>Right</i>	10 x 1,25 	
	R.O. 56600-38G10-11	Sinistro <i>Left</i>	10 x 1,25 	





600: Gsf Bandit 00-04 • **1200:** Gsf Bandit 01-05

	CODICE RMS - RMS CODE	COLORE COLOR	LATO SIDE	PASSO THREAD
	12 277 1840			
				
	R.O. 56500-31F00			
	12 276 1840			
				
	Nero <i>Black</i>	Destro <i>Right</i>	2 Parni M6 <i>2 M6 Pins</i>	
	R.O. 56600-31F00	Sinistro <i>Left</i>		

600: Gsx-R600 01-03 • **750:** Gsx-R750 00-03 • **1000:** Gsx-R1000 01-02

	CODICE RMS - RMS CODE	COLORE COLOR	LATO SIDE	PASSO THREAD
	12 277 1990			
				
	R.O. 56500-40F10-000			
	12 276 1990			
				
	Nero <i>Black</i>	Destro <i>Right</i>	2 Fori passanti <i>2 Passing holes</i>	
	R.O. 56600-40F10-000	Sinistro <i>Left</i>		

650: DL V-Strom 04-06 • DL V-Strom 07-10 • DL V-Strom 11 • **1000:** DL V-Strom 02-06 • DL V-Strom 07-10

	CODICE RMS - RMS CODE	COLORE COLOR	LATO SIDE	PASSO THREAD
	12 277 1420			
				
	R.O. 56500-04F23-000			
	12 276 1420			
				
	Nero <i>Black</i>	Destro <i>Right</i>	10 x 1,25 	
	R.O. 56600-04F23-000	Sinistro <i>Left</i>	10 x 1,25 	







SPECCHI RETROVISORI



REAR VIEW MIRRORS

SUZUKI





650: Sfv Gladius 09-11 • 1300: B-King 08-10

E-MARK 	CODICE RMS - RMS CODE		COLORE COLOR	LATO SIDE	PASSO THREAD
	12 277 1450				
					
	R.O. 56500-41F40-000				
	12 276 1450				
					
R.O. 56600-41F40-000		Cromato Chromed	Destro Right	10 x 1,25 	
R.O. 56600-41F40-000			Sinistro Left	10 x 1,25 	



650: Sv 99-02

E-MARK 	CODICE RMS - RMS CODE		COLORE COLOR	LATO SIDE	PASSO THREAD
	12 277 1800				
					
	R.O. 56500-19F00-000				
	12 276 1800				
					
R.O. 56600-19F00-000		Nero Black	Destro Right	2 Perni M6 2 M6 Pins	
R.O. 56600-19F00-000			Sinistro Left		



650: Gsf Bandit 09-12

E-MARK 	CODICE RMS - RMS CODE		COLORE COLOR	LATO SIDE	PASSO THREAD
	12 277 1960				
					
	R.O. 56500-44G10-000				
	12 276 1960				
					
R.O. 56600-44G10-000		Nero Black	Destro Right	10 x 1,25 	
R.O. 56600-44G10-000			Sinistro Left	10 x 1,25 	

650: Gsf Bandit 07-08 • Gsx F 08-10 • 1200: Gsf 06 • 1250: Gsf Bandit 07-10 • Gsf S Bandit 11-12

E-MARK 	CODICE RMS - RMS CODE		COLORE COLOR	LATO SIDE	PASSO THREAD
	12 277 1980				
					
	R.O. 56500-38G21-000				
	12 276 1980				
					
R.O. 56600-38G21-000		Nero Black	Destro Right	Fori passanti Passing holes	
R.O. 56600-38G21-000			Sinistro Left	Fori passanti Passing holes	



650: Gsf Bandit 05-06

E-MARK 	CODICE RMS - RMS CODE		COLORE COLOR	LATO SIDE	PASSO THREAD
	12 277 2130				
					
	R.O. 56500-38G00-000				
	12 276 2130				
					
R.O. 56600-38G00-000		Nero Black	Destro Right	2 Fori passanti 6 mm 2 Passing holes 6 mm	
R.O. 56600-38G00-000			Sinistro Left		





SUZUKI





650: Sv 03-10 • Sv SL 15 • **1000:** Sv 03-07 • Gsx R 03-04

 E-MARK	CODICE RMS - RMS CODE		COLORE COLOR	LATO SIDE	PASSO THREAD
	12 277 2160				
					
	R.O. 56500-16G10-000				
	12 276 2160				
					
R.O. 56600-16G10-000					
		Nero Black	Destro Right	2 Fori passanti 6 mm 2 Passing holes 6 mm	
			Sinistro Left		



650: Gsx F 11-12 • **1250:** Gsf S Bandit 16 • Gsx F 10-16

 E-MARK	CODICE RMS - RMS CODE		COLORE COLOR	LATO SIDE	PASSO THREAD
	12 277 2640				
					
	R.O. 56500-18H00-000				
	12 276 2640				
					
R.O. 56600-18H00-000					
		Nero Black	Destro Right	2 Fori passanti 6 mm 2 Passing holes 6 mm	
			Sinistro Left		



750: Gsr 11-15

 E-MARK	CODICE RMS - RMS CODE		COLORE COLOR	LATO SIDE	PASSO THREAD
	12 277 1430				
					
	R.O. 56500-08J00-000				
	12 276 1430				
					
R.O. 56600-08J00-000					
		Nero Black	Destro Right	10 x 1,25 	
			Sinistro Left	10 x 1,25 	

750: Gsx R 04-05

 E-MARK	CODICE RMS - RMS CODE		COLORE COLOR	LATO SIDE	PASSO THREAD
	12 277 1970				
					
	R.O. 56500-29G10-000				
	12 276 1970				
					
R.O. 56600-29G10-000					
		Nero Black	Destro Right	2 Fori passanti 6 mm 2 Passing holes 6 mm	
			Sinistro Left		

1300: Hayabusa 04-11 • Hayabusa X-R3 99-03

 E-MARK	CODICE RMS - RMS CODE		COLORE COLOR	LATO SIDE	PASSO THREAD
	12 277 2030				
					
	R.O. 56500-24F20-000				
	12 276 2030				
					
R.O. 56600-24F20-000					
		Nero Black	Destro Right	2 Fori passanti 6 mm 2 Passing holes 6 mm	
			Sinistro Left		



SPECCHI RETROVISORI
REAR VIEW MIRRORS

SYM

50: Super Fancy 98-00 • Cinderella 99-02 • 100: Cinderella 99-01 • 125: Attila 99-00 • Super Duke 00-01 • Super Fancy 99-02 • 150: Attila 00-01

	CODICE RMS - RMS CODE	COLORE COLOR	LATO SIDE	PASSO THREAD
	12 277 0540	Nero Black	Destro Right	8 x 1,25
	R.O. 88110T40000			
	12 276 0540		Sinistro Left	8 x 1,25
R.O. 88120T40000				

50: Simphony S 10-14 • Symphony 09 • 125: Symphony 09 • Symphony S 09-14 • 150: Symphony S 10-14

	CODICE RMS - RMS CODE	COLORE COLOR	LATO SIDE	PASSO THREAD
	12 277 1040	Nero Black	Destro Right	8 x 1,25
	R.O. 88110APA000			
	12 276 1040		Sinistro Left	8 x 1,25
R.O. 88120APA000				

50: Jet 4 09-10 • Jet 4 R 11-14 • Symphony Sr 10-14 • 125: Jet 4 09-10 • Symphony Sr 10-14 • 150: Symphony Sr 10-14

	CODICE RMS - RMS CODE	COLORE COLOR	LATO SIDE	PASSO THREAD
	12 277 1110	Nero Black	Destro Right	8 x 1,25
	R.O. 88110ANA000			
	12 276 1110		Sinistro Left	8 x 1,25
R.O. 88120ANA000				

125: Joyride Evo 09-14 • 200: Joyride Evo 09-14

	CODICE RMS - RMS CODE	COLORE COLOR	LATO SIDE	PASSO THREAD
	12 277 1180	Nero Black	Destro Right	10 x 1,25
	R.O. 88110LVA000			
	12 276 1180		Sinistro Left	10 x 1,25
R.O. 88120LVA000				

125: Hd2 11-14 • 200: Hd2 I 11-14

	CODICE RMS - RMS CODE	COLORE COLOR	LATO SIDE	PASSO THREAD
	12 277 1710	Nero Black	Destro Right	8 x 1,25
	R.O. 88110LDA000			
	12 276 1710		Sinistro Left	8 x 1,25
R.O. 88120LDA000				

- Filetto sinistro - Left Thread
- Filetto destro - Right Thread

SPECCHI RETROVISORI REAR VIEW MIRRORS



SYM

125: Joyride 01-02 • Joyride Eu2 03-04 • **150:** Joyride 01-02

E-MARK	CODICE RMS - RMS CODE	COLORE COLOR	LATO SIDE	PASSO THREAD
	12 277 1730	Nero Black	Destro Right	10 x 1,25
	R.O. 88110H9D000			
	12 276 1730			
	R.O. 88120H9D000			
			Sinistro Left	10 x 1,25

125: Joyride 05-07 • **200:** Joyride 05-09

E-MARK	CODICE RMS - RMS CODE	COLORE COLOR	LATO SIDE	PASSO THREAD
	12 277 1740	Nero/Cromato Black/Chomed	Destro Right	10 x 1,25
	R.O. 88110H9A00			
	12 276 1740			
	R.O. 88120H9A00			
			Sinistro Left	10 x 1,25

125: Hd 07-08 • Hd Evo 05-11 • **200:** Hd 07 • Hd Evo 07-12

E-MARK	CODICE RMS - RMS CODE	COLORE COLOR	LATO SIDE	PASSO THREAD
	12 277 2550	Nero Black	Destro Right	8x1,25
	R.O. 88110HHA000			
	12 276 2550			
	R.O. 88120HHA000			
			Sinistro Left	8x1,25

200: Joyride 03 • Joyride Eu2 03-04

E-MARK	CODICE RMS - RMS CODE	COLORE COLOR	LATO SIDE	PASSO THREAD
	12 277 1770	Nero / Grigio Black / Gray	Destro Right	10 x 1,25
	R.O. 88110H9A910			
	12 276 1770			
	R.O. 88120H9A910			
			Sinistro Left	10 x 1,25

TRIUMPH

600: Speed Four 03 - **955-1150:** Speed Triple 02-07



E-MARK	CODICE RMS - RMS CODE	COLORE COLOR	LATO SIDE	PASSO THREAD
	12 277 1470	Nero Black	Destro Right Sinistro Left	10 x 1,25
	R.O. 1829158			





SPECCHI RETROVISORI REAR VIEW MIRRORS

TRIUMPH



675: Street Triple 12-14

E-MARK 	CODICE RMS - RMS CODE		COLORE COLOR	LATO SIDE	PASSO THREAD
	12 277 1460		Nero Black	Destro Right	Foro passante Passing hole
					
	R.O. 2066711				
	12 276 1460				
					
R.O. 2066710					

675: Daytona





E-MARK 	CODICE RMS - RMS CODE		COLORE COLOR	LATO SIDE	PASSO THREAD
	12 277 1830		Nero Black	Destro Right	2 Perni M6 2 M6 Pins
					
	R.O. 2066706				
	12 276 1830				
					
R.O. 2066705					

865: Speedmaster • 1700: Thunderbird • 2300: Rocket 3





E-MARK 	CODICE RMS - RMS CODE		COLORE COLOR	LATO SIDE	PASSO THREAD
	12 277 1860		Cromato Chromed	Destro Right	Perno Ø 11 Ø 11 Pin
					
	R.O. 2060060				
	12 276 1860				
					
R.O. 2060061					

YAMAHA

50: Bw's Bump 97-98 • Bw's Easy 13 • Bw's Next Generation 97-06 • Bw's R 01 • Bw's 04-16 • Cw L Bw's 03 • Cw Rs Spy 95-98 • Cw Sp Bw's Original Eu2 02 • Ns Aerox 13-16 • Ns F Aerox F 14-16 • Ns N Aerox Naked 13-16 • Yq Aerox 09-12

E-MARK 	CODICE RMS - RMS CODE		COLORE COLOR	LATO SIDE	PASSO THREAD
	12 277 0030		Nero Black	Destro Right	8 x 1,25 
					
	R.O. 45BF62900000				
	12 276 0030				
					
R.O. 45BF62800000					

50: Yq Aerox 99-08 • Bw's Original 99-02 • 100: Yq Aerox R 12

E-MARK 	CODICE RMS - RMS CODE		COLORE COLOR	LATO SIDE	PASSO THREAD
	12 277 0050		Nero Black	Destro Right	8 x 1,25 
					
	R.O. 5BRF62901000				
	12 276 0050				
					
R.O. 5BRF62801000					



YAMAHA

50: Neo's 97-01 • 100: Neo's 99-02

E-MARK 	CODICE RMS - RMS CODE		COLORE COLOR	LATO SIDE	PASSO THREAD
	12 277 0580				
	R.O. 5ADF62901000				
	12 276 0580				
R.O. 5ADF62801000		Nero Black	Destro Right	8 x 1,25 	
			Sinistro Left	8 x 1,25 	

50: Yq Aerox 09-12 • Ns Aerox 13-16 • Bw's 04-12 • Bw's Bump 13-16 • Bw's Easy 97-98 • Bw's Ng 97-06

E-MARK 	CODICE RMS - RMS CODE		COLORE COLOR	LATO SIDE	PASSO THREAD
	12 277 0800				
	R.O. 4SBF62900000				
	12 276 0800				
R.O. 4SBF62800000		Nero Black	Destro Right	8 x 1,25 	
			Sinistro Left	8 x 1,25 	

50: Neo's 07-12 • Neo's 4 09-15

E-MARK 	CODICE RMS - RMS CODE		COLORE COLOR	LATO SIDE	PASSO THREAD
	12 277 0880				
	R.O. 5C2F62900000				
	12 276 0880				
R.O. 5C2F62800000		Nero Black	Destro Right	8 x 1,25 	
			Sinistro Left	8 x 1,25 	

50: Dt R 06 • Dt X 06 • 125: Xt R 05-08 • Xt X 05-08

E-MARK 	CODICE RMS - RMS CODE		COLORE COLOR	LATO SIDE	PASSO THREAD
	12 277 2650				
	R.O. 1D4F62800000				
	12 276 2650				
R.O. 1D4F62900000		Nero Black	Destro Right	8 x 1,25 	
			Sinistro Left	10 x 1,25 	

125-250: X-Max - X-Max Black 07-09

	CODICE RMS - RMS CODE		COLORE COLOR	LATO SIDE	PASSO THREAD
	12 277 0210				
	R.O. 1B9F629020				
	12 276 0210				
R.O. 1B9F628020		Nero Black	Destro Right	8 x 1,25 	
			Sinistro Left	8 x 1,25 	





SPECCHI RETROVISORI



REAR VIEW MIRRORS

YAMAHA



125: Dt • X-Re 04-06 • 250: Xg Tricker 05->

E-MARK 	CODICE RMS - RMS CODE		COLORE COLOR	LATO SIDE	PASSO THREAD
	12 277 0570				
					
	R.O. 1D0F629000				
	12 276 0570				
					
R.O. 1D0F628000					



125: Xc Cygnus / R 95-99

E-MARK 	CODICE RMS - RMS CODE		COLORE COLOR	LATO SIDE	PASSO THREAD
	12 277 0850				
					
	R.O. 4NB262900000				
	12 276 0850				
					
R.O. 4NB262800000					



125: Yp R X-Max 06-07 • 250: Yp R X-Max 05-06



E-MARK 	CODICE RMS - RMS CODE		COLORE COLOR	LATO SIDE	PASSO THREAD
	12 277 0860				
					
	R.O. 1B9F62901000				
	12 276 0860				
					
R.O. 1B9F62801000					

125: Ybr 05 • 660: Mt-03 06-12 • Xt R 04-14 • Xt X 04-05 • Xt Z Tenere 08-15

E-MARK 	CODICE RMS - RMS CODE		COLORE COLOR	LATO SIDE	PASSO THREAD
	12 277 1480				
					
	R.O. 5VKF629000				
	12 276 1480				
					
R.O. 5VKF628000					

125: Vp X-City 08-11 • 250: Vp X-City 07-15

E-MARK 	CODICE RMS - RMS CODE		COLORE COLOR	LATO SIDE	PASSO THREAD
	12 277 1620				
					
	R.O. 5B2F62900100				
	12 276 1620				
					
R.O. 5B2F62800100					

-  Filetto sinistro - *Left Thread*
-  Filetto destro - *Right Thread*





SPECCHI RETROVISORI

REAR VIEW MIRRORS





YAMAHA





125: Yp R X-Max 10-16 • **250:** Yp R X-Max 10-16 • **400:** Yp R X-Max 14-16

	CODICE RMS - RMS CODE	COLORE COLOR Nero Black	LATO SIDE	PASSO THREAD
	12 277 1760			
				
	R.O. 37PF62900100			
	12 276 1760			
				
	R.O. 37PF62800100		Destro Right	10 x 1,25 
			Sinistro Left	10 x 1,25 





125: Yzf-R 08-16

	CODICE RMS - RMS CODE	COLORE COLOR Nero Black	LATO SIDE	PASSO THREAD
	12 277 2010			
				
	R.O. 5D7F62900100			
	12 276 2010			
				
	R.O. 5D7F62800100		Destro Right	2 Fori passanti 6 mm 2 Passing holes 6 mm
			Sinistro Left	





YAMAHA 125: D'Light 14

	CODICE RMS - RMS CODE	COLORE COLOR Nero Black	LATO SIDE	PASSO THREAD
	12 277 2680			
				
	R.O. 54SF62900000			
	12 276 2680			
				
	R.O. 54SF62800000		Destro Right	10 x 1,25 
			Sinistro Left	10 x 1,25 

YAMAHA 125: Majesty S 14

	CODICE RMS - RMS CODE	COLORE COLOR Nero Black	LATO SIDE	PASSO THREAD
	12 277 2710			
				
	R.O. 1DKF62901000			
	12 276 2710			
				
	R.O. 1DKF62801000		Destro Right	8 x 1,25 
			Sinistro Left	8 x 1,25 

250: Yp Majesty 98-03 • **400:** Yp Majesty 04-11





	CODICE RMS - RMS CODE	COLORE COLOR Nero Black	LATO SIDE	PASSO THREAD
	12 277 0560			
				
	R.O. 5CG262901000			
	12 276 0560			
				
	R.O. 5CG262801000		Destro Right	10 x 1,25 
			Sinistro Left	10 x 1,25 







SPECCHI RETROVISORI
REAR VIEW MIRRORS

YAMAHA





250: Majesty 96-98

E-MARK 	CODICE RMS - RMS CODE		COLORE COLOR	LATO SIDE	PASSO THREAD
	12 277 0600		Nero Black	Destro Right	10 x 1,25 
					
	R.O. 3TB262901000				
	12 276 0600			Sinistro Left	10 x 1,25 
					
R.O. 3TB262801000					



300: Versity

E-MARK 	CODICE RMS - RMS CODE		COLORE COLOR	LATO SIDE	PASSO THREAD
	12 277 1640		Nero Black	Destro Right	8 x 1,25 
					
	R.O. 5SEF62900000				
	12 276 1640			Sinistro Left	8 x 1,25 
					
R.O. 5SEF62800000					



320: Mt-03 16 • **700:** Mt-07 14-16 • **850:** Mt-09 14-16

E-MARK 	CODICE RMS - RMS CODE		COLORE COLOR	LATO SIDE	PASSO THREAD
	12 277 1750		Nero Black	Destro Right	10 x 1,25 
					
	R.O. 1RC262800000				
	12 276 1750			Sinistro Left	10 x 1,25 
					
R.O. 1RC262900000					

320: Yzf-R3A 15-16

E-MARK 	CODICE RMS - RMS CODE		COLORE COLOR	LATO SIDE	PASSO THREAD
	12 277 2560		Nero Black	Destro Right	2 Fori passanti Ø 6 2 Passing holes Ø 6
					
	R.O. 1WDF62901000				
	12 276 2560			Sinistro Left	
					
R.O. 1WDF62801000					

500: Xp T • Max 01-06

E-MARK 	CODICE RMS - RMS CODE		COLORE COLOR	LATO SIDE	PASSO THREAD
	12 277 0550		Nero Black	Destro Right	2 Fori passanti Ø 6 2 Passing holes Ø 6
					
	R.O. 5GJ262901000				
	12 276 0550			Sinistro Left	
					
R.O. 5GJ262801000					

- Filetto sinistro - Left Thread
- Filetto destro - Right Thread

SPECCHI RETROVISORI REAR VIEW MIRRORS



YAMAHA

500: Yp T-Max (Abs) 08-11

E-MARK	CODICE RMS - RMS CODE	COLORE COLOR	LATO SIDE	PASSO THREAD
	12 277 0900	Nero Black	Destro Right	2 Fori passanti Ø 6 2 Passing holes Ø 6
	R.O. 4B5262901900			
	12 276 0900			
	R.O. 4B5262801900			
			Sinistro Left	

530: T Max 12-14

E-MARK	CODICE RMS - RMS CODE	COLORE COLOR	LATO SIDE	PASSO THREAD
	12 277 1090	Nero Black	Destro Right	2 Fori passanti Ø 6 2 Passing holes Ø 6
	R.O. 59C262900000			
	12 276 1090			
	R.O. 59C262800000			
			Sinistro Left	

YAMAHA 530: T-Max 15-16

E-MARK NEW	CODICE RMS - RMS CODE	COLORE COLOR	LATO SIDE	PASSO THREAD
	12 277 2700	Nero Black	Destro Right	2 Fori passanti Ø 6 2 Passing holes Ø 6
	R.O. 2PW262900000			
	12 276 2700			
	R.O. 2PW262800000			
			Sinistro Left	

600: Xj6-N Sp 13 • Xj6-N 09-13 • Xj6-Na Abs 15 • **800:** Fz8-N 11-12 • Fz8-Na 11-12

E-MARK	CODICE RMS - RMS CODE	COLORE COLOR	LATO SIDE	PASSO THREAD
	12 277 1360	Nero Black	Destro Right	10 x 1,25
	R.O. 20S262900000			
	12 276 1360			
	R.O. 20S262800000			
			Sinistro Left	

600: Fz6 Ns 05-06 • Fz6 S2 07-08 • Fz6 04-07

E-MARK	CODICE RMS - RMS CODE	COLORE COLOR	LATO SIDE	PASSO THREAD
	12 277 1530	Cromato Chromed	Destro Right	10 x 1,25
	R.O. 1B3262901000			
	12 276 1530			
	R.O. 1B3262801000			
			Sinistro Left	





SPECCHI RETROVISORI



REAR VIEW MIRRORS

YAMAHA



600: Xj6-F Diversion 10-11 • Xj6-Fa Diversion Abs 10-11

 E-MARK	CODICE RMS - RMS CODE		COLORE COLOR	LATO SIDE	PASSO THREAD
	12 277 1890				
					
	R.O. 36P26290000				
	12 276 1890				
					
R.O. 36P26280000					
			Nero Black	Destro Right	2 Perni M6 2 M6 Pins
				Sinistro Left	





600: Fz6 Fazer 07-08

 E-MARK	CODICE RMS - RMS CODE		COLORE COLOR	LATO SIDE	PASSO THREAD
	12 277 1950				
					
	R.O. 458262900000				
	12 276 1950				
					
R.O. 458262800000					
			Nero Black	Destro Right	2 Perni M6 2 M6 Pins
				Sinistro Left	





600: Fzs Fazer 02-03 • 1000: Fzs Fazer 01-05

 E-MARK	CODICE RMS - RMS CODE		COLORE COLOR	LATO SIDE	PASSO THREAD
	12 277 2110				
					
	R.O. 5LV262900000				
	12 276 2110				
					
R.O. 5LV262800000					
			Nero Black	Destro Right	2 Perni M6 2 M6 Pins
				Sinistro Left	

600: Xj N 95-01 • Xj S Diversion 92-02

 E-MARK	CODICE RMS - RMS CODE		COLORE COLOR	LATO SIDE	PASSO THREAD
	12 277 2230				
					
	R.O. 4BR262900000				
	12 276 2230				
					
R.O. 4BR262800000					
			Nero Black	Destro Right	10 x 1,25 
				Sinistro Left	10 x 1,25 

660: Xt X 04-14

 E-MARK	CODICE RMS - RMS CODE		COLORE COLOR	LATO SIDE	PASSO THREAD
	12 277 1490				
					
	R.O. 1D2F62900000				
	12 276 1490				
					
R.O. 1D2F62800000					
			Nero Black	Destro Right	10 x 1,25 
				Sinistro Left	10 x 1,25 

- Filetto sinistro - *Left Thread*
- Filetto destro - *Right Thread*

SPECCHI RETROVISORI

REAR VIEW MIRRORS



YAMAHA

800: Fz8-S 11-15 • Fz8-Sa 11-15

E-MARK	CODICE RMS - <i>RMS CODE</i>	COLORE COLOR	LATO SIDE	PASSO THREAD
	12 277 2060	Nero <i>Black</i>	Destro <i>Right</i>	2 Pemi M6 2 M6 Pins
	R.O. 42P262900000			
	12 276 2060			
	R.O. 42P262800000			
			Sinistro <i>Left</i>	

850: Tdm 00-01 • **900:** Tdm Abs 06-10 • Tdm 06-10

E-MARK	CODICE RMS - <i>RMS CODE</i>	COLORE COLOR	LATO SIDE	PASSO THREAD
	12 277 1220	Nero <i>Black</i>	Destro <i>Right</i>	10 x 1,25
	R.O. 4TX262805000			
	12 276 1220			
	R.O. 4TX262905000			
			Sinistro <i>Left</i>	10 x 1,25

850: Tdm 91-98

E-MARK	CODICE RMS - <i>RMS CODE</i>	COLORE COLOR	LATO SIDE	PASSO THREAD
	12 277 2100	Nero <i>Black</i>	Destro <i>Right</i>	10 x 1,25
	R.O. 3VD262900100			
	12 276 2100			
	R.O. 4TX262800000			
			Sinistro <i>Left</i>	10 x 1,25

1000: Fz1 08-09 • **1700:** Mt-01 07-09 • Mt-01S 09

E-MARK	CODICE RMS - <i>RMS CODE</i>	COLORE COLOR	LATO SIDE	PASSO THREAD
	12 277 1240	Nero <i>Black</i>	Destro <i>Right</i>	10 x 1,25
	R.O. 5YU262902000-2100-3000			
	12 276 1240			
	R.O. 5YU262802000-2100-3000			
			Sinistro <i>Left</i>	10 x 1,25

1000: Fz1 06-07

E-MARK	CODICE RMS - <i>RMS CODE</i>	COLORE COLOR	LATO SIDE	PASSO THREAD
	12 277 1260	Cromato <i>Chromed</i>	Destro <i>Right</i>	10 x 1,25
	R.O. 2D1262900100			
	12 276 1260			
	R.O. 2D1262800100			
			Sinistro <i>Left</i>	10 x 1,25





SPECCHI RETROVISORI



REAR VIEW MIRRORS

YAMAHA





1000: Yzf-R1 04-06 • Yzf-R1Sp 06

 E-MARK	CODICE RMS - RMS CODE		COLORE COLOR	LATO SIDE	PASSO THREAD
	12 277 2000		Nero Black	Destro Right	2 Perni M6 2 M6 Pins
					
	R.O. 5VY262900000				
	12 276 2000				
					
R.O. 5VY262800000					

1000: Fz1 Fazer Abs 07-08 • Fz1 Fazer 06-10



 E-MARK	CODICE RMS - RMS CODE		COLORE COLOR	LATO SIDE	PASSO THREAD
	12 277 2070		Nero Black	Destro Right	2 Perni M6 2 M6 Pins
					
	R.O. 3C3262900000				
	12 276 2070				
					
R.O. 3C32628000000					

1200: Xt Z Super tenere 14-15 • Xt Ze Super tenere 14-15



 E-MARK	CODICE RMS - RMS CODE		COLORE COLOR	LATO SIDE	PASSO THREAD	
	12 277 2570		Nero Black	Destro Right	10 x 1,25 	
						
	R.O. 2BS262900000					
	12 276 2570				Sinistro Left	10 x 1,25 
						
R.O. 2BS262800000						

UNIVERSALE

Specchio universale per ciclomotore - *Universal mirror for moped*

 E-MARK	CODICE RMS - RMS CODE		COLORE - COLOR	
	12 276 0100		Nero Black	
				
	<ul style="list-style-type: none"> • Vetro Ø 105 mm. - <i>Glass Ø 105 mm.</i> • Asta semplice Ø 8 mm. - <i>Shaft Ø 8 mm.</i> • Attacco a fascetta al manubrio - <i>Clamp mount</i> 			

Specchio tondo universale pieghevole - *Universal rounded folding mirror*

 E-MARK	CODICE RMS - RMS CODE		COLORE COLOR	LATO SIDE	PASSO THREAD
	12 276 1000		Nero Black	Destro Right Sinistro Left	8 mm
					



UNIVERSALE

Specchio universale "end bar" alluminio nero - *Universal "end bar" rear view mirror*

	CODICE RMS - RMS CODE	COLORE COLOR	LATO SIDE	PASSO THREAD
	12 277 1510	Nero Black	Destro Right Sinistro Left	Ø 22

Coppia specchi universali con adattatori - *Couple of adjustable rear view mirrors with adapters*

	CODICE RMS - RMS CODE	COLORE COLOR	LATO SIDE	PASSO THREAD
	12 277 1690	Nero Black	-	Con adattatori With adapters

Specchio universale cromato - *Universal chromed rear view mirror*

	CODICE RMS - RMS CODE	COLORE COLOR	LATO SIDE	PASSO THREAD
	12 277 2190	Cromato Chromed	Destro Right Sinistro Left	

Coppia specchi tondi universali pieghevoli con adattatori - *Couple of universal rounded folding mirrors and adapters*

	CODICE RMS - RMS CODE	COLORE COLOR	LATO SIDE	PASSO THREAD
	12 277 2250	Nero Black	-	Con adattatori With adapters

Coppia specchi universali omologati con adattatori - *Couple of adjustable homologated rear view mirrors with adapters*

	CODICE RMS - RMS CODE	COLORE COLOR	LATO SIDE	PASSO THREAD
	12 277 2280	Nero Black	-	Con adattatori With adapters

Coppia specchi universali omologati con frecce integrate e adattatori - *Couple of adjustable homologated rear view mirrors with blinkers and adapters*



	CODICE RMS - RMS CODE	COLORE COLOR	LATO SIDE	PASSO THREAD
	12 277 2290	Nero Black	-	Con adattatori With adapters





SPECCHI RETROVISORI
REAR VIEW MIRRORS

UNIVERSALE

Coppia specchi universali omologati con adattatori - Couple of adjustable homologated rear view mirrors and adapters

 	CODICE RMS - RMS CODE	COLORE COLOR	LATO SIDE	PASSO THREAD
	12 277 2330	Nero Black	-	Con adattatori With adapters
				

Coppia specchi universali omologati con adattatori - Couple of adjustable homologated rear view mirrors with adapters

 	CODICE RMS - RMS CODE	COLORE COLOR	LATO SIDE	PASSO THREAD
	12 277 2340	Cromato Chromed	-	Con adattatori With adapters
				



ADATTATORI SPECCHI - MIRROR ADAPTERS

	CODICE RMS <i>RMS CODE</i>	BARCODE	\varnothing D1	T1	D2	T2
	12 185 0060		M8		M10	
	12 185 0070		M8		M10	
	12 185 0080		M8		M8	
	12 185 0090		M8		M10	
	12 185 0100		M8		M10	
	12 185 0110		M8		M8	
	12 185 0120		M10		M10	
	12 185 0130		M10		M8	
	12 185 0140		M10		M8	
	12 185 0150		M10		M10	
	12 185 0160		M10		M8	
	12 185 0170		M10		M8	

12 185 0050

ADATTATORE SPECCHIO - MIRROR ADAPTER

PIAGGIO 125: Beverly Eu3 Mic 07 • Beverly Eu3 Sport 07-08 • Beverly Eu3 07-08 • Beverly Rst 05-07 • Beverly Tourer Eu3 07-10 • Beverly 01-03 • Carnaby 07-10 • **200:** Carnaby 07-08 • **250:** Beverly Eu3 Mic 07 • Beverly Ie Eu3 06-08 • Beverly Rst 04-05 • Beverly Sport 06-08 • Beverly Tourer Eu3 07-09 • Beverly 06-07 • Carnaby 08 • **300:** Beverly Tourer Eu3 09-10 • **400:** Beverly Eu3 06-07 • Beverly Tourer Eu3 08-10 • X8 Eu3 06-08 • **500:** Beverly Eu3 06-08 • Beverly 02-06 (R.O. 497343)



12 185 0020

ADATTATORE SPECCHIO LATO DESTRO

RIGHT SIDE MIRROR ADAPTER

APRILIA 50: Mx 04 • Rally Liquid Cooled 96-99 • Rx • Racing • Enduro • Motard 95-06 • Scarabeo 2T Net • 2T Eu 2 Mot. Piaggio • Street 2T Restyling • Scarabeo 4T • 4V • 4V Net • 4T Restyling Eu 3 • Quattro • Ditech 93-11 • **100:** Scarabeo 4T • 4T Net • Net Eu 3 • 4T Restyling 01-10 • Scarabeo Motori Minarelli • Yamaha 00 **125:** Mx 04-06 • Rx • Sx 94-10

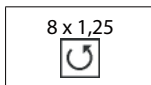

12 185 0030

ADATTATORE SPECCHIO LATO SINISTRO

LEFT SIDE MIRROR ADAPTER

APRILIA 50: Mx 04 • Rally Liquid Cooled 96-99 • Rx • Racing • Enduro • Motard 95-06 • Scarabeo 2T Net • 2T Eu 2 Mot. Piaggio • Street 2T Restyling • Scarabeo 4T • 4V • 4V Net • 4T Restyling Eu 3 • Quattro • Ditech 93-11 • **100:** Scarabeo 4T • 4T Net • Net Eu 3 • 4T Restyling 01-10 • Scarabeo Motori Minarelli • Yamaha 00 **125:** Mx 04-06 • Rx • Sx 94-10

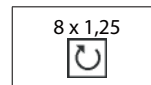

12 185 0180

STAFFA SUPPORTO SPECCHIO

MIRROR HOLDER

PIAGGIO: Vespa Px 125-150-200 77-98



12 185 0040

ADATTATORE SPECCHIO - MIRROR ADAPTER

PIAGGIO: Vespa Px 98-15

(R.O. 622391)





RMS
YOUR BEST PARTNER

The background of the top two-thirds of the page is a repeating pattern of various motorcycle-related icons in a light grey color. These icons include a motorcycle, a battery, a wrench and screwdriver, a gear, a bolt, a nut, a piston, a spark plug, and a tire. The icons are arranged in a grid-like fashion, creating a technical and industrial aesthetic.

▶ CAVALLETTI

STANDS

The RMS logo is located in the bottom-left corner of the page. It features the letters 'RMS' in a bold, sans-serif font. The 'R' is blue, the 'M' is red, and the 'S' is blue. Below the letters is a horizontal line with a green segment under the 'R', a white segment under the 'M', and a red segment under the 'S'. Below the line is the tagline 'YOUR BEST PARTNER' in a smaller, blue, sans-serif font.

▶ **RMS**
YOUR BEST PARTNER



CAVALLETTI CENTRALI
CENTRAL STANDS

APRILIA

12 161 0010 

50: Sr 93>unificato • Amico
(R.O. AP8232933)



12 161 0030 

50: Sr - Gulliver 94-03
(R.O. AP8232819)



12 161 0040 

50-80-100: Scarabeo 2t
Modifica - *Modified*
(R.O. AP8232927)



12 161 0060 

50: Sr Ditech iniezione 00
(R.O. AP8235090)



12 161 0070 

50: Sonic Gp 98-08
(R.O. AP8232987)



12 161 0100 

50: Scarabeo 2T • Net 2T • Street 2T
Motori Piaggio - *Piaggio Engine*
(R.O. AP8235177)



12 161 0430 

50: Scarabeo Motori Minarelli 2T
Modifica - *Modified*



12 161 0440 

50: Sr Motori Minarelli 2T
Modifica - *Modified*



12 161 0950 

50: Scarabeo Quattro 09 • Scarabeo 4T 02-06 •
Scarabeo 4T Restyling 06-09 • Scarabeo 4T 4V
Net 09-10 • Scarabeo 4T 4V 10-12
100: Scarabeo 4T 01-12
(R.O. 600183)





APRILIA

12 161 0390 

100-125-150: Scarabeo 4T
Motori Piaggio - Piaggio Engine
(R.O. 581835)



12 161 0410 

125-150: Habana
(R.O. 580902-56467R))



DERBI

12 161 0950 

125: Sonar 4T 09-11
150: Sonar 09
(R.O. 600183)



GILERA

12 161 0110 

50: Runner • Ice • Nrg 96-12
(R.O. 581537)



12 161 0120 

50: Typhoon • Typhoon X 2T 01-11
Typhoon Eu 2 10-12 • Typhoon Eu 3 11
(R.O. 581505)



12 161 0130 

50: Stalker • Runner 97-00
Runner Poggiali 02 • Purejet 02-04 • Sp 02-04
(R.O. 581785)



12 161 0140 

125: Typhoon 95-98 • Runner • Typhoon Xr 98-00
(R.O. 580985)





CAVALLETTI CENTRALI
CENTRAL STANDS

HONDA

12 161 0170 

50: Sh • Scoopy 2T 84-89



12 161 0530 

125-150: Chiocciola 4T



12 161 0540 

125-150: Sh 4T
(R.O. 50500-KPR-900)



INNOCENTI

12 161 0960 

125-150-200: Lambretta Li 3° DL serie
(R.O. 19957030)



12 161 1070 

INNOCENTI Lambretta
LI 2° Serie



NEW

12 161 0200 

50: Pista 2T 92



ITALJET

KYMCO

12 161 0760 

50: Agility 4T
Ruota 16" - Wheel 16"
(R.O. 00150056)



12 161 0770 

50: Agility 4T
Ruota 12" - Wheel 12"
(R.O. 00165059)



12 161 0150 

125-150: People 4T 03-11
(R.O. 00165700)





KYMCO

12 161 0510 

125-150: Dink 4T
Ruota 10" - *Wheel 10"*
(R.O. 00164972)



12 161 0710 

125: Agility R16 08
Ruota 16" - *Wheel 16"*
(R.O. 00150077)



12 161 0730 

125: Agility Rs 4T
Ruota 12" - *Wheel 12"*
(R.O. 00164128)



12 161 0740 

125: Super 8 08-09 4T
(R.O. 00150051)



12 161 0750 

125: Agility Carry 11 • Like 09 • Like Lx 12
200: Like I 09 • Like Lx 12
(R.O. 00150185)



12 161 0820 

125-200: People 4T
(R.O. 00165704)



LML

12 161 0691 

125-150: Scooter 2T Engine 2 Stroke
Zincato - *Galvanized*



MALAGUTI

12 161 0180 

50: F10 • Yesterday
(R.O. 15803499)



12 161 0190 

50: F12 Aria e Lc • F15 • Centro
(R.O. 15804055)





CAVALLETTI CENTRALI
CENTRAL STANDS

MALAGUTI

12 161 0230

50: Ciak
(R.O. 15804899)



12 161 0450

50: F12 • F15
Modifica - Modified



12 161 0620

50: F12 • F15 • Ciak



MBK

12 161 0180

50: Sorriso • Evolis 91-93



12 161 0200

50: Booster 90-94 • Spirit • Road • Ng • Rocket
(R.O. 5WF71110000)



12 161 0220

50: Ovetto 97-01
(R.O. 5ADF71110100)



12 161 0230

50: Flipper 2T
(R.O. 158048899)



12 161 0240

50: Stunt 00-02
(R.O. 5JHF71110000)



12 161 0250

50: Booster Ng • Track • Bump
(R.O. 5LUF71110000)





MBK

12 161 0260 

50: Nitro 2T 00-03
100: Booster



12 161 0440 

50: Nitro
Modifica - *Modified*



12 161 0450 

50: Ovetto 97-01
Modifica - *Modified*



PEUGEOT

12 161 0620 

50: Flipper
Modifica - *Modified*



12 161 0570 

50-100: Speedfight • Elyseo • Vivacity • Xfight • Looxor • Metal X • Jet Force
(R.O. 740232)



12 161 0650 

50: Ludix
Ruota 12"-14" - *Wheel 12"-14"*
(R.O. 761700)



12 161 0660 

50: Ludix
Ruota 10" - *Wheel 10"*
(R.O. 761699)



12 161 0390 

125-150: Looxor
Motori Piaggio - *Piaggio Engine*
(R.O. 746916)





CAVALLETTI CENTRALI
CENTRAL STANDS

PIAGGIO

12 161 0100 

50: Zip • Zip Fast Rider 93-94
Zip Rst 96-99 2T
(R.O. 581226)



12 161 0120 

50: Typhoon- Typhoon X 12
(R.O. 581505)



12 161 0130 

50: Nrg 2T (Tutti - All) 96-12
(R.O. 581785)



12 161 0290 

50: Free • Delivery • FL 00-01
Liberty Unificato 2T
(R.O. 271144)



12 161 0300 

50: Sfera Rst 2T 91-93 • Quartz 92-96
(R.O. 259209)



12 161 0320 

50: Vespa 2T Et2 97-00 • Sfera 95-00
Vespa Lx 2T 10-13 • Navy 08 • S 07-12 •
College 07-12
(R.O. 582155)



12 161 0390 

50: Liberty 4T 00-02
125: Liberty 4T 01-02
(R.O. 581835)



12 161 0410 

50-100-125-150: Fly 4T
125: Zip 00-02
150: Et4
(R.O. 601708-56467R-582018)



12 161 0490 

50: Si • Si FL2 2T 91-93
(R.O. 185869)





PIAGGIO

12 161 0500 

50: Ciao • Px 2T 80-04
(R.O. 25523001)



12 161 0640 

50: Liberty Poste
125: Liberty >05
Modello Poste - *Postal service model*
(Foro Ø 10 - Hole Ø 10 mm)
(R.O. 647563)



12 161 0950 

50: Liberty 4T 04-13 - **125:** Liberty 4T 06-12
150: Liberty 4T 08-13 - **200:** 06-08
(R.O. 600183)



12 161 0970 

50: Vespa Sprint 4T 4V 14
(R.O. 1C000274)



12 161 0980 

50: Vespa Primavera 4T 4V 14
(R.O. 1C000011)



12 161 0990 

50: Vespa Primavera 2T 13-14
(R.O. 1C000276)



12 161 1000 

50: Vespa Sprint 2T 14
(R.O. 1C000885)



12 161 1030 

50: Ciao 1° serie
(R.O. 10463101)



12 161 0140 

125-150: Skipper 2T 94-97
(R.O. 560011)





CAVALLETTI CENTRALI
CENTRAL STANDS

PIAGGIO

12 161 0270 

125: Liberty 4t Mod. 98-00
(R.O. 581368)



12 161 0330 

125: Vespa Et4 • Sfera Rst 96-98
(R.O. 562593)



12 161 0670 

NEW

Vespa Pk 50-125
V5x1t-V5x2t-V5s1t-Vmx1t-Vmx5t-Vm6xt
Ø 22 mm
Ruota 10"/Wheel 10"
(R.O. 2162476)



12 161 0940 

125: Vespa Lx 4T 3V le - Touring 12-13
Vespa S 4T 3V le 12-13
150: Vespa Lx 4T 3V le - Touring 12-13
(R.O. 668451)



12 161 1010 

125: Vespa Lx 4T Eu3 Touring 10-11 • Vespa Lx 4T FL 09 • Vespa Lx Eu3 le 09-11 • Vespa Lx Eu3 06-08 • Vespa Lx 05-06 • Vespa Lxv 4T Eu3 06-09 • Vespa Lxv 4T Navy Eu3 07-08 • Vespa Lxv le 4T 10-13 • Vespa S 4T Eu3 07-08 • Vespa S 4T le & College 09-11 • **150:** Vespa Lx 4T FL 09 • Vespa Lx Eu3 le 09-11 • Vespa Lx Eu3 06-08 • Vespa Lx Touring 10-12 • Vespa Lx 05-06 • Vespa S 4T le & College 09-12 • Vespa S 4T 08-09
(R.O. 56467R)



12 161 1060 

NEW

PIAGGIO 125: Liberty 2T Versione Ptt
(R.O. 581092)



12 161 0350 

50-90-125: Primavera • Et3
V5A1 - V5A2T - V5B1T - V3T - V9A1 - VMA2
VMB1
Nero - Black
Ø 20 mm
Ruota 10" - Wheel 10"
(R.O. 1353845)



12 161 0351 

50-90-125: Primavera • Et3
V5A1 - V5A2T - V5B1T - V3T - V9A1 - VMA2
VMB1
Zincato - Galvanized
Ø 20 mm
Ruota 10" - Wheel 10"
(R.O. 1353845)



12 161 0352 

50-90-125: Primavera • Et3
V5A1 - V5A2T - V5B1T - V3T - V9A1 - VMA2
VMB1
Cromato - Chromed
Ø 20 mm
Ruota 10" - Wheel 10"





PIAGGIO - VESPA

12 161 0671



50-125: Pk
V5X1T - V5X2T - V5S1T - VMX1T - VMX5T
VM6XT
Zincato - *Galvanized*
Ø 22 mm
Ruota 10" - *Wheel 10"*
(R.O. 2162476)



12 161 0672



50-125: Pk
V5X1T - V5X2T - V5S1T - VMX1T - VMX5T
VM6XT
Cromato - *Chromed*
Ø 22 mm
Ruota 10" - *Wheel 10"*



12 161 0830



50-90:
V5A - V5SA1 - V9A
Zincato - *Galvanized*
Ø 16 mm
Ruota 9" - *Wheel 9"*
(R.O. 070161)



12 161 0360



125-150-200: Cosa 1 e 2
VSR1T - VNR2T - VLR2T
Nero - *Black*
Ø 22 mm
Ruota 10" - *Wheel 10"*
(R.O. 2533615)



12 161 0370



125-150-200: Px • Pxe Arcobaleno
VNX - VLX - VSX - VNX2 - VLX2 - VSX2
Nero - *Black*
Ø 22 mm
Ruota 10" - *Wheel 10"*



12 161 0371



125-150-200: Px • Pxe Arcobaleno
VNX - VLX - VSX - VNX2 - VLX2 - VSX2
Zincato - *Galvanized*
Ø 22 mm
Ruota 10" - *Wheel 10"*
(R.O. 1761606)



12 161 0372



125-150-200: Px • Pxe Arcobaleno
VNX - VLX - VSX - VNX2 - VLX2 - VSX2
Cromato - *Chromed*
Ø 22 mm
Ruota 10" - *Wheel 10"*



12 161 0380



125-150-200: Px • Pxe Arcobaleno
VNX - VLX - VSX - VNX2 - VLX2 - VSX2
Nero - *Black*
Ø 22 mm
Ruota 10" - *Wheel 10"*



12 161 0790



125: T5
VNX5T
Nero - *Black*
Ø 22 mm
Ruota 10" - *Wheel 10"*
(R.O. 232904)





CAVALLETTI CENTRALI
CENTRAL STANDS

PIAGGIO - VESPA

12 161 0800



125:
VNB1/2/3/4/5
Zincato - *Galvanized*
Ø 20 mm
Ruota 8" - *Wheel 8"*
(R.O.54140)



12 161 0870



125:
VM1/2T-VL1/2T
Zincato - *Galvanized*
Ø 15 mm
Ruota 8" - *Wheel 8"*
(R.O. 017013)



12 161 0880



125:
VNA 1/2T-VNB1/2 - VBA1T - VBB1T
Zincato - *Galvanized*
Ø 16 mm
Ruota 8" - *Wheel 8"*
(R.O. 083814)



12 161 0890



125:
VNA 1T
Zincato - *Galvanized*
Ø 15 mm
Ruota 8" - *Wheel 8"*



12 161 0910



125:
Zincato - *Galvanized*
Ø 15 mm
Ruota 8" - *Wheel 8"*



12 161 1020



125: U
VU1T
Zincato - *Galvanized*
Ruota 8" - *Wheel 8"*



12 161 0810



150:
VNB2 - VNB3 - VNB4 - VNB5 - VNB6
Zincato - *Galvanized*
Ø 20 mm
Ruota 10" - *Wheel 10"*
(R.O. 54141)



12 161 0860



150: Gs
VS4/5
Zincato - *Galvanized*
Ø 15 mm
Ruota 10" - *Wheel 10"*
(R.O. 026452)



12 161 0900



150:
Zincato - *Galvanized*
Ø 15 mm
Ruota 10" - *Wheel 10"*





PIAGGIO - VESPA

12 161 0920 

150:
VGLA-B
Zincato - Galvanized
Ø 16 mm
Ruota 10" - Wheel 10"



12 161 1051 

150: GL • Sprint • Sprint Veloce
200: Rally
VNL2 - VLB1 - VLA - VSE1
Zincato - Galvanized
Ø 20 mm
Ruota 10" - Wheel 10"
(R.O. 091047)



12 161 1052 

150: GL • Sprint • Sprint Veloce
200: Rally
VNL2 - VLB1 - VLA - VSE1
Cromato - Chromed
Ø 20 mm
Ruota 10" - Wheel 10"



SYM

12 161 1040 

125: Symphony St 15 • Symphony Sr 10-14 •
Symphony S 13-14 • 150: Symphony Sr 10-14 •
Symphony S 12-14 • 200: Symphony St 15
(R.O. 50500X4A000)



YAMAHA

12 161 0200 

50: Bump • Bw's
(R.O. 4YBF71110000)



12 161 0220 

50: Neo's • 106 R • Mach
Modifica - Modified



12 161 0230 

50: Why
(R.O. 158048899)



12 161 0240 

50: Slider 00-02
(R.O. 5JHF71110000)



12 161 0250 

50: Bw's • Ng • Track • Bump





CAVALLETTI CENTRALI
CENTRAL STANDS

YAMAHA

12 161 0260



50: Aerox
100: Bw's 99-01



12 161 0440



50: Aerox
Modifica - Modified



12 161 0450



50: Neo's
Modifica - Modified



SCOOTER CINESI - CHINESE SCOOTERS

12 161 0620



50: Why
Modifica - Modified



12 161 0840



Scooter Cinesi 50 4T - Chinese Scooters 50 4T



12 161 0850



Scooter Cinesi 125 4T - Chinese Scooters 125 4T





APRILIA

12 163 0020 

50: Sr Www • Rally 98 • Ditech



12 163 0030 

50: Scarabeo



12 163 0300 

50: Sr Ditech 2T Factory Street
Motori Piaggio - Piaggio Engine



Fornito con distanziale e bul-
lone lungo da utilizzare per la
versione con motore Piaggio
With Piaggio engine assembly kit

GILERA

12 163 0360 

50: Scarabeo Street 2T
Motori Piaggio - Piaggio Engine



12 163 0380 

125-200 : Sportcity 4T 04-06



12 163 0050 

50: Typhoon- Storm



12 163 0060 

50: Stalker



12 163 0080 

50: Runner



12 163 0310 

50: Runner Sp Kat • FL • Poggiali Purejet





CAVALLETTI LATERALI
SIDE STANDS

GILERA

12 163 0420 

50: Nrg Power Dd • Purejet



HONDA

12 163 0280 

125-150: Sh 01-09



12 163 0510 

125-150: Sh 10>



KYMCO

12 163 0590 

50: Like 2T 09 • Like 4T 09 • 125: Like Lx 12
200: Like I 09 • Like Lx 12
(R.O. 0015059)



LML

12 163 0490 

125-150: Star 2T
Con ritorno automatico - *Automatic return*



12 163 0491 

125-150: Star 2T
Con ritorno automatico - *Automatic return*
Cromato - *Chromed*



MALAGUTI

12 163 0130 

50: F15



12 163 0550 

50: Dvd





MBK

12 163 0150 

50: Nitro • Ng



12 163 0160 

50: Ovetto



12 163 0170 

50: Booster • R • Ng



12 163 0200 

50: Booster • Track



12 163 0320 

50: Booster • Spirit Eu 2



12 163 0440 

50: Mach



PEUGEOT

12 163 0450 

50: Booster 4T



12 163 0220 

50: Speedfight • Trekker • Road • Vivacity



12 163 0221 

50: Speedfight • Trekker • Road • Vivacity X
Cromato - Chromed





CAVALLETTI LATERALI
SIDE STANDS

PEUGEOT

12 163 0460

50: Ludix
Ruota 14" - Wheel 14"



12 163 0500

50: Ludix
Ruota 12" - Wheel 12"



12 163 0610

50: Kisbee



PIAGGIO

12 163 0640

50: Speedfight 3



12 163 0050

50: Nrg • Ntt • Nrg Extreme



12 163 0060

50: Zip Sp



12 163 0070

50-125: Liberty
Zampa - Leg mm 245



12 163 0250

50: Zip 2T-4T • Fast Rider • Sfera • Quartz



12 163 0260

50: Vespa Et2





PIAGGIO

12 163 0310



50: Nrg Extreme



12 163 0330



50-125: Liberty
Zampa - Leg mm 290



12 163 0340



50-125-150: Liberty
Modello Poste - *Postal service Model*
(R.O. 646545)



12 163 0350



50: Liberty 2T - 4T 00



12 163 0410



250: X7 IE



12 163 0420



50: Nrg Power DD-Purejet



12 163 0470



50-90-125: Vespa • Primavera
Con ritorno automatico - *Automatic return*



12 163 0471



50-125: Vespa Pk



NEW

12 163 0480



50-125: Vespa Pk
Con ritorno automatico - *Automatic return*





CAVALLETTI LATERALI
SIDE STANDS

PIAGGIO

12 163 0481



50-90-125: Vespa • Primavera
Con ritorno automatico - *Automatic return*
Cromato - *Chromed*



12 163 0490



125-150-200: Vespa Px
Con ritorno automatico - *Automatic return*



12 163 0491



125-150-200: Vespa Px
Con ritorno automatico - *Automatic return*
Cromato - *Chromed*



12 163 0520



125: Vespa Gts
200: Vespa Gtv • Granturismo
250: Vespa Gt 60 • Grs



12 163 0521



125: Vespa Gts
200: Vespa Gtv • Granturismo
250: Vespa Gt 60 • Grs
Cromato - *Chromed*



12 163 0580



50: Vespa Lx 2T Touring 10-13 • Vespa Lx 4T 4V
Touring 10-13 • Vespa S 2T 07-12
Vespa S 4T 4V 08-12
125: Vespa Lx 4T Eu 3 Touring 10-11
Vespa Lxv le 4T 10-12
Vespa S 4T 3V le 12-13
Vespa S 4T le 09-11
150: Vespa Lx Touring 10-12
Vespa S 4T le 09-12
Vespa S 4T 08-09
(R.O. 64466R)



12 163 0620



50: Primavera 2T 13-14
125: Primavera Lx 4T 3V le 13
150: Primavera 4T 3V 13



12 163 0630



50: Primavera 2T 13-14
125: Primavera Lx 4T 3V le 13
150: Primavera 4T 3V 13
Cromato - *Chromed*



12 163 0650



50: Vespa Sprint 13-14





PIAGGIO

12 163 0651 

50: Vespa Sprint 13-14
Cromato - Chromed



12 163 0660 

125-250: Beverly Eu3 Mic 07
125: Beverly Eu3 Sport 07-08 • Beverly Eu3
07-08 • Beverly Rst 05-07 • Beverly Tourer Eu3
07-10 • 250: Beverly Cruiser 07-09 • Beverly
le Eu3 06-08 • Beverly Sport 06-08 • Beverly
Tourer Eu3 08-09 • Beverly 06-07
300: Beverly Tourer Eu3 09-10



12 163 0661 

125-250: Beverly Eu3 Mic 07
125: Beverly Eu3 Sport 07-08 • Beverly Eu3
07-08 • Beverly Rst 05-07 • Beverly Tourer Eu3
07-10 • 250: Beverly Cruiser 07-09 • Beverly
le Eu3 06-08 • Beverly Sport 06-08 • Beverly
Tourer Eu3 08-09
• Beverly 06-07
300: Beverly Tourer
• Eu3 09-10
Cromato - Chromed



SUZUKI

12 163 0670 

125: Beverly Rst 4T 4V le Eu3 10-13
300: Beverly Rst 4T 4V le Eu3 10-14
350: Beverly Rst 4T 4V le Eu3 Sport Touring
11-14



12 163 0671 

125: Beverly Rst 4T 4V le Eu3 10-13
300: Beverly Rst 4T 4V le Eu3 10-14
350: Beverly Rst 4T 4V le Eu3 Sport Touring
11-14
Cromato - Chromed



12 163 0530 

125-150: Sixteen



YAMAHA

12 163 0150 

50: Aerox



12 163 0160 

50: Neo's



12 163 0170 

50: Bws





CAVALLETTI LATERALI
SIDE STANDS

YAMAHA

12 163 0200 

50: Bump • Bws



12 163 0320 

50: Bws Original Eu 2



12 163 0440 

50: Jog R



12 163 0450 

50: Giggle 4T



12 163 0540 

125-150: Xenter



12 163 0600 

50: Neo's 4T



SCOOTER CINESI - CHINESE SCOOTERS

12 163 0560 

Scooter Cinesi 50 4T - *Chinese Scooters 50 4T*



12 163 0570 

Scooter Cinesi 125 4T - *Chinese Scooters 125 4T*





MODELLO MODEL	CC	ANNO YEAR	CODICE CODE
APRILIA			
Scarabeo	50	94-97	12 163 0030
Scarabeo Street 2T dal 05> (M. Piaggio)	50		12 163 0360
Sr www - Rally 98 - Ditech	50		12 163 0020
Sr-Ditech-2T-Factory-Street (Mot. Piaggio e Minar.)	50	00>	12 163 0300
Sport City 4T	125-200	04-06	12 163 0380
GILERA			
Runner	50		12 163 0080
Runner Sp	50	05>	12 163 0420
Runner-Purejet	50	05>	12 163 0420
Runner-Sp-Kat-FL Poggiali-Purejet	50	01>	12 163 0310
Stalker	50		12 163 0060
Typhoon - Storm	50		12 163 0050
Runner St	200	08-09	12 163 0420
HONDA			
Sh	125-150	01-09	12 163 0280
Sh	125-150	10>	12 163 0510
KYMCO			
Like 2T - 4T	50	09	12 163 0590
Like Lx	125	12	12 163 0590
Like I	200	09	12 163 0590
Like Lx	200	12	12 163 0590
LML			
Star 2T Ritorno automatico	125-150		12 163 0490
Star 2T Ritorno autom. (Cromato)	125-150		12 163 0491
MALAGUTI			
Dvd	50		12 163 0550
F15	50		12 163 0130
MBK			
Booster - R - Ng	50		12 163 0170
Booster - Track	50		12 163 0200
Booster Spirit Eu2	50	90- 04	12 163 0320
Booster X 4T	50		12 163 0450
Mach G	50	02-04	12 163 0440
Nitro - Ng	50	98>	12 163 0150
Ovetto	50		12 163 0160
PEUGEOT			
Kisbee	50		12 163 0610
Ludix ruote 12"	50		12 163 0500
Ludix-14"	50	04	12 163 0460
Speedfight - Trekker - Road - Vivacity	50		12 163 0220
Speedfight 3	50		12 163 0640
Speedfight-Trekker-Road-Vivacity (Crom.)	50		12 163 0221
PIAGGIO			
Liberty - (Zampa lunghezza 230 mm)	50-125		12 163 0070
Liberty - (Zampa lunghezza 285 mm)	50-125		12 163 0330
Liberty 2T/4T dal 2000>	50		12 163 0350
Nrg Extreme Lc - Mc3 - Purejet-Fly	50-125-150	00>	12 163 0310
Nrg Power DD-Purejet	50	05>	12 163 0420
Nrg-Ntt-Nrg Extreme	50		12 163 0050
Vespa Et2	50		12 163 0260
Vespa Et4-Lx	50-125-150		12 163 0260
Vespa Lx 2T Touring	50	10-13	12 163 0580
Vespa Lx 4T 4V Touring	50	10-13	12 163 0580

MODELLO MODEL	CC	ANNO YEAR	CODICE CODE
Vespa PK-Pks Ritorno automatico	50-125		12 163 0480
Vespa Primavera 2T	50	13-14	12 163 0620
Vespa Primavera 2T	50	13-14	12 163 0630
Vespa Primavera-Et3 Ritorno automatico	50-90-125		12 163 0470
Vespa S 2T	50	07-12	12 163 0580
Vespa S 4T 4V	50	08-12	12 163 0580
Zip 2-4T - Fast Rider - Sfera - Quartz	50		12 163 0250
Zip Sp	50	06-09	12 163 0060
Liberty Poste	125-150-200		12 163 0340
Skipper 4T	125-150		12 163 0050
Vespa Lx 4T Eu3 Touring	125	10-11	12 163 0580
Vespa Lxv ie 4T	125	10-12	12 163 0580
Vespa Primavera Lx 4T 3V ie	125	13	12 163 0620
Vespa Primavera Lx 4T 3V ie	125	13	12 163 0630
Vespa Px-Pxe Ritorno automatico (Cromato)	125-150		12 163 0491
Vespa Px-Pxe Ritorno automatico	125-150		12 163 0490
Vespa S 4T 3V ie	125	12-13	12 163 0580
Vespa S 4T ie	125	09-11	12 163 0580
Vespa Lx Touring	150	10-12	12 163 0580
Vespa Primavera 4T 3V	150	13	12 163 0620
Vespa Primavera 4T 3V	150	13	12 163 0630
Vespa S 4T	150	08-09	12 163 0580
Vespa S 4T ie	150	09-12	12 163 0580
Vespa Px-Pe	200		12 163 0490
Vespa Gtv (Cromato)	200-300		12 163 0521
Vespa Gtv	200-300		12 163 0520
X7 ie	250		12 163 0410
SUZUKI			
Sixteen	125-150		12 163 0530
YAMAHA			
Aerox	50		12 163 0150
Aerox (Cromato)	50		12 163 0151
Bump - Bw's	50	98-00	12 163 0200
Bw's	50		12 163 0170
Bw's Original Eu2	50	90-04	12 163 0320
Giggle 4T	50	08>	12 163 0450
Jog R	50		12 163 0440
Neo's 2T	50		12 163 0160
Neo's 4T	50		12 163 0600
Xenter	125-150		12 163 0540



CAVALLETTI ACCESSORI VARI

SIDE STAND ACCESSORIES

12 161 9010



KIT PERNO MOLLE CAVALLETTO CENTRALE
CENTRAL STAND SPRING AND PIVOT KIT

APRILIA: Scarabeo 50-80-100 • Sr 50 94-97

Rally Gulliver • Sonic Gp • Sr 125-150

BETA 50: Quadra • Ark



12 161 9030



KIT PERNO MOLLE CAVALLETTO CENTRALE
CENTRAL STAND SPRING AND PIVOT KIT

APRILIA 125-150: Scarabeo • Leonardo



12 161 9050



KIT PERNO MOLLE CAVALLETTO CENTRALE
CENTRAL STAND SPRING AND PIVOT KIT

PIAGGIO 125: Liberty 98/00

Et4 96-99 • Sfera Rst 95-97



12 161 9060



KIT PERNO MOLLE CAVALLETTO CENTRALE
CENTRAL STAND SPRING AND PIVOT KIT

GILERA 125-180: Runner • Vx • Vxr

PIAGGIO 50-125-150: Liberty 4T 00>

Et4 4T 99> • Skipper • Hexagon

125: Zip 4T



12 161 9070



KIT MOLLE CAVALLETTO CENTRALE
CENTRAL STAND SPRING SET

KYMCO 125-150: People



12 161 9080



KIT PERNO MOLLE CAVALLETTO CENTRALE
CENTRAL STAND SPRING AND PIVOT KIT

ITALJET 50: Pista

YAMAHA 50: Bump • Slider • Spy • Bw's
Original • Ng Bump

MBK 50: Booster 90-94 • Spirit Road • Ng
• Rocket • Booster Ng 00 • Stunt • Track



12 161 9150



KIT MOLLE CAVALLETTO CENTRALE
CENTRAL STAND SPRING SET

HONDA 125-150: Sh



12 161 9160



KIT MOLLE CAVALLETTO CENTRALE
CENTRAL STAND SPRING SET

HONDA 125-150: Chiocciola



12 161 9170



KIT PERNO MOLLE CAVALLETTO CENTRALE
CENTRAL STAND SPRING AND PIVOT KIT

PIAGGIO 50: Free • Liberty • Zip • Sfera

• Quartz • Et2

GILERA 50: Typhoon • Stalker • Runner



12 161 9180



KIT PERNO MOLLE CAVALLETTO CENTRALE
CENTRAL STAND SPRING AND PIVOT KIT

GILERA 50: Dna



12 161 9190



KIT PERNO MOLLE CAVALLETTO CENTRALE
CENTRAL STAND SPRING AND PIVOT KIT

Versione - Model 2005

GILERA 50: Easy Moving • Runner • Stalker-
Storm • Typhoon

PIAGGIO 50: Free FL • Nrg • Nrg Rst • Liberty
Ntt • Sfera Rst • Sfera Maquillage 2 VespaEt2

Iniezione • ZIP Tutti • **50-80:** Quartz-Sfera



12 161 9200



KIT PERNO MOLLE CAVALLETTO CENTRALE
CENTRAL STAND SPRING AND PIVOT KIT

KIMCO 125-150: Dink





12 189 0010 

MOLLA CAVALLETTO - STAND SPRING
MBK 50: Booster



12 189 0020 

MOLLA CAVALLETTO - STAND SPRING
PIAGGIO GILERA 50: Scooter • Sfera • Liberty
125: Vespa Et4 95-00



12 189 0030 

MOLLA CAVALLETTO - STAND SPRING
PIAGGIO 50-90-125: Vespa Primavera Et3
(R.O. 277269)



12 189 0040 

MOLLA CAVALLETTO - STAND SPRING
PIAGGIO 50-125: Vespa Pk • Pk XL • Rush-FL
(R.O. 2216255)



12 189 0050 

MOLLA CAVALLETTO - STAND SPRING
PIAGGIO 125-150-200: Vespa Px • Pe
(R.O. 176169)



12 189 0060 

KIT MOLLE CAVALLETTO CENTRALE
CENTRAL STAND SPRING SET
APRILIA 50: Sr



12 189 0080 

MOLLA CAVALLETTO - STAND SPRING
PIAGGIO 125-150-200: Cosa VLR1T-VLR-VSX2
(R.O. 257430)



12 189 0090 

MOLLA CAVALLETTO - STAND SPRING
PIAGGIO 125-150: Vespa T5-Px 11 • VNX5T
(R.O. 176444)



12 189 0100 

MOLLE CAVALLETTO - STAND SPRINGS
PIAGGIO 50: Ciao
(R.O. 139136-7)



12 189 0110 

MOLLE CAVALLETTO - STAND SPRINGS
PIAGGIO 50: Si
(R.O. 164166-7)





CAVALLETTI ACCESSORI VARI

SIDE STAND ACCESSORIES

12 183 0050



GOMMINO CAVALLETTO CENTRALE CENTRAL STAND RUBBER

KYMCO 50: Agility 4T R12 07-08 • 4T R16 09 • Rs 09 • Rs Naked 2T 10 • Dink 4T 07 • Like 2-4T 09 • People S 4T 06-08 • Sento 08 • Super 8 07
125: Dink Eu 3 06-07 • Downtown 09 • People S 05 • People S Dd Eu 3 07-08 • **150:** Agility R16 08
200: Agility I R16 10 • Dink Eu 3 I 06-07 • People S 05 • People S I 07 • Like I 09 • **250:** People S 06 • S I 07 • X Citing 05 • I 06-07 • **300:** Downtown I 09 • Abs 10 • People S I 08 • X Citing I 08 • I R 08 • I R 09 • **500:** X Citing R 09 • X Citing 05 • I 06-08 • R 07-08



12 183 0630



TAMPONE CAVALLETTO CENTRAL STAND BUFFER

PIAGGIO 125-150-200: Vespa Px Arcobaleno-T5 VNX-VLX-VSX-VNX5T-VLR1T-VLR-VSR1-VNX2-VLX2-VSX2
(R.O. 174773)



12 183 0140



GOMMINI CAVALLETTO - RUBBER PADS

PIAGGIO 50-90-125: Vespa Et3 • Primavera Confez. Industriale 10 Cp. - *Packaging 10 pcs*
(R.O. 135387/8)



12 183 0150



GOMMINI CAVALLETTO - RUBBER PADS

PIAGGIO 50-125: Vespa Pk • Pk XL • Rush • N • FL
125-150-200: Px • Pe
(R.O. 176166)



12 183 0159



GOMMINI CAVALLETTO - RUBBER PADS

PIAGGIO 50-125: Vespa Pk • Pk XL • Rush • N • FL
125-150-200: Px • Pe
Confez. Industriale 100 Cp. - *Packaging 100 pcs*
(R.O. 176166)



12 183 0540



GOMMINI CAVALLETTO - RUBBER PADS

PIAGGIO 150: Vespa Sprint • GL Sprint Veloce • Super
180-200: Rally
(R.O. 54146-7)



12 161 9130



COPPIA PIASTRINE CAVALLETTO CENTRALE CENTRAL STAND BRACKETS

PIAGGIO 50-90-125: Vespa Et3 • Primavera
(R.O. 135390/I)



12 161 9140



COPPIA PIASTRINE CAVALLETTO CENTRALE CENTRAL STAND BRACKETS

PIAGGIO 125-150-200: Vespa Px • Pe
(R.O. 176167/68)



12 161 9210



COPPIA PIASTRINE CAVALLETTO CENTRALE CENTRAL STAND BRACKETS

PIAGGIO 150: Vespa GL Sprint
(R.O. 59188/9)



12 161 9220



COPPIA PIASTRINE CAVALLETTO CENTRALE CENTRAL STAND BRACKETS

PIAGGIO 50: Vespa 1° Serie



12 161 9230



COPPIA PIASTRINE CAVALLETTO CENTRALE CENTRAL STAND BRACKETS

PIAGGIO 150: Vespa Gs



12 161 9250



COPPIA PIASTRINE CAVALLETTO CENTRALE CENTRAL STAND BRACKETS

PIAGGIO 50-125: Vespa Pk XL-VSX1T V5X2T-V5S1T-VMX1T-VMX5T-VMX6T
(R.O. 233120-216252)





14 270 0360 

SUPPORTO CAVALLETTO - STAND SUPPORTS
APRILIA - YAMAHA
mm 6



14 270 0370 

SUPPORTO CAVALLETTO - STAND SUPPORTS
DUCATI - HONDA - SUZUKI
mm 8

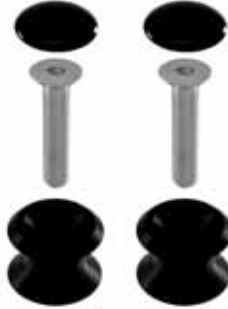

14 270 0380 

SUPPORTO CAVALLETTO - STAND SUPPORTS
KAWASAKI
mm 10



14 270 0361 

SUPPORTO CAVALLETTO - STAND SUPPORTS
APRILIA - YAMAHA
mm 6



14 270 0371 

SUPPORTO CAVALLETTO - STAND SUPPORTS
DUCATI - HONDA - SUZUKI
mm 8



14 270 0381 

SUPPORTO CAVALLETTO - STAND SUPPORTS
KAWASAKI
mm 10





RMS
YOUR BEST PARTNER

▶ AMMORTIZZATORI

SHOCK ABSORBERS

▶  FORSA®



AMMORTIZZATORI SCOOTER

SCOOTER SHOCK ABSORBERS

Codice RMS RMS Code	Modello - Model	CC	Da - From	A - To	Rif. Originale Oem number	Ant -Front Post-Rear
APRILIA						
20 455 0052	Rally	50	95	03	AP8203627	Post-Rear
20 455 0052	Rally	50	95	03	AP8203750	Post-Rear
20 455 0052	Rally Liquid Cooled	50	96	99	AP8203750	Post-Rear
20 455 0031	Scarabeo	50	93	97	AP8203631	Post-Rear
20 455 0041	Scarabeo	50	98	98	AP8203814	Post-Rear
20 455 0041	Scarabeo	50	98	98	AP8203874	Post-Rear
20 455 0041	Scarabeo	50	98	98	AP8203932	Post-Rear
20 455 0041	Scarabeo	50	99	99	AP8203932	Post-Rear
20 455 0041	Scarabeo	50	99	99	AP8203946	Post-Rear
20 455 0041	Scarabeo	50	00	05	AP8203946	Post-Rear
20 455 0862	Scarabeo 2T Net	50	09	09	AP8223120	Post-Rear
20 455 0642	Scarabeo 4T	50	02	06	AP8203997	Post-Rear
20 455 0642	Scarabeo 4T	50	02	06	AP8223064	Post-Rear
20 455 0642	Scarabeo 4T 4V	50	10	12	666265	Post-Rear
20 455 0642	Scarabeo 4T 4V	50	14	14	668008	Post-Rear
20 455 0642	Scarabeo 4T 4V Net	50	09	09	AP8223064	Post-Rear
20 455 0642	Scarabeo 4T 4V Net	50	10	10	666265	Post-Rear
20 455 0642	Scarabeo 4T Restyling Eu3	50	06	09	AP8223064	Post-Rear
20 455 0642	Scarabeo Quattro	50	09	09	AP8223064	Post-Rear
20 455 0862	Scarabeo Street	50	05	06	AP8223120	Post-Rear
20 455 0862	Scarabeo Street 2T Restyl.	50	06	09	AP8223120	Post-Rear
20 455 0452	Sport City One 2T	50	08	11	856441	Post-Rear
20 455 0452	Sport City One 4T	50	08	10	856441	Post-Rear
20 455 0031	Sr	50	93	93	AP8203631	Post-Rear
20 455 0031	Sr	50	94	96	AP8203631	Post-Rear
20 455 0031	Sr	50	94	96	AP8203667	Post-Rear
20 455 0472	Sr Iniezione E Carburat.	50	14	14	668009	Post-Rear
20 455 0031	Sr Liquid Cooled	50	94	96	AP8203631	Post-Rear
20 455 0031	Sr Liquid Cooled	50	94	96	AP8203667	Post-Rear
20 455 0452	Sr Motard 2T	50	12	14	856441	Post-Rear
20 455 0472	Sr R Factory Ie E Carburat.	50	10	14	AP8223036	Post-Rear
20 455 0472	Sr R, R Factory	50	04	09	AP8223036	Post-Rear
20 455 0472	Sr Street	50	03	12	AP8223036	Post-Rear
20 455 0472	Sr Street	50	03	12	AP8223059	Post-Rear
20 455 0642	Scarabeo 4T	100	01	05	AP8203997	Post-Rear
20 455 0642	Scarabeo 4T	100	01	05	AP8223064	Post-Rear
20 455 0642	Scarabeo 4T	100	10	12	666265	Post-Rear
20 455 0642	Scarabeo 4T	100	14	14	668008	Post-Rear
20 455 0642	Scarabeo 4T Net	100	09	09	AP8223064	Post-Rear
20 455 0642	Scarabeo 4T Net Eu3	100	10	10	666265	Post-Rear
20 455 0642	Scarabeo 4T Restyling	100	06	09	AP8223064	Post-Rear
20 455 0041	Scarabeo Mot. Minarelli	100	00	00	AP8203946	Post-Rear
20 455 0041	Scarabeo Motore Yamaha	100	00	00	AP8203946	Post-Rear
20 455 0442	Scarabeo Ie Light	125	09	10	JC62100X92000	Post-Rear
20 455 0442	Scarabeo Ie Light	125	11	12	JC62100X92000	Post-Rear
20 455 0442	Scarabeo Light	125	07	08	JC62100X92000	Post-Rear
20 455 0602	Scarabeo Motore Rotax	125	99	04	AP8163188	Post-Rear
20 455 0462	Sport City	125	04	06	AP8163551	Post-Rear
20 455 0463	Sport City	125	04	06	AP8163551	Post-Rear
20 455 0462	Sport City Cube	125	08	10	AP8163551	Post-Rear
20 455 0463	Sport City Cube	125	08	10	AP8163551	Post-Rear
20 455 0462	Sport City Eu3	125	06	08	AP8163551	Post-Rear
20 455 0463	Sport City Eu3	125	06	08	AP8163551	Post-Rear
20 455 0462	Sport City Street	125	12	12	AP8163551	Post-Rear
20 455 0463	Sport City Street	125	12	12	AP8163551	Post-Rear
20 455 0752	Sr Max	125	11	14	647524	Post-Rear
20 455 0753	Sr Max	125	11	14	647524	Post-Rear
20 455 0442	Scarabeo Ie Light	200	11	12	JC62100X92000	Post-Rear
20 455 0462	Scarabeo Light	250	06	08	AP8163551	Post-Rear
20 455 0463	Scarabeo Light	250	06	08	AP8163551	Post-Rear
20 455 0462	Sport City Cube	250	08	12	AP8163551	Post-Rear
20 455 0463	Sport City Cube	250	08	12	AP8163551	Post-Rear
20 455 0462	Scarabeo Light	300	09	10	AP8163551	Post-Rear

Codice RMS RMS Code	Modello - Model	CC	Da - From	A - To	Rif. Originale Oem number	Ant -Front Post-Rear
20 455 0463	Scarabeo Light	300	09	10	AP8163551	Post-Rear
20 455 0462	Sport City Street	300	12	12	AP8163551	Post-Rear
20 455 0463	Sport City Street	300	12	12	AP8163551	Post-Rear
20 455 0752	Sr Max	300	11	14	647524	Post-Rear
20 455 0753	Sr Max	300	11	14	647524	Post-Rear
20 455 0732	Scarabeo Light	400	06	08	AP8163503	Post-Rear
20 455 0742	Scarabeo	500	03	06	AP8163328	Post-Rear
20 455 0732	Scarabeo Light	500	06	08	AP8163503	Post-Rear
BENELLI						
20 455 0031	491 Sport	50	98	99		Post-Rear
20 455 0031	491 St	50				Post-Rear
20 455 0031	491 ST Morini	50				Post-Rear
GILERA						
20 455 0061	Easy Moving	50	95	96	2729604	Post-Rear
20 455 0752	Nexus Eu3	125	07	08	647524	Post-Rear
20 455 0753	Nexus Eu3	125	07	08	647524	Post-Rear
20 455 0752	Nexus Eu3 Ie	125	08	08	647524	Post-Rear
20 455 0753	Nexus Eu3 Ie	125	08	08	647524	Post-Rear
20 455 0752	Nexus Eu3 Ie	125	09	10	647524	Post-Rear
20 455 0753	Nexus Eu3 Ie	125	09	10	647524	Post-Rear
20 455 0752	Nexus Eu3	250	06	06	647524	Post-Rear
20 455 0753	Nexus Eu3	250	06	06	647524	Post-Rear
20 455 0752	Nexus Eu3	250	07	07	647524	Post-Rear
20 455 0753	Nexus Eu3	250	07	07	647524	Post-Rear
20 455 0752	Nexus Sp Eu3	250	06	07	647524	Post-Rear
20 455 0753	Nexus Sp Eu3	250	06	07	647524	Post-Rear
20 455 0752	Nexus Eu3	300	08	08	647524	Post-Rear
20 455 0753	Nexus Eu3	300	08	08	647524	Post-Rear
20 455 0752	Nexus Eu3	300	09	11	647524	Post-Rear
20 455 0753	Nexus Eu3	300	09	11	647524	Post-Rear
HONDA						
20 455 0061	Gp Dio	50				Post-Rear
20 455 0031	Sky	50	97	04		Post-Rear
20 455 0061	Vision Met-In	50				Post-Rear
20 455 0061	Vision Prima Serie	50				Post-Rear
20 455 0311	Dylan	125	01	06	52400-KTF-641	Post-Rear
20 455 0313	Dylan	125	01	06	52400-KTF-641	Post-Rear
20 455 0311	Nes	125	00	06	52400-KTF-641	Post-Rear
20 455 0313	Nes	125	00	06	52400-KTF-641	Post-Rear
20 455 0712	Pcx	125	10	15	52400-KWN-711	Post-Rear
20 455 0311	Sh	125	01	04	52400-KTF-641	Post-Rear
20 455 0313	Sh	125	01	04	52400-KTF-641	Post-Rear
20 455 0311	Sh I	125	05	12	52400-KTF-641	Post-Rear
20 455 0312	Sh I	125	05	12	52400-KTF-641	Post-Rear
20 455 0313	Sh I	125	05	12	52400-KTF-641	Post-Rear
20 455 0722	Sh I	125	13	16	52400-K01-901	Post-Rear
20 455 0852	Sh Mode	125	13	16	52400-K29-901	Post-Rear
20 455 0311	Dylan	150	01	06	52400-KTF-641	Post-Rear
20 455 0313	Dylan	150	01	06	52400-KTF-641	Post-Rear
20 455 0311	Nes	150	00	06	52400-KTF-641	Post-Rear
20 455 0313	Nes	150	00	06	52400-KTF-641	Post-Rear
20 455 0712	Pcx	150	10	15	52400-KWN-711	Post-Rear
20 455 0311	Sh	150	01	04	52400-KTF-641	Post-Rear
20 455 0313	Sh	150	01	04	52400-KTF-641	Post-Rear
20 455 0313	Sh I	150	05	12	52400-KTF-641	Post-Rear
20 455 0722	Sh I	150	13	16	52400-KTF-641	Post-Rear
20 455 0701	Forza	250	05	07	52400-KTW-903	Post-Rear
20 455 0703	Forza	250	05	07	52400-KTW-903	Post-Rear
20 455 0701	Jazz	250	01	05	52400-KTW-903	Post-Rear
20 455 0703	Jazz	250	01	05	52400-KTW-903	Post-Rear
20 455 0701	Jazz	250	01	05	52400-KTW-903	Post-Rear
20 455 0703	Sh	300	07	15	52400-KTW-903	Post-Rear



Codice RMS RMS Code	Modello - Model	CC	Da - From	A - To	Rif. Originale Oem number	Ant-Front Post-Rear	Codice RMS RMS Code	Modello - Model	CC	Da - From	A - To	Rif. Originale Oem number	Ant-Front Post-Rear
KYMCO							MALAGUTI						
20 455 0592	Agility 4T Carry	50	11	11	00166107	Post-Rear	20 455 0132	Centro Base	50	93	94	1003100	Post-Rear
20 455 0592	Agility 4T R12	50	07	08	00166107	Post-Rear	20 455 0132	Centro SL	50	94	98	1003100	Post-Rear
20 455 0582	Agility 4T R16	50	08	08	00152232	Post-Rear	20 455 0132	Centro SL Kat	50	99	00	1003100	Post-Rear
20 455 0582	Agility 4T R16	50	09	09	00152232	Post-Rear	20 455 0122	F10 Ac	50	08	08	1004603	Post-Rear
20 455 0582	Agility 4T R16	50	12	12	00152232	Post-Rear	20 455 0122	F10 Ac Eco	50	09	10	1004603	Post-Rear
20 455 0592	Agility R12	50	05	05	00166107	Post-Rear	20 455 0122	F10 Jet Line	50	92	98	1004603	Post-Rear
20 455 0592	Agility R12 Ecs	50	16	16	00166107	Post-Rear	20 455 0122	F10 Kat	50	99	00	1004603	Post-Rear
20 455 0592	Agility Rs	50	09	09	00166107	Post-Rear	20 455 0122	F10 Restyling Eu1	50	01	02	1004603	Post-Rear
20 455 0522	Agility R16	125	08	08	00152239	Post-Rear	20 455 0122	F10 Restyling Eu2-2.3	50	03	04	1004603	Post-Rear
20 455 0523	Agility R16	125	08	08	00152239	Post-Rear	20 455 0122	F10 Restyling Eu2	50	02	03	1004603	Post-Rear
20 455 0522	Agility R16	125	09	09	00152239	Post-Rear	20 455 0122	F10 Restyling Eu2	50	06	06	1004603	Post-Rear
20 455 0523	Agility R16	125	09	09	00152239	Post-Rear	20 455 0142	F12 Aria Restyling Eu2	50	06	06	1003408	Post-Rear
20 455 0522	Agility R16	125	12	12	00152371	Post-Rear	20 455 0142	F12 Lc Restyling Eu2	50	06	06	1003408	Post-Rear
20 455 0523	Agility R16	125	12	12	00152371	Post-Rear	20 455 0142	F12 Phantom	50	94	98	1003401	Post-Rear
20 455 0572	Dink 125 Eu3	125	06	07	00165937	Post-Rear	20 455 0142	F12 Phantom	50	94	98	1003411	Post-Rear
20 455 0372	Dink Classic	125	02	02	00165936	Post-Rear	20 455 0142	F12 Phantom Eu1	50	99	00	1003401	Post-Rear
20 455 0372	Dink Classic Eu2	125	03	03	00165936	Post-Rear	20 455 0142	F12 Phantom Eu1	50	99	00	1003408	Post-Rear
20 455 0762	K-Xct I	125	12	14	00152380N1	Post-Rear	20 455 0142	F12 Phantom Eu1	50	99	00	1003411	Post-Rear
20 455 0763	K-Xct I	125	12	14	00152380N1	Post-Rear	20 455 0142	F12 Phantom Lc	50	94	98	1003401	Post-Rear
20 455 0542	People S Dd Eu3	125	07	08	00166374NE	Post-Rear	20 455 0142	F12 Phantom Lc	50	94	98	1003411	Post-Rear
20 455 0522	Agility R16	150	08	08	00152239	Post-Rear	20 455 0142	F12 Phantom Lc Eu1	50	99	00	1003408	Post-Rear
20 455 0523	Agility R16	150	08	08	00152239	Post-Rear	20 455 0142	F12 Phantom Lc Restyling Eu1	50	01	02	1003408	Post-Rear
20 455 0522	Agility R16	150	09	09	00152239	Post-Rear	20 455 0142	F12 Phantom Lc Restyl. Eu2	50	02	02	1003408	Post-Rear
20 455 0523	Agility R16	150	09	09	00152239	Post-Rear	20 455 0142	F12 Phantom Lc Rest. Eu2-2.3	50	03	04	1003408	Post-Rear
20 455 0372	Dink Classic	150	02	02	00165936	Post-Rear	20 455 0142	F12 Phantom Lc Twin Disks	50	98	98	1003408	Post-Rear
20 455 0372	Dink Classic Eu2	150	03	03	00165936	Post-Rear	20 455 0142	F12 Phantom Restyling Eu1	50	01	02	1003408	Post-Rear
20 455 0522	Agility 200l R16	200	10	10	00152274	Post-Rear	20 455 0142	F12 Phantom Restyling Eu2	50	02	02	1003408	Post-Rear
20 455 0523	Agility 200l R16	200	10	10	00152274	Post-Rear	20 455 0142	F12 Phantom Restyling Eu2-2.3	50			1003408	Post-Rear
20 455 0522	Agility R16	200	12	12	00152371	Post-Rear	20 455 0122	Yesterday - Yesterday Euro	50	97	00	1004603	Post-Rear
20 455 0523	Agility R16	200	12	12	00152371	Post-Rear	MBK						
20 455 0372	Dink Classic	200	04	04	00165936	Post-Rear	20 455 0161	Cw Booster	50	01	02	4VUF22100000	Post-Rear
20 455 0572	Dink Eu3i	200	06	07	00165937	Post-Rear	20 455 0161	Cw Booster Spirit	50	96	98	4VUF22100000	Post-Rear
20 455 0532	Downtown I	200	10	10	00152254	Post-Rear	20 455 0161	Cw Booster Spirit (Ita)	50	99	99	4VUF22100000	Post-Rear
20 455 0533	Downtown I	200	10	10	00152254	Post-Rear	20 455 0161	Cw Booster Spirit (Ita)	50	00	00	4VUF22100000	Post-Rear
20 455 0562	People Gti	200	10	10	00152277	Post-Rear	20 455 0161	Cw Booster Spirit Eu2	50	02	02	4VUF22100000	Post-Rear
20 455 0562	People Gti	200	14	14	00152277	Post-Rear	20 455 0161	Cw Booster Spirit Eu2	50	03	03	4VUF22100000	Post-Rear
20 455 0542	People S 200l	200	07	07	00166374NE	Post-Rear	20 455 0181	Yn R Ovetto (Che-Ita)	50	97	01	5KKF22100033	Post-Rear
20 455 0552	People S 250l	250	07	07	00166375NE	Post-Rear	20 455 0181	Yn R Ovetto Eu1	50	02	04	5KKF22100033	Post-Rear
20 455 0532	Downtown 300l	300	09	09	00152254	Post-Rear	20 455 0181	Yn R Ovetto Eu2	50	02	03	5KKF22100033	Post-Rear
20 455 0533	Downtown 300l	300	09	09	00152254	Post-Rear	20 455 0181	Yn Ovetto	100	00	02	5KKF22100033	Post-Rear
20 455 0562	People Gti Abs E4	300	16	16	00152277	Post-Rear	PEUGEOT						
20 455 0562	People Gti Abs	300	12	12	00152277	Post-Rear	20 455 0191	Buxy	50	94	97		Post-Rear
20 455 0562	People Gti Abs	300	14	14	00152277	Post-Rear	20 455 0192	Buxy	50	94	97		Post-Rear
20 455 0562	People Gti	300	10	10	00152277	Post-Rear	20 455 0191	Sc Metropolis Lm-Sxlm	50	91	91		Post-Rear
20 455 0562	People Gti	300	11	11	00152277	Post-Rear	20 455 0192	Sc Metropolis Lm-Sxlm	50	91	91		Post-Rear
20 455 0562	People Gti	300	14	14	00152277	Post-Rear	20 455 0191	Speedake	50	94	97		Post-Rear
20 455 0532	Downtown Abs	300	10	10	00152254	Post-Rear	20 455 0192	Speedake	50	94	97		Post-Rear
20 455 0533	Downtown Abs	300	10	10	00152254	Post-Rear	20 455 0191	St Rapido	50	85	93		Post-Rear
20 455 0532	Downtown Abs I	300	11	16	00152254	Post-Rear	20 455 0192	St Rapido	50	85	93		Post-Rear
20 455 0533	Downtown Abs I	300	11	16	00152254	Post-Rear	20 455 0812	Geo	125			770375	Post-Rear
20 455 0532	Downtown I	300	11	11	00152254	Post-Rear	20 455 0812	Geo C	125			770375	Post-Rear
20 455 0533	Downtown I	300	11	11	00152254	Post-Rear	20 455 0812	Geo E	125			770375	Post-Rear
20 455 0762	K-Xct I	300	12	12	00152380N1	Post-Rear	20 455 0812	Geo Es	125			770375	Post-Rear
20 455 0763	K-Xct I	300	12	12	00152380N1	Post-Rear	20 455 0812	Geo Ex	125			770375	Post-Rear
20 455 0762	K-Xct I Abs	300	14	14	00152380N1	Post-Rear	20 455 0812	Geo Exn	125			770375	Post-Rear
20 455 0763	K-Xct I Abs	300	14	14	00152380N1	Post-Rear	20 455 0812	Geo S	125			770375	Post-Rear
20 455 0552	People S 300l	300	08	08	00166375NE	Post-Rear	20 455 0812	Geo Sc	125			770375	Post-Rear
20 455 0832	X Citing 300l	300	08	08	00152234	Post-Rear	20 455 0812	Geo X	125			770375	Post-Rear
20 455 0832	X Citing 300l R	300	08	08	00152234	Post-Rear	20 455 0822	Geo	250			769092	Post-Rear
20 455 0832	X Citing 300l R	300	09	09	00152234	Post-Rear	20 455 0822	Geo C	250			769092	Post-Rear
20 455 0842	X Citing 500 R	500	09	09	00166176	Post-Rear	20 455 0822	Geo S	250			769092	Post-Rear
20 455 0842	X Citing 500l	500	08	08	00166176	Post-Rear	20 455 0822	Geo Sc	250			769092	Post-Rear
20 455 0842	X Citing 500l R	500	07	08	00166176	Post-Rear	20 455 0822	Geo X	250			769092	Post-Rear



AMMORTIZZATORI SCOOTER

SCOOTER SHOCK ABSORBERS

Codice RMS RMS Code	Modello - Model	CC	Da - From	A - To	Rif. Originale Oem number	Ant-Front Post-Rear
20 455 0822	Geo	300			769092	Post-Rear
20 455 0822	Geo St	300			769092	Post-Rear
20 455 0822	Geo X	300			769092	Post-Rear
20 455 0822	Geo Xn	300			769092	Post-Rear
PIAGGIO						
20 455 0882	Liberty 4T	50	00	02	56063R	Post-Rear
20 455 0882	Liberty 4T	50	05	08	648088	Post-Rear
20 455 0882	Liberty 4T Rst	50	04	04	56063R	Post-Rear
20 455 0882	Liberty 4T Sport	50	06	06	600497	Post-Rear
20 455 0882	Liberty 4T Sport	50	07	08	648088	Post-Rear
20 455 0882	Liberty Moc 4T & Elle	50	09	16	648088	Post-Rear
20 455 0352	Liberty Ptt Eu2	50	04	05	563701	Post-Rear
20 455 0221	Sfera Rst	50	95	97	564110	Post-Rear
20 458 4212	Sfera Rst	50	95	97	598922	Ant-Front
20 458 4212	Vespa Et2	50	97	05	598922	Ant-Front
20 458 4212	Vespa Et2 Iniezione	50	97	00	598922	Ant-Front
20 455 0081	Vespa Et2 Iniezione	50	97	00	600488	Post-Rear
20 458 4212	Vespa Et4	50	00	05	598922	Ant-Front
20 455 0081	Vespa Et4	50	00	05	600488	Post-Rear
20 458 4371	Vespa Lx 2T	50	05	08	601997	Ant-Front
20 458 4373	Vespa Lx 2T	50	05	08	601997	Ant-Front
20 458 4371	Vespa Lx 2T	50	05	08	601997	Post-Rear
20 458 4373	Vespa Lx 2T	50	05	08	601997	Post-Rear
20 455 0081	Vespa Lx 2T	50	05	08	667967	Post-Rear
20 458 4371	Vespa Lx 2T	50	09	13	601997	Ant-Front
20 458 4373	Vespa Lx 2T	50	09	13	601997	Ant-Front
20 458 4371	Vespa Lx 2T	50	09	13	601997	Post-Rear
20 458 4373	Vespa Lx 2T	50	09	13	601997	Post-Rear
20 455 0081	Vespa Lx 2T	50	09	13	667967	Post-Rear
20 458 4371	Vespa Lx 2T Touring & 30Km	50	10	13	601997	Ant-Front
20 458 4373	Vespa Lx 2T Touring & 30Km	50	10	13	601997	Ant-Front
20 458 4371	Vespa Lx 2T Touring & 30Km	50	10	13	601997	Post-Rear
20 458 4373	Vespa Lx 2T Touring & 30Km	50	10	13	601997	Post-Rear
20 455 0081	Vespa Lx 2T Touring & 30Km	50	10	13	667967	Post-Rear
20 455 0081	Vespa Lx 4T	50	05	09	600488	Post-Rear
20 458 4371	Vespa Lx 4T	50	05	09	56266R	Ant-Front
20 458 4373	Vespa Lx 4T	50	05	09	56266R	Ant-Front
20 458 4371	Vespa Lx 4T	50	05	09	56266R	Post-Rear
20 458 4373	Vespa Lx 4T	50	05	09	56266R	Post-Rear
20 458 4371	Vespa Lx 4T-4V	50	09	13	601997	Ant-Front
20 458 4373	Vespa Lx 4T-4V	50	09	13	601997	Ant-Front
20 458 4371	Vespa Lx 4T-4V	50	09	13	601997	Post-Rear
20 458 4373	Vespa Lx 4T-4V	50	09	13	601997	Post-Rear
20 455 0081	Vespa Lx 4T-4V	50	09	13	667967	Post-Rear
20 458 4371	Vespa Lx 4T-4V Touring	50	10	13	601997	Ant-Front
20 458 4373	Vespa Lx 4T-4V Touring	50	10	13	601997	Ant-Front
20 458 4371	Vespa Lx 4T-4V Touring	50	10	13	601997	Post-Rear
20 458 4373	Vespa Lx 4T-4V Touring	50	10	13	601997	Post-Rear
20 455 0081	Vespa Lx 4T-4V Touring	50	10	13	667967	Post-Rear
20 455 0081	Vespa Lxv 2T	50	06	09	667967	Post-Rear
20 455 0081	Vespa Lxv 2T Navy	50	08	08	667967	Post-Rear
20 455 0932	Vespa Primavera 2T	50	13	17	668480	Post-Rear
20 458 5112	Vespa Primavera 2T	50	13	17	1C000837R	Ant-Front
20 455 0932	V. Primavera 4T 2V 25 Km/H	50	14	17	668480	Post-Rear
20 458 5112	V. Primavera 4T 2V 25 Km/H	50	14	17	1C000837R	Ant-Front
20 455 0932	Vespa Primavera 4T-4V	50	13	17	668480	Post-Rear
20 458 5112	Vespa Primavera 4T-4V	50	13	17	1C000837R	Ant-Front
20 455 0932	Vespa Sprint 2T 2V	50	14	17	668480	Post-Rear
20 455 0932	V. Sprint 4T 2V 25 Km/H	50	14	17	668480	Post-Rear
20 455 0932	Vespa Sprint 4T 4V	50	14	17	668480	Post-Rear
20 455 0061	Zip	50	92	93	2729604	Post-Rear
20 455 0062	Zip	50	92	93	2729604	Post-Rear
20 455 0061	Zip	50	95	96	2729604	Post-Rear
20 455 0062	Zip	50	95	96	2729604	Post-Rear

Codice RMS RMS Code	Modello - Model	CC	Da - From	A - To	Rif. Originale Oem number	Ant-Front Post-Rear
20 455 0061	Zip Fast Raider	50	93	94	2729604	Post-Rear
20 455 0062	Zip Fast Raider	50	93	94	2729604	Post-Rear
20 458 4212	Zip Sp	50	01	04	598922	Ant-Front
20 458 4212	Zip Sp Eu2	50	06	13	598922	Ant-Front
20 455 0362	Beverly	125	01	03	56138R	Post-Rear
20 455 0682	Beverly	125	01	03	56138R	Post-Rear
20 455 0683	Beverly	125	01	03	56138R	Post-Rear
20 455 0362	Beverly Eu3	125	07	08	601014	Post-Rear
20 455 0682	Beverly Eu3	125	07	08	601014	Post-Rear
20 455 0683	Beverly Eu3	125	07	08	601014	Post-Rear
20 455 0362	Beverly Eu3 Mic	125	07	07	56174R	Post-Rear
20 455 0682	Beverly Eu3 Mic	125	07	07	56174R	Post-Rear
20 455 0683	Beverly Eu3 Mic	125	07	07	56174R	Post-Rear
20 455 0362	Beverly Eu3 Sport	125	07	08	601014	Post-Rear
20 455 0682	Beverly Eu3 Sport	125	07	08	601014	Post-Rear
20 455 0683	Beverly Eu3 Sport	125	07	08	601014	Post-Rear
20 455 0362	Beverly Rst	125	04	05	56138R	Post-Rear
20 455 0682	Beverly Rst	125	04	05	56138R	Post-Rear
20 455 0683	Beverly Rst	125	04	05	56138R	Post-Rear
20 455 0362	Beverly Rst	125	05	07	601014	Post-Rear
20 455 0682	Beverly Rst	125	05	07	601014	Post-Rear
20 455 0683	Beverly Rst	125	05	07	601014	Post-Rear
20 455 0662	Beverly Rst 4T 4V le Eu3	125	10	15	58518R	Post-Rear
20 455 0663	Beverly Rst 4T 4V le Eu3	125	10	15	58518R	Post-Rear
20 455 0362	Beverly Tourer Eu3	125	07	10	601014	Post-Rear
20 455 0682	Beverly Tourer Eu3	125	07	10	601014	Post-Rear
20 455 0683	Beverly Tourer Eu3	125	07	10	601014	Post-Rear
20 455 0672	Carnaby	125	07	10	649423	Post-Rear
20 455 0352	Liberty	125	98	00	563701	Post-Rear
20 455 0352	Liberty	125	98	00	564949	Post-Rear
20 455 0352	Liberty	125	98	00	564949	Post-Rear
20 455 0281	Liberty	125	01	02	56232R	Post-Rear
20 455 0281	Liberty 4T	125	06	07	56232R	Post-Rear
20 455 0281	Liberty 4T 2V Eu3	125	09	12	56232R	Post-Rear
20 455 0281	Liberty 4T 2V le Ptt - Ita	125	12	13	56232R	Post-Rear
20 455 0281	Liberty 4T Eu3	125	06	08	56232R	Post-Rear
20 455 0281	Liberty 4T Eu3 Deliv.-Single	125	07	15	56232R	Post-Rear
20 455 0281	Liberty 4T Eu3 Deliv.-Tnt-Nexive	125	08	15	56232R	Post-Rear
20 455 0281	Liberty 4T Sport Eu3	125	06	08	56232R	Post-Rear
20 455 0281	Liberty Rst	125	04	05	56134R	Post-Rear
20 455 0281	Liberty Rst Ptt	125	05	11	56232R	Post-Rear
20 455 0281	Liberty Sport	125	06	06	56232R	Post-Rear
20 455 0221	Sfera	125	95	97	564110	Post-Rear
20 458 4212	Sfera	125	95	97	597316	Ant-Front
20 455 0432	Skipper 4T	125	00	02	598929	Post-Rear
20 455 0433	Skipper 4T	125	00	02	598929	Post-Rear
20 455 0221	Vespa Et4	125	96	98	564110	Post-Rear
20 458 4212	Vespa Et4	125	96	98	598922	Ant-Front
20 458 4212	Vespa Et4	125	99	02	598922	Ant-Front
20 455 0432	Vespa Et4	125	99	02	598929	Post-Rear
20 455 0433	Vespa Et4	125	99	02	598929	Post-Rear
20 455 0512	Vespa Granturismo	125	03	05	56198R	Post-Rear
20 455 0513	Vespa Granturismo	125	03	05	56198R	Post-Rear
20 458 4383	Vespa Granturismo	125	03	05	56263R	Ant-Front
20 458 4382	Vespa Granturismo	125	03	05	56263R	Post-Rear
20 455 0512	Vespa Granturismo	125	06	07	56234R	Post-Rear
20 455 0513	Vespa Granturismo	125	06	07	56234R	Post-Rear
20 458 4383	Vespa Granturismo	125	06	07	56263R	Ant-Front
20 458 4382	Vespa Granturismo	125	06	07	56263R	Post-Rear
20 458 4383	Vespa Granturismo Eu3	125	06	07	56286R	Ant-Front
20 458 4382	Vespa Granturismo Eu3	125	06	07	56286R	Post-Rear
20 455 0512	Vespa Granturismo Eu3	125	06	07	58503R	Post-Rear
20 455 0513	Vespa Granturismo Eu3	125	06	07	58503R	Post-Rear
20 455 0512	Vespa Gts 4T le Super	125	09	16	58503R	Post-Rear

AMMORTIZZATORI SCOOTER

SCOOTER SHOCK ABSORBERS



Codice RMS RMS Code	Modello - Model	CC	Da - From	A - To	Rif. Originale Oem number	Ant-Front Post-Rear	Codice RMS RMS Code	Modello - Model	CC	Da - From	A - To	Rif. Originale Oem number	Ant-Front Post-Rear
20 455 0513	Vespa Gts 4T le Super	125	09	16	58503R	Post-Rear	20 455 0782	X9	125	01	02	564995	Post-Rear
20 458 4383	Vespa Gts Eu3	125	07	12	56286R	Ant-Front	20 455 0782	X9 Evolution	125	03	03	564995	Post-Rear
20 458 4382	Vespa Gts Eu3	125	07	12	56286R	Post-Rear	20 455 0782	X9 Evolution	125	05	06	56231R	Post-Rear
20 455 0512	Vespa Gts Eu3	125	07	12	58503R	Post-Rear	20 455 0782	X9 Evolution Eu3	125	07	07	56231R	Post-Rear
20 455 0513	Vespa Gts Eu3	125	07	12	58503R	Post-Rear	20 455 0433	Zip	125	00	02	564881	Post-Rear
20 458 4383	Vespa Gtv	125	06	08	56286R	Ant-Front	20 458 4212	Zip	125	00	02	598922	Ant-Front
20 458 4382	Vespa Gtv	125	06	08	56286R	Post-Rear	20 455 0281	Liberty 4T Eu3	150	08	08	56232R	Post-Rear
20 455 0512	Vespa Gtv	125	06	08	58503R	Post-Rear	20 455 0281	Liberty 4T Sport Eu3	150	08	08	56232R	Post-Rear
20 455 0513	Vespa Gtv	125	06	08	58503R	Post-Rear	20 455 0281	Liberty Moc 4T Eu3	150	09	13	56232R	Post-Rear
20 458 4383	Vespa Gtv 4T Navy Eu3	125	08	08	56286R	Ant-Front	20 455 0512	V. Gts Sup. le 4T 3V Au,Ex,Jp,Ri,Tv	150	14	15	58503R	Post-Rear
20 458 4382	Vespa Gtv 4T Navy Eu3	125	08	08	56286R	Post-Rear	20 455 0513	V. Gts Sup. le 4T 3V Au,Ex,Jp,Ri,Tv	150	14	15	58503R	Post-Rear
20 455 0512	Vespa Gtv 4T Navy Eu3	125	08	08	58503R	Post-Rear	20 458 4371	Vespa Lx	150	05	06	601997	Ant-Front
20 455 0513	Vespa Gtv 4T Navy Eu3	125	08	08	58503R	Post-Rear	20 458 4373	Vespa Lx	150	05	06	601997	Ant-Front
20 458 4371	Vespa Lx	125	05	06	601997	Ant-Front	20 458 4371	Vespa Lx	150	05	06	601997	Post-Rear
20 458 4373	Vespa Lx	125	05	06	601997	Ant-Front	20 458 4373	Vespa Lx	150	05	06	601997	Post-Rear
20 458 4371	Vespa Lx	125	05	06	601997	Post-Rear	20 455 0432	Vespa Lx	150	05	06	56230R	Post-Rear
20 458 4373	Vespa Lx	125	05	06	601997	Post-Rear	20 455 0433	Vespa Lx	150	05	06	56230R	Post-Rear
20 455 0432	Vespa Lx	125	05	06	56230R	Post-Rear	20 458 4371	Vespa Lx 4T 3V le - Touring	150	12	13	601997	Ant-Front
20 455 0433	Vespa Lx	125	05	06	56230R	Post-Rear	20 458 4373	Vespa Lx 4T 3V le - Touring	150	12	13	601997	Ant-Front
20 458 4371	Vespa Lx 4T 3V le - Touring	125	12	13	601997	Ant-Front	20 458 4371	Vespa Lx 4T 3V le - Touring	150	12	13	601997	Post-Rear
20 458 4373	Vespa Lx 4T 3V le - Touring	125	12	13	601997	Ant-Front	20 458 4373	Vespa Lx 4T 3V le - Touring	150	12	13	601997	Post-Rear
20 458 4371	Vespa Lx 4T 3V le - Touring	125	12	13	601997	Post-Rear	20 455 0432	Vespa Lx 4T 3V le - Touring	150	12	13	56230R	Post-Rear
20 458 4373	Vespa Lx 4T 3V le - Touring	125	12	13	601997	Post-Rear	20 455 0433	Vespa Lx 4T 3V le - Touring	150	12	13	56230R	Post-Rear
20 455 0432	Vespa Lx 4T 3V le - Touring	125	12	13	56230R	Post-Rear	20 458 4371	Vespa Lx 4T FL	150	09	09	601997	Ant-Front
20 455 0433	Vespa Lx 4T 3V le - Touring	125	12	13	56230R	Post-Rear	20 458 4373	Vespa Lx 4T FL	150	09	09	601997	Ant-Front
20 458 4371	Vespa Lx 4T Eu3 Touring	125	10	11	601997	Ant-Front	20 458 4371	Vespa Lx 4T FL	150	09	09	601997	Post-Rear
20 458 4373	Vespa Lx 4T Eu3 Touring	125	10	11	601997	Ant-Front	20 458 4373	Vespa Lx 4T FL	150	09	09	601997	Post-Rear
20 458 4371	Vespa Lx 4T Eu3 Touring	125	10	11	601997	Post-Rear	20 455 0432	Vespa Lx 4T FL	150	09	09	56230R	Post-Rear
20 458 4373	Vespa Lx 4T Eu3 Touring	125	10	11	601997	Post-Rear	20 455 0433	Vespa Lx 4T FL	150	09	09	56230R	Post-Rear
20 455 0432	Vespa Lx 4T Eu3 Touring	125	10	11	56230R	Post-Rear	20 458 4371	Vespa Lx Eu3	150	06	08	601997	Ant-Front
20 455 0433	Vespa Lx 4T Eu3 Touring	125	10	11	56230R	Post-Rear	20 458 4373	Vespa Lx Eu3	150	06	08	601997	Ant-Front
20 458 4371	Vespa Lx 4T FL	125	09	09	601997	Ant-Front	20 458 4371	Vespa Lx Eu3	150	06	08	601997	Post-Rear
20 458 4373	Vespa Lx 4T FL	125	09	09	601997	Ant-Front	20 458 4373	Vespa Lx Eu3	150	06	08	601997	Post-Rear
20 458 4371	Vespa Lx 4T FL	125	09	09	601997	Post-Rear	20 455 0432	Vespa Lx Eu3	150	06	08	56230R	Post-Rear
20 458 4373	Vespa Lx 4T FL	125	09	09	601997	Post-Rear	20 455 0433	Vespa Lx Eu3	150	06	08	56230R	Post-Rear
20 455 0432	Vespa Lx 4T FL	125	09	09	56230R	Post-Rear	20 458 4371	Vespa Lx Eu3 le	150	09	11	601997	Ant-Front
20 455 0433	Vespa Lx 4T FL	125	09	09	56230R	Post-Rear	20 458 4373	Vespa Lx Eu3 le	150	09	11	601997	Ant-Front
20 458 4371	Vespa Lx Eu3	125	06	08	601997	Ant-Front	20 458 4371	Vespa Lx Eu3 le	150	09	11	601997	Post-Rear
20 458 4373	Vespa Lx Eu3	125	06	08	601997	Ant-Front	20 458 4373	Vespa Lx Eu3 le	150	09	11	601997	Post-Rear
20 458 4371	Vespa Lx Eu3	125	06	08	601997	Post-Rear	20 455 0432	Vespa Lx Eu3 le	150	09	11	56230R	Post-Rear
20 458 4373	Vespa Lx Eu3	125	06	08	601997	Post-Rear	20 455 0433	Vespa Lx Eu3 le	150	09	11	56230R	Post-Rear
20 455 0432	Vespa Lx Eu3	125	06	08	56230R	Post-Rear	20 458 4371	Vespa Lx Touring	150	10	12	646959	Ant-Front
20 455 0433	Vespa Lx Eu3	125	06	08	56230R	Post-Rear	20 458 4372	Vespa Lx Touring	150	10	12	646959	Ant-Front
20 458 4371	Vespa Lx Eu3 le	125	09	11	601997	Ant-Front	20 455 0432	Vespa Lx Touring	150	10	12	56230R	Post-Rear
20 458 4373	Vespa Lx Eu3 le	125	09	11	601997	Ant-Front	20 455 0433	Vespa Lx Touring	150	10	12	56230R	Post-Rear
20 458 4371	Vespa Lx Eu3 le	125	09	11	601997	Post-Rear	20 458 5112	Vespa Primavera 4T-3V	150	13	16	1C000837R	Ant-Front
20 458 4373	Vespa Lx Eu3 le	125	09	11	601997	Post-Rear	20 455 0782	X9 Amalfi	180	00	03	564995	Post-Rear
20 455 0432	Vespa Lx Eu3 le	125	09	11	56230R	Post-Rear	20 455 0672	Carnaby	200	07	08	649423	Post-Rear
20 455 0433	Vespa Lx Eu3 le	125	09	11	56230R	Post-Rear	20 455 0281	Liberty	200	06	06	56232R	Post-Rear
20 458 5112	Vespa Lx Primavera 4T 3V le	125	13	17	669166	Ant-Front	20 455 0281	Liberty 4T Eu3	200	06	08	56232R	Post-Rear
20 455 0432	Vespa Lxv 4T Eu3	125	06	09	56230R	Post-Rear	20 455 0281	Liberty 4T Sport Eu3	200	06	07	56232R	Post-Rear
20 455 0433	Vespa Lxv 4T Eu3	125	06	09	56230R	Post-Rear	20 455 0281	Liberty Rst	200	04	04	56134R	Post-Rear
20 455 0432	Vespa Lxv 4T Navy Eu3	125	07	08	56230R	Post-Rear	20 455 0281	Liberty Sport	200	06	06	56232R	Post-Rear
20 455 0433	Vespa Lxv 4T Navy Eu3	125	07	08	56230R	Post-Rear	20 455 0512	Vespa Granturismo	200	06	07	56234R	Post-Rear
20 455 0432	Vespa Lxv le 4T	125	10	13	56230R	Post-Rear	20 455 0513	Vespa Granturismo	200	06	07	56234R	Post-Rear
20 455 0433	Vespa Lxv le 4T	125	10	13	56230R	Post-Rear	20 458 4383	Vespa Granturismo	200	06	07	56286R	Ant-Front
20 455 0772	X Evo	125	07	16	646552	Post-Rear	20 458 4382	Vespa Granturismo	200	06	07	56286R	Post-Rear
20 455 0772	X Evo	125	07	16	56235R	Post-Rear	20 455 0772	X8	200	05	07	56235R	Post-Rear
20 455 0792	X10 4T 4V le Eu3	125	12	13	58607R	Post-Rear	20 455 0782	X9	200	02	03	564995	Post-Rear
20 455 0772	X7 Eu3	125	08	08	646552	Post-Rear	20 455 0782	X9 Evolution	200	03	03	564995	Post-Rear
20 455 0772	X8	125	04	04	599891	Post-Rear	20 455 0362	Beverly	250	06	07	601014	Post-Rear
20 455 0772	X8	125	05	06	56235R	Post-Rear	20 455 0682	Beverly	250	06	07	601014	Post-Rear
20 455 0772	X8 Premium Eu2	125	06	06	56235R	Post-Rear	20 455 0683	Beverly	250	06	07	601014	Post-Rear
20 455 0772	X8 Premium Eu3	125	06	07	56235R	Post-Rear	20 455 0362	Beverly Cruiser	250	07	09	601014	Post-Rear



AMMORTIZZATORI SCOOTER

SCOOTER SHOCK ABSORBERS

Codice RMS RMS Code	Modello - Model	CC	Da - From	A - To	Rif. Originale Oem number	Ant -Front Post-Rear	Codice RMS RMS Code	Modello - Model	CC	Da - From	A - To	Rif. Originale Oem number	Ant -Front Post-Rear
20 455 0682	Beverly Cruiser	250	07	09	601014	Post-Rear	20 458 4383	Vespa Gts le Touring	300	11	12	56286R	Ant-Front
20 455 0683	Beverly Cruiser	250	07	09	601014	Post-Rear	20 458 4382	Vespa Gts le Touring	300	11	12	56286R	Post-Rear
20 455 0362	Beverly Cruiser	250	07	09	56174R	Post-Rear	20 455 0512	Vespa Gts le Touring	300	11	12	58503R	Post-Rear
20 455 0682	Beverly Cruiser	250	07	09	56174R	Post-Rear	20 455 0513	Vespa Gts le Touring	300	11	12	58503R	Post-Rear
20 455 0683	Beverly Cruiser	250	07	09	56174R	Post-Rear	20 455 0512	Vespa Gts Super	300	08	16	58503R	Post-Rear
20 455 0362	Beverly Eu3 Mic	250	07	07	56174R	Post-Rear	20 455 0513	Vespa Gts Super	300	08	16	58503R	Post-Rear
20 455 0682	Beverly Eu3 Mic	250	07	07	56174R	Post-Rear	20 455 0512	Vespa Gts Super Sport	300	10	13	58503R	Post-Rear
20 455 0683	Beverly Eu3 Mic	250	07	07	56174R	Post-Rear	20 455 0513	Vespa Gts Super Sport	300	10	13	58503R	Post-Rear
20 455 0362	Beverly le Eu3	250	06	08	56174R	Post-Rear	20 458 4383	Vespa Gtv 4T 4V le	300	10	13	56286R	Ant-Front
20 455 0682	Beverly le Eu3	250	06	08	56174R	Post-Rear	20 458 4382	Vespa Gtv 4T 4V le	300	10	13	56286R	Post-Rear
20 455 0683	Beverly le Eu3	250	06	08	56174R	Post-Rear	20 455 0512	Vespa Gtv 4T 4V le	300	10	13	58503R	Post-Rear
20 455 0362	Beverly Rst	250	04	05	56138R	Post-Rear	20 455 0513	Vespa Gtv 4T 4V le	300	10	13	58503R	Post-Rear
20 455 0682	Beverly Rst	250	04	05	56138R	Post-Rear	20 458 4383	V. Gtv Via Montenapoleone	300	10	10	56286R	Ant-Front
20 455 0683	Beverly Rst	250	04	05	56138R	Post-Rear	20 458 4382	V. Gtv Via Montenapoleone	300	10	10	56286R	Post-Rear
20 455 0362	Beverly Sport	250	06	08	56174R	Post-Rear	20 455 0512	V. Gtv Via Montenapoleone	300	10	10	58503R	Post-Rear
20 455 0682	Beverly Sport	250	06	08	56174R	Post-Rear	20 455 0513	V. Gtv Via Montenapoleone	300	10	10	58503R	Post-Rear
20 455 0683	Beverly Sport	250	06	08	56174R	Post-Rear	20 455 0632	Beverly 4T 4V le Eu3 Sport Touring	350	11	14	58583R	Post-Rear
20 455 0362	Beverly Tourer Eu3	250	07	09	56174R	Post-Rear	20 455 0633	Beverly 4T 4V le Eu3 Sport Touring	350	11	14	58583R	Post-Rear
20 455 0682	Beverly Tourer Eu3	250	07	09	56174R	Post-Rear	20 455 0632	Beverly 4T 4V le Eu3 Sport Touring	350	11	14	58613R	Post-Rear
20 455 0683	Beverly Tourer Eu3	250	07	09	56174R	Post-Rear	20 455 0633	Beverly 4T 4V le Eu3 Sport Touring	350	11	14	58613R	Post-Rear
20 455 0672	Carnaby	250	08	08	649423	Post-Rear	20 455 0632	Beverly 4T St le Abs	350	16	16	58613R	Post-Rear
20 458 4383	Vespa Gt 60 Eu3	250	06	07	56286R	Ant-Front	20 455 0633	Beverly 4T St le Abs	350	16	16	58613R	Post-Rear
20 458 4382	Vespa Gt 60 Eu3	250	06	07	56286R	Post-Rear	20 455 0792	X10 4T 4V le Eu3	350	12	15	58607R	Post-Rear
20 455 0512	Vespa Gt 60 Eu3	250	06	07	58503R	Post-Rear	20 455 0651	Beverly Eu3	400	06	07	56210R	Post-Rear
20 455 0513	Vespa Gt 60 Eu3	250	06	07	58503R	Post-Rear	20 455 0653	Beverly Eu3	400	06	07	56210R	Post-Rear
20 458 4383	Vespa Gts	250	05	16	56286R	Ant-Front	20 455 0651	Beverly Tourer Eu3	400	08	10	56210R	Post-Rear
20 458 4382	Vespa Gts	250	05	16	56286R	Post-Rear	20 455 0653	Beverly Tourer Eu3	400	08	10	56210R	Post-Rear
20 455 0512	Vespa Gts	250	05	16	58503R	Post-Rear	20 455 0651	Beverly	500	02	04	56210R	Post-Rear
20 455 0513	Vespa Gts	250	05	16	58503R	Post-Rear	20 455 0653	Beverly	500	02	04	56210R	Post-Rear
20 455 0512	Vespa Gts Abs	250	05	12	56234R	Post-Rear	20 455 0651	Beverly	500	05	06	56210R	Post-Rear
20 455 0513	Vespa Gts Abs	250	05	12	56234R	Post-Rear	20 455 0653	Beverly	500	05	06	56210R	Post-Rear
20 458 4383	Vespa Gts Abs	250	05	12	56286R	Ant-Front	20 455 0651	Beverly Cruiser	500	07	12	56210R	Post-Rear
20 458 4382	Vespa Gts Abs	250	05	12	56286R	Post-Rear	20 455 0653	Beverly Cruiser	500	07	12	56210R	Post-Rear
20 458 4383	Vespa Gtv	250	06	09	56286R	Ant-Front	20 455 0651	Beverly Eu3	500	06	08	56210R	Post-Rear
20 458 4382	Vespa Gtv	250	06	09	56286R	Post-Rear	20 455 0653	Beverly Eu3	500	06	08	56210R	Post-Rear
20 455 0512	Vespa Gtv	250	06	09	58503R	Post-Rear	SUZUKI						
20 455 0513	Vespa Gtv	250	06	09	58503R	Post-Rear	20 455 0092	Aj Zz Sepia S	50	95	97		Post-Rear
20 458 4383	Vespa Gtv 4T Navy Eu3	250	07	07	56286R	Ant-Front	20 455 0622	Uh125 Burgman K7-L0	125	07	10	62100-03H01-000	Post-Rear
20 458 4382	Vespa Gtv 4T Navy Eu3	250	07	07	56286R	Post-Rear	20 455 0622	Uh125 Burgman L1	125	11	12	62100-03H01-000	Post-Rear
20 455 0512	Vespa Gtv 4T Navy Eu3	250	07	07	58503R	Post-Rear	20 455 0622	Uh125 Burgman L3	125	13	13	62100-03H01-000	Post-Rear
20 455 0513	Vespa Gtv 4T Navy Eu3	250	07	07	58503R	Post-Rear	20 455 0622	Uh125 Burgman L4	125	14	14	62100-03H01-000	Post-Rear
20 455 0772	X Evo	250	07	16	646552	Post-Rear	20 455 0612	Ux Sixteen K8-L0	125	08	10	62100-20H01-000	Post-Rear
20 455 0772	X Evo	250	07	16	56235R	Post-Rear	20 455 0612	UX Sixteen L1	125	11	11	62100-20H01-000	Post-Rear
20 455 0772	X7 Eu3	250	08	08	646552	Post-Rear	20 455 0612	Ux Sixteen K8-L0	150	08	10	62100-20H01-000	Post-Rear
20 455 0772	X8 Eu3	250	05	08	56235R	Post-Rear	20 455 0612	Ux Sixteen L1	150	11	11	62100-20H01-000	Post-Rear
20 455 0922	X9	250	00	01	564505	Post-Rear	20 455 0622	Uh200 Burgman K7-L0	200	07	10	62100-03H01-000	Post-Rear
20 455 0782	X9 Evolution	250	04	04	564995	Post-Rear	20 455 0622	Uh200 Burgman L1	200	11	12	62100-03H01-000	Post-Rear
20 455 0782	X9 Evolution	250	06	06	56231R	Post-Rear	20 455 0622	Uh200 Burgman L3	200	13	13	62100-03H01-000	Post-Rear
20 455 0662	Beverly le Abs E4	300	16	16	58518R	Post-Rear	20 455 0622	Uh200 Burgman L4	200	14	14	62100-03H01-000	Post-Rear
20 455 0663	Beverly le Abs E4	300	16	16	58518R	Post-Rear	SYM						
20 455 0662	Beverly Rst 4T 4V le Eu3	300	10	15	58518R	Post-Rear	20 455 0951	Symphony S	50	10	10	52400APA010	Post-Rear
20 455 0663	Beverly Rst 4T 4V le Eu3	300	10	15	58518R	Post-Rear	20 455 0951	Symphony S	50	11	11	52400APA010	Post-Rear
20 455 0362	Beverly Tourer Eu3	300	09	10	56174R	Post-Rear	20 455 0951	Symphony S	50	12	14	52400APA010	Post-Rear
20 455 0682	Beverly Tourer Eu3	300	09	10	56174R	Post-Rear	20 455 0951	Symphony Sr	50	10	10	52400APA010	Post-Rear
20 455 0683	Beverly Tourer Eu3	300	09	10	56174R	Post-Rear	20 455 0951	Symphony Sr	50	11	11	52400APA010	Post-Rear
20 455 0672	Carnaby Cruiser	300	09	12	649423	Post-Rear	20 455 0961	Hd Eu2	125	03	04	52400H9B800	Post-Rear
20 458 4383	Vespa Gts le & Touring	300	12	16	56286R	Ant-Front	20 455 0961	Hd Eu3	125	07	08	52400H9B800	Post-Rear
20 458 4382	Vespa Gts le & Touring	300	12	16	56286R	Post-Rear	20 455 0961	Hd Evo	125	05	06	52400H9B800	Post-Rear
20 455 0512	Vespa Gts le & Touring	300	12	16	58503R	Post-Rear	20 455 0961	Hd Evo Eu3	125	07	08	52400H9B800	Post-Rear
20 455 0513	Vespa Gts le & Touring	300	12	16	58503R	Post-Rear	20 455 0961	Hd Evo Eu3	125	10	11	52400H9B800	Post-Rear
20 458 4383	Vespa Gts le Abs E4	300	16	16	56286R	Ant-Front	20 455 0961	Hd Evo Tamburo Eu3	125	08	09	52400H9B800	Post-Rear
20 458 4382	Vespa Gts le Abs E4	300	16	16	56286R	Post-Rear	20 455 1011	Joyride Evo	125	09	10	52400LVA000KB	Post-Rear
20 455 0512	Vespa Gts le Abs E4	300	16	16	58503R5	Post-Rear	20 455 1011	Joyride Evo	125	10	10	52400LVA000KB	Post-Rear
20 455 0513	Vespa Gts le Abs E4	300	16	16	58503R5	Post-Rear	20 455 1011	Joyride Evo	125	13	13	52400LVA000KB	Post-Rear



Codice RMS RMS Code	Modello - Model	CC	Da - From	A - To	Rif. Originale Oem number	Ant-Front Post-Rear	Codice RMS RMS Code	Modello - Model	CC	Da - From	A - To	Rif. Originale Oem number	Ant-Front Post-Rear
20 455 1011	Joyride Evo	125	14	14	52400LVA000KB	Post-Rear	20 455 0502	Yp125R X-Max Abs	125	11	11	37PF22100000	Post-Rear
20 455 0941	Symphony S	125	10	10	52400ARB010	Post-Rear	20 455 0503	Yp125R X-Max Abs	125	11	11	37PF22100000	Post-Rear
20 455 0941	Symphony S	125	12	12	52400ARB010	Post-Rear	20 455 0502	Yp125Ra X-Max Abs	125	13	13	37PF22100000	Post-Rear
20 455 0941	Symphony S	125	13	14	52400ARB010	Post-Rear	20 455 0503	Yp125Ra X-Max Abs	125	13	13	37PF22100000	Post-Rear
20 455 1021	Symphony S Eu4	125	16	16	52400AR1000K	Post-Rear	20 455 0302	Yp150 Majesty	150	00	00	5DSF22100033	Post-Rear
20 455 0941	Symphony Sr	125	10	10	52400ARB010	Post-Rear	20 455 0302	Yp150 Majesty	150	01	02	5DSF22100000	Post-Rear
20 455 1021	Symphony St	125	15	15	52400AR1000K	Post-Rear	20 455 0302	Yp180E Majesty	180	03	06	5DSF22100000	Post-Rear
20 455 1021	Symphony St Eu4	125	16	16	52400AR1000K	Post-Rear	20 455 0802	Vp X-City	250	07	07	5B2F22101000	Post-Rear
20 455 0941	Symphony S	150	10	10	52400ARB010	Post-Rear	20 455 0492	Vp X-City	250	09	12	5B2F22102000	Post-Rear
20 455 0941	Symphony S	150	12	12	52400ARB010	Post-Rear	20 455 0493	Vp X-City	250	09	12	5B2F22102000	Post-Rear
20 455 0941	Symphony S	150	13	14	52400ARB010	Post-Rear	20 455 0492	Vp X-City	250	13	15	5B2F22102000	Post-Rear
20 455 0941	Symphony Sr	150	10	10	52400ARB010	Post-Rear	20 455 0493	Vp X-City	250	13	15	5B2F22102000	Post-Rear
20 455 0941	Symphony Sr	150	12	14	52400ARB010	Post-Rear	20 455 0331	Yp250 Majesty	250	00	01	5GM222100000	Post-Rear
20 455 0961	Hd Eu2	200	03	04	52400H9B800	Post-Rear	20 455 0332	Yp250 Majesty	250	00	01	5GM222100000	Post-Rear
20 455 0961	Hd Eu3 I	200	07	07	52400H9B800	Post-Rear	20 455 0331	Yp250 Majesty	250	02	03	5GM222100000	Post-Rear
20 455 0961	Hd Evo Eu2	200	05	06	52400H9B800	Post-Rear	20 455 0332	Yp250 Majesty	250	02	03	5GM222100000	Post-Rear
20 455 0961	Hd Evo Eu3 I	200	07	07	52400H9B800	Post-Rear	20 455 0331	Yp250 Majesty Abs	250	03	03	5GM222100000	Post-Rear
20 455 0961	Hd Evo I Eu3	200	10	12	52400H9B800	Post-Rear	20 455 0332	Yp250 Majesty Abs	250	03	03	5GM222100000	Post-Rear
20 455 0961	Hd Evo I Tamburo Eu3	200	08	09	52400H9B800	Post-Rear	20 455 0482	Yp250R Black X-Max	250	09	09	1B9F22100200	Post-Rear
20 455 1011	Joyride Evo I	200	09	09	52400LVA000KB	Post-Rear	20 455 0482	Yp250R X-Max	250	05	06	1B9F22100200	Post-Rear
20 455 1011	Joyride Evo I	200	13	14	52400LVA000KB	Post-Rear	20 455 0482	Yp250R X-Max	250	07	09	1B9F22100200	Post-Rear
20 455 1011	Joyride I Evo	200	10	10	52400LVA000KB	Post-Rear	20 455 0502	Yp250R X-Max	250	10	12	37PF22100000	Post-Rear
20 455 1011	Joyride S 200I Eu4	200	17	17	52400LVA000KB	Post-Rear	20 455 0503	Yp250R X-Max	250	10	12	37PF22100000	Post-Rear
20 455 1021	Symphony St	200	15	15	52400AR1000K	Post-Rear	20 455 0502	Yp250R X-Max	250	12	13	37PF22100000	Post-Rear
20 455 0971	Citycom	300	08	09	52400LEA000KB	Post-Rear	20 455 0503	Yp250R X-Max	250	12	13	37PF22100000	Post-Rear
20 455 0971	Citycom Efi	300	10	11	52400LEA000KB	Post-Rear	20 455 0502	Yp250R X-Max Sport	250	11	12	37PF22100000	Post-Rear
20 455 0971	Citycom I Cbs	300	12	12	52400LEA000KB	Post-Rear	20 455 0503	Yp250R X-Max Sport	250	11	12	37PF22100000	Post-Rear
20 455 0971	Citycom I S Eu4	300	17	17	52400LEA000KB	Post-Rear	20 455 0502	Yp250Ra X-Max Abs	250	11	12	37PF22100000	Post-Rear
20 455 0971	Citycom S 300 I Cbs	300	15	15	52400LEA000KB	Post-Rear	20 455 0503	Yp250Ra X-Max Abs	250	11	12	37PF22100000	Post-Rear
20 455 0981	Joymax I	300	12	12	52400L3A000KB	Post-Rear	20 455 0502	Yp250Ra X-Max Abs	250	12	13	37PF22100000	Post-Rear
20 455 0981	Joymax I	300	14	14	52400L3A000KB	Post-Rear	20 455 0503	Yp250Ra X-Max Abs	250	12	13	37PF22100000	Post-Rear
20 455 0981	Joymax I Abs	300	13	13	52400L3A000KB	Post-Rear	20 455 0342	Yp400 Majesty	400	04	05	5RU222101000	Post-Rear
20 455 0981	Joymax I Abs	300	14	14	52400L3A000KB	Post-Rear	20 455 0343	Yp400 Majesty	400	04	05	5RU222101000	Post-Rear
20 455 0981	Joymax I Sport Abs-S&S Eu4	300	17	17	52400L3A100KB	Post-Rear	20 455 0342	Yp400 Majesty	400	06	06	5RU222101000	Post-Rear
20 455 1001	Maxsym I	400	11	11	52400L4A000KB	Post-Rear	20 455 0343	Yp400 Majesty	400	06	06	5RU222101000	Post-Rear
20 455 1001	Maxsym I	400	12	12	52400L4A000KB	Post-Rear	20 455 0342	Yp400 Majesty	400	07	08	5RU222103000	Post-Rear
20 455 1001	Maxsym I Abs	400	12	12	52400L4A000KB	Post-Rear	20 455 0343	Yp400 Majesty	400	07	08	5RU222103000	Post-Rear
YAMAHA							20 455 0342	Yp400 Majesty	400	09	11	5RU222103000	Post-Rear
20 455 0161	Bw's Original	50	97	98	4VUF22100000	Post-Rear	20 455 0343	Yp400 Majesty	400	09	11	5RU222103000	Post-Rear
20 455 0161	Bw's Original	50	99	99	4VUF22100000	Post-Rear	20 455 0342	Yp400 Majesty Abs	400	07	07	5RU222103000	Post-Rear
20 455 0161	Bw's Original	50	99	00	4VUF22100000	Post-Rear	20 455 0343	Yp400 Majesty Abs	400	07	07	5RU222103000	Post-Rear
20 455 0161	Bw's Original Eu2	50	03	03	4VUF22100000	Post-Rear	20 455 0342	Yp400 Majesty Abs	400	08	08	5RU222103000	Post-Rear
20 455 0161	Cw Bw's Original Eu2	50	02	02	4VUF22100000	Post-Rear	20 455 0343	Yp400 Majesty Abs	400	08	08	5RU222103000	Post-Rear
20 455 0902	Ns 50n Aerox Naked	50	13	16	5BSF2210A000	Post-Rear	20 455 0342	Yp400 Majesty Abs	400	09	11	5RU222103000	Post-Rear
20 455 0181	Yn Neo's	50	04	06	5KKF22100033	Post-Rear	20 455 0343	Yp400 Majesty Abs	400	09	11	5RU222103000	Post-Rear
20 455 0181	Yn Neo's Eu2	50	02	03	5KKF22100033	Post-Rear	20 455 0912	Yp400R X-Max	400	15	16	1SDF22101000	Post-Rear
20 455 0181	Yn R Neo's	50	97	01	5KKF22100033	Post-Rear	20 455 0912	Yp400Ra X-Max Abs	400	15	17	1SDF22101000	Post-Rear
20 455 0181	Yn R Neo's	50	02	02	5KKF22100000	Post-Rear	20 455 0912	Yp400Ra X-Max Ironmax Abs	400	16	16	1SDF22101000	Post-Rear
20 455 0902	Yq Aerox	50	06	06	5BSF2210A000	Post-Rear							
20 455 0902	Yq Aerox	50	07	07	5BSF2210A000	Post-Rear							
20 455 0902	Yq Aerox	50	08	08	5BSF2210A000	Post-Rear							
20 455 0902	Yq Aerox	50	09	09	5BSF2210A000	Post-Rear							
20 455 0902	Yq Aerox	50	10	12	5BSF2210A000	Post-Rear							
20 455 0181	Yn Neo's	100	99	02	5KKF22100033	Post-Rear							
20 455 0302	Yp125 Majesty	125	98	00	5DSF22100000	Post-Rear							
20 455 0302	Yp125 Majesty	125	01	02	5DSF22100000	Post-Rear							
20 455 0302	Yp125E Majesty	125	03	05	5DSF22100000	Post-Rear							
20 455 0302	Yp125E Majesty	125	06	06	5DSF22100000	Post-Rear							
20 455 0482	Yp125R X-Max	125	06	07	1B9F22100200	Post-Rear							
20 455 0482	Yp125R X-Max	125	08	09	1B9F22100200	Post-Rear							
20 455 0502	Yp125R X-Max	125	10	12	37PF22100000	Post-Rear							
20 455 0503	Yp125R X-Max	125	10	12	37PF22100000	Post-Rear							
20 455 0502	Yp125R X-Max	125	12	13	37PF22100000	Post-Rear							
20 455 0503	Yp125R X-Max	125	12	13	37PF22100000	Post-Rear							



AMMORTIZZATORI SCOOTER

SCOOTER SHOCK ABSORBERS

20 455 0031 NEW						-	
LUNGHEZZA LENGHT (mm)	ATTACCO SUPERIORE UPPER FASTENING POINT			ATTACCO INFERIORE LOWER FASTENING POINT			
	Tipo-Type	D (mm)	W (mm)	Tipo-Type	D (mm)	W (mm)	
290		10,1	20		M8x1,25	20	

20 455 0041 NEW						-	
LUNGHEZZA LENGHT (mm)	ATTACCO SUPERIORE UPPER FASTENING POINT			ATTACCO INFERIORE LOWER FASTENING POINT			
	Tipo-Type	D (mm)	W (mm)	Tipo-Type	D (mm)	W (mm)	
290		10,2	20		M8x1,25	20	

20 455 0052							
LUNGHEZZA LENGHT (mm)	ATTACCO SUPERIORE UPPER FASTENING POINT			ATTACCO INFERIORE LOWER FASTENING POINT			
	Tipo-Type	D (mm)	W (mm)	Tipo-Type	D (mm)	W (mm)	
290		10,1	20		M8x1,25	20	

20 455 0061 NEW						-	
LUNGHEZZA LENGHT (mm)	ATTACCO SUPERIORE UPPER FASTENING POINT			ATTACCO INFERIORE LOWER FASTENING POINT			
	Tipo-Type	D (mm)	W (mm)	Tipo-Type	D (mm)	W (mm)	
340		M8x1,25	-		10,1	33	

20 455 0081 NEW						-	
LUNGHEZZA LENGHT (mm)	ATTACCO SUPERIORE UPPER FASTENING POINT			ATTACCO INFERIORE LOWER FASTENING POINT			
	Tipo-Type	D (mm)	W (mm)	Tipo-Type	D (mm)	W (mm)	
330		M8x1,0	15		10,1	33	

20 455 0092							
LUNGHEZZA LENGHT (mm)	ATTACCO SUPERIORE UPPER FASTENING POINT			ATTACCO INFERIORE LOWER FASTENING POINT			
	Tipo-Type	D (mm)	W (mm)	Tipo-Type	D (mm)	W (mm)	
265		10,1	20		M8x1,25	20	

20 455 0122							
LUNGHEZZA LENGHT (mm)	ATTACCO SUPERIORE UPPER FASTENING POINT			ATTACCO INFERIORE LOWER FASTENING POINT			
	Tipo-Type	D (mm)	W (mm)	Tipo-Type	D (mm)	W (mm)	
000		10,1	20		M8x1,25	20	

20 455 0132							
LUNGHEZZA LENGHT (mm)	ATTACCO SUPERIORE UPPER FASTENING POINT			ATTACCO INFERIORE LOWER FASTENING POINT			
	Tipo-Type	D (mm)	W (mm)	Tipo-Type	D (mm)	W (mm)	
225		10,1	20		M8x1,25	20	

20 455 0142							
LUNGHEZZA LENGHT (mm)	ATTACCO SUPERIORE UPPER FASTENING POINT			ATTACCO INFERIORE LOWER FASTENING POINT			
	Tipo-Type	D (mm)	W (mm)	Tipo-Type	D (mm)	W (mm)	
255		10,2	20		M8x1,25	20	

20 455 0161 NEW						-	
LUNGHEZZA LENGHT (mm)	ATTACCO SUPERIORE UPPER FASTENING POINT			ATTACCO INFERIORE LOWER FASTENING POINT			
	Tipo-Type	D (mm)	W (mm)	Tipo-Type	D (mm)	W (mm)	
245		10,1	20		M8x1,25	20	

AMMORTIZZATORI SCOOTER

SCOOTER SHOCK ABSORBERS



20 455 0181 NEW						-
LUNGHEZZA LENGHT (mm)	ATTACCO SUPERIORE UPPER FASTENING POINT			ATTACCO INFERIORE LOWER FASTENING POINT		
	Tipo-Type	D (mm)	W (mm)	Tipo-Type	D (mm)	W (mm)
280		10,1	20		M8x1,25	20

20 455 0191 NEW						-
LUNGHEZZA LENGHT (mm)	ATTACCO SUPERIORE UPPER FASTENING POINT			ATTACCO INFERIORE LOWER FASTENING POINT		
	Tipo-Type	D (mm)	W (mm)	Tipo-Type	D (mm)	W (mm)
280		10,2	20		M8x1,25	20

20 455 0192						
LUNGHEZZA LENGHT (mm)	ATTACCO SUPERIORE UPPER FASTENING POINT			ATTACCO INFERIORE LOWER FASTENING POINT		
	Tipo-Type	D (mm)	W (mm)	Tipo-Type	D (mm)	W (mm)
280		10,2	20		M8x1,25	20

20 455 0221 NEW						-
LUNGHEZZA LENGHT (mm)	ATTACCO SUPERIORE UPPER FASTENING POINT			ATTACCO INFERIORE LOWER FASTENING POINT		
	Tipo-Type	D (mm)	W (mm)	Tipo-Type	D (mm)	W (mm)
325		M8x1,0	8		10,1	33

20 455 0281 NEW						-
LUNGHEZZA LENGHT (mm)	ATTACCO SUPERIORE UPPER FASTENING POINT			ATTACCO INFERIORE LOWER FASTENING POINT		
	Tipo-Type	D (mm)	W (mm)	Tipo-Type	D (mm)	W (mm)
318		M8x1,0	25		10,2	30

20 455 0302						-
LUNGHEZZA LENGHT (mm)	ATTACCO SUPERIORE UPPER FASTENING POINT			ATTACCO INFERIORE LOWER FASTENING POINT		
	Tipo-Type	D (mm)	W (mm)	Tipo-Type	D (mm)	W (mm)
336		10,1	20		M8x1,25	20

20 455 0311 NEW						-
LUNGHEZZA LENGHT (mm)	ATTACCO SUPERIORE UPPER FASTENING POINT			ATTACCO INFERIORE LOWER FASTENING POINT		
	Tipo-Type	D (mm)	W (mm)	Tipo-Type	D (mm)	W (mm)
308		10,1	20		M8x1,25	20

20 455 0313						
LUNGHEZZA LENGHT (mm)	ATTACCO SUPERIORE UPPER FASTENING POINT			ATTACCO INFERIORE LOWER FASTENING POINT		
	Tipo-Type	D (mm)	W (mm)	Tipo-Type	D (mm)	W (mm)
308		10,1	20		M8x1,25	20

20 455 0331 NEW						-
LUNGHEZZA LENGHT (mm)	ATTACCO SUPERIORE UPPER FASTENING POINT			ATTACCO INFERIORE LOWER FASTENING POINT		
	Tipo-Type	D (mm)	W (mm)	Tipo-Type	D (mm)	W (mm)
344		10,1	20		M8x1,25	20

20 455 0332						
LUNGHEZZA LENGHT (mm)	ATTACCO SUPERIORE UPPER FASTENING POINT			ATTACCO INFERIORE LOWER FASTENING POINT		
	Tipo-Type	D (mm)	W (mm)	Tipo-Type	D (mm)	W (mm)
344		10,1	20		M8x1,25	20



AMMORTIZZATORI SCOOTER

SCOOTER SHOCK ABSORBERS

20 455 0342				-		
LUNGHEZZA LENGHT (mm)	ATTACCO SUPERIORE UPPER FASTENING POINT			ATTACCO INFERIORE LOWER FASTENING POINT		
	Tipo-Type	D (mm)	W (mm)	Tipo-Type	D (mm)	W (mm)
415		10x1,25	20		M8x1,25	20

20 455 0343						
LUNGHEZZA LENGHT (mm)	ATTACCO SUPERIORE UPPER FASTENING POINT			ATTACCO INFERIORE LOWER FASTENING POINT		
	Tipo-Type	D (mm)	W (mm)	Tipo-Type	D (mm)	W (mm)
415		10x1,25	20		M8x1,25	20

20 455 0352						
LUNGHEZZA LENGHT (mm)	ATTACCO SUPERIORE UPPER FASTENING POINT			ATTACCO INFERIORE LOWER FASTENING POINT		
	Tipo-Type	D (mm)	W (mm)	Tipo-Type	D (mm)	W (mm)
329		M8x1,0	20,5		10,1	37

20 455 0362						
LUNGHEZZA LENGHT (mm)	ATTACCO SUPERIORE UPPER FASTENING POINT			ATTACCO INFERIORE LOWER FASTENING POINT		
	Tipo-Type	D (mm)	W (mm)	Tipo-Type	D (mm)	W (mm)
339		10,1	30		14,1	24

20 455 0372						
LUNGHEZZA LENGHT (mm)	ATTACCO SUPERIORE UPPER FASTENING POINT			ATTACCO INFERIORE LOWER FASTENING POINT		
	Tipo-Type	D (mm)	W (mm)	Tipo-Type	D (mm)	W (mm)
280		10,15	21		M8x1,25	20

20 455 0432						
LUNGHEZZA LENGHT (mm)	ATTACCO SUPERIORE UPPER FASTENING POINT			ATTACCO INFERIORE LOWER FASTENING POINT		
	Tipo-Type	D (mm)	W (mm)	Tipo-Type	D (mm)	W (mm)
322,5		M8x1,0	21		10,2	30,5

20 455 0433						
LUNGHEZZA LENGHT (mm)	ATTACCO SUPERIORE UPPER FASTENING POINT			ATTACCO INFERIORE LOWER FASTENING POINT		
	Tipo-Type	D (mm)	W (mm)	Tipo-Type	D (mm)	W (mm)
322,5		M8x1,0	21		10,2	30,5

20 455 0442						
LUNGHEZZA LENGHT (mm)	ATTACCO SUPERIORE UPPER FASTENING POINT			ATTACCO INFERIORE LOWER FASTENING POINT		
	Tipo-Type	D (mm)	W (mm)	Tipo-Type	D (mm)	W (mm)
344		8	21		10,1	24

20 455 0452						
LUNGHEZZA LENGHT (mm)	ATTACCO SUPERIORE UPPER FASTENING POINT			ATTACCO INFERIORE LOWER FASTENING POINT		
	Tipo-Type	D (mm)	W (mm)	Tipo-Type	D (mm)	W (mm)
340		10,2	28		10,1	33

20 455 0462						
LUNGHEZZA LENGHT (mm)	ATTACCO SUPERIORE UPPER FASTENING POINT			ATTACCO INFERIORE LOWER FASTENING POINT		
	Tipo-Type	D (mm)	W (mm)	Tipo-Type	D (mm)	W (mm)
345		8	21		14,1	24

AMMORTIZZATORI SCOOTER

SCOOTER SHOCK ABSORBERS



20 455 0463						
LUNGHEZZA LENGHT (mm)	ATTACCO SUPERIORE UPPER FASTENING POINT			ATTACCO INFERIORE LOWER FASTENING POINT		
	Tipo-Type	D (mm)	W (mm)	Tipo-Type	D (mm)	W (mm)
345		8	21		14,1	24

20 455 0472					-	
LUNGHEZZA LENGHT (mm)	ATTACCO SUPERIORE UPPER FASTENING POINT			ATTACCO INFERIORE LOWER FASTENING POINT		
	Tipo-Type	D (mm)	W (mm)	Tipo-Type	D (mm)	W (mm)
300		10,15	21		10,1	36

20 455 0482						
LUNGHEZZA LENGHT (mm)	ATTACCO SUPERIORE UPPER FASTENING POINT			ATTACCO INFERIORE LOWER FASTENING POINT		
	Tipo-Type	D (mm)	W (mm)	Tipo-Type	D (mm)	W (mm)
343		10,1	20		M8x1,25	20

20 455 0492						
LUNGHEZZA LENGHT (mm)	ATTACCO SUPERIORE UPPER FASTENING POINT			ATTACCO INFERIORE LOWER FASTENING POINT		
	Tipo-Type	D (mm)	W (mm)	Tipo-Type	D (mm)	W (mm)
358		10,1	20		M8x1,25	20

20 455 0493						
LUNGHEZZA LENGHT (mm)	ATTACCO SUPERIORE UPPER FASTENING POINT			ATTACCO INFERIORE LOWER FASTENING POINT		
	Tipo-Type	D (mm)	W (mm)	Tipo-Type	D (mm)	W (mm)
358		10,1	20		M8x1,25	20

20 455 0502						
LUNGHEZZA LENGHT (mm)	ATTACCO SUPERIORE UPPER FASTENING POINT			ATTACCO INFERIORE LOWER FASTENING POINT		
	Tipo-Type	D (mm)	W (mm)	Tipo-Type	D (mm)	W (mm)
343		10,1	20		M8x1,25	20

20 455 0503						
LUNGHEZZA LENGHT (mm)	ATTACCO SUPERIORE UPPER FASTENING POINT			ATTACCO INFERIORE LOWER FASTENING POINT		
	Tipo-Type	D (mm)	W (mm)	Tipo-Type	D (mm)	W (mm)
343		10,1	20		M8x1,25	20

20 455 0512						
LUNGHEZZA LENGHT (mm)	ATTACCO SUPERIORE UPPER FASTENING POINT			ATTACCO INFERIORE LOWER FASTENING POINT		
	Tipo-Type	D (mm)	W (mm)	Tipo-Type	D (mm)	W (mm)
348		M8x1,0	25		14,1	24

20 455 0513						
LUNGHEZZA LENGHT (mm)	ATTACCO SUPERIORE UPPER FASTENING POINT			ATTACCO INFERIORE LOWER FASTENING POINT		
	Tipo-Type	D (mm)	W (mm)	Tipo-Type	D (mm)	W (mm)
348		M8x1,0	25		14,1	24

20 455 0522						
LUNGHEZZA LENGHT (mm)	ATTACCO SUPERIORE UPPER FASTENING POINT			ATTACCO INFERIORE LOWER FASTENING POINT		
	Tipo-Type	D (mm)	W (mm)	Tipo-Type	D (mm)	W (mm)
326		10,15	21		M8x1,25	20



AMMORTIZZATORI SCOOTER

SCOOTER SHOCK ABSORBERS

20 455 0523						
LUNGHEZZA LENGHT (mm)	ATTACCO SUPERIORE UPPER FASTENING POINT			ATTACCO INFERIORE LOWER FASTENING POINT		
	Tipo-Type	D (mm)	W (mm)	Tipo-Type	D (mm)	W (mm)
326		10,15	21		M8x1,25	20

20 455 0532						
LUNGHEZZA LENGHT (mm)	ATTACCO SUPERIORE UPPER FASTENING POINT			ATTACCO INFERIORE LOWER FASTENING POINT		
	Tipo-Type	D (mm)	W (mm)	Tipo-Type	D (mm)	W (mm)
390		10,15	21		M10x1,25	26,5

20 455 0533						
LUNGHEZZA LENGHT (mm)	ATTACCO SUPERIORE UPPER FASTENING POINT			ATTACCO INFERIORE LOWER FASTENING POINT		
	Tipo-Type	D (mm)	W (mm)	Tipo-Type	D (mm)	W (mm)
390		10,15	21		M10x1,25	26,5

20 455 0542						
LUNGHEZZA LENGHT (mm)	ATTACCO SUPERIORE UPPER FASTENING POINT			ATTACCO INFERIORE LOWER FASTENING POINT		
	Tipo-Type	D (mm)	W (mm)	Tipo-Type	D (mm)	W (mm)
328		10,15	21		M8x1,25	20

20 455 0552						
LUNGHEZZA LENGHT (mm)	ATTACCO SUPERIORE UPPER FASTENING POINT			ATTACCO INFERIORE LOWER FASTENING POINT		
	Tipo-Type	D (mm)	W (mm)	Tipo-Type	D (mm)	W (mm)
394		10,15	21		M10x1,25	23

20 455 0562						
LUNGHEZZA LENGHT (mm)	ATTACCO SUPERIORE UPPER FASTENING POINT			ATTACCO INFERIORE LOWER FASTENING POINT		
	Tipo-Type	D (mm)	W (mm)	Tipo-Type	D (mm)	W (mm)
398		10,15	21		M10x1,25	26,5

20 455 0572						
LUNGHEZZA LENGHT (mm)	ATTACCO SUPERIORE UPPER FASTENING POINT			ATTACCO INFERIORE LOWER FASTENING POINT		
	Tipo-Type	D (mm)	W (mm)	Tipo-Type	D (mm)	W (mm)
320		10,15	21		M8x1,25	20

20 455 0582						
LUNGHEZZA LENGHT (mm)	ATTACCO SUPERIORE UPPER FASTENING POINT			ATTACCO INFERIORE LOWER FASTENING POINT		
	Tipo-Type	D (mm)	W (mm)	Tipo-Type	D (mm)	W (mm)
308		10,1	20		M8x1,25	20

20 455 0592						
LUNGHEZZA LENGHT (mm)	ATTACCO SUPERIORE UPPER FASTENING POINT			ATTACCO INFERIORE LOWER FASTENING POINT		
	Tipo-Type	D (mm)	W (mm)	Tipo-Type	D (mm)	W (mm)
338		10,1	20		M8x1,25	20

20 455 0602				-		
LUNGHEZZA LENGHT (mm)	ATTACCO SUPERIORE UPPER FASTENING POINT			ATTACCO INFERIORE LOWER FASTENING POINT		
	Tipo-Type	D (mm)	W (mm)	Tipo-Type	D (mm)	W (mm)
390		10,15	21		10,1	30

AMMORTIZZATORI SCOOTER

SCOOTER SHOCK ABSORBERS



20 455 0612								
LUNGHEZZA LENGHT (mm)	ATTACCO SUPERIORE UPPER FASTENING POINT			ATTACCO INFERIORE LOWER FASTENING POINT			Tipo-Type	W (mm)
	Tipo-Type	D (mm)	W (mm)	Tipo-Type	D (mm)	W (mm)		
325		10,1	20		M10x1,25	20		
20 455 0622								
LUNGHEZZA LENGHT (mm)	ATTACCO SUPERIORE UPPER FASTENING POINT			ATTACCO INFERIORE LOWER FASTENING POINT			Tipo-Type	W (mm)
	Tipo-Type	D (mm)	W (mm)	Tipo-Type	D (mm)	W (mm)		
340		10,1	20		M10x1,25	20		
20 455 0632								
LUNGHEZZA LENGHT (mm)	ATTACCO SUPERIORE UPPER FASTENING POINT			ATTACCO INFERIORE LOWER FASTENING POINT			Tipo-Type	W (mm)
	Tipo-Type	D (mm)	W (mm)	Tipo-Type	D (mm)	W (mm)		
363		10,1	20		M10x1,25	20		
20 455 0633								
LUNGHEZZA LENGHT (mm)	ATTACCO SUPERIORE UPPER FASTENING POINT			ATTACCO INFERIORE LOWER FASTENING POINT			Tipo-Type	W (mm)
	Tipo-Type	D (mm)	W (mm)	Tipo-Type	D (mm)	W (mm)		
363		10,1	20		M10x1,25	20		
20 455 0642							-	
LUNGHEZZA LENGHT (mm)	ATTACCO SUPERIORE UPPER FASTENING POINT			ATTACCO INFERIORE LOWER FASTENING POINT			Tipo-Type	W (mm)
	Tipo-Type	D (mm)	W (mm)	Tipo-Type	D (mm)	W (mm)		
345		10,1	21,6		10,1	33		
20 455 0651							-	
LUNGHEZZA LENGHT (mm)	ATTACCO SUPERIORE UPPER FASTENING POINT			ATTACCO INFERIORE LOWER FASTENING POINT			Tipo-Type	W (mm)
	Tipo-Type	D (mm)	W (mm)	Tipo-Type	D (mm)	W (mm)		
377		10,5	30		10,5	30		
20 455 0653								
LUNGHEZZA LENGHT (mm)	ATTACCO SUPERIORE UPPER FASTENING POINT			ATTACCO INFERIORE LOWER FASTENING POINT			Tipo-Type	W (mm)
	Tipo-Type	D (mm)	W (mm)	Tipo-Type	D (mm)	W (mm)		
377		10,5	30		10,5	30		
20 455 0662								
LUNGHEZZA LENGHT (mm)	ATTACCO SUPERIORE UPPER FASTENING POINT			ATTACCO INFERIORE LOWER FASTENING POINT			Tipo-Type	W (mm)
	Tipo-Type	D (mm)	W (mm)	Tipo-Type	D (mm)	W (mm)		
346		10,5	30		14,1	24		
20 455 0663								
LUNGHEZZA LENGHT (mm)	ATTACCO SUPERIORE UPPER FASTENING POINT			ATTACCO INFERIORE LOWER FASTENING POINT			Tipo-Type	W (mm)
	Tipo-Type	D (mm)	W (mm)	Tipo-Type	D (mm)	W (mm)		
346		10,5	30		14,1	24		
20 455 0672								
LUNGHEZZA LENGHT (mm)	ATTACCO SUPERIORE UPPER FASTENING POINT			ATTACCO INFERIORE LOWER FASTENING POINT			Tipo-Type	W (mm)
	Tipo-Type	D (mm)	W (mm)	Tipo-Type	D (mm)	W (mm)		
348		8	21		14,1	24		



AMMORTIZZATORI SCOOTER

SCOOTER SHOCK ABSORBERS

20 455 0682						
LUNGHEZZA LENGHT (mm)	ATTACCO SUPERIORE UPPER FASTENING POINT			ATTACCO INFERIORE LOWER FASTENING POINT		
	Tipo-Type	D (mm)	W (mm)	Tipo-Type	D (mm)	W (mm)
338		10,5	30		14,1	24

20 455 0683						
LUNGHEZZA LENGHT (mm)	ATTACCO SUPERIORE UPPER FASTENING POINT			ATTACCO INFERIORE LOWER FASTENING POINT		
	Tipo-Type	D (mm)	W (mm)	Tipo-Type	D (mm)	W (mm)
338		10,5	30		14,1	24

20 455 0701 NEW				-		
LUNGHEZZA LENGHT (mm)	ATTACCO SUPERIORE UPPER FASTENING POINT			ATTACCO INFERIORE LOWER FASTENING POINT		
	Tipo-Type	D (mm)	W (mm)	Tipo-Type	D (mm)	W (mm)
404		10,1	20,5		M10x1,25	27

20 455 0703						
LUNGHEZZA LENGHT (mm)	ATTACCO SUPERIORE UPPER FASTENING POINT			ATTACCO INFERIORE LOWER FASTENING POINT		
	Tipo-Type	D (mm)	W (mm)	Tipo-Type	D (mm)	W (mm)
404		10,1	20,5		M10x1,25	27

20 455 0712						
LUNGHEZZA LENGHT (mm)	ATTACCO SUPERIORE UPPER FASTENING POINT			ATTACCO INFERIORE LOWER FASTENING POINT		
	Tipo-Type	D (mm)	W (mm)	Tipo-Type	D (mm)	W (mm)
311		10,15	21		M8x1,25	20

20 455 0722						
LUNGHEZZA LENGHT (mm)	ATTACCO SUPERIORE UPPER FASTENING POINT			ATTACCO INFERIORE LOWER FASTENING POINT		
	Tipo-Type	D (mm)	W (mm)	Tipo-Type	D (mm)	W (mm)
377		10,15	21		M8x1,25	20

20 455 0723						
LUNGHEZZA LENGHT (mm)	ATTACCO SUPERIORE UPPER FASTENING POINT			ATTACCO INFERIORE LOWER FASTENING POINT		
	Tipo-Type	D (mm)	W (mm)	Tipo-Type	D (mm)	W (mm)
377		10,15	21		M8x1,25	20

20 455 0732						
LUNGHEZZA LENGHT (mm)	ATTACCO SUPERIORE UPPER FASTENING POINT			ATTACCO INFERIORE LOWER FASTENING POINT		
	Tipo-Type	D (mm)	W (mm)	Tipo-Type	D (mm)	W (mm)
377		10,5	30		10,5	30

20 455 0742						
LUNGHEZZA LENGHT (mm)	ATTACCO SUPERIORE UPPER FASTENING POINT			ATTACCO INFERIORE LOWER FASTENING POINT		
	Tipo-Type	D (mm)	W (mm)	Tipo-Type	D (mm)	W (mm)
390		10,2	21		10,2	30

20 455 0752						
LUNGHEZZA LENGHT (mm)	ATTACCO SUPERIORE UPPER FASTENING POINT			ATTACCO INFERIORE LOWER FASTENING POINT		
	Tipo-Type	D (mm)	W (mm)	Tipo-Type	D (mm)	W (mm)
334		10,5	30		10,5	30

AMMORTIZZATORI SCOOTER

SCOOTER SHOCK ABSORBERS



20 455 0753							
LUNGHEZZA LENGHT (mm)	ATTACCO SUPERIORE UPPER FASTENING POINT			ATTACCO INFERIORE LOWER FASTENING POINT			
	Tipo-Type	D (mm)	W (mm)	Tipo-Type	D (mm)	W (mm)	
334		10,5	30		10,5	30	
20 455 0762							
LUNGHEZZA LENGHT (mm)	ATTACCO SUPERIORE UPPER FASTENING POINT			ATTACCO INFERIORE LOWER FASTENING POINT			
	Tipo-Type	D (mm)	W (mm)	Tipo-Type	D (mm)	W (mm)	
390		10,2	21		M10x1,25	26,5	
20 455 0763							
LUNGHEZZA LENGHT (mm)	ATTACCO SUPERIORE UPPER FASTENING POINT			ATTACCO INFERIORE LOWER FASTENING POINT			
	Tipo-Type	D (mm)	W (mm)	Tipo-Type	D (mm)	W (mm)	
390		10,2	21		M10x1,25	26,5	
20 455 0772							
LUNGHEZZA LENGHT (mm)	ATTACCO SUPERIORE UPPER FASTENING POINT			ATTACCO INFERIORE LOWER FASTENING POINT			
	Tipo-Type	D (mm)	W (mm)	Tipo-Type	D (mm)	W (mm)	
350		10,5	30		10,5	30	
20 455 0782							
LUNGHEZZA LENGHT (mm)	ATTACCO SUPERIORE UPPER FASTENING POINT			ATTACCO INFERIORE LOWER FASTENING POINT			
	Tipo-Type	D (mm)	W (mm)	Tipo-Type	D (mm)	W (mm)	
340		10,5	30		14,1	24	
20 455 0792							
LUNGHEZZA LENGHT (mm)	ATTACCO SUPERIORE UPPER FASTENING POINT			ATTACCO INFERIORE LOWER FASTENING POINT			
	Tipo-Type	D (mm)	W (mm)	Tipo-Type	D (mm)	W (mm)	
430		10,5	30		14,1	24	
20 455 0802							
LUNGHEZZA LENGHT (mm)	ATTACCO SUPERIORE UPPER FASTENING POINT			ATTACCO INFERIORE LOWER FASTENING POINT			
	Tipo-Type	D (mm)	W (mm)	Tipo-Type	D (mm)	W (mm)	
358		10,1	20		M8x1,25	20	
20 455 0812							
LUNGHEZZA LENGHT (mm)	ATTACCO SUPERIORE UPPER FASTENING POINT			ATTACCO INFERIORE LOWER FASTENING POINT			
	Tipo-Type	D (mm)	W (mm)	Tipo-Type	D (mm)	W (mm)	
260		10,1	21		M10x1,25	20	
20 455 0822							
LUNGHEZZA LENGHT (mm)	ATTACCO SUPERIORE UPPER FASTENING POINT			ATTACCO INFERIORE LOWER FASTENING POINT			
	Tipo-Type	D (mm)	W (mm)	Tipo-Type	D (mm)	W (mm)	
352		10,1	21		14,1	24	
20 455 0832							
LUNGHEZZA LENGHT (mm)	ATTACCO SUPERIORE UPPER FASTENING POINT			ATTACCO INFERIORE LOWER FASTENING POINT			
	Tipo-Type	D (mm)	W (mm)	Tipo-Type	D (mm)	W (mm)	
387		10,2	21		M10x1,25	26,5	



AMMORTIZZATORI SCOOTER

SCOOTER SHOCK ABSORBERS

20 455 0842				-		
LUNGHEZZA LENGHT (mm)	ATTACCO SUPERIORE UPPER FASTENING POINT			ATTACCO INFERIORE LOWER FASTENING POINT		
	Tipo-Type	D (mm)	W (mm)	Tipo-Type	D (mm)	W (mm)
387		10,2	21		M10x1,25	26,5

20 455 0852						
LUNGHEZZA LENGHT (mm)	ATTACCO SUPERIORE UPPER FASTENING POINT			ATTACCO INFERIORE LOWER FASTENING POINT		
	Tipo-Type	D (mm)	W (mm)	Tipo-Type	D (mm)	W (mm)
315		10,5	21		M8x1,25	20

20 455 0862				-		
LUNGHEZZA LENGHT (mm)	ATTACCO SUPERIORE UPPER FASTENING POINT			ATTACCO INFERIORE LOWER FASTENING POINT		
	Tipo-Type	D (mm)	W (mm)	Tipo-Type	D (mm)	W (mm)
310		10,2	20		10,5	33,5

20 455 0882				-		
LUNGHEZZA LENGHT (mm)	ATTACCO SUPERIORE UPPER FASTENING POINT			ATTACCO INFERIORE LOWER FASTENING POINT		
	Tipo-Type	D (mm)	W (mm)	Tipo-Type	D (mm)	W (mm)
348		M8X1,0	22		10,1	33

20 455 0902						
LUNGHEZZA LENGHT (mm)	ATTACCO SUPERIORE UPPER FASTENING POINT			ATTACCO INFERIORE LOWER FASTENING POINT		
	Tipo-Type	D (mm)	W (mm)	Tipo-Type	D (mm)	W (mm)
273		10,1	20		M8x1,25	20

20 455 0912						
LUNGHEZZA LENGHT (mm)	ATTACCO SUPERIORE UPPER FASTENING POINT			ATTACCO INFERIORE LOWER FASTENING POINT		
	Tipo-Type	D (mm)	W (mm)	Tipo-Type	D (mm)	W (mm)
405		10,1	20		M8x1,25	20

20 455 0922						
LUNGHEZZA LENGHT (mm)	ATTACCO SUPERIORE UPPER FASTENING POINT			ATTACCO INFERIORE LOWER FASTENING POINT		
	Tipo-Type	D (mm)	W (mm)	Tipo-Type	D (mm)	W (mm)
401		10,2	30		M10x1,25	20

20 455 0932 NEW				-		
LUNGHEZZA LENGHT (mm)	ATTACCO SUPERIORE UPPER FASTENING POINT			ATTACCO INFERIORE LOWER FASTENING POINT		
	Tipo-Type	D (mm)	W (mm)	Tipo-Type	D (mm)	W (mm)
382		M8x1,0	24		10	33

20 455 0941 NEW				-		
LUNGHEZZA LENGHT (mm)	ATTACCO SUPERIORE UPPER FASTENING POINT			ATTACCO INFERIORE LOWER FASTENING POINT		
	Tipo-Type	D (mm)	W (mm)	Tipo-Type	D (mm)	W (mm)
321		10,2	18		M8x1,25	20

20 455 0951 NEW				-		
LUNGHEZZA LENGHT (mm)	ATTACCO SUPERIORE UPPER FASTENING POINT			ATTACCO INFERIORE LOWER FASTENING POINT		
	Tipo-Type	D (mm)	W (mm)	Tipo-Type	D (mm)	W (mm)
323		10,2	18		M8x1,25	20

AMMORTIZZATORI SCOOTER

SCOOTER SHOCK ABSORBERS



20 455 0961 NEW						-
LUNGHEZZA LENGHT (mm)	ATTACCO SUPERIORE UPPER FASTENING POINT			ATTACCO INFERIORE LOWER FASTENING POINT		
	Tipo-Type	D (mm)	W (mm)	Tipo-Type	D (mm)	W (mm)
303		10,2	18		M8x1,25	19
20 455 0971 NEW						-
LUNGHEZZA LENGHT (mm)	ATTACCO SUPERIORE UPPER FASTENING POINT			ATTACCO INFERIORE LOWER FASTENING POINT		
	Tipo-Type	D (mm)	W (mm)	Tipo-Type	D (mm)	W (mm)
381		10,2	21		M8x1,25	19
20 455 0981 NEW						-
LUNGHEZZA LENGHT (mm)	ATTACCO SUPERIORE UPPER FASTENING POINT			ATTACCO INFERIORE LOWER FASTENING POINT		
	Tipo-Type	D (mm)	W (mm)	Tipo-Type	D (mm)	W (mm)
381		10,2	21		M8x1,25	19
20 455 1001 NEW						-
LUNGHEZZA LENGHT (mm)	ATTACCO SUPERIORE UPPER FASTENING POINT			ATTACCO INFERIORE LOWER FASTENING POINT		
	Tipo-Type	D (mm)	W (mm)	Tipo-Type	D (mm)	W (mm)
397		12,2	21		M10x1,25	26
20 455 1011 NEW						-
LUNGHEZZA LENGHT (mm)	ATTACCO SUPERIORE UPPER FASTENING POINT			ATTACCO INFERIORE LOWER FASTENING POINT		
	Tipo-Type	D (mm)	W (mm)	Tipo-Type	D (mm)	W (mm)
325		10,2	21		M8x1,25	19
20 455 1021 NEW						-
LUNGHEZZA LENGHT (mm)	ATTACCO SUPERIORE UPPER FASTENING POINT			ATTACCO INFERIORE LOWER FASTENING POINT		
	Tipo-Type	D (mm)	W (mm)	Tipo-Type	D (mm)	W (mm)
325		10,2	21		M8x1,25	20
20 458 4212						-
LUNGHEZZA LENGHT (mm)	ATTACCO SUPERIORE UPPER FASTENING POINT			ATTACCO INFERIORE LOWER FASTENING POINT		
	Tipo-Type	D (mm)	W (mm)	Tipo-Type	D (mm)	W (mm)
264		M8x1,25	14		M8	35
20 458 4371 NEW						-
LUNGHEZZA LENGHT (mm)	ATTACCO SUPERIORE UPPER FASTENING POINT			ATTACCO INFERIORE LOWER FASTENING POINT		
	Tipo-Type	D (mm)	W (mm)	Tipo-Type	D (mm)	W (mm)
266		M10x1,25	15		M8x1,25	35
20 458 4373						
LUNGHEZZA LENGHT (mm)	ATTACCO SUPERIORE UPPER FASTENING POINT			ATTACCO INFERIORE LOWER FASTENING POINT		
	Tipo-Type	D (mm)	W (mm)	Tipo-Type	D (mm)	W (mm)
266		M10x1,25	15		M8x1,25	35
20 458 4382						-
LUNGHEZZA LENGHT (mm)	ATTACCO SUPERIORE UPPER FASTENING POINT			ATTACCO INFERIORE LOWER FASTENING POINT		
	Tipo-Type	D (mm)	W (mm)	Tipo-Type	D (mm)	W (mm)
291		M10x1,25	16		M8x1,25	35



AMMORTIZZATORI SCOOTER

SCOOTER SHOCK ABSORBERS

20 458 4383						
LUNGHEZZA LENGHT (mm)	ATTACCO SUPERIORE UPPER FASTENING POINT			ATTACCO INFERIORE LOWER FASTENING POINT		
	Tipo-Type	D (mm)	W (mm)	Tipo-Type	D (mm)	W (mm)
291		M10x1,25	16		M8x1,25	35

20 458 5112					-	
NEW						
LUNGHEZZA LENGHT (mm)	ATTACCO SUPERIORE UPPER FASTENING POINT			ATTACCO INFERIORE LOWER FASTENING POINT		
	Tipo-Type	D (mm)	W (mm)	Tipo-Type	D (mm)	W (mm)
296		M10x1,25	15		12,1	34

	Posteriore <i>Rear</i>
	Anteriore <i>Front</i>
	Prearico molla a camma <i>Step spring preload</i>
	Prearico molla con ghiera filettata <i>Threaded spring preload</i>
	Attacco ad occhiello <i>End eye fastening point</i>
	Attacco a forchetta <i>Fork fastening point</i>
	Attacco con perno <i>Stud fastening point</i>
	Attacco con doppia vite <i>Two bolts fastening point</i>



Codice RMS Code	Modello - Model	CC	Da - From	A - To	Riferimento Originale Oem number	Codice Telaio Frame Code	Ant -Front Post-Rear	Codice RMS Code	Modello - Model	CC	Da - From	A - To	Riferimento Originale Oem number	Codice Telaio Frame Code	Ant -Front Post-Rear
PIAGGIO								204560193	Vespa 50 S	50	63	68	494783	V55A1T	Post-Rear
204550872	Vespa 50	50	63	67	610287M	V5A1T	Post-Rear	204584362	Vespa 50 S	50	63	68	100282	V55A1T	Ant-Front
204560182	Vespa 50	50	63	67	2466204	V5A1T	Post-Rear	204550872	Vespa 50 Special	50	70	72	610287M	V5A2T	Post-Rear
204560191	Vespa 50	50	63	67	494783	V5A1T	Post-Rear	204560182	Vespa 50 Special	50	70	72	2466204	V5A2T	Post-Rear
204560192	Vespa 50	50	63	67	494783	V5A1T	Post-Rear	204560191	Vespa 50 Special	50	70	72	494783	V5A2T	Post-Rear
204560193	Vespa 50	50	63	67	494783	V5A1T	Post-Rear	204560192	Vespa 50 Special	50	70	72	494783	V5A2T	Post-Rear
204584362	Vespa 50	50	63	67	100282	V5A1T	Ant-Front	204560193	Vespa 50 Special	50	70	72	494783	V5A2T	Post-Rear
204550872	Vespa 50	50	67	71	610287M	VA51T	Post-Rear	204584242	Vespa 50 Special	50	70	72	1379364	V5A2T	Ant-Front
204560182	Vespa 50	50	67	71	2466204	VA51T	Post-Rear	204584243	Vespa 50 Special	50	70	72	1379364	V5A2T	Ant-Front
204560191	Vespa 50	50	67	71	494783	VA51T	Post-Rear	204584251	Vespa 50 Special	50	70	72	610290M	V5A2T	Ant-Front
204560192	Vespa 50	50	67	71	494783	VA51T	Post-Rear	204584252	Vespa 50 Special	50	70	72	610290M	V5A2T	Ant-Front
204560193	Vespa 50	50	67	71	494783	VA51T	Post-Rear	204585072	Vespa 50 Special	50	70	72	610290M	V5A2T	Ant-Front
204584362	Vespa 50	50	67	71	100282	VA51T	Ant-Front	204585092	Vespa 50 Special	50	70	72	610290M	V5A2T	Ant-Front
204550382	Vespa 50 Autom.	50	90	90	266403	V5P2T	Post-Rear	204550872	Vespa 50 Special	50	72	75	610287M	V5B1T	Post-Rear
204560201	Vespa 50 Autom.	50	90	90	266403	V5P2T	Post-Rear	204560182	Vespa 50 Special	50	72	75	2466204	V5B1T	Post-Rear
204560202	Vespa 50 Autom.	50	90	90	266403	V5P2T	Post-Rear	204560191	Vespa 50 Special	50	72	75	494783	V5B1T	Post-Rear
204560212	Vespa 50 Autom.	50	90	90	2664264	V5P2T	Post-Rear	204560192	Vespa 50 Special	50	72	75	494783	V5B1T	Post-Rear
204584262	Vespa 50 Autom.	50	90	90	2665384	V5P2T	Ant-Front	204560193	Vespa 50 Special	50	72	75	494783	V5B1T	Post-Rear
204584302	Vespa 50 Autom.	50	90	90	-	V5P2T	Ant-Front	204584242	Vespa 50 Special	50	72	75	1379364	V5B1T	Ant-Front
204550382	Vespa 50 FI	50	90	90	266403	V5N1	Post-Rear	204584243	Vespa 50 Special	50	72	75	1379364	V5B1T	Ant-Front
204560201	Vespa 50 FI	50	90	90	266403	V5N1	Post-Rear	204584251	Vespa 50 Special	50	72	75	610290M	V5B1T	Ant-Front
204560202	Vespa 50 FI	50	90	90	266403	V5N1	Post-Rear	204584252	Vespa 50 Special	50	72	75	610290M	V5B1T	Ant-Front
204560212	Vespa 50 FI	50	90	90	2664264	V5N1	Post-Rear	204585072	Vespa 50 Special	50	72	75	610290M	V5B1T	Ant-Front
204584262	Vespa 50 FI	50	90	90	2665384	V5N1	Ant-Front	204585092	Vespa 50 Special	50	72	75	610290M	V5B1T	Ant-Front
204584302	Vespa 50 FI	50	90	90	-	V5N1	Ant-Front	204550872	Vespa 50 Special	50	75	83	610287M	V5B3T	Post-Rear
204550872	Vespa 50 L	50	66	70	610287M	V5A1T	Post-Rear	204560182	Vespa 50 Special	50	75	83	2466204	V5B3T	Post-Rear
204560182	Vespa 50 L	50	66	70	2466204	V5A1T	Post-Rear	204560191	Vespa 50 Special	50	75	83	494783	V5B3T	Post-Rear
204560191	Vespa 50 L	50	66	70	494783	V5A1T	Post-Rear	204560192	Vespa 50 Special	50	75	83	494783	V5B3T	Post-Rear
204560192	Vespa 50 L	50	66	70	494783	V5A1T	Post-Rear	204560193	Vespa 50 Special	50	75	83	494783	V5B3T	Post-Rear
204560193	Vespa 50 L	50	66	70	494783	V5A1T	Post-Rear	204584242	Vespa 50 Special	50	75	83	1379364	V5B3T	Ant-Front
204560282	Vespa 50 L	50	66	70	98812	V5A1T	Post-Rear	204584243	Vespa 50 Special	50	75	83	1379364	V5B3T	Ant-Front
204584362	Vespa 50 L	50	66	70	100282	V5A1T	Ant-Front	204584251	Vespa 50 Special	50	75	83	610290M	V5B3T	Ant-Front
204550872	Vespa 50 N	50	63	71	610287M	V5A1T	Post-Rear	204584252	Vespa 50 Special	50	75	83	610290M	V5B3T	Ant-Front
204560182	Vespa 50 N	50	63	71	2466204	V5A1T	Post-Rear	204585072	Vespa 50 Special	50	75	83	610290M	V5B3T	Ant-Front
204560191	Vespa 50 N	50	63	71	494783	V5A1T	Post-Rear	204585092	Vespa 50 Special	50	75	83	610290M	V5B3T	Ant-Front
204560192	Vespa 50 N	50	63	71	494783	V5A1T	Post-Rear	204550872	Vespa 50 Special Elestart	50	70	72	610287M	V5A3T	Post-Rear
204560193	Vespa 50 N	50	63	71	494783	V5A1T	Post-Rear	204560182	Vespa 50 Special Elestart	50	70	72	2466204	V5A3T	Post-Rear
204560282	Vespa 50 N	50	63	71	98812	V5A1T	Post-Rear	204560191	Vespa 50 Special Elestart	50	70	72	494783	V5A3T	Post-Rear
204584362	Vespa 50 N	50	63	71	100282	V5A1T	Ant-Front	204560192	Vespa 50 Special Elestart	50	70	72	494783	V5A3T	Post-Rear
204550872	Vespa 50 R	50	69	71	610287M	V5A1T	Post-Rear	204560193	Vespa 50 Special Elestart	50	70	72	494783	V5A3T	Post-Rear
204560182	Vespa 50 R	50	69	71	2466204	V5A1T	Post-Rear	204584242	Vespa 50 Special Elestart	50	70	72	1379364	V5A3T	Ant-Front
204560191	Vespa 50 R	50	69	71	494783	V5A1T	Post-Rear	204584243	Vespa 50 Special Elestart	50	70	72	1379364	V5A3T	Ant-Front
204560192	Vespa 50 R	50	69	71	494783	V5A1T	Post-Rear	204584251	Vespa 50 Special Elestart	50	70	72	610290M	V5A3T	Ant-Front
204560193	Vespa 50 R	50	69	71	494783	V5A1T	Post-Rear	204584252	Vespa 50 Special Elestart	50	70	72	610290M	V5A3T	Ant-Front
204560282	Vespa 50 R	50	69	71	98812	V5A1T	Post-Rear	204585072	Vespa 50 Special Elestart	50	70	72	610290M	V5A3T	Ant-Front
204584362	Vespa 50 R	50	69	71	100282	V5A1T	Ant-Front	204585092	Vespa 50 Special Elestart	50	70	72	610290M	V5A3T	Ant-Front
204550872	Vespa 50 Revival	50	91	91	610287M	V5R1T	Post-Rear	204550872	Vespa 50 Special Elestart	50	72	75	610287M	V5B2T	Post-Rear
204560182	Vespa 50 Revival	50	91	91	2466204	V5R1T	Post-Rear	204560182	Vespa 50 Special Elestart	50	72	75	2466204	V5B2T	Post-Rear
204560191	Vespa 50 Revival	50	91	91	494783	V5R1T	Post-Rear	204560191	Vespa 50 Special Elestart	50	72	75	494783	V5B2T	Post-Rear
204560192	Vespa 50 Revival	50	91	91	494783	V5R1T	Post-Rear	204560192	Vespa 50 Special Elestart	50	72	75	494783	V5B2T	Post-Rear
204560193	Vespa 50 Revival	50	91	91	494783	V5R1T	Post-Rear	204560193	Vespa 50 Special Elestart	50	72	75	494783	V5B2T	Post-Rear
204550872	Vespa 50 S	50	63	68	610287M	V55A1T	Post-Rear	204584242	Vespa 50 Special Elestart	50	72	75	1379364	V5B2T	Ant-Front
204560182	Vespa 50 S	50	63	68	2466204	V55A1T	Post-Rear	204584243	Vespa 50 Special Elestart	50	72	75	1379364	V5B2T	Ant-Front
204560191	Vespa 50 S	50	63	68	494783	V55A1T	Post-Rear	204584251	Vespa 50 Special Elestart	50	72	75	610290M	V5B2T	Ant-Front
204560192	Vespa 50 S	50	63	68	494783	V55A1T	Post-Rear	204584252	Vespa 50 Special Elestart	50	72	75	610290M	V5B2T	Ant-Front



AMMORTIZZATORI PIAGGIO VESPA

PIAGGIO VESPA SHOCK ABSORBERS

Codice RMS Code	Modello - Model	CC	Da - From		Riferimento Originale Oem number	Codice Telaio Frame Code	Ant-Front Post-Rear
			A - To	A - To			
204585072	Vespa 50 Special Elestart	50	72	75	610290M	V5B2T	Ant-Front
204585092	Vespa 50 Special Elestart	50	72	75	610290M	V5B2T	Ant-Front
204550872	Vespa 50 Special Elestart	50	75	76	610287M	V5B4T	Post-Rear
204560182	Vespa 50 Special Elestart	50	75	76	2466204	V5B4T	Post-Rear
204560191	Vespa 50 Special Elestart	50	75	76	494783	V5B4T	Post-Rear
204560192	Vespa 50 Special Elestart	50	75	76	494783	V5B4T	Post-Rear
204560193	Vespa 50 Special Elestart	50	75	76	494783	V5B4T	Post-Rear
204584242	Vespa 50 Special Elestart	50	75	76	1379364	V5B4T	Ant-Front
204584243	Vespa 50 Special Elestart	50	75	76	1379364	V5B4T	Ant-Front
204584251	Vespa 50 Special Elestart	50	75	76	610290M	V5B4T	Ant-Front
204584252	Vespa 50 Special Elestart	50	75	76	610290M	V5B4T	Ant-Front
204585072	Vespa 50 Special Elestart	50	75	76	610290M	V5B4T	Ant-Front
204585092	Vespa 50 Special Elestart	50	75	76	610290M	V5B4T	Ant-Front
204550382	Vespa Pk 50	50	82	84	266403	V5X1T	Post-Rear
204560201	Vespa Pk 50	50	82	84	266403	V5X1T	Post-Rear
204560202	Vespa Pk 50	50	82	84	266403	V5X1T	Post-Rear
204560212	Vespa Pk 50	50	82	84	2664264	V5X1T	Post-Rear
204550382	Vespa Pk 50 Autom.	50	84	89	266403	V5A1T	Post-Rear
204560201	Vespa Pk 50 Autom.	50	84	89	266403	V5A1T	Post-Rear
204560202	Vespa Pk 50 Autom.	50	84	89	266403	V5A1T	Post-Rear
204560212	Vespa Pk 50 Autom.	50	84	89	2664264	V5A1T	Post-Rear
204550382	Vespa PK 50 HP	50	91	99	266403	V5N2T	Post-Rear
204560201	Vespa PK 50 HP	50	91	99	266403	V5N2T	Post-Rear
204560202	Vespa PK 50 HP	50	91	99	266403	V5N2T	Post-Rear
204560212	Vespa PK 50 HP	50	91	99	2664264	V5N2T	Post-Rear
204584262	Vespa PK 50 HP	50	91	99	2665384	V5N2T	Ant-Front
204584302	Vespa PK 50 HP	50	91	99	-	V5N2T	Ant-Front
204550382	Vespa PK 50 N	50	90	90	266403	V5X5	Post-Rear
204560201	Vespa PK 50 N	50	90	90	266403	V5X5	Post-Rear
204560202	Vespa PK 50 N	50	90	90	266403	V5X5	Post-Rear
204560212	Vespa PK 50 N	50	90	90	2664264	V5X5	Post-Rear
204584262	Vespa PK 50 N	50	90	90	2665384	V5X5	Ant-Front
204584302	Vespa PK 50 N	50	90	90	-	V5X5	Ant-Front
204550382	Vespa PK 50 N Speedmatic	50	90	90	266403	V5P1	Post-Rear
204560201	Vespa PK 50 N Speedmatic	50	90	90	266403	V5P1	Post-Rear
204560202	Vespa PK 50 N Speedmatic	50	90	90	266403	V5P1	Post-Rear
204560212	Vespa PK 50 N Speedmatic	50	90	90	2664264	V5P1	Post-Rear
204584262	Vespa PK 50 N Speedmatic	50	90	90	2665384	V5P1	Ant-Front
204584302	Vespa PK 50 N Speedmatic	50	90	90	-	V5P1	Ant-Front
204550382	Vespa Pk 50 Rush	50	88	88	266403	V5X4T	Post-Rear
204560201	Vespa Pk 50 Rush	50	88	88	266403	V5X4T	Post-Rear
204560202	Vespa Pk 50 Rush	50	88	88	266403	V5X4T	Post-Rear
204560212	Vespa Pk 50 Rush	50	88	88	2664264	V5X4T	Post-Rear
204584262	Vespa Pk 50 Rush	50	88	88	2665384	V5X4T	Ant-Front
204584302	Vespa Pk 50 Rush	50	88	88	-	V5X4T	Ant-Front
204550382	Vespa Pk 50 Rush Elestart	50	89	89	266403	V5X4T	Post-Rear
204560201	Vespa Pk 50 Rush Elestart	50	89	89	266403	V5X4T	Post-Rear
204560202	Vespa Pk 50 Rush Elestart	50	89	89	266403	V5X4T	Post-Rear
204560212	Vespa Pk 50 Rush Elestart	50	89	89	2664264	V5X4T	Post-Rear
204584262	Vespa Pk 50 Rush Elestart	50	89	89	2665384	V5X4T	Ant-Front
204584302	Vespa Pk 50 Rush Elestart	50	89	89	-	V5X4T	Ant-Front
204550382	Vespa Pk 50 S	50	82	82	266403	V5X2T	Post-Rear
204560201	Vespa Pk 50 S	50	82	82	266403	V5X2T	Post-Rear
204560202	Vespa Pk 50 S	50	82	82	266403	V5X2T	Post-Rear
204560212	Vespa Pk 50 S	50	82	82	2664264	V5X2T	Post-Rear

Codice RMS Code	Modello - Model	CC	Da - From		Riferimento Originale Oem number	Codice Telaio Frame Code	Ant-Front Post-Rear
			A - To	A - To			
204550382	Vespa Pk 50 Ss	50	83	83	266403	V5S1T	Post-Rear
204560201	Vespa Pk 50 Ss	50	83	83	266403	V5S1T	Post-Rear
204560202	Vespa Pk 50 Ss	50	83	83	266403	V5S1T	Post-Rear
204560212	Vespa Pk 50 Ss	50	83	83	2664264	V5S1T	Post-Rear
204550382	Vespa Pk 50 Ss Elestart	50	83	83	266403	V5S1T	Post-Rear
204560201	Vespa Pk 50 Ss Elestart	50	83	83	266403	V5S1T	Post-Rear
204560202	Vespa Pk 50 Ss Elestart	50	83	83	266403	V5S1T	Post-Rear
204560212	Vespa Pk 50 Ss Elestart	50	83	83	2664264	V5S1T	Post-Rear
204550382	Vespa Pk 50 XI	50	85	88	266403	V5X3T	Post-Rear
204560201	Vespa Pk 50 XI	50	85	88	266403	V5X3T	Post-Rear
204560202	Vespa Pk 50 XI	50	85	88	266403	V5X3T	Post-Rear
204560212	Vespa Pk 50 XI	50	85	88	2664264	V5X3T	Post-Rear
204584262	Vespa Pk 50 XI	50	85	88	2665384	V5X3T	Ant-Front
204584302	Vespa Pk 50 XI	50	85	88	-	V5X3T	Ant-Front
204550382	Vespa Pk 50 XI Elestart	50	86	86	266403	V5X3T	Post-Rear
204560201	Vespa Pk 50 XI Elestart	50	86	86	266403	V5X3T	Post-Rear
204560202	Vespa Pk 50 XI Elestart	50	86	86	266403	V5X3T	Post-Rear
204560212	Vespa Pk 50 XI Elestart	50	86	86	2664264	V5X3T	Post-Rear
204584262	Vespa Pk 50 XI Elestart	50	86	86	2665384	V5X3T	Ant-Front
204584302	Vespa Pk 50 XI Elestart	50	86	86	-	V5X3T	Ant-Front
204550382	Vespa Pk 50 XI Plurimatic	50	85	90	266403	VA52T	Post-Rear
204560201	Vespa Pk 50 XI Plurimatic	50	85	90	266403	VA52T	Post-Rear
204560202	Vespa Pk 50 XI Plurimatic	50	85	90	266403	VA52T	Post-Rear
204560212	Vespa Pk 50 XI Plurimatic	50	85	90	2664264	VA52T	Post-Rear
204584262	Vespa Pk 50 XI Plurimatic	50	85	90	2665384	VA52T	Ant-Front
204584302	Vespa Pk 50 XI Plurimatic	50	85	90	-	VA52T	Ant-Front
204550382	Vespa Pk 50 XI Plurimatic	50	85	90	-	VA52T	Ant-Front
204550382	Vespa Pk 50 XI Rush	50	88	89	266403	V5X4T	Post-Rear
204560201	Vespa Pk 50 XI Rush	50	88	89	266403	V5X4T	Post-Rear
204560202	Vespa Pk 50 XI Rush	50	88	89	266403	V5X4T	Post-Rear
204560212	Vespa Pk 50 XI Rush	50	88	89	2664264	V5X4T	Post-Rear
204550382	Vespa Pk 50 XLS	50	86	86	266403	V5S2T	Post-Rear
204560201	Vespa Pk 50 XLS	50	86	86	266403	V5S2T	Post-Rear
204560202	Vespa Pk 50 XLS	50	86	86	266403	V5S2T	Post-Rear
204560212	Vespa Pk 50 XLS	50	86	86	2664264	V5S2T	Post-Rear
204584262	Vespa Pk 50 XLS	50	86	86	2665384	V5S2T	Ant-Front
204584302	Vespa Pk 50 XLS	50	86	86	-	V5S2T	Ant-Front
204550872	Vespa Sprinter	50	71	73	610287M	V5S52T	Post-Rear
204560182	Vespa Sprinter	50	71	73	2466204	V5S52T	Post-Rear
204560191	Vespa Sprinter	50	71	73	494783	V5S52T	Post-Rear
204560192	Vespa Sprinter	50	71	73	494783	V5S52T	Post-Rear
204560193	Vespa Sprinter	50	71	73	494783	V5S52T	Post-Rear
204584242	Vespa Sprinter	50	71	73	1379364	V5S52T	Ant-Front
204584243	Vespa Sprinter	50	71	73	1379364	V5S52T	Ant-Front
204584251	Vespa Sprinter	50	71	73	610290M	V5S52T	Ant-Front
204584252	Vespa Sprinter	50	71	73	610290M	V5S52T	Ant-Front
204585072	Vespa Sprinter	50	71	73	610290M	V5S52T	Ant-Front
204585092	Vespa Sprinter	50	71	73	610290M	V5S52T	Ant-Front
204550872	Vespa SS 50	50	65	71	610287M	V5S51T	Post-Rear
204560182	Vespa SS 50	50	65	71	2466204	V5S51T	Post-Rear
204560191	Vespa SS 50	50	65	71	494783	V5S51T	Post-Rear
204560192	Vespa SS 50	50	65	71	494783	V5S51T	Post-Rear
204560193	Vespa SS 50	50	65	71	494783	V5S51T	Post-Rear

AMMORTIZZATORI PIAGGIO VESPA

PIAGGIO VESPA SHOCK ABSORBERS



Codice RMS Code	Modello - Model	CC	Da - From	A - To	Riferimento Originale Oem number	Codice Telaio Frame Code	Ant -Front Post-Rear	Codice RMS Code	Modello - Model	CC	Da - From	A - To	Riferimento Originale Oem number	Codice Telaio Frame Code	Ant -Front Post-Rear
204584251	Vespa SS 50	50	65	71	610290M	V5SS1T	Ant-Front	204560202	Vespa Pk 100 S	100	82	82	266403	V9X1T	Post-Rear
204584252	Vespa SS 50	50	65	71	610290M	V5SS1T	Ant-Front	204560212	Vespa Pk 100 S	100	82	82	2664264	V9X1T	Post-Rear
204584362	Vespa SS 50	50	65	71	100282	V5SS1T	Ant-Front	204550382	Vespa Pk 100 S Elestart	100	83	83	266403	V9X1T	Post-Rear
204585072	Vespa SS 50	50	65	71	610290M	V5SS1T	Ant-Front	204560201	Vespa Pk 100 S Elestart	100	83	83	266403	V9X1T	Post-Rear
204585092	Vespa SS 50	50	65	71	610290M	V5SS1T	Ant-Front	204560202	Vespa Pk 100 S Elestart	100	83	83	266403	V9X1T	Post-Rear
204550382	Vespa Pk 80 S	80	82	82	266403	V8X5T	Post-Rear	204560212	Vespa Pk 100 S Elestart	100	83	83	2664264	V9X1T	Post-Rear
204560201	Vespa Pk 80 S	80	82	82	266403	V8X5T	Post-Rear	204550382	Vespa Pk 100 XL	100	86	86	266403	V9X2T	Post-Rear
204560202	Vespa Pk 80 S	80	82	82	266403	V8X5T	Post-Rear	204560201	Vespa Pk 100 XL	100	86	86	266403	V9X2T	Post-Rear
204560212	Vespa Pk 80 S	80	82	82	2664264	V8X5T	Post-Rear	204560202	Vespa Pk 100 XL	100	86	86	266403	V9X2T	Post-Rear
204550382	Vespa Pk 80 S	80	84	84	266403	VA81T	Post-Rear	204560212	Vespa Pk 100 XL	100	86	86	2664264	V9X2T	Post-Rear
204560201	Vespa Pk 80 S	80	84	84	266403	VA81T	Post-Rear	204550892	Cosa 1 125	125	88	91	2681414	VNR1T	Post-Rear
204560202	Vespa Pk 80 S	80	84	84	266403	VA81T	Post-Rear	204585102	Cosa 1 125	125	88	91	2679244	VNR1T	Ant-Front
204560212	Vespa Pk 80 S	80	84	84	2664264	VA81T	Post-Rear	204550892	Cosa 1 125 Elestart	125	88	88	2681414	VNR1T	Post-Rear
204560201	Vespa Pk 80 S Autom.	80	84	84	266403	VA81T	Post-Rear	204585102	Cosa 1 125 Elestart	125	88	88	2679244	VNR1T	Ant-Front
204560202	Vespa Pk 80 S Autom.	80	84	84	266403	VA81T	Post-Rear	204550892	Cosa 2 125	125	91	97	2681414	VNR1	Post-Rear
204560212	Vespa Pk 80 S Autom.	80	84	84	2664264	VA81T	Post-Rear	204585102	Cosa 2 125	125	91	97	2679244	VNR1	Ant-Front
204550382	Vespa Pk 80 S Elestart	80	83	83	266403	V8X5T	Post-Rear	204585062	Vespa 125	125	56	57	1375714001	VN2T	Ant-Front
204560201	Vespa Pk 80 S Elestart	80	83	83	266403	V8X5T	Post-Rear	204560242	Vespa 125	125	58	58	83816	VNA1T	Post-Rear
204560202	Vespa Pk 80 S Elestart	80	83	83	266403	V8X5T	Post-Rear	204560242	Vespa 125	125	58	59	83816	VNA2T	Post-Rear
204560212	Vespa Pk 80 S Elestart	80	83	83	2664264	V8X5T	Post-Rear	204585062	Vespa 125	125	58	58	1375714001	VNA1T	Ant-Front
204550872	Vespa 90	90	63	68	610287M	V9A1T	Post-Rear	204585062	Vespa 125	125	58	59	1375714001	VNA2T	Ant-Front
204560182	Vespa 90	90	63	68	2466204	V9A1T	Post-Rear	204560242	Vespa 125	125	60	60	83816	VNB1T	Post-Rear
204560191	Vespa 90	90	63	68	494783	V9A1T	Post-Rear	204585062	Vespa 125	125	60	60	1375714001	VNB1T	Ant-Front
204560192	Vespa 90	90	63	68	494783	V9A1T	Post-Rear	204560242	Vespa 125	125	61	61	83816	VNB2T	Post-Rear
204560193	Vespa 90	90	63	68	494783	V9A1T	Post-Rear	204560242	Vespa 125	125	61	62	83816	VNB3T	Post-Rear
204584242	Vespa 90	90	63	68	1379364	V9A1T	Ant-Front	204585062	Vespa 125	125	61	61	1375714001	VNB2T	Ant-Front
204584243	Vespa 90	90	63	68	1379364	V9A1T	Ant-Front	204585062	Vespa 125	125	61	62	1375714001	VNB3T	Ant-Front
204584251	Vespa 90	90	63	68	610290M	V9A1T	Ant-Front	204560242	Vespa 125	125	63	63	83816	VNB4T	Post-Rear
204584252	Vespa 90	90	63	68	610290M	V9A1T	Ant-Front	204585062	Vespa 125	125	63	63	1375714001	VNB4T	Ant-Front
204585072	Vespa 90	90	63	68	610290M	V9A1T	Ant-Front	204560242	Vespa 125	125	64	64	83816	VNB5T	Post-Rear
204585092	Vespa 90	90	63	68	610290M	V9A1T	Ant-Front	204585062	Vespa 125	125	64	64	1375714001	VNB5T	Ant-Front
204550872	Vespa 90 Racer	90	71	73	610287M	V9SS2T	Post-Rear	204560242	Vespa 125	125	65	66	83816	VNB6T	Post-Rear
204560182	Vespa 90 Racer	90	71	73	2466204	V9SS2T	Post-Rear	204585062	Vespa 125	125	65	66	1375714001	VNB6T	Ant-Front
204560191	Vespa 90 Racer	90	71	73	494783	V9SS2T	Post-Rear	204550382	Vespa 125 FI	125	89	89	266403	VMX7	Post-Rear
204560192	Vespa 90 Racer	90	71	73	494783	V9SS2T	Post-Rear	204560201	Vespa 125 FI	125	89	89	266403	VMX7	Post-Rear
204560193	Vespa 90 Racer	90	71	73	494783	V9SS2T	Post-Rear	204560202	Vespa 125 FI	125	89	89	266403	VMX7	Post-Rear
204584242	Vespa 90 Racer	90	71	73	1379364	V9SS2T	Ant-Front	204560212	Vespa 125 FI	125	89	89	2664264	VMX7	Post-Rear
204584243	Vespa 90 Racer	90	71	73	1379364	V9SS2T	Ant-Front	204550872	Vespa ET3 125	125	76	83	610287M	VMB1T	Post-Rear
204584251	Vespa 90 Racer	90	71	73	610290M	V9SS2T	Ant-Front	204560182	Vespa ET3 125	125	76	83	2466204	VMB1T	Post-Rear
204584252	Vespa 90 Racer	90	71	73	610290M	V9SS2T	Ant-Front	204560191	Vespa ET3 125	125	76	83	494783	VMB1T	Post-Rear
204585072	Vespa 90 Racer	90	71	73	610290M	V9SS2T	Ant-Front	204560192	Vespa ET3 125	125	76	83	494783	VMB1T	Post-Rear
204585092	Vespa 90 Racer	90	71	73	610290M	V9SS2T	Ant-Front	204560193	Vespa ET3 125	125	76	83	494783	VMB1T	Post-Rear
204550872	Vespa SS 90	90	65	71	610287M	V9SS1T	Post-Rear	204584251	Vespa ET3 125	125	76	83	610290M	VMB1T	Ant-Front
204560182	Vespa SS 90	90	65	71	2466204	V9SS1T	Post-Rear	204584252	Vespa ET3 125	125	76	83	610290M	VMB1T	Ant-Front
204560191	Vespa SS 90	90	65	71	494783	V9SS1T	Post-Rear	204585072	Vespa ET3 125	125	76	83	610290M	VMB1T	Ant-Front
204560192	Vespa SS 90	90	65	71	494783	V9SS1T	Post-Rear	204585082	Vespa ET3 125	125	76	83	1379364	VMB1T	Ant-Front
204560193	Vespa SS 90	90	65	71	494783	V9SS1T	Post-Rear	204585092	Vespa ET3 125	125	76	83	610290M	VMB1T	Ant-Front
204584242	Vespa SS 90	90	65	71	1379364	V9SS1T	Ant-Front	204550872	Vespa Gt 125	125	66	73	610287M	VNL2T	Post-Rear
204584243	Vespa SS 90	90	65	71	1379364	V9SS1T	Ant-Front	204560182	Vespa Gt 125	125	66	73	2466204	VNL2T	Post-Rear
204584251	Vespa SS 90	90	65	71	610290M	V9SS1T	Ant-Front	204560191	Vespa Gt 125	125	66	73	494783	VNL2T	Post-Rear
204584252	Vespa SS 90	90	65	71	610290M	V9SS1T	Ant-Front	204560192	Vespa Gt 125	125	66	73	494783	VNL2T	Post-Rear
204585072	Vespa SS 90	90	65	71	610290M	V9SS1T	Ant-Front	204560193	Vespa Gt 125	125	66	73	494783	VNL2T	Post-Rear
204585092	Vespa SS 90	90	65	71	610290M	V9SS1T	Ant-Front	204584272	Vespa Gt 125	125	66	73	1375714	VNL2T	Ant-Front
204550382	Vespa Pk 100 S	100	82	82	266403	V9X1T	Post-Rear	204585062	Vespa Gt 125	125	66	73	1375714001	VNL2T	Ant-Front
204560201	Vespa Pk 100 S	100	82	82	266403	V9X1T	Post-Rear	204550872	Vespa Gtr 125	125	69	78	610287M	VNL2T	Post-Rear



AMMORTIZZATORI PIAGGIO VESPA

PIAGGIO VESPA SHOCK ABSORBERS

Codice RMS Code	Modello - Model	CC	Da - From		Riferimento Originale Oem number	Codice Telaio Frame Code	Ant-Front Post-Rear	Codice RMS Code	Modello - Model	CC	Da - From		Riferimento Originale Oem number	Codice Telaio Frame Code	Ant-Front Post-Rear
			A - To	A - To							A - To	A - To			
204560182	Vespa Gtr 125	125	69	78	2466204	VNL2T	Post-Rear	204560212	Vespa Pk 125 XL	125	86	86	2664264	VMX6T	Post-Rear
204560191	Vespa Gtr 125	125	69	78	494783	VNL2T	Post-Rear	204584262	Vespa Pk 125 XL	125	86	86	2665384	VMX6T	Ant-Front
204560192	Vespa Gtr 125	125	69	78	494783	VNL2T	Post-Rear	204584302	Vespa Pk 125 XL	125	86	86	-	VMX6T	Ant-Front
204560193	Vespa Gtr 125	125	69	78	494783	VNL2T	Post-Rear	204550382	Vespa Pk 125 XL Elestart	125	86	86	266403	VMX6T	Post-Rear
204550872	Vespa Nuova 125	125	65	67	610287M	VMA1T	Post-Rear	204560201	Vespa Pk 125 XL Elestart	125	86	86	266403	VMX6T	Post-Rear
204560182	Vespa Nuova 125	125	65	67	2466204	VMA1T	Post-Rear	204560202	Vespa Pk 125 XL Elestart	125	86	86	266403	VMX6T	Post-Rear
204560191	Vespa Nuova 125	125	65	67	494783	VMA1T	Post-Rear	204560212	Vespa Pk 125 XL Elestart	125	86	86	2664264	VMX6T	Post-Rear
204560192	Vespa Nuova 125	125	65	67	494783	VMA1T	Post-Rear	204584262	Vespa Pk 125 XL Elestart	125	86	86	2665384	VMX6T	Ant-Front
204560193	Vespa Nuova 125	125	65	67	494783	VMA1T	Post-Rear	204584302	Vespa Pk 125 XL Elestart	125	86	86	-	VMX6T	Ant-Front
204584242	Vespa Nuova 125	125	65	67	1379364	VMA1T	Ant-Front	204550382	Vespa Pk 125 XL Plurimatic	125	89	89	266403	VMX6T	Post-Rear
204584243	Vespa Nuova 125	125	65	67	1379364	VMA1T	Ant-Front	204560201	Vespa Pk 125 XL Plurimatic	125	89	89	266403	VMX6T	Post-Rear
204584251	Vespa Nuova 125	125	65	67	610290M	VMA1T	Ant-Front	204560202	Vespa Pk 125 XL Plurimatic	125	89	89	266403	VMX6T	Post-Rear
204584252	Vespa Nuova 125	125	65	67	610290M	VMA1T	Ant-Front	204560212	Vespa Pk 125 XL Plurimatic	125	89	89	2664264	VMX6T	Post-Rear
204585072	Vespa Nuova 125	125	65	67	610290M	VMA1T	Ant-Front	204550872	Vespa Primavera 125	125	67	83	610287M	VMA2T	Post-Rear
204585092	Vespa Nuova 125	125	65	67	610290M	VMA1T	Ant-Front	204560182	Vespa Primavera 125	125	67	83	2466204	VMA2T	Post-Rear
204584292	Vespa P 125 E	125	81	81	56187R	VNX2T	Ant-Front	204560191	Vespa Primavera 125	125	67	83	494783	VMA2T	Post-Rear
204584312	Vespa P 125 E	125	81	81	56187R	VNX2T	Ant-Front	204560192	Vespa Primavera 125	125	67	83	494783	VMA2T	Post-Rear
204584402	Vespa P 125 E	125	81	81	2329284	VNX2T	Ant-Front	204560193	Vespa Primavera 125	125	67	83	494783	VMA2T	Post-Rear
204584412	Vespa P 125 E	125	81	81	56187R	VNX2T	Ant-Front	204584242	Vespa Primavera 125	125	67	83	1379364	VMA2T	Ant-Front
204585052	Vespa P 125 E	125	81	81	56187R	VNX2T	Ant-Front	204584243	Vespa Primavera 125	125	67	83	1379364	VMA2T	Ant-Front
204550872	Vespa P 125 X	125	77	82	610287M	VNX1T	Post-Rear	204584251	Vespa Primavera 125	125	67	83	610290M	VMA2T	Ant-Front
204560182	Vespa P 125 X	125	77	82	2466204	VNX1T	Post-Rear	204584252	Vespa Primavera 125	125	67	83	610290M	VMA2T	Ant-Front
204560191	Vespa P 125 X	125	77	82	494783	VNX1T	Post-Rear	204585072	Vespa Primavera 125	125	67	83	610290M	VMA2T	Ant-Front
204560192	Vespa P 125 X	125	77	82	494783	VNX1T	Post-Rear	204585092	Vespa Primavera 125	125	67	83	610290M	VMA2T	Ant-Front
204560193	Vespa P 125 X	125	77	82	494783	VNX1T	Post-Rear	204550412	Vespa Px 125	125	11	16	561882	M74100	Post-Rear
204584292	Vespa P 125 X	125	77	82	56187R	VNX1T	Ant-Front	204560272	Vespa Px 125	125	11	16	561882	M74100	Post-Rear
204584312	Vespa P 125 X	125	77	82	56187R	VNX1T	Ant-Front	204584332	Vespa Px 125	125	11	16	65187R	M74100	Post-Rear
204584392	Vespa P 125 X	125	77	82	2329284	VNX1T	Ant-Front	204585043	Vespa Px 125	125	11	16	65187R	M74100	Post-Rear
204584412	Vespa P 125 X	125	77	82	56187R	VNX1T	Ant-Front	204550412	Vespa Px 125 30 anni	125	07	08	561882	M09302	Post-Rear
204585052	Vespa P 125 X	125	77	82	56187R	VNX1T	Ant-Front	204560272	Vespa Px 125 30 anni	125	07	08	561882	M09302	Post-Rear
204550382	Vespa Pk 125	125	82	82	266403	VMX1T	Post-Rear	204584332	Vespa Px 125 30 anni	125	07	08	65187R	M09302	Post-Rear
204560201	Vespa Pk 125	125	82	82	266403	VMX1T	Post-Rear	204584342	Vespa Px 125 30 anni	125	07	08	-	M09302	Ant-Front
204560202	Vespa Pk 125	125	82	82	266403	VMX1T	Post-Rear	204585043	Vespa Px 125 30 anni	125	07	08	65187R	M09302	Post-Rear
204560212	Vespa Pk 125	125	82	82	2664264	VMX1T	Post-Rear	204584292	Vespa Px 125 E Arcobaleno	125	83	83	56187	VNX2T	Ant-Front
204550382	Vespa Pk 125 Ets	125	84	84	266403	VMS1T	Post-Rear	204584312	Vespa Px 125 E Arcobaleno	125	83	83	56187R	VNX2T	Ant-Front
204560201	Vespa Pk 125 Ets	125	84	84	266403	VMS1T	Post-Rear	204584412	Vespa Px 125 E Arcobaleno	125	83	83	56187R	VNX2T	Ant-Front
204560202	Vespa Pk 125 Ets	125	84	84	266403	VMS1T	Post-Rear	204584292	Vespa Px 125 E Elestart	125	84	84	56187R	VNX2T	Ant-Front
204560212	Vespa Pk 125 Ets	125	84	84	2664264	VMS1T	Post-Rear	204584312	Vespa Px 125 E Elestart	125	84	84	56187R	VNX2T	Ant-Front
204550382	Vespa Pk 125 Ets Elestart	125	84	84	266403	VMS1T	Post-Rear	204584412	Vespa Px 125 E Elestart	125	84	84	56187R	VNX2T	Ant-Front
204560201	Vespa Pk 125 Ets Elestart	125	84	84	266403	VMS1T	Post-Rear	204550412	Vespa PX 125 E Freno a Disco	125	98	01	561882	VNX2T	Post-Rear
204560202	Vespa Pk 125 Ets Elestart	125	84	84	266403	VMS1T	Post-Rear	204560272	Vespa PX 125 E Freno a Disco	125	98	01	561882	VNX2T	Post-Rear
204560212	Vespa Pk 125 Ets Elestart	125	84	84	2664264	VMS1T	Post-Rear	204584332	Vespa PX 125 E Freno a Disco	125	98	01	65187R	VNX2T	Post-Rear
204550382	Vespa Pk 125 S	125	82	82	266403	VMX5T	Post-Rear	204584342	Vespa PX 125 E Freno a Disco	125	98	01	-	VNX2T	Ant-Front
204560201	Vespa Pk 125 S	125	82	82	266403	VMX5T	Post-Rear	204585043	Vespa PX 125 E Freno a Disco	125	98	01	65187R	VNX2T	Post-Rear
204560202	Vespa Pk 125 S	125	82	82	266403	VMX5T	Post-Rear	204550412	Vespa Px 125 euro 2	125	07	08	561882	M09302	Post-Rear
204560212	Vespa Pk 125 S	125	82	82	2664264	VMX5T	Post-Rear	204560272	Vespa Px 125 euro 2	125	07	08	561882	M09302	Post-Rear
204550382	Vespa Pk 125 S Aut. Elestart	125	85	85	266403	VVM1T	Post-Rear	204584332	Vespa Px 125 euro 2	125	07	08	65187R	M09302	Post-Rear
204560201	Vespa Pk 125 S Aut. Elestart	125	85	85	266403	VVM1T	Post-Rear	204584342	Vespa Px 125 euro 2	125	07	08	-	M09302	Ant-Front
204560202	Vespa Pk 125 S Aut. Elestart	125	85	85	266403	VVM1T	Post-Rear	204585043	Vespa Px 125 euro 2	125	07	08	65187R	M09302	Post-Rear
204550382	Vespa Pk 125 S Elestart	125	83	83	266403	VMX5T	Post-Rear	204584292	Vespa Px 125 T5	125	85	85	56187R	VNX5T	Ant-Front
204560201	Vespa Pk 125 S Elestart	125	83	83	266403	VMX5T	Post-Rear	204584312	Vespa Px 125 T5	125	85	85	56187R	VNX5T	Ant-Front
204560202	Vespa Pk 125 S Elestart	125	83	83	266403	VMX5T	Post-Rear	204584402	Vespa Px 125 T5	125	85	85	2329284	VNX5T	Ant-Front
204550382	Vespa Pk 125 XL	125	86	86	266403	VMX6T	Post-Rear	204584412	Vespa Px 125 T5	125	85	85	56187R	VNX5T	Ant-Front
204560201	Vespa Pk 125 XL	125	86	86	266403	VMX6T	Post-Rear	204584292	Vespa Px 125 T5 Elestart	125	86	86	56187R	VNX5T	Ant-Front
204560202	Vespa Pk 125 XL	125	86	86	266403	VMX6T	Post-Rear	204584312	Vespa Px 125 T5 Elestart	125	86	86	56187R	VNX5T	Ant-Front



Codice RMS Code	Modello - Model	CC	Da - From	A - To	Riferimento Originale Oem number	Codice Telaio Frame Code	Ant-Front Post-Rear	Codice RMS Code	Modello - Model	CC	Da - From	A - To	Riferimento Originale Oem number	Codice Telaio Frame Code	Ant-Front Post-Rear
204584402	Vespa Px 125 T5 Elestart	125	86	86	2329284	VNX5T	Ant-Front	204584342	Vespa Px 150	150	11	16	-	M74200	Ant-Front
204584412	Vespa Px 125 T5 Elestart	125	86	86	56187R	VNX5T	Ant-Front	204585043	Vespa Px 150	150	11	16	65187R	M74200	Post-Rear
204550872	Vespa Super 125	125	66	68	610287M	VNC1T	Post-Rear	204584292	Vespa Px 150 E	150	81	81	56187R	VLX1T	Ant-Front
204560182	Vespa Super 125	125	66	68	2466204	VNC1T	Post-Rear	204584312	Vespa Px 150 E	150	81	81	56187R	VLX1T	Ant-Front
204560191	Vespa Super 125	125	66	68	494783	VNC1T	Post-Rear	204584402	Vespa Px 150 E	150	81	81	2329284	VLX1T	Ant-Front
204560192	Vespa Super 125	125	66	68	494783	VNC1T	Post-Rear	204584412	Vespa Px 150 E	150	81	81	56187R	VLX1T	Ant-Front
204560193	Vespa Super 125	125	66	68	494783	VNC1T	Post-Rear	204585052	Vespa Px 150 E	150	81	81	56187R	VLX1T	Ant-Front
204584272	Vespa Super 125	125	66	68	1375714	VNC1T	Ant-Front	204584292	Vespa Px 150 E Arcobaleno	150	83	83	56187R		Ant-Front
204585062	Vespa Super 125	125	66	68	1375714001	VNC1T	Ant-Front	204584312	Vespa Px 150 E Arcobaleno	150	83	83	56187R		Ant-Front
204550872	Vespa Ts 125	125	75	78	610287M	VNL3T	Post-Rear	204584412	Vespa Px 150 E Arcobaleno	150	83	83	56187R		Ant-Front
204560182	Vespa Ts 125	125	75	78	2466204	VNL3T	Post-Rear	204584292	Vespa Px 150 E Elestart	150	84	84	56187R		Ant-Front
204560191	Vespa Ts 125	125	75	78	494783	VNL3T	Post-Rear	204584312	Vespa Px 150 E Elestart	150	84	84	56187R		Ant-Front
204560192	Vespa Ts 125	125	75	78	494783	VNL3T	Post-Rear	204584412	Vespa Px 150 E Elestart	150	84	84	56187R		Ant-Front
204560193	Vespa Ts 125	125	75	78	494783	VNL3T	Post-Rear	204550412	Vespa PX 150 E Freno a Disco	150	98	01	561882	VLX1T	Post-Rear
204584272	Vespa Ts 125	125	75	78	1375714	VNL3T	Ant-Front	204560272	Vespa PX 150 E Freno a Disco	150	98	01	561882	VLX1T	Post-Rear
204585062	Vespa Ts 125	125	75	78	1375714001	VNL3T	Ant-Front	204584332	Vespa PX 150 E Freno a Disco	150	98	01	65187R	VLX1T	Post-Rear
204550892	Cosa 1 150	150	88	91	2681414	VLR1T	Post-Rear	204584342	Vespa PX 150 E Freno a Disco	150	98	01	-	VLX1T	Ant-Front
204585102	Cosa 1 150	150	88	91	2679244	VLR1T	Ant-Front	204585043	Vespa PX 150 E Freno a Disco	150	98	01	65187R	VLX1T	Post-Rear
204550892	Cosa 2 150	150	91	97	2681414	VLR1	Post-Rear	204550872	Vespa Sprint 150	150	65	74	610287M	VLB1T	Post-Rear
204585102	Cosa 2 150	150	91	97	2679244	VLR1	Ant-Front	204560182	Vespa Sprint 150	150	65	74	2466204	VLB1T	Post-Rear
204560242	Vespa 150	150	59	60	83816	VBA1T	Post-Rear	204560191	Vespa Sprint 150	150	65	74	494783	VLB1T	Post-Rear
204585062	Vespa 150	150	59	60	1375714001	VBA1T	Ant-Front	204560192	Vespa Sprint 150	150	65	74	494783	VLB1T	Post-Rear
204560242	Vespa 150	150	61	62	83816	VBB1T	Post-Rear	204560193	Vespa Sprint 150	150	65	74	494783	VLB1T	Post-Rear
204585062	Vespa 150	150	61	62	1375714001	VBB1T	Ant-Front	204584272	Vespa Sprint 150	150	65	74	1375714	VLB1T	Ant-Front
204550872	Vespa 150	150	63	66	610287M	VBB2T	Post-Rear	204550872	Vespa Sprint Veloce 150	150	69	79	610287M	VLB1T	Post-Rear
204560182	Vespa 150	150	63	66	2466204	VBB2T	Post-Rear	204560182	Vespa Sprint Veloce 150	150	69	79	2466204	VLB1T	Post-Rear
204560191	Vespa 150	150	63	66	494783	VBB2T	Post-Rear	204560191	Vespa Sprint Veloce 150	150	69	79	494783	VLB1T	Post-Rear
204560192	Vespa 150	150	63	66	494783	VBB2T	Post-Rear	204560192	Vespa Sprint Veloce 150	150	69	79	494783	VLB1T	Post-Rear
204560193	Vespa 150	150	63	66	494783	VBB2T	Post-Rear	204560193	Vespa Sprint Veloce 150	150	69	79	494783	VLB1T	Post-Rear
204585062	Vespa 150	150	63	66	1375714001	VBB2T	Ant-Front	204550872	Vespa Super 150	150	65	79	610287M	VBC1T	Post-Rear
204550872	Vespa Gl 150	150	63	64	610287M	VLA1T	Post-Rear	204560182	Vespa Super 150	150	65	79	2466204	VBC1T	Post-Rear
204560182	Vespa Gl 150	150	63	64	2466204	VLA1T	Post-Rear	204560191	Vespa Super 150	150	65	79	494783	VBC1T	Post-Rear
204560191	Vespa Gl 150	150	63	64	494783	VLA1T	Post-Rear	204560192	Vespa Super 150	150	65	79	494783	VBC1T	Post-Rear
204560192	Vespa Gl 150	150	63	64	494783	VLA1T	Post-Rear	204560193	Vespa Super 150	150	65	79	494783	VBC1T	Post-Rear
204560193	Vespa Gl 150	150	63	64	494783	VLA1T	Post-Rear	204584272	Vespa Super 150	150	65	79	1375714	VBC1T	Ant-Front
204560242	Vespa Gl 150	150	63	64	83816	VLA1T	Post-Rear	204585062	Vespa Super 150	150	65	79	1375714001	VBC1T	Ant-Front
204585062	Vespa Gl 150	150	63	64	1375714001	VLA1T	Ant-Front	204550872	Vespa GS 160	160	62	64	610287M	VSB1T	Post-Rear
204585062	Vespa GS 150	150	59	61	1375714001	V5S1T	Ant-Front	204560182	Vespa GS 160	160	62	64	2466204	VSB1T	Post-Rear
204550872	Vespa P 150 S	150	78	84	610287M	VBX1T	Post-Rear	204560191	Vespa GS 160	160	62	64	494783	VSB1T	Post-Rear
204560182	Vespa P 150 S	150	78	84	2466204	VBX1T	Post-Rear	204560192	Vespa GS 160	160	62	64	494783	VSB1T	Post-Rear
204560191	Vespa P 150 S	150	78	84	494783	VBX1T	Post-Rear	204560193	Vespa GS 160	160	62	64	494783	VSB1T	Post-Rear
204560192	Vespa P 150 S	150	78	84	494783	VBX1T	Post-Rear	204550872	Vespa Rally 180	180	68	73	610287M	VSD1T	Post-Rear
204560193	Vespa P 150 S	150	78	84	494783	VBX1T	Post-Rear	204560182	Vespa Rally 180	180	68	73	2466204	VSD1T	Post-Rear
204584272	Vespa P 150 S	150	78	84	1375714	VBX1T	Ant-Front	204560191	Vespa Rally 180	180	68	73	494783	VSD1T	Post-Rear
204550872	Vespa P 150 X	150	78	81	610287M	VLX1T	Post-Rear	204560192	Vespa Rally 180	180	68	73	494783	VSD1T	Post-Rear
204560182	Vespa P 150 X	150	78	81	2466204	VLX1T	Post-Rear	204560193	Vespa Rally 180	180	68	73	494783	VSD1T	Post-Rear
204560191	Vespa P 150 X	150	78	81	494783	VLX1T	Post-Rear	204584272	Vespa Rally 180	180	68	73	1375714	VSD1T	Ant-Front
204560192	Vespa P 150 X	150	78	81	494783	VLX1T	Post-Rear	204585062	Vespa Rally 180	180	68	73	1375714001	VSD1T	Ant-Front
204560193	Vespa P 150 X	150	78	81	494783	VLX1T	Post-Rear	204550872	Vespa SS 180	180	65	68	610287M	VSC1T	Post-Rear
204584292	Vespa P 150 X	150	78	81	56187R	VLX1T	Ant-Front	204560182	Vespa SS 180	180	65	68	2466204	VSC1T	Post-Rear
204584312	Vespa P 150 X	150	78	81	56187R	VLX1T	Ant-Front	204560191	Vespa SS 180	180	65	68	494783	VSC1T	Post-Rear
204584392	Vespa P 150 X	150	78	81	2329284	VLX1T	Ant-Front	204560192	Vespa SS 180	180	65	68	494783	VSC1T	Post-Rear
204584412	Vespa P 150 X	150	78	81	56187R	VLX1T	Ant-Front	204560193	Vespa SS 180	180	65	68	494783	VSC1T	Post-Rear
204585052	Vespa P 150 X	150	78	81	56187R	VLX1T	Ant-Front	204550892	Cosa 1 200	200	88	91	2681414	VSR1T	Post-Rear
204584332	Vespa Px 150	150	11	16	65187R	M74200	Post-Rear	204585102	Cosa 1 200	200	88	91	2679244	VSR1T	Ant-Front



AMMORTIZZATORI PIAGGIO VESPA

PIAGGIO VESPA SHOCK ABSORBERS

Codice RMS Code	Modello - Model	CC	Da - From		Riferimento Originale Oem number	Codice Telaio Frame Code	Ant -Front Post-Rear	Codice RMS Code	Modello - Model	CC	Da - From		Riferimento Originale Oem number	Codice Telaio Frame Code	Ant -Front Post-Rear
			A - To	A - To							A - To	A - To			
204550892	Cosa 2 200	200	91	97	2681414	VSR1T	Post-Rear	204560262	Lambretta 150 Li 2 Serie	150	60	60	19058120		Post-Rear
204585102	Cosa 2 200	200	91	97	2679244	VSR1T	Ant-Front	204585123	Lambretta 150 Li 3 Serie	150	62	67	19060290		Ant-Front
204550872	Vespa P 200 X	200	77	77	610287M	VSX1T	Post-Rear	204585133	Lambretta 150 Li 3 Serie	150	62	67	-		Ant-Front
204560182	Vespa P 200 X	200	77	77	2466204	VSX1T	Post-Rear	204560252	Lambretta 150 Li 3 Serie	150	62	67	19058100		Post-Rear
204560191	Vespa P 200 X	200	77	77	494783	VSX1T	Post-Rear	204560292	Lambretta 150 Li 3 Serie	150	62	67	19058100		Post-Rear
204560192	Vespa P 200 X	200	77	77	494783	VSX1T	Post-Rear	204560252	Lambretta 150 Li Special Sx	150	66	68	19058100		Post-Rear
204560193	Vespa P 200 X	200	77	77	494783	VSX1T	Post-Rear	204560292	Lambretta 150 Li Special Sx	150	66	68	19058100		Post-Rear
204584292	Vespa P 200 X	200	77	77	56187R	VSX1T	Ant-Front	204560252	Lambretta 200 DL	200	69	71	19058100		Post-Rear
204584392	Vespa P 200 X	200	77	77	2329284	VSX1T	Ant-Front	204560292	Lambretta 200 DL	200	69	71	19058100		Post-Rear
204585052	Vespa P 200 X	200	77	77	56187R	VSX1T	Ant-Front	204585123	Lambretta 200 Li Special Sx	200	66	68	19060290		Ant-Front
204550872	Vespa PX 200 E	200	77	82	610287M	VSX1T	Post-Rear	204585133	Lambretta 200 Li Special Sx	200	66	68	-		Ant-Front
204560182	Vespa PX 200 E	200	77	82	2466204	VSX1T	Post-Rear	204560252	Lambretta 200 Li Special Sx	200	66	68	19058100		Post-Rear
204560191	Vespa PX 200 E	200	77	82	494783	VSX1T	Post-Rear	204560292	Lambretta 200 Li Special Sx	200	66	68	19058100		Post-Rear
204560192	Vespa PX 200 E	200	77	82	494783	VSX1T	Post-Rear								
204560193	Vespa PX 200 E	200	77	82	494783	VSX1T	Post-Rear								
204584292	Vespa PX 200 E	200	77	82	56187R	VSX1T	Ant-Front								
204584312	Vespa PX 200 E	200	77	82	56187R	VSX1T	Ant-Front								
204584392	Vespa PX 200 E	200	77	82	2329284	VSX1T	Ant-Front								
204584412	Vespa PX 200 E	200	77	82	56187R	VSX1T	Ant-Front								
204585052	Vespa PX 200 E	200	77	82	56187R	VSX1T	Ant-Front								
204584292	Vespa PX 200 E	200	82	82	56187R	VSX1T	Ant-Front								
204584312	Vespa PX 200 E	200	82	82	56187R	VSX1T	Ant-Front								
204584412	Vespa PX 200 E	200	82	82	56187R	VSX1T	Ant-Front								
204585052	Vespa PX 200 E	200	82	82	56187R	VSX1T	Ant-Front								
204550412	Vespa PX 200 E Freno a Disco	200	98	01	561882	VSX1T	Post-Rear								
204560272	Vespa PX 200 E Freno a Disco	200	98	01	561882	VSX1T	Post-Rear								
204584332	Vespa PX 200 E Freno a Disco	200	98	01	65187R	VSX1T	Post-Rear								
204584342	Vespa PX 200 E Freno a Disco	200	98	01	-	VSX1T	Ant-Front								
204585043	Vespa PX 200 E Freno a Disco	200	98	01	65187R	VSX1T	Post-Rear								
204584292	Vespa PX 200 E Arcobaleno	200	83	84	56187R	VSX1T	Ant-Front								
204584312	Vespa PX 200 E Arcobaleno	200	83	84	56187R	VSX1T	Ant-Front								
204584412	Vespa PX 200 E Arcobaleno	200	83	84	56187R	VSX1T	Ant-Front								
204584292	Vespa PX 200 E Elestart	200	81	90	56187R	VSX1T	Ant-Front								
204584312	Vespa PX 200 E Elestart	200	81	90	56187R	VSX1T	Ant-Front								
204584402	Vespa PX 200 E Elestart	200	81	90	2329284	VSX1T	Ant-Front								
204584412	Vespa PX 200 E Elestart	200	81	90	56187R	VSX1T	Ant-Front								
204585052	Vespa PX 200 E Elestart	200	81	90	56187R	VSX1T	Ant-Front								
204550872	Vespa Rally 200	200	72	79	610287M	VSE1T	Post-Rear								
204560182	Vespa Rally 200	200	72	79	2466204	VSE1T	Post-Rear								
204560191	Vespa Rally 200	200	72	79	494783	VSE1T	Post-Rear								
204560192	Vespa Rally 200	200	72	79	494783	VSE1T	Post-Rear								
204560193	Vespa Rally 200	200	72	79	494783	VSE1T	Post-Rear								
204584272	Vespa Rally 200	200	72	79	1375714	VSE1T	Ant-Front								
204585062	Vespa Rally 200	200	72	79	1375714001	VSE1T	Ant-Front								
INNOCENTI															
204560252	Lambretta 125 DL	125	69	71	19058100		Post-Rear								
204560292	Lambretta 125 DL	125	69	71	19058100		Post-Rear								
204585123	Lambretta 125 Li 3 Serie	125	61	67	19060290		Ant-Front								
204585133	Lambretta 125 Li 3 Serie	125	61	67	-		Ant-Front								
204560252	Lambretta 125 Li 3 Serie	125	61	67	19058100		Post-Rear								
204560292	Lambretta 125 Li 3 Serie	125	61	67	19058100		Post-Rear								
204560252	Lambretta 125 Li Special	125	66	68	19058100		Post-Rear								
204560292	Lambretta 125 Li Special	125	66	68	19058100		Post-Rear								
204560252	Lambretta 150 DL	150	69	71	19058100		Post-Rear								
204560292	Lambretta 150 DL	150	69	71	19058100		Post-Rear								

AMMORTIZZATORI PIAGGIO VESPA

PIAGGIO VESPA SHOCK ABSORBERS



20 455 0382						-	
LUNGHEZZA LENGHT (mm)	ATTACCO SUPERIORE UPPER FASTENING POINT			ATTACCO INFERIORE LOWER FASTENING POINT			
	Tipo-Type	D (mm)	W (mm)	Tipo-Type	D (mm)	W (mm)	
353		M9x1,25	24		9,6	47	
20 455 0412							
LUNGHEZZA LENGHT (mm)	ATTACCO SUPERIORE UPPER FASTENING POINT			ATTACCO INFERIORE LOWER FASTENING POINT			
	Tipo-Type	D (mm)	W (mm)	Tipo-Type	D (mm)	W (mm)	
391		M9x1,25	16		9,6	47	
20 455 0872							
LUNGHEZZA LENGHT (mm)	ATTACCO SUPERIORE UPPER FASTENING POINT			ATTACCO INFERIORE LOWER FASTENING POINT			
	Tipo-Type	D (mm)	W (mm)	Tipo-Type	D (mm)	W (mm)	
348		M9x1,25	16		9,6	47	
20 455 0892						-	
LUNGHEZZA LENGHT (mm)	ATTACCO SUPERIORE UPPER FASTENING POINT			ATTACCO INFERIORE LOWER FASTENING POINT			
	Tipo-Type	D (mm)	W (mm)	Tipo-Type	D (mm)	W (mm)	
453		M9x1,25	22		10	50	
20 455 0182						-	
LUNGHEZZA LENGHT (mm)	ATTACCO SUPERIORE UPPER FASTENING POINT			ATTACCO INFERIORE LOWER FASTENING POINT			
	Tipo-Type	D (mm)	W (mm)	Tipo-Type	D (mm)	W (mm)	
348		M9x1,25	16		9,6	47	
20 456 0191 NEW						-	
LUNGHEZZA LENGHT (mm)	ATTACCO SUPERIORE UPPER FASTENING POINT			ATTACCO INFERIORE LOWER FASTENING POINT			
	Tipo-Type	D (mm)	W (mm)	Tipo-Type	D (mm)	W (mm)	
344		M9x1,25	16		9,8	47	
20 456 0192						-	
LUNGHEZZA LENGHT (mm)	ATTACCO SUPERIORE UPPER FASTENING POINT			ATTACCO INFERIORE LOWER FASTENING POINT			
	Tipo-Type	D (mm)	W (mm)	Tipo-Type	D (mm)	W (mm)	
344		M9x1,25	16		9,6	47	
20 456 0193							
LUNGHEZZA LENGHT (mm)	ATTACCO SUPERIORE UPPER FASTENING POINT			ATTACCO INFERIORE LOWER FASTENING POINT			
	Tipo-Type	D (mm)	W (mm)	Tipo-Type	D (mm)	W (mm)	
344		M9x1,25	16		9,6	47	
20 456 0201 NEW						-	
LUNGHEZZA LENGHT (mm)	ATTACCO SUPERIORE UPPER FASTENING POINT			ATTACCO INFERIORE LOWER FASTENING POINT			
	Tipo-Type	D (mm)	W (mm)	Tipo-Type	D (mm)	W (mm)	
348		M8x1,0	30		9,6	47	
20 456 0202						-	
LUNGHEZZA LENGHT (mm)	ATTACCO SUPERIORE UPPER FASTENING POINT			ATTACCO INFERIORE LOWER FASTENING POINT			
	Tipo-Type	D (mm)	W (mm)	Tipo-Type	D (mm)	W (mm)	
348		M8x1,0	30		9,6	47	



AMMORTIZZATORI PIAGGIO VESPA

PIAGGIO VESPA SHOCK ABSORBERS

20 456 0212				-		
LUNGHEZZA LENGHT (mm)	ATTACCO SUPERIORE UPPER FASTENING POINT			ATTACCO INFERIORE LOWER FASTENING POINT		
	Tipo-Type	D (mm)	W (mm)	Tipo-Type	D (mm)	W (mm)
348		M8x1,0	30		9,6	47

20 456 0242				-		
LUNGHEZZA LENGHT (mm)	ATTACCO SUPERIORE UPPER FASTENING POINT			ATTACCO INFERIORE LOWER FASTENING POINT		
	Tipo-Type	D (mm)	W (mm)	Tipo-Type	D (mm)	W (mm)
355		M9x1,25	16		9,2	45

20 456 0252				-		
LUNGHEZZA LENGHT (mm)	ATTACCO SUPERIORE UPPER FASTENING POINT			ATTACCO INFERIORE LOWER FASTENING POINT		
	Tipo-Type	D (mm)	W (mm)	Tipo-Type	D (mm)	W (mm)
305		18	33		18	33

20 456 0262				-		
LUNGHEZZA LENGHT (mm)	ATTACCO SUPERIORE UPPER FASTENING POINT			ATTACCO INFERIORE LOWER FASTENING POINT		
	Tipo-Type	D (mm)	W (mm)	Tipo-Type	D (mm)	W (mm)
317		18	33		18	33

20 456 0272				-		
LUNGHEZZA LENGHT (mm)	ATTACCO SUPERIORE UPPER FASTENING POINT			ATTACCO INFERIORE LOWER FASTENING POINT		
	Tipo-Type	D (mm)	W (mm)	Tipo-Type	D (mm)	W (mm)
391		M9x1,25	16		9,6	47

20 456 0282				-		
LUNGHEZZA LENGHT (mm)	ATTACCO SUPERIORE UPPER FASTENING POINT			ATTACCO INFERIORE LOWER FASTENING POINT		
	Tipo-Type	D (mm)	W (mm)	Tipo-Type	D (mm)	W (mm)
344		M9x1,25	16		9,6	47

20 456 0292				-		
LUNGHEZZA LENGHT (mm)	ATTACCO SUPERIORE UPPER FASTENING POINT			ATTACCO INFERIORE LOWER FASTENING POINT		
	Tipo-Type	D (mm)	W (mm)	Tipo-Type	D (mm)	W (mm)
305		18	33		18	33

20 458 4242				-		
LUNGHEZZA LENGHT (mm)	ATTACCO SUPERIORE UPPER FASTENING POINT			ATTACCO INFERIORE LOWER FASTENING POINT		
	Tipo-Type	D (mm)	W (mm)	Tipo-Type	D (mm)	W (mm)
217		M8x1,0	25		14,1	40

20 458 4243 NEW				-		
LUNGHEZZA LENGHT (mm)	ATTACCO SUPERIORE UPPER FASTENING POINT			ATTACCO INFERIORE LOWER FASTENING POINT		
	Tipo-Type	D (mm)	W (mm)	Tipo-Type	D (mm)	W (mm)
217		M8x1,0	25		14,1	40

20 458 4251 NEW				-		
LUNGHEZZA LENGHT (mm)	ATTACCO SUPERIORE UPPER FASTENING POINT			ATTACCO INFERIORE LOWER FASTENING POINT		
	Tipo-Type	D (mm)	W (mm)	Tipo-Type	D (mm)	W (mm)
215		M8x1,0	30		14,1	40

AMMORTIZZATORI PIAGGIO VESPA

PIAGGIO VESPA SHOCK ABSORBERS



20 458 4252							
LUNGHEZZA LENGHT (mm)	ATTACCO SUPERIORE UPPER FASTENING POINT			ATTACCO INFERIORE LOWER FASTENING POINT			
	Tipo-Type	D (mm)	W (mm)	Tipo-Type	D (mm)	W (mm)	
215		M8x1,0	30		14,1	40	
20 458 4262						-	
LUNGHEZZA LENGHT (mm)	ATTACCO SUPERIORE UPPER FASTENING POINT			ATTACCO INFERIORE LOWER FASTENING POINT			
	Tipo-Type	D (mm)	W (mm)	Tipo-Type	D (mm)	W (mm)	
253		M10x1,25	17		M8x1,25	35	
20 458 4272						-	
LUNGHEZZA LENGHT (mm)	ATTACCO SUPERIORE UPPER FASTENING POINT			ATTACCO INFERIORE LOWER FASTENING POINT			
	Tipo-Type	D (mm)	W (mm)	Tipo-Type	D (mm)	W (mm)	
212		11,2	20		11,2	26	
20 458 4292						-	
LUNGHEZZA LENGHT (mm)	ATTACCO SUPERIORE UPPER FASTENING POINT			ATTACCO INFERIORE LOWER FASTENING POINT			
	Tipo-Type	D (mm)	W (mm)	Tipo-Type	D (mm)	W (mm)	
310		M10x1,25	14		8,1	38	
20 458 4302						-	
LUNGHEZZA LENGHT (mm)	ATTACCO SUPERIORE UPPER FASTENING POINT			ATTACCO INFERIORE LOWER FASTENING POINT			
	Tipo-Type	D (mm)	W (mm)	Tipo-Type	D (mm)	W (mm)	
253		M10x1,25	17		M8x1,25	35	
20 458 4312							
LUNGHEZZA LENGHT (mm)	ATTACCO SUPERIORE UPPER FASTENING POINT			ATTACCO INFERIORE LOWER FASTENING POINT			
	Tipo-Type	D (mm)	W (mm)	Tipo-Type	D (mm)	W (mm)	
310		M10x1,25	14		8,1	38	
20 458 4332						-	
LUNGHEZZA LENGHT (mm)	ATTACCO SUPERIORE UPPER FASTENING POINT			ATTACCO INFERIORE LOWER FASTENING POINT			
	Tipo-Type	D (mm)	W (mm)	Tipo-Type	D (mm)	W (mm)	
310		M10x1,25	14		8,1	38	
20 458 4342							
LUNGHEZZA LENGHT (mm)	ATTACCO SUPERIORE UPPER FASTENING POINT			ATTACCO INFERIORE LOWER FASTENING POINT			
	Tipo-Type	D (mm)	W (mm)	Tipo-Type	D (mm)	W (mm)	
310		M10x1,25	14		M8x1,25	38	
20 458 4362						-	
LUNGHEZZA LENGHT (mm)	ATTACCO SUPERIORE UPPER FASTENING POINT			ATTACCO INFERIORE LOWER FASTENING POINT			
	Tipo-Type	D (mm)	W (mm)	Tipo-Type	D (mm)	W (mm)	
214		M8x1,0	16		14,1	40	
20 458 4392						-	
LUNGHEZZA LENGHT (mm)	ATTACCO SUPERIORE UPPER FASTENING POINT			ATTACCO INFERIORE LOWER FASTENING POINT			
	Tipo-Type	D (mm)	W (mm)	Tipo-Type	D (mm)	W (mm)	
310		M10x1,25	12,5		8,5	38	



AMMORTIZZATORI PIAGGIO VESPA

PIAGGIO VESPA SHOCK ABSORBERS

20 458 4402				-		
LUNGHEZZA LENGHT (mm)	ATTACCO SUPERIORE UPPER FASTENING POINT			ATTACCO INFERIORE LOWER FASTENING POINT		
	Tipo-Type	D (mm)	W (mm)	Tipo-Type	D (mm)	W (mm)
310		M10x1,25	14		8,1	38

20 458 4412 NEW						
LUNGHEZZA LENGHT (mm)	ATTACCO SUPERIORE UPPER FASTENING POINT			ATTACCO INFERIORE LOWER FASTENING POINT		
	Tipo-Type	D (mm)	W (mm)	Tipo-Type	D (mm)	W (mm)
310		M10x1,25	14		8,1	38

20 458 5043						
LUNGHEZZA LENGHT (mm)	ATTACCO SUPERIORE UPPER FASTENING POINT			ATTACCO INFERIORE LOWER FASTENING POINT		
	Tipo-Type	D (mm)	W (mm)	Tipo-Type	D (mm)	W (mm)
310		M10x1,25	12,5		8,5	38

20 458 5052				-		
LUNGHEZZA LENGHT (mm)	ATTACCO SUPERIORE UPPER FASTENING POINT			ATTACCO INFERIORE LOWER FASTENING POINT		
	Tipo-Type	D (mm)	W (mm)	Tipo-Type	D (mm)	W (mm)
324		M10x1,25	14		8,1	38

20 458 5062				-		
LUNGHEZZA LENGHT (mm)	ATTACCO SUPERIORE UPPER FASTENING POINT			ATTACCO INFERIORE LOWER FASTENING POINT		
	Tipo-Type	D (mm)	W (mm)	Tipo-Type	D (mm)	W (mm)
212		11,2	20		11,2	26

20 458 5072						
LUNGHEZZA LENGHT (mm)	ATTACCO SUPERIORE UPPER FASTENING POINT			ATTACCO INFERIORE LOWER FASTENING POINT		
	Tipo-Type	D (mm)	W (mm)	Tipo-Type	D (mm)	W (mm)
217		M8x1,0	16		14,1	40

20 458 5082				-		
LUNGHEZZA LENGHT (mm)	ATTACCO SUPERIORE UPPER FASTENING POINT			ATTACCO INFERIORE LOWER FASTENING POINT		
	Tipo-Type	D (mm)	W (mm)	Tipo-Type	D (mm)	W (mm)
220		M8x1,0	14		14	40

20 458 5092						
LUNGHEZZA LENGHT (mm)	ATTACCO SUPERIORE UPPER FASTENING POINT			ATTACCO INFERIORE LOWER FASTENING POINT		
	Tipo-Type	D (mm)	W (mm)	Tipo-Type	D (mm)	W (mm)
220		M8x1,0	14		14	40

20 458 5102				-		
LUNGHEZZA LENGHT (mm)	ATTACCO SUPERIORE UPPER FASTENING POINT			ATTACCO INFERIORE LOWER FASTENING POINT		
	Tipo-Type	D (mm)	W (mm)	Tipo-Type	D (mm)	W (mm)
312		M10x1,25	12		8	38

20 458 5123 NEW				-		
LUNGHEZZA LENGHT (mm)	ATTACCO SUPERIORE UPPER FASTENING POINT			ATTACCO INFERIORE LOWER FASTENING POINT		
	Tipo-Type	D (mm)	W (mm)	Tipo-Type	D (mm)	W (mm)
237		6	22,2		6	22,2



20 458 5133 NEW						-
LUNGHEZZA LENGHT (mm)	ATTACCO SUPERIORE UPPER FASTENING POINT			ATTACCO INFERIORE LOWER FASTENING POINT		
	Tipo-Type	D (mm)	W (mm)	Tipo-Type	D (mm)	W (mm)
237		6	22,2		6	22,2

	Posteriore <i>Rear</i>
	Anteriore <i>Front</i>
	Precarico molla a camma <i>Step spring preload</i>
	Precarico molla con ghiera filettata <i>Threaded spring preload</i>
	Attacco ad occhiello <i>End eye fastening point</i>
	Attacco a forchetta <i>Fork fastening point</i>
	Attacco con perno <i>Stud fastening point</i>
	Attacco con doppia vite <i>Two bolts fastening point</i>



AMMORTIZZATORI PIAGGIO APE

PIAGGIO APE SHOCK ABSORBERS

Codice RMS RMS Code	Modello - Model	CC	Da - From	A - To	Rif. Originale Oem number	Ant-Front Post-Rear
20 456 5002	Ape FL - FL2	50	89	95	2682514	Post-Rear
20 456 5002	Ape FL3 Europa	50	96	99	2682514	Post-Rear
20 456 5002	Ape P	50	80	85	2682514	Post-Rear
20 456 5002	Ape Rst Mix	50	99	03	2682514	Post-Rear
20 456 5002	Ape Tm P	50	85	89	2682514	Post-Rear
20 456 5002	Ape	50	09	16	646464	Post-Rear
20 456 5002	Ape Mix 2T	50	98	08	56597R	Post-Rear
20 456 5012	Ape Car P2-P3	220	78	85	566504	Post-Rear
20 456 5012	Ape Car P2-P3	220	78	85	566504	Post-Rear
20 458 5002	Ape Mix 2T	50	98	08	646463	Ant-Front
20 458 5002	Ape	50	09	16	646463	Ant-Front
20 458 5002	Ape FL - FL2	50	89	95	566502	Ant-Front
20 458 5002	Ape FL3 Europa	50	96	99	566502	Ant-Front
20 458 5002	Ape P	50	80	85	566502	Ant-Front

Codice RMS RMS Code	Modello - Model	CC	Da - From	A - To	Rif. Originale Oem number	Ant-Front Post-Rear
20 458 5002	Ape Rst Mix	50	99	03	566502	Ant-Front
20 458 5002	Ape Tm P	50	85	89	566502	Ant-Front
20 458 5012	Ape Calessino (City)	200	13	16	1364514	Ant-Front
20 458 5012	Ape Car P2-P3	220	78	85	1364514	Ant-Front
20 458 5012	Ape Mp P501-P601	220	78	96	1364514	Ant-Front
20 458 5012	Ape Calessino - Vme	420	07	12	1364514	Ant-Front
20 458 5022	Ape Mp P501-P601	220	78	96	244949	Ant-Front
20 458 5032	Ape Tm P602	220	82	83	225533	Ant-Front
20 458 5042	Ape Tm P703-P703v, FL2	220	84	05	646465	Ant-Front
20 458 5042	Ape Tm	220	09	16	646465	Ant-Front
20 458 5042	Ape Tm P703-P703v Diesel	420	87	04	646465	Ant-Front
20 458 5042	Ape Tm P703 FL2	220	99	07	566506	Ant-Front
20 458 5042	Ape Car - Max Diesel	420	86	96	566506	Ant-Front
20 458 5042	Ape Tm Diesel Lcs	420	05	12	566506	Ant-Front

20 456 5002

LUNGHEZZA LENGHT (mm)	ATTACCO SUPERIORE UPPER FASTENING POINT			ATTACCO INFERIORE LOWER FASTENING POINT		
	Tipo-Type	D (mm)	W (mm)	Tipo-Type	D (mm)	W (mm)
403		M10x1,25	-		M10x1,25	-

20 456 5012

LUNGHEZZA LENGHT (mm)	ATTACCO SUPERIORE UPPER FASTENING POINT			ATTACCO INFERIORE LOWER FASTENING POINT		
	Tipo-Type	D (mm)	W (mm)	Tipo-Type	D (mm)	W (mm)
385		M10x1,25	-		10	40

20 458 5002

LUNGHEZZA LENGHT (mm)	ATTACCO SUPERIORE UPPER FASTENING POINT			ATTACCO INFERIORE LOWER FASTENING POINT		
	Tipo-Type	D (mm)	W (mm)	Tipo-Type	D (mm)	W (mm)
368,5		M10x1,25	-		15,1	34

20 458 5012

LUNGHEZZA LENGHT (mm)	ATTACCO SUPERIORE UPPER FASTENING POINT			ATTACCO INFERIORE LOWER FASTENING POINT		
	Tipo-Type	D (mm)	W (mm)	Tipo-Type	D (mm)	W (mm)
439		M10x1,25	-		18,1	48

20 458 5022

LUNGHEZZA LENGHT (mm)	ATTACCO SUPERIORE UPPER FASTENING POINT			ATTACCO INFERIORE LOWER FASTENING POINT		
	Tipo-Type	D (mm)	W (mm)	Tipo-Type	D (mm)	W (mm)
417		M10x1,25	-		18,1	48

20 458 5032

LUNGHEZZA LENGHT (mm)	ATTACCO SUPERIORE UPPER FASTENING POINT			ATTACCO INFERIORE LOWER FASTENING POINT		
	Tipo-Type	D (mm)	W (mm)	Tipo-Type	D (mm)	W (mm)
400		M10x1,25	-		19,1	48

20 458 5042

LUNGHEZZA LENGHT (mm)	ATTACCO SUPERIORE UPPER FASTENING POINT			ATTACCO INFERIORE LOWER FASTENING POINT		
	Tipo-Type	D (mm)	W (mm)	Tipo-Type	D (mm)	W (mm)
400		M10x1,25	-		19,1	48



12 187 0120 

PROLUNGA AMMORTIZZATORE POSTERIORE
REAR SHOCK ABSORBERS EXTENSION mm 42
PIAGGIO 125-150: Vespa Super



12 187 0130 

PROLUNGA AMMORTIZZATORE POSTERIORE
REAR SHOCK ABSORBERS EXTENSION mm 26
PIAGGIO 150: Vespa Sprint • GL • Sprint Veloce
• Super
180-200: Vespa Rally
(R.O. 070642)



12 187 0140 

PROLUNGA AMMORTIZZATORE POSTERIORE
REAR SHOCK ABSORBERS EXTENSION mm 52
PIAGGIO 125-150-200: Vespa Px
(R.O. 149871)



12 187 0150 

PROLUNGA AMMORTIZZATORE POSTERIORE
REAR SHOCK ABSORBERS EXTENSION mm 48
PIAGGIO 125-150-200: Vespa Px
Arcobeleno T5
(R.O. 9344)



12 187 0090 

GILERA: Typhoon
PIAGGIO: Nrg
Colore alluminio naturale
Alloy Colour



12 187 0101 

MBK: Nitro - **YAMAHA:** Aerox
Nero - *Black*

12 187 0100 

MBK: Nitro - **YAMAHA:** Aerox
Cromato - *Chromed*

12 187 0102 

MBK: Nitro - **YAMAHA:** Aerox
Bianco - *White*



12 187 0108 

MBK: Nitro - **YAMAHA:** Aerox
Colore carbon - *Carbon colour*



12 187 0110 

PEUGEOT: Speedfight
Colore cromato - *Chromed colour*

12 187 0111 

Nero - *Black*

12 187 0118 

Carbon - *Carbon colour*



12 187 0070 

YAMAHA MINARELLI 50
Colore alluminio naturale - *Alloy Colour*



12 187 0071 

YAMAHA MINARELLI 50
Colore nero - *Colour black*





ACCESSORI PER AMMORTIZZATORI

SHOCK ABSORBER ACCESSORIES

12 183 0820



TAMPONE SUPERIORE AMMORTIZZATORE
SHOCK ABSORBER BUFFER
PIAGGIO 125-150-200: Vespa Px
(R.O. 174085)



12 183 0800



TAMPONE SUPERIORE AMMORTIZZATORE
SHOCK ABSORBER BUFFER
PIAGGIO 50: Vespa 1° Serie
Ø Int.13mm



12 183 0810



TAMPONE SUPERIORE AMMORTIZZATORE
SHOCK ABSORBER BUFFER
PIAGGIO 125-150: Vespa
(R.O. 015019)



12 183 0790



TAMPONE AMMORTIZZATORE
SHOCK ABSORBER BUFFER
PIAGGIO 50: Vespa 1° Serie
VSA1T
Ø12 (Foro - Hole)



12 183 0600



TAMPONE AMMORTIZZATORE
SHOCK ABSORBER PLUG
PIAGGIO 50-90-125: Vespa Primavera • Et3
(R.O. 57012)



12 183 0350



GOMMINO AMM. POSTERIORE
BUFFER REAR SHOCK ABSORBER
PIAGGIO 50-90: Vespa Primavera Et3
V5A1-V5B1-V5B2-V5SA1-V9A1-VMA2-VMB1
125: Vespa VNA-VNB
(R.O. 040316)



12 187 0513



PIASTRA AMMORTIZZATORE
SHOCK ABSORBER PLATE
PIAGGIO 125-150-200: Vespa PX T5
VNX-VLX-VSX-VNX5T
(R.O. 174806)



12 183 0780



SILENTBLOCK ATTACCO INFERIORE
AMMORTIZZATORE
LOWER SHOCK ABSORBER MOUNTING SI-
LENTBLOCK
KYMCO 125: Downtown 09 • K-Xct I K-Xct I 12-14
People Gti 10
200: Downtown I 10 • People Gti 10-14
250: X Citing I 06-07 • X Citing 05
300: Downtown I 09-11 • Downtown Abs I 11 •
Downtown Abs 10 • K-Xct I Abs 12-14 • People
Gti Abs 12-14 • People Gti 10-14 • X Citing 300 I
R 08-09
350: Downtown I Abs 15
400: X Citing I Abs 14 • X Citing I Abs 13-15
500: X Citing R 05-09 • X Citing I R07-08 • X Citing
I 06-08
700: Myroad I 11
(R.O. 00121034)



12 183 0750



SILENTBLOCK ATTACCO INFERIORE
AMMORTIZZATORE
LOWER SHOCK ABSORBER MOUNTING SI-
LENTBLOCK
KYMCO 50: Agility R12 05 • B&w Eu2 03 • B&w 02
Cx Super 94-97 • Cx 93 • Dink 50 4T 07 • Dink Classic
Eu2 03 • Dink Lc 98-02 • Dj W 94-00 • Dj X 91-92 • Dj
Y 93 • Fever Zx Eu2 03-04 • Fever Zx 99-00 • Filly Lx
01-02 • Filly 98-00 • Heroism 95-97 • K 12 95-00 • Kb
95-00 • Like 2T 09 • Mixer Eu2 04
Mxfr 02-03 • People Eu2 03 • People Eu2 08
People Eu2 11 • People S 4T 06-08 • People S 05-08 •
People 99-00 • People 04 • Sento 08 • Sniper Dd 94-
96 • Sniper 93 • Super 9 Sport Eu2 03 • Super 9 Sport
Eu2 04 • Super 9 00 • Top Boy 97-00 • Vitality 2T 04 •
Vitality 4T 04 • Yup Eu2 03 • Yup 02
125: Agility 4T 06 • Agility Plus 14 • Agility R16 09 •
B&w 125-150 Eu2 03-04 • B&w 125-150 00 • Dink
125 Eu3 06-07 • Dink 125-150 97-98 • Dink Classic
125-150 Eu2 03 • Dink Classic 125-150 02 • Dink Lx
125-150 98-00 • G-Dink 12 • Grand Dink 125-150
Eu2 03-04 • Grand Dink 125-150 01-02 • Heroism
95-97 • Movie 125 Eu3 06-07 • Movie XL 125-150 Eu2
03-04 • Movie XL 125-150 01 • Movie 99-00 • People
125-150 Eu2 03 • People 125-150 99-00 • People Eu3
07 • People Eu3 08 • People Eu3 11 • People S Dd Eu3
07-08 • People S 05 • Vivio 125-150 00
150: Heroism 95-97 • Movie 150 Eu3 06-07 •
200: Dink Classic 04 • Dink Eu3 I 06-07 • People S 07
(R.O. 00109006)



▶ PASTIGLIE FRENO

BRAKE PADS

▶ **RMS**
YOUR BEST PARTNER

▶ **SINTER**
HIGH PERFORMANCE BRAKES

Scopri la vasta gamma di pastiglie organiche
RMS Made in Italy e Testate TUV.
Garantiscono performance durature e bassa usura del disco.

Coprono completamente il mercato degli scooter e rappresentano la soluzione ideale sia per applicazioni off-road che stradali.

Here it is the wide range of **RMS** organic brake pads Made in Italy and TUV Tested.
RMS brake pads ensure lasting performances and low consumption of the disc.
Scooter market is completely covered and they are the ideal best solution also for off-road driving.



RMS presenta nel suo catalogo la linea di pastiglie freno **SINTER**

La gamma **SINTER** include pastiglie freno sinterizzate a base metallo con elevato coefficiente d'attrito. Le pastiglie **SINTER** garantiscono inoltre una lunga durata.

Con un ottimo rapporto qualità prezzo sono l'ideale per una guida sicura.

*RMS is proud to show in the new catalogue the new line of **SINTER** brake pads.
Sintered brake pads have a metal-based compound. Their main characteristics are: Higher performances, better friction coefficient and durability.
The best possible quality with an affordable price.
It's the best choice for safe driving.*



**COME INTERPRETARE
CODICI
PASTIGLIE FRENO**



Codice finale
Final number **0** =



**HOW TO READ BRAKE
PADS RMS CODES**



Codice finale
Final number **3** =



I codici con il numero 0 finale: **MESCOLA ORGANICA**
I codici con il numero 3 finale: **MESCOLA SINTERIZZATA**
Non omologata

PASTIGLIE FRENO IN ORDINE DI CODICE

BRAKE PADS SEARCH BY CODE NUMBER



22 510 0010



22 510 0013



22 510 0020



22 510 0030

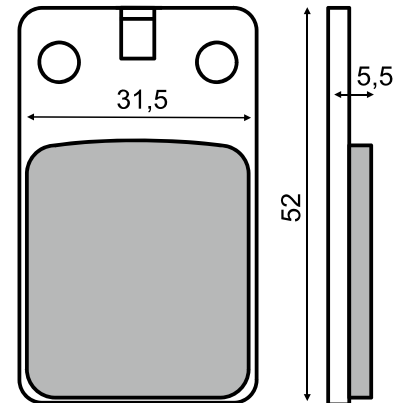
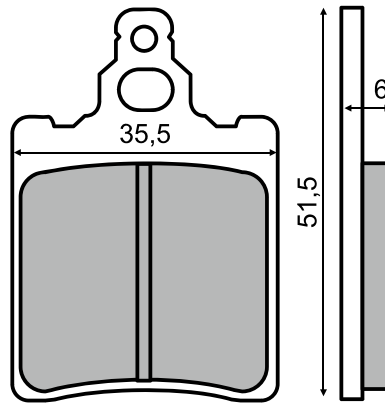
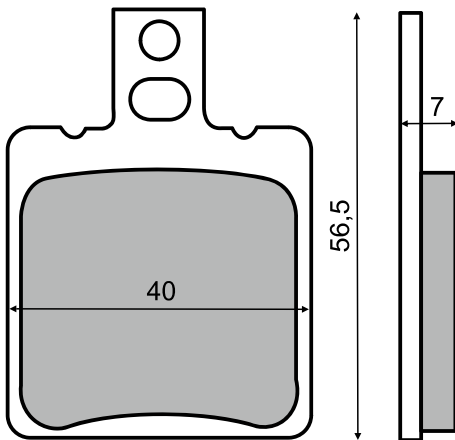

22 510 0040

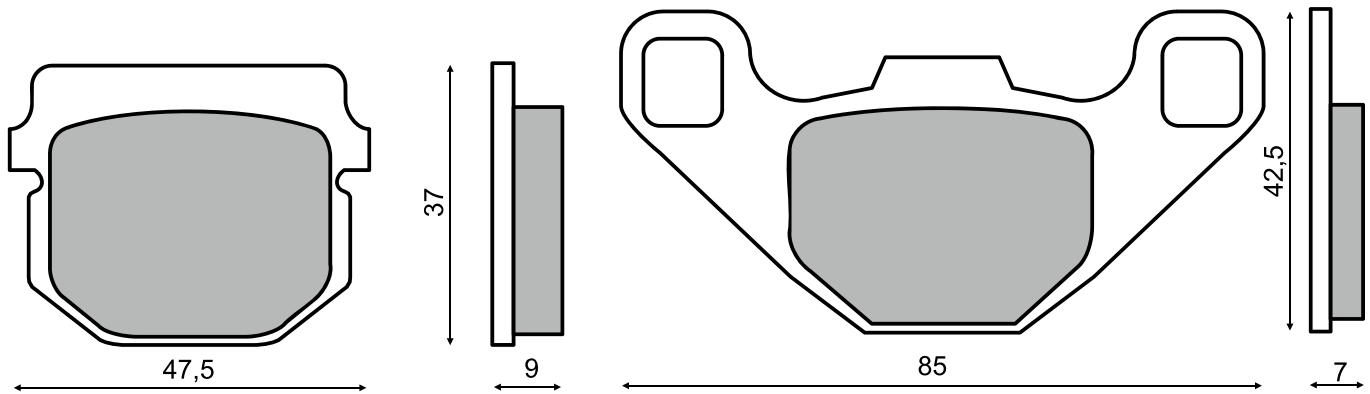

22 510 0060



22 510 0063

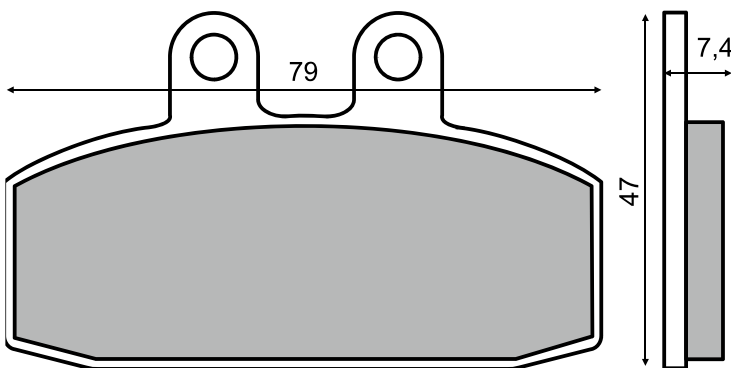

22 510 0070

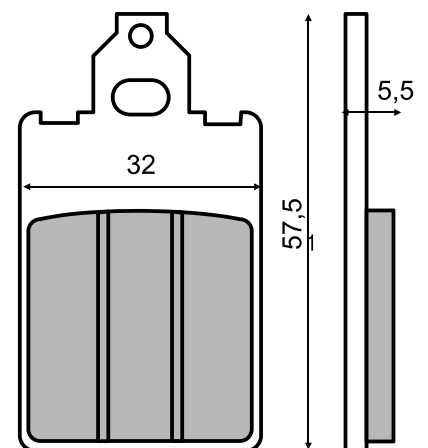



PASTIGLIE FRENO IN ORDINE DI CODICE

BRAKE PADS SEARCH BY CODE NUMBER

22 510 0080



22 510 0083

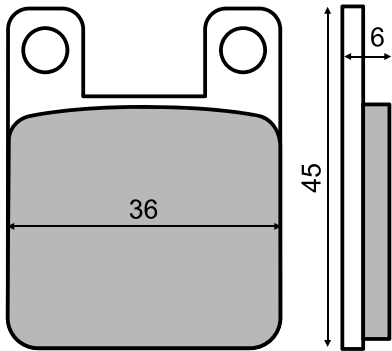

22 510 0140

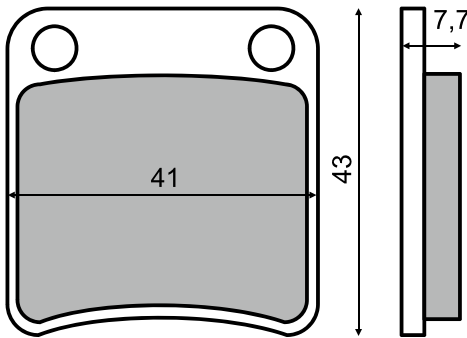

22 510 0160

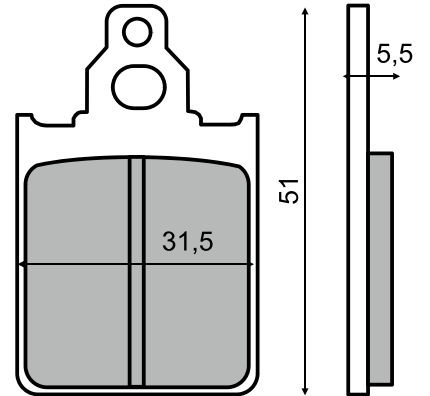

22 510 0170

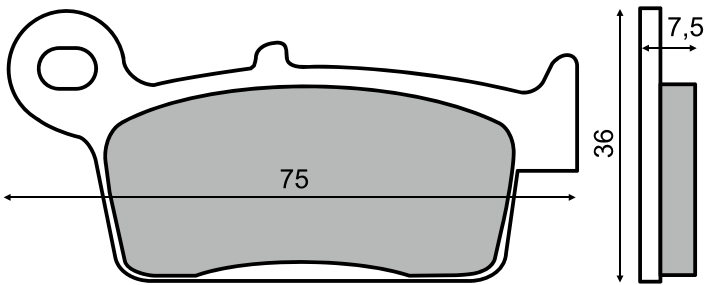

22 510 0180

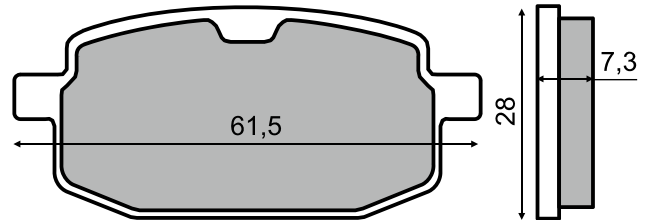

22 510 0190



22 510 0193

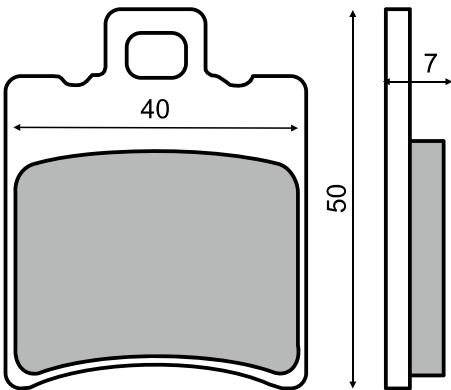

22 510 0240

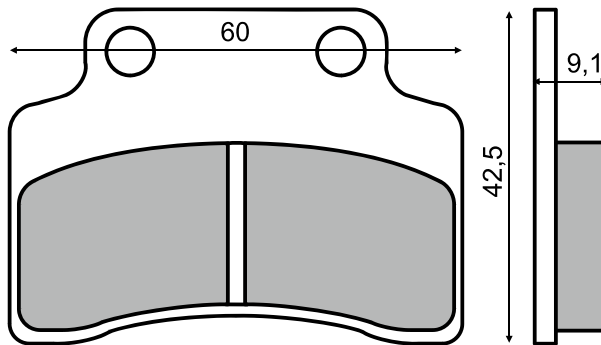

22 510 0250

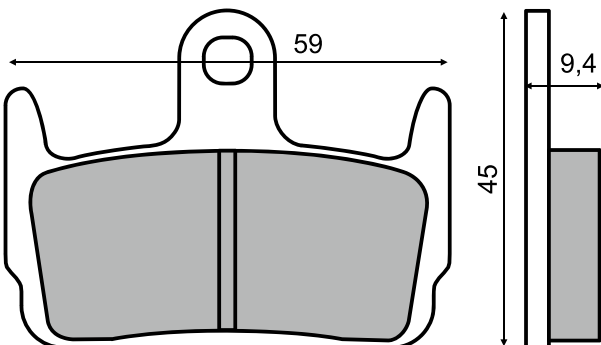

22 510 0270



22 510 0273

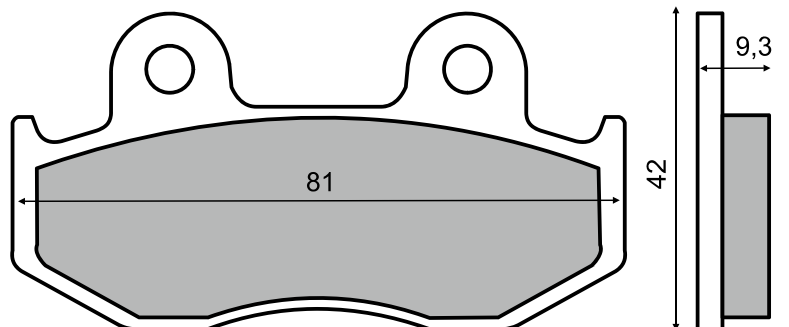



22 510 0280

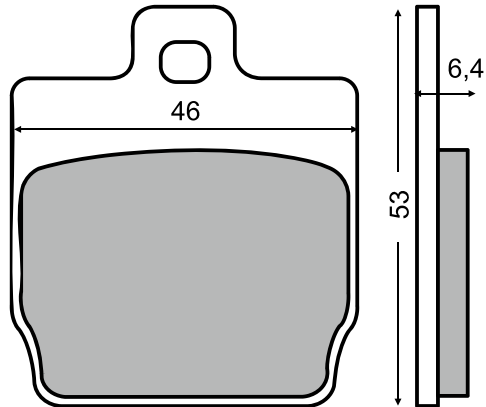

22 510 0300

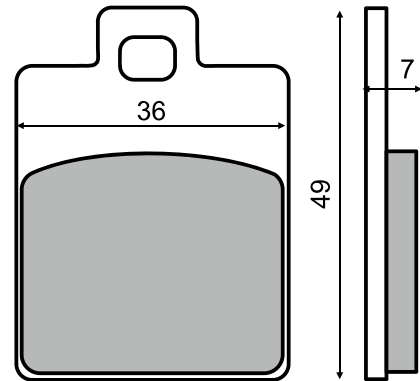

22 510 0303

22 510 0310

22 510 0313

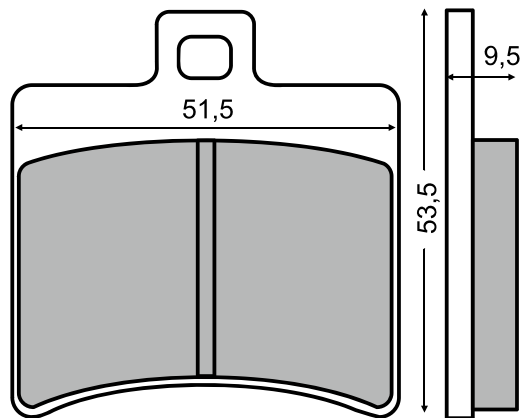

22 510 0330

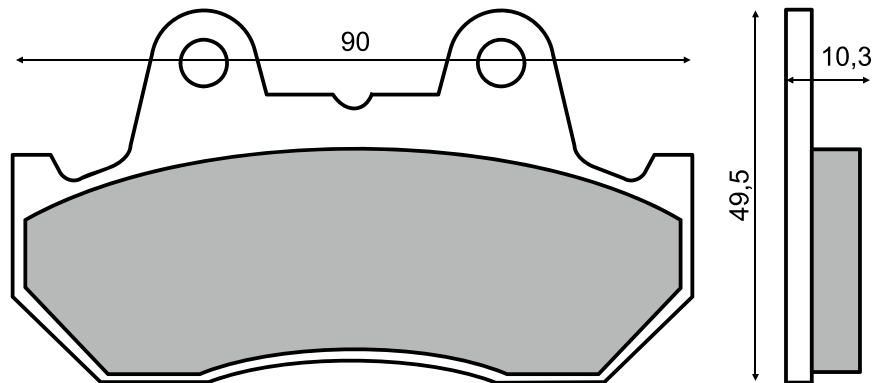

22 510 0340

22 510 0343

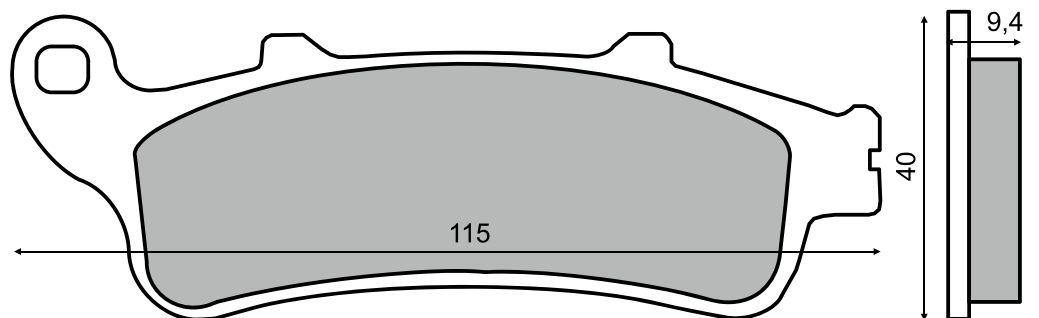



PASTIGLIE FRENO IN ORDINE DI CODICE
BRAKE PADS SEARCH BY CODE NUMBER

22 510 0350

22 510 0353

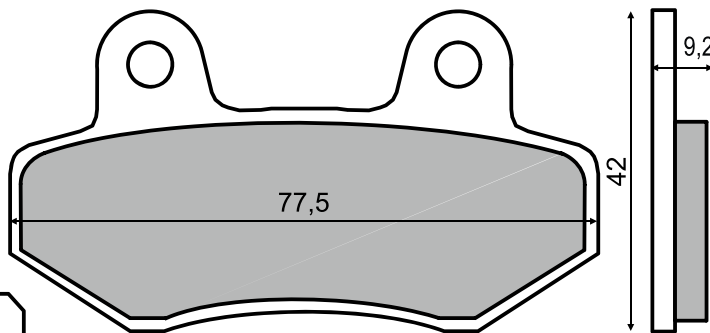
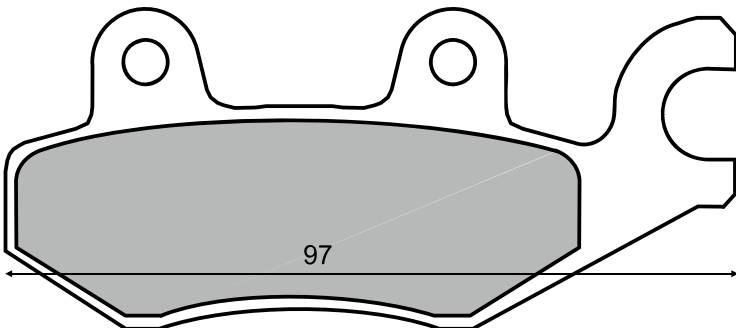

22 510 0360

22 510 0363

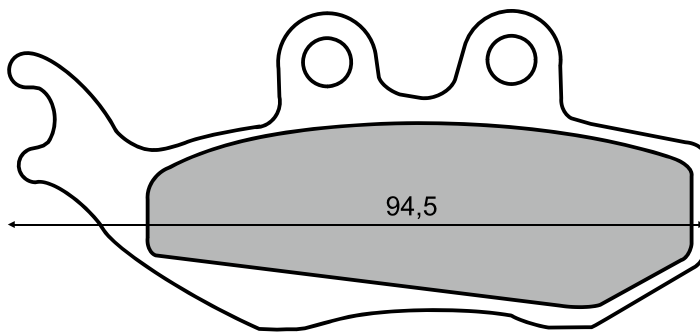
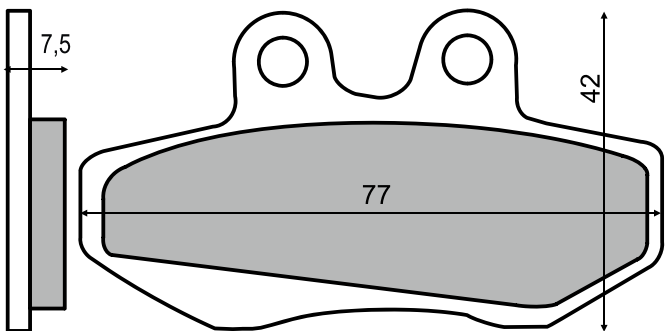

22 510 0380

22 510 0383

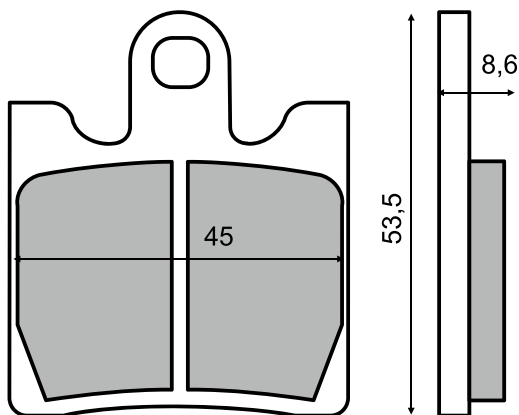

22 510 0400

22 510 0403

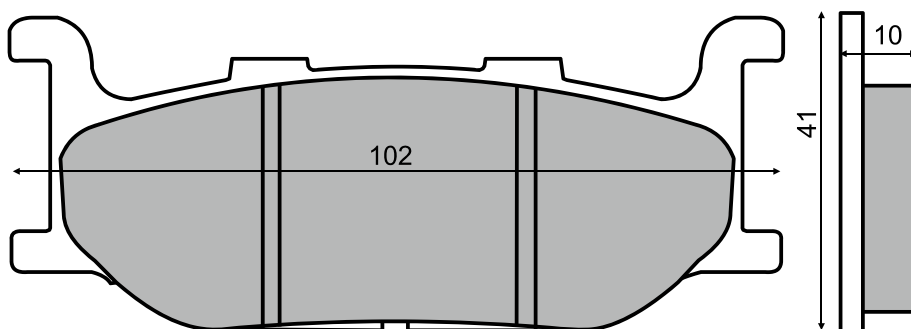

I codici con il numero 0 finale: **MESCOLA ORGANICA**
I codici con il numero 3 finale: **MESCOLA SINTERIZZATA**
❗ Non omologata

PASTIGLIE FRENO IN ORDINE DI CODICE

BRAKE PADS SEARCH BY CODE NUMBER



22 510 0410

22 510 0413

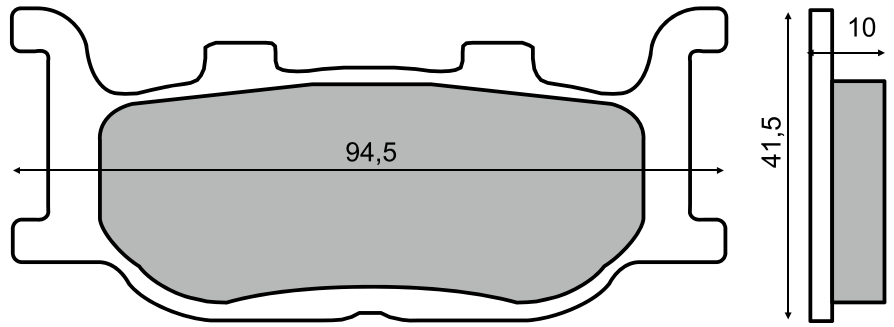

22 510 0430

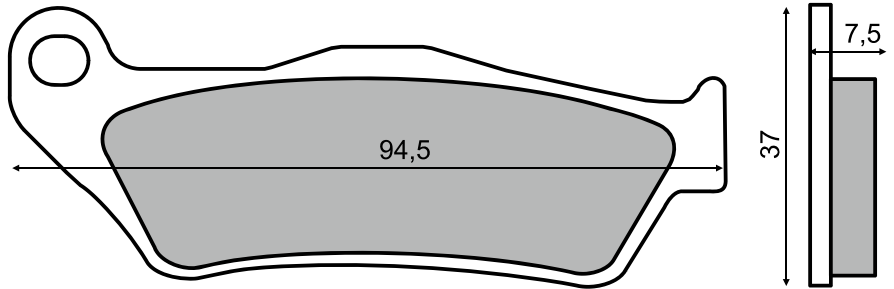

22 510 0450

22 510 0453

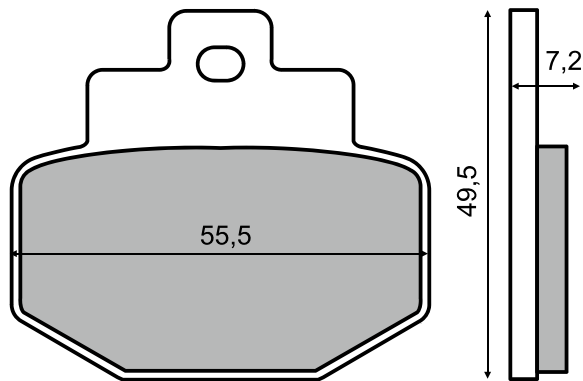

22 510 0460

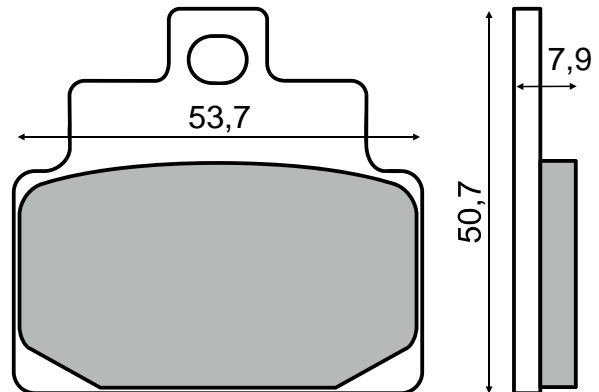

22 510 0490

22 510 0493

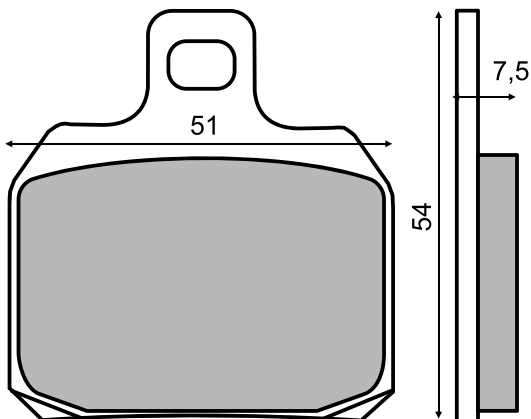

22 510 0500

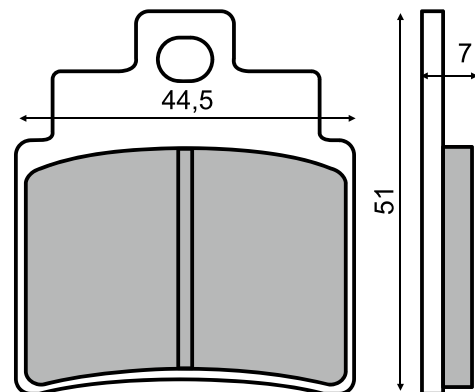



PASTIGLIE FRENO IN ORDINE DI CODICE

BRAKE PADS SEARCH BY CODE NUMBER

22 510 0510

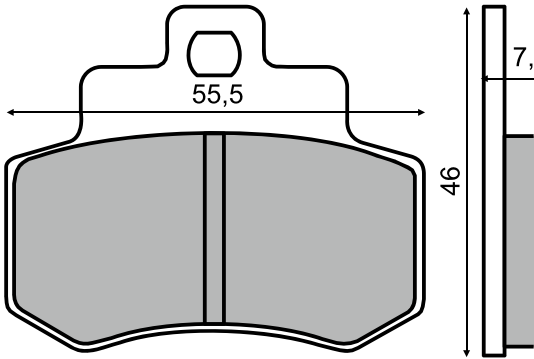

22 510 0520



22 510 0523

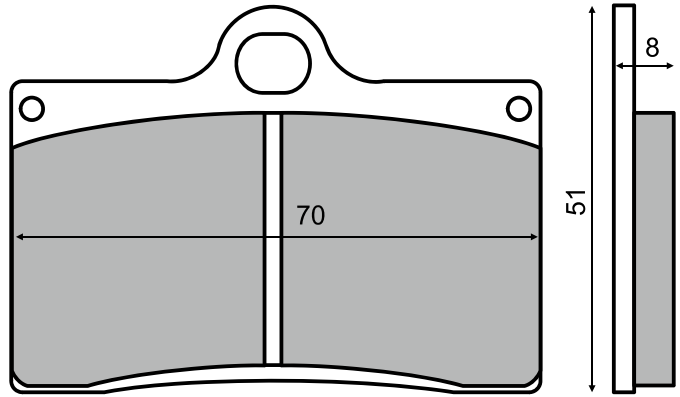

22 510 0530



22 510 0533

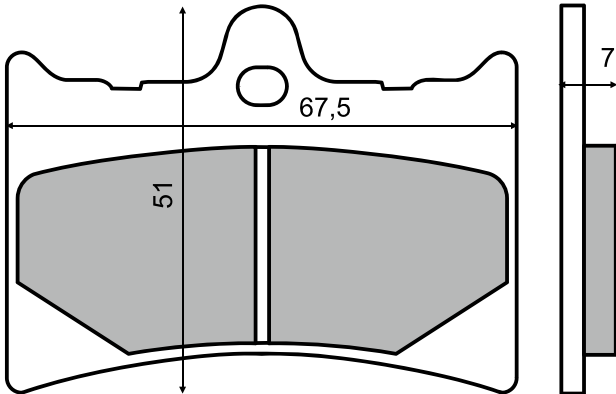

22 510 0540

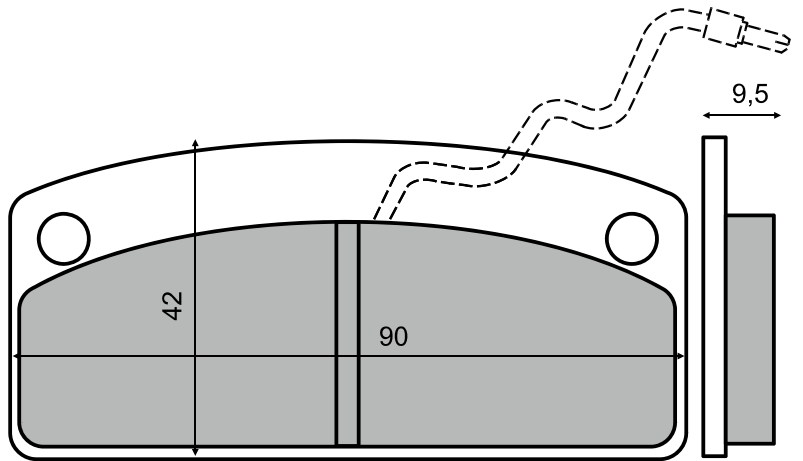

22 510 0560

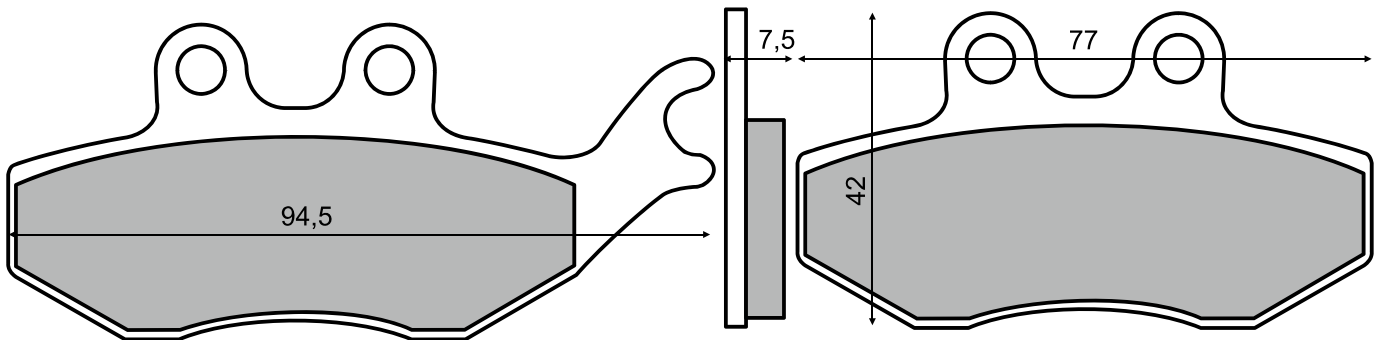

22 510 0573

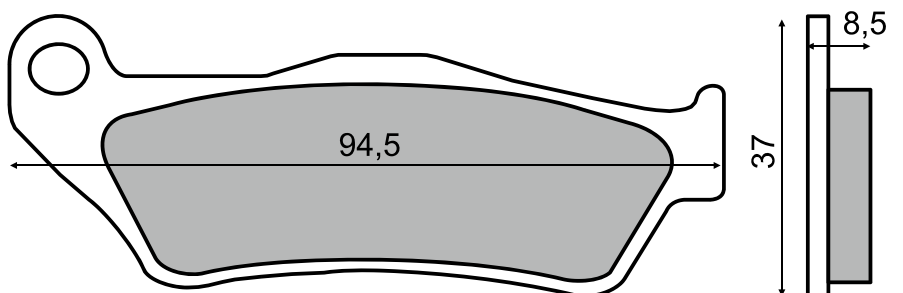

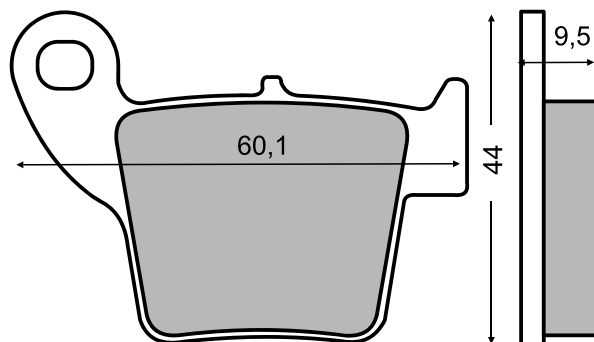
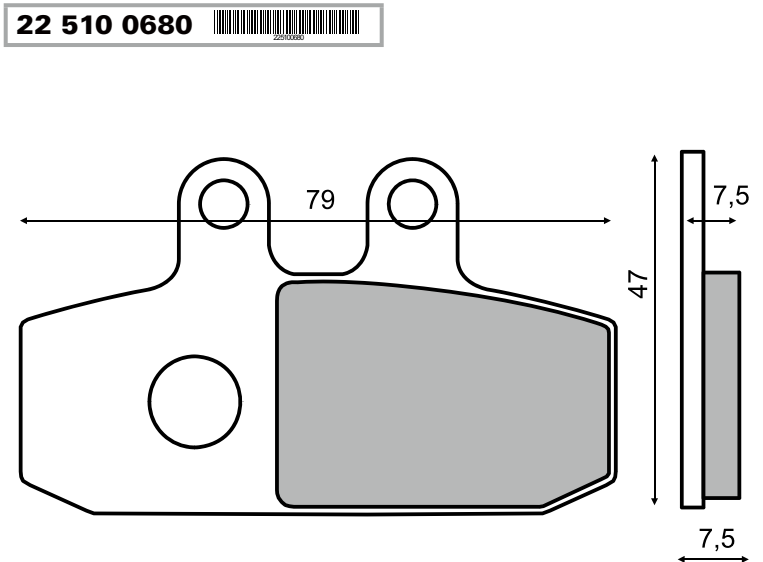
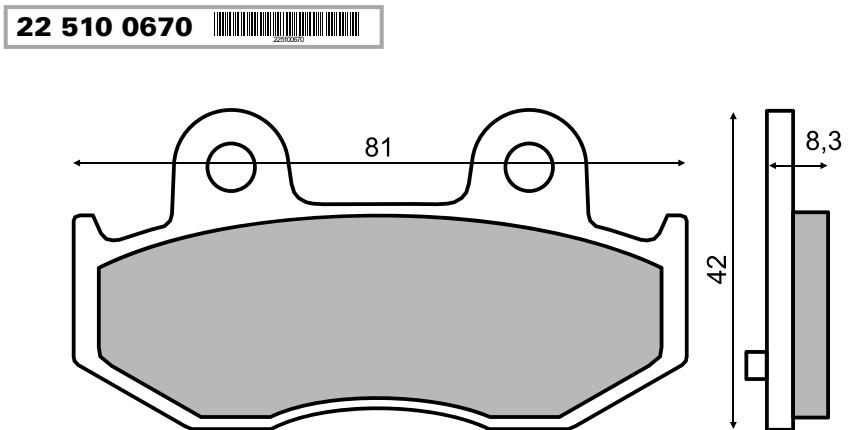
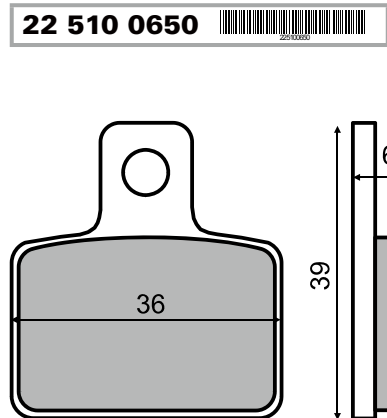
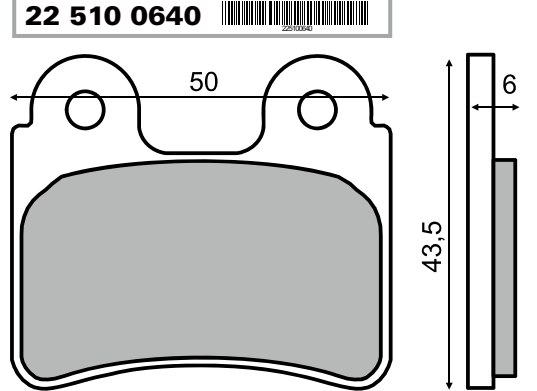
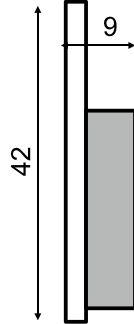
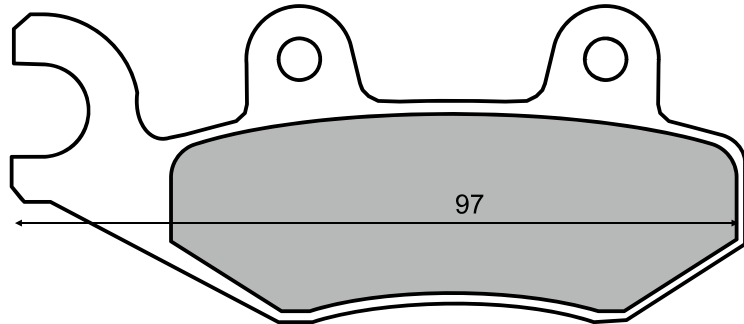
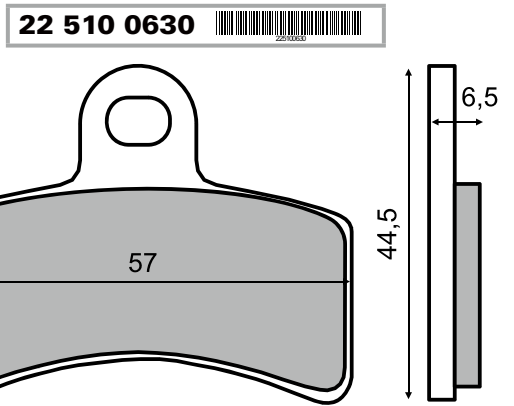
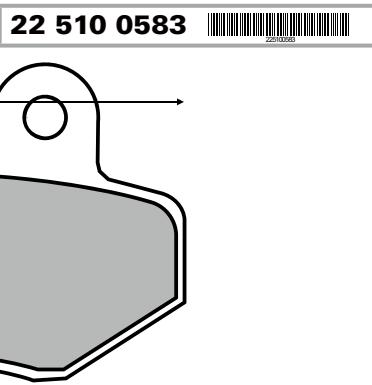
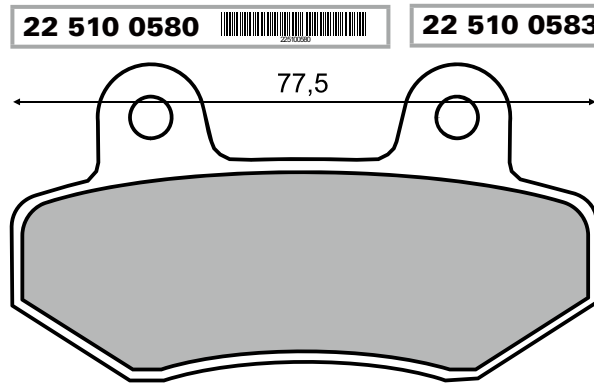



PASTIGLIE FRENO IN ORDINE DI CODICE

BRAKE PADS SEARCH BY CODE NUMBER

22 510 0690

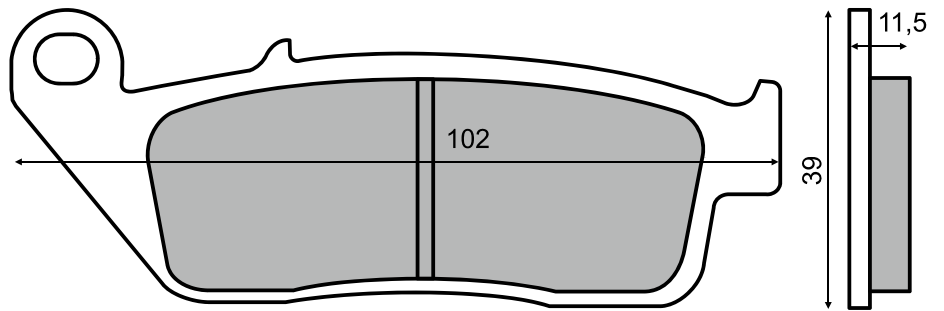

22 510 0720



22 510 0723

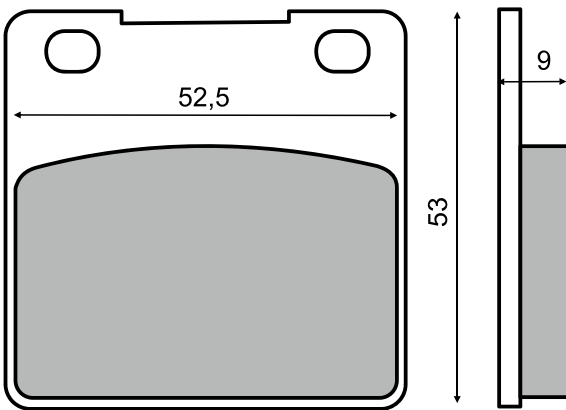

22 510 0730



22 510 0733

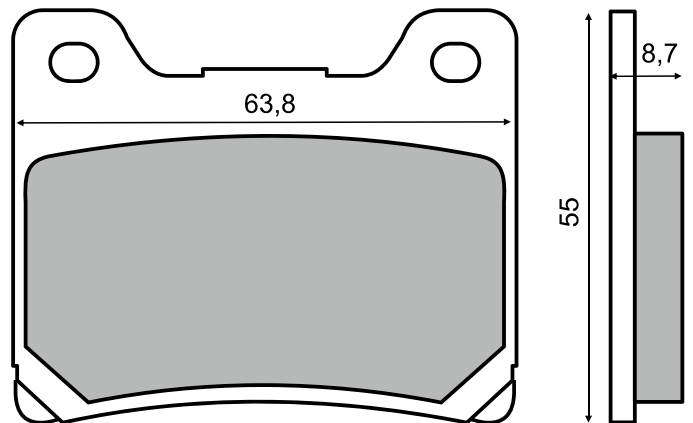

22 510 0740

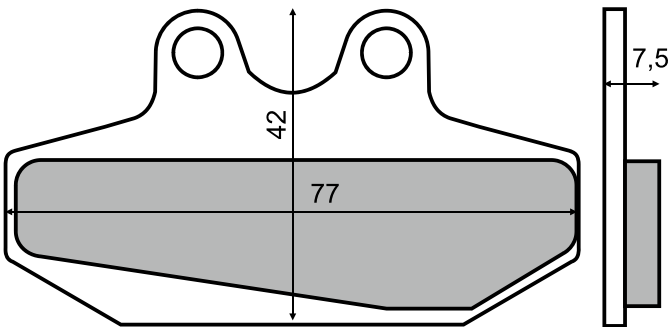

22 510 0750



22 510 0753

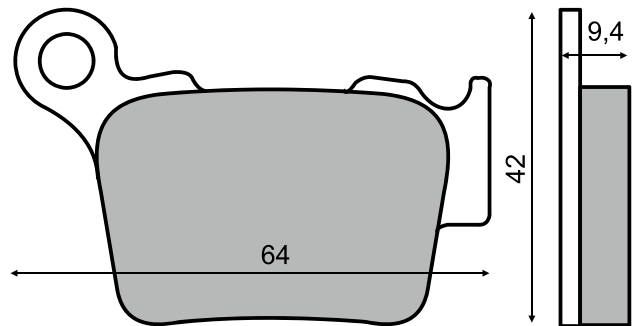

22 510 0760

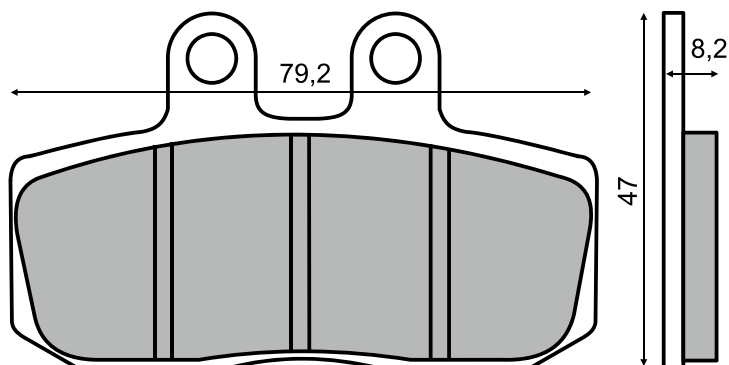



22 510 0770

22 510 0773

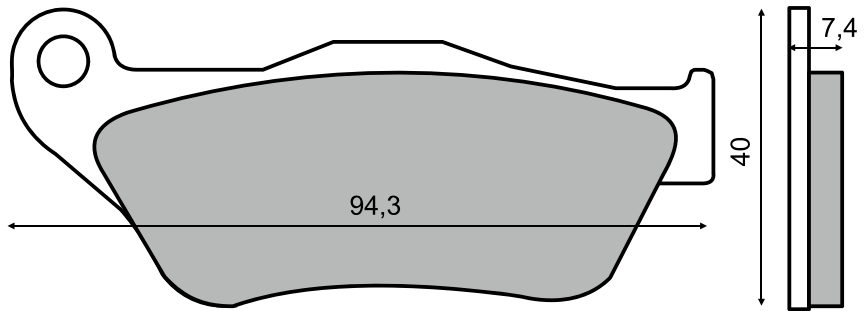

22 510 0780

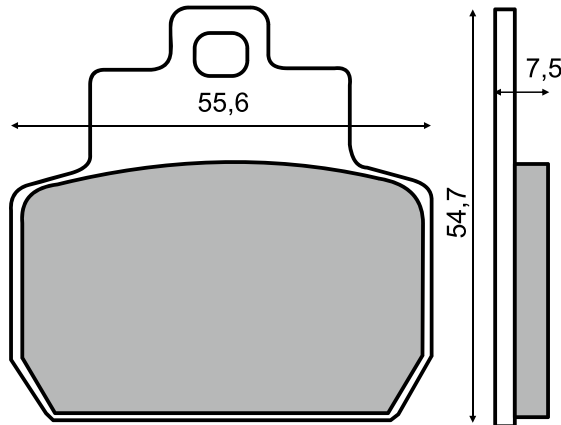

22 510 0800

22 510 0803

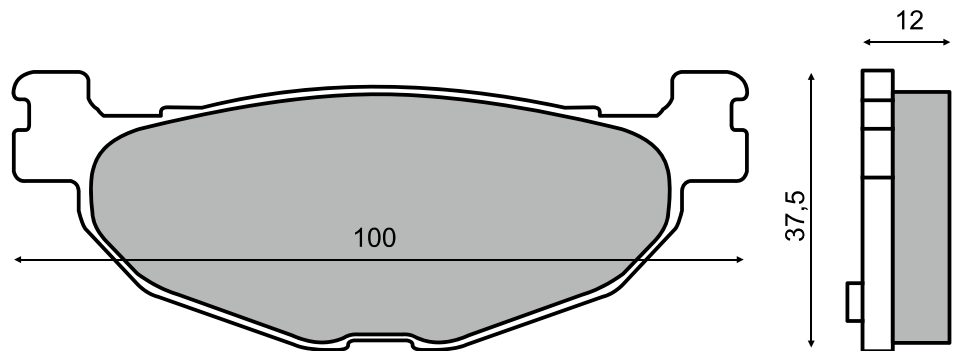

22 510 0870

22 510 0873

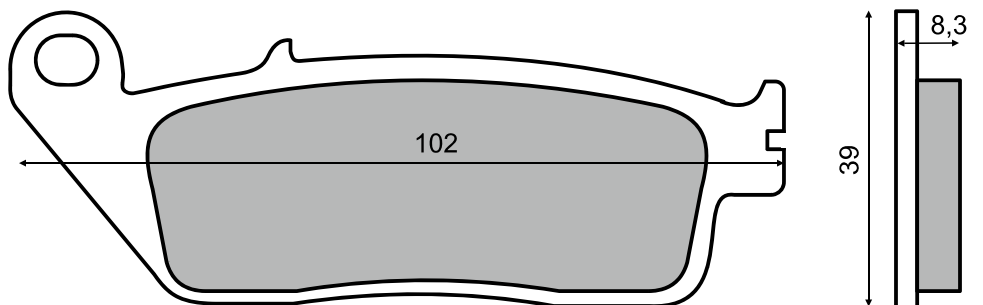

22 510 0890

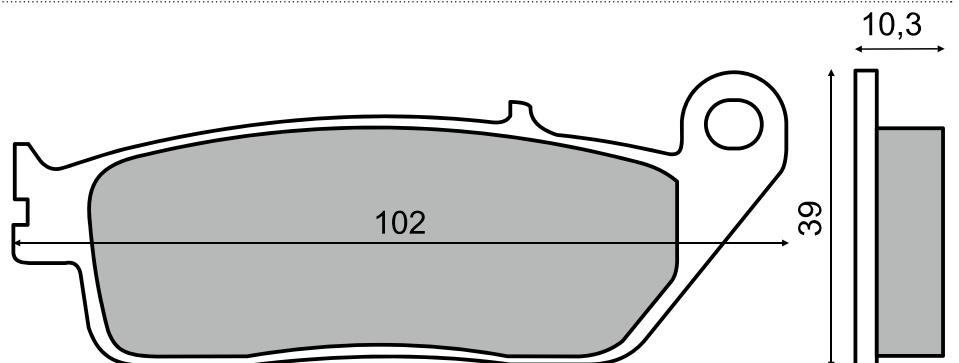



PASTIGLIE FRENO IN ORDINE DI CODICE

BRAKE PADS SEARCH BY CODE NUMBER

22 510 0920



22 510 0923

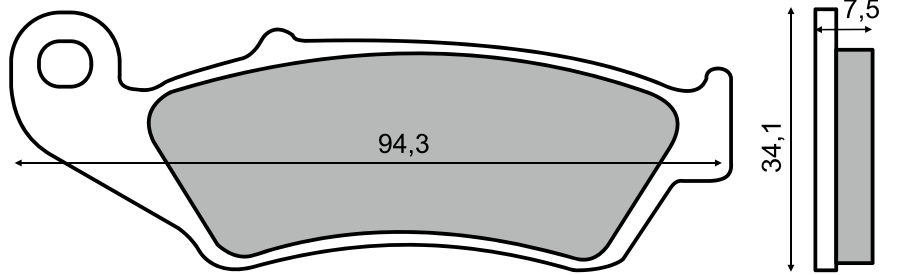

22 510 0930



22 510 0933

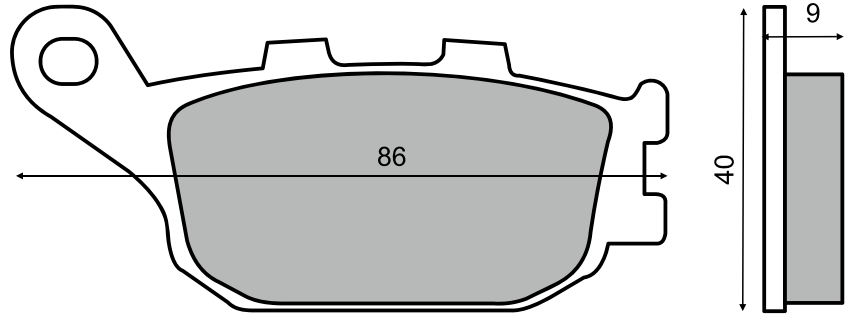

22 510 0970



22 510 0973

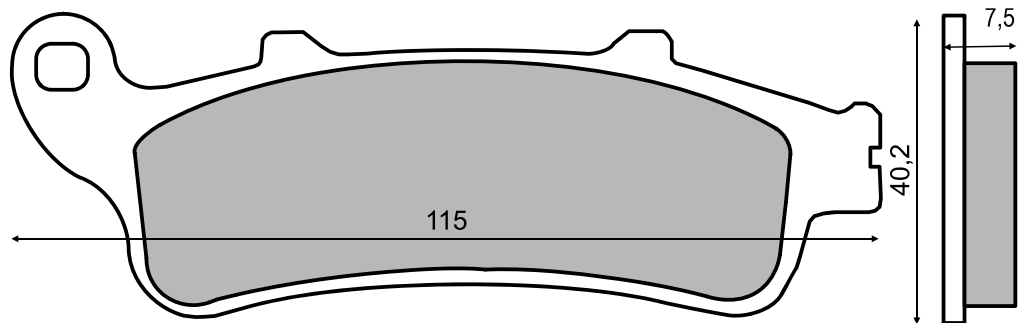

22 510 1010



22 510 1013

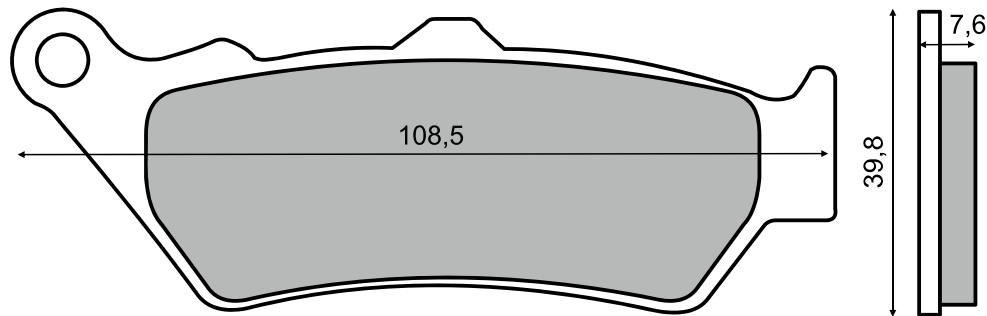

22 510 1060



22 510 1063

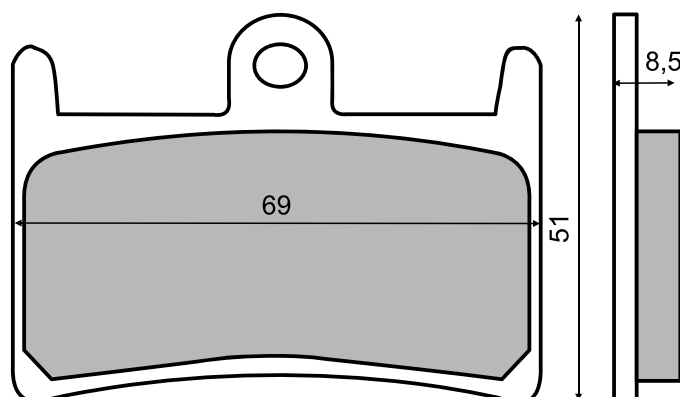



22 510 1070

22 510 1073

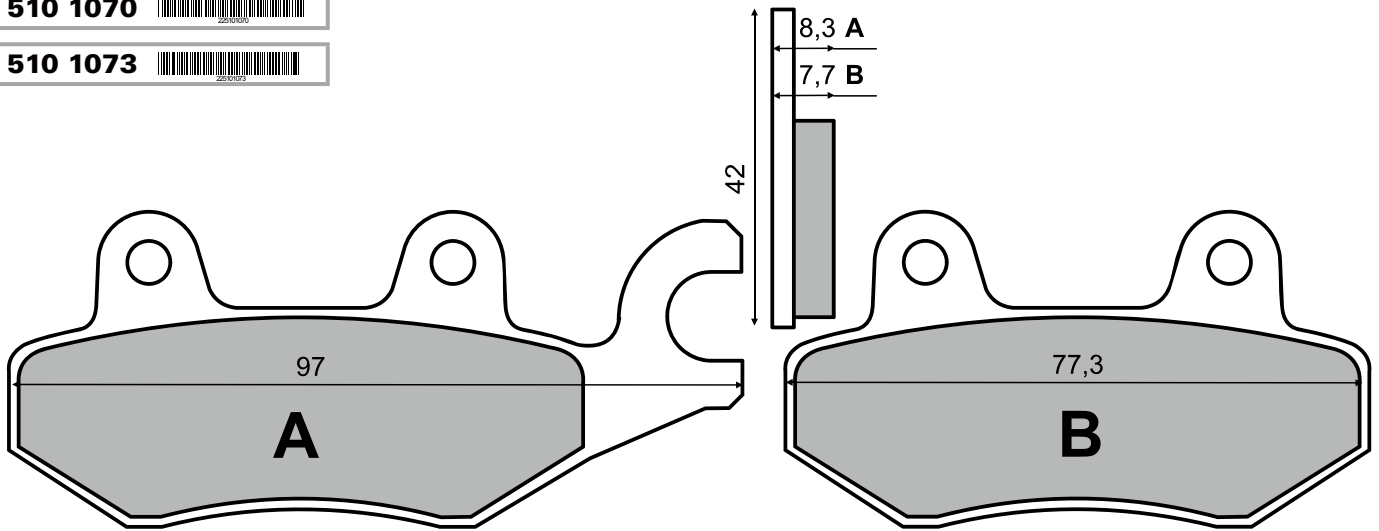

22 510 1100

22 510 1103

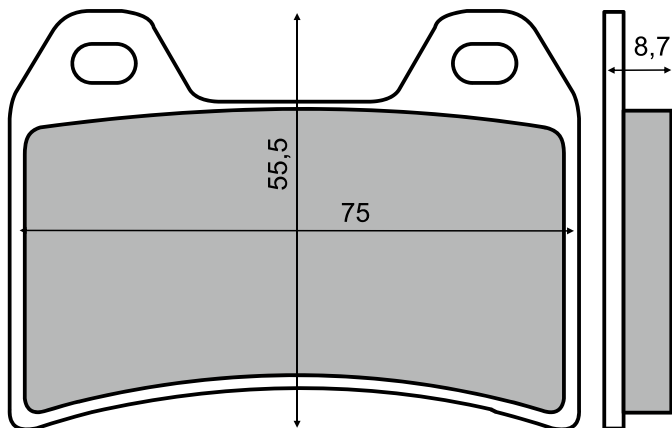

22 510 1150

22 510 1153

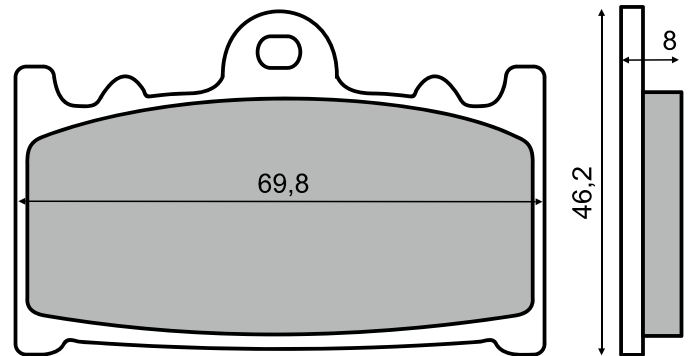

22 510 1170

22 510 1173

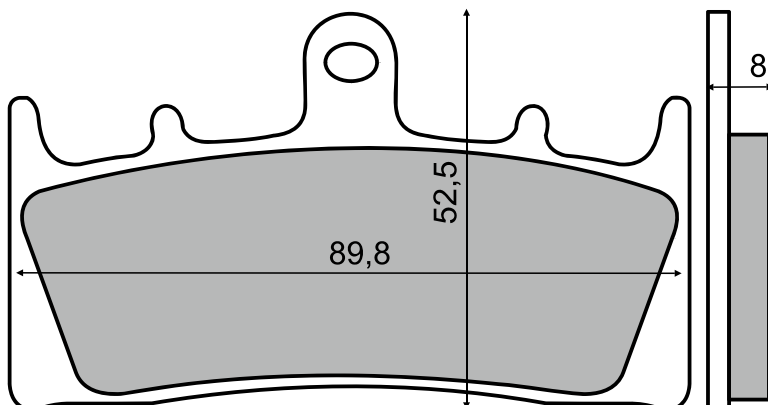

22 510 1190

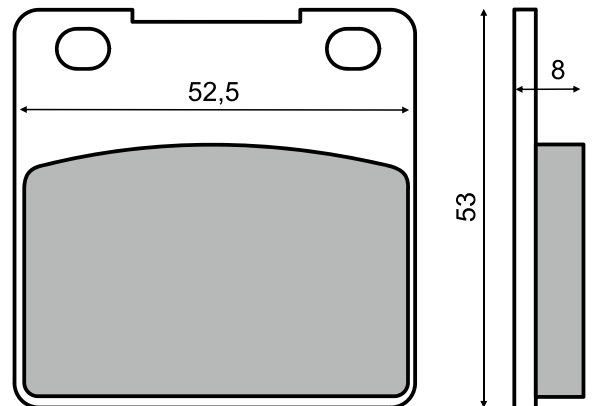



PASTIGLIE FRENO IN ORDINE DI CODICE

BRAKE PADS SEARCH BY CODE NUMBER

22 510 1200

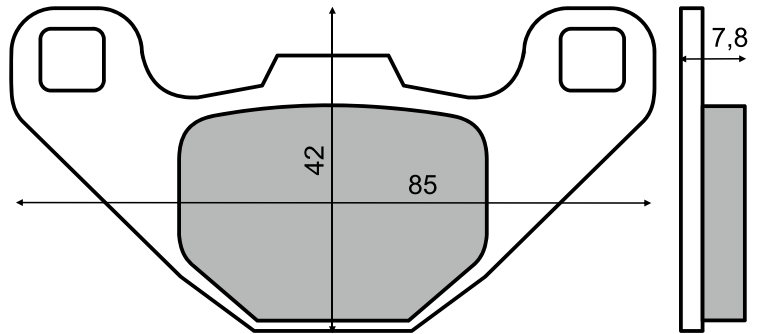
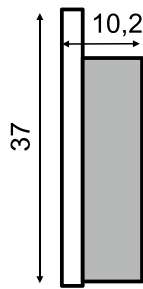
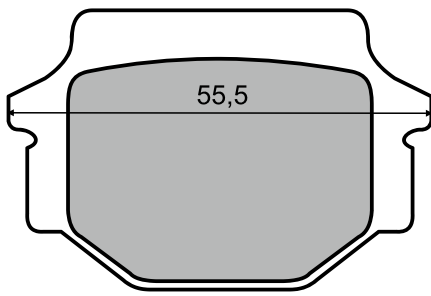

22 510 1220



22 510 1223

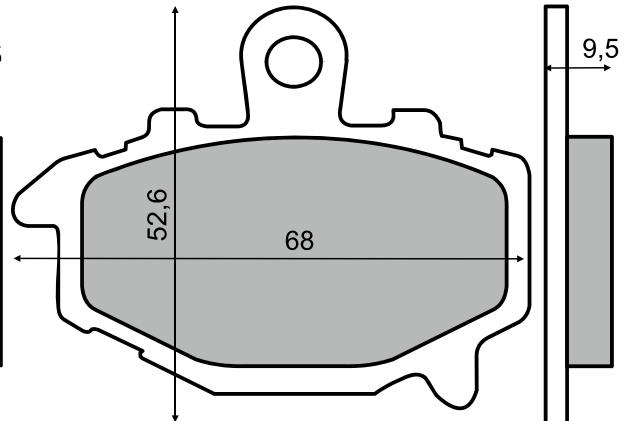
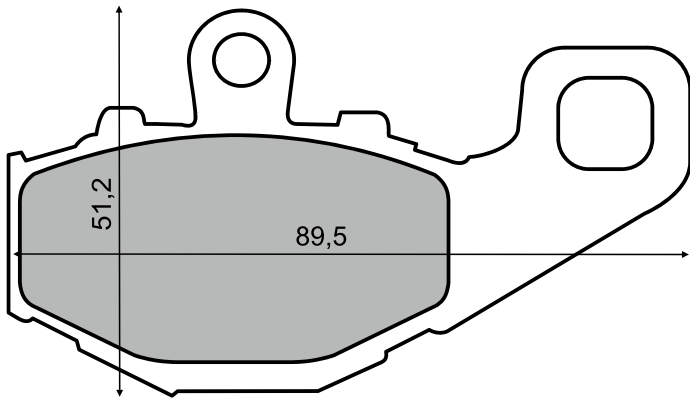

22 510 1240



22 510 1243

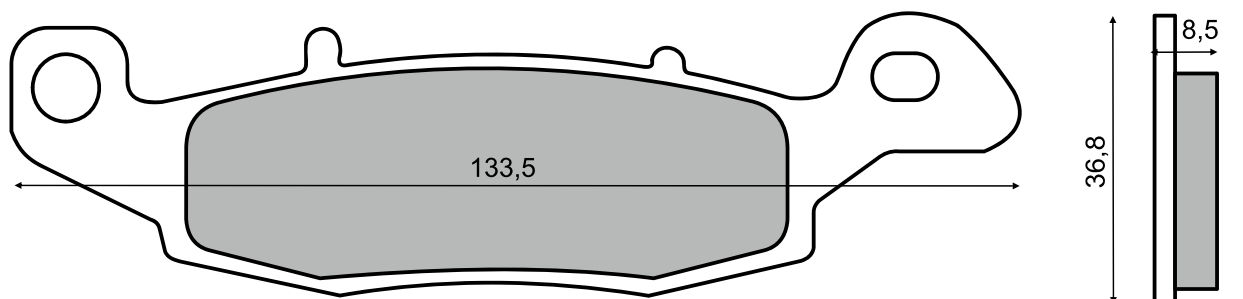
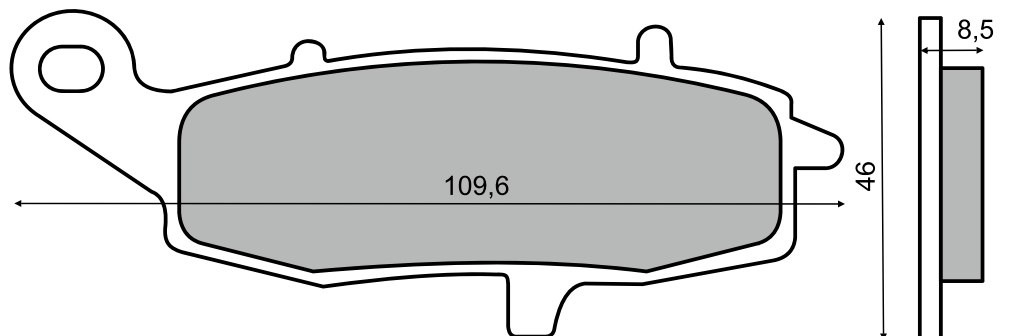

I codici con il numero 0 finale: **MESCOLA ORGANICA**
I codici con il numero 3 finale: **MESCOLA SINTERIZZATA**
Non omologata

PASTIGLIE FRENO IN ORDINE DI CODICE

BRAKE PADS SEARCH BY CODE NUMBER



22 510 1250

22 510 1253

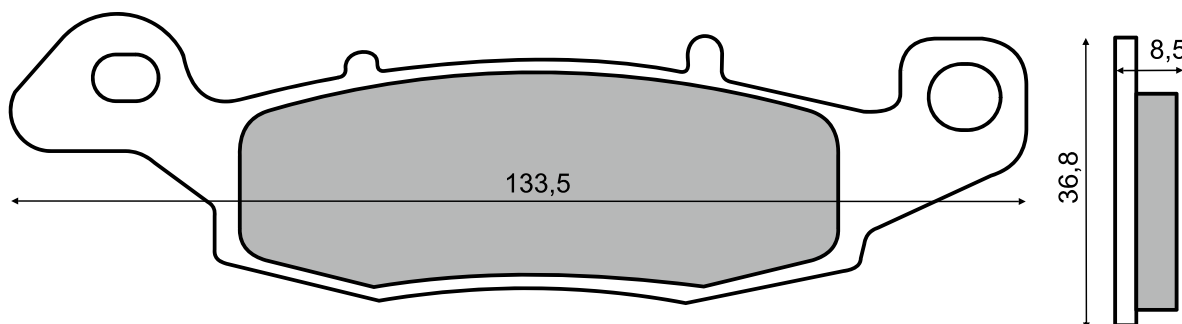
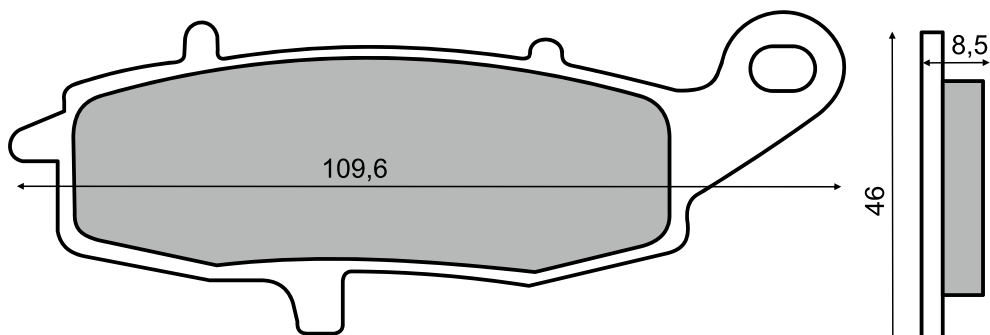

22 510 1330

22 510 1333

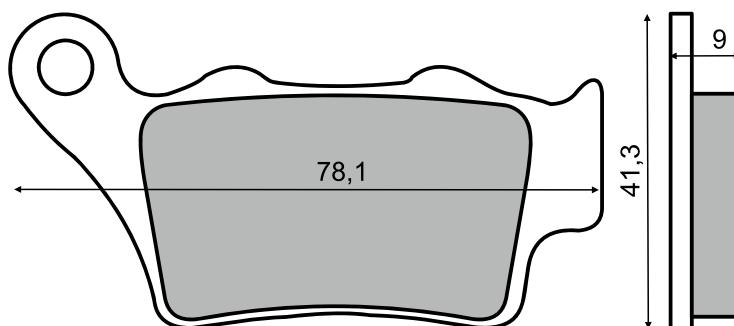

22 510 1380

22 510 1383

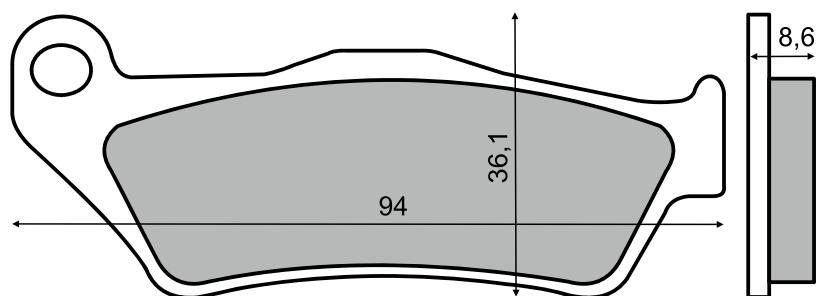
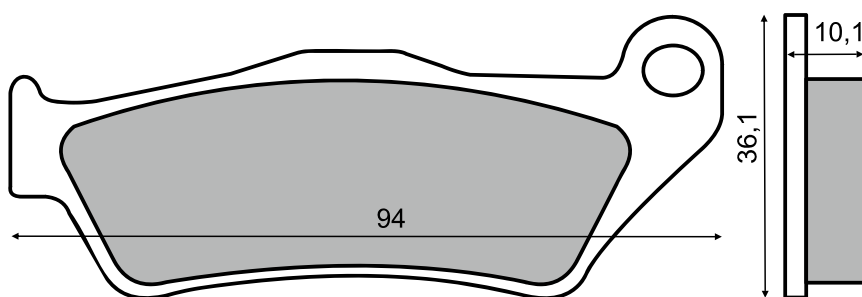



PASTIGLIE FRENO IN ORDINE DI CODICE

BRAKE PADS SEARCH BY CODE NUMBER

22 510 1400

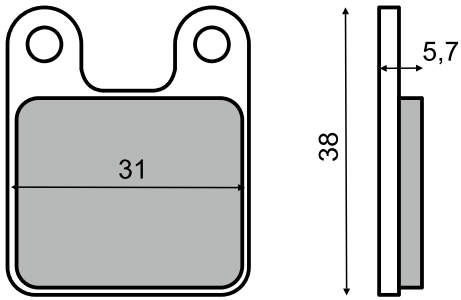

22 510 1410



22 510 1413

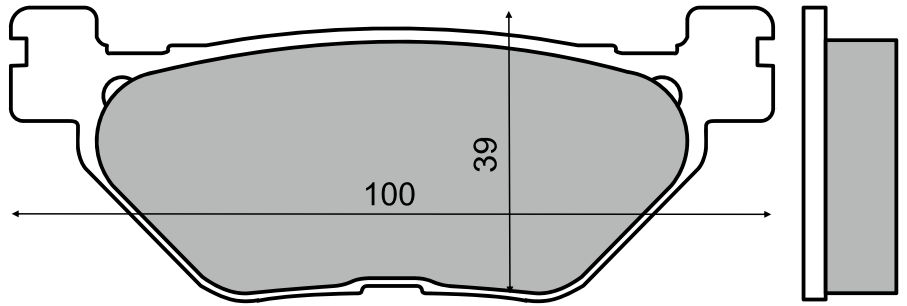

22 510 1420



22 510 1423

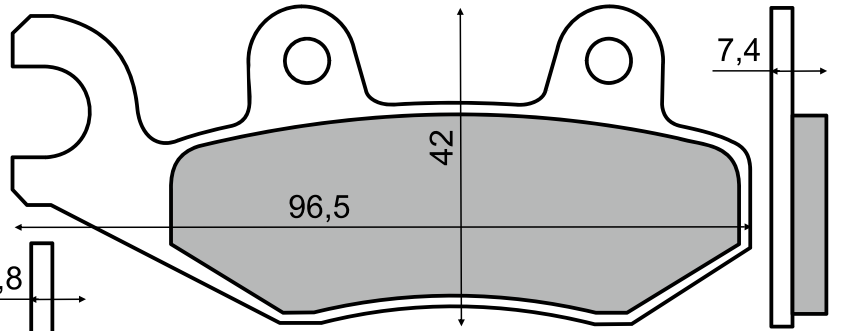
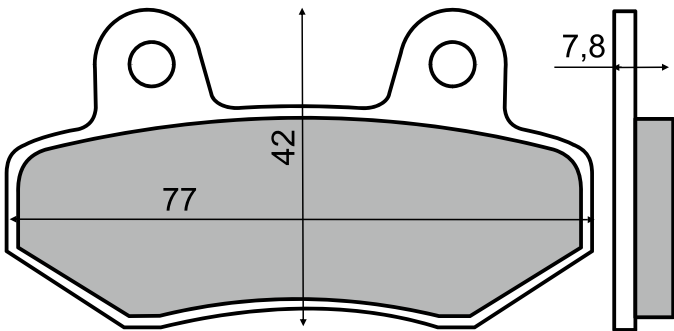

22 510 1430



22 510 2730

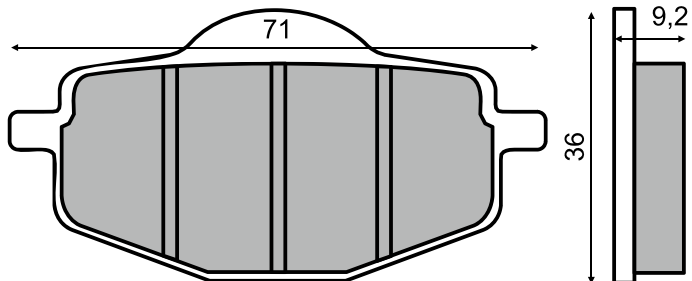

22 510 1440

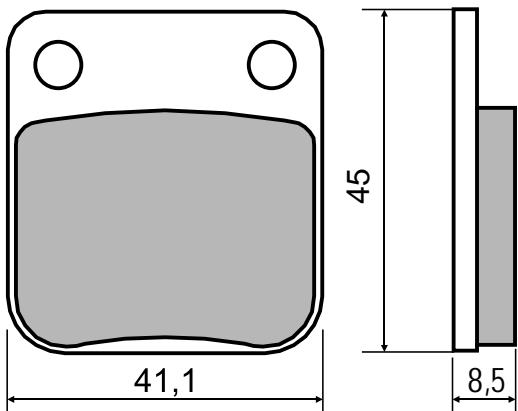

22 510 1450



22 510 1453

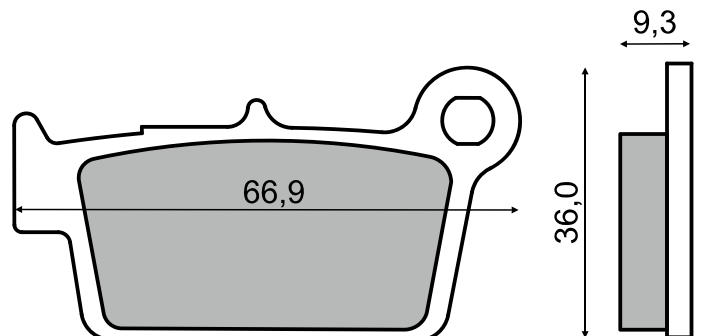

I codici con il numero 0 finale: **MESCOLA ORGANICA**
I codici con il numero 3 finale: **MESCOLA SINTERIZZATA**
• Non omologata

PASTIGLIE FRENO IN ORDINE DI CODICE

BRAKE PADS SEARCH BY CODE NUMBER

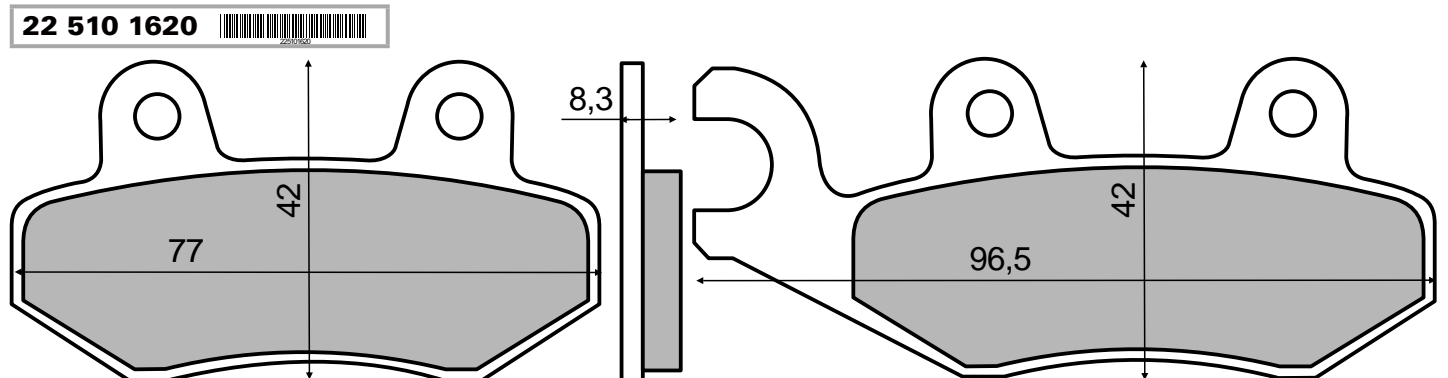
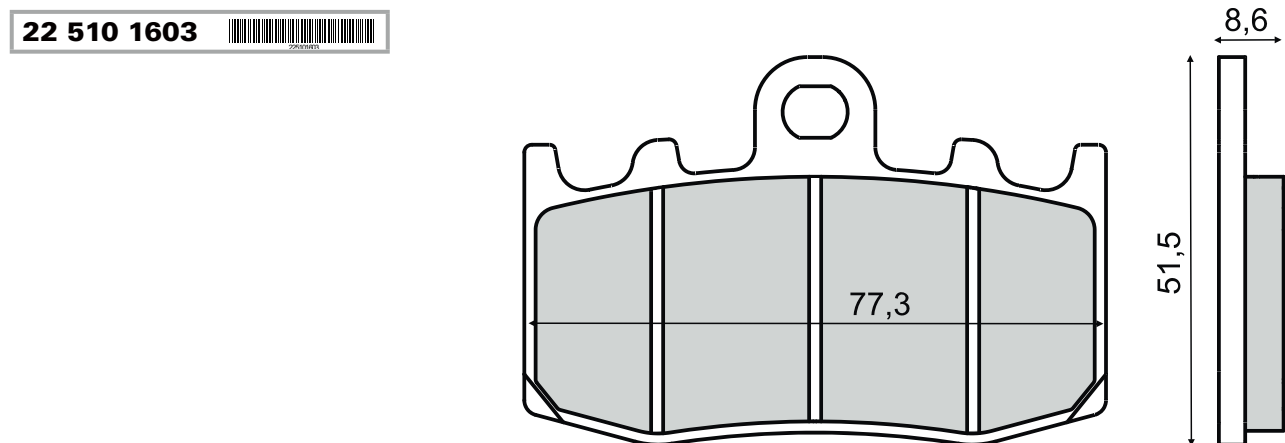
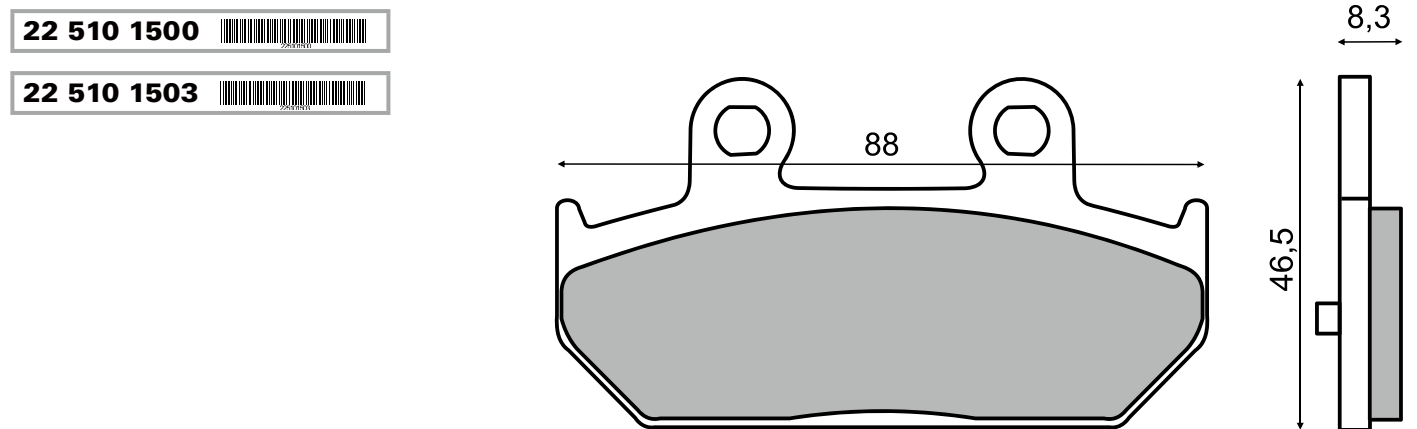
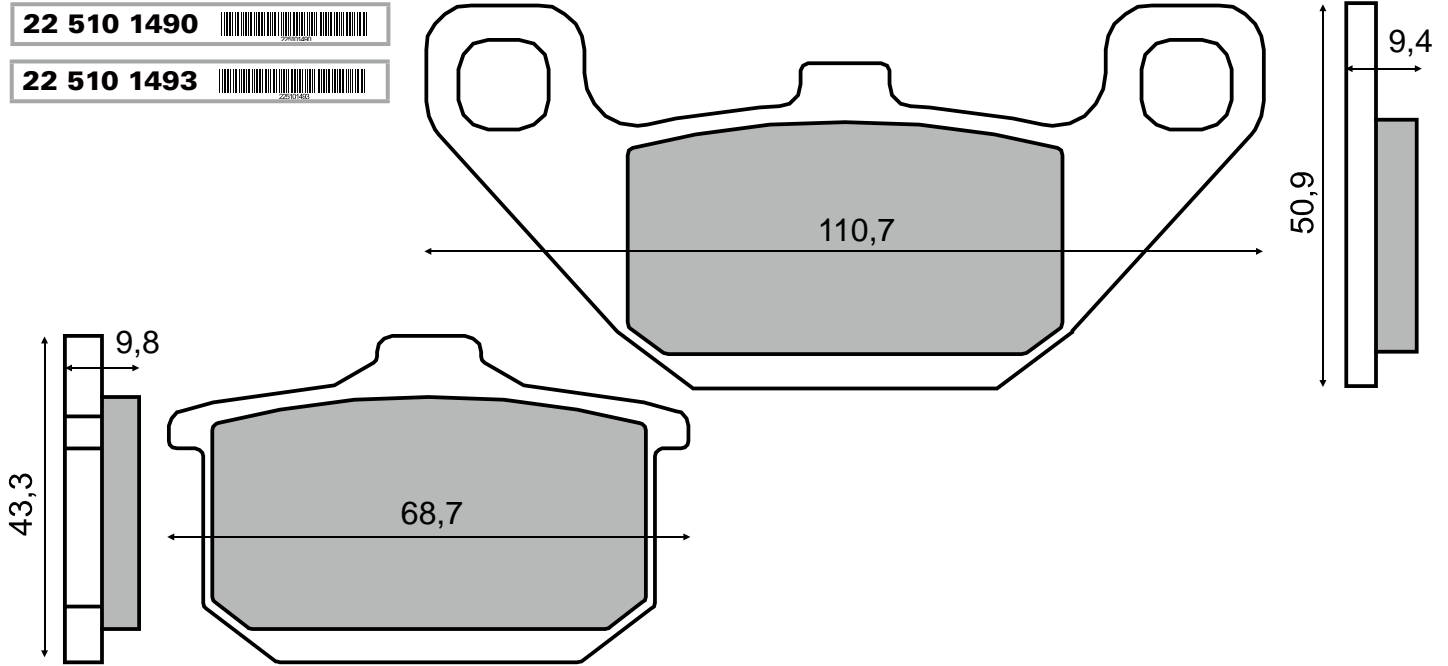



PASTIGLIE FRENO IN ORDINE DI CODICE

BRAKE PADS SEARCH BY CODE NUMBER

22 510 1650



22 510 3440



NEW

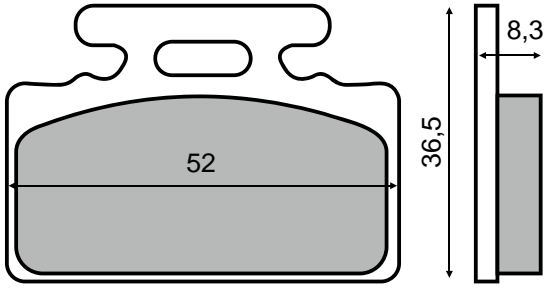

22 510 1790

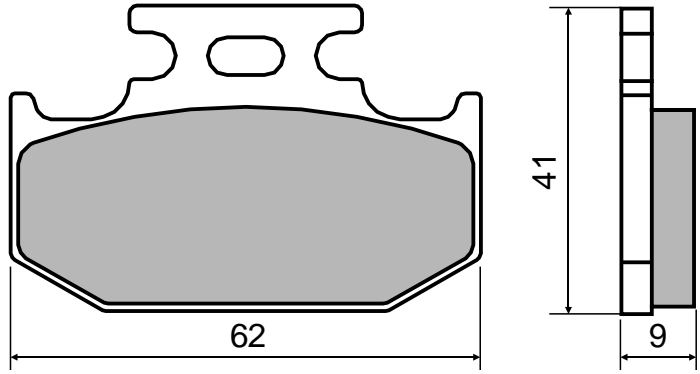

22 510 2020

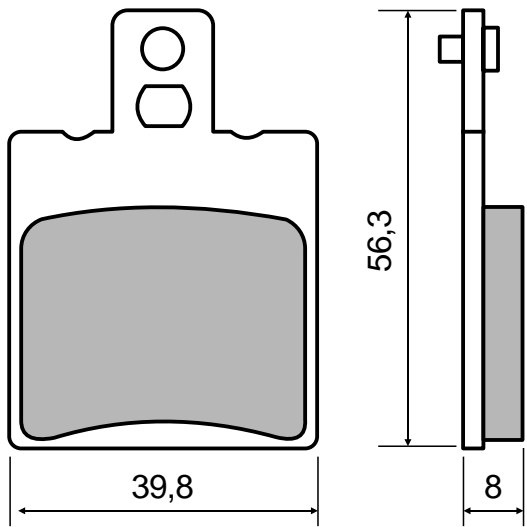

22 510 2120

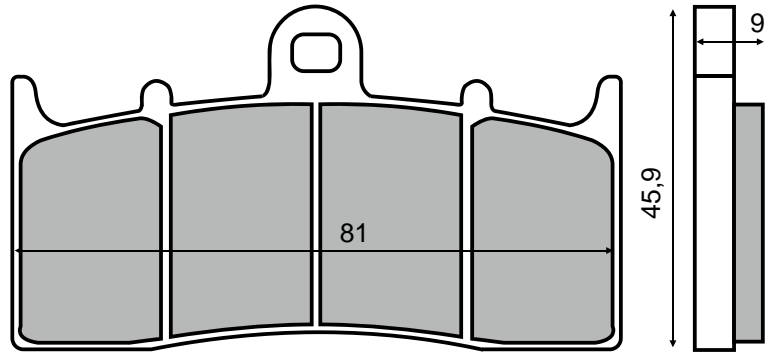

22 510 2530

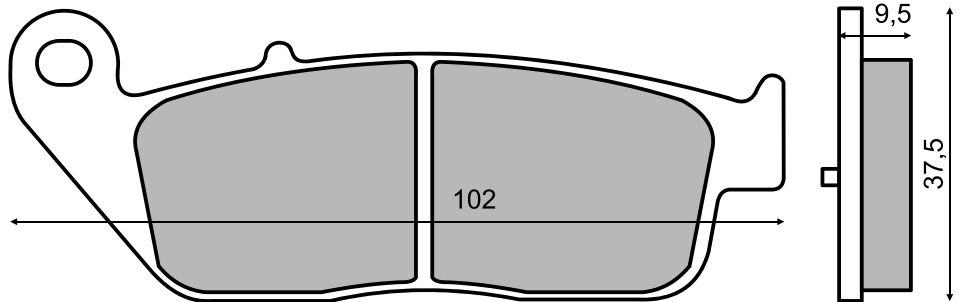

22 510 2540



22 510 2543

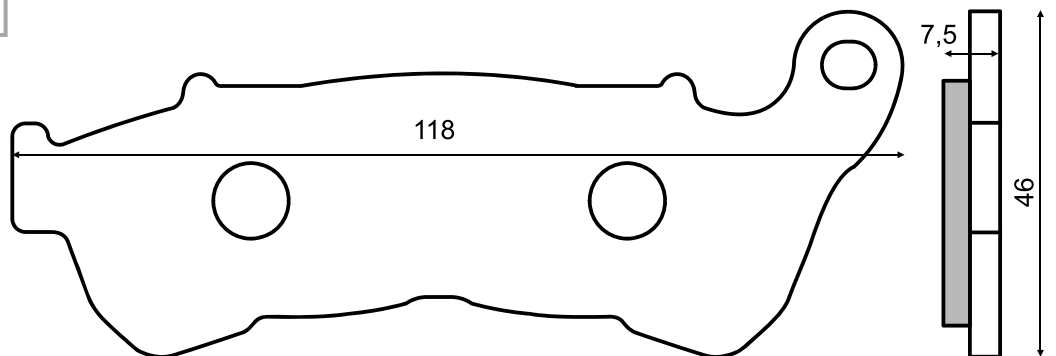

I codici con il numero 0 finale: **MESCOLA ORGANICA**
I codici con il numero 3 finale: **MESCOLA SINTERIZZATA**
● Non omologata

PASTIGLIE FRENO IN ORDINE DI CODICE

BRAKE PADS SEARCH BY CODE NUMBER



22 510 2550

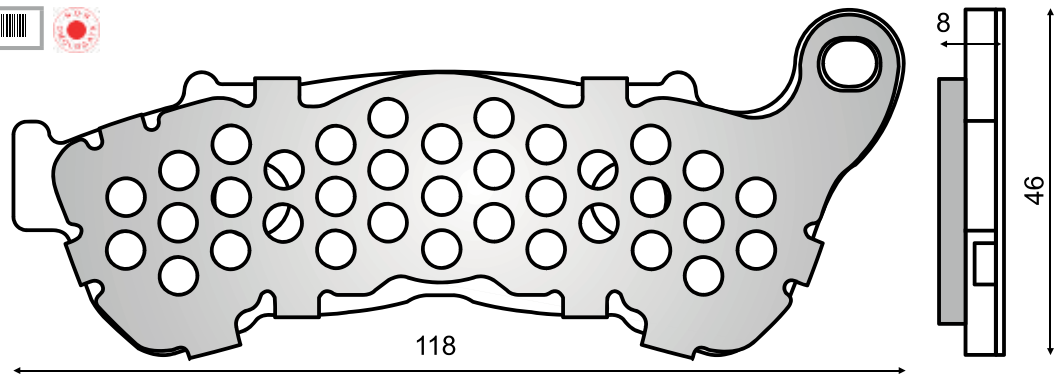

22 510 2560



22 510 2563

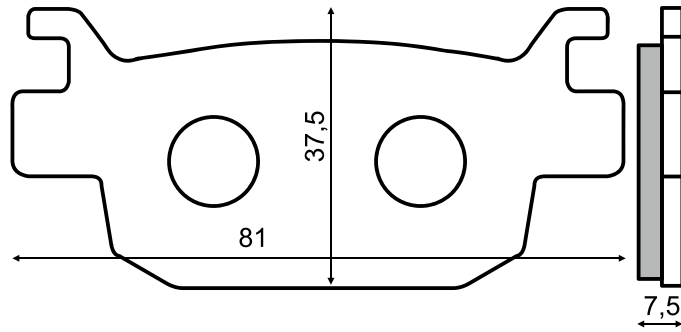

22 510 2570

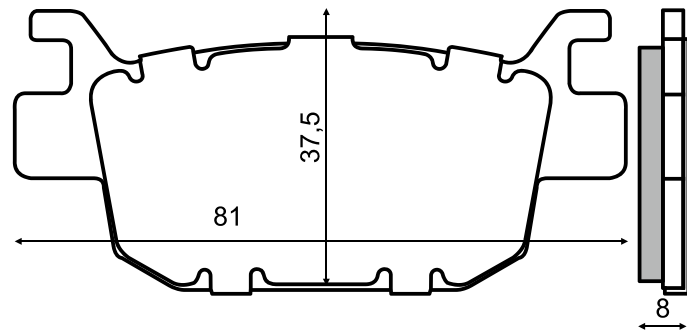

22 510 2590



22 510 2593

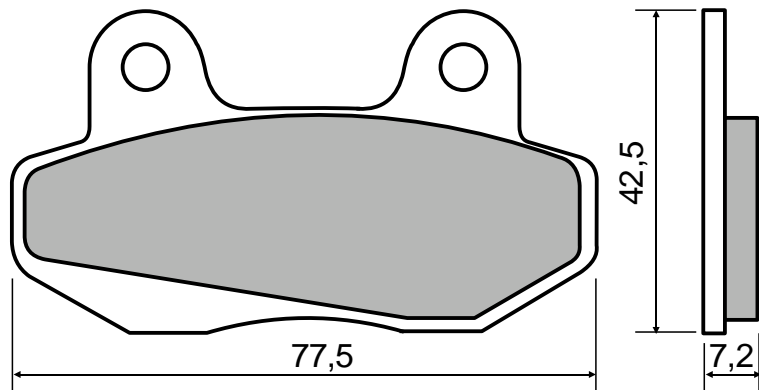

22 510 2600



22 510 2603

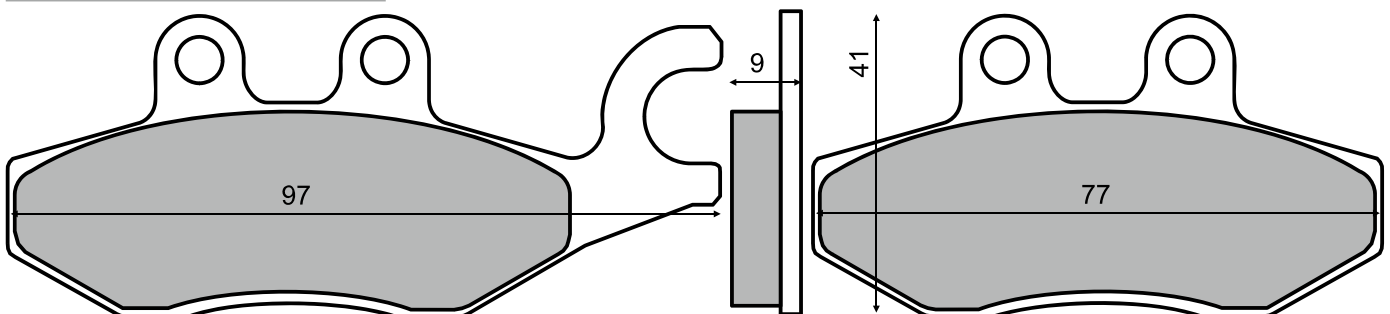



PASTIGLIE FRENO IN ORDINE DI CODICE

BRAKE PADS SEARCH BY CODE NUMBER

- 22 510 2610
- 22 510 2613

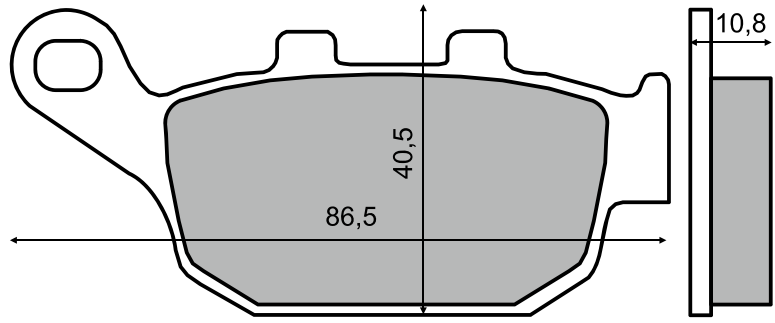

- 22 510 2620
- 22 510 2623

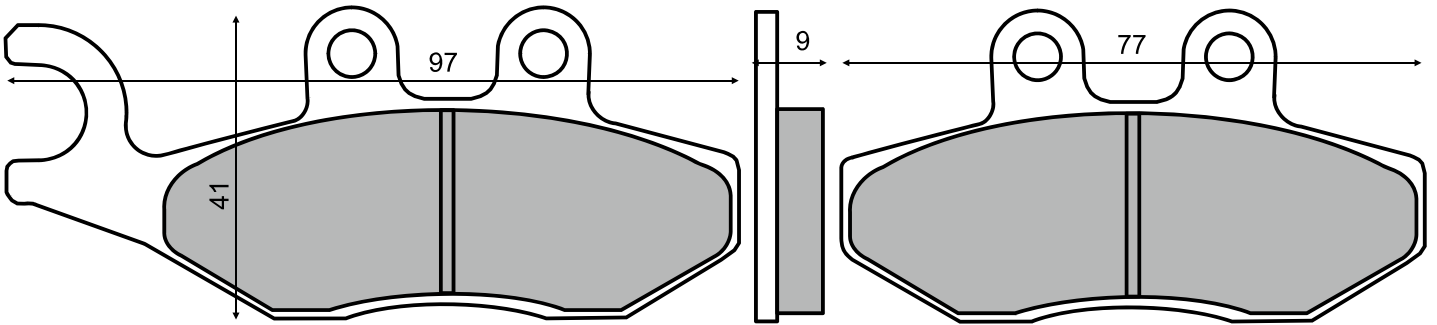

- 22 510 2630
- 22 510 2633

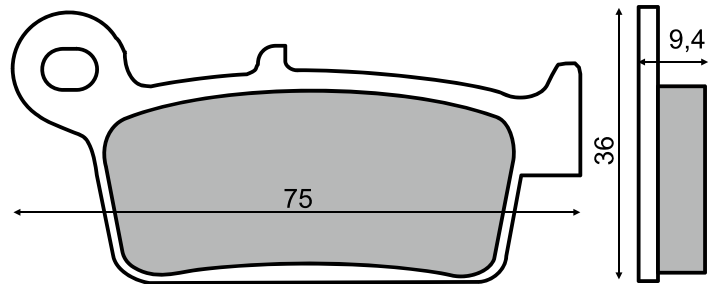

- 22 510 2640
- 22 510 2643

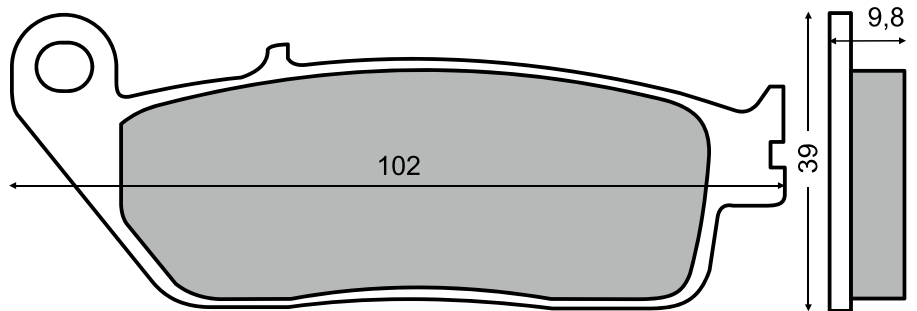

- 22 510 2650
- 22 510 2653

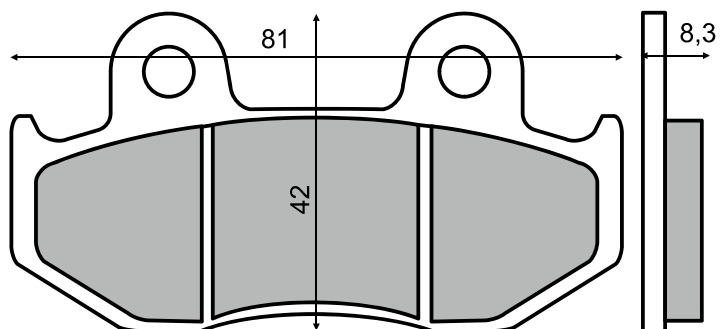

I codici con il numero 0 finale: **MESCOLA ORGANICA**
 I codici con il numero 3 finale: **MESCOLA SINTERIZZATA**
 Non omologata

PASTIGLIE FRENO IN ORDINE DI CODICE
BRAKE PADS SEARCH BY CODE NUMBER



22 510 2660

22 510 2663

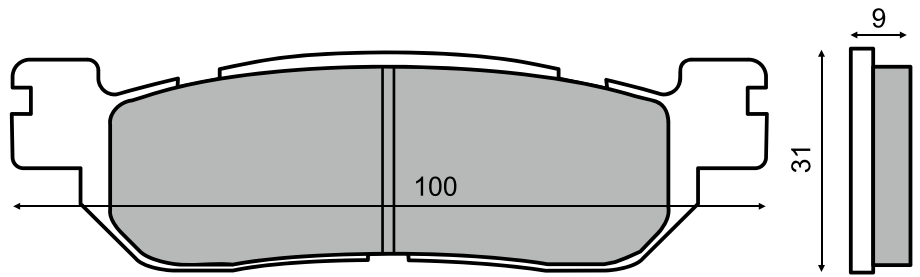

22 510 2670

22 510 0440



22 510 2673

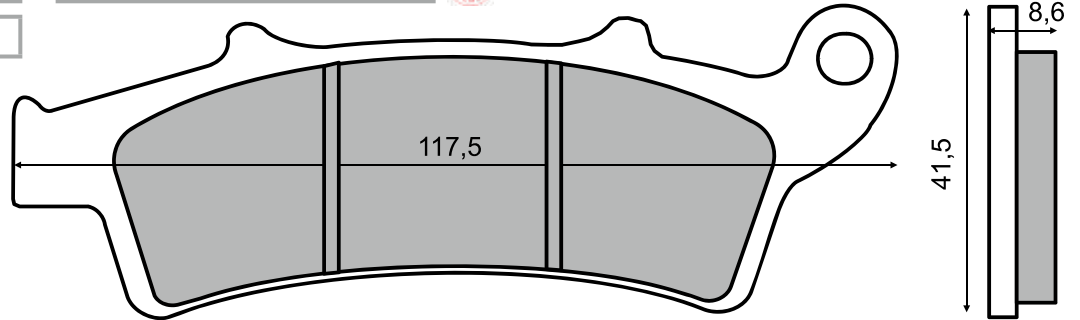

22 510 2710

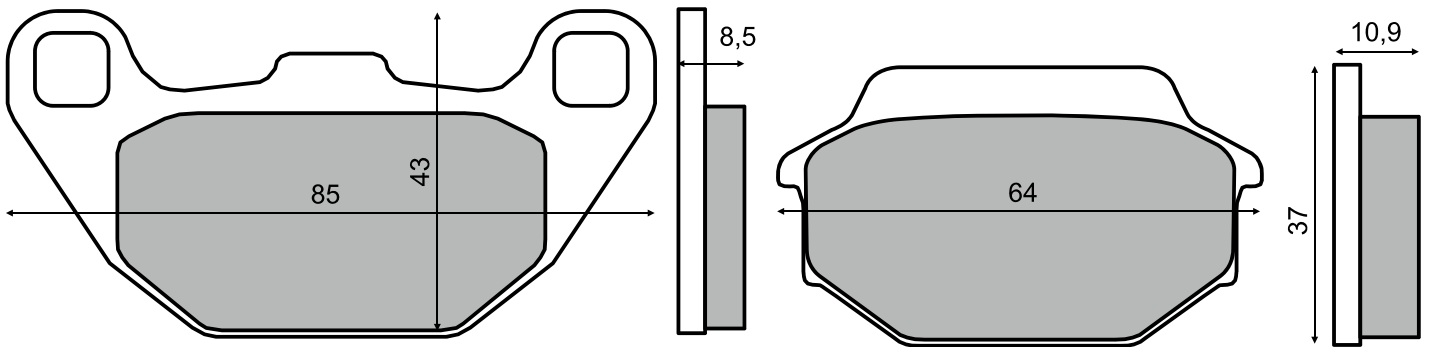

22 510 2720

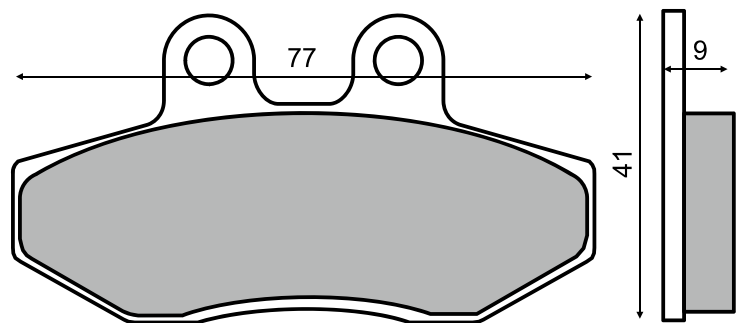

22 510 2730

22 510 1430

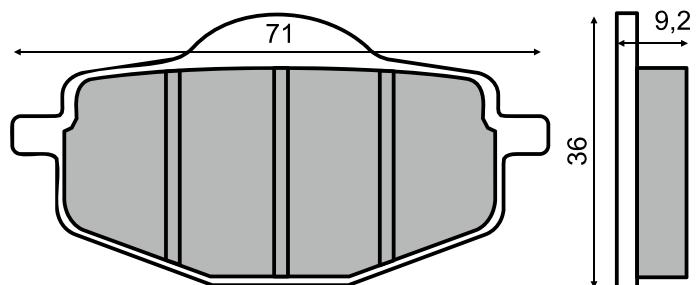



PASTIGLIE FRENO IN ORDINE DI CODICE

BRAKE PADS SEARCH BY CODE NUMBER

22 510 2740



22 510 2743

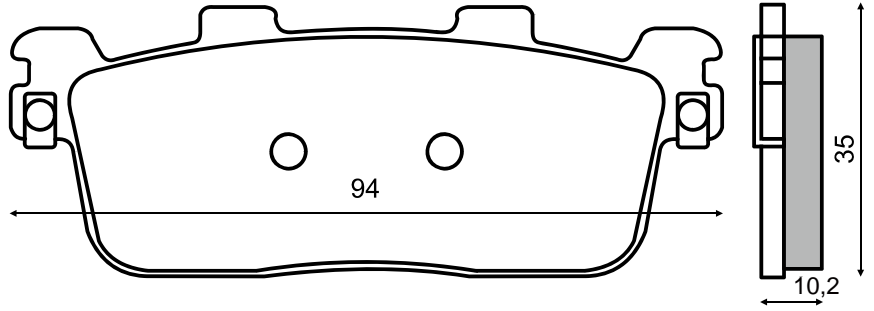

22 510 2750



22 510 2753

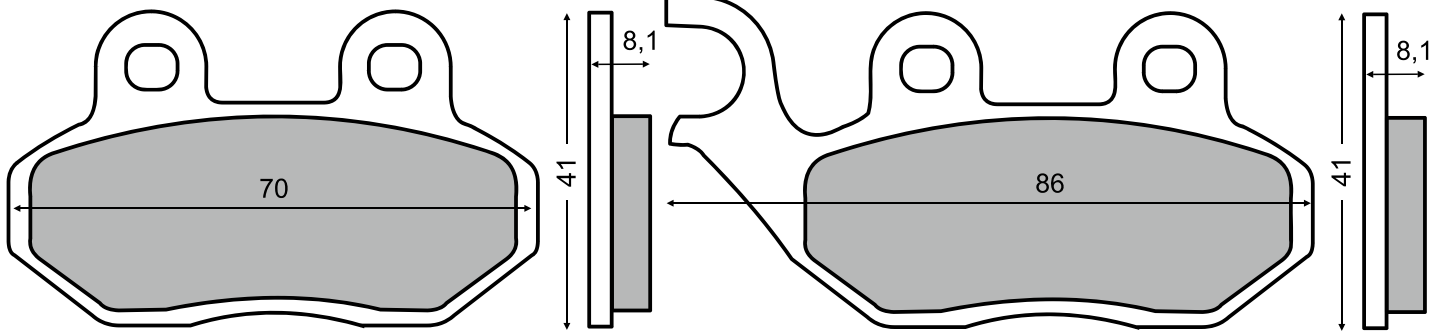

22 510 2760



22 510 2763

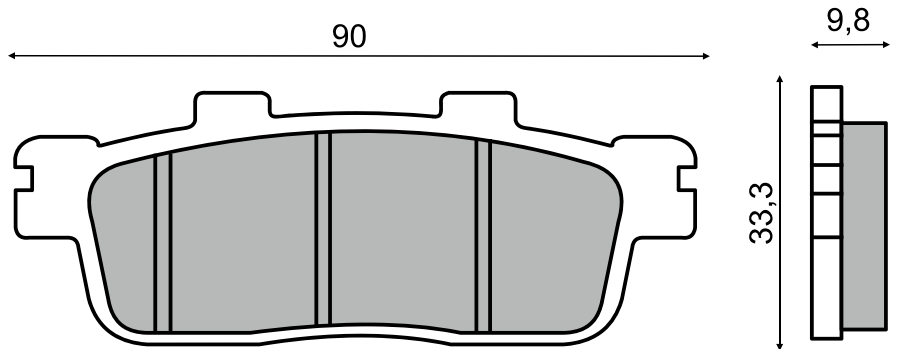

22 510 2780

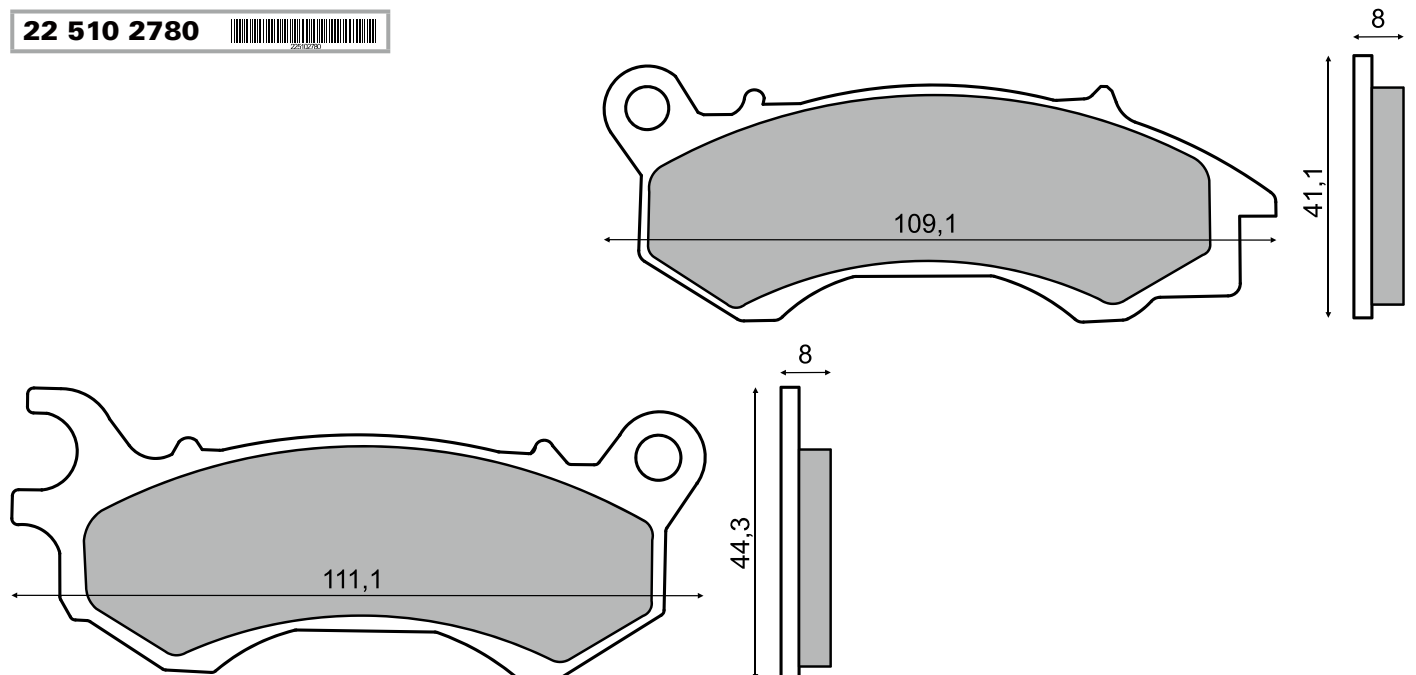



22 510 2800

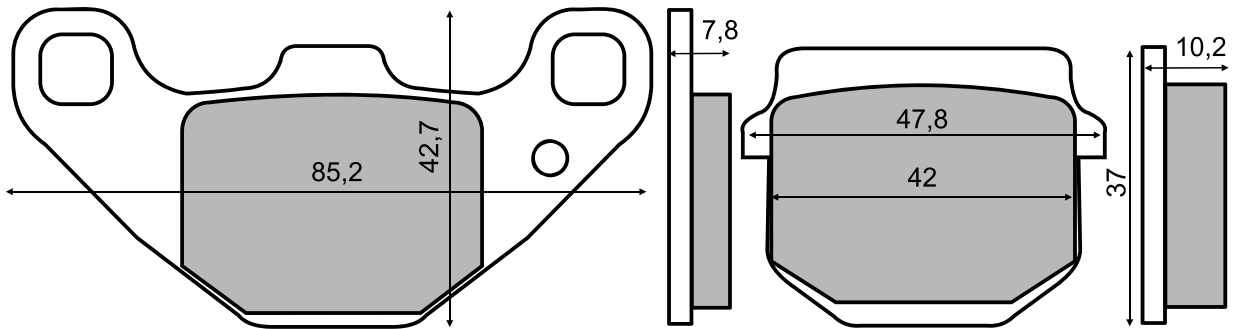

22 510 2810

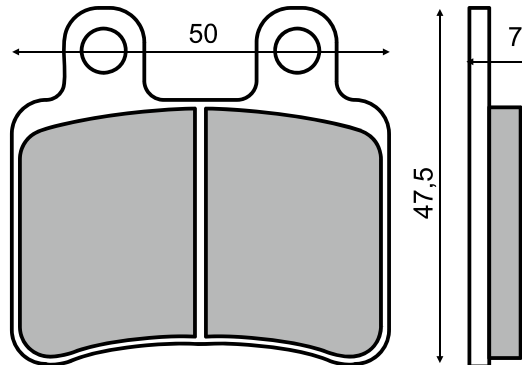

22 510 2820

22 510 2823

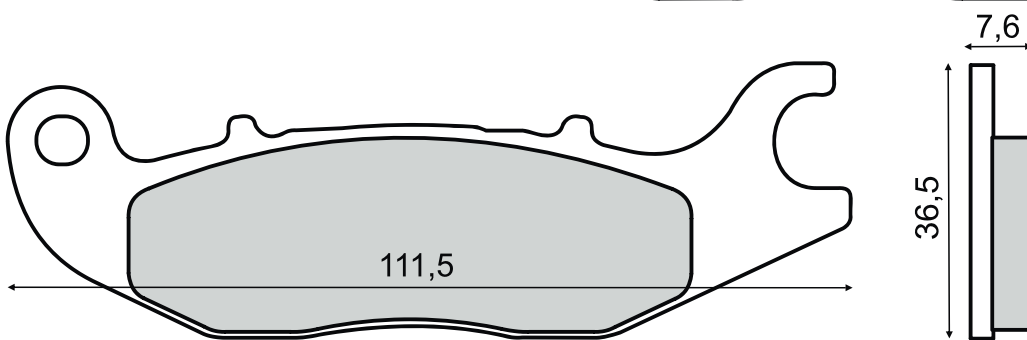
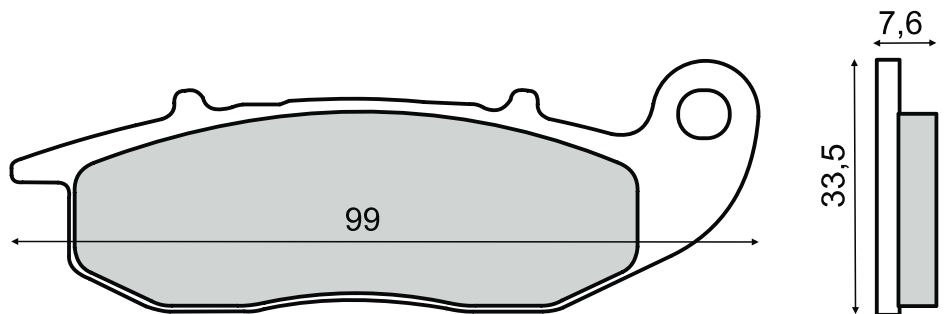

22 510 2830

22 510 2833

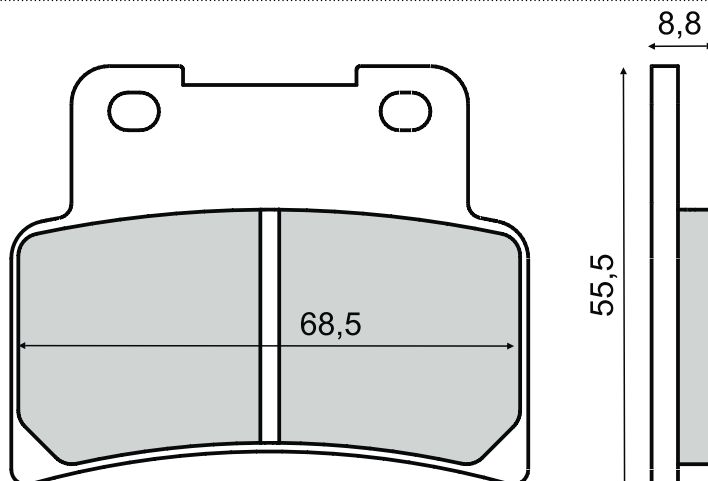



PASTIGLIE FRENO IN ORDINE DI CODICE

BRAKE PADS SEARCH BY CODE NUMBER

22 510 2840



22 510 2843

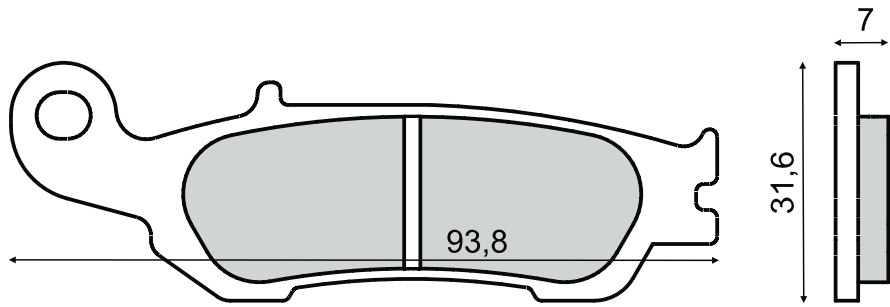

22 510 2850



22 510 2853



22 510 2860



22 510 2863

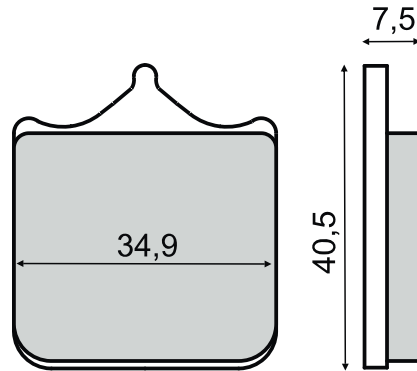
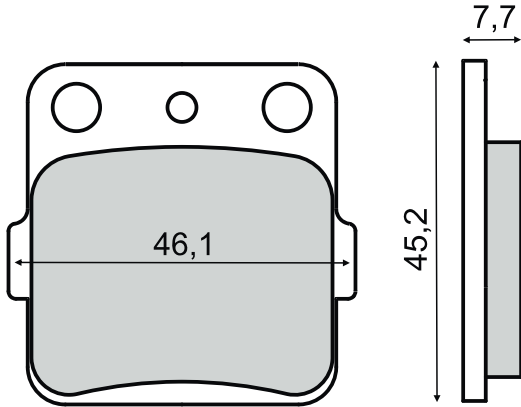

22 510 2870



22 510 2873

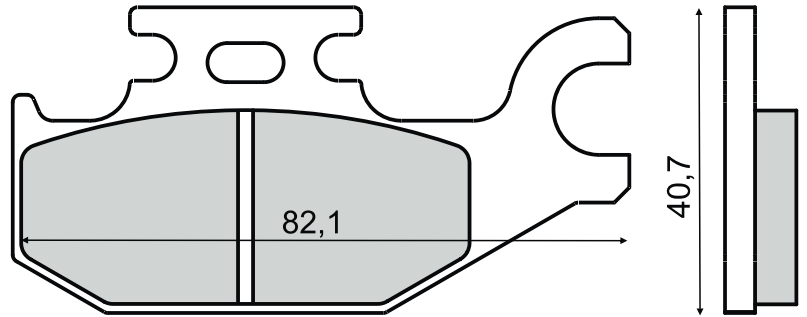
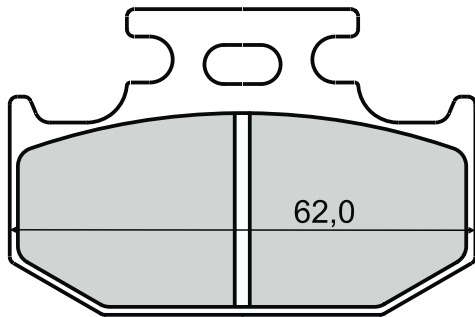

22 510 2880



22 510 2883

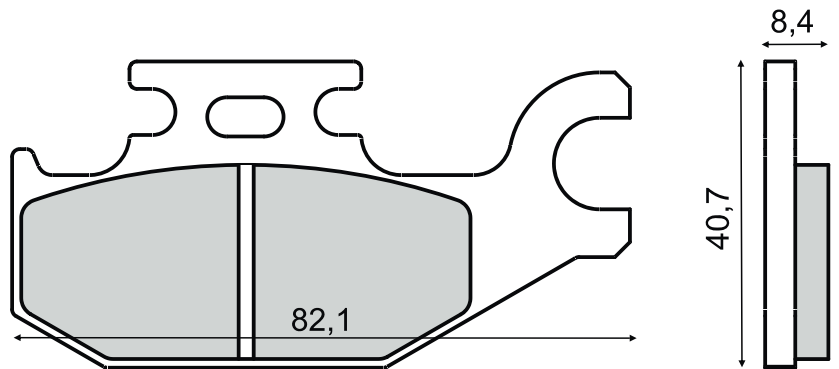
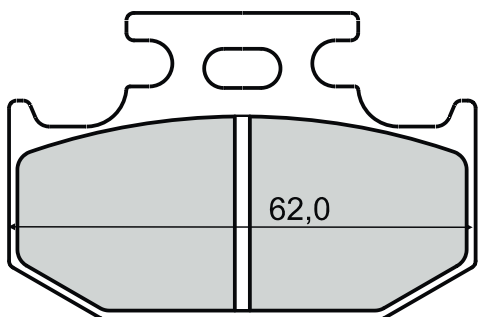

I codici con il numero 0 finale: **MESCOLA ORGANICA**
I codici con il numero 3 finale: **MESCOLA SINTERIZZATA**
Non omologata

PASTIGLIE FRENO IN ORDINE DI CODICE

BRAKE PADS SEARCH BY CODE NUMBER



22 510 2890

22 510 2893

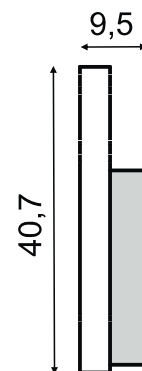
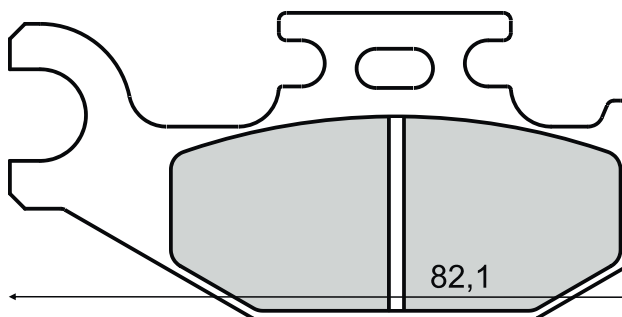
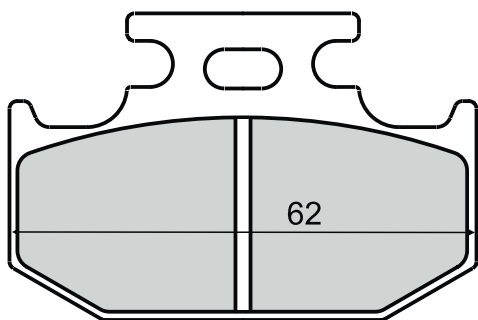

22 510 2900

22 510 2903

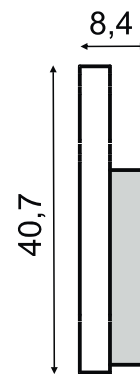
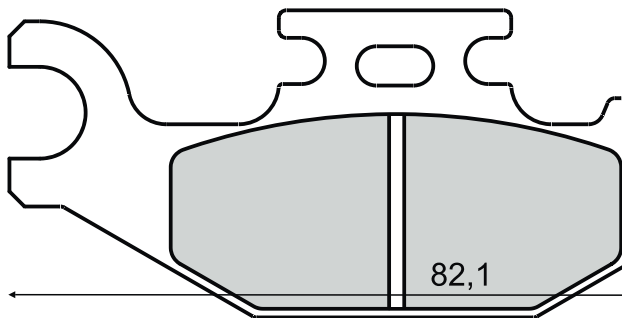
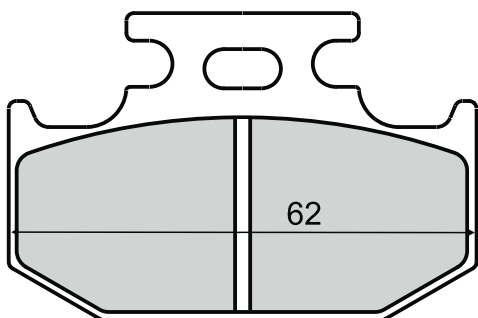

22 510 2910

22 510 2913

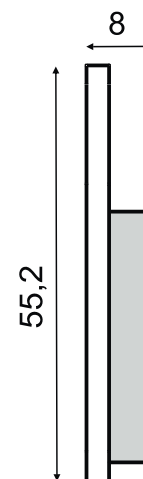
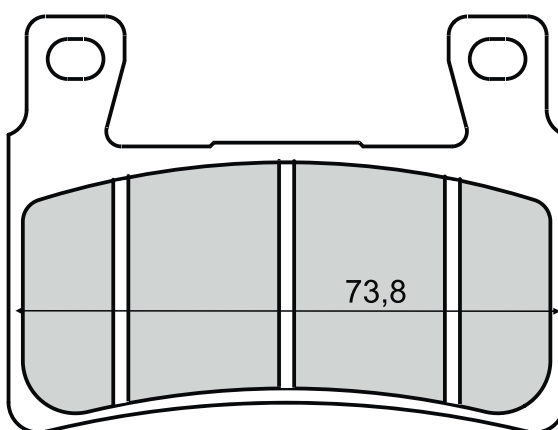

22 510 2923

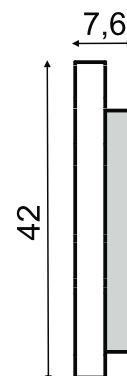
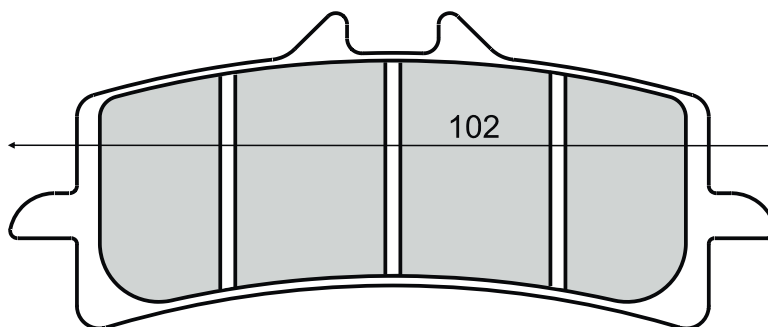



PASTIGLIE FRENO IN ORDINE DI CODICE

BRAKE PADS SEARCH BY CODE NUMBER

22 510 2933

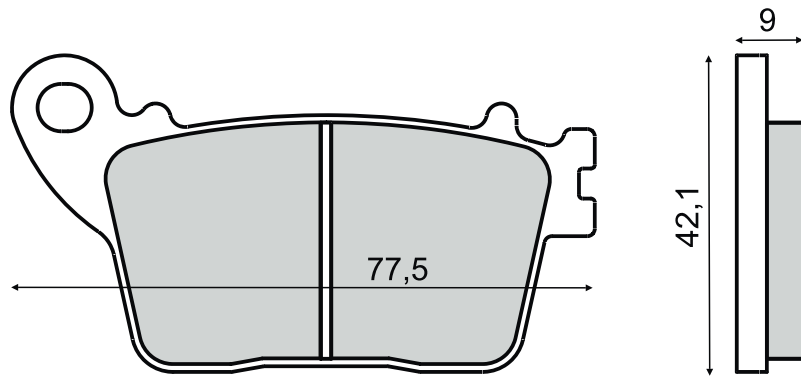

22 510 2943

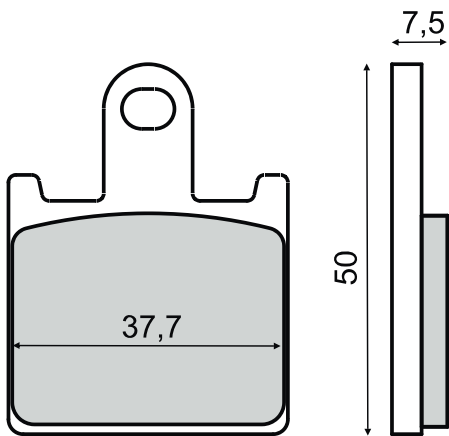

22 510 2950



22 510 2953

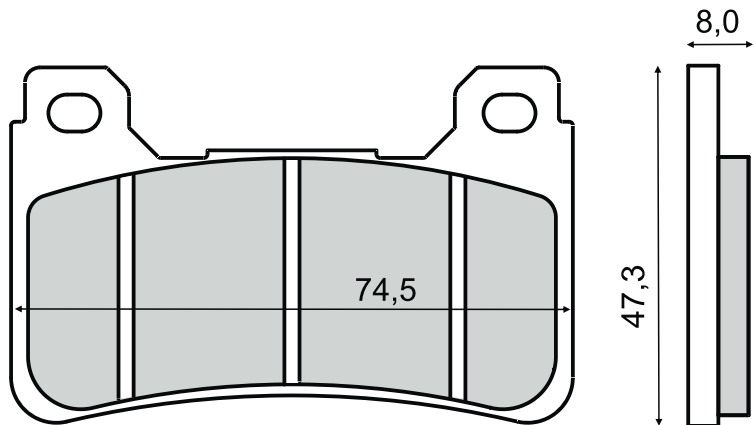

22 510 2960



22 510 2963

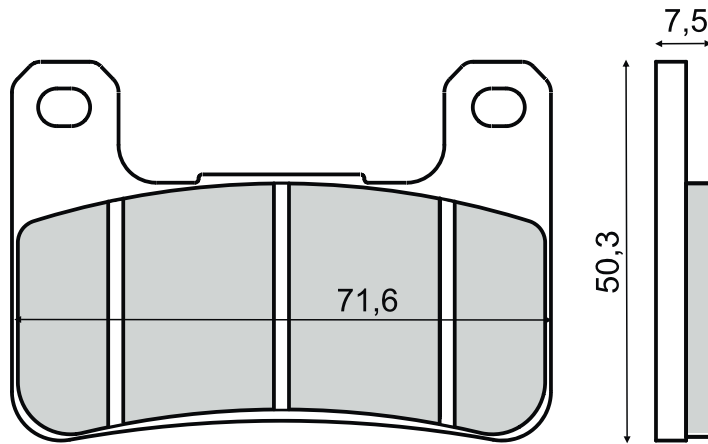

22 510 2973

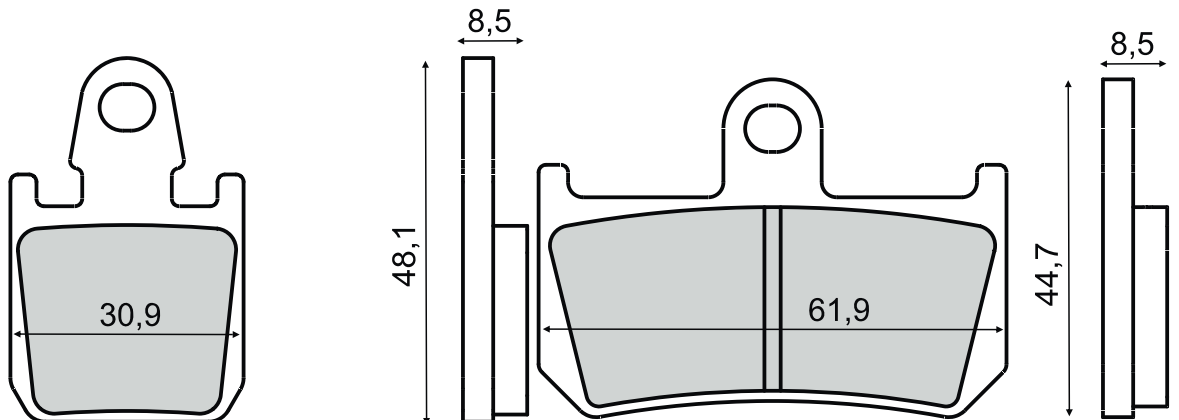



22 510 2983

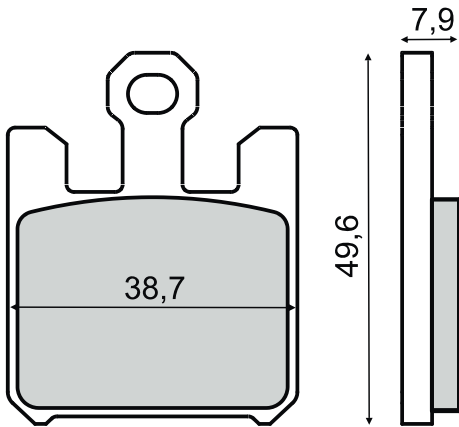

22 510 2993

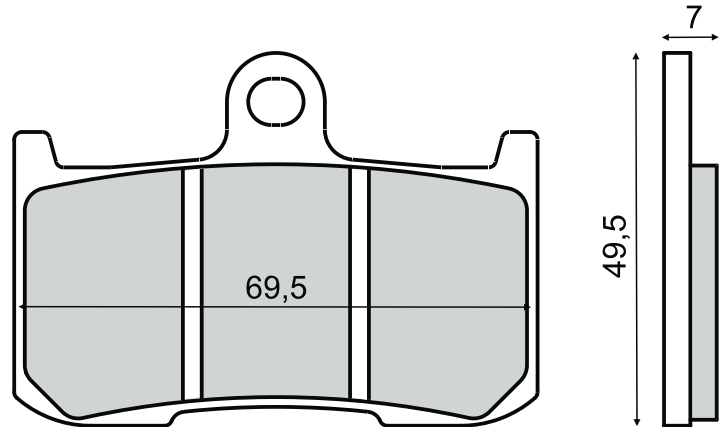

22 510 3003

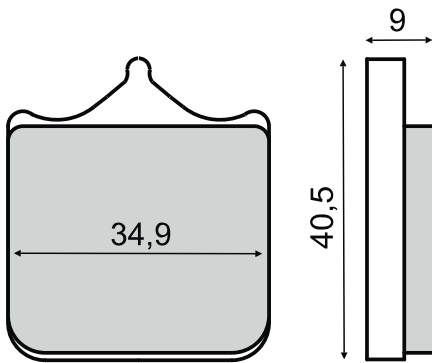

22 510 3013

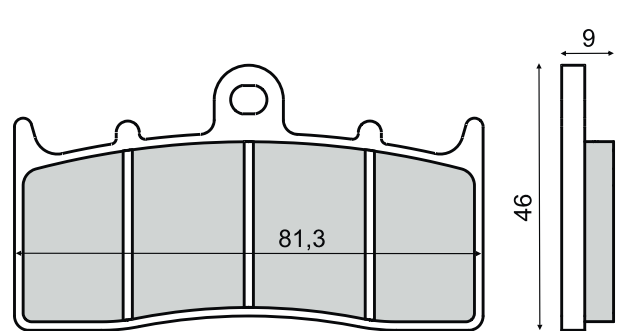

22 510 3020

22 510 3023

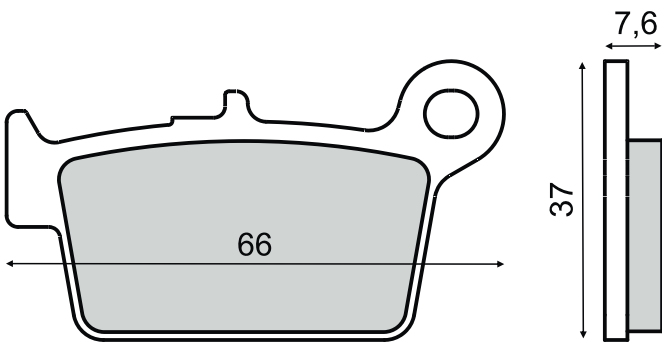

22 510 3030

22 510 3033

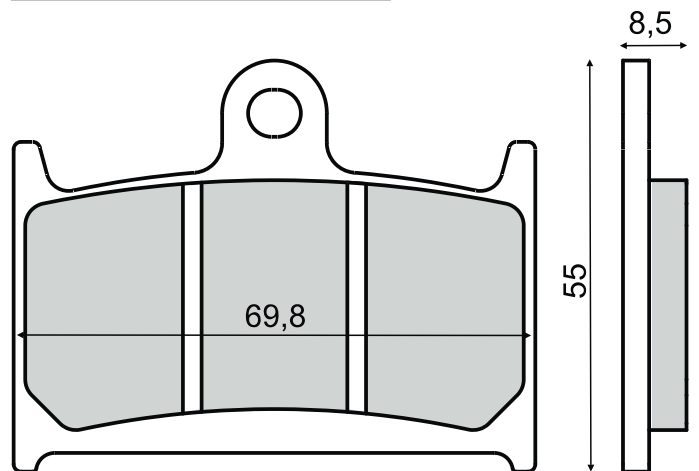

22 510 3043

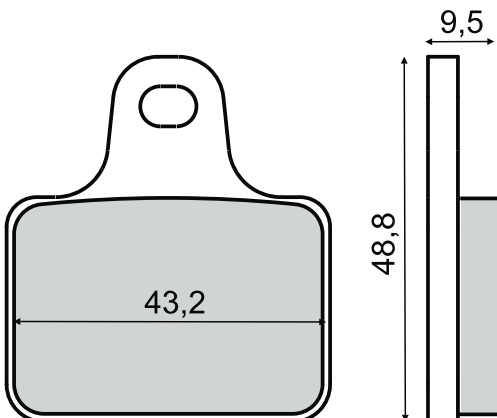



PASTIGLIE FRENO IN ORDINE DI CODICE

BRAKE PADS SEARCH BY CODE NUMBER

22 510 3050



22 510 3053

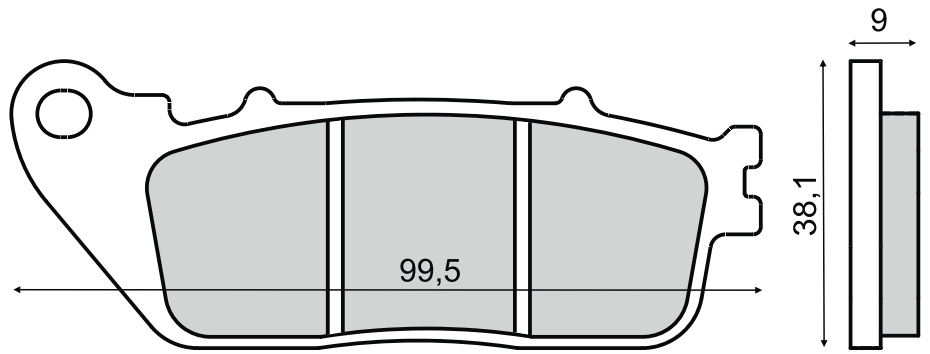

22 510 3060



22 510 3063

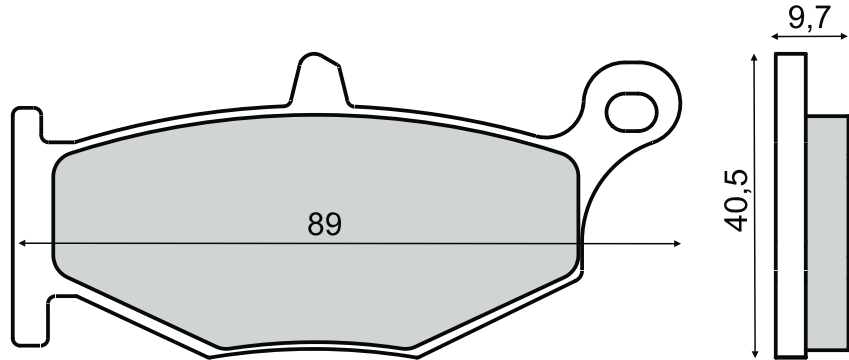

22 510 3070



22 510 3073

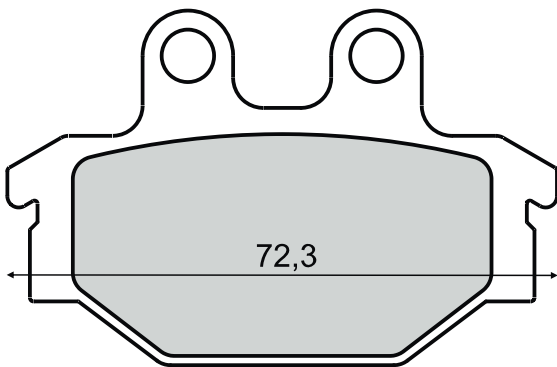
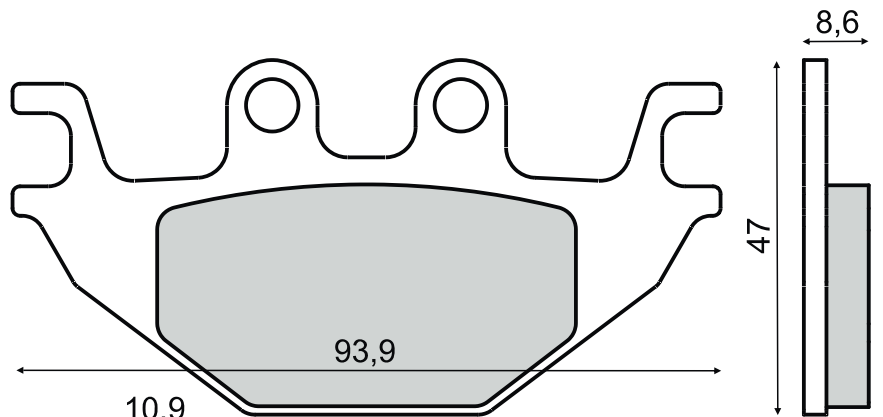

22 510 3080



22 510 3083

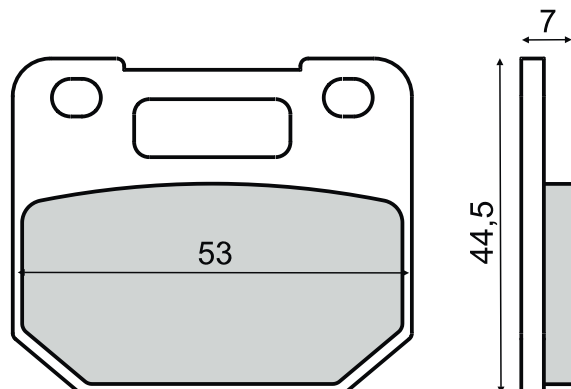



22 510 3093

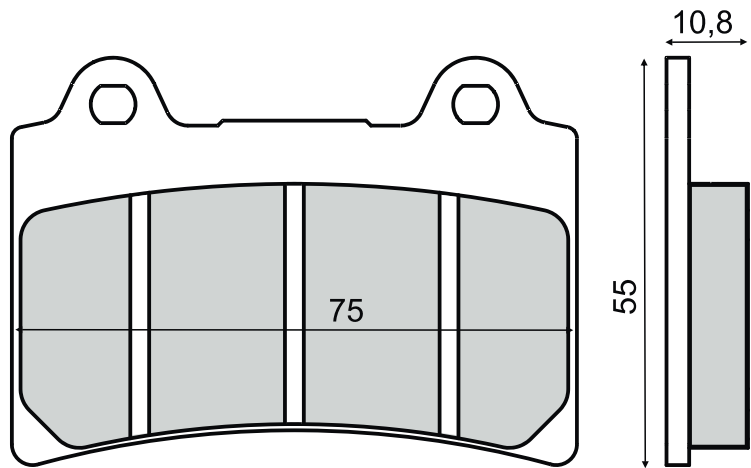

22 510 3103

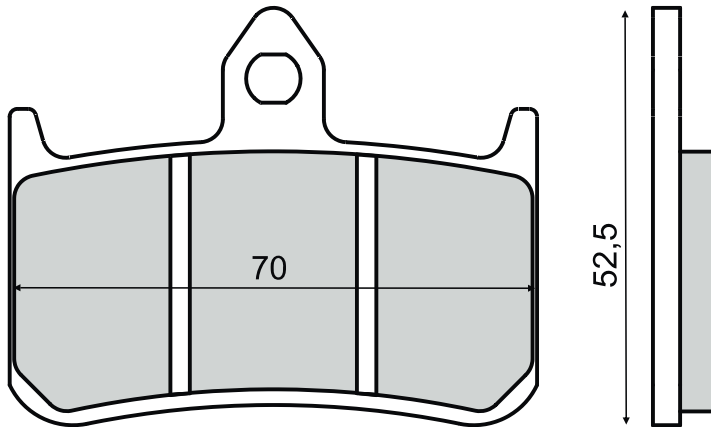

22 510 3110

22 510 3113

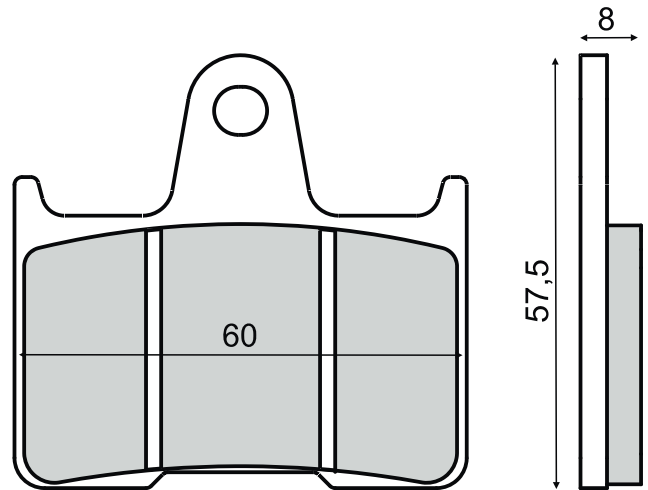

22 510 3123

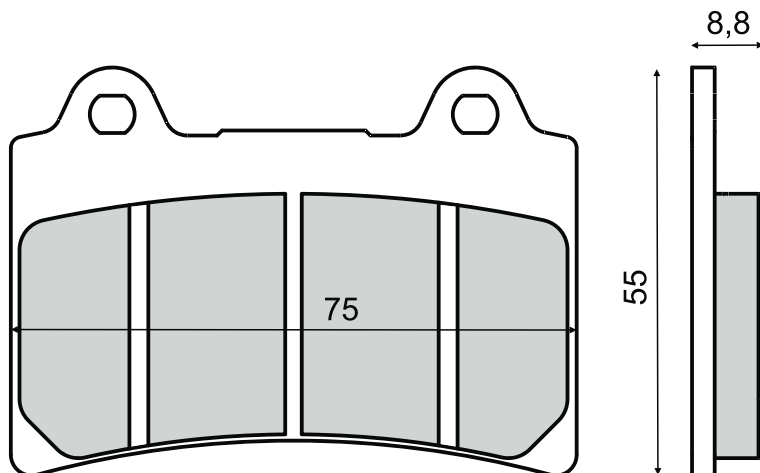

22 510 3130

22 510 3133

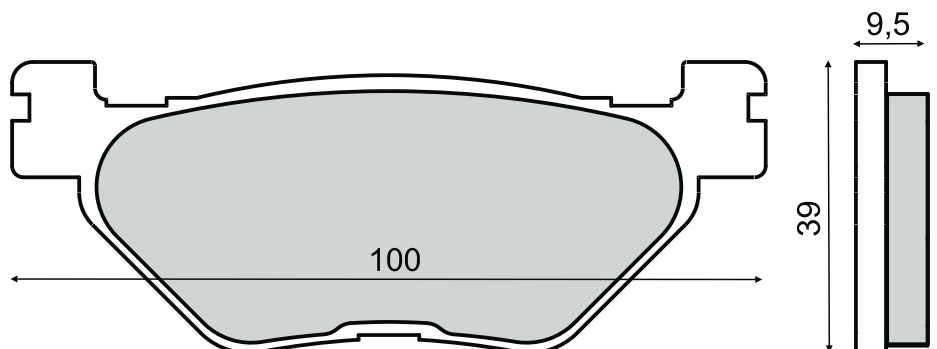



PASTIGLIE FRENO IN ORDINE DI CODICE

BRAKE PADS SEARCH BY CODE NUMBER

22 510 3140 

22 510 3143 

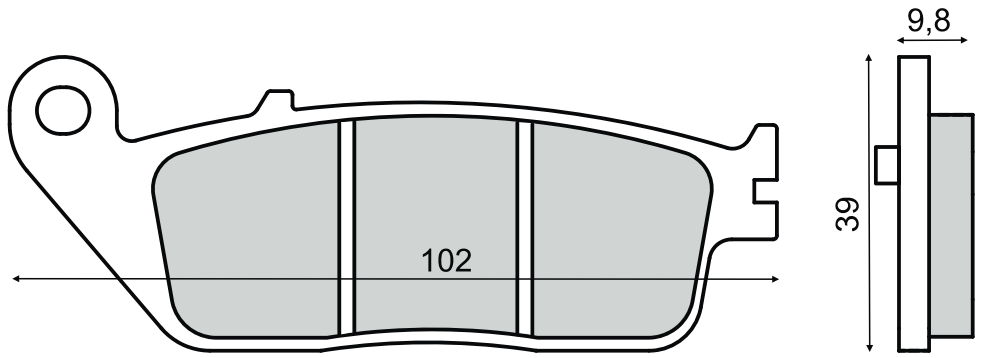

22 510 3150 

22 510 3153 

22 510 3160 

22 510 3163 

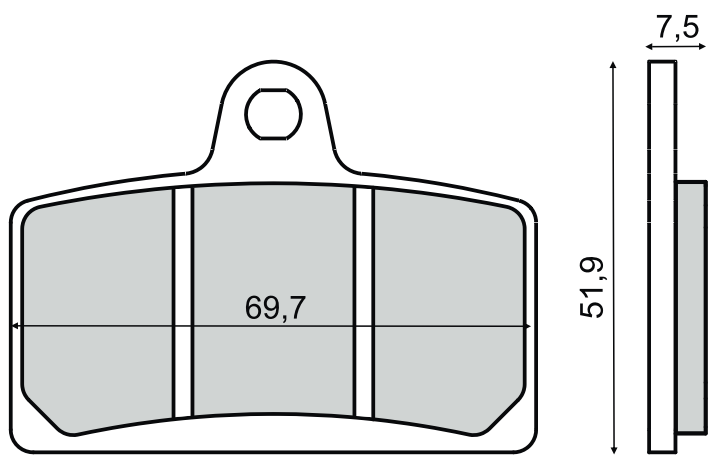
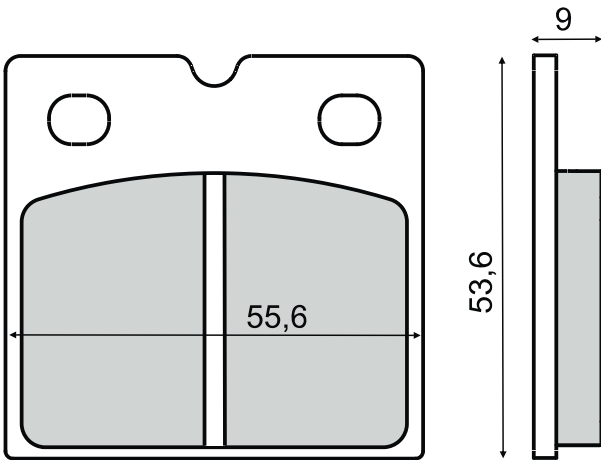

22 510 3170 

22 510 3173 

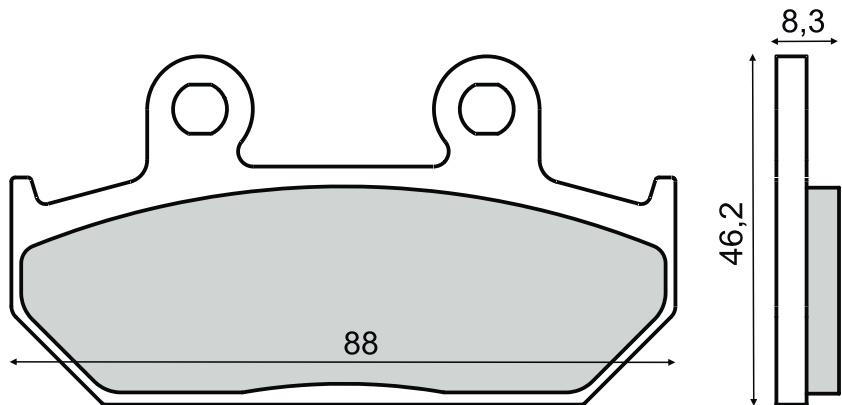

22 510 3180 

22 510 3183 

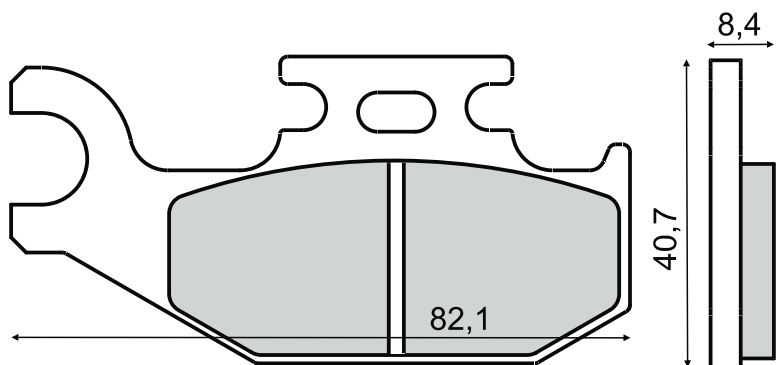
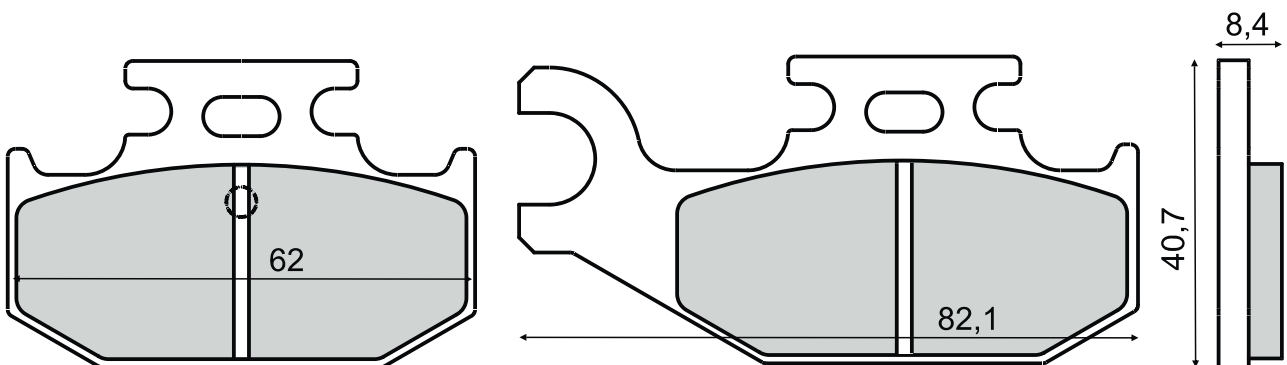



22 510 3193

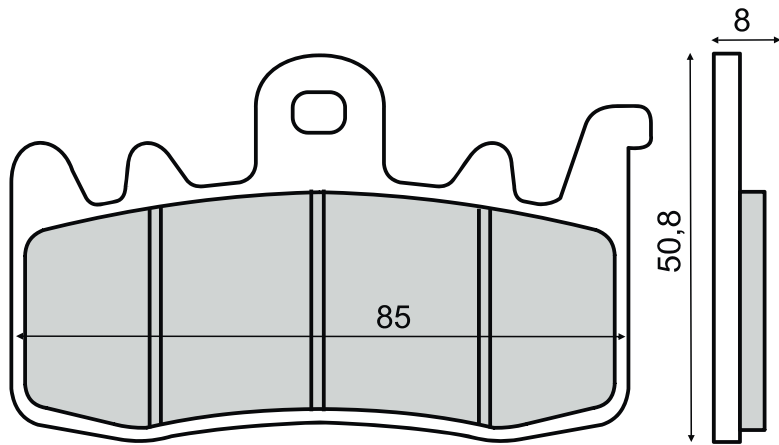

22 510 3200

22 510 3203

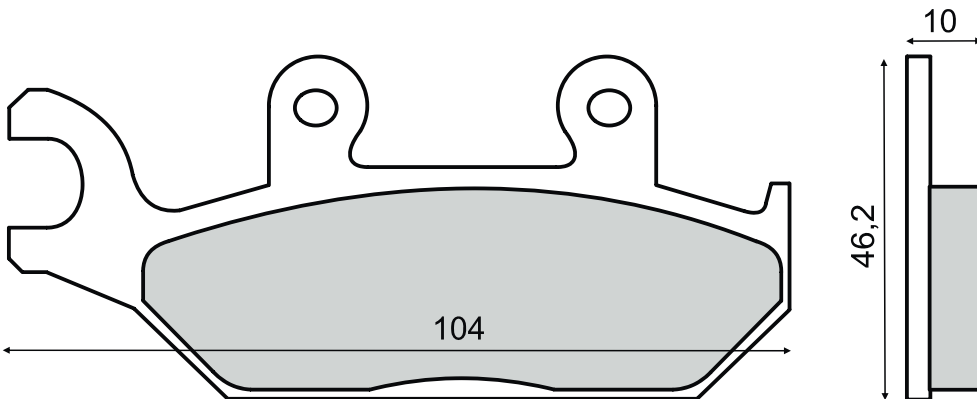
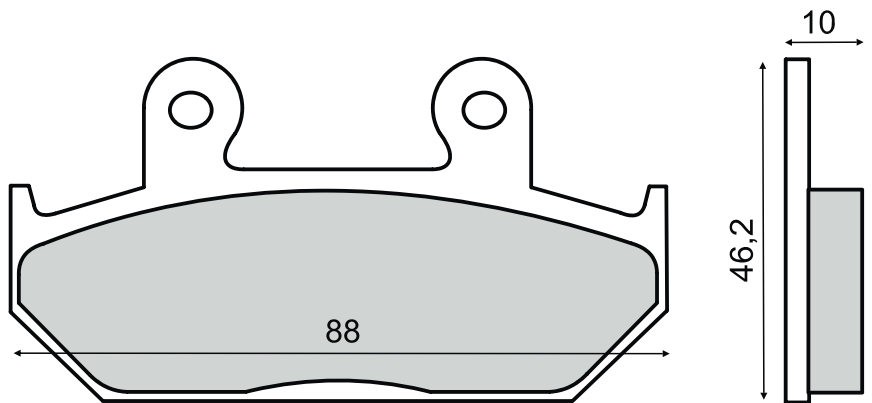

22 510 3210

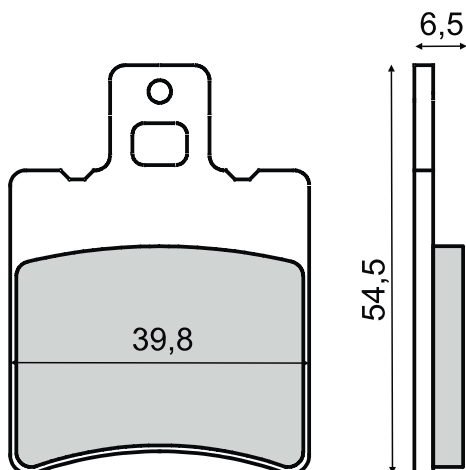

22 510 3220

22 510 3223

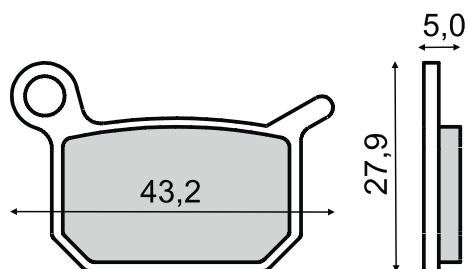



PASTIGLIE FRENO IN ORDINE DI CODICE

BRAKE PADS SEARCH BY CODE NUMBER

22 510 3230

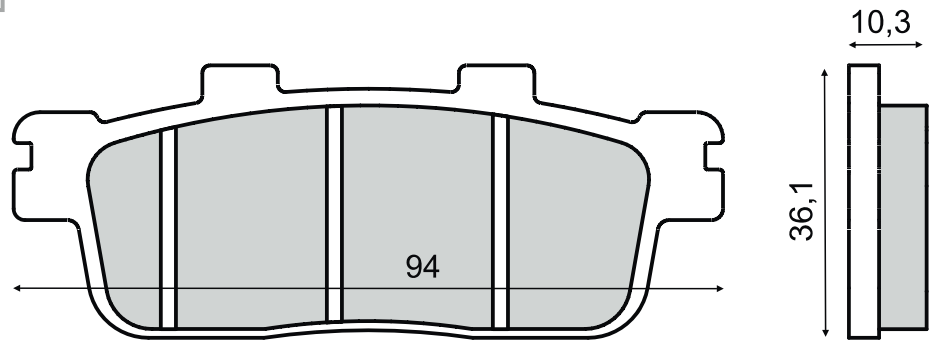

22 510 3240

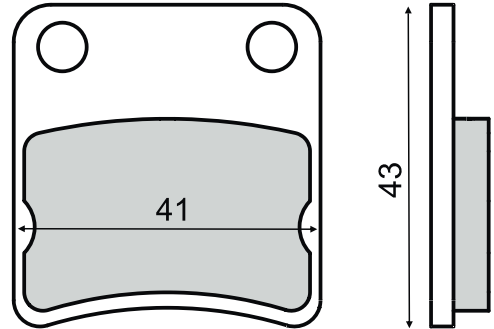

22 510 3250

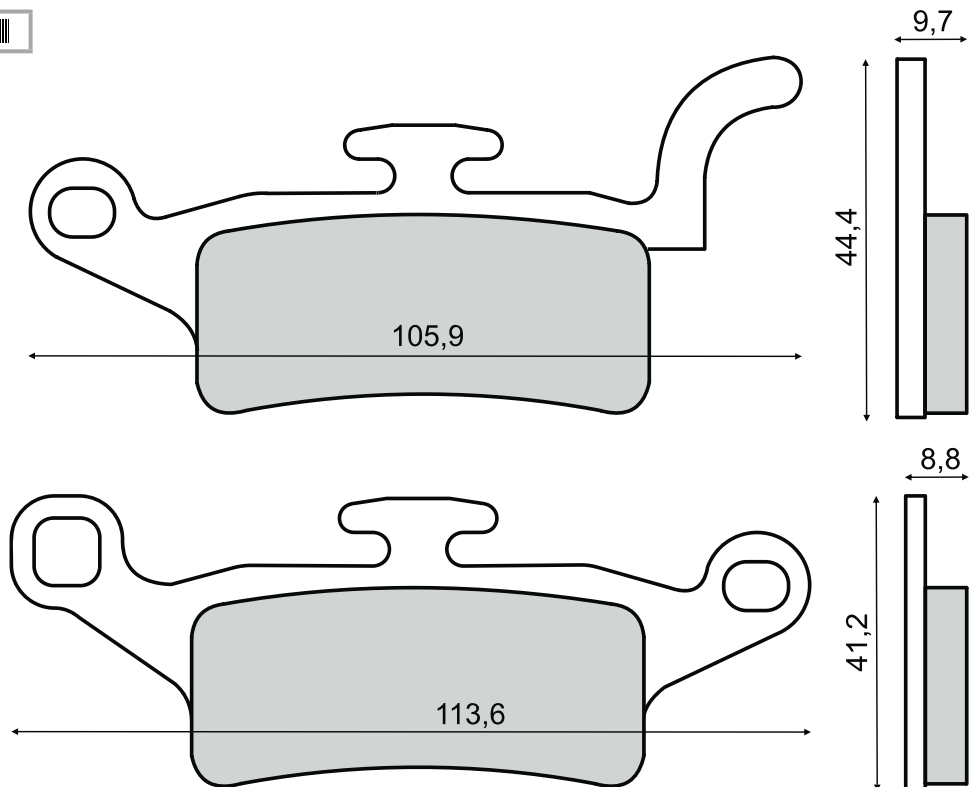

22 510 3260

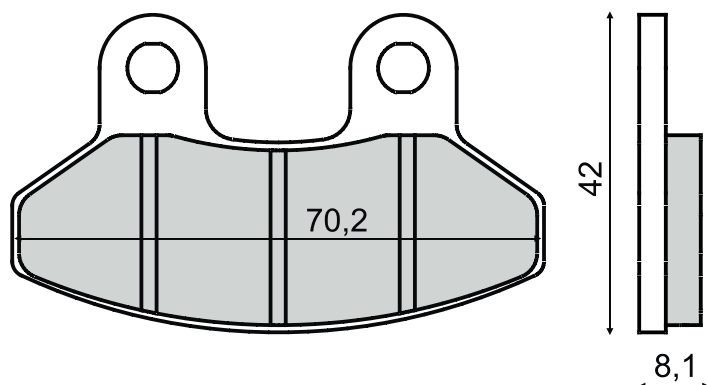



22 510 3270 
22 510 3273 

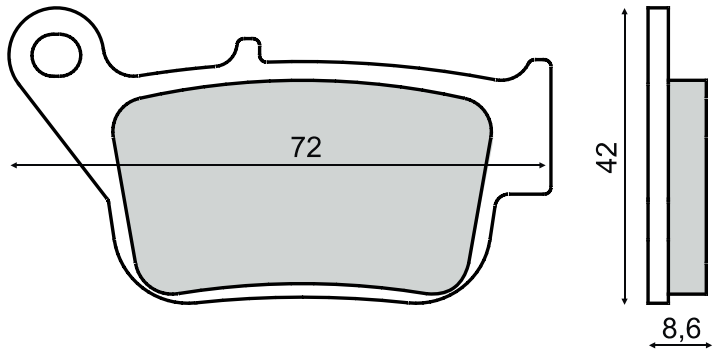

22 510 3280 
22 510 3283 

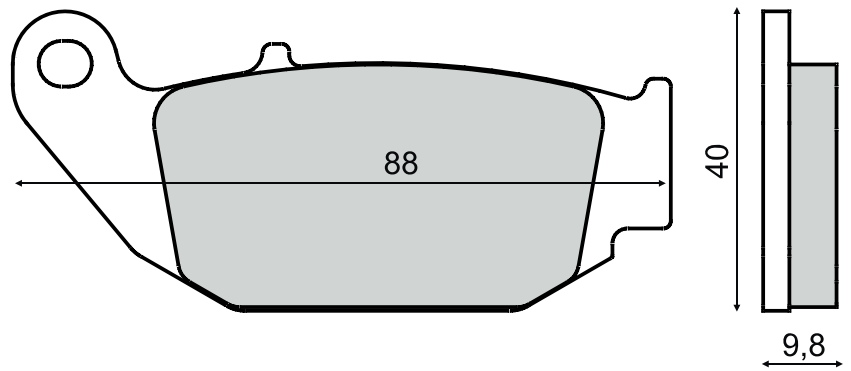

22 510 3290 

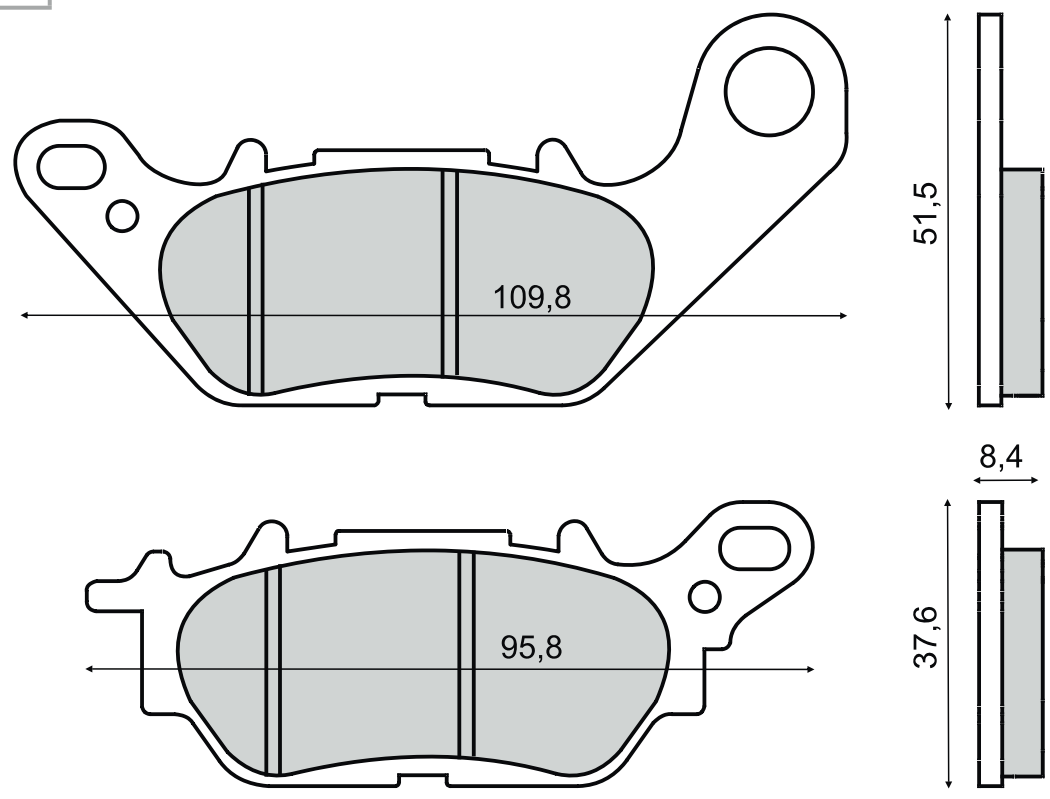

22 510 3300 

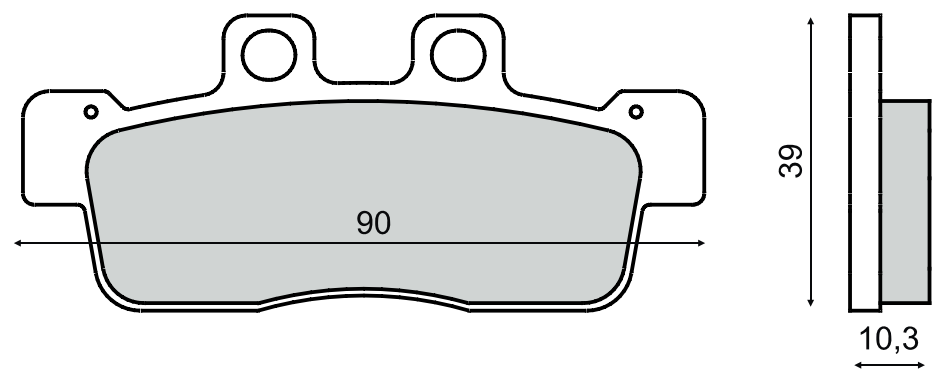



PASTIGLIE FRENO IN ORDINE DI CODICE

BRAKE PADS SEARCH BY CODE NUMBER

22 510 3310



22 510 3313

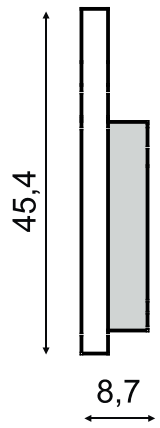
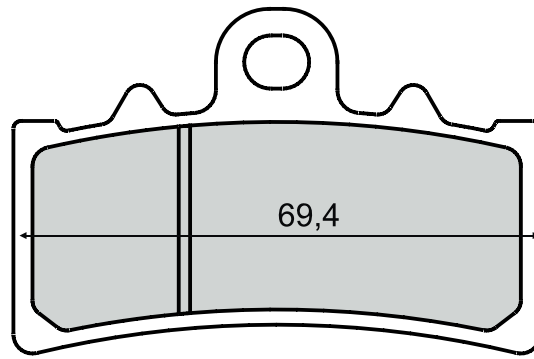

22 510 3323

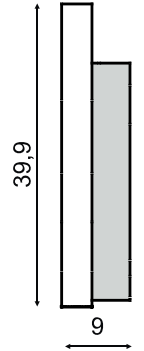
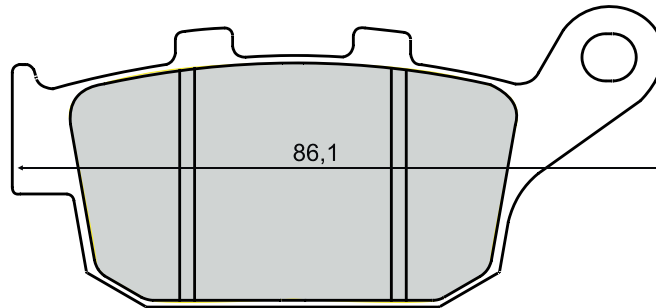

22 510 3333

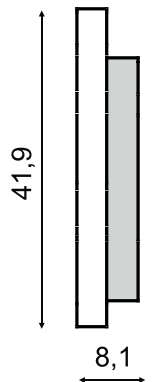
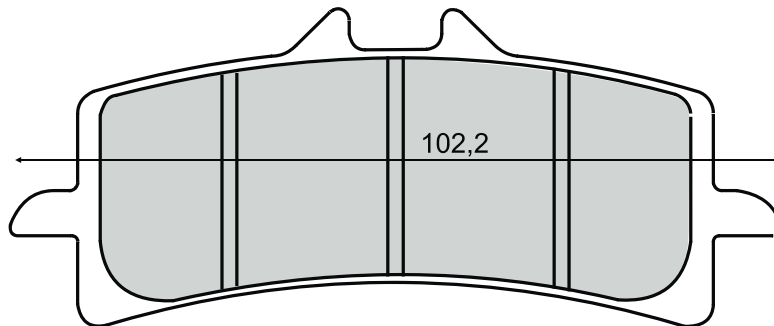

22 510 3343

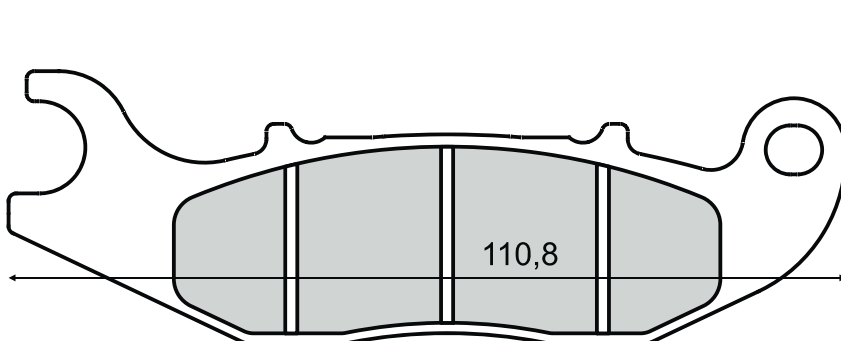
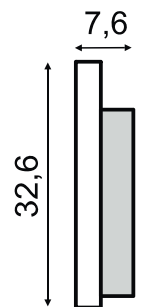
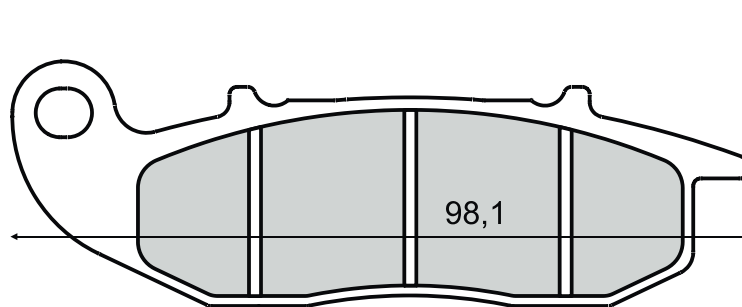



22 510 3353

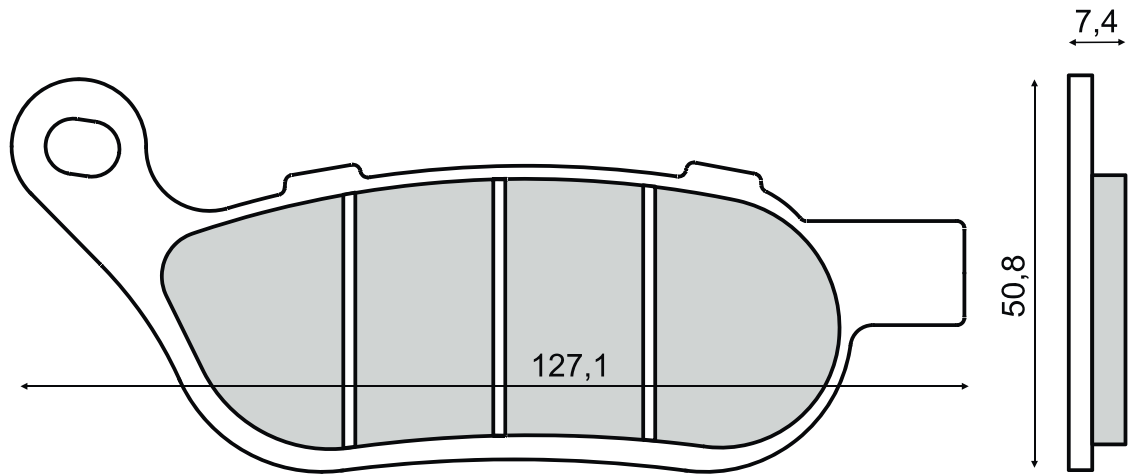

22 510 3363

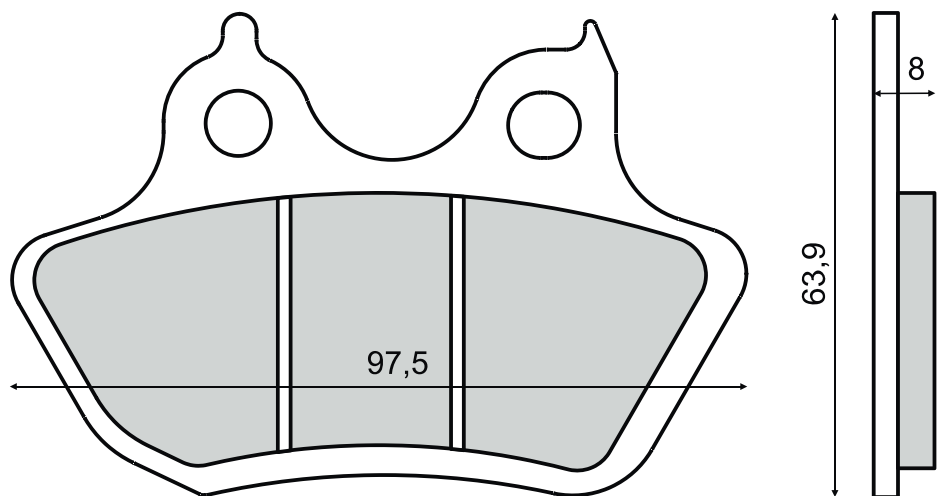
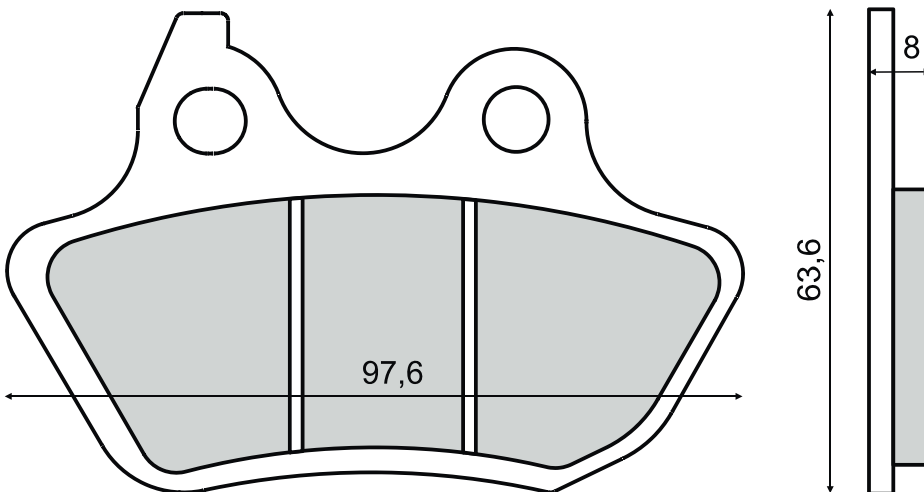



PASTIGLIE FRENO IN ORDINE DI CODICE

BRAKE PADS SEARCH BY CODE NUMBER

22 510 3373

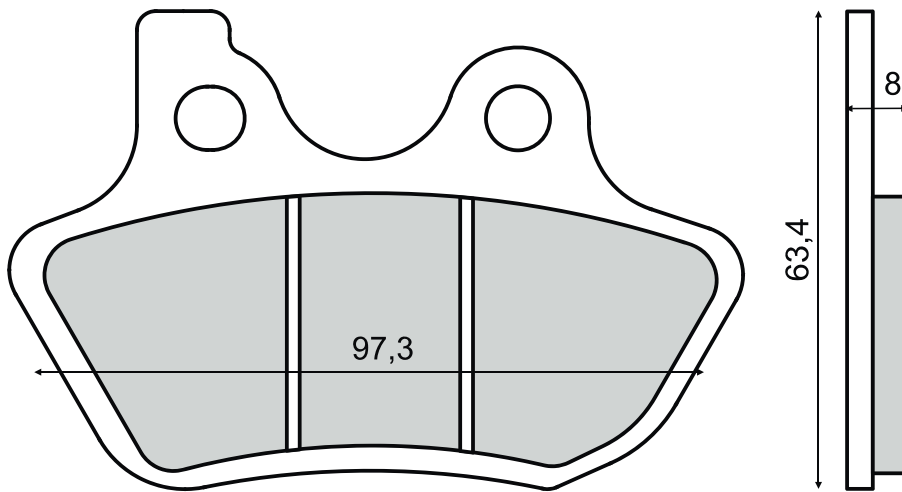
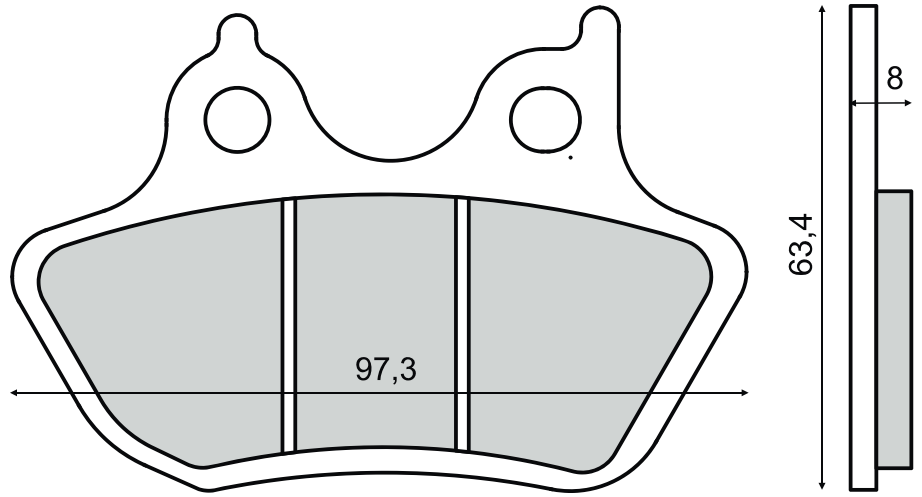

22 510 3383

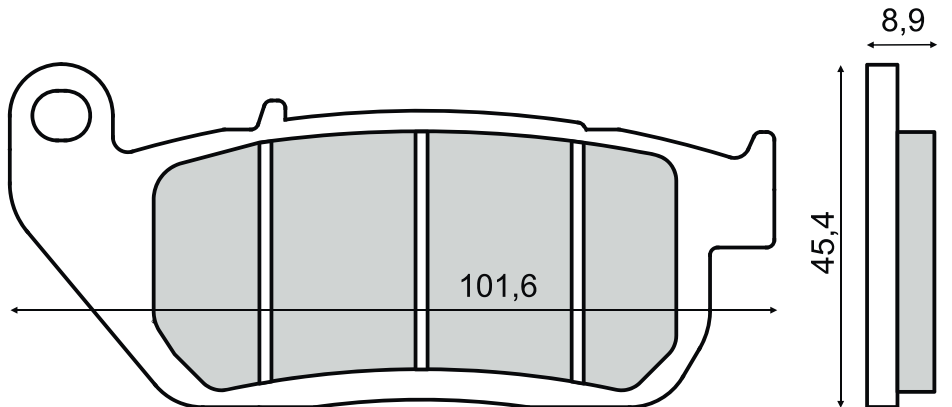

22 510 3393

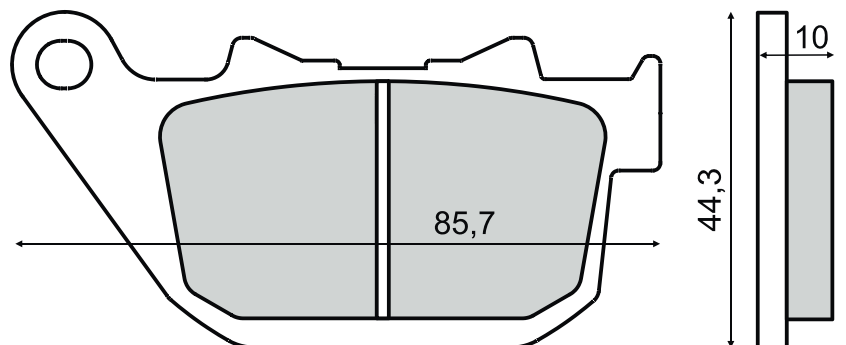



22 510 3403

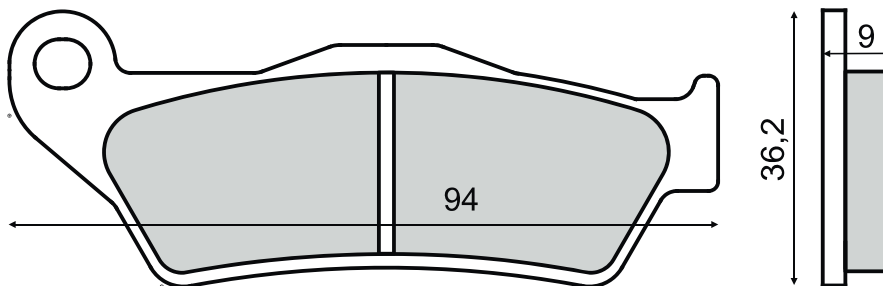

22 510 3413

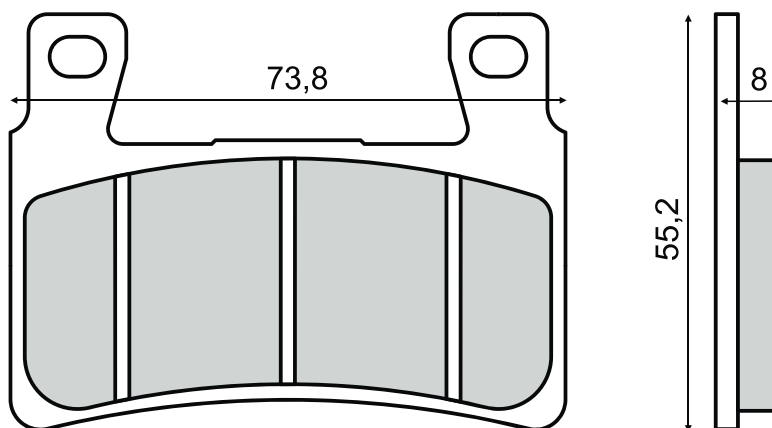

22 510 3423

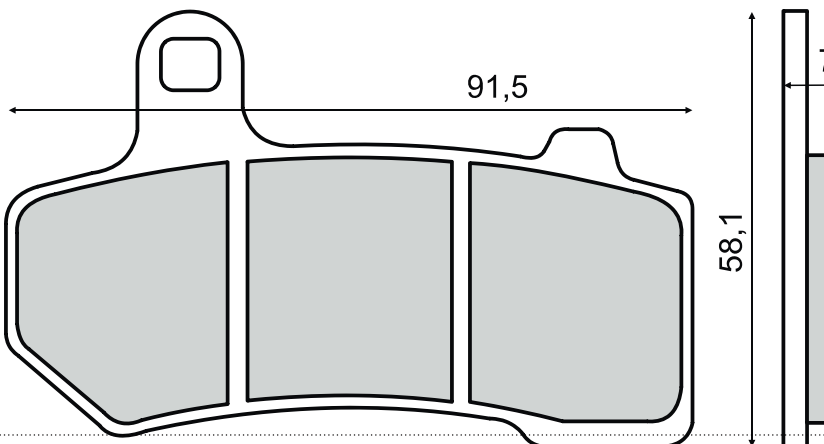

22 510 3433

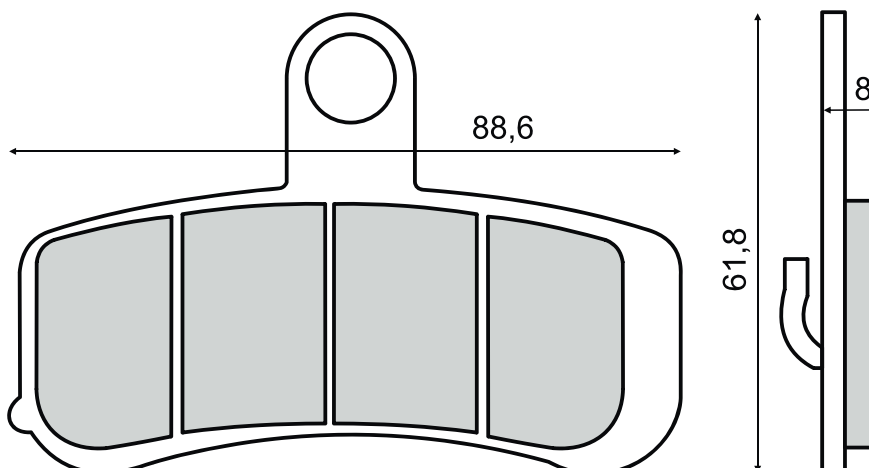



PASTIGLIE FRENO IN ORDINE DI CODICE

BRAKE PADS SEARCH BY CODE NUMBER

22 510 3440



NEW

22 510 1650

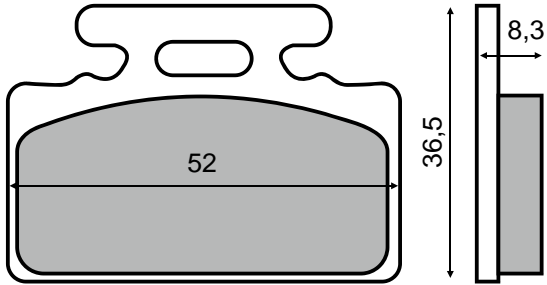

22 510 3450



NEW

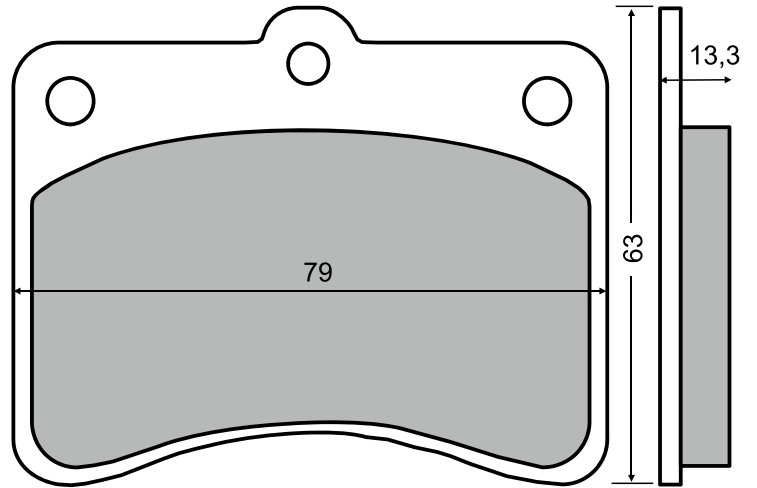

22 510 3460



NEW

22 510 3463



NEW

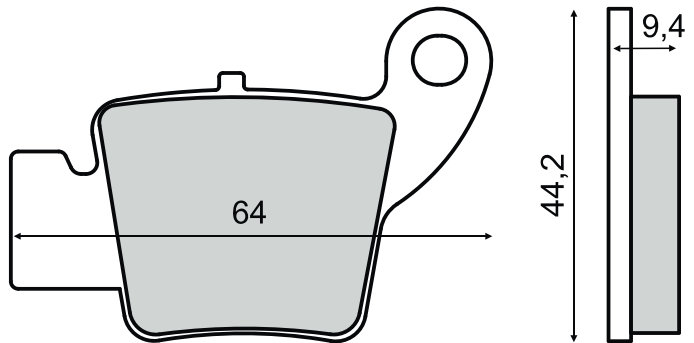

22 510 3470



NEW

22 510 3473



NEW

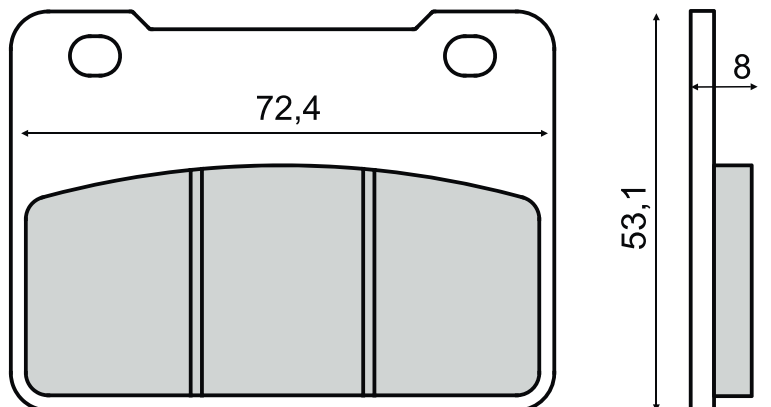



22 510 3483



NEW

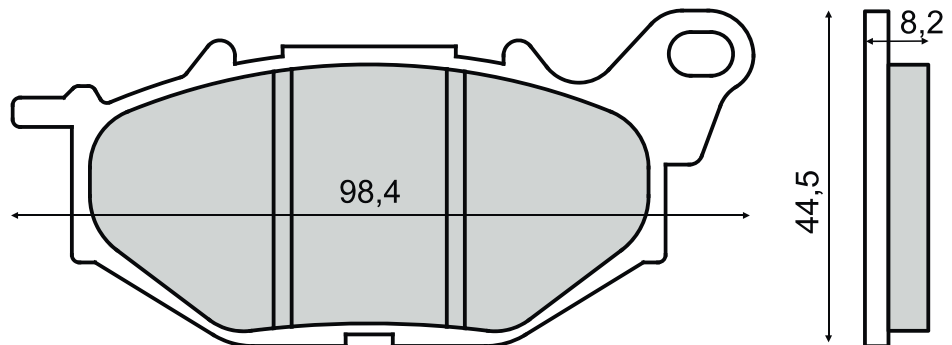
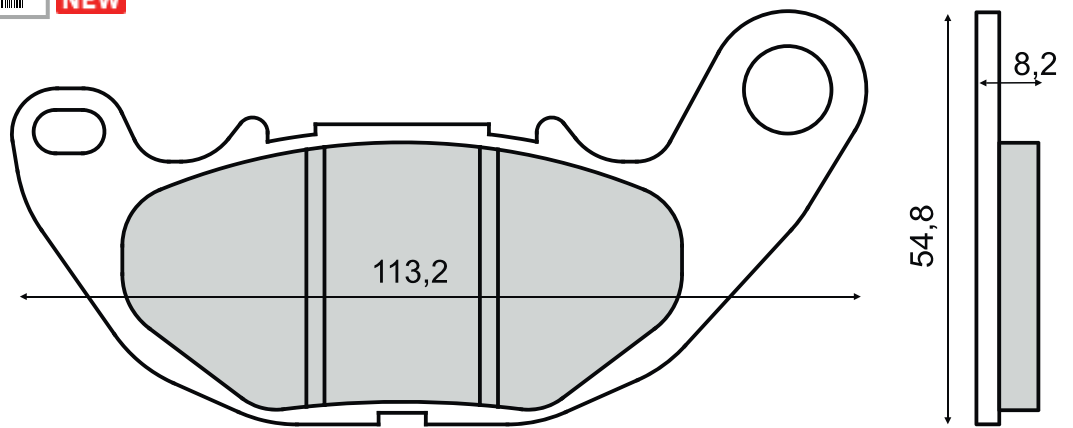

22 510 3493



NEW

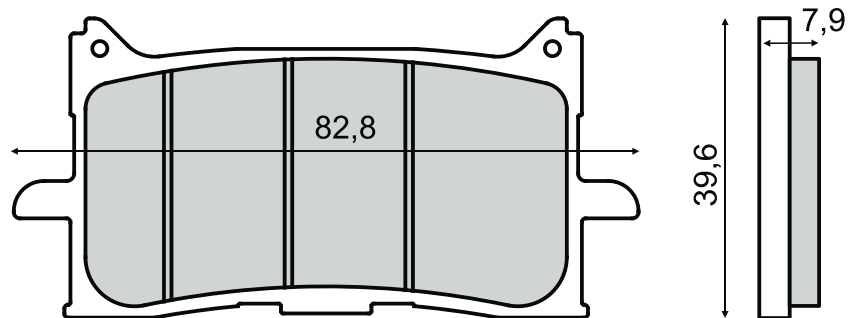



GANASCE FRENO - FIGURATO IN ORDINE DI CODICE
BRAKE SHOES ILLUSTRATED SECTION - SEARCH BY CODE NUMBER

22 512 0051



MBK • YAMAHA

Anteriore - *Front* • Posteriore - *Rear*

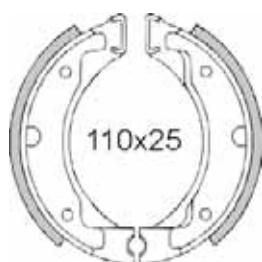

22 512 0061



**ADLY • CPI • FANTIC • ITALJET • LEM
 • KEE • KOTIR • MAICO • MALAGUTI •
 MBK • SULA • YAMAHA • WAY**

Anteriore - *Front* • Posteriore - *Rear*

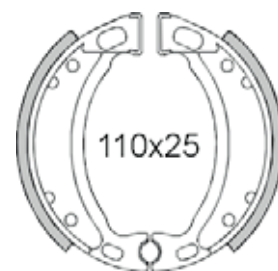

22 512 0070



HONDA • KYMCO

Anteriore - *Front* • Posteriore - *Rear*

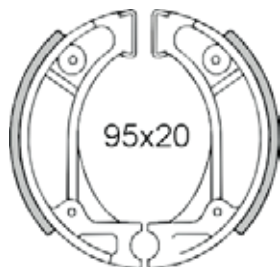

22 512 0080



CPI • HONDA

Anteriore - *Front* • Posteriore - *Rear*



22 512 0091



**APRILIA • ATALA • BENELLI • BETA
 • BS • DAELIM • VILLA • CAGIVA •
 KYMCO • HONDA • MALAGUTI • PEU-
 GEOT • SYM • YAMAHA**

Anteriore - *Front* • Posteriore - *Rear*



22 512 0131



NEW

**APRILIA • ATALA • CAGIVA • DERBI
 ITALJET • SUZUKI**

Anteriore - *Front*



22 512 0161



**PIAGGIO: Vespa Px • Pe • Vnx • VLx • Vsx
 • Vnx2 • VLx2 • Vsx2
 (R.O. 414450)**

Anteriore - *Front* • Posteriore - *Rear*

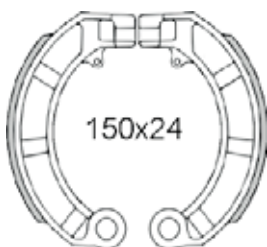

22 512 0171



**PIAGGIO: Vespa 50
 (R.O. 266506)**

Anteriore - *Front*



22 512 0181



**PIAGGIO: Vespa 50
 (R.O. 2100492)**
 Posteriore - *Rear*

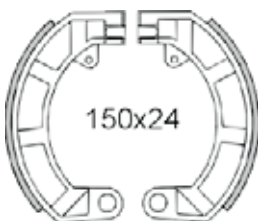

22 512 0191



**BENELLI • PIAGGIO • BETA • FANTIC
 • GARELLI • GILERA • MALAGUTI •
 MOTO GUZZI • RIZZATO • TOMOS**

Anteriore - *Front* • Posteriore - *Rear*



22 512 0200



**APRILIA • BETA • FANTIC • GARELLI •
 GILERA • ITALJET • PIAGGIO • RIZZATO**
 Posteriore - *Rear*



22 512 0220



22 512 0221



**PIAGGIO: Ape
 (R.O. 154998)**
 Posteriore - *Rear*

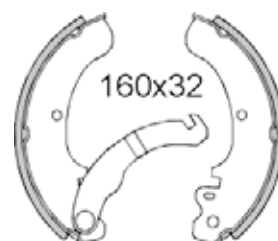



22 512 0230 

GILERA • ITALJET
PIAGGIO Ciclomotori/Mopeds
 (R.O. 4144974)
 Posteriore - Rear



22 512 0251 

PIAGGIO: Ape
 Kit 3 Ganasce/Kit 3 pcs.
 (R.O. 498401)
 Anteriore - Front • Posteriore - Rear



22 512 0261 

PIAGGIO: Ape
 Kit 3 Ganasce/Kit 3 pcs.
 (R.O. 4154991)
 Posteriore - Rear



22 512 0301 

GILERA • PIAGGIO
 (R.O. 2691825)
 Posteriore/Rear



22 512 0351 

APRILIA • DERBI • GILERA • ITALJET • PIAGGIO
 (R.O. 82907R)
 Posteriore - Rear



22 512 0360 

GILERA • PIAGGIO
 (R.O. 2727115)
 Posteriore - Rear

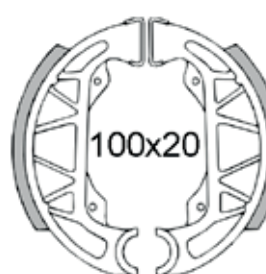

22 512 0401  **NEW**

HONDA • ITALJET • KYMCO • MALAGUTI • PEUGEOT • PIAGGIO
 Posteriore - Rear



22 512 0410 

HONDA
 Posteriore - Rear

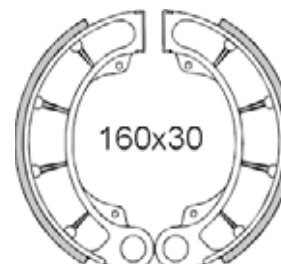

22 512 0421 

APRILIA • GILERA • DERBI • PIAGGIO
 (R.O. 56294R)
 Posteriore - Rear



22 512 0451 

APRILIA • KEEWAY • MBK • YAMAHA
 Posteriore - Rear

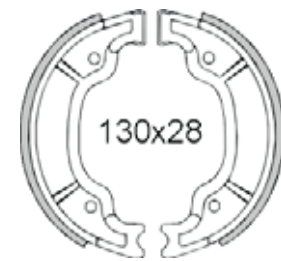

22 512 0460 

YAMAHA
 Posteriore - Rear

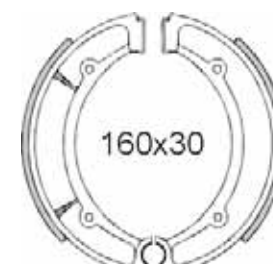

22 512 0471 

HONDA
 Posteriore - Rear

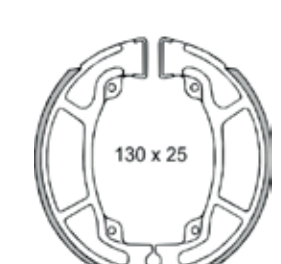



GANASCE FRENO - FIGURATO IN ORDINE DI CODICE
BRAKE SHOES ILLUSTRATED SECTION - SEARCH BY CODE NUMBER

22 512 0480 

YAMAHA
Posteriore - Rear



22 512 0491 

PIAGGIO: Vespa 50
(R.O. 090582)
Posteriore - Rear



22 512 0501  **NEW**

PIAGGIO: Cosa1-2 - 125-150-200
(R.O. 414437)
Posteriore - Rear



22 512 0511  **NEW**

PIAGGIO: Cosa1-2 - 125-150-200
(R.O. 414429)
Anteriore - Front



22 512 0520 

PIAGGIO: Vespa 150 Sprint Veloce •
Vespa 160 Gs • Vespa 180 Ss • Vespa
200 Rally
(R.O. 026832)
Anteriore - Front



22 512 0530 

22 512 0531 

PIAGGIO 125-150: Vespa Super
(R.O. 081229)
Posteriore - Rear



22 512 0540 

PIAGGIO 150: Vespa Super
(R.O. 110412)
Posteriore - Rear



22 512 0551 

PIAGGIO 125-150: Vespa 51-62
(R.O. 078170)
Posteriore - Rear



22 512 0560 

APRILIA • DERBI • MALAGUTI • PIAGGIO
(R.O. 56293R)
Posteriore - Rear



22 512 0570 

PIAGGIO: Vespa Px • Pe • Vnx • VLx • Vsx •
Vnx2 • VLx2 • Vsx2
(R.O. 414450)
Anteriore - Front • Posteriore - Rear

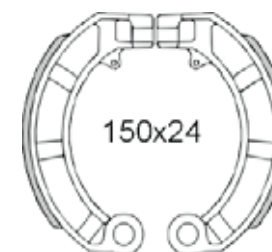

22 512 0601 

INNOCENTI: Lambretta LI 125-150-175 •
Lambretta TV II 175
Anteriore - Front • Posteriore - Rear



22 512 0611 

KYMCO: 50-125-150
(R.O. 4312AKUDU920 • 00158047)
MALAGUTI: Ciak 125-150
(R.O. 11954700)
Posteriore - Rear



PASTIGLIE FRENO RMS - SINTER (RICERCA PER MARCA)

RMS - SINTER BRAKE PADS (SEARCH BY BRAND)



CC	MODELLO MODEL	ANNO YEAR	RMS YOUR BEST PARTNER				SINTER			
			ANTERIORE FRONT		POSTERIORE REAR		ANTERIORE FRONT	POSTERIORE REAR		
			PASTIGLIA ORGANICA ORGANIC				PASTIGLIA SINTERIZZATA SINTERED			
			OMOLOGATA HOMOLOGATED	NON OMOLOGATA NOT HOMOLOGATED	GANASCE BRAKE SHOES	OMOLOGATA HOMOLOGATED	NON OMOLOGATA NOT HOMOLOGATED	GANASCE BRAKE SHOES	22 510	22 510
ACCOSSATO										
50	50 Enduro Codice	89>					0070			
50	Ce 50	87>	0010				0070 0013			
80	Ce 80	87>	0010				0010 0013			
80	Kr 80	87>	0010				0070 0013			
ADLY										
25	Silver Fox 25	00>05	0180				0061			
50	Cat 50	01>	0180							
50	Cosy 50	01>	0180							
50	Fox 50	00>	0180				0061			
50	Fox Plus 50	01>	0180							
50	Jet 50	96>	0180				0061			
50	Panther 50	01>	2800							
50	Pista - Twin Light 50	96>	0180				0061			
50	Rt 50 Road Tracer	02>	0180							
50	Silver Fox 50	00>05	0180				0061			
50	Silver Fox 50	06>	2800				0061			
50	Super Sonic 50	00>	2800							
50	Super Sonic 50	06>	2800		2800					
50	Thunderbike 50	97>	2800							
70	Fox Plus 70	01>	0180							
70	Pista - Twin Light 70	96>	0180							
80	Cosy 80	01>	0180							
90	Rt 90 Road Tracer	02>	0180							
100	Cat 100	01>	0180							
100	Jet 100	96>	0180				0061			
100	Panther 100	01>	2800							
100	Rs 100 Super Sonic	01>	2800							
100	Rt 100 Road Tracer	02>	0180							
100	Silver Fox 100	00>05	0180							
100	Silver Fox 100	06>	2800				0061			
100	Thunderbike 100	01>	2800		2800					
125	Cat 125	01>	0180							
125	Super Sonic 125	01>	2800							
125	Thunderbike 125	01>	2800		2800					
ADLY ATV										
150	Atv 150	05>	0040				0040			
150	Interceptor 150	05>	0040				0040			
300	Atv 300	05>	0040				0040			
300	Cross X Over 300 - Cross X Road 300	07>	3070				3073			
300	Sport 300	07>	3070				3073			
320	S 320	07>	3070				3073			
320	U 320	07>	3070				3073			
AEON										
50	Aero 50	06>	0040							
50	Regal 50	06>	0040							
50	Torch 50	06>	0040							
90	Regal 90	06>	0040							
100	Pulsar 100	06>	0040							
100	Revo 2 100	04>				0040				
110	Aero 110	06>	0040							
110	Pulsar 110	06>	0040							



PASTIGLIE FRENO RMS - SINTER (RICERCA PER MARCA)

RMS - SINTER BRAKE PADS (SEARCH BY BRAND)

CC	MODELLO MODEL	ANNO YEAR								
			 ANTERIORE FRONT		 POSTERIORE REAR		 ANTERIORE FRONT	 POSTERIORE REAR		
			PASTIGLIA ORGANICA ORGANIC				PASTIGLIA SINTERIZZATA SINTERED			
			 OMOLOGATA HOMOLOGATED	 NON OMOLOGATA NOT HOMOLOGATED	 GANASCE BRAKE SHOES	 OMOLOGATA HOMOLOGATED	 NON OMOLOGATA NOT HOMOLOGATED	 GANASCE BRAKE SHOES		
			22 510	22 512	22 510	22 512	22 510	22 510		
125	Overland 125	02>			1070			1073		
125	Pulsar 125	06>	0040							
150	Pulsar 150	06>	0040							
180	Overland 180	02>			1070			1073		
180	Roadster 180	02>			1070			1073		
AJP										
125	Pr3 125 Enduro	08>	0360		0640			0363		
125	Pr3 125 Enduro	12>14	3460					3463		
125	Pr3 125 Enduro Pro	12>14	3460					3463		
125	Pr3 125 Supermotard	08>	0360		0640			0363		
125	Pr3 125 Supermotard	12>14	3460					3463		
125	Pr3 125 Trial	11>14	3460					3463		
125	Pr4 125	12>14	3460					3463		
125	Pr4 125 Enduro	04>07	0740		0640					
125	Pr4 125 Enduro	12>14	3460					3463		
125	Pr4 125 Supermotard	04>07	0740		0640					
125	Pr4 125 Supermotard	12>14	3460					3463		
200	Mx 200	09>	0360		0080			0363 0083		
200	Pr3 200 Enduro	08>	0360		0640			0363		
200	Pr3 200 Enduro	12>14	3460					3463		
200	Pr3 200 Enduro Pro	12>14	3460					3463		
200	Pr3 200 Mx Pro	12>14	3460					3463		
200	Pr3 200 Supermotard	08>11	0360		0640			0363		
200	Pr3 200 Supermotard	12>14	3460					3463		
200	Pr4 200 Enduro	04>07	0740		0640					
200	Pr4 200 Enduro	12>14	3460					3463		
200	Pr4 200 Enduro Pro	12>14	3460					3463		
200	Pr4 200 Extreme	12>14	3460					3463		
200	Pr4 200 Supermotard	04>07	0740		0640					
200	Pr4 200 Supermotard	12>14	3460					3463		
250	Pr5 250 Enduro	09	0920		2630			0923 2633		
250	Pr5 250 Enduro	10>11	3460					3463		
250	Pr5 250 Extreme	10>14	3460					3463		
250	Pr5 250 Supermotard	09	0920		2630			0923 2633		
250	Pr5 250 Supermotard	10>11	3460					3463		
ALFER										
80	Mc 80	88>	0010		0080			0013 0083		
80	Mc 80 Cross	89>	0010		0010			0013 0013		
125	Mc 125	87>	0010		0010			0013 0013		
125	Mc 125	88>	0530		0010			0533 0013		
125	Vre 125 4 Stroke	00>	0430		1330			1333		
250	Ar 250	92>			1200					
250	Ar 250	93>	0430		1200					
250	Gr 250 Enduro	85>87	0010		0010			0013 0013		
250	Gr 250 Enduro	88>	0530		0010			0533 0013		
250	Mc 250	85>86	0010					0013		
250	Mc 250	87>	0010		0010			0013 0013		
250	Mc 250	88>	0530		0010			0533 0013		
250	Vr 250	94>	0430		1200					
250	Vr 250 Enduro	95>	0430		1330			1333		
250	Vr 250 Motocross	95>	0430		1330			1333		
250	Vr 250 No Limits	95>	0430		1330			1333		

Con Piastra - With Plate

PASTIGLIE FRENO RMS - SINTER (RICERCA PER MARCA)

RMS - SINTER BRAKE PADS (SEARCH BY BRAND)

















CC	MODELLO MODEL	ANNO YEAR	RMS YOUR BEST PARTNER				SINTER			
			 ANTERIORE FRONT		 POSTERIORE REAR		 ANTERIORE FRONT	 POSTERIORE REAR		
			PASTIGLIA ORGANICA ORGANIC				PASTIGLIA SINTERIZZATA SINTERED			
			 OMOLOGATA HOMOLOGATED	 NON OMOLOGATA NOT HOMOLOGATED	 GANASCE BRAKE SHOES	 OMOLOGATA HOMOLOGATED	 NON OMOLOGATA NOT HOMOLOGATED	 GANASCE BRAKE SHOES		
			22 510		22 512		22 510		22 512	
250	Vr 250 Supermotard	99>	0430			1330		1333		
300	Gr 300 Enduro	85>87	0010			0010	0013			
300	Gr 300 Enduro	89>				0530		0533		
300	Tx 300	90>	0080			0010	0083	0013		
APRILIA										
50	Af1 50 Ae All Models	87>	0070							
50	Af1 50 Europa	91>	0070							
50	Af1 50 Futura	90>	0070			0020				
50	Amico 50	90>91		0091		0091				
50	Amico 50 All Models	92>	0190			0091	0193			
50	Area 51 50	98>	0190		0190		0193	0193		
50	Classic 50	92>	0360				0363			
50	Et 50 Ae	87>	0070							
50	Etx 50	86>	0070			0020				
50	Gulliver 50	95>	0190			0091	0193			
50	Habana 50 All Models	98>	0190				0193			
50	Mojto 50	03>05	0190				0193			
50	Mojto Custom	99>03	0010			0131	0013			
50	Mojto Retro	99>03	0010			0131	0013			
50	Mx 50	00>	0360				0363			
50	Pegaso	92>94				0020				
50	Rally 50	95>	0190			0091	0193			
50	Rally 50 Liquid Cooled	96>	0190		0190		0193	0193		
50	Red Rose 50	88>91	0070							
50	Red Rose 50	92>	0070							
50	Rs 50	06>	0490		0080		0493	0083		
50	Rs 50	93>95	0010		0010		0013			
50	Rs 50	96>99	0010			0020	0013			
50	Rs 50 Replica	00>02	0360		0080		0363	0083		
50	Rs 50 Replica	03>05	0360				0363			
50	Rs4 50 (4T)	11>12	3160				3163			
50	Rx 50	08>	0740		0080			0083		
50	Rx 50	90>91	0070			0020				
50	Rx 50	92>95	0360				0363			
50	Rx 50	96>98	0010				0013			
50	Rx 50 Racing	04>07	0360				0363			
50	Scarabeo 50	94>95				0091				
50	Scarabeo 50	96>	0190			0091	0193			
50	Scarabeo 50 All Models	98>05	0190		0190		0193	0193		
50	Scarabeo 50 Ditech	01>04	0190		0310		0193	0313		
50	Sonic 50 Gp	97>	0190			0091	0193			
50	Sonic 50 Spice	97>	0190			0091	0193			
50	Sport City 50 One 2T	08>10	2620			0351	2623			
50	Sport City 50 One 4T	08>10	2620			0351	2623			
50	Sr 50 2000	00>	0190		0310		0193	0313		
50	Sr 50 All Models	93>96	3210			0091				
50	Sr 50 ie Ditech	02>	0190		0310		0193	0313		
50	Sr 50 R Factory (Pinza Grimeca)	04>05	0010		0310		0013	0313		
50	Sr 50 Stealth - Racing	97>	0190		0190		0193	0193		
50	Sr 50 Www - Netscaper	97>	0190		0190		0193	0193		
50	Sr H2o Ditech e Carburatore	00>04	0010			0131	0013			
50	Tuareg 50	86>	0070							



PASTIGLIE FRENO RMS - SINTER (RICERCA PER MARCA)

RMS - SINTER BRAKE PADS (SEARCH BY BRAND)

CC	MODELLO MODEL	ANNO YEAR	 YOUR BEST PARTNER							
			 ANTERIORE FRONT		 POSTERIORE REAR		 ANTERIORE FRONT	 POSTERIORE REAR		
			PASTIGLIA ORGANICA ORGANIC				PASTIGLIA SINTERIZZATA SINTERED			
			 OMOLOGATA HOMOLOGATED	 NON OMOLOGATA NOT HOMOLOGATED	 GANASCE BRAKE SHOES	 OMOLOGATA HOMOLOGATED	 NON OMOLOGATA NOT HOMOLOGATED	 GANASCE BRAKE SHOES		
			22 510		22 512		22 510		22 512	
50	Tuareg 50	87>	0070							
50	Tuareg 50 Hpc System	87>	0060		0010		0063 0013			
50	Tuareg 50 Rally	90>	0070		0020					
70	Scarabeo 70	94>	0190				0091 0193			
80	Classic 80	93>	0070							
100	Scarabeo 100 (Motore Minarelli)	00>	0460				0451			
100	Scarabeo 100 (Motore Yamaha)	00>	0460							
100	Scarabeo 100 4T	01>04	0460		0310		0313			
125	Af1 125	87>			0010		0013			
125	Af1 125 Europa	90>91	0530		0010		0533 0013			
125	Af1 125 Futura	90>91	0530		0010		0533 0013			
125	Af1 125 Replica	89>91	0530		0010		0533 0013			
125	Af1 125 Sintesi	89>91	0530		0010		0533 0013			
125	Arecife 125 (Spagna)	03>	2670 0440		0310		2673 0313			
125	Asr 125	86>			0010		0013			
125	Atlantic 125 (Pinza Grimeca)	03>05	2670 0440		0310		2673 0313			
125	Classic 125	96>	0740		0010		0013			
125	Etx 125	85>86	0010							
125	Etx 125	86>97	0060				0063			
125	Etx 125	98>	0360				0363			
125	Habana 125 All Models	99>	0460				0421			
125	Leonardo 125	95>96	0010		0190		0013 0193			
125	Leonardo 125	97>98	2020		0190		0193			
125	Leonardo 125	99>	0460		0460					
125	Mojto 125 All Models	99>04	0460				0421			
125	Mx 125	04>	0430							
125	Mx 125 Supermoto	07>	0430							
125	Pegaso 125	89>	0740							
125	Pegaso 125 Kat	94>	0360				0363			
125	Red Rose 125	89>89	0060				0063			
125	Red Rose 125	90>	0740							
125	Rs 125	06>	2830		0310		2833 0313			
125	Rs 125 All Models	93>05	0530		0010		0533 0013			
125	Rs 125 Extrema/Replica	93>98	0530		0010		0533 0013			
125	Rs4 125 (4T)	11>12	3160				3163			
125	Rx 125	86>	0060				0063			
125	Rx 125	90>	0740							
125	Rx 125	91>	0740							
125	Rx 125	92>94	0360				0363			
125	Rx 125	95>	0430							
125	Rx 125 Enduro	08>	0430							
125	Rx 125 Supermotard	08>	0430							
125	Scarabeo 125	04>06	2670 0440		0310		2673 0313			
125	Scarabeo 125	98>	0060		0310		0063 0313			
125	Scarabeo 125 (Motore Piaggio)	03>	0060		0310		0063 0313			
125	Sport City 125 (Pinza Grimeca)	04>05	0060		0310		0063 0313			
125	Sport City 125 (Pinza Heng Tong)	04>06	0760		0010		0013			
125	Sport City 125 Eu3 (Pinza Grimeca)	06>	0060		0310		0063 0313			
125	Sport City 125 Eu3 (Pinza Heng Tong)	06>08	0760							
125	Sport City 125 One 4T Eu3	08>10	2620				0421 2623			
125	Sport City Street	12>08	0760							
125	Sport Pro 125	93>	0530		0010		0533 0013			

Con Piastra - With Plate

PASTIGLIE FRENO RMS - SINTER (RICERCA PER MARCA)

RMS - SINTER BRAKE PADS (SEARCH BY BRAND)



CC	MODELLO MODEL	ANNO YEAR	RMS YOUR BEST PARTNER				SINTER			
			 ANTERIORE FRONT		 POSTERIORE REAR		 ANTERIORE FRONT	 POSTERIORE REAR		
			PASTIGLIA ORGANICA ORGANIC				PASTIGLIA SINTERIZZATA SINTERED			
			 OMOLOGATA HOMOLOGATED	 NON OMOLOGATA NOT HOMOLOGATED	 GANASCE BRAKE SHOES	 OMOLOGATA HOMOLOGATED	 NON OMOLOGATA NOT HOMOLOGATED	 GANASCE BRAKE SHOES		
			22 510		22 512		22 510		22 512	
125	Sr 125	99>	0460		0421					
125	Sr 125 Replica	00>	0460							
125	Trend Go West 125	87>	0060				0063			
125	Tuareg 125	86>	0060		0010		0063	0013		
125	Tuareg 125	87>	0060		0010		0063	0013		
125	Tuareg 125 Rally	86>	0060				0063			
125	Tuareg 125 Rally	89>90	0740							
125	Tuareg 125 Rally (Mozzi Rimoldi)	86>	0060				0063			
125	Tuareg 125 Wind	90>			0010			0013		
125	Tx 125 M	86>	0080				0083			
150	Leonardo 150	97>98	2020		0190			0193		
150	Leonardo 150	99>	0460		0460					
150	Mojto 150 All Models	03>04	0460							
150	Scarabeo 150	98>	0060		0310		0063	0313		
150	Sr 150	99>	0460				0421			
200	Arecife 200 (Spagna)	03>	2670	0440	0310		2673	0313		
200	Atlantic 200 (Pinza Grimeca)	03>05	2670	0440	0310		2673	0313		
200	Climber 200	89>90			0020					
200	Climber 200	93>	0010		0010		0013			
200	Scarabeo 200	01>03	0060		0310		0063	0313		
200	Scarabeo 200 (Motore Piaggio)	03>	0060		0310		0063	0313		
200	Sport City 200 Eu3 (Pinza Heng Tong)	06>08	0760							
200	Sport City 200 (Pinza Grimeca)	04>05	0060		0310		0063	0313		
200	Sport City 200 (Pinza Heng Tong)	04>05	0760		0010			0013		
200	Sport City 200 Eu3 (Pinza Grimeca)	06>	0060		0310		0063	0313		
240	Climber 240	89>90	0070							
240	Trx 240 M	89>	0070		0070					
250	Af1 250 Replica	90>			3150			3153		
250	Af1 250 Replica	90>	0530				0533			
250	Atlantic 250 (Pinza Grimeca)	03>05	2670	0440	0310		2673	0313		
250	Atlantic 250 (Pinza Heng Tong)	03>05	2670	0440	0010			0013		
250	Atlantic 250 ie	07>	2670	0440	0310		2673	0313		
250	Leonardo 250	99>	0060		0310		0063	0313		
250	Mx 250	83>	0010				0013			
250	Rs 250	95>96	0520		0010		0523	0013		
250	Rs 250	97>	0520		0190		0523	0193		
250	Rs 250	98>	1100		0190		1103	0193		
250	Rs 250 Pista	04>	1100		0190		1103	0193		
250	Rx 250	83>	0010				0013			
250	Rx 250	86>	0010				0013			
250	Scarabeo 250	04>06	2670	0440	0310		2673	0313		
250	Sport City 250 Cube	08>10	0060		0310		0063	0313		
250	Sport City 250 Eu3 (Pinza Grimeca)	06>	0060		0310		0063	0313		
250	Tuareg 250 Rally	86>	0060				0063			
250	Tuareg 250 Rally (Mozzi Rimoldi)	86>	0060				0063			
275	Climber 275	89>92	0070			0020				
280	Climber 280	93>	0080		0080		0083	0083		
280	Tx 311 M	87>	0080				0083			
280	Tx 312 M	88>	0080		0080		0083	0083		
280	Trx 312 M	88>	0080		0080		0083	0083		
300	Leonardo 300	02>	0060		0310		0063	0313		
300	Scarabeo 300 Special	09>	2670	0440	0310		2673	0313		



PASTIGLIE FRENO RMS - SINTER (RICERCA PER MARCA)

RMS - SINTER BRAKE PADS (SEARCH BY BRAND)

CC	MODELLO MODEL	ANNO YEAR	RMS YOUR BEST PARTNER				SINTER			
			ANTERIORE FRONT		POSTERIORE REAR		ANTERIORE FRONT	POSTERIORE REAR		
			PASTIGLIA ORGANICA ORGANIC				PASTIGLIA SINTERIZZATA SINTERED			
			22 510		22 512		22 510	22512	22 510	22 510
300	Tx 300	86>	0080				0083			
300	Tx 300 M	86>	0080				0083			
350	Etx 350	86>	0060		0010		0063	0013		
350	Etx 350 Ae	87>	0060		0010		0063	0013		
350	Tuareg 350	87>	0060		0010		0063	0013		
350	Tuareg 350 Wind	87>88	0060		0010		0063	0013		
350	Tuareg 350 Wind	89>			1200					
350	Tuareg 350 Wind	90>			1200					
400	Scarabeo 400 ie	07>	0060		0310		0063	0313		
400	Scarabeo 400 Light	06>08	0060		0490		0063	0493		
450	Mxv 450 4.5	09>	0920		0660		0923	0663		
450	Rxv 450 4.5	06>	0920		1450		0923	1453		
450	Sxv 450	05>			1450			1453		
450	Sxv Replica 450 Van De Bosch	05>			1450			1453		
500	Arecife 500 (Pinza Dx) (Spagna)	02>04	0680		0310					
500	Arecife 500 (Pinza Sx) (Spagna)	02>04	0060		0310		0063	0313		
500	Atlantic 500 (Pinza Dx)	02>04	0680		0310					
500	Atlantic 500 (Pinza Sx)	02>04	0060		0310		0063	0313		
500	Atlantic 500 Sprint	05>	2670	0440	0310		2673	0313		
500	Scarabeo 500	02>06	0060		0310		0063	0313		
500	Scarabeo 500 Class	10>	0060		0310		0063	0313		
500	Scarabeo 500 ie	07>	0060		0310		0063	0313		
500	Scarabeo 500 Light	06>08	0060		0310		0063	0313		
550	Sxv 550	06>			1450			1453		
550	Sxv Replica 550 Van De Bosch	05>			1450			1453		
600	Etx 600	86>	0060		0010		0063	0013		
600	Pegaso 600	90>	1010				1013			
600	Tuareg 600 Wind	89>	1200		1200					
650	Moto' 650 6.5	95>96	1010				1013			
650	Moto' 650 6.5	97>	1010				1013			
650	Pegaso 650	96>	0430							
650	Pegaso 650	97>	1010				1013			
650	Pegaso 650 Factory	07>			1330			1333		
650	Pegaso 650 ie	01>	1010		1330		1013	1333		
650	Pegaso 650 Strada	05>	1100		1330		1103	1333		
650	Pegaso 650 Tuscany Tibet Raid	04>	1010		1330		1013	1333		
650	Starck 650	96>	1010				1013			
750	SI 750 Shiver	07>	2830		1330		2833	1333		
750	SI 750 Shiver Gt	09>	2830		1330		2833	1333		
750	Smv 750 Dorsoduro	08>	1100		1330		1103	1333		
750	Smv 750 Dorsoduro	09>	2830		1330		2833	1333		
850	Na 850 Mana	07>	2830		1330		2833	1333		
850	Na 850 Mana	08>	2830		0060		2833	0063		
850	Na 850 Mana Gt	09>	2830		0060		2833	0063		
1000	1000 Blue Marlin	02>	1100		0490		1103	0493		
1000	Etv 1000 Caponord	01>	1010		0490		1013	0493		
1000	Etv 1000 Caponord Rally Raid	04>	1010		0490		1013	0493		
1000	Rst 1000 Futura	01>	1100		0430		1103			
1000	Rsv 1000 Factory	04>	2860		0490		2863	0493		
1000	Rsv 1000 Mille	97>01	1100		0490		1103	0493		
1000	Rsv 1000 Mille Nera	04>	2860		0490		2863	0493		
1000	Rsv 1000 Mille R	98>00	1100		0490		1103	0493		

Con Piastra - With Plate

PASTIGLIE FRENO RMS - SINTER (RICERCA PER MARCA)

RMS - SINTER BRAKE PADS (SEARCH BY BRAND)



CC	MODELLO MODEL	ANNO YEAR	RMS YOUR BEST PARTNER				SINTER			
			 ANTERIORE FRONT		 POSTERIORE REAR		 ANTERIORE FRONT	 POSTERIORE REAR		
			PASTIGLIA ORGANICA ORGANIC				PASTIGLIA SINTERIZZATA SINTERED			
			 OMOLOGATA HOMOLOGATED	 NON OMOLOGATA NOT HOMOLOGATED	 GANASCE BRAKE SHOES	 OMOLOGATA HOMOLOGATED	 NON OMOLOGATA NOT HOMOLOGATED	 GANASCE BRAKE SHOES		
			22 510		22 512	22 510		22512	22 510	22 510
1000	Rsv 1000 Mille R	02>05	2860			0490		2863	0493	
1000	Rsv 1000 SI - R Falco	00>	1100			0490		1103	0493	
1000	Rsv 1000 Sp	00>	1100			0490		1103	0493	
1000	Rsv 1000 Tuono	02>	1100			0490		1103	0493	
1000	Rsv 1000 Tuono Figther	03>05	1100			0490		1103	0493	
1000	Rsv 1000 Tuono R	02>	1100			0490		1103	0493	
1000	Rsv 1000 Tuono R	03>	2860			0490		2863	0493	
1000	Rsv 1000 Tuono R Factory	06>	2860			0490		2863	0493	
1000	Rsv 1000 Tuono V4r	11>	1100			0490		1103	0493	
1000	Rsv4 1000	09>				0490		2923	0493	
1000	Rsv4-R 1000	10>				0490		2923	0493	
1200	Caponord 1200	13>						3193		
1200	Dorsoduro 1200	11>	1100			1330		1103	1333	
ARTIC CAT ATV										
400	Dvx 400	04>	1440							
ATALA										
50	Byte 50	96>	0190					0193		
50	Carosello 50	97>	0190				0091	0193		
50	Hacker 50	96>	0190					0193		
50	Hacker 50	>95	0190					0193		
50	Scheggia 50	98>	0190				0131	0193		
125	Hacker 125	98>	0190					0193		
ATK										
560	Atk 560	87>88				0080			0083	
560	Atk 560	89>91				0070				
604	Atk 604 Quadracer	90>				0070				
ATK (USA)										
250	Atk 250 Cc/Mx	91>92	0530			0010		0533	0013	
350	Atk 350 Es/Cc/Mx/Std	91>92	0530			0010		0533	0013	
350	Atk 350 Gs	93>	0010			0010			0013	
406	Atk 406 Cc/Mx	91>92	0530			0010		0533	0013	
560	Atk 560	84>85	0010					0013		
560	Atk 560	86>	0010					0013		
560	Atk 560	87>88	0010					0013		
560	Atk 560	89>91	0530					0533		
604	Atk 604	91>	0530					0533		
604	Atk 604 Es/Cc/Mx/Std	91>92	0530			0010		0533	0013	
604	Atk 604 Quadracer	90>	0530					0533		
640	Atk 640	93>	0010			0010		0013	0013	
BENELLI										
50	491 50 Gt	97>	0190				0091	0193		
50	491 50 Sport - Racing	97>	0190			0300		0193	0303	
50	Bobo 50	78>			0191		0191			
50	Chrono 50	92>93	0070							
50	Chrono 50	94>	0190					0193		
50	Devil 50	92>	0530			0030		0533		
50	Export 3 V 50	79>			0191		0191			
50	G 2 50	79>			0191		0191			
50	K2 50 All Models	98>	0190			0190		0193	0193	
50	Master 4 50	95>	0030							
50	Motorella 50	79>			0191		0191			
50	Naked 50	98>	0190					0193		

Con Plastra - With Plate



PASTIGLIE FRENO RMS - SINTER (RICERCA PER MARCA)

RMS - SINTER BRAKE PADS (SEARCH BY BRAND)

CC	MODELLO MODEL	ANNO YEAR	RMS YOUR BEST PARTNER				SINTER			
			ANTERIORE FRONT		POSTERIORE REAR		ANTERIORE FRONT	POSTERIORE REAR		
			PASTIGLIA ORGANICA ORGANIC				PASTIGLIA SINTERIZZATA SINTERED			
			OMOLOGATA HOMOLOGATED	NON OMOLOGATA NOT HOMOLOGATED	GANASCE BRAKE SHOES	OMOLOGATA HOMOLOGATED	NON OMOLOGATA NOT HOMOLOGATED	GANASCE BRAKE SHOES	OMOLOGATA HOMOLOGATED	NON OMOLOGATA NOT HOMOLOGATED
			22 510	22 512	22 510	22512	22 510	22 510		
50	Pepe 50	99>04	0190			0091	0193			
50	Spring 50	92>	0530		0030		0533			
80	Devil 80	95>	0530		0030		0533			
100	100 Naked	02>	0190				0193			
100	K2 100 Biposto	99>	0190				0193			
100	Lx 100 Pepe	02>	0190				0193			
125	125 2 C	76>78	0010				0013			
125	125 2T - 2 Cse	76>78	0010				0013			
125	125 Jarno	89>	0530				0533			
125	666 125	98>		0190				0193		
125	Adiva 125	00>02	0190		0450		0193	0453		
125	Caffenero 125 (Pinza Dx)	08>	1420		1420		1423			
125	Caffenero 125 (Pinza Sx)	08>	1070		1420		1073	1423		
125	Macis 125	10>	1420		1420		1423	1423		
125	Velvet 125	99>04	0190		0190		0193	0193		
125	Velvet 125 Touring	02>03	0190		0190		0193	0193		
150	Adiva 150	00>02	0190		0450		0193	0453		
150	Macis 150	10>	1420		1420		1423	1423		
150	Velvet 150	99>04	0190		0190		0193	0193		
150	Velvet 150 Touring	02>03	0190		0190		0193	0193		
250	250 4	76>	0010				0013			
250	250 C	76>78	0010				0013			
250	250 Ts	76>78	0010				0013			
250	Caffe' Nero 250 (Pinza Dx)	08>	0580		0190		0583	0193		
250	Caffe' Nero 250 (Pinza Sx)	08>	0350		0190		0353	0193		
250	Velvet 250	99>	0360		0310		0363	0313		
250	Velvet 250 Touring	01>	0360		0310		0363	0313		
350	350	83>	0010		0010		0013			
350	350 Sport	78>			3150			3153		
350	350 Sport li	78>			3150			3153		
350	350 T	78>			3150			3153		
350	350 4 Cil.	78>	0010				0013			
350	350 Sport	78>	0010				0013			
350	350 Sport li	78>	0010				0013			
350	350 T	78>	0010				0013			
400	Velvet 400 Dusk	03>	0360				0363			
449	Bx 449 Cross	07>	0430		1330			1333		
449	Bx 449 Supermotard	08>	2860		1330		2863	1333		
500	500	78>	0010		3150		0013	3153		
500	500 Ls	78>			3150			3153		
500	500 Ls	78>	0010				0013			
500	500 Quattro	76>	0010				0013			
505	Bx 505 Enduro	08>	0430		1330			1333		
650	650	82>	0010		3150		0013	3153		
650	650 Sport	78>			3150			3153		
650	650 T	78>			3150			3153		
650	650 Sport	78>	0010				0013			
650	650 T	78>	0010				0013			
666	666 125	98>	1100				1103			
750	Sei 750	76>	3150				3153			
756	Cue 756	07>09	2860		0490		2863	0493		
756	Cue 756	10>	1100		0490		1103	0493		

Con Piastra - With Plate

PASTIGLIE FRENO RMS - SINTER (RICERCA PER MARCA)

RMS - SINTER BRAKE PADS (SEARCH BY BRAND)















CC	MODELLO MODEL	ANNO YEAR	RMS YOUR BEST PARTNER				SINTER			
			 ANTERIORE FRONT		 POSTERIORE REAR		 ANTERIORE FRONT	 POSTERIORE REAR		
			PASTIGLIA ORGANICA ORGANIC				PASTIGLIA SINTERIZZATA SINTERED			
			 OMOLOGATA HOMOLOGATED	 NON OMOLOGATA NOT HOMOLOGATED	 GANASCE BRAKE SHOES	 OMOLOGATA HOMOLOGATED	 NON OMOLOGATA NOT HOMOLOGATED	 GANASCE BRAKE SHOES		
			22 510		22 512	22 510		22512	22 510	22 510
899	Tnt 899	07>	1100			0490		1103	0493	
899	Tnt 899 Century Racer	11>	2860			0490		2863	0493	
899	Trek 899	07>	1100			0490		1103	0493	
900	Sei 900	78>	3150					3153		
900	Tornado 3 900	00>02	1100			0010		1103	0013	
900	Tornado Tre 900	03>	2860			0490		2863	0493	
900	Tornado Tre 900 Rs	04>	2860			0490		2863	0493	
1100	Tnt 1100	04>	1100			0010		1103	0013	
1130	Tnt 1130	05>	1100			0490		1103	0493	
1130	Tnt 1130 Cafe Racer	05>	2860			0490		2863	0493	
1130	Tnt 1130 Century Racer	11>	2860			0490		2863	0493	
1130	Tnt 1130 Officine	07>	2860			0490		2863	0493	
1130	Tnt 1130 Sport	05>	2860			0490		2863	0493	
1130	Tnt 1130 Titanium	05>	2860			0490		2863	0493	
1130	Tnt 1130 Trek	06>	1100			0490		1103	0493	
1130	Tnt 1130 Trek Amazonas	07>	1100			0490		1103	0493	
1130	Tornado 3 1130	06>	2860			0490		2863	0493	
BETA										
50	Alp 50	91>	0030			0070				
50	Andy 50 Ruote Lega	78>			0191		0191			
50	Andy 50 Ruote Raggi	78>			0191		0191			
50	Ark 50 All Models	96>	0190			0190		0193	0193	
50	B12 50	73>			0191		0191			
50	Ch 50	96>	0190				0091	0193		
50	Chrono 50	92>94	0070				0091			
50	Chrono 50	94>	0070				0091			
50	Chrono 50 13	94>	0190				0091	0193		
50	Crono 50 502	97>	0190				0091	0193		
50	Eikon 50	99>03	0080			0080		0083	0083	
50	Four Twin 50	88>	0030							
50	Kr 50	87>	0070							
50	Kr 50 Adventure	87>	0070							
50	Mio 50	79>			0191		0191			
50	Mx 50 Enduro	92>	0080			0080		0083	0083	
50	Pro Race 50	98>	0740							
50	Pro Race 50	04>	0650			0650				
50	Pulman 50	70>			0201		0201			
50	Quadra 50	95>96	0190				0091	0193		
50	Quadra 50	97>	0010				0091	0013		
50	Rr 50 Enduro	05>	0360			3020		0363	3023	
50	Rr 50 Enduro Alu	04>	0360			0080		0363	0083	
50	Rr 50 Pro Race	98>	0740			0080			0083	
50	Rr 50 Supermotard	99>03	0740			0080			0083	
50	Rr 50 Supermotard	04>07	0080			0080		0083	0083	
50	Rr 50 Supermotard	08>	0360			3020		0363	3023	
50	Rr 50 Supermotard Alu	04>	0360			3020		0363	3023	
50	Supermotard 50	00>	0080			0080		0083	0083	
50	Supertrial 50	92>	0080					0083		
50	Techno 50	96>	0080			0080		0083	0083	
50	Tempo 50	92>96	0080				0091	0083		
50	Tempo 50	97>98	0010				0091	0013		
50	Tempo 50	99>	0190				0091	0193		



PASTIGLIE FRENO RMS - SINTER (RICERCA PER MARCA)

RMS - SINTER BRAKE PADS (SEARCH BY BRAND)

CC	MODELLO MODEL	ANNO YEAR	 YOUR BEST PARTNER						
			 ANTERIORE FRONT		 POSTERIORE REAR		 ANTERIORE FRONT	 POSTERIORE REAR	
			PASTIGLIA ORGANICA ORGANIC				PASTIGLIA SINTERIZZATA SINTERED		
									
			OMOLOGATA HOMOLOGATED	NON OMOLOGATA NOT HOMOLOGATED	GANASCE BRAKE SHOES	OMOLOGATA HOMOLOGATED	NON OMOLOGATA NOT HOMOLOGATED	GANASCE BRAKE SHOES	OMOLOGATA HOMOLOGATED
22 510		22 512	22 510		22512	22 510	22 510		
50	Tempo 50 13	00>	0190			0091	0193		
50	Tempo 50 16	00>	0190			0091	0193		
50	Tr 50 (Spain)	89>	0080				0083		
80	Evo 80	09>	0640						
80	Evo 80 Junior	10>	0080		0080		0083	0083	
80	Rev 80	00>07	0080		0080		0083	0083	
80	Rev 80	08>	0640						
125	Alp 125	99>	0080		0080		0083	0083	
125	Alp 125 4T	99>05	0080		0080		0083	0083	
125	Alp 125 4T	06>08	0360		3020		0363	3023	
125	Eikon 125	99>	2020						
125	Eikon 125	99>03	0080		0080		0083	0083	
125	Eikon 125	99>			0310			0313	
125	Eikon 125	04>	0190		0310		0193	0313	
125	Evo 125 2T	09>	0640						
125	Jonathan 125	99>	0520		1330		0523	1333	
125	Kr 125	86>	0010				0013		
125	Kr 125 Afrika	87>	0010				0013		
125	Rev 3 125	00>05	0640		0640				
125	Rev 3 125	06>08	0640						
125	Rr 125 4T	05>06	0360		3020		0363	3023	
125	Rr 125 4T Re	08>	0360		3020		0363	3023	
125	Rr 125 Enduro 4T Eu3	08>	0360		3020		0363	3023	
125	Rr 125 Enduro Eu3	07>	0360		3020		0363	3023	
125	Rr 125 Motard 4T Eu3	08>	0360		3020		0363	3023	
125	Rr 125 Motard Eu3	07>	0360		3020		0363	3023	
125	Techno 125	98>	0080		0080		0083	0083	
125	Tr 32 125	86>	0030						
125	Tr 33 125	87>	0030						
125	Tr 34 125	88>	0030		0070				
125	Tr 35 125	90>	0080		0080		0083	0083	
125	Trial 125	97>	0080				0083		
125	Urban 125	08>	0360		3020		0363	3023	
150	Eikon 150	99>	2020		0310			0313	
150	Eikon 150	04>	0190		0310		0193	0313	
200	Alp 200 4T	00>05	0080		0080		0083	0083	
200	Alp 200 4T	06>08	0360		3020		0363	3023	
200	Evo 200 2T	09>	0640						
200	Rev 3 200	00>05	0640		0640				
200	Rev 3 200	06>08	0640						
200	Urban 200	08>	0360		3020		0363	3023	
240	Alp 240	91>95	0030						
240	Alp 240	96>	0080		0010		0083	0013	
240	Supertrial 240	92>	0080				0083		
240	Tr 33 240	86>88	0030						
240	Tr 33 Trekking 240	88>	0030						
250	Alp 250	97>	0080		0080		0083	0083	
250	Cr 250	83>	0010				0013		
250	Eikon 250	99>	0080		0080		0083	0083	
250	Evo 250 2T	09>	0640						
250	Kr 250 Afrika	86>	0010				0013		
250	Kr 250 Rally	87>	0010				0013		

□ Con Piastra - With Plate

PASTIGLIE FRENO RMS - SINTER (RICERCA PER MARCA)

RMS - SINTER BRAKE PADS (SEARCH BY BRAND)



CC	MODELLO MODEL	ANNO YEAR	RMS YOUR BEST PARTNER				SINTER			
			 ANTERIORE FRONT		 POSTERIORE REAR		 ANTERIORE FRONT	 POSTERIORE REAR		
			PASTIGLIA ORGANICA ORGANIC				PASTIGLIA SINTERIZZATA SINTERED			
			 OMOLOGATA HOMOLOGATED	 NON OMOLOGATA NOT HOMOLOGATED	 GANASCE BRAKE SHOES	 OMOLOGATA HOMOLOGATED	 NON OMOLOGATA NOT HOMOLOGATED	 GANASCE BRAKE SHOES		
			22 510		22 512		22 510		22 512	
250	Rev 250 4T	07>08	0640							
250	Rev 3 250	00>04	0640		0640					
250	Rev 3 250	05>08	0640							
250	Rr 250 4T	05>	0920		1450		0923 1453			
250	Techno 250	94>99	0080		0080		0083 0083			
250	Tr 34 250	88>	0030		0070					
250	Tr 34 250 (Spain)	89>	0030		0030					
250	Tr 34 250 Professional	89>	0030		0070					
250	Tr 35 250	90>91	0080		0080		0083 0083			
260	Alp 260	90>	0030							
260	Synt 260	92>	0080				0083			
260	Tr 34 260	87>88	0030		0070					
260	Tr 35 260	89>91	0030							
260	Zero 260 Gara - Techno - Synt	93>	0080				0083			
260	Zero 260 Synt	89>92	0080				0083			
270	Rev 3 270	00>04	0640		0640					
270	Rev 3 270	05>08	0640							
290	Evo 290 2T	09>	0640							
350	350 Jonathan	02>	0520		1330		0523 1333			
350	Alp 350 4.0	03>	0360				0363			
350	Alp 350 4.0	04>08	0360		3020		0363 3023			
350	Euro 350	99>	0520		1330		0523 1333			
350	Motard 350 4.0	04>08			3020		3023			
400	Rr 400 4T	05>	0920		1450		0923 1453			
450	Rr 450 4T	05>	0920		1450		0923 1453			
500	Gs - Rv 500	84>	0010				0013			
525	Rr 525 4T	05>	0920		1450		0923 1453			
BIMOTA										
400	Yb 7 400	89>	0520		0010		0523 0013			
500	V Due 500	97>	0520		0010		0523 0013			
600	Bellaria 600 Sport	91>			3150		3153			
600	Bellaria 600 Sport	91>	0520				0523			
600	Yb 9 600 Sri	97>	0520		0010		0523 0013			
650	Supermono 650	97>	0520		0010		0523 0013			
750	Sb 7 750	96>	0520		0010		0523 0013			
750	Yb 4 750	89>	0520		0010		0523 0013			
851	Tesi 851 1D	91>			3150		3153			
851	Tesi 851 1D	91>	0520				0523			
900	Db 1 - 2 900	92>	0520		0010		0523 0013			
900	Db 4 900	99>	1100		0010		1103 0013			
900	Mantra 900	97>	0520		0010		0523 0013			
906	Tesi 906 1D	91>			3150		3153			
906	Tesi 906 1D	91>	0520				0523			
1000	Bb3	14					3333			
1000	1000 All Models ->1988	>88	3150		3150		3153 3153			
1000	Db 5 1000 Delirio	07>	2860		0490		2863 0493			
1000	Db 5 1000 Mille	05>	2860		0490		2863 0493			
1000	Db 5 1000 S	07>	2860		0490		2863 0493			
1000	Sb 3 1000	83>	3150		3150		3153 3153			
1000	Sb 8 1000 R	98>	1100		0010		1103 0013			
1000	Sb 8K 1000	06>	1100		0010		1103 0013			
1000	Sb 8K 1000 Santamonica	07>	2860		0010		2863 0013			

Con Piastra - With Plate



PASTIGLIE FRENO RMS - SINTER (RICERCA PER MARCA)

RMS - SINTER BRAKE PADS (SEARCH BY BRAND)

CC	MODELLO MODEL	ANNO YEAR	RMS YOUR BEST PARTNER				SINTER			
			ANTERIORE FRONT		POSTERIORE REAR		ANTERIORE FRONT	POSTERIORE REAR		
			PASTIGLIA ORGANICA ORGANIC				PASTIGLIA SINTERIZZATA SINTERED			
			22 510	22 512	22 510	22 512	22 510	22 510		
1000	Yb 10 1000 Biposto	92>	0520		0010		0523	0013		
1000	Yb 11 1000	97>	0520		0010		0523	0013		
1000	Yb 6 1000	89>	0520		0010		0523	0013		
1000	Yb 8 1000 E	90>	0520		0010		0523	0013		
1000	Yb 8 1000 E.i. Furano	90>	0520		0010		0523	0013		
1000	Yb 8 1000 Furano	92>	0520		0010		0523	0013		
1002	Yb 10 1002 Dieci	91>	0520				0523			
1002	Yb 10 Dieci 1002	91>			3150			3153		
1098	Db 7 1098	08>	2860		0490		2863	0493		
1099	Db 7 1099	09>			0010		2923	0013		
1099	Db7 (Pinze radiali - Rad.cal)	09					3333			
1100	Db 6R 1100 Delirio	08>	2860		0490		2863	0493		
1100	Sb 6 1100	97>	0520		0010		0523	0013		
1198	Db8 1198	10>			0490		2923	0493		
1198	Db9 Brivido S	11>			0490		3043	0493		
1198	Db9 Brivido Sc	11>			0490		3043	0493		
1198	Db8 (Pinze radiali - Rad.cal)	10					3333			
1200	Db11 (Pinze radiali - Rad.cal)	13					3333			
BLATA										
125	Enduro 125	07>	3160		0080		3163	0083		
125	Motard 125	07>	3160		0080		3163	0083		
BMW										
125	C 1 125	99>	1010		1330		1013	1333		
200	C 1 200	01>	1010		1330		1013	1333		
450	G 450 Enduro	08>	0430		0750			0753		
450	G 450 Smr	09>	2860		0750		2863	0753		
450	R 45 450	81>	3150				3153			
650	F 650	94>00	1010		1330		1013	1333		
650	F 650 Cs Scarver	02>06	1010		1330		1013	1333		
650	F 650 Gs	08>	1010		1330		1013	1333		
650	F 650 Gs Dakar / Rallye	01>07	1010		1330		1013	1333		
650	F 650 St	94>00	1010		1330		1013	1333		
650	G 650 Gs	09>	1010		1330		1013	1333		
650	G 650 X Challenge	07>	1010		1330		1013	1333		
650	G 650 X Country	07>	1010		1330		1013	1333		
650	G 650 X Moto	07>	1100		1330		1103	1333		
650	R 65 650	81>89	3150				3153			
650	R 65 650 Gs	87>	3150				3153			
650	R 65 650 Ls	>81	3150				3153			
750	K 75 750	90>			3150			3153		
750	K 75 750	>88	3150				3153			
750	K 75 750 (Pinza Abs)	91>			3150			3153		
750	K 75 750 Rt	91>93			3150			3153		
750	K 75 750 S	88>93			3150			3153		
750	K 75 750 S	>88	3150		3150		3153	3153		
800	F 800 Gs	08>	1010		1330		1013	1333		
800	F 800 R	09>	1100		1330		1103	1333		
800	F 800 S	06>	1100		1330		1103	1333		
800	F 800 St	06>	1100		1330		1103	1333		
800	F 800 St Touring	11>	1100		1330		1103	1333		
800	R 80 800 All Models	82>84	3150				3153			
800	R 80 800 All Models	85>89	3150				3153			

Con Piastra - With Plate

PASTIGLIE FRENO RMS - SINTER (RICERCA PER MARCA)

RMS - SINTER BRAKE PADS (SEARCH BY BRAND)



CC	MODELLO MODEL	ANNO YEAR	RMS YOUR BEST PARTNER				SINTER			
			 ANTERIORE FRONT		 POSTERIORE REAR		 ANTERIORE FRONT	 POSTERIORE REAR		
			PASTIGLIA ORGANICA ORGANIC				PASTIGLIA SINTERIZZATA SINTERED			
			 OMOLOGATA HOMOLOGATED	 NON OMOLOGATA NOT HOMOLOGATED	 GANASCE BRAKE SHOES	 OMOLOGATA HOMOLOGATED	 NON OMOLOGATA NOT HOMOLOGATED	 GANASCE BRAKE SHOES		
			22 510	22 512	22 510	22 512	22 510	22 510		
800	R 80 800 Gs/Paris-Dakar	81>86	3150				3153			
850	R 850 C	99>			1380			1383		
850	R 850 Gs	99>			1380			1383		
850	R 850 R	99>			1380			1383		
850	R 850 R	03>	2120		1380		3013	1383		
850	R 850 R Roadster	95>			1380			1383		
850	R 850 R Roadster	01>			1380		1603	1383		
850	R 850 Rt	98>00			1330			1333		
850	R 850 Rt Abs	01>			1380		1603	1383		
1000	K 1 1000	89>			3150			3153		
1000	K 100 1000 (Pinza Abs)	91>			3150			3153		
1000	K 100 1000 All Models	>88	3150		3150		3153	3153		
1000	K 100 1000 Lt	88>			3150			3153		
1000	K 100 1000 Rs	88>90			3150			3153		
1000	K 100 1000 Rs	90>			3150			3153		
1000	R 100 1000 All Models	81>89	3150				3153			
1000	R 100 1000 All Models	81>89	3150		3150		3153	3153		
1000	R 100 1000 Rs - Rt - Cs	81>			3150			3153		
1000	S 1000 Rr	09>			1330		3003	1333		
1000	S Rr Hp4	13					3333			
1100	K 1100 Rt (Abs)	00>			1380			1383		
1100	R 1100 Gs (Abs)	94>			1380			1383		
1100	R 1100 R	99>			0430					
1100	R 1100 R Roadster	95>00			1380			1383		
1100	R 1100 Rs (Abs)	94>			1380			1383		
1100	R 1100 Rt (Abs)	95>			1380			1383		
1100	R 1100 S	99>00			1380			1383		
1100	R 1100 S (No Abs)	01>			1380		1603	1383		
1100	R 1100 S Abs	01>	2120		1380		3013	1383		
1150	R 1150 Gs	00>			1380			1383		
1150	R 1150 R	01>	2120		1380		3013	1383		
1150	R 1150 R Con Freno Integrale	01>	2120		1380		3013	1383		
1150	R 1150 R Roadster	01>	2120		1380		3013	1383		
1150	R 1150 Rs Con Freno Integrale	01>	2120		1380		3013	1383		
1150	R 1150 Rt	01>	2120		1380		3013	1383		
1200	Hp2 1200 Enduro	06>	1010		0430		1013			
1200	Hp2 1200 Megamoto	07>			1380		1603	1383		
1200	Hp2 1200 Sport	08>			0430		2923			
1200	K 1200 Rs	97>00			3150			3153		
1200	K 1200 Rs	01>04			3150			3153		
1200	K 1200 Gt Abs Integrale	02>07					1603			
1200	K 1200 Gt Abs Integrale	08>			0430		1603			
1200	K 1200 Lt Abs Integrale	02>	2120				3013			
1200	K 1200 R	05>08	2120		1380		3013	1383		
1200	K 1200 R Sport	07>	2120		1380		3013	1383		
1200	K 1200 Rs	01>04					1603			
1200	K 1200 S	05>08			1380		1603	1383		
1200	R 1200 C All Models	97>02			1380			1383		
1200	R 1200 C Classic	03>04	2120		1380		3013	1383		
1200	R 1200 C Indipendent	03>	2120		1380		3013	1383		
1200	R 1200 C Motauk	04>	2120		1380		3013	1383		
1200	R 1200 CL	03>	2120				3013			

□ Con Piastra - With Plate



PASTIGLIE FRENO RMS - SINTER (RICERCA PER MARCA)

RMS - SINTER BRAKE PADS (SEARCH BY BRAND)

CC	MODELLO MODEL	ANNO YEAR	RMS YOUR BEST PARTNER				SINTER			
			ANTERIORE FRONT		POSTERIORE REAR		ANTERIORE FRONT	POSTERIORE REAR		
			PASTIGLIA ORGANICA ORGANIC				PASTIGLIA SINTERIZZATA SINTERED			
			OMOLOGATA HOMOLOGATED	NON OMOLOGATA NOT HOMOLOGATED	GANASCE BRAKE SHOES	OMOLOGATA HOMOLOGATED	NON OMOLOGATA NOT HOMOLOGATED	GANASCE BRAKE SHOES		
			22 510	22 512	22 510	22 512	22 510	22 510		
1200	R 1200 Gs	04>			1380		1603	1383		
1200	R 1200 Gs	13>					3193			
1200	R 1200 Gs Tripple Black	11>			1380		1603	1383		
1200	R 1200 Lt Con Freno Integrale	02>	2120				3013			
1200	R 1200 R	05>08	2120		1380		3013	1383		
1200	R 1200 R Sport	07>	2120		1380		3013	1383		
1200	R 1200 Rt	06>			1380		1603	1383		
1200	R 1200 S	06>			1380		1603	1383		
1200	R 1200 St	06>			1380		1603	1383		
1200	Hp2 Sport	08-10					3333			
1300	K 1300 Gt	09>			1380		1603	1383		
1300	K 1300 R	09>	2120		1380		3013	1383		
1300	K 1300 R Dynamic	11>	2120		1380		3013	1383		
1300	K 1300 S	09>			1380		1603	1383		
1600	K 1600 GT	11>	2120		1380		3013	1383		
1600	K 1600 GTL	11>	2120		1380		3013	1383		
BOMBARDIER ATV										
200	Rally 200 2X4	03>	0040							
330	Outlander 330 (Pinza Dx)	03>	2890		2870		2893	2873		
330	Outlander 330 (Pinza Sx)	03>	2870		2870		2873	2873		
400	Outlander 400 (Pinza Dx)	03>	2890		2870		2893	2873		
400	Outlander 400 (Pinza Sx)	03>	2870		2870		2873	2873		
500	Quest 500 (Pinza Dx)	02>	2890		2870		2893	2873		
500	Quest 500 (Pinza Sx)	02>	2870		2870		2873	2873		
500	Traxter 500 (Pinza Dx)	01>	2890		2870		2893	2873		
500	Traxter 500 (Pinza Sx)	01>	2870		2870		2873	2873		
500	Traxter 500 4X4	99>00	0490		0490		0493	0493		
650	Ds 650 (Pinza Dx)	00>01	2890		2870		2893	2873		
650	Ds 650 (Pinza Sx)	00>01	2870		2870		2873	2873		
650	Quest 650 (Pinza Dx)	02>	2890		2870		2893	2873		
650	Quest 650 (Pinza Sx)	02>	2870		2870		2873	2873		
BRANDY-BRAS										
50	Brandy 50	-					0061			
90	Brandy 90	-					0061			
BS VILLA										
50	Ax 50	93>	0180				0091			
50	Gz 50	93>	0180				0091			
50	Zx 50	93>	3240	0140						
BUELL										
500	Blast 500	01>09	0870		2610		0873	2613		
984	Xb9r 984 Firebolt	02>10			2610			2613		
984	Xb9s 984 Lightning	03>10			2610			2613		
984	Xb9sx 984 City X	05>10			2610			2613		
1200	M2 1200 Cyclone	98>02			2610			2613		
1200	Rs 1200 X 1	01>			2610			2613		
1200	S1 1200 Lightning	98>02			2610			2613		
1200	S1 1200 Whitelighning	98>02			2610			2613		
1200	S3 1200 Thunderbolt	98>02			2610			2613		
1200	X1 1200 Lightning	01>02			2610			2613		
1200	Xb12r 1200 Firebolt	04>08			2610			2613		
1200	Xb12r 1200 Firebolt	09>10			2610			2613		

Con Piastra - With Plate

PASTIGLIE FRENO RMS - SINTER (RICERCA PER MARCA)

RMS - SINTER BRAKE PADS (SEARCH BY BRAND)



CC	MODELLO MODEL	ANNO YEAR	RMS YOUR BEST PARTNER				SINTER			
			ANTERIORE FRONT		POSTERIORE REAR		ANTERIORE FRONT	POSTERIORE REAR		
			PASTIGLIA ORGANICA ORGANIC				PASTIGLIA SINTERIZZATA SINTERED			
			OMOLOGATA HOMOLOGATED	NON OMOLOGATA NOT HOMOLOGATED	GANASCE BRAKE SHOES	OMOLOGATA HOMOLOGATED	NON OMOLOGATA NOT HOMOLOGATED	GANASCE BRAKE SHOES		
			22 510	22 512	22 510	22 512	22 510	22 510		
1200	Xb12s 1200 Lightning	04>08			2610		2613			
1200	Xb12scg 1200 Lightning	06>08			2610		2613			
1200	Xb12scg 1200 Lightning	09>			2610		2613			
1200	Xb12scg 1200 Lightning	09>10			2610		2613			
1200	Xb12ss 1200 Lightning Long	06>08			2610		2613			
1200	Xb12ss 1200 Lightning Long	09>10			2610		2613			
1200	Xb12tt 1200 Super Tt	07>10			2610		2613			
1200	Xb12x 1200 Super Tt	06>10			2610		2613			
BULTACO										
50	Astro 50	01>	0740		0080		0083			
50	Lobito 50	98>	0740		0080		0083			
75	Lobito 75	99>	0740		0080		0083			
CAGIVA										
50	Blues 50	89>	0060		0020		0063			
50	City 50	92>94	3240	0140		0091				
50	City 50	95>	2750			0091	2753			
50	Cocis 50	88>	0010		0020		0013			
50	Cocis 50	89>	0010		0010					
50	Corsa 50	98>	0080				0083			
50	Cucciolo 50	97>	0010				0013			
50	Lucky Explorer 50	88>	0010		0020		0013			
50	Mantis 50	98>	0080			0131	0083			
50	Mito 50	98>	0060		0080		0063			
50	Nuvola 50	00>	0010				0013			
50	Passing 50	95>	2750				2753			
50	Prima 50	92>			0160					
50	Progress 50	97>	0080			0131	0083			
50	Supercity 50	93>			0010					
50	W4 Pro Action 50	94>	0010			0020	0013			
75	Elefant 750 Bifaro	90>			0740					
80	City 80	93>			0160					
80	Cocis 80	89>	0010			0020	0013			
80	Prima 80	92>			0160					
80	Supercity 80	94>			0010					
80	W4 Pro Action 80	94>	0010			0020	0013			
110	Passing 110 (Brasil)	-	2750				2753			
125	Aletta Oro Rs	86>		0020		0020				
125	Blues 125	88>92	0060		0010		0063			
125	Blues 125	93>	0060			0020	0063			
125	Dakar	85>		0020						
125	Elefantre 125	87>	0010							
125	Freccia 125	87>			0010		0013			
125	Freccia 125 C10	88>			0010		0013			
125	Freccia 125 C10 Anniversario	89>			0010		0013			
125	Freccia 125 C10 R	88>			0010		0013			
125	Freccia 125 C12 R	89>90			0010		0013			
125	Freccia 125 C12 R	91>			0010		0013			
125	Freccia 125 C9	88>			0010		0013			
125	K7 125 Enduro	91>			0010		0013			
125	Mito 125	91>			0010		0013			
125	Mito 125 Eddy	93>	0520		0010		0523			
125	Mito 125 Eu2	05>	0520		0010		0523			



PASTIGLIE FRENO RMS - SINTER (RICERCA PER MARCA)

RMS - SINTER BRAKE PADS (SEARCH BY BRAND)

CC	MODELLO MODEL	ANNO YEAR	RMS YOUR BEST PARTNER				SINTER			
			ANTERIORE FRONT		POSTERIORE REAR		ANTERIORE FRONT	POSTERIORE REAR		
			PASTIGLIA ORGANICA ORGANIC				PASTIGLIA SINTERIZZATA SINTERED			
			OMOLOGATA HOMOLOGATED	NON OMOLOGATA NOT HOMOLOGATED	GANASCE BRAKE SHOES	OMOLOGATA HOMOLOGATED	NON OMOLOGATA NOT HOMOLOGATED	GANASCE BRAKE SHOES		
			22 510	22 512	22 510	22 512	22 510	22 510		
125	Mito 125 Ev	94>03	0520		0010		0523	0013		
125	Mito 2 125 Production Racer	94>	0520		0010		0523	0013		
125	Nuvola 125	00>	0010				0013			
125	Passing 125	96>	2750				2753			
125	Planet 125	98>	0520				0523			
125	Raptor 125	03>	0520		0010		0523			
125	Roadster 125	94>	0060				0063			
125	Supercity 125	94>			0010					
125	W8 Pro Action 125	92>95			0010					
125	Wmx 125 Cross	86>	0010				0013			
125	Wr 125	93>	1420		1440		1423			
200	Elefant	85>98		0020						
200	Roadster 200	96>	0060				0063			
250	Ala Blu 250	83>	0010				0013			
250	Ala Rossa 250	83>	0010				0013			
250	Ala Verde 250	83>	0010				0013			
250	Sst 250	80>	0010				0013			
250	Sst 250 Ruota Integrale	>82	0010				0013			
250	Ssx 250	82>	0010				0013			
250	St 250	82>	0010				0013			
250	Sx 250	82>	0010				0013			
250	Wmx 250	>82	0010				0013			
250	Wmx 250 /1	83>	0010				0013			
250	Wrx 250	83>	0010				0013			
350	Ala Azzurra 350	83>	0010				0013			
350	Ala Azzurra 350 Gt	87>	0010				0013			
350	Ala Blu 350	83>	0010				0013			
350	Ala Rossa 350	83>	0010				0013			
350	Ala Rossa 350	88>	0010				0013			
350	Ala Verde 350	83>	0010				0013			
350	Elefant 350	85>			0010			0013		
350	Sst 350	81>	0010				0013			
350	Sst 350	82>	0010				0013			
350	Sx 350	82>	0010				0013			
350	T4 350 R - Er	87>	0010				0013			
350	W 12 350	92>			0010					
500	Canyon 500	99>	1420		1070		1423	1073		
500	River 500	00>	0520		0010		0523			
500	T4 500 E - Er	87>	0010				0013			
500	Wmx 500	84>	0010				0013			
600	Canyon 600	95>	1420		1070		1423	1073		
600	River 600	94>	0520		0010		0523			
650	Ala Azzurra 650	84>	0010		0010		0013			
650	Ala Azzurra 650 Gt	87>	0060		0010		0063	0013		
650	Elefant 650	85>			0010			0013		
650	Raptor 650	01>	1100		0490		1103	0493		
650	V-Raptor 650	01>	1100		0490		1103	0493		
750	Dakar 750	87>			0010			0013		
750	Elefant 750	87>			0010			0013		
750	Elefant 750	94>			0430					
900	900 Cat	93>	0870		2640	0890	0873	2643		
900	Canyon 900 ie	97>			1070			1073		

Con Piastra - With Plate



PASTIGLIE FRENO RMS - SINTER (RICERCA PER MARCA)

RMS - SINTER BRAKE PADS (SEARCH BY BRAND)

CC	MODELLO MODEL	ANNO YEAR	RMS YOUR BEST PARTNER				SINTER			
			ANTERIORE FRONT		POSTERIORE REAR		ANTERIORE FRONT	POSTERIORE REAR		
			PASTIGLIA ORGANICA ORGANIC				PASTIGLIA SINTERIZZATA SINTERED			
			22 510	22 512	22 510	22 512	22 510	22 510		
50	Oliver 50 All Models	03>05					0061			
50	Popcorn 50	02>	0040				0061			
50	Supercross 50	03>05	0080		0080		0083	0083		
50	Supermoto 50	03>05	0080		0080		0083	0083		
125	Gtr 125	02>	0360		0300		0363	0303		
125	Gts 125	02>03	0360		0300		0363	0303		
125	Prince 125	01>	3210							
125	Sahel 125	02>	0920		2630		0923	2633		
125	X-Large 125	02>03	0490		0490		0493	0493		
150	X-Large 150	02>03	0490		0490		0493	0493		
200	Gtr 200	02>	0360		0300		0363	0303		
200	Gts 200	02>03	0360		0300		0363	0303		
200	X-Large 200	02>03	0490		0490		0493	0493		
250	Xs 250	07>	3070				3073			
250	Xs 250 Power Quad	06>	0040							
CZ JAWA										
50	50 Minarelli	03>04	0080				0083			
50	Robby 50	03>04	0080				0083			
100	Robby 100	03>04	0080				0083			
125	Cz 125 2T	-	3150				3153			
125	Cz 125 Mx	-	3150				3153			
125	Chopper 125	03>04	0080				0083			
125	Dandy 125	03>04	0080		0080		0083	0083		
125	Sport 125	03>04	0080		0080		0083	0083		
125	Travel 125	03>04	0080				0083			
180	Cz 180	92>	3150				3153			
180	Cz 180	93>	0010					0013		
300	Trail 300	93>	3150				3153			
DAELIM										
50	A Four 50	06>	0580				0583			
50	Besbi 50	07>	2630				2633			
50	Bonita 50	09>	3240	0140						
50	Delfino 50	99>	1440							
50	E-Five 50	03>	1440							
50	Gz 50 G Message	98>	3240	0140						
50	History 50	01>	1440		1440					
50	Message 50 li	02>	1440							
50	Se 50 Cordi	06>	1440							
50	S-Five 50	01>	1440		1440					
50	Sj 50 S Five	06>	3240	0140						
50	Tapo 50	99>	1440							
50	Vivo 50	99>	1440							
100	Altino 100	99>	1440							
100	Delfino 100	99>	1440							
110	City Ace 110	03>	2590				2593			
125	Altino 125	02>	1440							
125	Daystar 125	00>	2640	0890			2643			
125	Delfino 125	08>	0580				0583			
125	History 125	01>	1440		1440					
125	Message 125 li	02>	1440							
125	Nf 125	03>	1440							
125	Ns 125 li	00>	1440				0091			

Con Piastra - With Plate

PASTIGLIE FRENO RMS - SINTER (RICERCA PER MARCA)

RMS - SINTER BRAKE PADS (SEARCH BY BRAND)















CC	MODELLO MODEL	ANNO YEAR								
			 ANTERIORE FRONT		 POSTERIORE REAR		 ANTERIORE FRONT	 POSTERIORE REAR		
			PASTIGLIA ORGANICA ORGANIC				PASTIGLIA SINTERIZZATA SINTERED			
			 OMOLOGATA HOMOLOGATED	 NON OMOLOGATA NOT HOMOLOGATED	 GANASCE BRAKE SHOES	 OMOLOGATA HOMOLOGATED	 NON OMOLOGATA NOT HOMOLOGATED	 GANASCE BRAKE SHOES		
			22 510	22 512	22 510	22 512	22 510	22 510		
125	Otello 125	99>	1440							
125	Otello 125	08>	0380		1440		0383			
125	Otello 125 Dlx	99>	1440		1440					
125	Roadwin 125	04>	2640	0890	0350		2643	0353		
125	Rocket 125	99>	2640	0890			2643			
125	S2 125	05>06	2640	0890			2643			
125	S2 125 Fi	07>	0380		1440		0383			
125	SI 125 U3 Fi	07>	0380		1440		0383			
125	U2 125 Fi	07>	0380		1440		0383			
125	VI 125 Daystar	00>	2640	0890			2643			
125	Vs 125 Evolution	95>	1440							
125	Vt 125 Evolution	00>	2640	0890			2643			
125	Vt 125 Magna	97>	2640	0890			2643			
150	Roadwin 150 X5	06>	2640	0890	0350		2643	0353		
250	Roadwin 250	08>	2640	0890	0350		2643	0353		
250	S2 250	06>	2640	0890	1440		2643			
250	St 250 Sector Quad	05>06	0040		3230					
DB MOTORS										
50	Pirat 50 Zz	00>	0010		0010		0013			
50	Sport 50 Zz	00>	0010				0013			
DERBI										
50	All Models 50 Con Freno A Disco	83>	0080				0083			
50	Atlantis 50	99>	0080				0083			
50	Atlantis 50 4T	04>	0080				0083			
50	Atlantis 50 Bullet	04>	0080				0083			
50	Atlantis 50 City	06>	0080				0083			
50	Atlantis 50 H20	01>	0080				0083			
50	Atlantis 50 Wawe	01>	0080				0083			
50	Aventura 50	96>	0080				0083			
50	Black Devil 50	04>	0360		0080		0363	0083		
50	Coppa 50 Fdt	86>	0080				0083			
50	Coppa 50 Fdx	87>	0080				0083			
50	Drd Racing 50 R	05>	0360		0080		0363	0083		
50	Drd Racing 50 Sm	05>	0360		0080		0363	0083		
50	Ds 50 World Champion	88>	0080				0083			
50	Easy 50	96>	0010				0013			
50	Fd 50 Jumbo	85>	0080				0083			
50	Fds 50	86>	0080				0083			
50	Fenix 50	94>	0080		0080		0083	0083		
50	Furax 50	96>	0080		0080		0083	0083		
50	Gp 1 50	01>04	0080		0080		0083	0083		
50	Gp 1 50 Eu2	05>	0490		0080		0493	0083		
50	Gpr 50 Nude	04>	0490		0080		0493	0083		
50	Gpr 50 R	97>	0740		0080			0083		
50	Gpr 50 Racing	04>	0490		0080		0493	0083		
50	Gpr 50 Sport	96>	0070		0020					
50	Hunter 50	95>	0080			0131	0083			
50	Manhattan 50	99>	0080				0083			
50	Paddock 50 St	96>	0080			0131	0083			
50	Predator 50	98>	0080		0080		0083	0083		
50	Predator 50 0.2	99>	0080			0131	0083			
50	Progress 50	97>	0080				0083			



PASTIGLIE FRENO RMS - SINTER (RICERCA PER MARCA)

RMS - SINTER BRAKE PADS (SEARCH BY BRAND)

CC	MODELLO MODEL	ANNO YEAR	 YOUR BEST PARTNER							
			 ANTERIORE FRONT		 POSTERIORE REAR		 ANTERIORE FRONT	 POSTERIORE REAR		
			PASTIGLIA ORGANICA ORGANIC				PASTIGLIA SINTERIZZATA SINTERED			
			 OMOLOGATA HOMOLOGATED	 NON OMOLOGATA NOT HOMOLOGATED	 GANASCE BRAKE SHOES	 OMOLOGATA HOMOLOGATED	 NON OMOLOGATA NOT HOMOLOGATED	 GANASCE BRAKE SHOES	 OMOLOGATA HOMOLOGATED	 NON OMOLOGATA NOT HOMOLOGATED
			22 510	22 512	22 510	22512	22 510	22 510		
50	Record 50	98>	0080			0131	0083			
50	Sabana 50	90>	0080		0080		0083	0083		
50	Senda 50	94>	0080				0083			
50	Senda 50 L	99>	0080		0080		0083	0083		
50	Senda 50 R	94>04	0080		0080		0083	0083		
50	Senda 50 R Drd	03>04	0740		0080			0083		
50	Senda 50 Sm	99>	0080		0080		0083	0083		
50	Senda 50 Sm Drd Black Edition	03>	0360		0080		0363	0083		
50	Senda 50 Sm Drd Racing	03>04	0080		0080		0083	0083		
50	Senda 50 Sm Drd Racing Ltd	05>	0080				0083			
50	Senda 50 X-Treme	94>04	0080		0080		0083	0083		
50	Sport Edition 50	95>	0080				0083			
50	St 50 Paddock	96>	0080				0083			
50	Stinger 50	96>	0080				0083			
50	Vamos 50	94>	0080				0083			
50	Vamos 50 R	95>	0190			0131	0193			
50	Vamos 50 R	96>	0080				0083			
50	Variant 50 Sport R	94>	0080				0083			
50	X-Race 50 R	05>	0080		0080		0083	0083		
50	X-Treme 50 R	05>	0080		0080		0083	0083		
75	Coppa 75 Sport	85>	0080				0083			
75	Gpr 75 Sport	90>	0070							
75	Tt8 75	84>	0010				0013			
75	Yumbo 75 Rd-2 Fds	87>	0080				0083			
80	Gpr 80 Cup	04>	0490		0080		0493	0083		
100	Atlantis 100 4T	04>	0080			0390	0083			
100	Atlantis 100 H20	01>	0080				0083			
125	Boulevard 125	02>04	2810			0421				
125	Gp1 125	06>08	0490		0080		0493	0083		
125	Gpr 125 4T	09>	3160				3163			
125	Gpr 125 Nude	04>06	3160		0080		3163	0083		
125	Gpr 125 Racing	04>06	3160		0080		3163	0083		
125	Mulhacen 125	07>	0360		0010		0363	0013		
125	Mulhacen 125	08					3343			
125	Predator 125	99>	0740							
125	Senda 125 R 4T	04>	0360		0080		0363	0083		
125	Senda 125 X-Treme Sm 4T	04>	0360		0080		0363	0083		
125	Terra	07>	0080		0080		0083	0083		
125	Terra	08					3343			
125	Terra Adventure	08					3343			
150	Atlantis 150	04>	2810							
150	Boulevard 150	02>04	2810			0421				
180	Predator 180	99>	0740							
200	Boulevard 200	05>	2810			0421				
250	Gp1 250	05>	0490		0450		0493	0453		
250	Rc 250	85>	0010				0013			
659	Mulhacen 659	05>			0490		2983	0493		
659	Mulhacen 659 Cafe'	08>			0490		2983	0493		
DUCATI										
250	250 Desmo	>77	3150				3153			
350	350 Desmo	>77	3150				3153			
350	350 F3	86>	0010		0010		0013	0013		

Con Piastra - With Plate

PASTIGLIE FRENO RMS - SINTER (RICERCA PER MARCA)

RMS - SINTER BRAKE PADS (SEARCH BY BRAND)



CC	MODELLO MODEL	ANNO YEAR	RMS YOUR BEST PARTNER				SINTER			
			 ANTERIORE FRONT		 POSTERIORE REAR		 ANTERIORE FRONT	 POSTERIORE REAR		
			PASTIGLIA ORGANICA ORGANIC				PASTIGLIA SINTERIZZATA SINTERED			
			 OMOLOGATA HOMOLOGATED	 NON OMOLOGATA NOT HOMOLOGATED	 GANASCE BRAKE SHOES	 OMOLOGATA HOMOLOGATED	 NON OMOLOGATA NOT HOMOLOGATED	 GANASCE BRAKE SHOES		
			22 510		22 512	22 510		22 512	22 510	22 510
996	996 St4s	02>	1100			0490	1103	0493		
996	Monster S4r 996	04>	1100			0010	1103	0013		
998	998 Biposto	02>	1100			0010	1103	0013		
998	998 R	02>	2860			0490	2863	0493		
998	998 S - R	02>	1100			0010	1103	0013		
999	999 S - R	03>	2860			0490	2863	0493		
999	Monster S4r 999	07>	2860			0490	2863	0493		
999	Monster S4rs 999	07>	2860			0490	2863	0493		
1000	1000 All Models	84>	3150			3150	3153	3153		
1000	1000 Mille Replica	05>	3150			3150	3153	3153		
1000	1000 S2 Desmo	85>	3150			3150	3153	3153		
1000	1000 Biposto	07>	1010			1330	1013	1333		
1000	Desmosedici 1000 Rr	08>				0490	2923	0493		
1000	Gt 1000	07>10	1010			1330	1013	1333		
1000	Gt 1000 Touring	09>	1010			0490	1013	0493		
1000	Hypermotard 1000	06>	2860			0490	2863	0493		
1000	Monster 1000 Dark ie	03>	1100			0010	1103	0013		
1000	Monster 1000 ie	03>	1100			0010	1103	0013		
1000	Monster S2r 1000	06>	1100			0010	1103	0013		
1000	Multistrada 1000	07>	1100			0490	1103	0493		
1000	Multistrada 1000 Ds	03>06	1100			0490	1103	0493		
1000	Multistrada 1000 S Ds	05>06	1100			0490	1103	0493		
1000	Paul Smart 1000 L.e.	06>	1010			1330	1013	1333		
1000	Sport 1000	05>08	1010			1330	1013	1333		
1000	Sport 1000 S	07>09	1010			1330	1013	1333		
1000	Supersport 1000 Ds	03>	1100			0490	1103	0493		
1100	1098 1100 R	08>				0490	2923	0493		
1100	1098 1100 S	07>08				0490	2923	0493		
1100	1098 1100 S Tricolore	07>08				0490	2923	0493		
1100	Hypermotard 1100	07>09	1100			0490	1103	0493		
1100	Hypermotard 1100 Evo	10>	1100			0490	1103	0493		
1100	Hypermotard 1100 Evo Sp	10>				0490	2923	0493		
1100	Hypermotard 1100 S	07>09				0490	2923	0493		
1100	Monster 1100	09>	1100			0490	1103	0493		
1100	Monster 1100 Evo	11>	1100			0490	1103	0493		
1100	Monster S 1100	09>	1100			0490	1103	0493		
1100	Multistrada 1100	07>09	1100			0490	1103	0493		
1100	Multistrada 1100 S	07>09	1100			0490	1103	0493		
1100	Street Fighter 1100	09>				0490	2923	0493		
1100	Street Fighter 1100 S	09>				0490	2923	0493		
1198	1198 1200	09>				0490	2923	0493		
1198	1198 1200 R Corse	10>				0490	2923	0493		
1198	1198 1200 S	09>				0490	2923	0493		
1198	1198 1200 S Corse	10>				0490	2923	0493		
1198	1198 1200 Sp	11>				0490	2923	0493		
1200	Diavel 1200	11>				0430	2923			
1200	Multistrada 1200	10>	1100			0490	1103	0493		
E-TON										
50	Rxl 50 Viper	03>05				0040				
70	Rxl 70 Viper	03>05				0040				
90	Rxl 90 Viper	03>05				0040				

Con Plastra - With Plate

PASTIGLIE FRENO RMS - SINTER (RICERCA PER MARCA)

RMS - SINTER BRAKE PADS (SEARCH BY BRAND)



CC	MODELLO MODEL	ANNO YEAR	RMS YOUR BEST PARTNER				SINTER			
			 ANTERIORE FRONT		 POSTERIORE REAR		 ANTERIORE FRONT	 POSTERIORE REAR		
			PASTIGLIA ORGANICA ORGANIC				PASTIGLIA SINTERIZZATA SINTERED			
			 OMOLOGATA HOMOLOGATED	 NON OMOLOGATA NOT HOMOLOGATED	 GANASCE BRAKE SHOES	 OMOLOGATA HOMOLOGATED	 NON OMOLOGATA NOT HOMOLOGATED	 GANASCE BRAKE SHOES		
			22 510		22 512		22 510		22 512	
50	Trial 50 .9	91>	0080			0080		0083	0083	
65	Mx 65 Regolarita' Competizione	08>	0920			2630		0923	2633	
85	Mx 85 Regolarita' Competizione	08>	0920			2630		0923	2633	
125	Mx 125 Regolarita' Casa	08>	0360			2630		0363	2633	
125	Supersej 125 Motard	08>	0360			2630		0363	2633	
125	Trial 125 .1 Progress 1	86>86	0030							
125	Trial 125 .1 Progress 2	86>	0030							
125	Trial 125 .3 Professional (Fm 361)	87>	0030			0030				
125	Trial 125 .5	89>	0080			0080		0083	0083	
125	Trial 125 .9	91>	0080			0080		0083	0083	
200	Trial 200 Progress 1	86>	0030							
200	Trial 201 Progress2	86>	0030							
240	Trial 240 (Fm 363)	87>	0030			0030				
241	Trial 241 Professional	86>	0030							
250	Coach 250	91>	0080					0083		
250	K-Roo 250	91>	0080			0080		0083	0083	
250	K-Roo 250	93>	0080			0080		0083	0083	
250	Raider 250 (Fm. 259)	85>	0060					0063		
250	Trial 249	90>	0080			0080		0083	0083	
300	Trial 305	89>	0080			0080		0083	0083	
300	Trial 307	90>91	0080			0080		0083	0083	
301	Trial 301 Progress 1 (Fm. 266)	85>	0030							
301	Trial 301 Progress 2	86>	0030							
303	Trial 303 (Fm 364)	87>84	0030			0030				
FB MINARELLI										
80	Mr 80	-	0080					0083		
GARELLI										
50	Basic 50 (Ruota Raggi)	-			0191			0191		
50	Big Wheel 50	93>	0180							
50	Cpr 50	02>	0180							
50	Eureka 50	-			0191			0191		
50	Flo' 50	00>	0190					0193		
50	Fx 50	02>	0180							
50	Grinta 50	95>	0180							
50	Gulp 50	-			0191			0191		
50	Junior 50 Turismo (Ruota Raggi)	-			0201			0201		
50	Krs 50	02>	2750					0131	2753	
50	Noi 50 (Ruota Raggi)	-			0191			0191		
50	Noi 50 Matic	-			0191			0191		
50	Pony 50 Sr	92>	0180							
50	Queenie 50	95>	0180							
50	Sahel 50	91>	0070			0080			0083	
50	Starter 50	02>	0180							
50	Super Vip 50	-			0191			0191		
50	Tiger 50 XLE	86>	0070			0030				
50	Urka 50	91>	0010					0013		
50	Vip 50 (Ruota Raggi)	-			0191			0191		
80	Sahel 80	89>	0070			0080			0083	
125	Freeland 125	02>	2750					2753		
125	Panther 125	02>	3240	0140		0190			0193	
125	Raider 125	02>	0040							
125	Tiger 125 XLE	86>86	0060					0063		



PASTIGLIE FRENO RMS - SINTER (RICERCA PER MARCA)

RMS - SINTER BRAKE PADS (SEARCH BY BRAND)

CC	MODELLO MODEL	ANNO YEAR	RMS YOUR BEST PARTNER				SINTER			
			 ANTERIORE FRONT		 POSTERIORE REAR		 ANTERIORE FRONT	 POSTERIORE REAR		
			PASTIGLIA ORGANICA ORGANIC				PASTIGLIA SINTERIZZATA SINTERED			
			 OMOLOGATA HOMOLOGATED	 NON OMOLOGATA NOT HOMOLOGATED	 GANASCE BRAKE SHOES	 OMOLOGATA HOMOLOGATED	 NON OMOLOGATA NOT HOMOLOGATED	 GANASCE BRAKE SHOES	 OMOLOGATA HOMOLOGATED	 NON OMOLOGATA NOT HOMOLOGATED
			22 510		22 512	22 510		22512	22 510	22 510
125	Tiger 125 Xr	-	0010				0013			
125	Tiger 125 Xrd	-	0010				0013			
150	Freeland 150	02>	2750				2753			
150	Panther 150	02>	3240	0140	0190		0193			
250	Panther 250	02>	3240	0140	0190		0193			
320	Trial 320	86>	0080				0083			
125	Joker 2 125	02>	2590				2593			
150	Joker 2 150	02>	2590				2593			
GAS GAS										
50	Ec 50 Boy	01>	0630		0630					
50	Ec 50 Rookie	01>04	0740		0630					
50	Ec 50 Rookie	05>	0360		0640		0363			
50	Sm 50 Rookie	02>	0740		0630					
50	Txt 50 Boy	01>	0630		0630					
50	Txt 50 Boy	04>	0080		0080		0083	0083		
50	Txt 50 Rookie	02>03	0630		0630					
65	Mc 65	05>	0630		0630					
80	Endurcross 80	94>	0430		0060		0063			
80	Txt 80 Rookie	02>03	0630		0630					
125	Cross 125	94>	0430		0060		0063			
125	Delta 125	91>	0080				0083			
125	Ec 125	97>99	0430		1330		1333			
125	Ec 125	00>01	0920		2630		0923	2633		
125	Ec 125 Mx	02>07	0920		2630		0923	2633		
125	Ec 125 Sm	02>07	0520		2630		0523	2633		
125	Endurcross 125	94>	0430		0060		0063			
125	Jt 12 125	95>	0080		0080		0083	0083		
125	Mc 125	03>	0920		2630		0923	2633		
125	Pampera 125	96>03	0080		0080		0083	0083		
125	Pampera 125	04>	0360		0630		0363			
125	Sm 125	02>	0520		2630		0523	2633		
125	Trial 125	91>	0080		0080		0083	0083		
125	Tt 125	95>	0430		0080		0083			
125	Tt 125 Endurcross	93>	0430		0060		0063			
125	Txt 125	01>03	0630		0630					
125	Txt 125 Pro	04>09	0640		0650					
140	Jtr 140 Contact	96>	0080		0080		0083	0083		
150	Jt 16 150	95>	0080		0080		0083	0083		
160	Jt 160	95>	0080		0080		0083	0083		
200	Ec 200	99>	0430		1330		1333			
200	Ec 200	00>01	0920		2630		0923	2633		
200	Ec 200 Mx	02>07	0920		2630		0923	2633		
200	Ec 200 Sm	02>07	0520		2630		0523	2633		
200	Pampera 200	99>	0080		0080		0083	0083		
200	Tx 200	97>	0080		0080		0083	0083		
200	Txt 200	00>03	0630		0630					
200	Txt 200 Pro	04>09	0640		0650					
249	Txt 249	01>	0630		0630					
250	Cross 250	95>	0430		1200					
250	Ec 250	97>99	0430		1330		1333			
250	Ec 250	98>00	0430		1330		1333			
250	Ec 250	00>01	0920		2630		0923	2633		

Con Piastra - With Plate

PASTIGLIE FRENO RMS - SINTER (RICERCA PER MARCA)

RMS - SINTER BRAKE PADS (SEARCH BY BRAND)



CC	MODELLO MODEL	ANNO YEAR	RMS YOUR BEST PARTNER				SINTER			
			ANTERIORE FRONT		POSTERIORE REAR		ANTERIORE FRONT	POSTERIORE REAR		
			PASTIGLIA ORGANICA ORGANIC				PASTIGLIA SINTERIZZATA SINTERED			
			OMOLOGATA HOMOLOGATED	NON OMOLOGATA NOT HOMOLOGATED	GANASCE BRAKE SHOES	OMOLOGATA HOMOLOGATED	NON OMOLOGATA NOT HOMOLOGATED	GANASCE BRAKE SHOES		
			22 510		22 512	22 510		22512	22 510	22 510
250	Ec 250 Mx	01>07	0920		2630		0923	2633		
250	Ec 250 Mx	02>07	0920		2630		0923	2633		
250	Ec 250 Sm	02>07	0520		2630		0523	2633		
250	Endurcross 250	95>	0430							
250	Jt 25 250	91>	0080		0080		0083	0083		
250	Jt 250 Contact	94>	0080		0080		0083	0083		
250	Jtr 250 Contact	96>	0080		0080		0083	0083		
250	Mc 250	97>99	0430		1330			1333		
250	Mc 250	00>	0920		2630		0923	2633		
250	Pampera 250	96>99	0080		0080		0083	0083		
250	Pampera 250	02>	0360		0630		0363			
250	Sm 250	02>	0520		2630		0523	2633		
250	T 25 250 Contact	93>	0080		0080		0083	0083		
250	Tt 250	95>	0430		1330			1333		
250	Txt 250	00>03	0630		0630					
250	Txt 250 Pro	04>09	0640		0650					
270	Jtr 270 Contact	96>	0080		0080		0083	0083		
270	Tx 270	>99	0080		0080		0083	0083		
280	Pampera 280	04>	0360		0630		0363			
280	Txt 280	00>03	0630		0630					
280	Txt 280	04>09	0640		0650					
300	Ec 300	98>00	0430		1330			1333		
300	Ec 300	01>	0920		2630		0923	2633		
300	Ec 300 Sm	02>07	0520		2630		0523	2633		
300	Txt 300	04>09	0640		0650					
320	Jt 32 320	91>	0080		0080		0083	0083		
321	Txt 321	00>	0630		0630					
325	Halley 325 Pcx	87>	0080		0080		0083	0083		
327	Gt 327 Contact	-	0080		0080		0083	0083		
327	Trial 327	89>	0080		0080		0083	0083		
350	Gasgas 350	-	0080		0080		0083	0083		
350	Jt 350	95>	0080		0080		0083	0083		
370	Jtr 370 Contact	96>	0080		0080		0083	0083		
370	Pampera 370	96>	0080		0080		0083	0083		
400	Fse 400 Ec	01>07	0920		2630		0923	2633		
400	Fse 400 Sm	02>07	0520		2630		0523	2633		
450	Fse 450 Ec	03>07	0520		2630		0523	2633		
450	Fsr 450 Ec	08>	0920		2630		0923	2633		
450	Fsr 450 Sm	08>	0520		2630		0523	2633		
450	Pampera 450	07>08	0920		2630		0923	2633		
510	Fsr 510	08>	0920		2630		0923	2633		
GAS GAS ATV										
50	Wild 50 Hp	04>	0430		0430					
240	Wild 240 Hp	04>	0430		0430					
300	Wild 300 Hp	03>	0430		0430					
450	Wild 450 Hp	03>	0430		0430					
GENERIC										
50	Ideo 50	05>				0061				
50	Toxic 50	07>	0360		0190		0363	0193		
50	Trigger 50 Sm	06>	0360		0190		0363	0193		
50	Trigger 50 Sm Competition	08>	0360		0190		0363	0193		
50	Trigger 50 X	06>	0360		0190		0363	0193		

Con Plastra - With Plate



PASTIGLIE FRENO RMS - SINTER (RICERCA PER MARCA)

RMS - SINTER BRAKE PADS (SEARCH BY BRAND)

CC	MODELLO MODEL	ANNO YEAR	RMS YOUR BEST PARTNER				SINTER			
			 ANTERIORE FRONT		 POSTERIORE REAR		 ANTERIORE FRONT	 POSTERIORE REAR		
			PASTIGLIA ORGANICA ORGANIC				PASTIGLIA SINTERIZZATA SINTERED			
			 OMOLOGATA HOMOLOGATED	 NON OMOLOGATA NOT HOMOLOGATED	 GANASCE BRAKE SHOES	 OMOLOGATA HOMOLOGATED	 NON OMOLOGATA NOT HOMOLOGATED	 GANASCE BRAKE SHOES		
			22 510	22 512	22 510	22 512	22 510	22 510		
50	Trigger 50 X Competition	08>	0360		0190		0363	0193		
50	Xor 50	05>				0061				
125	Ideo 125	05>				0061				
125	Xor 125	05>				0061				
125	Zion 125	08>	0580				0583			
GILERA										
50	503 50	91>	0030		0030					
50	Bullit 50	90>	0030							
50	Cb 1 50	-		0191		0230				
50	Cba 50	-		0191		0230				
50	Cba 50	86>		0191		0230				
50	Dna 50	05>07	2620				2623			
50	Eaglet 50	96>	0070							
50	Easy Moving 50	95>	0190			0301	0193			
50	Easy Moving 50	98>	0190			0360				
50	Eco 50	-		0191		0230				
50	Gsm 50	99>	0080		0080		0083	0083		
50	H@C 50	99>	0080		0080		0083	0083		
50	Ice 50	02>	0190				0193			
50	Runner 50	97>	0190			0351	0193			
50	Runner 50 Pure Jet Race	06>08	2620		0300		2623	0303		
50	Runner 50 Pure Jet St	08>	2620		0300		2623	0303		
50	Runner 50 Sp	98>	0190		0300		0193	0303		
50	Runner 50 Sp Race	06>	2620		0300		2623	0303		
50	Runner 50 Sp Sc	06>07	2620		0300		2623	0303		
50	Runner 50 Sp St	08>	2620		0300		2623	0303		
50	Stalker 50	05>08	2800							
50	Stalker 50	97>04	0190		0300		0193	0303		
50	Stalker 50 Naked	08>	2800							
50	Stalker 50 Special Edition	07>08	2800							
50	Storm 50	94>95	0190			0301	0193			
50	Storm 50	96>				0360				
50	Storm 50 Eu2	07>	2800							
50	Supermotard 50	01>	0080		0080		0083	0083		
50	Surfer 50	99>	0080				0083			
50	Trend 50	89>		0201		0230				
50	Typhoon 50	93>95	0190			0301	0193			
50	Typhoon 50	96>	0190			0360	0193			
50	Typhoon 50 Catalyzed	02>	0190		0190		0193	0193		
50	Typhoon X 50	98>99	0190			0360				
50	Zulu 50	01>	0080		0080		0083	0083		
80	Typhoon 80	95>	0190			0301	0193			
125	Apache 125	91>		2730	1430					
125	Arizona 125	83>	0010				0013			
125	Arizona Hawk 125	86>	0060				0063			
125	Cmm Apts 125	87>	0060		0010		0063			
125	Crono 125	91>	0530		0010		0533			
125	Cx 125	91>	0530		0010		0533			
125	Er 125	87>	0060				0063			
125	Fast Bike 125	87>	0060		0010		0063			
125	Gfr 125	93>	0530		0010		0533			
125	Gsm 125	00>	0080				0083			

□ Con Piastra - With Plate

PASTIGLIE FRENO RMS - SINTER (RICERCA PER MARCA)

RMS - SINTER BRAKE PADS (SEARCH BY BRAND)



CC	MODELLO MODEL	ANNO YEAR	RMS YOUR BEST PARTNER				SINTER			
			 ANTERIORE FRONT		 POSTERIORE REAR		 ANTERIORE FRONT	 POSTERIORE REAR		
			PASTIGLIA ORGANICA ORGANIC				PASTIGLIA SINTERIZZATA SINTERED			
			 OMOLOGATA HOMOLOGATED	 NON OMOLOGATA NOT HOMOLOGATED	 GANASCE BRAKE SHOES	 OMOLOGATA HOMOLOGATED	 NON OMOLOGATA NOT HOMOLOGATED	 GANASCE BRAKE SHOES		
			22 510		22 512		22 510		22 512	
125	Hx 125 Lc	83>	0010				0013			
125	Kk 125 Apts	87>	0060		0010		0063 0013			
125	Kz 125	86>	0060		0010		0063 0013			
125	Kz 125 Endurance	88>	0060		0010		0063 0013			
125	Mx 1 125	88>	0530		0010		0533 0013			
125	Mx R 125	90>	0530		0010		0533 0013			
125	Nexus 125 Eu3	07>08	2620		2620		2623 2623			
125	Nexus 125 ie Eu3	08>09	2620		2620		2623 2623			
125	R1 125 S	88>	0060		0010		0063 0013			
125	Rc 125 Rally	87>	0060				0063			
125	Rc 125 Top Rally	89>			2730 1430					
125	Rrt 125 Nebraska	87>	0060				0063			
125	Rrt 125 Nebraska (Ruote Tubes)	87>	0060				0063			
125	Rtx 125	-	0060				0063			
125	Runner 125	>99	0360		0421		0363			
125	Runner 125 (Pinza Heng Tong)	02>	2620		0450		2623 0453			
125	Runner 125 4T	05>06	2620		0450		2623 0453			
125	Runner 125 Fx - Sp	00>	0360		0300		0363 0303			
125	Runner 125 Vx / Vxr 4T	01>04	0360		0450		0363 0453			
125	Runner 125 Vx 4T Eu3	07>	2620		0450		2623 0453			
125	Runner 125 Vx 4T Race	06>07	2620		0450		2623 0453			
125	Runner 125 Vx 4T Sc	06>07	2620		0450		2623 0453			
125	Runner 125 Vx 4T St Eu3	08>	2620		0450		2623 0453			
125	Rv 125 Es	87>	0060				0063			
125	Rx 125	84>	0010				0013			
125	Sp 01 125	89>	0530		0010		0533 0013			
125	Sp 02 125	90>	0530		0010		0533 0013			
125	Surfer 125	00>	0080				0083			
125	Typhoon 125	95>	0190		0351		0193			
125	Typhoon 125 Xr Kat	00>	0190		0351		0193			
125	Xr1 125	88>	0060		0010		0063 0013			
125	Xr2 125	89>	0060		0010		0063 0013			
175	Mad Mud 175	02>	0360		0190		0363 0193			
180	Dna 180	01>	0360		0190		0363 0193			
180	Runner 180	>98	0360		0421		0363			
180	Runner 180 (Pinza Heng Tong)	02>	2620		0450		2623 0453			
180	Runner 180 Fxr - Sp	99>	0360		0300		0363 0303			
200	Arizona Hawk 200	86>	0060				0063			
200	Er 200	87>	0060				0063			
200	Fast Bike 200	87>	0060		0010		0063 0013			
200	Rtx 200	86>	0060				0063			
200	Runner 200 Vx / Vxr 4T	02>	0360		0450		0363 0453			
200	Runner 200 Vxr 4T	05>06	2620		0450		2623 0453			
200	Runner 200 Vxr 4T Race	06>	2620		0450		2623 0453			
200	Runner 200 Vxr 4T St Eu3	08>	2620		0450		2623 0453			
200	Runner 200 Vxr Eu3	07>	2620		0450		2623 0453			
200	Rv 200	85>			0010		0013			
200	Rv 200 Es	87>	0060		0010		0063 0013			
200	Rx 200	85>	0010							
200	Rx 200 Arizona	85>	0010							
250	Hx 250 Lc	83>	0010							
250	Nexus 250 Eu3	06>07	2620		2620		2623 2623			



PASTIGLIE FRENO RMS - SINTER (RICERCA PER MARCA)

RMS - SINTER BRAKE PADS (SEARCH BY BRAND)

CC	MODELLO MODEL	ANNO YEAR								
			ANTERIORE FRONT		POSTERIORE REAR		ANTERIORE FRONT	POSTERIORE REAR		
			PASTIGLIA ORGANICA ORGANIC				PASTIGLIA SINTERIZZATA SINTERED			
			22 510	22 512	22 510	22 512	22 510	22 510	22 510	22 510
250	Nexus 250 Sp Eu3	06>07	2620		2620		2623	2623		
250	Ngr 250	85>			0010			0013		
250	Rc 250 Rally	87>	0060		0010		0063	0013		
250	Rx 250 Arizona Rally	86>	0010				0013			
300	Nexus 300 Eu3	08>	2620		2620		2623	2623		
350	Dakota 350	86>	0060				0063			
350	Er 350	87>	0060				0063			
350	Xrt 350	90>	0060		0010		0063	0013		
500	Dakota 500	87>	0060				0063			
500	Er 500	87>	0060				0063			
500	Fuoco 500	07>08	0300		2620		0303	2623		
500	Nexus 500	03>05	0430		0490			0493		
500	Nexus 500 Eu3	06>08	0430		0490			0493		
500	Nexus 500 Sp Eu3	06>07	0430		0490			0493		
500	Saturno 500 Piuma	90>	0520		0010		0523	0013		
600	Rc 600	89>90			2730	1430				
600	Rc 600	91>			2730	1430				
600	Rc 600 Nordwest	90>	0530				0533			
600	Rc 600 R	91>			2730	1430				
600	Rc 600 Top Rally	90>			2730	1430				
600	Supersport 600	02>	2860		0490		2863	0493		
600	Xrt 600	88>	0060		0010		0063	0013		
800	Gp 800	08>	0430		2620			2623		
HARLEY DAVIDSON										
500	Xg Street	14					3403	3403		
750	Xg Street	15					3403	3403		
883	XL C Sportster Custom	04>13					3383	3393		
883	XL L Sportsler Low	06>13					3383	3393		
883	XL L Super Low	11>13					3383	3393		
883	XL N Iron	13					3383	3393		
883	XL R Roadster	10>13					3383	3393		
883	XL R Sportster	00>03					3373	3373		
883	XL Sportster	04>13					3383	3393		
883	XL Sportster R	05>13					3383	3393		
883	XL Sprtster Custom	00>03					3373	3373		
883	XLh Sportster	00>03					3373	3373		
883	XLh Sportster Hugger	00>03					3373	3373		
1130	Vrsca V-Road	02>05					3373	3373		
1130	Vrsca V-Rod	06					3423	3423		
1130	Vrscb V-Road	04					3373	3373		
1130	Vrscd Night Rod	06					3423	3423		
1130	Vrscr Street Rod	06					3423	3423		
1200	N Nightster	07					3383	3393		
1200	X Forty-Eight	11>13					3383	3393		
1200	XL C Sportster Custom	04					3383	3393		
1200	XL L Sportster Low	07					3383	3393		
1200	XL R Sportster Roadster	04					3383	3393		
1200	XL Sportster Custom	00>03					3373	3373		
1200	XL Sportster Sport	00>03					3373	3373		
1200	XL V Seventy-Two	11>13					3383	3393		
1200	XLh Sportster	00>03					3373	3373		
1200	Xr	08						3393		

Con Piastra - With Plate

PASTIGLIE FRENO RMS - SINTER (RICERCA PER MARCA)

RMS - SINTER BRAKE PADS (SEARCH BY BRAND)



















CC	MODELLO MODEL	ANNO YEAR	RMS YOUR BEST PARTNER				SINTER			
			 ANTERIORE FRONT		 POSTERIORE REAR		 ANTERIORE FRONT	 POSTERIORE REAR		
			PASTIGLIA ORGANICA ORGANIC				PASTIGLIA SINTERIZZATA SINTERED			
			 OMOLOGATA HOMOLOGATED	 NON OMOLOGATA NOT HOMOLOGATED	 GANASCE BRAKE SHOES	 OMOLOGATA HOMOLOGATED	 NON OMOLOGATA NOT HOMOLOGATED	 GANASCE BRAKE SHOES		
			22 510		22 512		22 510		22 512	
1200	Xr X	10					3413	3393		
1250	Vrscaw V-Rod	08					3423	3423		
1250	Vrscdx Night Rod Special	08					3423	3423		
1250	Vrscf Muscle	09					3423	3423		
1250	Vrscx V-Rod	08					3423	3423		
1450	Flhr/I Road King	00>06					3373	3373		
1450	Flhrci Road King Classic	00>04					3373	3373		
1450	Flhrci Road King Classic	05>06					3373	3373		
1450	Flhrs/I Road King Custom	04					3373	3373		
1450	Flhrs/I Road King Custom	05>06					3373	3373		
1450	Flht/I Electra Glide Standard	00>04					3373	3373		
1450	Flht/I Electra Glide Standard	05>06					3373	3373		
1450	Flhtc/I Electra Glide Standard	00>06					3373	3373		
1450	Flhtcui Ultra Classic Electra Glide	00>04					3373	3373		
1450	Flhtcui Ultra Classic Electra Glide	05>06					3373	3373		
1450	Flhxi Street Glide	06					3373	3373		
1450	Flsfti Fat Boy	06					3373	3373		
1450	Flstc Softail	06>07					3373	3373		
1450	Flstc/I Heritage Softail Classic	00>04					3373	3373		
1450	Flstci Softail	06					3373	3373		
1450	Flstf Fat Boy	06>07					3373	3373		
1450	Flstf/I Fat Boy	00>04					3373	3373		
1450	Flsti Heritage Softail	06					3373	3363		
1450	Flstn/I Softail Deluxe	06					3373	3373		
1450	Flsts/I Heritage Springer	00>03						3373		
1450	Flstsc/I Springer Softail Classic	06						3373		
1450	Fltr/I Road Glide Classic	00>06					3373	3373		
1450	Fxd Dyna Super Glide	00>03					3373	3373		
1450	Fxdbidyna Street Bob	06					3373	3373		
1450	Fxdc/I Dyna Super Glide Custom	05>06					3373	3373		
1450	Fxdi 35Th Anniversary Super Glide	06					3373	3363		
1450	Fxdi Dyna Super Glide	04					3373	3373		
1450	Fxdi Dyna Super Glide	05>06					3373	3373		
1450	Fxdl Dyna Low Rider	00>03					3373	3373		
1450	Fxdli Dyna Low Rider	04					3373	3373		
1450	Fxdli Dyna Low Rider	05>06					3373	3373		
1450	Fxds Dyna Convertible	00>02					3373	3373		
1450	Fxdwg Dyna Wide Glide	00>03					3373	3373		
1450	Fxdwgi Dyna Wide Glide	04					3373	3373		
1450	Fxdwgi Dyna Wide Glide	05>06					3373	3373		
1450	Fxdx Dyna Super Glide Sport	00>03					3373	3373		
1450	Fxdxi Dyna Super Glide Sport	04					3373	3373		
1450	Fxdxi Dyna Super Glide Sport	05>06					3373	3373		
1450	Fxdxt Dyna Super Glide T-Sport	00>03					3373	3373		
1450	Fxst/I Softail Standard	00>04					3373	3373		
1450	Fxst/I Softail Standard	05					3373	3373		
1450	Fxst/I Softail Standard	06					3373	3363		
1450	Fxstb/I Night Train	06					3373	3363		
1450	Fxstb/I Night Train	00>04					3373	3373		
1450	Fxstb/I Night Train	05					3373	3373		
1450	Fxstd/I Softail Deuce	00>04					3373	3373		
1450	Fxstd/I Softail Deuce	05					3373	3373		

□ Con Piastra - With Plate



PASTIGLIE FRENO RMS - SINTER (RICERCA PER MARCA)

RMS - SINTER BRAKE PADS (SEARCH BY BRAND)

CC	MODELLO MODEL	ANNO YEAR	 YOUR BEST PARTNER							
			 ANTERIORE FRONT		 POSTERIORE REAR		 ANTERIORE FRONT	 POSTERIORE REAR		
			 PASTIGLIA ORGANICA ORGANIC				 PASTIGLIA SINTERIZZATA SINTERED			
			 OMOLOGATA HOMOLOGATED	 NON OMOLOGATA NOT HOMOLOGATED	 GANASCE BRAKE SHOES	 OMOLOGATA HOMOLOGATED	 NON OMOLOGATA NOT HOMOLOGATED	 GANASCE BRAKE SHOES		
			22 510		22 512		22 510		22 512	
1450	Fxstd/I Softail Deuce	06					3373	3363		
1450	Fxsts/I Softail	05						3373		
1450	Fxsts/I Softail	06						3363		
1450	Fxsts/I Springer Softail	00>04						3373		
1584	Flhr Road King	07					3373	3373		
1584	Flhr Road King	08>10					3423	3423		
1584	Flhrc Road King Classic	07					3373	3373		
1584	Flhrc Road King Classic	08					3423	3423		
1584	Flhrs Road King Custom	07					3373	3373		
1584	Flht Electra Glide Standard	07					3373	3373		
1584	Flht Electra Glide Standard	08					3423	3423		
1584	Flhtc Electra Glide Classic	07					3373	3373		
1584	Flhtc Electra Glide Classic	08					3423	3423		
1584	Flhtci Ultra Electra Glide Classic	08					3423	3423		
1584	Flhtcui Ultra Classic Electra Glide	07>10					3373	3373		
1584	Flhtk Electra Glide Ultra Ltd	10					3423	3423		
1584	Flhx Street Glide	08					3423	3423		
1584	Flhxi Street Glide	07					3373	3373		
1584	Flstc Heritage Softail Classic	06						3363		
1584	Flstc Heritage Softail Classic	07					3373	-		
1584	Flstf Fat Boy	07					3373	3363		
1584	Flstn Softail Deluxe	07					3373	3363		
1584	Flstsc/I Softail	07						3363		
1584	Fltr Road Glide	08					3423	3423		
1584	Fltru Road Glide Ultra	11					3423	3423		
1584	Fltrx Road Glide Custom	10					3423	3423		
1584	Fxd Dyna Super Glide	07					3373	3373		
1584	Fxdb Dyna Street Bob	07					3373	3373		
1584	Fxdc Dyna Super Glide Custom	07					3373	3373		
1584	Fxdwg Dyna Wide Glide	07					3373	3373		
1584	Fxkl Dyna Low Rider	07					3373	3373		
1584	Fxst Softail Standard	07					3373	3363		
1584	Fxstb Night Train	07					3373	3363		
1584	Fxstc Softail Custom	07					3373	3363		
1584	Fxstd Softail Deuce	07					3373	3363		
1690	Flhr Road King	11					3423	3423		
1690	Flhtcu Ultra Classic Electra Glide	11					3423	3423		
1690	Flhtcul Electra Glide Ultra Classic Low	15					3423	3423		
1690	Flhtcutg Tri Glide Ultra Classic Trike	09>13					3423	-		
1690	Flhtk Ultra Classic Glide	10					3423	3423		
1690	Flhtkl Ultra Limited Low	15					3423	3423		
1690	Flhx Street Glide	11					3423	3423		
1690	Flhxs Street Glide Special	14					3423	3423		
1690	Flhxxx Street Glide Trike	10					3423	-		
1690	Fltrx Road Glide Custom	15					3423	3423		
1690	Fltrxs Road Glide Special	15					3423	3423		
1802	Flhrse Cvo Road King	14					3423	3423		
1802	Flhtkse Cvo Limited	14					3423	3423		
1802	Flhxsecvo Street Glide	10					3423	3423		
1802	Fltruse Cvo Road Glide Ultra	11					3423	3423		
1584	Flstc Heritage Softail Classic	08					3433	3353		
1584	Flstf Fat Boy	08					3433	3353		

Con Piastra - With Plate

PASTIGLIE FRENO RMS - SINTER (RICERCA PER MARCA)

RMS - SINTER BRAKE PADS (SEARCH BY BRAND)



CC	MODELLO MODEL	ANNO YEAR	RMS YOUR BEST PARTNER				SINTER			
			 ANTERIORE FRONT		 POSTERIORE REAR		 ANTERIORE FRONT	 POSTERIORE REAR		
			PASTIGLIA ORGANICA ORGANIC				PASTIGLIA SINTERIZZATA SINTERED			
			 OMOLOGATA HOMOLOGATED	 NON OMOLOGATA NOT HOMOLOGATED	 GANASCE BRAKE SHOES	 OMOLOGATA HOMOLOGATED	 NON OMOLOGATA NOT HOMOLOGATED	 GANASCE BRAKE SHOES		
			22 510		22 512		22 510		22 512	
1584	Flstfb Fat Boy Special	10					3433	3353		
1584	Flstn Softail Deluxe	08					3433	3353		
1584	Fxcw Rocker	08					3433	3353		
1584	Fxcwc Rocker C	08					3433	3353		
1584	Fxd Dyana Super Glide	08					3433	3353		
1584	Fxdb Dyana Street Bob	08>13					3433	3353		
1584	Fxdc Dyana Super Glide Custom	08					3433	3353		
1584	Fxdf Fat Bob	08					3433	3353		
1584	Fxdl Dyana Low Rider	08					3433	3353		
1584	Fxdwg Dyna Wide Glide	08					3433	3353		
1584	Fxst Softail Standard	08					3433	3353		
1584	Fxstb Night Train	08					3433	3353		
1584	Fxstc Softail Custom	08					3433	3353		
1690	Fld Switchback	12					3433	3353		
1690	Flhrc Road King Classic	11					3433	3353		
1690	Flhtc Electra Glide Classic	11					3433	3353		
1690	Flhtk Ultra Electra Glide	11					3433	3353		
1690	Fls Softail Slim	12					3433	3353		
1690	Flstc Heritage Softail Classic	12					3433	3353		
1690	Flstf Fat Boy	12					3433	3353		
1690	Flstf Fat Boy Special	12					3433	3353		
1690	Flstfb Fat Boy	12					3433	3353		
1690	Flstn Softail Deluxe	12					3433	3353		
1690	Fxdb Dyana Street Bob	14					3433	3353		
1690	Fxdba Street Bob	13					3433	3353		
1690	Fxdbb Street Bob	14					3433	3353		
1690	Fxdbp Street Bob	13					3433	3353		
1690	Fxdc Dyana Super Glide Custom	14					3433	3353		
1690	Fxdf Fat Bob	12					3433	3353		
1690	Fxdf Wide Glide	12					3433	3353		
1690	Fxdl Low Rider	14					3433	3353		
1690	Fxs Blackline	13					3433	3353		
1690	Fxs Breakout	14					3433	3353		
1802	Flstnse Cvo Softail Deluxe	14					3433	3353		
1802	Fxsbsc Cvo Breakout	13					3433	3353		
HERCULES										
50	Gipsy 50	93>		0190			0193			
80	Lotus 80 Sw	-		0010			0013			
80	Samba Sr 80	93>		2630			2633			
125	Samba Sr 125	93>		2630			2633			
HIGHLAND										
450	Mx 450	06>		0430		1330		1333		
950	V2 950 Motard	00>		0430		1330		1333		
950	V2 950 Outback	99>		0430		1330		1333		
HONDA										
50	Crn 50	88>92		1440						
50	Crn 50	93>		1440		2630		2633		
50	G-Dash 50	89>		1440			0070			
50	Gp 50 Dio	91>		3240	0140		0070			
50	Life Dio	94>				0070	0070			
50	Mb 50	82>		1440						
50	Mbx 50 Sd - Sf	83>		2590			2593			

□ Con Piastra - With Plate



PASTIGLIE FRENO RMS - SINTER (RICERCA PER MARCA)

RMS - SINTER BRAKE PADS (SEARCH BY BRAND)

CC	MODELLO MODEL	ANNO YEAR	RMS YOUR BEST PARTNER				SINTER			
			ANTERIORE FRONT		POSTERIORE REAR		ANTERIORE FRONT	POSTERIORE REAR		
			PASTIGLIA ORGANICA ORGANIC				PASTIGLIA SINTERIZZATA SINTERED			
			22 510	22 512	22 510	22 512	22 510	22 510		
50	Nh 50 Lead	94>	2630				2633			
50	Nsr 50	93>94	2590				2593			
50	Nsr 50	94>	1070				1073			
50	Nsr 50 (Spagna)	-	2590		2630		2593	2633		
50	Pk Wallaroo - Dx St	90>		0070		0091				
50	Sa Vision	88>93		0070		0091				
50	Sfx 50	95>	0190			0091	0193			
50	Sh 50 Fifty	97>	0190				0193			
50	Sh City Express	84>		0091		0080				
50	Sh Scoopy	88>94		0080		0080				
50	Sj 50 Bali	93>	0060				0063			
50	Sky 50	97>	0190				0193			
50	Sky 50 Vetro	00>	0190				0193			
50	Sr 50 Dio	90>	3240	0140						
50	Sr 50 Life Dio	94>	3240	0140						
50	Super Dio 50 Sr	91>92	3240	0140						
50	Super Dio 50 Zx	92>	3240	0140						
50	Sxr 50	97>	0190				0193			
50	X8r 50 S	98>	0190			9175	0193			
50	X8r 50 X	98>	0190			9175	0193			
50	Xr 50 Dio Baja	94>	3240	0140		0070				
50	Zx 50 Life Dio	94>	3240	0140		0070				
50	Zx Dio 50	95>	3240	0140						
75	Crm 75	90>			2630			2633		
75	Crm 75 R	90>			2630			2633		
75	Ns-1 75	92>	0350				0353			
75	Nsr 75 Fii	88>	2590				2593			
75	Yupy 75	91>	2630				2633			
80	Cr 80 R	87>91	2850				2853			
80	Cr 80 R	92>	2850		2630		2853	2633		
80	Cre 80	98>	2850		2630		2853	2633		
80	Crm 80	88>92	1440							
80	Crm 80	93>	1440		2630			2633		
80	Lead	86>	3440	1650						
80	Mb 80	80>	0040							
80	Mbx 80	82>	2590				2593			
80	Mbx 80 (Espana)	84>	2590				2593			
80	Mbx 80 Dx	82>	2590				2593			
80	Mbx 80 Fwd	83>	1440							
80	Mbx 80 Volluerkleidung	85>	2590				2593			
80	Mcx 80 All Models	82>	0040							
80	Nsr 80 R	87>92	2590		2630		2593	2633		
80	Nsr 80 R	93>	1070		2630		1073	2633		
85	Cr 85	03>07	2850		2630		2853	2633		
90	Srx 90 Shadow	99>	2630				2633			
90	Yupy 90 (Nh 90)	90>	2630				2633			
100	100 Lead	00>	0270				0273			
100	Sh 100	97>	0190				0193			
100	Sj 100 Bali - Ex	98>	0060				0063			
100	Supra 100	99>	1070				1073			
110	Scv 110	08>	0270				0273			
125	Anf 125 Innova	03>11	2820				2823			

Con Piastra - With Plate

PASTIGLIE FRENO RMS - SINTER (RICERCA PER MARCA)

RMS - SINTER BRAKE PADS (SEARCH BY BRAND)















CC	MODELLO MODEL	ANNO YEAR	RMS YOUR BEST PARTNER				SINTER			
			ANTERIORE FRONT		POSTERIORE REAR		ANTERIORE FRONT	POSTERIORE REAR		
			PASTIGLIA ORGANICA ORGANIC				PASTIGLIA SINTERIZZATA SINTERED			
			OMOLOGATA HOMOLOGATED	NON OMOLOGATA NOT HOMOLOGATED	GANASCE BRAKE SHOES	OMOLOGATA HOMOLOGATED	NON OMOLOGATA NOT HOMOLOGATED	GANASCE BRAKE SHOES		
			22 510	22 512	22 510	22 512	22 510	22 510		
125	Ca 125 Rebel	95>97	0580				0583			
125	Ca 125 Rebel	98>	0060				0063			
125	Cb 125 Rs	83>	1440							
125	Cbf 125	09>12	2820				2823			
125	Cbr 125 R	04>07	2820				2823			
125	Cbr 125 R	08>12	2820				2823			
125	Cg 125	04>	1440							
125	Ch 125 Spacy	94>	0270				0273			
125	Clr 125 City Fly	99>	0060				0063			
125	Cr 125	02>	0920		0660		0923	0663		
125	Cr 125	95>01	0920		2630		0923	2633		
125	Cr 125 Rh - J - K - L	87>94			2630			2633		
125	Cr 125 Supermotard	00>	0920		2630		0923	2633		
125	Cre 125	02>	0920		0660		0923	0663		
125	Cre 125	96>01	0920		2630		0923	2633		
125	Crn 125	90>			2630			2633		
125	Crn 125 (Italy)	90>	0060				0063			
125	Crn 125 X Supermotard	07>			0660			0663		
125	Dylan 125	01>	0270			0471	0273			
125	Fes 125 Pantheon	03>	0340		2610		0343	2613		
125	Fes 125 Pantheon	98>02	0970			0410	0973			
125	Fes 125 S-Wing	08>	2540	2550 □	2560	2570 □	2543	2563		
125	Fs 125 Sonic	03>	2590				2593			
125	Mbx 125 Rwb	84>	2590				2593			
125	Mtx 125 R	87>	0060				0063			
125	Mtx 125 Rii	89>	0060				0063			
125	Nes 125 @	00>	0270			0471	0273			
125	Nes 125 @	09>	2540	2550 □	2560	2570 □	2543	2563		
125	Ns 125 F All Models	85>	0060				0063			
125	Nsr 125	88>	0060				0063			
125	Nsr 125 R - F	89>	0060				0063			
125	Nsr 125 Raiden	90>	0060				0063			
125	Nx 125 (Italy)	90>	0060				0063			
125	Pcx 125	10>	2780			0471				
125	Psi 125	02>	0270				0273			
125	Rs 125 R	88>	3170				3173			
125	Rs 125 R	91>94	0870				0873			
125	Rs 125 R	95>			1440		3103			
125	Sh 125	00>09	0270			0471	0273			
125	Sh 125 I	09>	2540	2550 □	2560	2570 □	2543	2563		
125	Tur/MI 125 (Brasil)	-	3240	0140						
125	Vt 125 C - C2 Shadow	99>	0350				0353			
125	XI 125 L Paris Dakar	89>	0060				0063			
125	XI 125 Paris Dakar	89>	0060				0063			
125	XI 125 R	87>	0060				0063			
125	Xlr 125	93>	0920		2630		0923	2633		
125	Xlr 125 R	98>	0920		2630		0923	2633		
125	Xlv 125 Varadero	01>	0350				0353			
125	Xr 125 L	03>	0920				0923			
125	Msx	14			3280			3283		
150	Cbr R 150	00>03	2820				2823			
150	Cg 150	04>	1440							

□ Con Piastra - With Plate



PASTIGLIE FRENO RMS - SINTER (RICERCA PER MARCA)

RMS - SINTER BRAKE PADS (SEARCH BY BRAND)

CC	MODELLO MODEL	ANNO YEAR	 YOUR BEST PARTNER					
			 ANTERIORE FRONT		 POSTERIORE REAR		 ANTERIORE FRONT	 POSTERIORE REAR
			PASTIGLIA ORGANICA ORGANIC				PASTIGLIA SINTERIZZATA SINTERED	
								
			OMOLOGATA HOMOLOGATED	NON OMOLOGATA NOT HOMOLOGATED	GANASCE BRAKE SHOES	OMOLOGATA HOMOLOGATED	NON OMOLOGATA NOT HOMOLOGATED	GANASCE BRAKE SHOES
22 510		22 512	22 510		22512	22 510	22 510	
150	Crf 150	07>08	2850		0660		2853	0663
150	Fes 150 Pantheon	03>	0340		2610		0343	2613
150	Fes 150 Pantheon	98>02	0970			0410	0973	
150	Fes 150 S-Wing	08>	2540	2550 □	2560	2570 □	2543	2563
150	Nes 150 @	00>	0270			0471	0273	
150	Nes 150 @	09>	2540	2550 □	2560	2570 □	2543	2563
150	Nx 150 (Brasil)	-	0920				0923	
150	Pcx 150	10>	2780			0471		
150	Psi 150	02>	0270				0273	
150	Psi 150	06>	0270			0471	0273	
150	Ses 150 Dylan	01>	0270			0471	0273	
150	Sh 150	00>09	0270			0471	0273	
150	Sh 150 I	09>	2540	2550 □	2560	2570 □	2543	2563
200	Ctx 200	04>	0920				0923	
200	Mtx 200 R	87>	0060				0063	
200	Nx 200 (Brasil)	-	0920				0923	
200	Strada 200 (Brasil)	-	3240	0140				
200	Xl 200 R	85>	0060				0063	
200	Xlr 200 R	93>	0920		2630		0923	2633
200	Xr 200 (Brasil)	-	0920				0923	
230	Crf 230 Easy	04>	0920				0923	
230	Crf 230 Easy (Rear Disc)	04>	0920		2630		0923	2633
250	Cb 250	88>91	3170				3173	
250	Cb 250 Ft Hornet	96>			2610			2613
250	Cb 250 Night Hawk	91>	0870				0873	
250	Cb 250 Rebel	86>	2590				2593	
250	Cbf 250	04>	0350				0353	
250	Cbr 250 R	11>	0870				0873	
250	Cbr 250 R - Rr	90>			2610			2613
250	Cbr 250 R Abs	11>	2540	2550 □			2543	
250	Cbr 250 R Hurricane	86>88			2610			2613
250	Cmx 250 C Rebel	96>	0580				0583	
250	Cn	95>99	2640			0400		
250	Cn	97>94	2640			0400		
250	Cota 250 4Rt	05>	0640		0650			
250	Cr 250	02>	0920		0660		0923	0663
250	Cr 250	95>01	0920		2630		0923	2633
250	Cr 250 R	87>94			2630			2633
250	Cr 250 Supermotard	00>	0920		2630		0923	2633
250	Cre 250	02>	0920		0660		0923	0663
250	Crf 250 F	04>	0920		0660		0923	0663
250	Crf 250 R	04>09	0920		0660		0923	0663
250	Crf 250 R Efi	10>	0920		0660		0923	0663
250	Crf 250 X	04>	0920		0660		0923	0663
250	Crn 250 R	89>90			2630			2633
250	Crn 250 R	91>	0920		2630		0923	2633
250	Crn 250 X Supermotard	07>			0660			0663
250	Crf L	13					3343	
250	Crn M	14					3343	
250	Fe 250 Foresight	97>98	0970			0410	0973	
250	Fe 250 Foresight	99>	0340		2610		0343	2613
250	Forza 250	00>04	0970		0930		0973	0933

□ Con Piastra - With Plate

PASTIGLIE FRENO RMS - SINTER (RICERCA PER MARCA)

RMS - SINTER BRAKE PADS (SEARCH BY BRAND)

















CC	MODELLO MODEL	ANNO YEAR	RMS YOUR BEST PARTNER				SINTER			
			 ANTERIORE FRONT		 POSTERIORE REAR		 ANTERIORE FRONT	 POSTERIORE REAR		
			PASTIGLIA ORGANICA ORGANIC				PASTIGLIA SINTERIZZATA SINTERED			
			 OMOLOGATA HOMOLOGATED	 NON OMOLOGATA NOT HOMOLOGATED	 GANASCE BRAKE SHOES	 OMOLOGATA HOMOLOGATED	 NON OMOLOGATA NOT HOMOLOGATED	 GANASCE BRAKE SHOES		
			22 510	22 512	22 510	22 512	22 510	22 510		
250	Forza 250	05>	2540	2550 □	2560	2570 □	2543	2563		
250	Freeway	85>	0270				0400			
250	Fusion	85>	0270				0400			
250	Jade 250	91>	0870		2610		0873	2613		
250	Jazz 250	01>04	0970		0930		0973	0933		
250	Jazz 250	05>	2540	2550 □	2560	2570 □	2543	2563		
250	Nsr 250 R - Sp	88>93			2610			2613		
250	Nsr 250 R Se-Sp	94>					3103			
250	Nss 250	00>04	0970		0930		0973	0933		
250	Nss 250	05>	2540	2550 □	2560	2570 □	2543	2563		
250	Nx 250 Dominator	93>	0920				0923			
250	Ps 250	05>	2540	2550 □			2543			
250	Reflex 250	00>	0970		0930		0973	0933		
250	Rs 250	93>			1440		3103			
250	Rs 250 R	91>			2610			2613		
250	Rs 250 R	95>			1440					
250	Vt 250 Cr Magna	94>	0870				0873			
250	Vt 250 Spada	88>	0870		2610		0873	2613		
250	Vtr 250	98>	0870		0930		0873	0933		
250	Vtz 250	88>	3170				3173			
250	Vtz 250 Xelvis	92>	0870				0873			
250	XI 250	90>			2630			2633		
250	XI 250 Degree	91>	0920				0923			
250	Xlr 250 R	91>	0920		2630		0923	2633		
250	Xlr 250 R Baja	91>	0920		2630		0923	2633		
250	Xr 250 L	91>	0920		2630		0923	2633		
250	Xr 250 R	88>93			2630			2633		
250	Xr 250 R	94>	0920		2630		0923	2633		
250	Crf L	14			3280			3283		
250	Cbr R Abs (Nissin)	11-13						3323		
260	Cre 260	90>			2630			2633		
300	Cb 300	10>	0350				0353			
300	Sh 300 i	07>	2540	2550 □	2560	2570 □	2543	2563		
300	Sh 300 i Abs	07>	2540	2550 □	2560	2570 □	2543	2563		
300	Cbr F	14						3323		
350	Nx 350 Sahara (Brasil)	-	0920				0923			
400	Cb 400 Fk (Cb-1)	90>	0870		2610		0873	2613		
400	Cb 400 Super Four	92>	0870		2610		0873	2613		
400	Cb 400 Super Four (Sf)	99>					2913	3113		
400	Cb-1400 F	89>	0870		2610		0873	2613		
400	Cbr 400 R R	88>93	0870		2610		0873	2613		
400	Fjs 400 Silver Wing	06>	0340		2640	0890	0343	2643		
400	Fjs 400 Silver Wing (Freno A Mano)	06>	1440							
400	Ntv 400 Bros	88>			2610			2613		
400	Rvf 400	94>					3103			
400	Sw-T 400	09>	2540	2550 □	2640	0890	2543	2643		
400	Sw-T 400 Abs	09>	2540	2550 □	2640	0890	2543	2643		
400	Transalp 400	92>	3170				3173			
400	Transalp 400	92>			2610			2613		
400	Vfr 400 R	87>89			2610			2613		
400	Vfr 400 R (Nc 30)	91>					3103			
400	Xr 400	96>	0920		2630		0923	2633		

□ Con Piastra - With Plate



PASTIGLIE FRENO RMS - SINTER (RICERCA PER MARCA)

RMS - SINTER BRAKE PADS (SEARCH BY BRAND)

CC	MODELLO MODEL	ANNO YEAR	 YOUR BEST PARTNER						
			 ANTERIORE FRONT		 POSTERIORE REAR		 ANTERIORE FRONT	 POSTERIORE REAR	
			PASTIGLIA ORGANICA ORGANIC				PASTIGLIA SINTERIZZATA SINTERED		
									
			OMOLOGATA HOMOLOGATED	NON OMOLOGATA NOT HOMOLOGATED	GANASCE BRAKE SHOES	OMOLOGATA HOMOLOGATED	NON OMOLOGATA NOT HOMOLOGATED	GANASCE BRAKE SHOES	
22 510		22 512	22 510		22512	22 510	22 510		
400	Xr 400 Supermotard	00>	0920			2630		0923	2633
440	Xr 440 R (Dall'ara)	99>	0920			2630		0923	2633
450	Cre 450	02>	0920			0660		0923	0663
450	Crf 450 Efi	09>	0920			0660		0923	0663
450	Crf 450 R - E	02>	0920			0660		0923	0663
450	Crf 450 X	05>	0920			0660		0923	0663
450	Crm 450 X Supermotard	07>				0660			0663
490	Cre 490 X ie	09>	0920			0660		0923	0663
490	Crf 490 R ie	09>	0920			0660		0923	0663
500	Cb 500 R/T	94>	0870					0873	
500	Cb 500 S	99>	1010			1330		1013	1333
500	Cb 500 V	97>	1010			1330		1013	1333
500	Cbf 500	04>	0870			0930		0873	0933
500	Cbf 500 Abs	04>	2540	2550 □		0930		2543	0933
500	Cr 500 R	87>93				2630			2633
500	Cr 500 R	96>01	0920			2630		0923	2633
500	Crm 500 X Supermotard	07>				0660			0663
500	Nx 500 Dominator	88>96				2610			2613
500	Nx 500 Dominator	97>	1010			1330		1013	1333
500	Cb F	13							3323
500	Cb X	13							3323
500	Cbr R	14							3323
600	Cb 600 F Hornet	07>	0870					0873	2933
600	Cb 600 F Hornet	98>06	0870			0930		0873	0933
600	Cb 600 F Hornet (Japan)	98>				0930		2913	0933
600	Cb 600 F Hornet Abs	07>	2540	2550 □		0930		2543	0933
600	Cb 600 F Hornet S	04>	0870			0930		0873	0933
600	Cbf 600	04>07	0870			0930		0873	0933
600	Cbf 600 N	08>	2540	2550 □		0930		2543	0933
600	Cbf 600 S	08>	2540	2550 □		0930		2543	0933
600	Cbr 600 F	11>	0870					0873	2933
600	Cbr 600 F	95>98	0870			0930		0873	0933
600	Cbr 600 F	99>				0930		2913	0933
600	Cbr 600 F - Super Sport	91>94				0930			0933
600	Cbr 600 F Abs	11>	2540	2550 □				2543	2933
600	Cbr 600 F4 Sport	01>				0930		2913	0933
600	Cbr 600 Rr	03>04				0930		2913	0933
600	Cbr 600 Rr	05>06				0930		2953	0933
600	Cbr 600 Rr	07>						2953	2933
600	Cbr 600 Rr Abs	09>						2953	2933
600	Fjs 600 Silver Wing	01>	0340			2640	0890	0343	2643
600	Fjs 600 Silver Wing (Freno A Mano)	01>	1440						
600	Fsc 600 Silver Wing	01>	0340			2640	0890	0343	2643
600	Ntv 600 Bros	88>				2610			2613
600	Ntv 600 Revere	88>				2610			2613
600	Sw-T 600 Silver Wing	11>	2540	2550 □		2640	0890	2543	2643
600	Vt 600 C-Cd Shadow Vlx	94>	0870					0873	
600	Xl 600 V Transalp	91>93				2610			2613
600	Xl 600 V Transalp	94>96	0870			2610		0873	2613
600	Xl 600 V Transalp	97>	0920			2610		0923	2613
600	Xr 600 L - R	93>	0920			2630		0923	2633
600	Xr 600 R	91>				2630			2633

□ Con Piastra - With Plate

PASTIGLIE FRENO RMS - SINTER (RICERCA PER MARCA)

RMS - SINTER BRAKE PADS (SEARCH BY BRAND)



CC	MODELLO MODEL	ANNO YEAR	RMS YOUR BEST PARTNER				SINTER			
			 ANTERIORE FRONT		 POSTERIORE REAR		 ANTERIORE FRONT	 POSTERIORE REAR		
			PASTIGLIA ORGANICA ORGANIC				PASTIGLIA SINTERIZZATA SINTERED			
			 OMOLOGATA HOMOLOGATED	 NON OMOLOGATA NOT HOMOLOGATED	 GANASCE BRAKE SHOES	 OMOLOGATA HOMOLOGATED	 NON OMOLOGATA NOT HOMOLOGATED	 GANASCE BRAKE SHOES		
			22 510		22 512	22 510		22 512	22 510	22 510
650	Fmx 650	05>	0870		0870		0873	0873		
650	Nt 650 Hawk Gt	88>90	0870		2610		0873	2613		
650	Nt 650 V Deauville	02>05	0970		0340		0973	0343		
650	Nt 650 V Deauville	98>01	1010		2610		1013	2613		
650	Ntv 650 Bros	88>92			2610			2613		
650	Ntv 650 Deauville	98>01	1010		2610		1013	2613		
650	Ntv 650 Revere	93>97	0870		2610		0873	2613		
650	Ntv 650 V 2 Deauville	02>	0970		2610		0973	2613		
650	Nx 650 Dominator	93>94	3170				3173			
650	Nx 650 Dominator	88>96			2610			2613		
650	Nx 650 Dominator	93>94			2610			2613		
650	Nx 650 Dominator	97>	1010		1330		1013	1333		
650	Slr 650	97>	1010		1330		1013	1333		
650	Sx 650 Vigor	99>02	1010		1330		1013	1333		
650	Xl 650 V Transalp	99>	0920		2610		0923	2613		
650	Xr 650 L	93>95			2630			2633		
650	Xr 650 L	96>	0920		2630		0923	2633		
650	Xr 650 R	99>	0920		2630		0923	2633		
650	Xrv 650 Africa Twin	88>			2610			2613		
650	Cb F	14						3323		
650	Cbr F	14						3323		
670	Integra	12>	2540 2550 □				2543	2933		
680	Dn-01 680	08>	2540 2550 □		2640 0890		2543	2643		
700	Nt 700 Deauville Abs	06>	2540 2550 □		0970		2543	0973		
700	Nt 700 V Varadero - Abs	10>	2540 2550 □		0970		2543	0973		
700	Vfr 700 F/F2 Interceptor	86>87	3170				3173			
700	Vfr 700 F Interceptor	88>	0870		0870		0873	0873		
700	Xl 700 Transalp	08>	0920		2610		0923	2613		
700	Xl 700 Transalp Abs	08>	2540 2550 □		0930		2543	0933		
700	Ctx D Abs	14						3323		
700	Ctx N	14						3323		
700	Ctx Nd Abs	14						3323		
750	Cb 750 N Seven Fifty	92>	0870		0930		0873	0933		
750	Cbr 750 F	88>	0870		0870		0873	0873		
750	Cbr 750 Super Aero	88>						3103		
750	Magna 750	93>	0870				0873			
750	Rvf 750 Rr (Rc 45)	94>					3103			
750	Vf 750 C	93>	0870				0873			
750	Vfr 750 F	90>	0870		2640 0890		0873	2643		
750	Vfr 750 F Interceptor	88>89	2640 0890		2640 0890		2643	2643		
750	Vt 750 Black Window	01>	2640 0890				2643			
750	Vt 750 C Shadow	97>03	2640 0890				2643			
750	Vt 750 C2 Shadow A.c.e.	97>03	2640 0890				2643			
750	Vt 750 C2b	11>	0870				0873			
750	Vt 750 C4 Shadow	04>	2640 0890				2643			
750	Vt 750 Rs	11>	0870				0873			
750	Vt 750 S	11>	0870				0873			
750	Vt 750 Shadow Spirit	07>	0870				0873			
750	Xrv 750 R Africa Twin	90>93			2610			2613		
750	Xrv 750 R Africa Twin	94>	0920		2610		0923	2613		
800	800 Crossrunner	11>	2540 2550 □		3050		2543	3053		
800	Pc 800 Pacific Coast	88>	0870				0873			

□ Con Piastra - With Plate



PASTIGLIE FRENO RMS - SINTER (RICERCA PER MARCA)

RMS - SINTER BRAKE PADS (SEARCH BY BRAND)

CC	MODELLO MODEL	ANNO YEAR	RMS YOUR BEST PARTNER				SINTER			
			ANTERIORE FRONT		POSTERIORE REAR		ANTERIORE FRONT	POSTERIORE REAR		
			PASTIGLIA ORGANICA ORGANIC				PASTIGLIA SINTERIZZATA SINTERED			
			22 510	22 512	22 510	22 512	22 510	22 510		
800	Vfr 800	06>	2540	2550 □	0970		2543	0973		
800	Vfr 800 Abs	06>	2540	2550 □	0970		2543	0973		
800	Vfr 800 Fi	98>01	0970		0340		0973	0343		
800	Vfr 800 V-Tech	02>05	0970		0340		0973	0343		
800	Vfr 800 V-Tech Abs	02>05	0970		0340		0973	0343		
900	Cb 900 Hornet	01>			0930			0933		
900	Cbr 900 Rr Fireblade	94>97			0930			0933		
900	Cbr 900 Rr-Fireblade	92>93			0930			0933		
900	Cbr 900 Rr-Fireblade	98>			0930		2913	0933		
900	Cbr 900 Rr-Fireblade (954 Cc)	02>03			0930		2913	0933		
950	Vfr 950 F Carat	92>	0870		2640	0890	0873	2643		
1000	Cb 1000 R	08>			3050		2953	3053		
1000	Cb 1000 R Abs	08>	2540	2550 □	3050		2543	3053		
1000	Cb 1000 Sf	93>			0930		3103	0933		
1000	Cb 1000 Superfour (Big Four)	92>	0870		2640	0890	0873	2643		
1000	Cbf 1000	06>	2640	0890	0930		2643	0933		
1000	Cbf 1000 Abs	06>	2540	2550 □	2560	2570 □	2543	2543		
1000	Cbf 1000 Limited Edition	09>	2640	0890	0930		2643	0933		
1000	Cbf 1000 Limited Edition Abs	09>	2540	2550 □	2560	2570 □	2543	2543		
1000	Cbr 1000 Big One	93>			0930			0933		
1000	Cbr 1000 F	89>92	0870		0870		0873	0873		
1000	Cbr 1000 Rr	04>05			0930		2953	0933		
1000	Cbr 1000 Rr	06>08					2953	2933		
1000	Cbr 1000 Rr Abs	09>					2953	2933		
1000	Crf 1000 L Africa Twin	16>					3493			
1000	Vtr 1000 Fv Firestorm	97>99			0930			0933		
1000	Vtr 1000 Sp-1 Sp-2	00>			0930		2913	0933		
1000	Xl 1000 V Varadero	99>03	0970		0970		0973	0973		
1000	Xlv 1000 Varadero	04>	2540	2550 □	0340		2543	0343		
1000	Xlv 1000 Varadero Travel Abs	04>	2540	2550 □	0340		2543	0343		
1000	Cbr Rr	13					3333			
1100	1100 American Classic Edition	95>	0870		0930		0873	0933		
1100	Cb 1100 Hornet	99>	0970		0340		0973	0343		
1100	Cb 1100 Sf X Eleven (X11)	00>	0970		0340		0973	0343		
1100	Cbr 1100 Xx Blackbird	97>98	0970		0340		0973	0343		
1100	Cbr 1100 Xx Superblackbird	99>	0970		0340		0973	0343		
1100	St 1100 Abs-Tcs	92>	0870		0870		0873	0873		
1100	St 1100 Pan European	89>96	0870		0870		0873	0873		
1100	St 1100 Pan European	97>	0970		0340		0973	0343		
1100	Vt 1100 C Shadow	94>96	0870				0873			
1100	Vt 1100 C2 Shadow	95>	0870		0930		0873	0933		
1100	Vt 1100 C2 Y	00>	0870		0930		0873	0933		
1200	Gl Dx (Tutti I Modelli)			0330		0330				
1200	Vfr 1200 F	10>			3050			3053		
1300	Cb 1300	98>00						3113		
1300	Cb 1300 R	01>					2913	3113		
1300	Cb 1300 X4	97>						3113		
1300	Stx 1300 Pan European Abs	02>	0970		0340		0973	0343		
1300	Vt 1300 Fury	10>	0870		0930		0873	0933		
1300	Vt 1300 Fury Abs	10>	2540	2550 □	0970		2543	0973		
1300	Vtx 1300 C	04>	0870		0930		0873	0933		
1300	Vtx 1300 S	03>	0870		0930		0873	0933		

□ Con Piastra - With Plate

PASTIGLIE FRENO RMS - SINTER (RICERCA PER MARCA)

RMS - SINTER BRAKE PADS (SEARCH BY BRAND)



CC	MODELLO MODEL	ANNO YEAR	RMS YOUR BEST PARTNER				SINTER			
			 ANTERIORE FRONT		 POSTERIORE REAR		 ANTERIORE FRONT	 POSTERIORE REAR		
			PASTIGLIA ORGANICA ORGANIC				PASTIGLIA SINTERIZZATA SINTERED			
			 OMOLOGATA HOMOLOGATED	 NON OMOLOGATA NOT HOMOLOGATED	 GANASCE BRAKE SHOES	 OMOLOGATA HOMOLOGATED	 NON OMOLOGATA NOT HOMOLOGATED	 GANASCE BRAKE SHOES		
			22 510		22 512	22 510		22 512	22 510	22 510
1500	Gl 1500 F6c Valkyrie	97>	0870		2640	0890	0873	2643		
1800	Gl 1800 Gold Wing	01>	0970		0340		0973	0343		
1800	Vtx 1800	01>	0970		0340		0973	0343		
HONDA - HM										
50	Cre 50	06>	0360		2630		0363	2633		
50	Cre 50 (Da Telaio Nr.1001 A 2818)	-			0010			0013		
50	Cre 50 (Da Telaio Nr.2819)	-	0360				0363			
50	Cre 50 All Models	03>04	0360		2810		0363			
50	Cre 50 Baja - Derapage	01>02	0360		0080		0363	0083		
50	Cre 50 Six	95>02	0360		0080		0363	0083		
125	Cre 125	02>	0920		0660		0923	0663		
125	Cre 125	>01	0920		2630		0923	2633		
125	Cre 125 Supermotard	04>06	0920		0660		0923	0663		
125	Cre 125 Supermotard	>03	0920		2630		0923	2633		
125	Crn F 125 X Super Motard	07>			0660			0663		
250	Cre 250 F	04>	0920		0660		0923	0663		
250	Cre 250 Supermotard	04>	0920		0660		0923	0663		
250	Cre 250 Supermotard	>03	0920		2630		0923	2633		
250	Cre 250 X	04>	0920		0660		0923	0663		
250	Crf 250 Supermotard	04>	0920		0660		0923	0663		
250	Crn F 250 X ie Super Motard	07>			0660			0663		
290	Crn F 290 X ie Super Motard	07>			0660			0663		
450	Cre 450 F	02>	0920		0660		0923	0663		
450	Cre 450 X	04>	0920		0660		0923	0663		
450	Crn F 450 X ie Super Motard	07>			0660			0663		
490	Crn F 490 X ie Super Motard	07>			0660			0663		
HONDA ATV										
200	Atc 200 X	83>85	2850				2853			
200	Atc 200 X	86>87	2850		2850		2853	2853		
250	Atc 250 R	81>	1440					2853		
250	Atc 250 R	82>	1440		2850			2853		
250	Atc 250 R	83>84	2850		2850		2853	2853		
250	Trx 250 Ex Sportrax	01>	2850				2853			
250	Trx 250 X Fourtrax	87>92	2850		2850		2853	2853		
300	Trx 300 Ex Fourtrax	93>00	2850		2850		2853	2853		
350	Atc 350 X	85>			2850			2853		
350	Atc 350 X	86>			2850			2853		
400	Trx 400 Ex Foutrax	99>00	2850		2850		2853	2853		
400	Trx 400 Ex Sportrax	01>	2850		2850		2853	2853		
400	Trx 400 R	04>	0920				0923			
HONDA ITALIA										
125	Dt 125	87>	0060				0063			
125	Mtx 125 R	86>	0060				0063			
125	Mtx 125 Rally Sport	88>	0060				0063			
125	Ns 125 F	85>	0060				0063			
125	Ns 125 R Super Sport	87>	0060				0063			
125	Nsr 125 R	89>	0060				0063			
125	XI 125 L Paris Dakar	85>	0060				0063			
125	XI 125 R2	87>	0060				0063			
200	XI 200 L	85>	0060				0063			
200	XI 200 L Paris Dakar	87>	0060				0063			
200	XI 200 R2	87>	0060				0063			

□ Con Piastra - With Plate



PASTIGLIE FRENO RMS - SINTER (RICERCA PER MARCA)

RMS - SINTER BRAKE PADS (SEARCH BY BRAND)

CC	MODELLO MODEL	ANNO YEAR								
			 ANTERIORE FRONT		 POSTERIORE REAR		 ANTERIORE FRONT	 POSTERIORE REAR		
			PASTIGLIA ORGANICA ORGANIC				PASTIGLIA SINTERIZZATA SINTERED			
			 OMOLOGATA HOMOLOGATED	 NON OMOLOGATA NOT HOMOLOGATED	 GANASCE BRAKE SHOES	 OMOLOGATA HOMOLOGATED	 NON OMOLOGATA NOT HOMOLOGATED	 GANASCE BRAKE SHOES		
			22 510		22 512		22 510	22512	22 510	22 510
HOREX										
80	Rebell 80 T	86>	3150		3150		3153	3153		
80	Sport 80 L	86>	3150		3150		3153	3153		
125	Imperator 125	96>	3150				3153			
125	Regent 125	96>	3150				3153			
560	E 560	86>	3150		3150		3153	3153		
600	Columbus 600	87>	3150		3150		3153	3153		
HRD										
50	Gs 50 Enduro	00>02	0740		1330			1333		
50	Sonic 2 50 Supermotard	00>02	0740		0080			0083		
50	Sonic 2 50 Trail	00>02	0740		0080			0083		
125	Platino 125 St	86>	0010				0013			
125	Road 125 St	86>	0010				0013			
125	Supermotard 125	00>02	0740		0080			0083		
125	Trail 125	00>02	0740		0080			0083		
HSC										
50	Hsc 01 50	92>	3240	0140						
50	Sr 50 Dio	92>	3240	0140						
50	Zr 50	92>	3240	0140						
50	Zx 50 Dio	92>	3240	0140						
HUSABERG										
250	Te 250	11>	0430		0750			0753		
300	Te 300	11>	0430		0750			0753		
350	Fc 350	95>	0430		1330			1333		
350	Fe 350	95>	0430		1330			1333		
350	Mc 350	91>93			1200					
350	Mc 350	94>			1330			1333		
390	Fe 390	11>	0430		0750			0753		
400	Fc 400	99>02	0430		1330			1333		
400	Fe 400 S - E	98>03	0430		1330			1333		
400	Fs 400 E - C	01>03	1150		1330		1153	1333		
450	Fc 450	98>03	0430		1330			1333		
450	Fe 450	09>	0430		0750			0753		
450	Fe 450 E	04>	0430		1330			1333		
450	Fs 450 C	06>			1330			1333		
450	Fs 450 E - C	03>05	1150		1330		1153	1333		
450	Fx 450	03>	0430		1330			1333		
470	Fc 470 E	01>02	0430		1330			1333		
470	Fx 470 E	01>02	0430		1330			1333		
500	500 All Models	91>			1200					
501	501 Enduro	-			1200					
501	Fc 501	98>01	0430		1330			1333		
501	Fe 501 S - E	98>04	0430		1330			1333		
550	Fc 550	01>	0430		1330			1333		
550	Fe 550 E	04>	0430		1330			1333		
570	Fe 570	09>	0430		0750			0753		
600	600 Enduro	-			1200					
600	Ef 600 E (Quad)	98>	1330				1333			
600	Fc 600 Supermotard	98>01	0430		1330			1333		
600	Fe 600 S - E - R	98>02	0430		1330			1333		
650	Fe 650 E	01>	0430		1330			1333		
650	Fs 650 E - C	01>05	1150		1330		1153	1333		

Con Piastra - With Plate

PASTIGLIE FRENO RMS - SINTER (RICERCA PER MARCA)

RMS - SINTER BRAKE PADS (SEARCH BY BRAND)



CC	MODELLO MODEL	ANNO YEAR	RMS YOUR BEST PARTNER				SINTER			
			 ANTERIORE FRONT		 POSTERIORE REAR		 ANTERIORE FRONT	 POSTERIORE REAR		
			PASTIGLIA ORGANICA ORGANIC				PASTIGLIA SINTERIZZATA SINTERED			
			 OMOLOGATA HOMOLOGATED	 NON OMOLOGATA NOT HOMOLOGATED	 GANASCE BRAKE SHOES	 OMOLOGATA HOMOLOGATED	 NON OMOLOGATA NOT HOMOLOGATED	 GANASCE BRAKE SHOES		
			22 510		22 512	22 510		22 512	22 510	22 510
650	Fs 650 E - C	06>					1330	1333		
650	Fx 650 E	01>	0430			1330		1333		
HUSQVARNA										
50	Cr 50 Junior	06>	0650							
50	Cr 50 Pro Senjor	06>	0650			3220		3223		
50	Cr 50 Senjor	06>	0650			3220		3223		
50	Husqy Boy 50	01>	0080					0083		
50	Racing 50	98>	0080					0083		
50	Sm 50	02>	0740			0080		0083		
50	Sm 50	10>	0650			3220		3223		
50	Wr 50	02>	0740			0080		0083		
50	Wrs 50 (Scooter)	98>	0080				0083			
125	125 All Models 1992	92>	1420			1440		1423		
125	125 All Models 1993	93>	1420					1423		
125	125 All Models 1994-1995	94>95	0430			1330		1333		
125	Cr 125	85>95	0010				0013			
125	Cr 125	96>03	0430			1330		1333		
125	Cr 125	04>	0430			0750		0753		
125	Cr 125 Cross	91>95				1200				
125	Sm 125 Supermotard	98>	0430			1330		1333		
125	Wr 125	86>	0010				0013			
125	Wr 125	91>97				1200				
125	Wr 125	98>03	0430			1330		1333		
125	Wr 125	04>	0430			0750		0753		
125	Wre 125	04>	0430			0750		0753		
125	Wre 125 Dual	95>03	0430			1330		1333		
240	Wr 240	86>	0010				0013			
240	Wr 240	91>				1200				
250	250 All Models 1992	92>	1420			1440		1423		
250	250 All Models 1993	93>	1420					1423		
250	250 All Models 1994-1995	94>95	0430			1330		1333		
250	Cr 250	85>95	0010				0013			
250	Cr 250	96>03	0430			1330		1333		
250	Cr 250	04>	0430			0750		0753		
250	Cr 250 Cross	91>				1200				
250	Tc 250	02>03	0430			1330		1333		
250	Tc 250	04>	0430			0750		0753		
250	Te 250	02>03	0430			1330		1333		
250	Te 250	04>	0430			0750		0753		
250	Te 250 4T	10>	0430			0750		0753		
250	Wr 250	90>				1200				
250	Wr 250	91>97				1200				
250	Wr 250	04>	0430			0750		0753		
250	Wr 250 Enduro	98>03	0430			1330		1333		
260	Wr 260	91>				1200				
300	Wr 300	10>	0430			0750		0753		
310	Te 310 4T	10>	0430			0750		0753		
350	Te 350	90>95				1200				
350	Te 350	96>	0430			1330		1333		
360	Wr 360 Enduro	98>	0430			1330		1333		
400	Sm 400 Supermotard	02>	0520			1330	0523	1333		
400	Tc 400	02>	0430			1330		1333		



PASTIGLIE FRENO RMS - SINTER (RICERCA PER MARCA)

RMS - SINTER BRAKE PADS (SEARCH BY BRAND)

CC	MODELLO MODEL	ANNO YEAR	RMS YOUR BEST PARTNER				SINTER			
			ANTERIORE FRONT		POSTERIORE REAR		ANTERIORE FRONT	POSTERIORE REAR		
			PASTIGLIA ORGANICA ORGANIC				PASTIGLIA SINTERIZZATA SINTERED			
			22 510	22 512	22 510	22 512	22 510	22 510		
400	Te 400	01>	0430		1330		1333			
400	Te 400 E Dual - Enduro	98>	0430		1330		1333			
400	Wr 400	86>	0010			0013				
410	Te 410 E	00>	0430		1330		1333			
449	Smr 449	11>	2860		0750	2863	0753			
449	Tc 449	11>	0430		0750		0753			
449	Te 449	11>	0430		0750		0753			
450	Sm 450 R	03>04	0520		1330	0523	1333			
450	Sm 450 R	05>	2860		1330	2863	1333			
450	Tc 450	04>	0430		0750		0753			
450	Te 450	04>	0430		0750		0753			
500	Cr 500	85>	0010			0013				
510	Sm 510 R	05>	2860		1330	2863	1333			
510	Tc 510	04>	0430		0750		0753			
510	Te 510	90>			1200					
510	Te 510	04>	0430		0750		0753			
510	Te 510 C	04>	0430		0750		0753			
511	Smr 511	11>	2860		0750	2863	0753			
511	Te 511	11>	0430		0750		0753			
570	Nox 570	98>	1100		0430	1103				
570	R 570	01>	0520		1330	0523	1333			
570	Tc 570	01>	0430		1330		1333			
570	Te 570	01>03	0430		1330		1333			
570	Te 570	04>	0430		0750		0753			
600	Lt 600 Dual	98>	1100		0430	1103				
600	Sm 600 Supermotard	98>	1100		1330	1103	1333			
600	Te 600	96>	0430		1330		1333			
600	Te 600 E Dual - Enduro	98>	0430		1330		1333			
610	Lt 610	00>	1100		1330	1103	1333			
610	Sm 610	00>	1100		1330	1103	1333			
610	Sm 610 ie	07>	2860		0750	2863	0753			
610	Tc 610	96>	0430		1330		1333			
610	Tc 610 Cross	91>	1420		1440	1423				
610	Te 610	91>97	1420		1440	1423				
610	Te 610 E	99>03	0430		1330		1333			
610	Te 610 E	04>	0430		0750		0753			
610	Te 610 E Supermotard	00>	1100		1330	1103	1333			
630	Sm 630	10>	2860		0750	2863	0753			
630	Sm 630	>09	1100		1330	1103	1333			
630	Te 630	10>	0430		0750		0753			
650	Str 650 Crc	07>	2860		0750	2863	0753			
HYOSUNG										
50	Avanti 50	99>	2800							
50	Ga-4 50	99>	1490			1493				
50	Rush 50	97>	2800							
50	Sb 50	00>	2800							
50	Sd 50	00>	2800							
50	Sense 50	98>	2800							
50	Sf 50	99>	2800							
50	Super Cab 50	95>97	2800							
50	Super Cab 50 Plus	98>	2800							
100	Cab 100	98>	2800							

Con Piastra - With Plate

PASTIGLIE FRENO RMS - SINTER (RICERCA PER MARCA)

RMS - SINTER BRAKE PADS (SEARCH BY BRAND)



CC	MODELLO MODEL	ANNO YEAR	RMS YOUR BEST PARTNER				SINTER			
			ANTERIORE FRONT		POSTERIORE REAR		ANTERIORE FRONT	POSTERIORE REAR		
			PASTIGLIA ORGANICA ORGANIC				PASTIGLIA SINTERIZZATA SINTERED			
			OMOLOGATA HOMOLOGATED	NON OMOLOGATA NOT HOMOLOGATED	GANASCE BRAKE SHOES	OMOLOGATA HOMOLOGATED	NON OMOLOGATA NOT HOMOLOGATED	GANASCE BRAKE SHOES		
			22 510	22 512	22 510	22 512	22 510	22 510		
100	Ez 100	00>	2800							
110	Fx 110	02>	0040							
110	Kr 110 Master	04>	0040							
110	Midas 110 Plus	98>	2800							
125	Aquila 125	00>	1420			1423				
125	Boomer 125	03>	0190			0193				
125	Comet 125	02>	2590			2593				
125	Exceed 125	02>	0190			0193				
125	Grand Prix 125	98>	0190	2590		0193	2593			
125	Grand Prix 125 Plus	02>	2590			2593				
125	Gt 125 Comet	02>03	2590			2593				
125	Gv 125 Aquila	02>04	2590			2593				
125	Hyper 125	99>	0190			0193				
125	Rt 125 Karion	02>06	2590			2593				
125	Rx 125	00>	0740							
125	V2 125	99>	0870			0873				
125	Xrx 125 Offroad	99>06	2590			2593				
150	Exceed 150	02>	0190	2590		0193	2593			
150	Grand Prix 150	98>	0190	2590		0193	2593			
250	Aquila 250	00>	0870			0873				
250	Comet 250	02>	0190			0193				
250	Gv 250	02>	2590			2593				
252	Aquila 252	00>	0870			0873				
300	Ga 300	98>	1490			1493				
400	Te 400 (Atv)	05>	1440							
400	Xrx 400	05>	2590	2630		2593	2633			
450	Rx 450 Sm	08>	2860	1330		2863	1333			
450	Te 450 (Atv)	07>	1440							
600	Comet 600	02>		0720			0723			
600	Comet 600	03>	2590			2593				
650	Gv 650 Aquila	04>05	2590	3130		2593	3133			
INNOCENTI										
125	Lambretta 125 Li	-		0601		0601				
150	Lambretta 150 Li	-		0601		0601				
175	Lambretta 175 Li	-		0601		0601				
175	Lambretta 175 TV i	-				0601				
ITALJET										
50	Adly 50	90>				0061				
50	Bazooka 2 50	92>	0180							
50	Cruise 50	95>	0180							
50	Dragster 50	98>	0080	0080		0083	0083			
50	Formula 50	94>96	0160	0190			0193			
50	Formula 50	97>	0080	0080		0083	0083			
50	Jet Set 50	02>	2810							
50	Pista 2 50	92>	0180							
50	Rg 50	98>	0080			0083				
50	Scoop 50	93>	0180							
50	Shopping 50	90>		0201		0230				
50	Torpedo 50	97>	0080			0131	0083			
50	Yankee 8 50	94>	0180							
80	Formula 80	94>	0160	0190			0193			
125	Dragster 125	99>	0080			0083				



PASTIGLIE FRENO RMS - SINTER (RICERCA PER MARCA)

RMS - SINTER BRAKE PADS (SEARCH BY BRAND)

CC	MODELLO MODEL	ANNO YEAR								
			 ANTERIORE FRONT		 POSTERIORE REAR		 ANTERIORE FRONT	 POSTERIORE REAR		
			PASTIGLIA ORGANICA ORGANIC				PASTIGLIA SINTERIZZATA SINTERED			
			 OMOLOGATA HOMOLOGATED	 NON OMOLOGATA NOT HOMOLOGATED	 GANASCE BRAKE SHOES	 OMOLOGATA HOMOLOGATED	 NON OMOLOGATA NOT HOMOLOGATED	 GANASCE BRAKE SHOES		
			22 510	22 512	22 510	22 512	22 510	22 510		
125	Formula 125	94>96	0160		0190		0193			
125	Formula 125	97>	0080		0080	0083	0083			
125	Jet Set 125	02>	2810							
125	Jupiter 125	02>	0410		2810	0413				
125	Millenium 125	>00	2730							
125	Millenium 125 (Seconda Serie)	01>	2810		0560					
125	Torpedo 125	99>	0080			0083				
125	Twin 125	98>	0080		0080	0083	0083			
150	Jet Set 150	02>	2810							
150	Jupiter 150	02>	0410		2810	0413				
150	Millenium 150	>00	2730							
150	Millenium 150 (Seconda Serie)	01>	2810		0560					
150	Torpedo 150 4 T	01>	0080			0083				
180	Dragster 180	99>	0080			0083				
250	Jupiter 250	02>	0410		0560	0413				
350	Boss 350 Enduro	-	0010			0013				
350	Cx 350	85>	0010			0013				
350	Road Master 350	-	0010			0013				
JANSHE										
125	Js 1253	02>	0410			0413				
JCM										
125	Europa 125	89>	0080		0080	0083	0083			
125	Oxygene 125	89>	0030							
125	Sr 125	89>	0080		0080	0083	0083			
125	Week End 125	89>	0030							
233	Vega 233	88>	0030							
240	Enduro 240	91>	0030							
240	Europa 240	89>	0080		0080	0083	0083			
240	Oxygene 240	89>	0030							
240	Sr 240	89>	0080		0080	0083	0083			
240	Week End 240	89>	0030							
250	Week End 250	91>	0030							
325	Europa 325	89>	0080			0083				
325	Oxygene 325	89>	0030							
325	Sr 325	89>	0080		0080	0083	0083			
325	Week End 325	89>	0030							
333	Vega 333	87>	0030							
333	Vega 333	88>	0030							
JINCHENG										
125	Jc 125 2A/3A	97>	1070			1073				
125	Jc 125 2B	97>	2630			2633				
150	Jc 150 T-D	06>	0410			0413				
250	Jc 250	06>	0280							
JJ COBAS										
-	Tr 1	85>	0520		0080	0523	0083			
-	Trial	85>	0080		0080	0083	0083			
KAWASAKI										
50	Ar 50	81>	0040							
50	Kmx 50	88>	0040							
50	Ksr 50 I/II	90>	0040		1200					
65	Kx 65	00>05			1440					
80	Ar 80	81>	0040							

PASTIGLIE FRENO RMS - SINTER (RICERCA PER MARCA)

RMS - SINTER BRAKE PADS (SEARCH BY BRAND)















CC	MODELLO MODEL	ANNO YEAR	RMS YOUR BEST PARTNER				SINTER			
			ANTERIORE FRONT		POSTERIORE REAR		ANTERIORE FRONT	POSTERIORE REAR		
			PASTIGLIA ORGANICA ORGANIC				PASTIGLIA SINTERIZZATA SINTERED			
			OMOLOGATA HOMOLOGATED	NON OMOLOGATA NOT HOMOLOGATED	GANASCE BRAKE SHOES	OMOLOGATA HOMOLOGATED	NON OMOLOGATA NOT HOMOLOGATED	GANASCE BRAKE SHOES		
			22 510	22 512	22 510	22 512	22 510	22 510		
80	Kd 80	88>90	0040							
80	Kx 80	88>96	0040		2850			2853		
80	Kx 80	97>00			2850			2853		
80	Kx 80 E2	84>87	0040							
85	Kx 85	01>06			2850			2853		
100	Kg 100 G4	83>	1200							
100	Kx 100	88>91	0040		2850			2853		
100	Kx 100 B7	97>			2850			2853		
125	Ar 125 A1 - Lc	82>	1200							
125	Bn 125	98>99	1440			0061				
125	Bn 125 Eliminator	00>	1420				1423			
125	Kaze 115 R	98>	1070				1073			
125	Kdx 125 A1	90>	0040		1790					
125	Kh 125 Ex	82>83	1200							
125	Kh 125 K1	82>	1440							
125	Kh 125 K2-4 - L1	82>83	1200							
125	Klx 125	10>	1420				1423			
125	Klx 125 D-Tracker	10>	1420				1423			
125	Kmx 125	86>89	1200		0040					
125	Kmx 125	00>			1440					
125	Kx 125	86>	1200		1200					
125	Kx 125	89>94	1420		1790		1423			
125	Kx 125	96>	0920		2630		0923	2633		
125	Kx 125 B1	81>	0040							
125	Kx 125 B2 - C1	82>85	1200							
125	Kx 125 E2 - D1 - E2	87>88			1200					
125	Kx 125 K2-K4	95>	0920		1790		0923			
150	Kr 150	98>	1070		1200		1073			
150	Kr 150 Sport	98>			1200					
200	Kdx 200 C1	86>88	1200							
200	Kdx 200 E1	89>	1200		1790					
200	Kdx 200 E6, H1-H3	94>	0920		1790		0923			
200	Kdx 200 Sr	90>93	1420		1790		1423			
200	Kmx 200	88>	0040		1200					
200	Z 200 A6	83>	1200							
220	Kdx 220 Ra4	97>	0920		1790		0923			
250	250 R Ninja	08>	1070		1070		1073	1073		
250	Bj 250 F1/F2	02>03	1250				1253			
250	El 250 All Models	87>94	1490				1493			
250	Er 250 (Z 250 T Scorpion)	83>88	1490				1493			
250	Ex 250 H1 - H2	90>			1200					
250	Ex 250 Ninja	86>87	1490		1490		1493	1493		
250	Gpz 250	85>	1200		1490			1493		
250	Kdx 250 Balius	91>			1200					
250	Kdx 250 Estrella	92>	1200		1200					
250	Kdx 250 K2-K4	95>	0920		2630		0923	2633		
250	Kdx 250 Sr-D	91>	1420		1790		1423			
250	Kl 250 Super Sherpa	00>			1200					
250	Kle 250 Anhele	93>			1200					
250	Klr 250 All Models	84>	1200							
250	Klx 250	93>	1420		1790		1423			
250	Klx 250	95>97	0920		1790		0923			

Con Piastra - With Plate



PASTIGLIE FRENO RMS - SINTER (RICERCA PER MARCA)

RMS - SINTER BRAKE PADS (SEARCH BY BRAND)

CC	MODELLO MODEL	ANNO YEAR	 YOUR BEST PARTNER					
			 ANTERIORE FRONT		 POSTERIORE REAR		 ANTERIORE FRONT	 POSTERIORE REAR
			PASTIGLIA ORGANICA ORGANIC				PASTIGLIA SINTERIZZATA SINTERED	
								
			OMOLOGATA HOMOLOGATED	NON OMOLOGATA NOT HOMOLOGATED	GANASCE BRAKE SHOES	OMOLOGATA HOMOLOGATED	NON OMOLOGATA NOT HOMOLOGATED	GANASCE BRAKE SHOES
22 510		22 512	22 510		22512	22 510	22 510	
250	Klx 250 H1 Super Sherpa	98>			1200			
250	Klx 250 S	09>	1420		2630	1423	2633	
250	Klx 250 Sf	09>	1420		2630	1423	2633	
250	Kmx 250	89>	1200		1200			
250	Kr-1 250 C1 - C3	90>	1150			1153		
250	Kx 250	86>	1200		1200			
250	Kx 250	89>94	1420		1790	1423		
250	Kx 250	94>95	0920		1790	0923		
250	Kx 250	96>	0920		2630	0923	2633	
250	Kx 250 B1	82>	0040					
250	Kx 250 C1 - C2	83>85	1200					
250	Kx 250 E1 - F1	87>88			1200			
250	Kx F 250	04>	0920		1450	0923	1453	
250	Lx 250 Eliminator - Se	90>	1490			1493		
250	Sc 250 Epsilon	02>	0380		0670	0383		
250	Z 250	83>	1490			1493		
250	Z 250 A1 - A2	78>80			1190			
250	Z 250 A3	81>			1190			
250	Z 250 Gp Belt Drive	83>	1490			1493		
250	Z 250 J1	81>			1190			
250	Zxr 250	89>			1200			
250	Zzr 250 (Ex 250 H)	90>93			1200			
252	El 252	97>00	1490			1493		
252	El 252	01>	1070			1073		
300	Klf 300 Bayou	88>04	1200					
300	Klx 300	00>	0920		2630	0923	2633	
300	Klx 300 R	97>	0920		1790	0923		
305	Gpz 305 All Models	83>96	1200					
400	Ex 4 400	95>			1200			
400	Gpx 400	85>	1200		1490			
400	Gpz 400	85>	1200		1490			
400	Kle 400	91>			1200			
400	Kle 400 Vulcan	90>	1490			1493		
400	Klx 400 R	03>	0920		2630	0923	2633	
400	Klx 400 Sr	03>	0920		2630	0923	2633	
400	Lx 400 Eliminator - Se	90>	1200					
400	Vn 400 Classic	99>	1240			1243		
400	Vn 400 Vulcan	95>	1490			1493		
400	Xantus 400	92>			1200			
400	Z 400 F2	85>	1200		1490		1493	
400	Zl 400	86>87	1490			1493		
400	Zl 400 Eliminator	88>92	1490		1490	1493	1493	
400	Zl 400 Eliminator	93>			1490		1493	
400	Zr 400 A1 - F	83>	1200					
400	Zr 400 Zephyr	93>			1220		1223	
400	Zrx 400	98>	1170		1220	1173	1223	
400	Zrx 400 (Zr 400 E2)	99>		2120	1220	3013	1223	
400	Zx 400 C2	85>	1200		1490		1493	
400	Zx 400 L	92>			0720		0723	
400	Zxr 400	91>	1150			1153		
400	Zxr 400	94>			1220		1223	
400	Zxr 400 (Zx 400L) Rr	92>			0720		0723	

Con Piastra - With Plate

PASTIGLIE FRENO RMS - SINTER (RICERCA PER MARCA)

RMS - SINTER BRAKE PADS (SEARCH BY BRAND)

















CC	MODELLO MODEL	ANNO YEAR	RMS YOUR BEST PARTNER				SINTER			
			 ANTERIORE FRONT		 POSTERIORE REAR		 ANTERIORE FRONT	 POSTERIORE REAR		
			PASTIGLIA ORGANICA ORGANIC				PASTIGLIA SINTERIZZATA SINTERED			
			 OMOLOGATA HOMOLOGATED	 NON OMOLOGATA NOT HOMOLOGATED	 GANASCE BRAKE SHOES	 OMOLOGATA HOMOLOGATED	 NON OMOLOGATA NOT HOMOLOGATED	 GANASCE BRAKE SHOES		
			22 510		22 512		22 510		22 512	
400	Zzr 400	90>92	1150				1153			
400	Zzr 400	93>	1150		1220		1153	1223		
450	Kx F 450	06>	0920		1450		0923	1453		
450	Kx F 450 Efi	09>	0920		1450		0923	1453		
450	Z 450 Ltd Liquid Cooled	86>89	1490				1493			
500	En 500 All Models	90>04	1490				1493			
500	Er-5 500 Twister	01>07	1240				1243			
500	Gpz 500 S	87>	1490				1493			
500	Gpz 500 S	88>	1200							
500	Gpz 500 S	89>92	1200		1490		1493			
500	Gpz 500 S	93>	1150				1153			
500	Gpz 500 S	94>97			1200					
500	Kle 500	91>93			1200					
500	Kle 500	00>			1200					
500	Kr 500 Es	93>	1420		1790		1423			
500	Kx 500	86>	1200		1200					
500	Kx 500	89>94	1420		1790		1423			
500	Kx 500	94>95	0920		1790		0923			
500	Kx 500 A1 - A2	83>85	1200							
500	Kx 500 C1	87>88			1200					
500	Kx 500 E8/E9	96>	0920		2630		0923	2633		
500	Z 500 F	83>	1200							
500	Zr 500 A1	83>	1200							
500	Zz-R 500	90>	1150				1153			
550	Gt 550	83>01	1200							
550	Z 550 F	83>	1200							
550	Z 550 G1 Shaft	83>	1200							
550	Z 550 Gp	84>	1490		1490		1493			
550	Zr 550 A1	83>84	1200							
550	Zr 550 Zephyr	93>			1220			1223		
570	Klr 570	88>	1200							
600	Gpz 600 R	85>	1490		1490		1493	1493		
600	Kle 600	92>			1200					
600	Klr 600	84>	1200							
600	Klr 600 Electric Starter	85>	1200							
600	Klr 600 S	92>	1200							
600	Klx 600 R	93>	0920		1790		0923			
600	Zl 600 A1/A2	85>94	1490				1493			
600	Zx 6R 600 D1-D2 (Dx 6)	90>93	1150				1153			
600	Zx 6R 600 Ninja	94>97	1150		1220		1153	1223		
600	Zx 6R 600 Ninja	98>02	1170		1220		1173	1223		
600	Zx 6R 600 Ninja	07>			1220		2943	1223		
600	Zx 6Rr 600 Ninja	05>06			1220		2983	1223		
600	Zzr 600	90>92	1150				1153			
600	Zzr 600	93>	1150		1220		1153	1223		
636	Zx 6R 636 Ninja	02>	1170		1220		1173	1223		
636	Zx 6R 636 Ninja	03>06			1220		2983	1223		
650	Er - 6F 650 (Pinza Dx)	06>09	1250		1220		1253	1223		
650	Er - 6F 650 (Pinza Sx)	06>09	1240		1220		1243	1223		
650	Er - 6F 650 Abs (Pinza Dx)	06>09	1250		1220		1253	1223		
650	Er - 6F 650 Abs (Pinza Sx)	06>09	1240		1220		1243	1223		
650	Er - 6N 650 (Pinza Dx)	06>09	1250		1220		1253	1223		

Con Piastra - With Plate



PASTIGLIE FRENO RMS - SINTER (RICERCA PER MARCA)

RMS - SINTER BRAKE PADS (SEARCH BY BRAND)

CC	MODELLO MODEL	ANNO YEAR	 YOUR BEST PARTNER							
			 ANTERIORE FRONT		 POSTERIORE REAR		 ANTERIORE FRONT	 POSTERIORE REAR		
			PASTIGLIA ORGANICA ORGANIC				PASTIGLIA SINTERIZZATA SINTERED			
			 OMOLOGATA HOMOLOGATED	 NON OMOLOGATA NOT HOMOLOGATED	 GANASCE BRAKE SHOES	 OMOLOGATA HOMOLOGATED	 NON OMOLOGATA NOT HOMOLOGATED	 GANASCE BRAKE SHOES	 OMOLOGATA HOMOLOGATED	 NON OMOLOGATA NOT HOMOLOGATED
			22 510		22 512		22 510		22 512	
650	Er - 6N 650 (Pinza Sx)	06>09	1240		1220		1243	1223		
650	Er - 6N 650 Abs (Pinza Dx)	06>09	1250		1220		1253	1223		
650	Er - 6N 650 Abs (Pinza Sx)	06>09	1240		1220		1243	1223		
650	Kl 650 Tengai	89>			1200					
650	Kle 650 Versys (Pinza Dx)	07>10	1250		1220		1253	1223		
650	Kle 650 Versys (Pinza Sx)	07>10	1240		1220		1243	1223		
650	Kle 650 Versys Abs (Pinza Dx)	07>10	1250		1220		1253	1223		
650	Kle 650 Versys Abs (Pinza Sx)	07>10	1240		1220		1243	1223		
650	Klr 650	87>94			1200					
650	Klr 650	95>	1240		1200		1243			
650	Klr 650	00>	1240		1200		1243			
650	Klr 650	08>	1420		1070		1423	1073		
650	Klx 650 R	93>	0920		1790		0923			
650	W 650 (Ej 650)	99>06	1250				1253			
700	Vn 700 A2-A10	86>94	1490				1493			
700	Vn 700 Vulcan	85>	1490				1493			
700	Z 700 (Pinza Dx)	04>	1250		1220		1253	1223		
700	Z 700 (Pinza Sx)	04>	1240		1220		1243	1223		
750	750 Belt Drive	85>	1490		1490		1493	1493		
750	750 Turbo	85>	1490		1490		1493	1493		
750	750 Vulcan	89>93	1490				1493			
750	Gpz 750	85>86	1490		1490		1493	1493		
750	Gpz 750 R1	85>87	1490		1490		1493	1493		
750	Gt 750	85>	1490		1490		1493	1493		
750	Vn 750	88>	1490		1490		1493	1493		
750	Vn 750 Twin	86>	1490				1493			
750	Vn 750 Vulcan	90>	1490				1493			
750	Z 750	07>09	0870		0930		0873	0933		
750	Z 750 Abs	07>09	0870		0930		0873	0933		
750	Z 750 Gp	83>	1490		1490		1493	1493		
750	Z 750 J (Pinza Dx) (Zr)	04>05	1250		1220		1253	1223		
750	Z 750 J (Pinza Sx) (Zr)	04>05	1240		1220		1243	1223		
750	Z 750 Ltd Twin K1	83>	1490				1493			
750	Z 750 R	11>			0930		2983	0933		
750	Z 750 R Abs	11>			0930		2983	0933		
750	Z 750 S (Pinza Dx) (Zr)	05>06	1250		1220		1253	1223		
750	Z 750 S (Pinza Sx) (Zr)	05>06	1240		1220		1243	1223		
750	Zr 750 Zephyr	96>	1240				1243			
750	Zr-7 750 (Pinza Dx)	99>	1250		1250		1253	1253		
750	Zr-7 750 (Pinza Sx)	99>	1240		1250		1243	1253		
750	Zr-7S 750 (Pinza Dx)	01>	1250		1250		1253	1253		
750	Zr-7S 750 (Pinza Sx)	01>	1240		1250		1243	1253		
750	Zx 750 A1	83>	1490		1490		1493			
750	Zx 750 E1 Turbo	83>	1490		1490		1493			
750	Zx-7 750 R Ninja	89>95	1150		1200		1153			
750	Zx-7 750 R Ninja	96>	1170		1200		1173			
750	Zx-7 750 Rr Ninja N1	96>						3113		
750	Zxr 750	89>90	1150		0720		1153	0723		
750	Zxr 750 R	93>	1150		0720		1153	0723		
750	Zxr 750 R Stinger / Ninja	91>92	1150				1153			
800	Vn 800	95>98	1490				1493			
800	Vn 800 Classic	96>99	1240				1243			

Con Piastra - With Plate

PASTIGLIE FRENO RMS - SINTER (RICERCA PER MARCA)

RMS - SINTER BRAKE PADS (SEARCH BY BRAND)



CC	MODELLO MODEL	ANNO YEAR	RMS YOUR BEST PARTNER				SINTER			
			 ANTERIORE FRONT		 POSTERIORE REAR		 ANTERIORE FRONT	 POSTERIORE REAR		
			PASTIGLIA ORGANICA ORGANIC				PASTIGLIA SINTERIZZATA SINTERED			
			 OMOLOGATA HOMOLOGATED	 NON OMOLOGATA NOT HOMOLOGATED	 GANASCE BRAKE SHOES	 OMOLOGATA HOMOLOGATED	 NON OMOLOGATA NOT HOMOLOGATED	 GANASCE BRAKE SHOES		
			22 510		22 512	22 510		22 512	22 510	22 510
800	Vn 800 Drifter	99>	1240				1250	1243	1253	
800	W 800 Abf (Ej 800)	11>	1250					1253		
800	Z R	13							3323	
800	Z E	13							3323	
850	Vn 850	95>	1490					1493		
900	Gpz 900	85>	1490			1490		1493	1493	
900	Gpz 900 R	90>	1150					1153		
900	Gpz 900 R Ninja	84>89	1490			1490		1493	1493	
900	Vn 900 Classic	06>	1240					1243	1253	
900	Vn 900 Custom	07>	1240					1243	1253	
900	X-9 R 900 Ninja	94>95	1150				1220	1153	1223	
900	Z 900 Z1a - Z1b	74>76	1490							
900	Zx-9 900 R Ninja	96>01	1170				1220	1173	1223	
900	Zx-9 900 R Ninja	02>					1220	2993	1223	
1000	Gpz 1000 Rx - Ry	86>	1490			1490		1493	1493	
1000	Gtr 1000	86>93	1490			1490		1493	1493	
1000	Klv 1000 (Pinza Dx)	04>	1250			0930		1253	0933	
1000	Klv 1000 (Pinza Sx)	04>	1240			0930		1243	0933	
1000	Vn 1000 Vulcan	87>	1490			1490		1493	1493	
1000	Z 1000	07>09				0930		2943	0933	
1000	Z 1000 - Abs	10>				1220		2963	1223	
1000	Z 1000 (Zr)	03>06				1220		2993	1223	
1000	Z 1000 Abs	07>09				0930		2943	0933	
1000	Z 1000 Abs	10>				1220		2963	1223	
1000	Z 1000 Gtr	94>				1490			1493	
1000	Z 1000 Gtr (Zg 1000)	86>93	1490			1490		1493	1493	
1000	Z 1000 Sx - Abs	11>				1220		2963	1223	
1000	Zl 1000 All Models	87>	1490			1490		1493	1493	
1000	Zx 10R 1000 Ninja	04>07				1220		2983	1223	
1000	Zx 10R 1000 Ninja	08>10				1220		2963	1223	
1000	Zx 10R 1000 Ninja	11>						2963	2933	
1000	Zx 10R 1000 Ninja Abs	11>						2963	2933	
1000	Zzr 1000	91>	1150					1153		
1100	Gpx 1100 (Zx 1100 A1)	83>	1490			1490		1493	1493	
1100	Gpz 1100 (Pinza Dx)	95>	1250			1220		1253	1223	
1100	Gpz 1100 (Pinza Sx)	95>	1240			1220		1243	1223	
1100	Vn 1100	87>	1490			1490		1493	1493	
1100	Z 1100 R1	84>	1490			1490		1493	1493	
1100	Zr 1100 C1	97>	1170			0720		1173	0723	
1100	Zr 1100 Zephir	97>	1240					1243		
1100	Zr 1100 Zephyr (Pinza Dx)	96>	1250					1253		
1100	Zr 1100 Zephyr (Pinza Sx)	96>	1240					1243		
1100	Zr 1100 Zephyr (Zr 1100 A)	92>96	1150					1153		
1100	Zrx 1100	96>				0720			0723	
1100	Zx 1100	93>	1150					1153		
1100	Zx 1100 A1	83>84	1490			1490		1493	1493	
1100	Zzr 1100 Gt (Zx 1100 C)	90>92	1150					1153		
1100	Zzr 1100 Gt (Zx 1100 D)	93>	1150			1190		1153		
1200	Kz 1200	87>	1490			1490		1493	1493	
1200	Zg 1200	86>90	1490			1490		1493	1493	
1200	Zg 1200 Voyager	86>	1490			1490		1493	1493	
1200	Zrx 1200	01>03	1170					1173		

□ Con Piastra - With Plate



PASTIGLIE FRENO RMS - SINTER (RICERCA PER MARCA)

RMS - SINTER BRAKE PADS (SEARCH BY BRAND)

CC	MODELLO MODEL	ANNO YEAR	RMS YOUR BEST PARTNER				SINTER	
			ANTERIORE FRONT		POSTERIORE REAR		ANTERIORE FRONT	POSTERIORE REAR
			PASTIGLIA ORGANICA ORGANIC				PASTIGLIA SINTERIZZATA SINTERED	
			OMOLOGATA HOMOLOGATED	NON OMOLOGATA NOT HOMOLOGATED	GANASCE BRAKE SHOES	OMOLOGATA HOMOLOGATED	NON OMOLOGATA NOT HOMOLOGATED	GANASCE BRAKE SHOES
1200	Zrx 1200	04>	1150				1153	
1200	Zrx 1200 R - S	00>			0720			0723
1200	Zrx 1200 R - S	01>03	1170				1173	
1200	Zrx 1200 R - S	04>	1150				1153	
1200	Zx 12R 1200 Ninja	00>03	1170		0720		1173	0723
1200	Zx 12R 1200 Ninja	04>06			0720		2983	0723
1200	Zz-R 1200	02>	1150		0720		1153	0723
1400	Gtr 1400	07>08					2943	3113
1400	Zzr 1400 A6f	06>09					2943	3113
1400	Zzr 1400 Abs B6f	06>09					2943	3113
1500	Vn 1500 All Models	87>93	1490		1490		1493	1493
1500	Vn 1500 Classic Tourer (Pinza Dx)	98>	1250		1490		1253	1493
1500	Vn 1500 Classic Tourer (Pinza Sx)	98>	1240		1490		1243	1493
1500	Vn 1500 Classic Tourer F1 (Pinza Dx)	00>02	1250		1490		1253	1493
1500	Vn 1500 Classic Tourer F1 (Pinza Sx)	00>02	1240		1490		1243	1493
1500	Vn 1500 D1/D2 Classic	96>98	1240		1490		1243	1493
1500	Vn 1500 Drifter	99>02	1240		1250		1243	1253
1500	Vn 1500 Mean Streak	02>03	1170		1250		1173	1253
1500	Vn 1500 Sumo	88>	1490		1490		1493	1493
1600	Vn 1600 Classic (Pinza Dx)	03>08	1250		1490		1253	1493
1600	Vn 1600 Classic (Pinza Sx)	03>08	1240		1490		1243	1493
1600	Vn 1600 Mean Streak	04>	1170		1250		1173	1253
1600	Vn 1600 Mean Streak	05>			1250		2983	1253
1700	Vn 1700 Classic (Pinza Dx)	09>	1250		1490		1253	1493
1700	Vn 1700 Classic (Pinza Sx)	09>	1240		1490		1243	1493
1700	Vn 1700 Classic Tourer (Pinza Dx)	09>	1250		1490		1253	1493
1700	Vn 1700 Classic Tourer (Pinza Sx)	09>	1240		1490		1243	1493
1700	Vn 1700 Voyager	09>	1150		1250		1153	1253
2000	Vn 2000	04>	1150		1250		1153	1253
KAWASAKI ATV								
250	Ksf 250 Mojave A1/A15	87>01			2850			2853
250	Kxf 250 Tecate A1/A2	87>88			2850			2853
250	Kxt 250 Tecate A1	84>			0040			
250	Kxt 250 Tecate A2 - B1	85>86	1200		1200			
250	Kxt 250 Tecate B2	87>	1200		2850			2853
300	Kef 300 Lakota (2Wd) A1/ A6	95>00			2850			2853
300	Kef 300 Lakota Sport	01>			2850			2853
300	Klf 300 Bayou B1/B14	88>01	1200					
300	Klf 300 Bayou C1/C12 (Pinza Dx)	89>	1070				1073	
300	Klf 300 Bayou C1/C12 (Pinza Sx)	89>90	1420				1423	
300	Kvf 300 Prairie 2X4 B1/B3	99>01	1440					
300	Kvf 300 Prairie 4X4 A1/A3	99>01	1440					
400	Kfx 400	02>	1440					
400	Klf 400 Bayou 4X4 B1/B7 (Pinza Dx)	93>99	1070				1073	
400	Klf 400 Bayou 4X4 B1/B7 (Pinza Sx)	93>99	1420				1423	
400	Kvf 400 Prairie 2X4 D1/D3	99>01	1440					
400	Kvf 400 Prairie 4X4 C1/C3	99>01	1440					
400	Kvf 400 Prairie A1/A2 - B1	97>98	1440					
650	Kvf 650 Brute Force 4X4i (Pinza Dx)	05>	1420				1423	
650	Kvf 650 Brute Force 4X4i (Pinza Sx)	05>	1070				1073	
750	Kvf 750 Brute Force 4X4i (Pinza Dx)	05>	1420				1423	
750	Kvf 750 Brute Force 4X4i (Pinza Sx)	05>	1070				1073	

Con Piastra - With Plate

PASTIGLIE FRENO RMS - SINTER (RICERCA PER MARCA)

RMS - SINTER BRAKE PADS (SEARCH BY BRAND)

















CC	MODELLO MODEL	ANNO YEAR	RMS YOUR BEST PARTNER				SINTER			
			ANTERIORE FRONT		POSTERIORE REAR		ANTERIORE FRONT	POSTERIORE REAR		
			PASTIGLIA ORGANICA ORGANIC				PASTIGLIA SINTERIZZATA SINTERED			
			OMOLOGATA HOMOLOGATED	NON OMOLOGATA NOT HOMOLOGATED	GANASCE BRAKE SHOES	OMOLOGATA HOMOLOGATED	NON OMOLOGATA NOT HOMOLOGATED	GANASCE BRAKE SHOES		
			22 510	22 512	22 510	22 512	22 510	22 510	22 510	
KEEWAY										
50	50 Hurricane	06>	0040							
50	F-Nkd 50	10>				0061				
50	Ry8 50	07>09				0061				
50	Ry8 50	10>		2590			2593			
50	Tx 50 Sm	10>	0560							
90	90 Hurricane	06>	0040							
100	100 Partner	06>	0350			0353				
110	110 Partner	06>	0350			0353				
125	125 Arn	06>	0190			0193				
125	125 Enduro	07>	0360	0010		0363	0013			
125	125 Speed	06>	0030	0350			0353			
125	125 Superlight	06>	0580			0583				
125	125 X-Ray	07>	0360	0010		0363	0013			
125	Focus	06>07	0040			0451				
125	Matrix	06>09	0040			0451				
125	Tx 125 Sm	10>	0560							
150	150 Arn	06>	0190			0193				
150	150 Speed	06>	0030	0350			0353			
150	150 Superlight	06>	0580			0583				
150	Matrix	07>09	0240			0451				
250	250 Land Cruiser	06>	0580			0583				
250	250 Supershadow	06>	0410			0413				
KOTIR										
50	Rs 50	90>		0061		0061				
KRAMIT										
250	Gs 250	97>	0430	1330			1333			
250	Mx 250	97>	0430	1330			1333			
250	Sm 250	97>	0430	1330			1333			
KREIDLER										
25	Florett 25 XL	99>	2800							
50	Florett 50 XL	99>	2800			0061				
125	Enduro 125	07>	0580			0583				
125	Florett 125	07>	1070			1073				
125	Florett 125 Rmc-F	07>	1070			1073				
125	Supermoto 125	07>	0580			0583				
KTM										
50	Chrono 50 Scooter	94>	0530			0091	0533			
50	Comet 50 PL-RL-RLW-RS4L-TS	-	0010				0013			
50	Go 50 Scooter	94>	0070			0091				
50	Mx 50	87>	0010				0013			
50	Rsv 50	86>	0010				0013			
50	Sx 50 Junior Lc	02>04	3220				3223			
50	Sx 50 Pro Junior Lc	02>	3220				3223			
50	Sx 50 Pro Senjor Lc	02>03	3220				3223			
50	Sx 50 Pro Senjor Lc	04>	3220	3220			3223			
50	Sx 50 Senjor Adventure	04>	3220				3223			
50	Sx 50 Supermoto	06>	3220	3220			3223			
60	Sx 60	98>99	0080				0083			
65	Sx 65	00>01	0080				0083			
65	Sx 65	04>08		3220			3223			
80	L-PI-RI-Rs-Rsl-Bora 80	-	0010	0010			0013			



PASTIGLIE FRENO RMS - SINTER (RICERCA PER MARCA)

RMS - SINTER BRAKE PADS (SEARCH BY BRAND)

CC	MODELLO MODEL	ANNO YEAR	 YOUR BEST PARTNER							
			 ANTERIORE FRONT		 POSTERIORE REAR		 ANTERIORE FRONT	 POSTERIORE REAR		
			PASTIGLIA ORGANICA ORGANIC				PASTIGLIA SINTERIZZATA SINTERED			
			 OMOLOGATA HOMOLOGATED	 NON OMOLOGATA NOT HOMOLOGATED	 GANASCE BRAKE SHOES	 OMOLOGATA HOMOLOGATED	 NON OMOLOGATA NOT HOMOLOGATED	 GANASCE BRAKE SHOES	 OMOLOGATA HOMOLOGATED	 NON OMOLOGATA NOT HOMOLOGATED
			22 510		22 512		22 510		22 512	
80	Mx 80 Gr - Super Mini	86>	0010				0013			
125	Baja 125	86>	0010				0013			
125	Duke 125	11>			1330			1333		
125	Exc 125	89>91	1200		1200					
125	Exc 125	92>93	0430		0430					
125	Exc 125	98>03	0430		1330			1333		
125	Exc 125	04>	0430		0750			0753		
125	Exe 125	00>	0430		1330			1333		
125	Gs 125	86>	0010		0010		0013			
125	Gs 125	86>87	0530		0530		0533			
125	Lc2 125	98>	0430		1330			1333		
125	Lc2 Sting 125	97>98	0520		1330		0523	1333		
125	Mx 125	85>	0010				0013			
125	Mx 125	86>	0010		0010		0013			
125	Mx 125	86>87	0530		0530		0533			
125	Mx 125	89>91	1200		1200					
125	Mx 125	92>93	0430		0430					
125	Supermoto 125	00>	0430		1330			1333		
125	Sx 125	96>03	0430		1330			1333		
125	Sx 125	04>	0430		0750			0753		
125	Duke	11	3310				3313			
144	Sx 144	07>08	0430		0750			0753		
150	Sx 150	09>	0430		0750			0753		
200	Egs 200	98>99	0430		1330			1333		
200	Exc 200	98>03	0430		1330			1333		
200	Exc 200	04>	0430		0750			0753		
200	Sx 200	03>04	0430		0750			0753		
200	Duke	12	3310				3313			
250	Baja 250	86>	0010				0013			
250	Exc 250	92>	0430		1200					
250	Exc 250	93>	0430		1200					
250	Exc 250	94>03	0430		1330			1333		
250	Exc 250	04>	0430		0750			0753		
250	Exc 250 4T	99>03	0430		1330			1333		
250	Exc 250 4T	04>06	0430		0750			0753		
250	Exc-F 250	07>09	0430		0750			0753		
250	Exc-R 250	01>03	0430		1330			1333		
250	Exc-R 250	04>06	0430		0750			0753		
250	Gs 250	86>	0010		0010		0013			
250	Gs 250	86>87	0530		0530		0533			
250	Mx 250	85>	0010				0013			
250	Mx 250	86>	0010		0010		0013			
250	Mx 250	86>87	0530		0530		0533			
250	Mx 250	92>93	0430		1200					
250	Mx 250	94>02	0430		1330			1333		
250	Sx 250	96>02	0430		1330			1333		
250	Sx 250	03>	0430		0750			0753		
250	Sx-F 250	06>	0430		0750			0753		
300	Exc 300 E	04>	0430		0750			0753		
300	Exc 300 Egs	93>	0430		1200					
300	Exc 300 Egs	94>03	0430		1330			1333		
300	Gs 300	86>	0010		0010		0013			

Con Piastra - With Plate

PASTIGLIE FRENO RMS - SINTER (RICERCA PER MARCA)

RMS - SINTER BRAKE PADS (SEARCH BY BRAND)



CC	MODELLO MODEL	ANNO YEAR	RMS YOUR BEST PARTNER				SINTER			
			 ANTERIORE FRONT		 POSTERIORE REAR		 ANTERIORE FRONT	 POSTERIORE REAR		
			PASTIGLIA ORGANICA ORGANIC				PASTIGLIA SINTERIZZATA SINTERED			
			 OMOLOGATA HOMOLOGATED	 NON OMOLOGATA NOT HOMOLOGATED	 GANASCE BRAKE SHOES	 OMOLOGATA HOMOLOGATED	 NON OMOLOGATA NOT HOMOLOGATED	 GANASCE BRAKE SHOES		
			22 510		22 512	22 510		22 512	22 510	22 510
300	Gs 300	86>87	0530			0530	0533			
350	Country 350	85>	0010				0013			
350	Exc/Egs 350	89>90	1200			1200				
350	Gs 350	83>	0010				0013			
360	Exc 360	96>97	0430			1330		1333		
360	Sx 360	96>97	0430			1330		1333		
380	Exc 380	98>02	0430			1330		1333		
380	Mxc 380	98>02	0430			1330		1333		
380	Sx 380	98>02	0430			1330		1333		
390	Gs 390	83>	0010				0013			
390	Duke	13	3310				3313			
400	Duke 400	94>	0520			1200	0523			
400	Duke 400	95>	0520			1330	0523	1333		
400	Enduro 400	87>	0530			0530	0533			
400	Exc 400	00>03	0430			1330		1333		
400	Exc 400	04>	0430			0750		0753		
400	Lc4 400	93>94	0430			1200				
400	Lc4 Egs 400	95>97	0430			1330		1333		
400	Lc4 Sc 400	98>00	0430			1330		1333		
400	Lc4 Sxc 400	98>00	0430			1330		1333		
400	Sx 400	00>02	0430			1330		1333		
400	Sxc 400	99>00	0430			1330		1333		
450	Exc 450	03>	0430			1330		1333		
450	Exc 450	04>09	0430			0750		0753		
450	Exc-R 450	08>	0430			0750		0753		
450	Sx 450	03>	0430			0750		0753		
450	Sx 450 Smr (Fte Caliper)	04>06				0750		0753		
450	Sx Sm 450 Factory Replica	04>	0520			0750	0523	0753		
450	Sx-F 450	07>	0430			0750		0753		
450	Xc-F 450	08>	0430			0750		0753		
495	Mx 495	82>83	0010				0013			
500	Exc/Mx 500	92>	0430			1200				
500	Exc/Mx 500	94>95	0430			1330		1333		
500	Exc/Mx 500 (Pinze Brembo)	89>91	1200			1200				
500	Gs 500	83>	0010				0013			
500	Lc4 Exc/Egs 500	92>	0430			1200				
500	Lc4 Exc/Egs 500 (Pinze Brembo)	90>91	1200			1200				
500	Lc4 Exc/Egs 500 (Pinze Grimeca)	90>91				1200				
500	Mx 500	86>87	0530			0530	0533			
500	Mx/Mxc 500	85>	0010				0013			
500	Mx/Mxc 500	86>	0010			0010	0013			
505	Sx-F 505	07>08	0430			0750		0753		
505	Xc-F 505	09>	0430			0750		0753		
520	Exc 520	00>02	0430			1330		1333		
520	Sx 520	00>02	0430			1330		1333		
525	Exc 525	03>	0430			1330		1333		
525	Exc 525	04>07	0430			0750		0753		
525	Sx 525	03>	0430			1330		1333		
525	Sx 525	04>06	0430			0750		0753		
525	Sx 525 Smr (Fte Caliper)	04>				0750		0753		
530	Exc-R 530	08>	0430			0750		0753		
540	Sxc 540	98>00	0430			1330		1333		

□ Con Plastra - With Plate



PASTIGLIE FRENO RMS - SINTER (RICERCA PER MARCA)

RMS - SINTER BRAKE PADS (SEARCH BY BRAND)

CC	MODELLO MODEL	ANNO YEAR								
			 ANTERIORE FRONT		 POSTERIORE REAR		 ANTERIORE FRONT	 POSTERIORE REAR		
			PASTIGLIA ORGANICA ORGANIC				PASTIGLIA SINTERIZZATA SINTERED			
			 OMOLOGATA HOMOLOGATED	 NON OMOLOGATA NOT HOMOLOGATED	 GANASCE BRAKE SHOES	 OMOLOGATA HOMOLOGATED	 NON OMOLOGATA NOT HOMOLOGATED	 GANASCE BRAKE SHOES		
			22 510		22 512	22 510		22512	22 510	22 510
550	Gxe 550	86>	0010			0010	0013			
550	Gxe 550	86>87	0530			0530	0533			
550	Mx 550	87>	0530			0530	0533			
560	Sx 560 Smr	06>				0750		0753		
600	Enduro 600	86>	0010			0010	0013			
600	Enduro 600	86>87	0530			0530	0533			
600	Gs 600	85>	0010				0013			
600	Xc/Xce 600	85>	0010				0013			
620	Duke 620	96>98	0520			0010	0523	0013		
620	Lc4 620 Competition	99>	0430			1330		1333		
620	Lc4 620 Competition Supermoto	00>	0430			1330		1333		
620	Lc4 620 Rxc	95>	0430			1330		1333		
620	Lc4 620 Supercompetition	01>	0430			1330		1333		
620	Sc 620	99>	0430			1330		1333		
620	Sx 620	95>99	0430			1330		1333		
625	Lc4 Sc 625 Supermoto	02>04	0430			1330		1333		
625	Smc 625	05>	1100			1330	1103	1333		
625	Sxc 625	03>04	0430			1330		1333		
640	Duke 640	99>02	0520			1330	0523	1333		
640	Duke 640	03>	1100			1330	1103	1333		
640	Lc4 640 Adventure	98>04	0430			1330		1333		
640	Lc4 640 Adventure	05>	1010			1330	1013	1333		
640	Lc4 640 Supermoto	03>	0520			1330	0523	1333		
640	Lc4 640 Supermoto	04>	1100			1330	1103	1333		
640	Lc4 E 640	98>06	0430			1330		1333		
640	Lc4-E 640 Enduro	99>	0430			1330		1333		
640	Lc4-E 640 Supermoto	99>02	0430			1330		1333		
660	Lc4 660 Sm Factory Replica	02>03	0520			1330	0523	1333		
660	Lc4-E 660 Rallye	01>	0430			1330		1333		
660	Smc 660 Supermoto	03>	0520			1330	0523	1333		
660	Smc 660 Supermoto	04>06	1100			1330	1103	1333		
690	Lc4 690 Duke	08>	2860			1330	2863	1333		
690	Lc4 690 Enduro	08>	1010			1330	1013	1333		
690	Lc4 690 Enduro R	09>	1010			1330	1013	1333		
690	Lc4 690 Sm	07>	2860			1330	2863	1333		
690	Lc4 690 Smc	08>	2860			1330	2863	1333		
690	Lc4 690 Supermoto R	08>	2860			1330	2863	1333		
950	Lc8 950 Adventure / S	02>	1010			1330	1013	1333		
950	Lc8 950 Sm / Sm R	05>	2860			0430	2863			
950	Lc8 950 Superenduro / R	06>	1010			0430	1013			
990	Lc8 990 Adventure / S	06>11	1010			0430	1013			
990	Lc8 990 Super Duke / R	04>09	2860			1330	2863	1333		
990	Lc8 990 Supermoto	07>	1010			0430	1013			
990	Lc8 990 Supermoto T	09>	1010			0430	1013			
1190	Rc8 1190	08>				0490	2923	0493		
1190	Rc8 1190 R	09>				0490	2923	0493		
1190	Rc8 1190 R Track	11>				0490	2923	0493		
KYMCO										
50	Agility 50	05>08	0350				0353			
50	Agility 50 2T R 16	10>	2710			0611				
50	Agility 50 4T R 10	06>08	0580				0353			
50	Agility 50 4T R 12	07>08	0580				0353			

Con Piastra - With Plate

PASTIGLIE FRENO RMS - SINTER (RICERCA PER MARCA)

RMS - SINTER BRAKE PADS (SEARCH BY BRAND)















CC	MODELLO MODEL	ANNO YEAR	RMS YOUR BEST PARTNER						SINTER			
			 ANTERIORE FRONT			 POSTERIORE REAR			 ANTERIORE FRONT	 POSTERIORE REAR		
			PASTIGLIA ORGANICA ORGANIC						PASTIGLIA SINTERIZZATA SINTERED			
			 OMOLOGATA HOMOLOGATED		 NON OMOLOGATA NOT HOMOLOGATED		 OMOLOGATA HOMOLOGATED		 NON OMOLOGATA NOT HOMOLOGATED		 GANASCE BRAKE SHOES	
			22 510		22 512		22 510		22 512		22 510	
50	Agility 50 4T R 16	08>	2710					0611				
50	Agility 50 Rs Naked 2T	10>	0350						0353			
50	Agility City 50 R16 (4T/2T)	08>	2710					0611				
50	B&w 50	04>	0350						0353			
50	Calypso	97>		0240								
50	Cobra 50 Cross	01>	2630						2633			
50	Cobra 50 Cross / Racer	99>00	2630						2633			
50	Cobra 50 Esclusiva / Racer	01>	2630						2633			
50	Cx 50 Curio Super	94>	2630						2633			
50	Dd 50 Sniper	94>	2630			9175			2633			
50	Dink 50	97>	0350						0353			
50	Dink 50 4T	07>	0350						0353			
50	Djx-Djy-Djw	93>93		0091			0070					
50	Fever Zx - Fever Zx Eu2	95>04	2360				0070					
50	Filly 50 Lx	02>	0580						0583			
50	Heroism 50	95>96	2630						2633			
50	K 12 50	95>	2630						2633			
50	Kb 50	94>	2630						2633			
50	Like 50 2T	09>	0580						0353			
50	Like 50 4T	09>	0580						0353			
50	Manboy	95>	3440	1650								
50	Mxer - Euro2 - Mxu Sr	02>07		0091		2710						
50	New Dink 50	08>	0350						0353			
50	People 50	99>11	2710				0611					
50	People 50 Eu2	03>	2710				0400					
50	People 50 Eu2	08>	2710				0400					
50	People S 50	05>10	2710				0611					
50	People S 50 4T	06>13	2710				0400					
50	Sento 50	08>	0350						0353			
50	Sniper	93>		0170			0091					
50	Spacer 50	99>	0350						0353			
50	Super 8	09>12	2710				0400					
50	Super 9 50	00>01	2630						2633			
50	Super 9 50 Ac - Lc	02>	0350			2710			0353			
50	Super 9 50 Sport Eu2	03>04				2710						
50	Tb 50	00>	2630						2633			
50	Top Boy 50 On / Off Road	96>	0350						0353			
50	Top Boy 50 Racer / Cross	01>	0350						0353			
50	Vitality 50	04>	0580						0583			
50	Yager 50	01>	0350						0353			
50	Yup 50	01>	2630						2633			
50	Yup 50	02>	0580						0583			
50	Zap	95>	3440	1650								
50	Zk 50 Superfever	99>	2630						2633			
50	Zx 50 Fever	95>	2630						2633			
50	Zx 50 Super Fever	02>	2630						2633			
90	Manboy 90	96>	2630						2633			
90	Yup	95>	3440	1650			0091					
100	Cobra 100 Racer	99>	0350						0353			
100	Kb 100	99>	2630						2633			
100	Top Boy 100	97>	0350						0353			
100	Top Boy 100 On / Off Road	99>	2630						2633			



PASTIGLIE FRENO RMS - SINTER (RICERCA PER MARCA)

RMS - SINTER BRAKE PADS (SEARCH BY BRAND)

CC	MODELLO MODEL	ANNO YEAR	 YOUR BEST PARTNER					
			 ANTERIORE FRONT		 POSTERIORE REAR		 ANTERIORE FRONT	 POSTERIORE REAR
			PASTIGLIA ORGANICA ORGANIC				PASTIGLIA SINTERIZZATA SINTERED	
								
			OMOLOGATA HOMOLOGATED	NON OMOLOGATA NOT HOMOLOGATED	GANASCE BRAKE SHOES	OMOLOGATA HOMOLOGATED	NON OMOLOGATA NOT HOMOLOGATED	GANASCE BRAKE SHOES
125	Agility 125 4T	06>	0580			0611	0353	
125	Agility 125 4T Eu3	05>08	0580			0611	0353	
125	Agility 125 R 16	08>	2710		1200			
125	Agility 125 Rs	09>13	0580			0611	0353	
125	Agility 125 Rs R12 (4T) Naked +	10>	0580			0611		
125	B&w 125 Bet & Win	00>	0350		0350		0353	0353
125	Dink 125	96>99	0350		0350		0353	0353
125	Dink 125 Eu3	06>07	0350				0353	
125	Dink 125 I Eu3	06>07	0350				0353	
125	Downtown 125 i	09>	2640	0890	2760		2643	2763
125	Downtown i	15	2670	0440	2760			
125	Grand Dink 125	02>	0350		0350		0353	0353
125	Heroism	95>97		0240		0091		
125	Hipster 125	01>	0350				0353	
125	K-Xct i	12	2670	0440	2740			
125	Like 125	09>	0580		0350		0353	0353
125	Movie 125	99>00	0580			0611	0353	
125	Movie 125 XL	01>	0350			0611	0353	
125	Mxer - Eu2 - Mxu Sr	02>07		0091	2710			
125	Mxer - Eu2 - Mxu Sr	02>07		0091	2710			
125	People 125	99>	2710			0611		
125	People 125 Eu2	03>04	2710					
125	People 125 Eu3	07>08	2710		2740			2743
125	People One 125 i	13>	2710			0611		2743
125	People Gti 125	10>	0870				0873	
125	People S 125	05>06	2710			0611		
125	People S 125 Dd	07>08	2710		2740			2743
125	Pulsar 125	01>	0350				0353	
125	Spacer 125	99>	0350		0350		0353	0353
125	Super 8 125	08>13	2710			0611		
125	Super 9 125	00>01	2630		2710		2633	
125	Superdink 125	10>	2640		2760		2643	2763
125	Vivio 125	00>03	0580			0611	0583	
125	Yager 125	01>	0350		0350		0353	0353
125	Zing 125	96>	0350				0353	
150	Agility 150 R 16	08>09	2710		0350			0353
150	B&w 150 Bet & Win	00>	0350		0350		0353	0353
150	Dink 150	97>	0350		0350		0353	0353
150	Dx 150 Custom	93>	2590				2593	
150	Freeway 150	95>	2630				2633	
150	Grand Dink 150	02>	0350		0350		0353	0353
150	Heroism	95>97		0240		9175		
150	Hipster 150	01>	0350				0353	
150	Movie 150 XL	01>09	0350			0611	0353	
150	People 150	99>	2710			0611		
150	People 150 Eu2	03>	2710					
150	People 150 Eu2	99>03	2710			0400		
150	Spacer 150	99>	0350		0350		0353	0353
150	Vivio 150	01>	0580			0400	0583	
150	Yager 150	01>	0350		0350	0611	0353	0353
150	Zing 150	99>	0350				0353	
200	Agility 200 i R 16	10>	2710		0350			0353

□ Con Piastra - With Plate

PASTIGLIE FRENO RMS - SINTER (RICERCA PER MARCA)

RMS - SINTER BRAKE PADS (SEARCH BY BRAND)



CC	MODELLO MODEL	ANNO YEAR	RMS YOUR BEST PARTNER				SINTER			
			 ANTERIORE FRONT		 POSTERIORE REAR		 ANTERIORE FRONT	 POSTERIORE REAR		
			PASTIGLIA ORGANICA ORGANIC				PASTIGLIA SINTERIZZATA SINTERED			
			 OMOLOGATA HOMOLOGATED	 NON OMOLOGATA NOT HOMOLOGATED	 GANASCE BRAKE SHOES	 OMOLOGATA HOMOLOGATED	 NON OMOLOGATA NOT HOMOLOGATED	 GANASCE BRAKE SHOES		
			22 510	22 512	22 510	22 512	22 510	22 510		
200	Dink 200 Euro 3 i	06>07	0350				0353			
200	Dink 200 i Eui3	06>07	0350				0353			
200	Downtown 200 i	10>	2640	0890	2760		2643	2763		
200	Like 200 i	09>	0580		0350		0353	0353		
200	People Gti 200	10>	0870				0873			
200	People S 200	04>07	2710			0611				
200	People S 200 i	07>	2710		2740			2743		
200	Super 9 200	00>	2630		2710		2633			
200	Yager 200	04>	0350		0350		0353	0353		
250	B&w 250 Bet & Win	00>	0350		0350		0353	0353		
250	Gran Dink 250	01>	0500		0510					
250	People 250	03>05	0350		0870	0690	0353	0873		
250	People S 250 (Pinza Dx)	06>	0350		2740		0353	2743		
250	People S 250 (Pinza Sx)	06>	0580		2740		0583	2743		
250	People S 250 I (Pinza Dx)	07>	0350		2740		0353	2743		
250	People S 250 I (Pinza Sx)	07>	0580		2740		0583	2743		
250	Venox 250	01>	0870				0873			
250	Xciting 250	04>	0870		0870		0873	0873		
250	Xciting 250	05>	2640	0890	2740		2643	2743		
250	Xciting 250 i	06>07	2640	0890	2740		2643	2743		
250	Yup 250	03>	0350		0350		0353	0353		
300	Agility Maxi i Abs	15	2670	0440						
300	Downtown 300 i	09>	2640	0890	2760		2643	2763		
300	People Gti 300	10>	0870				0873			
300	People S 300 i (Pinza Dx)	08>09	0350		2740		0353	2743		
300	People S 300 i (Pinza Sx)	08>09	0580		2740		0583	2743		
300	Xciting 300 i	08>	2640	0890			2643			
300	Xciting 300 i R	08>09	2640	0890	2740		2643	2743		
350	Downtown i Sport Touring Confortable	15	2670	0440	2760					
400	Xciting 400 i	12>	2830		3140		2833	3143		
500	Xciting 500	04>	0870		0870		0873	0873		
500	Xciting 500	05>	2640	0890	3140		2643	3143		
500	Xciting 500 i	06>08	2640	0890	3140		2643	3143		
500	Xciting 500 i R	07>09	2640	0890	3140		2643	3143		
700	My Road 700	09>	2640	0890	3140		2643	3143		
KYMCO ATV										
50	Mxer 50	03>			2710					
50	Mxu 50	05>			2710					
50	Mxu 50 Sr	06>			2710					
125	Mxer 125	03>			2710					
150	Mxer 150	03>			2710					
150	Mxu 150	05>			2710					
250	Kxr 250	03>04	3070				3073			
250	Mxu 250	05>	3070		0500		3073			
LAVERDA										
50	Gaucho 50	92>	0010		0010		0013			
50	Or 50 Atlas	87>	0010		0010		0013			
125	125	>82	0010				0013			
125	125	-	3150				3153			
125	Gs 125 Lesmo	86>	0010		0010		0013			
125	Phoenix 125	01>			2710					
125	Phoenix	01	3260							



PASTIGLIE FRENO RMS - SINTER (RICERCA PER MARCA)

RMS - SINTER BRAKE PADS (SEARCH BY BRAND)

CC	MODELLO MODEL	ANNO YEAR	RMS YOUR BEST PARTNER				SINTER			
			ANTERIORE FRONT		POSTERIORE REAR		ANTERIORE FRONT	POSTERIORE REAR		
			PASTIGLIA ORGANICA ORGANIC				PASTIGLIA SINTERIZZATA SINTERED			
			OMOLOGATA HOMOLOGATED	NON OMOLOGATA NOT HOMOLOGATED	GANASCE BRAKE SHOES	OMOLOGATA HOMOLOGATED	NON OMOLOGATA NOT HOMOLOGATED	GANASCE BRAKE SHOES	OMOLOGATA HOMOLOGATED	NON OMOLOGATA NOT HOMOLOGATED
			22 510	22 512	22 510	22 512	22 510	22 510		
150	Phoenix 150	01>			2710					
150	Phoenix	01	3260							
200	Phoenix 200	01>			2710					
200	Phoenix	01	3260							
350	350	80>	0010		0010		0013			
500	Alpino 500	77>	0010		0010		0013			
500	Pf 500	77>	0010		0010		0013			
500	Rs 500	77>	0010		0010		0013			
500	Sfc 500	77>	3150		3150		3153	3153		
600	Or 600	86>	0010				0013			
650	Strada 650	96>	0520		0010		0523	0013		
668	Ghost - Diamante 668	96>	0520		0010		0523	0013		
750	750 S (All Models)	97>	0520		0010		0523	0013		
750	Cup 750	98>	0520		0010		0523	0013		
750	Diamante 750	97>	0520		0010		0523	0013		
750	Sf3 750	77>	3150		3150		3153	3153		
800	Tts 800	99>	0520		0490		0523	0493		
1000	1000 Jota	76>	0520		0010		0523	0013		
1000	1000 Jota	95>	0520				0523			
1000	3Ce 1000	74>	3150		3150		3153	3153		
1000	Jota 1000	95>			3150			3153		
1000	Rgs 1000	83>	3150		3150		3153	3153		
1000	Rgs 1000 Corsa	-	3150		3150		3153	3153		
1000	Rgs 1000 Jota	77>	3150		3150		3153	3153		
1000	Rgs 1000 Jota	86>	3150		3150		3153	3153		
1000	Sfc 1000	85>86	3150		3150		3153	3153		
1000	Sfc 1000	04>	2860		0490		2863	0493		
1000	Tga 1000 Executive	84>	3150		3150		3153	3153		
1200	Mirage 1200	78>	3150		3150		3153	3153		
1200	T.t. 1200	76>	3150		3150		3153	3153		
LEM										
50	Flash 50	94>				0061				
50	Ghibli 50	90>		0061		0061				
50	L2 - L3 50 Cross	03>	3220		3220		3223	3223		
65	Rx 65	05>	3220		3220		3223	3223		
LONCIN										
110	Lx 110 4	02>	0350				0353			
125	Lx 125	02>	0350				0353			
150	Lx 150 6	02>	0410				0413			
MACAL										
50	Flash 50	99>	0190				0193			
50	Trophy 50 (Am5/6)	99>	0080				0083			
50	Trophy 50 H20 (Am5/6)	99>	0080				0083			
MACBOR										
50	Xc 50 510 Racing	04>	0650		0080			0083		
50	Xc 50 512 Pro	04>	0650							
50	Xc 50 512 R 6V	04>	0650		0080			0083		
50	Xc 50 512 Racing	04>	0650		0080			0083		
50	Xc 50 512 T	04>	0650							
MAICO										
50	C 1 50 Hard Enduro	99>	0040			0061				
50	Classic 50	99>		0061		0061				

Con Piastra - With Plate

PASTIGLIE FRENO RMS - SINTER (RICERCA PER MARCA)

RMS - SINTER BRAKE PADS (SEARCH BY BRAND)



CC	MODELLO MODEL	ANNO YEAR	RMS YOUR BEST PARTNER				SINTER			
			ANTERIORE FRONT		POSTERIORE REAR		ANTERIORE FRONT	POSTERIORE REAR		
			PASTIGLIA ORGANICA ORGANIC				PASTIGLIA SINTERIZZATA SINTERED			
			OMOLOGATA HOMOLOGATED	NON OMOLOGATA NOT HOMOLOGATED	GANASCE BRAKE SHOES	OMOLOGATA HOMOLOGATED	NON OMOLOGATA NOT HOMOLOGATED	GANASCE BRAKE SHOES		
			22 510	22 512	22 510	22 512	22 510	22 510		
50	Cruiser 50	99>	0040			0061				
50	R 1 50 Superbike	99>	0040			0061				
50	Thunderbike 50 i	99>	0040			0061				
50	Thunderbike 50 li	99>	0040			0061				
50	Traficjammer 50	99>		0061		0061				
50	X 1 50 Supercross	99>	0040			0061				
250	Cross 250	98>	0430		1330			1333		
250	Cross 250 Gm	84>	0010				0013			
250	Enduro 250	99>	0430		1330			1333		
250	Enduro 250 Gme	84>	0010				0013			
250	Motocross 250	99>	0430		1330			1333		
500	Cross 500	98>	0430		1330			1333		
500	Cross 500 Gm	84>	0010				0013			
500	Enduro 500	99>	0430		1330			1333		
500	Enduro 500 Gme	84>	0010				0013			
500	Motocross 500	99>	0430		1330			1333		
500	Supermotard 500	99>	0430		1330			1333		
MALAGUTI										
50	Centro 50	>92				0091				
50	Centro 50 4T	08>	0040			0560				
50	Centro 50 Sl	93>	0070			0091				
50	Centro Sl 50 4T	10>	0040			0560				
50	Chopper 25 - 40 - 80 - Fifty	>82				0191				
50	Ciak 50	99>	0190			0091	0193			
50	Ciak 50 Master	04>05	0190			0091	0193			
50	Ciak 50 Master 4T	05>06	0190			0560	0193			
50	Ciak 50 Master Eu2	06>	0190			0091	0193			
50	Ciak 50 Mono Eu2,3	03>	0190			0091	0193			
50	Ciak 50 Td	00>01	0190		0190		0193	0193		
50	Ciak 50 Twin Disk	02>	0190		0190		0193	0193		
50	Ciclomotori 50 All Models	>83	0030			0191				
50	Cr1 50 Crosser	95>	0030							
50	Cr1 50 Crosser	97>	0190				0193			
50	Crw 50 Enduro	03>	0080		0080		0083	0083		
50	Crw 50 Motard	03>	0360		2810		0363			
50	Dune 50 Enduro	87>	0030		0030					
50	F 10 50	92>93	1200			0091				
50	F 10 50 Ac	08>	0190			0061	0193			
50	F 10 50 Ac Eco	09>10	0040			0061				
50	F 10 50 All Models	94>	0190			0091	0193			
50	F 10 50 Timermachine	02>	0190			0091	0193			
50	F 10 50 Wap	02>	0190			0091	0193			
50	F 12 50 Mechatronic	03>	0190		0190		0193	0193		
50	F 12 50 Phantom	94>	0030			0091				
50	F 12 50 Phantom Digit	02>	0190		0190		0193	0193		
50	F 12 50 Phantom Liquid Cooled	95>97	0030			0091				
50	F 12 50 Phantom Twin Disk	98>	0070		0190			0193		
50	F 12 50 Racing Life	03>	0190		0190		0193	0193		
50	F 12 50 Tyre Track	03>	0190		0190		0193	0193		
50	F 12 R 50 Phantom Ac	07>08	0190			0061	0193			
50	F 12 R 50 Phantom Ac	09>10	0040			0061				
50	F 12 R 50 Phantom Lc	07>10	0040		0190			0193		



PASTIGLIE FRENO RMS - SINTER (RICERCA PER MARCA)

RMS - SINTER BRAKE PADS (SEARCH BY BRAND)

CC	MODELLO MODEL	ANNO YEAR	RMS YOUR BEST PARTNER				SINTER			
			 ANTERIORE FRONT		 POSTERIORE REAR		 ANTERIORE FRONT	 POSTERIORE REAR		
			PASTIGLIA ORGANICA ORGANIC				PASTIGLIA SINTERIZZATA SINTERED			
			 OMOLOGATA HOMOLOGATED	 NON OMOLOGATA NOT HOMOLOGATED	 GANASCE BRAKE SHOES	 OMOLOGATA HOMOLOGATED	 NON OMOLOGATA NOT HOMOLOGATED	 GANASCE BRAKE SHOES		
			22 510	22 512	22 510	22512	22 510	22 510		
50	F 15 50 Firefox	96>97	0070				0091			
50	F 15 50 Firefox Twin Disk	98>	0070		0190				0193	
50	Fifty 50 Full All Models	83>	0030							
50	Fifty 50 Top	85>	0030							
50	Lx 50 Sport	>82					0191			
50	Mdx Gold 50 Enduro	87>	0070							
50	Mlx 50 Enduro	87>	0070							
50	Mr4 50 Enduro	87>	0030		0030					
50	Nkd 50	04>	0360		0080		0363		0083	
50	Rcw 50 Ronco	>82					0191			
50	Rcx-W 50 Enduro	83>	0030							
50	Rgt 50 Sport	85>	0030							
50	Rgt 50 Strada	83>	0030							
50	Rst 50 Sport Tutti I Tipi	87>	0030		0030					
50	Sahib 50 Enduro	83>	0030							
50	Va 50 Olympique	>82					0191			
50	Xsm 50	03>	0360		2810		0363			
50	Xsm 50 Power-Up	07>08			2730	1430				
50	Xtm 50	03>	0080		2810		0083			
50	Xtm 50 Power-Up	07>08			2730	1430				
50	Yesterday 50	98>	0190				0091	0193		
80	Chopper 80	>82					0191			
100	Ciak 100	99>01	0190		0190		0193		0193	
100	F 12 100 Phantom	99>	0190		0190		0193		0193	
125	Blog 125 ie	09>10	0580		1200		0583			
125	Centro 125 ie	08>09	0580		2730	1430	0583			
125	Centro 125 SL ie	09>10	0580		2730	1430	0583			
125	Ciak 125	00>01	2020				0400			
125	Ciak 125 Master	04>	2020				0400			
125	Ciak 125 Master Eui3	06>	2020				0400			
125	Ciak 125 Restyling Eui2	03>	2020				0400			
125	F 12 125 Max	02>	0360		0310		0363		0313	
125	F 18 125 Warrior	01>	2020		0310				0313	
125	Madison 125	99>02	0360		0310		0363		0313	
125	Madison 3 125	06>09	0360		1500		0363		1503	
125	Madison R 125 Restyling	02>	0360		0310		0363		0313	
125	Madison R 125 Restyling Eui2	03>04	0360		0310		0363		0313	
125	Phantom Max 125	03>	0360		0310		0363		0313	
125	Runner 125 Rally	87>	0060				0063			
125	Runner 125 Ypvs	86>	0060				0063			
125	X3m 125 Enduro	08>			2730	1430				
125	X3m 125 Enduro Motore Bra	08>			2730	1430				
125	X3m 125 Motard	08>			2730	1430				
150	Ciak 150	00>02	2020				0400			
150	Ciak 150 Master	03>	2020							
150	Ciak 150 Restyling Eui2	04>	2020				0400			
150	F 18 150 Warrior	01>	2020		0310				0313	
150	Madison T 150	99>01	0360		0310		0363		0313	
160	Blog 160 ie	09>10	0580		1200		0583			
160	Centro 160 ie	08>09	0580		2730	1430	0583			
160	Centro 160 SL ie	09>10	0580		2730	1430	0583			
180	Madison R 180	01>02	0360		0310		0363		0313	

Con Piastra - With Plate

PASTIGLIE FRENO RMS - SINTER (RICERCA PER MARCA)

RMS - SINTER BRAKE PADS (SEARCH BY BRAND)



CC	MODELLO MODEL	ANNO YEAR	RMS YOUR BEST PARTNER				SINTER			
			 ANTERIORE FRONT		 POSTERIORE REAR		 ANTERIORE FRONT	 POSTERIORE REAR		
			PASTIGLIA ORGANICA ORGANIC				PASTIGLIA SINTERIZZATA SINTERED			
			 OMOLOGATA HOMOLOGATED	 NON OMOLOGATA NOT HOMOLOGATED	 GANASCE BRAKE SHOES	 OMOLOGATA HOMOLOGATED	 NON OMOLOGATA NOT HOMOLOGATED	 GANASCE BRAKE SHOES		
			22 510		22 512	22 510		22 512	22 510	22 510
200	Ciak 200 Master Eu2	06>	2020		0400					
200	F 12 200 Max	02>	0360		0310		0363 0313			
200	Madison 200 All Models	99>	0360		0310		0363 0313			
200	Madison S 200 Restyling	02>	0360		0310		0363 0313			
200	Madison S 200 Restyling Eu2	03>	0360		0310		0363 0313			
200	Phantom Max 200	03>	0360		0310		0363 0313			
250	Madison 250	99>	2670	0440	0310		2673 0313			
250	Madison 3 250	06>09	0360		1500		0363 1503			
250	Madison Rs 250 Restyling	04>	0360		0310		0363 0313			
250	Password 250	05>06	0360		0310		0363 0313			
250	Password 250 Eu3	07>08	0360		0310		0363 0313			
250	Phantom Max 250	04>	0360		0310		0363 0313			
400	Madison 400	02>	2670	0440	0310		2673 0313			
400	Madison 400 Restyling	03>	2670	0440	0310		2673 0313			
500	Gt 500 Spidermax	04>05	0060		0490		0063 0493			
500	Gt 500 Spidermax Eu3	06>07	0060		0490		0063 0493			
500	Rs 500 Spidermax	08>09	0060		0490		0063 0493			
MALANCA										
80	E2 C 80 Cs	-	0010		0010		0013 0013			
125	Gti 125	-	0010		0010		0013 0013			
125	Mark 125 Enduro	-	0010		0013					
MBK										
50	Active 50	90>			0051					
50	Booster 50	>94			0051		0580			
50	Booster 50	>94			0051		0051			
50	Booster 50 Next Generation	96>	3210		0061					
50	Booster 50 R	94>	3210		0051					
50	Booster 50 Spirit	96>	3210		0051					
50	Booster 50 Track	96>	3210		0051					
50	Cr Z 50 Target	91>95	0180		0061					
50	Cs 50 Mach G	02>	0190		0061		0193			
50	Dodo 50	00>	0190		0193					
50	Evolis 50	92>	3210		0061					
50	Fizz 50	94>	3210		0051					
50	Flipper 50	98>	0190		0051		0193			
50	Forte 50	95>	3210		0051					
50	Mach 50	02>	3210							
50	Nitro 50	97>	3210		0280					
50	Ovetto 50	97>	3210		0061					
50	Rocket 50	96>	0190		0061		0193			
50	Sorriso 50	92>			0061					
50	Stun't 50	00>	0190		0061		0193			
50	X-Limit 50	04>	0080		0080		0083 0083			
50	X-Limit 50	98>	0070		0061					
50	X-Power 50	04>	0360		0080		0363 0083			
75	Active 75	90>			0051					
80	Active 80	90>			0051					
80	Evolis 80	94>	3210		0061					
100	Yn R 100 Ovetto	00>	3210		0451					
100	Yq 100 Nitro	00>	3210		0451					
100	Yw 100 Booster	99>	0180							
150	Xc Vertex	97>	2730	1430	0451					



PASTIGLIE FRENO RMS - SINTER (RICERCA PER MARCA)

RMS - SINTER BRAKE PADS (SEARCH BY BRAND)

CC	MODELLO MODEL	ANNO YEAR	RMS YOUR BEST PARTNER				SINTER			
			ANTERIORE FRONT		POSTERIORE REAR		ANTERIORE FRONT	POSTERIORE REAR		
			PASTIGLIA ORGANICA ORGANIC				PASTIGLIA SINTERIZZATA SINTERED			
			OMOLOGATA HOMOLOGATED	NON OMOLOGATA NOT HOMOLOGATED	GANASCE BRAKE SHOES	OMOLOGATA HOMOLOGATED	NON OMOLOGATA NOT HOMOLOGATED	GANASCE BRAKE SHOES	OMOLOGATA HOMOLOGATED	NON OMOLOGATA NOT HOMOLOGATED
			22 510	22 512	22 510	22512	22 510	22 510		
125	Xc 125 Flame	98>	2730	1430			0061			
125	Xc 125 Flame R	98>	2730	1430			0061			
125	Xn 125 Doodo	00>01	3210				0451			
125	Xq 125 Thunder	01>	0430		0490			0493		
125	Yp 125 Skyliner	98>01	0430				0451			
125	Yp 125 Skyliner	02>	0430		0490			0493		
150	Xn 150 Doodo	01>	3210							
150	Xq 150 Thunder	01>	0430		0490			0493		
150	Yp 150 Skyliner	02>	0430		0490			0493		
150	Yp 150 Skyliner	>01	0430							
180	Yp 180 Skyliner	04>	0430		0490			0493		
250	Yp 250 Skyliner	00>	0410		2660		0413	2663		
300	Kilibre 300	03>	0430		0430					
400	Yp 400 Skyliner	04>	0410		2660		0413	2663		
MEGELLI										
125	125 M / R / S	08>			0660			0663		
METRAKIT										
50	Big Foot 50	08>			3220		3223			
50	Fun 50 2 Stroke	05>	0080		0650		0083			
50	Fun 50 4 Stroke	05>	0080		0650		0083			
50	Mini Gp 50	03>	0080		0650		0083			
50	Mini Gp 50 XL	05>	0490		0650		0493			
50	Mongoose 50	08>			3220		3223			
50	Pro 50	08>			3220		3223			
80	Mini Gp 80 XL Pro	04>	0640		0650					
80	XL 08 80	08>			0650					
110	Srm 110 4T	07>			3220		3223			
125	Pre Gp 125	07>	3160		0650		3163			
MINICAR										
500	Microcar 500 (Coppia pastiglie)	-	0540							
505	Grecav 505 Eike (Coppia pastiglie)	-	0540							
MODENAS										
125	Kriss 115	99>	1070				1073			
MONDIAL										
1000	Evo 1000	04>	2860		0490		2863	0493		
1000	Piega 1000	03>	2860		0490		2863	0493		
1000	Rz 1000 Nuda	04>	2860		0490		2863	0493		
1000	Starfighter 1000	04>	2860		0490		2863	0493		
MONTESA										
50	Mks 50	87>	0030							
250	Cota 250 4Rt	05>	0640		0650					
260	Evasion 260	94>	0080		0080		0083	0083		
304	Cota 304	87>	0030							
304	Cota 304	88>	0080		0080		0083	0083		
307	Cota 307	89>	0080		0080		0083	0083		
309	Cota 309	89>	0080		0010		0083	0013		
310	Cota 310	89>	0080		0010		0083	0013		
311	Cota 311	92>	0080		0010		0083	0013		
314	Cota 314 R	94>	0080		0010		0083	0013		
315	Cota 315	97>	0080		0080		0083	0083		
315	Cota 315 (360)	01>04	0640		0650					
335	Cota 335	87>91	0080		0080		0083	0083		

Con Piastra - With Plate

PASTIGLIE FRENO RMS - SINTER (RICERCA PER MARCA)

RMS - SINTER BRAKE PADS (SEARCH BY BRAND)















CC	MODELLO MODEL	ANNO YEAR	RMS YOUR BEST PARTNER				SINTER			
			ANTERIORE FRONT		POSTERIORE REAR		ANTERIORE FRONT	POSTERIORE REAR		
			PASTIGLIA ORGANICA ORGANIC				PASTIGLIA SINTERIZZATA SINTERED			
			OMOLOGATA HOMOLOGATED	NON OMOLOGATA NOT HOMOLOGATED	GANASCE BRAKE SHOES	OMOLOGATA HOMOLOGATED	NON OMOLOGATA NOT HOMOLOGATED	GANASCE BRAKE SHOES		
			22 510		22 512	22 510		22 512	22 510	22 510
335	Cota 335	89>	0080		0080		0083	0083		
360	H7-S 360 Enduro	86>	0030							
360	M7 360 Enduro	86>	0080				0083			
	All Models Trial	01>	0640		0650					
MOTO GUZZI										
50	Chiu' 50	74>76			0191	0191				
50	Dingo 50 3 V	75>76			0191	0191				
50	Dingo 50 3M	66>74			0191	0191				
50	Dingo 50 M	69>73			0191	0191				
50	Dingo 50 Mm	75>76			0191	0191				
50	Magnum 50	75>76			0191	0191				
50	Trotter 50	66>70			0191	0191				
50	Trotter 50 Mark M - V	71>73			0191	0191				
50	Trotter 50 Special M - V	71>73			0191	0191				
50	Trotter 50 Super	66>70			0191	0191				
125	2C 125 4T	79>	0010				0013			
125	Tt 125	85>	0010				0013			
250	Ts 250	76>82	0010		0010	0013		0013		
350	Gts 350	74>79	0010		0010	0013		0013		
350	Nevada 350	93>	0010		0010	0013		0013		
350	Ntx 350	90>			3150	3153				
350	Ntx 350	87>	0010		0010	0013		0013		
350	Ntx 350	90>	0010				0013			
350	V 35 350 Gt	90>	3150				3153			
350	V 35 350	77>	0010		0010	0013		0013		
350	V 35 350 C	82>	0010		0010	0013		0013		
350	V 35 350 Florida	87>	0010		0010	0013		0013		
350	V 35 350 Gt	90>			0010	0013		0013		
350	V 35 350 Imola	70>83	0010		0010	0013		0013		
350	V 35 350 Imola II	84>	0010		0010	0013		0013		
350	V 35 350 Tt Enduro	84>	0010		0010	0013		0013		
400	Gts 400	74>79	0010		0010	0013		0013		
500	V 50 500	77>80	0010		0010	0013		0013		
500	V 50 500 C	82>	0010		0010	0013		0013		
500	V 50 500 II	80>	0010		0010	0013		0013		
500	V 50 500 Monza	80>83	0010		0010	0013		0013		
500	V 50 500 Monza II	84>	0010		0010	0013		0013		
650	Gt 650 Sessantacinque	89>	0010		0010	0013		0013		
650	Nevada 650	92>96	0010		0010	0013		0013		
650	Nevada 650 Club / Base	97>02	0010		0010	0013		0013		
650	Ntx 650	90>			3150	3153				
650	Ntx 650	90>	0010				0013			
650	V 65 650 Gt	90>	3150				3153			
650	V 65 650	81>83	0010		0010	0013		0013		
650	V 65 650 Florida	87>	0010		0010	0013		0013		
650	V 65 650 Gt	90>			0010	0013		0013		
650	V 65 650 II Enduro	84>	0010		0010	0013		0013		
650	V 65 650 Lario	84>	0010		0010	0013		0013		
650	V 65 650 Sp Chopper	81>	0010		0010	0013		0013		
650	Vt 650 Tt Baja	86>			0010	0013		0013		
750	Breva 750	03>06	1100		0490	1103		0493		
750	Griso 750	04>	2860		0490	2863		0493		



PASTIGLIE FRENO RMS - SINTER (RICERCA PER MARCA)

RMS - SINTER BRAKE PADS (SEARCH BY BRAND)

CC	MODELLO MODEL	ANNO YEAR	 YOUR BEST PARTNER					
			 ANTERIORE FRONT		 POSTERIORE REAR		 ANTERIORE FRONT	 POSTERIORE REAR
			PASTIGLIA ORGANICA ORGANIC				PASTIGLIA SINTERIZZATA SINTERED	
								
			OMOLOGATA HOMOLOGATED	NON OMOLOGATA NOT HOMOLOGATED	GANASCE BRAKE SHOES	OMOLOGATA HOMOLOGATED	NON OMOLOGATA NOT HOMOLOGATED	GANASCE BRAKE SHOES
750	Ippogrifo	97>	0520				0523	
750	Nevada 750 Club	03>	1100		0490		1103	0493
750	Ntx 750	90>			3150			3153
750	S 750	74>75	3150				3153	
750	S3 750	75>76	3150		3150		3153	3153
850	California 850 T3	75>80	3150		3150		3153	3153
850	Le Mans 850	76>	3150		3150		3153	3153
850	T 850	74>75	3150				3153	
850	T 5 850	84>	3150		3150		3153	3153
850	T3 850	75>	3150		3150		3153	3153
850	T4 850	80>	3150		3150		3153	3153
1000	California 1000 II	81>	3150		3150		3153	3153
1000	California 1000 II C	91>	3150		3150		3153	3153
1000	California 1000 Ev	99>	0520		1010		0523	1013
1000	Daytona 1000	91>			3150			3153
1000	Daytona 1000	91>	0520				0523	
1000	Gt V 1000	91>	3150		3150		3153	3153
1000	Le Mans 1000	84>	3150		3150		3153	3153
1000	Le Mans - V 1000	90>	3150		3150		3153	3153
1000	Sp 1000	78>83	3150				3153	
1000	Sp 1000 II	84>	3150		3150		3153	3153
1000	Sp Iii 1000	91>	3150		3150		3153	3153
1000	V 1000 1000 G5	78>	3150		3150		3153	3153
1000	V 1000 1000 I Convert	75>	3150		3150		3153	3153
1100	Breva 1100	04>	1100		0490		1103	0493
1100	Breva 1100	05>	1100		1010		1103	1013
1100	California 1100	94>96	3150		3150		3153	3153
1100	California 1100	01>	1100		1010		1103	1013
1100	California 1100 Classic Touring	06>	1100		1010		1103	1013
1100	California 1100 Ev	97>00	0520		1010		0523	1013
1100	California 1100 Ev	01>05	1100		0010		1103	0013
1100	California 1100 Ev	06>	1100		1010		1103	1013
1100	California 1100 Ev Touring	04>	1100		1010		1103	1013
1100	California 1100 Jackal	00>	0520		1010		0523	1013
1100	California 1100 Jackal	01>	1100		1010		1103	1013
1100	California 1100 Jackal Basic	00>	0520		1010		0523	1013
1100	California 1100 Jackal Basic	01>	1100		1010		1103	1013
1100	California 1100 Special	99>00	0520		1010		0523	1013
1100	California 1100 Special	01>	1100		1010		1103	1013
1100	Griso 1100	05>	1100		0430		1103	
1100	Quota 1100	99>	1010		1010		1013	1013
1100	Sport 1100	01>			3150			3153
1100	Sport 1100	94>00	0520		0010		0523	0013
1100	Sport 1100	01>	1100				1103	
1100	V 11 1100 Le Mans	01>	1100		0010		1103	0013
1100	V 11 1100 Scura	02>	1100		0010		1103	0013
1100	V 11 1100 Sport	97>00	0520		0010		0523	0013
1100	V 11 1100 Sport	01>	1100		0010		1103	0013
1100	V 11 1100 Sport Naked	01>	1100		0010		1103	0013
1100	V 11 1100 Sport Rosso Mandell	01>	1100		0010		1103	0013
1100	V 11 1100 Sport Scura	02>	1100		0010		1103	0013
1200	Griso 1200 8V	05>	1100		0430		1103	

□ Con Piastra - With Plate

PASTIGLIE FRENO RMS - SINTER (RICERCA PER MARCA)

RMS - SINTER BRAKE PADS (SEARCH BY BRAND)



CC	MODELLO MODEL	ANNO YEAR	RMS YOUR BEST PARTNER				SINTER			
			ANTERIORE FRONT		POSTERIORE REAR		ANTERIORE FRONT	POSTERIORE REAR		
			PASTIGLIA ORGANICA ORGANIC				PASTIGLIA SINTERIZZATA SINTERED			
			OMOLOGATA HOMOLOGATED	NON OMOLOGATA NOT HOMOLOGATED	GANASCE BRAKE SHOES	OMOLOGATA HOMOLOGATED	NON OMOLOGATA NOT HOMOLOGATED	GANASCE BRAKE SHOES		
			22 510		22 512	22 510		22 512	22 510	22 510
1200	Mgs-01 1200 Corsa	05>	2860			0490		2863	0493	
1200	Norge 1200	06>	1100			0430		1103		
1200	Norge 1200 Abs	06>	1100			0430		1103		
1200	Sport 1200	06>	1100			0430		1103		
1200	Sport 1200 Abs	06>	1100			0430		1103		
1200	Stelvio 1200	08>	1100			0430		1103		
MOTO MORINI										
125	Blues 125	93>	0060			0010		0063	0013	
350	Cogauro 350	90>				0010			0013	
350	Dart 350	88>89				0010			0013	
350	Dart 350	90>				0010			0013	
350	Exalibur Rlx 350	90>				0010			0013	
350	Excalibur 350	86>89	0060					0063		
350	Kanguro 350	87>	0060			0010		0063	0013	
350	New York 350	89>				0010			0013	
350	Ws 350 Pro Action	93>				0010			0013	
400	Dart 400	90>				0010			0013	
501	Camel 501	87>	0060			0010		0063	0013	
501	Camel 501	>86	0010							
501	Coguardo 501	89>				0010			0013	
501	Excalibur 501	86>86	0060					0063		
501	Excalibur 501	87>88	0060			0010		0063	0013	
501	Excalibur 501	89>				0010			0013	
501	New York 501	89>				0010			0013	
950	9 1/2 950	06>	1100			0490		1103	0493	
1200	Corsaro 1200	06>	1100			0490		1103	0493	
1200	Gran Passo 1200	08>	1010			0430		1013		
1200	Granferro 1200	10>	2860			0430		2863		
1200	Gt 1200	10>	1010			0430		1013		
1200	Scrambler 1200	09>	1010			0430		1013		
1200	Sport 1200	08>	1100			0490		1103	0493	
MOTOR UNION										
125	Jc 125 2B Deer	98>	2630					2633		
250	Hk 250 Haoke	97>	1070					1073		
MOTORHISPANIA										
50	Mx 50 Furia	00>	0080			0080		0083	0083	
50	Rx 50 Racing	00>	0060			0080		0063	0083	
50	Rx 50 Racing	04>05	0740			0080			0083	
50	Ryz 50 Cross	04>05	0080			0080		0083	0083	
50	Ryz 50 Enduro	05>	0080			0080		0083	0083	
50	Ryz 50 Supermotard	04>05	0740			0080			0083	
125	Ryz 125 Arena Enduro	05>	0080			0080		0083	0083	
MOTRON										
50	Compact 50 Racing Es	89>92	0030							
50	Compact 50 Wf	88>92	0030							
50	Gl 4 50 Flash Id	89>93	0030							
50	Kcv 50	-	1440							
50	Rz 1 50 Es	89>94	0030							
50	Spike 50	98>	0190					0193		
50	Sting 50	95>	0030							
50	Syncro 50	98>	0190					0193		
50	Thunder 50	95>	0190					0193		



PASTIGLIE FRENO RMS - SINTER (RICERCA PER MARCA)

RMS - SINTER BRAKE PADS (SEARCH BY BRAND)

CC	MODELLO MODEL	ANNO YEAR								
			 ANTERIORE FRONT		 POSTERIORE REAR		 ANTERIORE FRONT	 POSTERIORE REAR		
			PASTIGLIA ORGANICA ORGANIC				PASTIGLIA SINTERIZZATA SINTERED			
			 OMOLOGATA HOMOLOGATED	 NON OMOLOGATA NOT HOMOLOGATED	 GANASCE BRAKE SHOES	 OMOLOGATA HOMOLOGATED	 NON OMOLOGATA NOT HOMOLOGATED	 GANASCE BRAKE SHOES		
			22 510	22 512	22 510	22512	22 510	22 510		
50	Xle 50	88>93	0030		0010			0013		
MV AGUSTA										
910	Brutale 910 R	05>06	2860					2863		
989	Brutale 989 R	08>	1100					1103		
1000	F4 1000 R	06>	2860					2863		
1000	F4 1000 R 312	06>	2860					2863		
1000	F4 1000 Senna	06>	2860					2863		
1078	Brutale 1078 Rr	08>						2923		
1078	F4 1078 Rr 312 / Cc	08>						2923		
1090	Brutale 1090 Rr	10>						2923		
800	Rivale 800	13>						3193		
MZ										
50	Moskito 50	99>	0180							
50	Moskito 50 Sx	00>	0040							
125	Etz 125	82>	3150					3153		
125	Etz 125	85>	3150					3153		
125	Mantizz S 125	07>	2590					2593		
125	Moskito 125	99>	0180							
125	Roadstar 125	-	3150					3153		
125	Sm 125	02>	0580					0583		
125	Sportstar 125	93>	3150					3153		
125	Sx 125	02>	0580					0583		
150	Etz 150	82>	3150					3153		
250	Etz 250	82>	3150					3153		
251	Sportstar 251	96>	3150		3150			3153 3153		
300	Etz 300	88>	3150					3153		
301	Etz 301	90>	3150					3153		
301	Sportstar 301	96>	3150		3150			3153 3153		
500	Saxon 500 All Models	92>	3150		3150			3153 3153		
500	Silver 500 Star Classic	93>	3150		3150			3153 3153		
660	Skorpion 660 Sport	95>99	0520					0523		
660	Skorpion 660 Tour	95>99	0520					0523		
660	Skorpion 660 Traveller	99>	0520					0523		
1000	S 1000 (Muz)	01>02	1100		0410			1103 0413		
1000	S 1000 (Muz)	03>	3030					3033 3113		
1000	Sf 1000 (Muz)	05>	3030					3033 3113		
1000	Sfx 1000 (Muz)	07>	3030					3033 3113		
1000	Sn 1000 (Muz)	05>	3030					3033 3113		
1000	St 1000 (Muz)	06>	3030					3033 3113		
NORTON										
	Commander	90>	3150		3150			3153 3153		
	F 1 Formula	89>	0520		0010			0523 0013		
	Formula 1 Sport	92>	0520		0010			0523 0013		
	Interpol 2 (Rotary)	83>	3150		3150			3153 3153		
	Tt	92>	0520		0010			0523 0013		
	Wankel Classic 2 (Rotary)	88>	3150		3150			3153 3153		
OSSA										
280	280 I	10>	0640		0650					
PETERSON										
50	Hurricane 50	95>	0180		0040					
50	Sr 50 Racing	95>	0180		0040					
80	Hurricane 80	95>	0180		0040					

□ Con Piastra - With Plate

PASTIGLIE FRENO RMS - SINTER (RICERCA PER MARCA)

RMS - SINTER BRAKE PADS (SEARCH BY BRAND)

















CC	MODELLO MODEL	ANNO YEAR	RMS YOUR BEST PARTNER				SINTER			
			ANTERIORE FRONT		POSTERIORE REAR		ANTERIORE FRONT	POSTERIORE REAR		
			PASTIGLIA ORGANICA ORGANIC				PASTIGLIA SINTERIZZATA SINTERED			
			OMOLOGATA HOMOLOGATED	NON OMOLOGATA NOT HOMOLOGATED	GANASCE BRAKE SHOES	OMOLOGATA HOMOLOGATED	NON OMOLOGATA NOT HOMOLOGATED	GANASCE BRAKE SHOES		
			22 510	22 512	22 510	22 512	22 510	22 510		
80	Sr 80 Racing	95>	0180		0040					
PEUGEOT										
50	Asv 50 (Forcella Telescopica)	93>	1200			0091				
50	Blaster 50	09>	0080				0083			
50	Blaster 50 Rs 12	09>	0080				0083			
50	Buxi 50	94>	0190			0091	0193			
50	Buxi Rs 50	94>	0040							
50	Elyseo 50	98>	0080				0083			
50	Elystar 50	03>05	0080		2810		0083			
50	Jet C-Tech 50	09>	0080		0080		0083 0083			
50	Jet Force 50	03>	0080		0080		0083 0083			
50	Kisbee 50	10>	0080				0083			
50	Looxor 50	01>05	0080				0083			
50	Looxor 50	06>	0080		0080		0083 0083			
50	Ludix 50	04>	0080				0083			
50	New Vivacity 50	10>	1440							
50	Nk 7 50	09>12	3160				3163			
50	Speedake 50	95>	0190			0091	0193			
50	Speedfight 50 (Raff. Acqua Pinze Ajp)	98>	0080		0080		0083 0083			
50	Speedfight 50 M (Pinza Ajp)	97>98	0080				0083			
50	Speedfight 50 M (Pinza Heng-Tong)	97>	0040							
50	Squab 50	95>95	1200			0091				
50	Squab 50	96>	0040							
50	Sv 50 Geo (All Models)	93>	2630				2633			
50	Sv 50 T (Forcella Telescopica)	93>	1200			0091				
50	Tkr 50 Furious	05>	0080				0083			
50	Tkr 50 Wrc	05>	0080				0083			
50	Trekker 50 Road	97>	0040							
50	V-Click 50	08>	0180							
50	Vivacity 50 (Forcelle Paioli)	98>	0080				0083			
50	Vivacity 50 (Pinza Heng tong)	05>	0040							
50	X Fight 50 (Raffreddamento Liquido)	00>	0080		0080		0083 0083			
50	X Fight 50 M	00>	0080				0083			
50	Xp 6 50 Enduro	06>	0080		0080		0083 0083			
50	Xp 6 50 Supermotard	06>	0080		0080		0083 0083			
50	Xp 6 50 Trail	04>	0080		0080		0083 0083			
50	Xp S6 50 Enduro	04>	0080		0080		0083 0083			
50	Xp S6 50 Supermotard	03>	0360		2810		0363			
50	Xr 6 50 Race Spec	02>07	0740		0080		0083			
50	Xr 7 50	08>			3160		3163			
50	Zenith 50	92>		0170		0091				
50	Zenith 50	96>	0080				0083			
80	Sv Geo	91>92		0170						
100	Elyseo 100	02>	0080		0080		0083 0083			
100	Elyseo 100	98>01	0080				0083			
100	Looxor 100	02>	0080		0080		0083 0083			
100	Speedfight 100	97>	0080		0080		0083 0083			
100	Trekker 100	98>	0080				0083			
100	Vivacity 100 (Pinza Heng tong)	05>	0040							
100	Vivacity 100 .	98>	0080				0083			
100	X Fight 100 (Raffreddamento Liquido)	00>	0080		0080		0083 0083			
100	X Fight 100 M	00>	0080				0083			



PASTIGLIE FRENO RMS - SINTER (RICERCA PER MARCA)

RMS - SINTER BRAKE PADS (SEARCH BY BRAND)

CC	MODELLO MODEL	ANNO YEAR	 YOUR BEST PARTNER							
			 ANTERIORE FRONT		 POSTERIORE REAR		 ANTERIORE FRONT	 POSTERIORE REAR		
			PASTIGLIA ORGANICA ORGANIC				PASTIGLIA SINTERIZZATA SINTERED			
			 OMOLOGATA HOMOLOGATED	 NON OMOLOGATA NOT HOMOLOGATED	 GANASCE BRAKE SHOES	 OMOLOGATA HOMOLOGATED	 NON OMOLOGATA NOT HOMOLOGATED	 GANASCE BRAKE SHOES	 OMOLOGATA HOMOLOGATED	 NON OMOLOGATA NOT HOMOLOGATED
			22 510		22 512	22 510		22512	22 510	22 510
125	Elyseo 125	00>	0360			2810		0363		
125	Elyseo 125	98>	0080				0400	0083		
125	Elystar 125	02>	0360			2810		0363		
125	Geopolis 125	06>	0360			2620		0363	2623	
125	Jet Force 125	03>04	0360			2810		0363		
125	Looxor 125	03>	0970			0080		0973	0083	
125	Ludix 125	04>	0080					0083		
125	Lxr 125	10>	1420					1423		
125	Rs 125 Geopolis	10>	2620			2810		2623		
125	Satelis 125	04>	0080			2810		0083		
125	Satelis 125	06>	0360			0080		0363	0083	
125	Satelis 125 Abs	04>	0870			2810		0873		
125	Sv 125 C Executive	96>	2630					2633		
125	Sv 125 Executive	94>	2630					2633		
125	Sv 125 Geo	92>92		0170			0091			
125	Sv 125 Geo	93>	2630					2633		
125	Vivacity 125	10>	1420					1423		
150	Elyseo 150	01>	0360			2810		0363		
150	Elyseo 150	99>	0080					0083		
150	Elystar 150	02>	0360			2810		0363		
150	Looxor 150	03>	2670	0440				2673		
200	Lxr 200	10>	1420					1423		
250	Geopolis 250	06>	2620			2620		2623	2623	
250	Geostyle 250	10>	1420			1420		1423	1423	
250	Satelis 250	06>	2620			2620		2623	2623	
250	Sv 250	01>	0340			2610		0343	2613	
400	Geopolis 400 (Pinze Ajp)	07>	0360			2810		0363		
400	Geopolis 400 (Pinze Nissin)	07>	1420			1420		1423	1423	
400	Geopolis 400 Rs	08>	0870			1420		0873	1423	
500	Satelis 500	06>	0490			0490		0493	0493	
500	Satelis 500	07>	0870			1420		0873	1423	
600	Satelis 600 Abs	04>	0870			2810		0873		
PGO										
50	Big Max 50	94>02	0180							
50	Big Max 50	03>	0040							
50	Big Max 50 Cromo	-	0040							
50	Comet 50	91>	0040							
50	Dr Big 50	01>	2750					2753		
50	G Max 50	06>	2750					2753		
50	G Max 50 Doppler	06>	0010					0013		
50	Galaxi 50	92>	0040							
50	Galaxi 90	92>	0040							
50	Libra 50	10>	2750					2753		
50	Ligero 50	06>	2750					2753		
50	Mega 50	-	0040							
50	Pm 50 X	-	0180							
50	Pm 50 X Sport	00>	2750					2753		
50	Ps 50	93>	0040							
50	Tornado 50	-	0180							
50	T-Rex 50 2T	00>	2750					2753		
90	Big Max 90	95>	0180							
90	Rodoshow 90	02>	3210							

Con Piastra - With Plate

PASTIGLIE FRENO RMS - SINTER (RICERCA PER MARCA)

RMS - SINTER BRAKE PADS (SEARCH BY BRAND)



CC	MODELLO MODEL	ANNO YEAR	RMS YOUR BEST PARTNER				SINTER			
			ANTERIORE FRONT		POSTERIORE REAR		ANTERIORE FRONT	POSTERIORE REAR		
			PASTIGLIA ORGANICA ORGANIC				PASTIGLIA SINTERIZZATA SINTERED			
			OMOLOGATA HOMOLOGATED	NON OMOLOGATA NOT HOMOLOGATED	GANASCE BRAKE SHOES	OMOLOGATA HOMOLOGATED	NON OMOLOGATA NOT HOMOLOGATED	GANASCE BRAKE SHOES		
			22 510	22 512	22 510	22 512	22 510	22 510		
100	My Bubu 100	02>	2750				2753			
125	Charge 125	02>	2750				2753			
125	Libra 125	10>	1420				1423			
125	Ligero 125	06>	2750				2753			
125	My Bubu 125	02>	2750				2753			
125	T-Rex 125 2T	00>	2750				2753			
125	T-Rex 125 4T	95>	2750				2753			
125	X Hot 125	10>	1420				1423			
150	Br 150 Bugxter	05>			1440					
150	Tr 3 150	02>	2750				2753			
150	T-Rex 150 4T	00>	2750				2753			
250	G Max 250	06>	0520				0523			
	I Dep	09>	2750				2753			
PGO ATV										
50	50 Bugdrider	06>			1440					
50	X Rider 50	03>			0040					
125	X Rider 125	03>			0040					
150	Br 150 E Bugdrider	04>07			1440					
150	X Rider 150	03>			0040					
PIAGGIO										
50	Dna 50	00>	0360		0450		0363	0453		
50	Fly 50 2T	05>07	2620			0560	2623			
50	Fly 50 2T	10>	2620			0560	2623			
50	Fly 50 4T	05>10	2620			0560	2623			
50	Free 50	93>95			0191					
50	Free 50	96>	0070			0360				
50	Free 50 (Ruote In Lega)	96>				0301				
50	Liberty 50	97>	0300			0560	0303			
50	Liberty 50 4T	00>	0300			0560	0303			
50	Nrg 50	94>95	0190			0301	0193			
50	Nrg 50	96>	0190				0193			
50	Nrg 50 Mc2	96>	0190				0193			
50	Nrg 50 Mc2 Dd	98>	0190		0300		0193	0303		
50	Nrg 50 Mc3	05>	0190		0300		0193	0303		
50	Nrg 50 Power Dd	04>05	0190		0300		0193	0303		
50	Nrg 50 Purejet	02>04	0190		0300		0193	0303		
50	Ntt 50	96>	0190				0193			
50	Ntt 50	>95	0190			0301	0193			
50	Quartz 50	92>	0160			0301				
50	Sfera 50	91>				0301				
50	Sfera 50 Rst	95>				0360				
50	Velofax 50	96>			0351					
50	Vespa 50	-			0171					
50	Vespa 50 Et2	97>	0300			0351	0303			
50	Vespa 50 Et4	99>	0300			0351	0303			
50	Vespa 50 Hp	92>			0570		0570			
50	Vespa 50 Lx 2T	05>	0300			0351	0303			
50	Vespa 50 Lx 2T Touring	10>	0300			0351	0303			
50	Vespa 50 Lx 4T	05>	0300			0351	0303			
50	Vespa 50 Lx 4T 4V Touring	10>	0300			0351	0303			
50	Vespa 50 Pk Special - XL	86>			0171		0161			
50	Vespa 50 Pk XL 2	-			0570		0570			



PASTIGLIE FRENO RMS - SINTER (RICERCA PER MARCA)

RMS - SINTER BRAKE PADS (SEARCH BY BRAND)

CC	MODELLO MODEL	ANNO YEAR	RMS YOUR BEST PARTNER				SINTER			
			ANTERIORE FRONT		POSTERIORE REAR		ANTERIORE FRONT	POSTERIORE REAR		
			PASTIGLIA ORGANICA ORGANIC				PASTIGLIA SINTERIZZATA SINTERED			
			OMOLOGATA HOMOLOGATED	NON OMOLOGATA NOT HOMOLOGATED	GANASCE BRAKE SHOES	OMOLOGATA HOMOLOGATED	NON OMOLOGATA NOT HOMOLOGATED	GANASCE BRAKE SHOES	OMOLOGATA HOMOLOGATED	NON OMOLOGATA NOT HOMOLOGATED
			22 510	22 512	22 510	22512	22 510	22 510		
50	Vespa 50 Pk XL 2 Automatica	-		0570						
50	Vespa 50 Special	-		0171		0181				
50	Vespa 50 V FL 2	90>		0570		0570				
50	Zip 50	92>93				0301				
50	Zip 50	99>				0351				
50	Zip 50 Fast Rider	93>95	0190			0360	0193			
50	Zip 50 Fast Rider	95>	0190			0351	0193			
50	Zip 50 Rst	96>97				0351				
50	Zip 50 Rst	98>	0300				0303			
50	Zip 50 Sp	96>	0300			0351	0303			
80	Sfera 80	94>				0301				
90	Vespa 90 Primavera	-		0171		0181				
100	Fly 100 4T	06>08	2620			0421	2623			
100	Free 100	01>	0300			0421	0303			
125	Beverly 125 (Pinza Grimeca)	01>	0360		0360		0363	0363		
125	Beverly 125 (Pinza Heng tong)	01>	2620		2620		2623	2623		
125	Beverly 125 Rst	05>	2620		2620		2623	2623		
125	Beverly 125 Rst 4T 4V ie Eu3	10>	2620		2620		2623	2623		
125	Carnaby 125	07>10	2620		2620		2623	2623		
125	Dna 125	00>	0360		0450		0363	0453		
125	Fly 125	05>07	2620			0421	2623			
125	Fly 125 Eu3	07>08	2620			0421	2623			
125	Hexagon 125	94>	0190			0351	0193			
125	Hexagon 125 Lx	98>	0360			0421	0363			
125	Liberty 125 4 T	98>	0300			0421	0303			
125	Mp3 125	06>08	0300		0780		0303			
125	Mp3 125 Ibrido	09>10	0300		2620		0303	2623		
125	Mp3 125 ie	08>09	0300		2620		0303	2623		
125	Sfera 125	95>								
125	Sfera 125 (4 Tempi)	96>	0300			0351	0303			
125	Skipper 125	93>97	0160			0351				
125	Skipper 125 St 4T	98>	0360			0421	0363			
125	Super Hexagon 125 Gtx	01>	2620		0450		2623	0453		
125	Super Hexagon 125 Gtx	>00	0360		0300		0363	0303		
125	Vespa 125	51>62		0171		0551				
125	Vespa 125	63>72		0171		0531				
125	Vespa 125 Et3	-		0171		0181				
125	Vespa 125 Et4	96>	0300			0351	0303			
125	Vespa 125 Granturismo L (Pinza Grim.)	03>	0360		0450		0363	0453		
125	Vespa 125 Granturismo L Pinza H. T.)	03>	2620		0450		2623	0453		
125	Vespa 125 Lx	05>	0300			0351	0303			
125	Vespa 125 Lx ie Eu3	09>10	0300			0351	0303			
125	Vespa 125 Lx Touring	10>	0300			0351	0303			
125	Vespa 125 Lxv ie 4T	10>	0300			0351	0303			
125	Vespa 125 Pk Automatica	84>		0570						
125	Vespa 125 Pk Special - XL	86>		0570		0570				
125	Vespa 125 Pk XL 2	-		0570		0570				
125	Vespa 125 Primavera	-		0171		0181				
125	Vespa 125 Px	78>		0570		0570				
125	Vespa 125 Px	98>	0160			0161				
125	Vespa 125 Px Arcobaleno	83>		0570		0570				
125	Vespa 125 S 4T ie & College	09>10	0300			0351	0303			

□ Con Piastra - With Plate

PASTIGLIE FRENO RMS - SINTER (RICERCA PER MARCA)

RMS - SINTER BRAKE PADS (SEARCH BY BRAND)



CC	MODELLO MODEL	ANNO YEAR	RMS YOUR BEST PARTNER						SINTER			
			 ANTERIORE FRONT			 POSTERIORE REAR			 ANTERIORE FRONT	 POSTERIORE REAR		
			PASTIGLIA ORGANICA ORGANIC						PASTIGLIA SINTERIZZATA SINTERED			
			 OMOLOGATA HOMOLOGATED		 NON OMOLOGATA NOT HOMOLOGATED		 OMOLOGATA HOMOLOGATED		 NON OMOLOGATA NOT HOMOLOGATED			
			GANASCE BRAKE SHOES		GANASCE BRAKE SHOES		GANASCE BRAKE SHOES		GANASCE BRAKE SHOES			
22 510		22 512		22 510		22 512		22 510	22 510			
125	Vespa 125 V FL2	91>	0570		0570							
125	X 125 Evo	07>	2620		2600		2623	2603				
125	X7 125	08>	2620		2620		2623	2623				
125	X8 125	04>	2620		0490		2623	0493				
125	X8 125 (Pinza Heng tong)	05>	2620		0780		2623					
125	X8 125 Premium	06>	2620		0780		2623					
125	X8 125 Street Eu3	06>	2620			0421	2623					
125	X9 125 Evolution	01>03	0490		0490		0493	0493				
125	X9 125 Evolution	05>07	2600		0490		2603	0493				
125	X9 125 Evolution (Pinza Dx Heng tong)	01>	2600		0780		2603					
125	X9 125 Evolution (Pinza Sx Heng tong)	01>	2620		0780		2623					
125	Zip 125	00>	0300			0351	0303					
150	Fly 150	05>07	2620				2623					
150	Fly 150 Eu3	08>10	2620				2623					
150	Hexagon 150	94>99	0190			0351	0193					
150	Liberty 150 Le	00>	0300			0421	0303					
150	Skipper 150	93>97	0160			0351						
150	Skipper 150 St 4T	98>	0360			0421	0363					
150	Vespa 150	51>62		0171		0551						
150	Vespa 150	63>72		0171		0531						
150	Vespa 150 Et4	96>	0300			0351	0303					
150	Vespa 150 Lx	05>	0300			0351	0303					
150	Vespa 150 Lx ie Eu3	09>10	0300			0351	0303					
150	Vespa 150 Lx Touring	10>	0300			0351	0303					
150	Vespa 150 Px	78>		0570		0570						
150	Vespa 150 Px	98>	0160			0161						
150	Vespa 150 Px Arcobaleno	83>		0570		0570						
150	Vespa 150 S 4T ie & College	09>10	0300			0351	0303					
150	Vespa 150 Sprint Veloce	-		0520		0161		0523				
150	Vespa 150 Super	-		0171		0540						
150	X8 150 Street Eu3	06>	2620			0421	2623					
160	Vespa 160 Gs	-		0520		0161		0523				
180	Dna 180	01>	0360		0450		0363	0453				
180	Hexagon 180 Lx	98>	0360			0421	0363					
180	Super Hexagon 180 Gtx	01>	2620		0450		2623	0453				
180	Super Hexagon 180 Gtx	>00	0360		0300		0363	0303				
180	Vespa 180 Ss	-		0520		0161		0523				
180	X9 180 Amalfi	01>	0490		0490		0493	0493				
200	Beverly 200 (Pinza Grimeca)	01>	0360		0360		0363	0363				
200	Beverly 200 (Pinza Heng tong)	01>	2620		2620		2623	2623				
200	Carnaby 200	07>08	2620		2620		2623	2623				
200	Liberty 200 4T	06>	0300			0421	0303					
200	Liberty 200 4T Sport	06>	0300			0421	0303					
200	Vespa 200 GT L (Pinza Grimeca)	03>	0360		0450		0363	0453				
200	Vespa 200 GT L (Pinza Heng tong)	03>	2620		0450		2623	0453				
200	Vespa 200 Pe	83>		0570		0570						
200	Vespa 200 Px	98>	0160			0161						
200	Vespa 200 Px Arcobaleno	83>		0570		0570						
200	Vespa 200 Px E	78>		0570		0570						
200	Vespa 200 Rally	-		0520		0161		0523				
200	X8 200	04>	2620		0490		2623	0493				
200	X8 200 (Pinza Heng tong)	05>	2620		0780		2623					

Con Piastra - With Plate



PASTIGLIE FRENO RMS - SINTER (RICERCA PER MARCA)

RMS - SINTER BRAKE PADS (SEARCH BY BRAND)

CC	MODELLO MODEL	ANNO YEAR	RMS YOUR BEST PARTNER				SINTER			
			ANTERIORE FRONT		POSTERIORE REAR		ANTERIORE FRONT	POSTERIORE REAR		
			PASTIGLIA ORGANICA ORGANIC				PASTIGLIA SINTERIZZATA SINTERED			
			22 510	22 512	22 510	22 512	22 510	22 510	22 510	22 510
200	X9 200 Evolution	03>	0490		0490		0493	0493		
250	Beverly 250 Cruiser	07>	2620		2620		2623	2623		
250	Beverly 250 Eu3	06>	2620		2620		2623	2623		
250	Beverly 250 Leader	04>	2620		2620		2623	2623		
250	Beverly 250 Rst	05>	2620		2620		2623	2623		
250	Beverly 250 Sport	06>	2620		2620		2623	2623		
250	Carnaby 250	08>	2620		2620		2623	2623		
250	Hexagon 250	98>	0360			0400	0363			
250	Mp3 250	06>08	0300		0780		0303			
250	Mp3 250 Lt	09>	0300		2620		0303	2623		
250	Mp3 250 Mic	08>09	0300		2600		0303	2603		
250	Super Hexagon 250 Gtx	00>	0360		0450		0363	0453		
250	Vespa 250 Gts (Pinza Grimeca)	05>	0360		0450		0363	0453		
250	Vespa 250 Gts (Pinza Heng tong)	05>	2620		0450		2623	0453		
250	Vespa 250 Gtv	06>	2620		0450		2623	0453		
250	X 250 Evo	07>	2620		2600		2623	2603		
250	X7 250 Eu3	08>	2620		2600		2623	2603		
250	X9 250 Amalfi	00>	0490		0490		0493	0493		
250	X9 250 Evolution (Pinza Dx)	04>	2620		0490		2623	0493		
250	X9 250 Evolution (Pinza Sx)	04>	2600				2603			
250	X9 250 Evolution (Pinza Dx)	05>06	2620		0780		2623	0783		
250	X9 250 Evolution (Pinza Sx)	05>06	2600				2603			
300	Beverly 300 Tourer Eu3	09>10	2620		2620		2623	2623		
300	Carnaby 300	09>10	2620		2620		2623	2623		
300	Mp3 300 4T 4V ie Lt Ibrido	10>	0300		2620		0303	2623		
300	Mp3 300 ie Lt	10>11	0300		2620		0303	2623		
300	Mp3 300 ie Mic	10>	0300		2620		0303	2623		
300	Vespa 300 Gts Super	08>	2620		0450		2623	0453		
400	Beverly 400 Eu3	06>	0430		2620			2623		
400	Beverly 400 Tourer Eu3	08>10	0490		0780		0493			
400	Mp3 400	07>08	0300		2620		0303	2623		
400	Mp3 400 ie Lt / ie Lt Sport	08>10	0300		2620		0303	2623		
400	Mp3 400 Mic	08>09	0300		2620		0303	2623		
400	X Evo 400 (Pinza Dx)	07>11	2600				2603			
400	X Evo 400 (Pinza Sx)	07>11	2620		2620		2623	2623		
400	X8 400 (Pinza Dx)	06>	2620		2620		2623	2623		
400	X8 400 (Pinza Sx)	06>	2600				2603			
400	X8 400 Eu3 (Pinza Dx)	06>08	2600				2623			
400	X8 400 Eu3 (Pinza Sx)	06>08	2620		2620		2623	2623		
500	Beverly 500	03>	0490		0490		0493	0493		
500	Beverly 500 (Pinza Hengtong)	05>06	0490		0780		0493			
500	Beverly 500 Cruiser	07>09	0490		0780		0493			
500	Beverly 500 Eu3	06>08	0490		0780		0493			
500	X9 500	01>03	0490		0490		0493	0493		
500	X9 500 Evolution	03>04	0430		0490			0493		
500	X9 500 Evolution Abs	05>	0430		0490			0493		
PIAGGIO (ciclomotori)										
50	Boss 50	88>				0230				
50	Boxer 50	-		0191		0230				
50	Bravo 50	-		0191		0230				
50	Bravo 50 (Ruote In Lega Mozzo 90 mm)	87>				0230				
50	Bravo 50 (Ruote In Lega)	87>		0201		0230				

Con Piastra - With Plate

PASTIGLIE FRENO RMS - SINTER (RICERCA PER MARCA)

RMS - SINTER BRAKE PADS (SEARCH BY BRAND)















CC	MODELLO MODEL	ANNO YEAR	RMS YOUR BEST PARTNER				SINTER			
			ANTERIORE FRONT		POSTERIORE REAR		ANTERIORE FRONT	POSTERIORE REAR		
			PASTIGLIA ORGANICA ORGANIC				PASTIGLIA SINTERIZZATA SINTERED			
			OMOLOGATA HOMOLOGATED	NON OMOLOGATA NOT HOMOLOGATED	GANASCE BRAKE SHOES	OMOLOGATA HOMOLOGATED	NON OMOLOGATA NOT HOMOLOGATED	GANASCE BRAKE SHOES		
			22 510		22 512		22 510		22 512	
50	Ciao 50	-			0191		0230			
50	Ciao 50 (Ruote In Lega)	87>			0201		0230			
50	Ciao 50 Mix	97>					0230			
50	Grillo 50	89>			0201		0230			
50	Si 50	-			0191		0230			
50	Si 50 (Ruote In Lega)	80>			0201		0230			
50	Si 50 Mix	97>					0230			
50	Super Bravo 50	85>			0191		0230			
50	Superbravo 50 3 Marce	87>			0201					
PIAGGIO (motocarri)										
50	Ape 50 Eu2	03>10			0171		0221			
50	Ape 50 FL / FL2	89>95			0171		0221			
50	Ape 50 FL3 Europa	96>99			0171		0221			
50	Ape 50 P	80>85			0171		0221			
50	Ape 50 Rst Mix	99>05			0171		0221			
50	Ape 50 Tm P	85>89			0171		0221			
150	Ape 150 C 1/2/3	-			0171					
150	Ape 150 C4	-			0171					
175	Ape 175 Pentaro'	-			0171					
220	Ape Car 220 P2/P3 (Kit 3 Ganasce)	78-85			0251		0251			
220	Ape MP 220 P501 II Serie (Kit 3 Gan.)	78-96			0251		0251			
220	Ape MP 220 P601 II Serie (Kit 3 Gan.)	78-96			0251		0251			
220	Ape TM 220 (Kit 3 Ganasce)	09-10			0261		0261			
220	Ape TM 220 P602 (Kit 3 Ganasce)	82-83			0261		0261			
220	Ape TM 220 P703/P703V/FL2 (Kit 3 Gan.)	84-02			0261		0261			
420	Ape Car 420 Diesel (Kit 3 Ganasce)	86-96			0251		0251			
420	Ape Car 420 Max Diesel 9Q (Kit 3 Ganasce)	86-96			0251		0251			
420	Ape MP 420 601 Classic (Kit 3 Ganasce)	06-07			0261		0261			
420	Ape TM 420 Diesel LCS (Kit 3 Ganasce)	05-10			0261		0261			
420	Ape TM 420 P703/P703V Diesel (Kit 3 Gan.)	87-04			0261		0261			
500	Quargo (Coppia pastiglie)	05-15			3450					
1000	Porter 1000 (Carburatore) (Coppia pastiglie)	92-94			3450					
1000	Porter 1000 (Iniezione) (Coppia pastiglie)	95-98			3450					
1200	Porter 1200 Diesel (Coppia pastiglie)	95-00			3450					
1300	Porter 1300 16V 4x4 (Coppia pastiglie)	98-07			3450					
1300	Porter 1300 16V GPL (Coppia pastiglie)	98-07			3450					
1300	Porter 1300 16V Maxxi (Coppia pastiglie)	98-07			3450					
1300	Porter 1300 16V Pick-up (Coppia pastiglie)	98-07			3450					
1300	Porter 1300 16V Van (Coppia pastiglie)	98-07			3450					
1300	Porter 1300 Maxxi Up - Date (Coppia pastiglie)	09>			3450					
1300	Porter 1300 Up - Date (Coppia pastiglie)	09>			3450					
1400	Porter 1400 Diesel (Coppia pastiglie)	95-00			3450					
PIAGGIO (Spagna)										
50	Vespino 50	80>			0201					
50	Vespino 50	>79			0191					
80	Vespa 80	-			0171		0161			
80	Vespa 80 Px	-			0171		0161			
80	Vespa 80 Special	-			0171		0161			
125	Vespa 125 Px	-			0570		0570			
150	Vespa 150 Px	-			0570		0570			
PINZE CALIPERS RACING										
	Minimoto Tipo Cs Racing	-			1400					



PASTIGLIE FRENO RMS - SINTER (RICERCA PER MARCA)

RMS - SINTER BRAKE PADS (SEARCH BY BRAND)

CC	MODELLO MODEL	ANNO YEAR	 YOUR BEST PARTNER							
			 ANTERIORE FRONT		 POSTERIORE REAR		 ANTERIORE FRONT	 POSTERIORE REAR		
			PASTIGLIA ORGANICA ORGANIC				PASTIGLIA SINTERIZZATA SINTERED			
			 OMOLOGATA HOMOLOGATED	 NON OMOLOGATA NOT HOMOLOGATED	 GANASCE BRAKE SHOES	 OMOLOGATA HOMOLOGATED	 NON OMOLOGATA NOT HOMOLOGATED	 GANASCE BRAKE SHOES	 OMOLOGATA HOMOLOGATED	 NON OMOLOGATA NOT HOMOLOGATED
			22 510		22 512		22 510		22 512	
	Minimoto Tipo Grc	-	1400							
	Minimoto Tipo Polini Tipo 1	-	1400							
	Minimoto Tipo Polini Tipo 2	-	3220				3223			
	Pinza Brembo Racing (Serie 4 Pz)	-					3043			
POLARIS ATV										
250	Cyclone 250 X	87>								
	Scrambler (3 Wheeler)	85>86					0061			
	Trail Boss 2X4	85>87					0061			
	Trail Boss 4X4	87>	1440							
POLINI										
50	Cross 50	99>	1400		1400					
50	X1- X2 50 R	04>	3220		3220		3223	3223		
65	X5 65 Rp	05>	3220		3220		3223	3223		
PRAGA										
250	Ed 250	99>	0430		1330			1333		
610	Cd 610	99>	0430		1330			1333		
PUCH										
50	Condor 50	-	0080				0083			
50	Monza 50	85>	0080				0083			
75	Cobra 75	85>	0080				0083			
80	Cobra 80	84>	0080				0083			
80	Maxi 80	88>			0010			0013		
125	125	87>	0060				0063			
250	Cross 250	86>86	0010							
250	Hfe 250	86>86	0010							
600	Enduro 600 4 Valves	85>	0010		0010			0013		
RAPIDO										
50	Screnna 50	-					0061			
RIEJU										
50	Drac 50	97>	0080		0080		0083	0083		
50	Drag 50	92>	0030							
50	Fd4 50 Super Maraton	85>	0080				0083			
50	First 50 H2o	97>	0080				0083			
50	Mrx 50 Pro	05>	0740		0080			0083		
50	Mrx 50 Racing	02>	0080		0080		0083	0083		
50	Nkd 50	05>	0560		0080			0083		
50	Racing 50 Special Edition	01>	0740		0080			0083		
50	Rr 50	96>	0080		0080		0083	0083		
50	Rr 50 Supermotard	96>	0080		0080		0083	0083		
50	Rrx 50	08>	0080		0080		0083	0083		
50	Rrx 50 Spike	08>	0080		0080		0083	0083		
50	Rs1 50	92>	0080		0080		0083	0083		
50	Rs1 50 Castrol	01>	0360		0080		0363	0083		
50	Rs1 50 Evolution	96>00	0080		0080		0083	0083		
50	Rs2 50 Matrix	03>	0560		0080			0083		
50	Rv 50	-	0080				0083			
50	Smx 50	02>	0740		0080			0083		
50	Smx 50 Pro	08>	0490		0080		0493	0083		
50	Spike 50	02>	0080		0080		0083	0083		
50	Spike 50 Racing	02>	0740		0080			0083		
50	Tango 50	08>	0490		0080		0493	0083		
50	Windy 50	97>	0080				0083			

Con Piastra - With Plate

PASTIGLIE FRENO RMS - SINTER (RICERCA PER MARCA)

RMS - SINTER BRAKE PADS (SEARCH BY BRAND)



CC	MODELLO MODEL	ANNO YEAR	RMS YOUR BEST PARTNER				SINTER			
			 ANTERIORE FRONT		 POSTERIORE REAR		 ANTERIORE FRONT	 POSTERIORE REAR		
			PASTIGLIA ORGANICA ORGANIC				PASTIGLIA SINTERIZZATA SINTERED			
			 OMOLOGATA HOMOLOGATED	 NON OMOLOGATA NOT HOMOLOGATED	 GANASCE BRAKE SHOES	 OMOLOGATA HOMOLOGATED	 NON OMOLOGATA NOT HOMOLOGATED	 GANASCE BRAKE SHOES		
			22 510		22 512	22 510		22 512	22 510	22 510
75	K6 75 Lc Strada	87>	0080				0083			
75	P6 75 Lc Strada	87>	0080				0083			
80	Mr 80	-	0080				0083			
80	Rst 80	91>	0080		0080		0083	0083		
125	Mrx 125	03>	0740		0080			0083		
125	Rr 125	97>	0080		0080		0083	0083		
125	Rs2 125 Nkd	06>	2820		0040		2823			
125	Rs2 125 Pro	08>			0080			0083		
125	Smx 125	03>	0740		0080			0083		
125	Tango 125	06>08	3160		0080		3163	0083		
125	Tango 125	08>	0490		0080		0493	0083		
125	Tango 125 Pro	08>	0490		0080		0493	0083		
125	Rs2 Pro	08	3260							
450	Mrx 450	08>	0430		0750			0753		
805	Mr 805 C / E	88>	0080				0083			
805	Mr 805 Cross / Enduro	87>	0080				0083			
RIZZATO										
50	Atala Califfone 50 (Ruota Raggi)	-			0201		0201			
50	Atala Carosello 50	97>	0070							
50	Atala Hacker 50	95>	0190				0193			
50	Atala Uno 50 (Ruota Raggi)	-			0191		0191			
SACHS										
50	Mad Ass 50	04>	2590				2593			
50	Mad Ass 50 4T	05>	2590		0080		2593	0083		
80	Sv 80 Lotus	-	0010				0013			
125	Roadster 125 V2	01>	0060				0063			
125	X Road 125	05>	0520				0523			
125	Xtc 125	99>	0520				0523			
125	Xtc 125 N	99>	0520				0523			
125	Zx 125	99>	0060				0063			
125	Zz 125	99>	0060				0063			
500	Mad Ass 500	05>	0520				0523			
650	Roadster 650 V 1.6	01>	0520				0523			
800	Roadster 800 V 2	00>	0520				0523			
805	B 805	02>	0520				0523			
805	S 805	03>	0520				0523			
SANGLAS										
400	Y 400	79>80	0010		0010		0013	0013		
500	S2 500	79>80	0010		0010		0013	0013		
SCORPA										
125	Sy 125 F	03>	0640		0650					
250	255 250 Works	95>	0080		0080		0083	0083		
250	Sy 250	00>	0640		0650					
250	Sy 250 Long Ride	04>	0640		0650					
250	T Ride	08					3343			
280	Easy Race 280	99>	0080		0080		0083	0083		
SHERCO										
50	Enduro 50	02>	0740		0080			0083		
50	Supermotard 50	02>	0740		0080			0083		
80	80 0.8	01>	0080		0080		0083	0083		



PASTIGLIE FRENO RMS - SINTER (RICERCA PER MARCA)

RMS - SINTER BRAKE PADS (SEARCH BY BRAND)

CC	MODELLO MODEL	ANNO YEAR	RMS YOUR BEST PARTNER				SINTER			
			ANTERIORE FRONT		POSTERIORE REAR		ANTERIORE FRONT	POSTERIORE REAR		
			PASTIGLIA ORGANICA ORGANIC				PASTIGLIA SINTERIZZATA SINTERED			
			OMOLOGATA HOMOLOGATED	NON OMOLOGATA NOT HOMOLOGATED	GANASCE BRAKE SHOES	OMOLOGATA HOMOLOGATED	NON OMOLOGATA NOT HOMOLOGATED	GANASCE BRAKE SHOES		
			22 510	22 512	22 510	22 512	22 510	22 510		
125	City Corp 125 4T Enduro	03>	0740		0080			0083		
125	City Corp 125 4T Sm	03>	0740		0080			0083		
125	Trial 125	99>00	0010		0010		0013	0013		
125	Trial 125	02>	0740		0080			0083		
125	Trial 125 1.25	99>02	0080		0080		0083	0083		
125	Trial 125 1.25	03>	0640		0650					
200	Trial 200 2.0	99>	0080		0080		0083	0083		
250	Trial 250 2.5	99>01	0080		0080		0083	0083		
250	Trial 250 2.5	02>	0640		0650					
290	Trial 290 2.9	02>05	0640		0650					
290	Trial 290 2.9	>01	0080		0080		0083	0083		
290	Trial 290 3.2 4T	05>	0640		0650					
450	Enduro 450 4.5 I	04>05	0430		1450			1453		
SIAM										
50	Falcon 50	97>	0190				0193			
50	Mat 50	97>	0040							
50	Scross 50	97>	0190				0193			
100	Mat 100	97>	0040							
SIAMOTO										
50	Birdie 50	02>	0180							
125	Bd - Kd 125	02>	0740							
SIMSON										
50	Habict 50 Cx	01>	0010				0013			
50	Spatz 50	99>	0010				0013			
50	Sperber 50	99>	0010				0013			
50	Sr 50 /1 Gamma	94>	0080				0083			
50	Sr 50 Gamma E	94>	0080				0083			
50	Sr 50 Xc/Xce	-	0080				0083			
50	Star 50	99>	0010				0013			
80	Ifa 80	89>	0010				0013			
80	S 83 Cx / Or	-	0010				0013			
80	Sr 80 /1 Gamma	94>	0080				0083			
80	Sr 80 2 Ce	89>	0010				0013			
80	Sr 80 Xce	-	0080				0083			
125	Rs 125	01>	0060				0063			
125	Schikra 125	99>	0060		0010		0063	0013		
125	Sm 125	01>	0740		0080			0083		
125	Star 125	99>	0080				0083			
SULA										
50	City Bird 50	99>	0180			0061				
50	Thunder Bird 50	99>	0040			0061				
100	Thunder Bird 100	99>	0040			0061				
125	Thunder Bird 125	99>	0040			0061				
SUZUKI										
50	Adress 50	92>	0040							
50	Ap 50	95>	3210							
50	Ay 50 A	04>06	0080		0080		0083	0083		
50	Ay 50 Katana (Pinza Brembo)	97>	0190			0131	0193			
50	Ay 50 W (Katana)	00>04	0080		0080		0083	0083		
50	Ay 50 W Katana	98>	0080			0131	0083			
50	Ay 50 Wr Katana	98>	0080			0131	0083			
50	Cp	85>93			0131		0131			

Con Piastra - With Plate

PASTIGLIE FRENO RMS - SINTER (RICERCA PER MARCA)

RMS - SINTER BRAKE PADS (SEARCH BY BRAND)



CC	MODELLO MODEL	ANNO YEAR	RMS YOUR BEST PARTNER						SINTER	
			 ANTERIORE FRONT			 POSTERIORE REAR			 ANTERIORE FRONT	 POSTERIORE REAR
			PASTIGLIA ORGANICA ORGANIC						PASTIGLIA SINTERIZZATA SINTERED	
			 OMOLOGATA HOMOLOGATED	 NON OMOLOGATA NOT HOMOLOGATED	 GANASCE BRAKE SHOES	 OMOLOGATA HOMOLOGATED	 NON OMOLOGATA NOT HOMOLOGATED	 GANASCE BRAKE SHOES		
			22 510		22 512	22 510		22512	22 510	22 510
50	Cp Chf	85>93			0131		0131			
50	Dr 50 Big	89>	0080					0083		
50	Lido	85>93			0131		0131			
50	Or 50	80>	1200							
50	Rg 50 Gag - Gamma	87>	0720					0723		
50	Rme 50	10>				0660			0663	
50	Rmx 50	00>	0080			0080		0083	0083	
50	Sepia 50	92>	0040				0131			
50	Sepia Au 50 Zz	96>	0040							
50	Smx 50 Super Motard	00>	0080			0080		0083	0083	
50	Tr 50 Street Magic	98>		0370						
50	Tune 50	93>	0040							
50	Tzr 50	97>	1070					1073		
50	Uf 50 Estilete	00>	0080				0131	0083		
50	Ux 50 Zillion	98>	0080					0083		
50	Zr 50 Skx - Slkx	81>	1200							
50	Zz 50	92>	0040				0131			
65	Rm 65	03>				2850			2853	
75	Lido 75	89>	0040							
80	3 E 80	-	1200							
80	Ah 80	92>	0040				0131			
80	Gt 80 L	81>	1200							
80	Rg 80 Gamma	>87	1200							
80	Rg 80 Gamma	88>93	3080					3083		
80	Rm 80 L/M	90>95	0040			0040				
80	Rm 80 X	86>89	0040							
80	Rm 80 Xt- Xv - X	96>01				0040				
85	Rm 85	02>04				0040				
100	Adress 100 V	95>	0040							
100	Gp 100 C - Den - N - X	78>	1200							
100	Rm 100	03>				2850			2853	
110	Ug 110 Hokuto	00>		0370						
125	An 125	06>08	0040							
125	Dr 125 S	86>93	1440							
125	En 125	05>	1420					1423		
125	Gn 125 E-M-T	91>04	1200							
125	Gs 125 Esz	82>	1200							
125	Lido 125 Vario	90>	0040							
125	Rg 125 E	82>84	1200							
125	Rg 125 T - Fv	92>	1150					1153		
125	Rg 125 W Gamma	85>91	3080					3083		
125	Rm 125	05>	0920			2630		0923	2633	
125	Rm 125	91>95	1420					1423		
125	Rm 125 H	87>	1420					1423		
125	Rm 125 J	88>	1420					1423		
125	Rm 125 K - L - M	89>90	1420			1790		1423		
125	Rm 125 T-K	96>06	0920			2630		0923	2633	
125	Rv 125 Van Van	02>10	1250					1253		
125	Ts 125	90>	1420			1440		1423		
125	Ts 125 Rk	89>	1440			1790				
125	Ts 125 X	88>	1440							
125	Tx 125 Xf	85>	1440							

Con Piastra - With Plate



PASTIGLIE FRENO RMS - SINTER (RICERCA PER MARCA)

RMS - SINTER BRAKE PADS (SEARCH BY BRAND)

CC	MODELLO MODEL	ANNO YEAR	RMS YOUR BEST PARTNER				SINTER			
			ANTERIORE FRONT		POSTERIORE REAR		ANTERIORE FRONT	POSTERIORE REAR		
			PASTIGLIA ORGANICA ORGANIC				PASTIGLIA SINTERIZZATA SINTERED			
			OMOLOGATA HOMOLOGATED	NON OMOLOGATA NOT HOMOLOGATED	GANASCE BRAKE SHOES	OMOLOGATA HOMOLOGATED	NON OMOLOGATA NOT HOMOLOGATED	GANASCE BRAKE SHOES		
22 510		22 512	22 510		22512	22 510	22 510			
125	Uc Epicuro	01>	0370		0370					
125	Uh 125 Burgman	02>06	0430		0490		0493			
125	Uh 125 Burgman	07>	2540	2550 □	2870	2543	2873			
125	Ux 125 Sixteen	08>	2540	2550 □	0670	2543				
125	X4 125	-	1200							
150	An 150 Ty	96>	0370		0131					
150	Fx 150 4 Stroke	98>	1070		1070	1073	1073			
150	Rg 150 Water Cooled	98>	1070		1070	1073	1073			
150	Uc Epicuro	01>	0370		0370					
150	Ue 150	02>	0040							
150	Uh 150 Burgman	02>06	0430		0490		0493			
150	Ux 150 Sixteen	08>	2540	2550 □	0670	2543				
200	Dr 200	00>	1440							
200	Dr 200 K	89>	1440							
200	Rg 200 Gamma	93>	1150			1153				
200	Ts 200 R	90>	1420		1790	1423				
200	Uh 200 Burgman	07>09	2540	2550 □	2870	2543	2873			
250	250 Bandit	90>			0720		0723			
250	Across 250	90>			0720		0723			
250	An 250 Burgman	01>06	0380		0670	0383				
250	An 250 Burgman	96>00	0380		2650	0383	2653			
250	Cobra 250	89>	1150		0720	1153	0723			
250	Cobra 250	90>	1150		0720	1153	0723			
250	Djebel 250	93>	1420		1790	1423				
250	Dr 250 S	86>89	1440							
250	Dr 250 S	90>	1420		1790	1423				
250	Dr-Z 250	01>	0920		2630	0923	2633			
250	Gf 250 S	86>			0720		0723			
250	Goose 250	92>	1150		0720	1153	0723			
250	Gs 250 Fw	84>	0720		0720	0723	0723			
250	Gsx 250 S Katana	91>			0720		0723			
250	Gsx-R 250	87>88			0720		0723			
250	Gsx-R 250 R - R/Sp	89>	1150		0720	1153	0723			
250	Rg 250 W Gamma	>83	0720		0720	0723	0723			
250	Rg 250 W Gamma	84>87			0720		0723			
250	Rgv 250	93>	1150			1153				
250	Rgv 250	94>	1150			1153				
250	Rgv 250 R	88>	3030		0720	3033	0723			
250	Rgv 250 R	89>	1150		0720	1153	0723			
250	Rgv 250 R	90>92	1150			1153				
250	Rh 250 X	87>	1440							
250	Rm 250	91>92	1420			1423				
250	Rm 250	96>06	0920		2630	0923	2633			
250	Rm 250 H	87>88	1420			1423				
250	Rm 250 K - L - M	89>94	1420		1790	1423				
250	Rm 250 R-S	93>95	1420			1423				
250	Rm Z 250 (4T)	04>11	0920		1450	0923	1453			
250	Rm Z 250 (4T) Efi	10>	0920		1450	0923	1453			
250	Rmx 250	99>	0920		2630	0923	2633			
250	Rmx 250 Rp	89>95	1420		1790	1423				
250	Rmx 250 T/V	96>	0920		1790	0923				
250	Sky Wave 250 (Type Ii)	98>	0380		2650	0383	2653			

□ Con Piastra - With Plate

PASTIGLIE FRENO RMS - SINTER (RICERCA PER MARCA)

RMS - SINTER BRAKE PADS (SEARCH BY BRAND)



CC	MODELLO MODEL	ANNO YEAR	RMS YOUR BEST PARTNER				SINTER			
			ANTERIORE FRONT		POSTERIORE REAR		ANTERIORE FRONT	POSTERIORE REAR		
			PASTIGLIA ORGANICA ORGANIC				PASTIGLIA SINTERIZZATA SINTERED			
			OMOLOGATA HOMOLOGATED	NON OMOLOGATA NOT HOMOLOGATED	GANASCE BRAKE SHOES	OMOLOGATA HOMOLOGATED	NON OMOLOGATA NOT HOMOLOGATED	GANASCE BRAKE SHOES		
			22 510	22 512	22 510	22 512	22 510	22 510		
250	Ts 250 X All Models	86>86	1440							
250	Tu 250 X	00>01	1240				1243			
250	Wolf 250	90>			0720			0723		
350	Dr 350	90>	1420		1790		1423			
350	Dr 350 S-Sh-Se	93>	1420		1790		1423			
350	Goose 350	92>	1150		0720		1153	0723		
400	An 400 Burgman	98>00	0380		2650		0383	2653		
400	An 400 Burgman	01>06	0380		0670		0383			
400	An 400 Burgman (Pinza Dx)	07>	1070		1500		1073	1503		
400	An 400 Burgman (Pinza Sx)	07>	1420		1500		1423	1503		
400	Dr Z 400 S - E	00>05	0920		2630		0923	2633		
400	Dr Z 400 Sm	05>	0920		2630		0923	2633		
400	Gsf 400 Bandit	93>94	1150		0720		1153	0723		
400	Gsf 400 Bandit	95>	0870				0873			
400	Gsf 400 S Katana	89>90	1150				1153			
400	Gsx 400 F (Four) Fz	81>	1200							
400	Gsx 400 Fd	81>	1200							
400	Gsx 400 Fws - D - E	83>	0720		0720			0723		
400	Gsx 400 Impulse	94>	0870		0720		0873	0723		
400	Gsx 400 Katana	89>	1150		0720		1153	0723		
400	Gsx 400 R I/li	85>86			0720			0723		
400	Gsx 400 S	83>	0720		0720		0723	0723		
400	Gsx 400 X Impulse	86>88			0720			0723		
400	Gsx-R 400	90>	1060		0720		1063	0723		
400	Gsx-R 400 (Ili-Iv)	>88			0720			0723 0723		
400	Gsx-R 400 (V)	89>	1150		0720		1153	0723		
400	Gsx-R 400 (Japan)	85>	0720				0723			
400	Gsx-R 400 R	90>	3030		0720		3033	0723		
400	Rf 400 Rvc	93>	0870		0720		0873	0723		
400	Rg 400 Gamma	85>			0720			0723		
450	Gs 450 S	87>	1200		0720			0723		
450	Rm X 450 (4T) Efi	10>	0920		1450		0923	1453		
450	Rm Z 450 (4T)	05>07	0920		1450		0923	1453		
450	Rm Z 450 (4T) Efi	08>	0920		1450		0923	1453		
500	Gs 500	04>	1250		0720		1253	0723		
500	Gs 500 Et/Ev	96>	1250				1253			
500	Gs 500 F	04>	1250		0720		1253	0723		
500	Rg 500 Rf Gamma	85>			0720			0723		
500	Rgv 500 Gamma	90>	1150				1153			
500	Rm 500	87>	1420				1423			
550	Gsx 550 Ef - Efe	83>	0720		0720		0723	0723		
550	Gsx 550 Es - Ese	83>	0720		0720		0723	0723		
550	Gsx 550 Esd - Es4	83>	0720		0720		0723	0723		
550	Gsx 550 Et - Ev	87>	0720		0720		0723	0723		
600	Gsf 600 Bandit	95>99	0870		0720		0873	0723		
600	Gsf 600 Bandit (Pinza Dx)	00>04	1250		0720		1253	0723		
600	Gsf 600 Bandit (Pinza Sx)	00>04	1240		0720		1243	0723		
600	Gsr 600	06>	1150		3060		1153	3063		
600	Gsx 600 F (Pinza Dx)	98>	1250		0720		1253	0723		
600	Gsx 600 F (Pinza Sx)	98>	1240				1243			
600	Gsx 600 F Katana	88>93			0720			0723		
600	Gsx-R 600	04>05					2963	3113		

Con Plastra - With Plate



PASTIGLIE FRENO RMS - SINTER (RICERCA PER MARCA)

RMS - SINTER BRAKE PADS (SEARCH BY BRAND)

CC	MODELLO MODEL	ANNO YEAR	RMS YOUR BEST PARTNER				SINTER			
			ANTERIORE FRONT		POSTERIORE REAR		ANTERIORE FRONT	POSTERIORE REAR		
			PASTIGLIA ORGANICA ORGANIC				PASTIGLIA SINTERIZZATA SINTERED			
			22 510	22 512	22 510	22 512	22 510	22 510		
600	Gsx-R 600	06>10			3060		2963	3063		
600	Gsx-R 600	11>					2923	2933		
600	Gsx-R 600	>93	3030		0720		3033	0723		
600	Gsx-R 600 F	94>95	0870				0873			
600	Gsx-R 600 V	96>03	1150				1153			
600	Rf 600 Rr	93>	0870				0873			
650	An 650 Burgman	03>09	0870		1500		0873	1503		
650	DI 650 V Strom (Pinza Dx)	04>	1250		0930		1253	0933		
650	DI 650 V Strom (Pinza Sx)	04>	1240		0930		1243	0933		
650	Dr 650 Se	96>	0920		2630		0923	2633		
650	Gsf 650 Bandit (Pinza Dx)	05>	1250		3110		1253	3113		
650	Gsf 650 Bandit (Pinza Sx)	05>	1240		3110		1243	3113		
650	Gsf 650 Bandit (Pinza Dx)	06>	1250		0930		1253	0933		
650	Gsf 650 Bandit (Pinza Sx)	06>	1240		0930		1243	0933		
650	Gsf 650 Bandit Abs	07>	1150		0930		1153	0933		
650	Gsf 650 S Bandit Abs	07>	1150		0930		1153	0933		
650	Gsx 650 F	08>	1150		0930		1153	0933		
650	Sfv 650 Gladius (Pinza Dx)	09>	1250		0930		1253	0933		
650	Sfv 650 Gladius (Pinza Sx)	09>	1240		0930		1243	0933		
650	Sv 650 S (Pinza Dx)	99>02	1250		0720		1253	0723		
650	Sv 650 S (Pinza Sx)	99>02	1240		0720		1243	0723		
650	Sv 650 S (Pinza Dx)	03>	1250		0930		1253	0933		
650	Sv 650 S (Pinza Sx)	03>	1240		0930		1243	0933		
650	Xf 650 Freewind	97>	1250		0930		1253	0933		
750	Gsr 750 (Pinza Dx)	11>	1240		0930		1243	0933		
750	Gsr 750 (Pinza Sx)	11>	1240		0930		1243	0933		
750	Gsx 750 Ef	87>			0720			0723		
750	Gsx 750 F	89>			0720			0723		
750	Gsx 750 F	90>91	1150		0720		1153	0723		
750	Gsx 750 F	93>97			0720			0723		
750	Gsx 750 F (Pinza Dx)	98>03	1250		0720		1253	0723		
750	Gsx 750 F (Pinza Sx)	98>03	1240		0720		1243	0723		
750	Gsx 750 Fk	88>			0720			0723		
750	Gsx 750 Limited Edition	86>			0720			0723		
750	Gsx F 750	08>09	1150		0930		1153	0933		
750	Gsx R 750	85>87			0720			0723		
750	Gsx R 750	88>93	3030				3033			
750	Gsx R 750	04>05					2963	3113		
750	Gsx R 750	06>10			3060		2963	3063		
750	Gsx R 750 Ltd Special Edition	87>88			0720			0723		
750	Gsx R 750 W	94>99	1170		0720		1173	0723		
750	Gsx R 750 Y	00>03	1150				1153			
750	Gsx-R 750	11>					2923	2933		
750	Gt 750 Rf	85>			0720			0723		
800	Dr 800 Big All Models	91>			1070			1073		
800	M 800 Intruder	05>	1250				1253			
800	VI 800 Intruder Lc Volusia	01>04	1250				1253			
800	Vx 800	90>92			0720			0723		
800	Vz 800 Marauder	97>04	1250				1253			
900	Rf 900 Rr	94>	3030				3033			
900	Rf 900 Rt - Rv	96>	3030		0720		3033	0723		
1000	DI 1000 V Strom (Pinza Dx)	02>09	1250		0930		1253	0933		

Con Piastra - With Plate

PASTIGLIE FRENO RMS - SINTER (RICERCA PER MARCA)

RMS - SINTER BRAKE PADS (SEARCH BY BRAND)



















CC	MODELLO MODEL	ANNO YEAR	RMS YOUR BEST PARTNER				SINTER			
			 ANTERIORE FRONT		 POSTERIORE REAR		 ANTERIORE FRONT	 POSTERIORE REAR		
			PASTIGLIA ORGANICA ORGANIC				PASTIGLIA SINTERIZZATA SINTERED			
			 OMOLOGATA HOMOLOGATED	 NON OMOLOGATA NOT HOMOLOGATED	 GANASCE BRAKE SHOES	 OMOLOGATA HOMOLOGATED	 NON OMOLOGATA NOT HOMOLOGATED	 GANASCE BRAKE SHOES		
			22 510		22 512	22 510		22512	22 510	22 510
1000	DI 1000 V Strom (Pinza Sx)	02>09	1240				0930	1243	0933	
1000	Gsx 1000 G Left	96>	1240					1243		
1000	Gsx 1000 G Right	96>	1250					1253		
1000	Gsx R 1000	01>02	1170					1173	3113	
1000	Gsx R 1000	03>						2983	3113	
1000	Gsx R 1000	04>06						2963	3113	
1000	Gsx R 1000	07>08				3060		2963	3063	
1000	Gsx R 1000	09>11						2963	2933	
1000	Gsx R 1000	11>						2923	2933	
1000	Sv 1000	03>05	1150			0930		1153	0933	
1000	Sv 1000	06>07	1150			0930		1153	0933	
1000	Tl 1000 Rw	98>02	1170			0720		1173	0723	
1000	Tl 1000 Sv Twin	97>01	1150					1153		
1100	Gsx 1100 F	93>	3030					3033		
1100	Gsx 1100 G (Pinza Dsx)	96>	1240			0720		1243	0723	
1100	Gsx 1100 G (Pinza Dx)	96>	1250			0720		1253	0723	
1100	Gsx R 1100	85>88				0720			0723	
1100	Gsx R 1100 K - L - M	89>92	3030			0720		3033	0723	
1100	Gsx R 1100 W	93>	1170					1173		
1200	Gs 1200 Ss K1	01>	1170					1173		
1200	Gsf 1200 Bandit	95>00	3030			0720		3033	0723	
1200	Gsf 1200 Bandit	01>05	1170			0720		1173	0723	
1200	Gsf 1200 Bandit	06>	1150			0930		1153	0933	
1200	Gsf 1200 S Bandit	01>05	1170			0720		1173	0723	
1200	Gsf 1200 S Bandit	06>	1150			0930		1153	0933	
1200	Gsx 1200	99>01	1100			0720		1103	0723	
1250	Gsf 1250 Bandit Abs	07>08	1150			0930		1153	0933	
1250	Gsf 1250 S Bandit Abs	07>08	1150			0930		1153	0933	
1250	Gsx 1250 Fa	10>	1150			0930		1153	0933	
1300	Gsx 1300 B King	07>				0930		2943	0933	
1300	Gsx 1300 B King	08>				3060		2993	3063	
1300	Gsx R 1300 Falcon	99>	1170			0720		1173	0723	
1300	Gsx R 1300 Hayabusa	99>07	1170			0720		1173	0723	
1300	Gsx R 1300 Hayabusa	08>				3060		2963	3063	
1400	Gsx 1400	01>06	1170					1173	3113	
1400	Gv 1400	85>86				0040				
1400	Vs 1400 Glpt/Glpv	96>	1150			1440		1153		
1500	C 1500 Intruder (Pinza Dx)	05>	1250					1253		
1500	C 1500 Intruder (Pinza Sx)	05>	1240					1243		
1500	M 1500 Intruder (Pinza Dx)	09>	1250			1250		1253	1253	
1500	M 1500 Intruder (Pinza Sx)	09>	1240			1250		1243	1253	
1500	VI 1500 Intruder (Pinza Dx)	02>	1250					1253		
1500	VI 1500 Intruder (Pinza Sx)	02>	1240					1243		
1600	M 1600 Intruder	05>				1250		2983	1253	
1600	Vz 1600 Marauder	04>	1170			1250		1173	1253	
1800	C 1800 R Intruder	08>	2540	2550 □		1250		2543	1253	
1800	M 1800 R Intruder	06>				1250		2963	1253	
1800	M 1800 R2 Intruder	08>				1250		2963	1253	
SUZUKI ATV										
230	Lt 230 Eh/Ej/Ek/El/Em/En/Ep	86>93				2850			2853	
250	Lt 250 Sk/SI	89>90				2850			2853	
250	Lt-Z 250 Quad Sport	04>	1440							

□ Con Piastra - With Plate



PASTIGLIE FRENO RMS - SINTER (RICERCA PER MARCA)

RMS - SINTER BRAKE PADS (SEARCH BY BRAND)

CC	MODELLO MODEL	ANNO YEAR	 YOUR BEST PARTNER							
			 ANTERIORE FRONT		 POSTERIORE REAR		 ANTERIORE FRONT	 POSTERIORE REAR		
			 PASTIGLIA ORGANICA ORGANIC				 PASTIGLIA SINTERIZZATA SINTERED			
			 OMOLOGATA HOMOLOGATED	 NON OMOLOGATA NOT HOMOLOGATED	 GANASCE BRAKE SHOES	 OMOLOGATA HOMOLOGATED	 NON OMOLOGATA NOT HOMOLOGATED	 GANASCE BRAKE SHOES		
			22 510		22 512	22 510		22512	22 510	22 510
250	Ozark 250	03>	1440							
300	Lt-F 300 King Quad (Pinza Dx)	02>	1070				1073			
300	Lt-F 300 King Quad (Pinza Sx)	02>	1420				1423			
400	Lt-F 400 Eiger	02>	1440							
400	Lt-Z 400 Quad Sport	02>	1440							
450	Lt-A 450 (Pinza Dx)	07>	2900				2903			
450	Lt-A 450 (Pinza Sx)	07>	2880				2883			
500	Lt-A 500 F Quadmaster (Pinza Dx)	00>	1070				1073			
500	Lt-A 500 F Quadmaster (Pinza Sx)	00>	1420				1423			
500	Lt-A 500 F Vinson	02>	1440							
500	Lt-F 500 F Quadrunner (Pinza Dx)	98>00	1070				1073			
500	Lt-F 500 F Quadrunner (Pinza Sx)	98>00	1420				1423			
700	King Quad 700 (Pinza Dx)	05>	2890				2893			
700	King Quad 700 (Pinza Sx)	05>	2870				2873			
700	Lt-A 700 Kingquad (Pinza Dx)	06>07	2900				2903			
700	Lt-A 700 Kingquad (Pinza Sx)	06>07	2880				2883			
SWM										
125	S1 125	83>	0010				0013			
125	S2 125	83>	0010				0013			
250	S1 250	83>	0010				0013			
250	S2 250	83>	0010				0013			
350	Xp 350 Sahara	83>	3150				3153			
SYM										
50	Alpha 50	95>	2750				2753			
50	Alto 50	11>	2750				2753			
50	Bullet	93>	3440	1650						
50	Cinderella 50	01>	3440	1650						
50	Cinderella 50	99>	3240	0140	0091					
50	City Hopper 50	99>	3240	0140	0091					
50	Fancy 50	95>	3240	0140	0091					
50	Fiddle 50	99>	0091							
50	Fiddle li 50	08>09	2750				2753			
50	Jet 4 50	09>10	2750				2753			
50	Jet 4 50 Naked	11>	2750				2753			
50	Jet 4R 50	11>	2750				2753			
50	Jet 50	95>	2750				2753			
50	Jet 50 All Models	05>08	2750				2753			
50	Jet 50 Sport X	06>10	2750				2753			
50	Jungle 50	96>	2750	0091		2753				
50	Mask 50	00>	2750				0091 2753			
50	Mask 50 Lc	00>	2750				0091 2753			
50	Mio	05>	3440	1650						
50	Red Devil 50	99>	2750				0091 2753			
50	Super Fancy 50	95>97	2750				0091 2753			
50	Super Fancy 50	99>	3240	0140	0091					
50	Symphony 50	09>	2750				2753			
50	Symphony 50 S	10>	2750				2753			
50	Symphony 50 Sr	10>	2750				2753			
50	Symply li 50	07>09	2750				2753			
50	Rs	05	3260							
50	Rs 21	02	3260							
100	Cinderella 100	01>	3440	1650						

Con Piastra - With Plate

PASTIGLIE FRENO RMS - SINTER (RICERCA PER MARCA)

RMS - SINTER BRAKE PADS (SEARCH BY BRAND)



CC	MODELLO MODEL	ANNO YEAR	RMS YOUR BEST PARTNER						SINTER			
			ANTERIORE FRONT			POSTERIORE REAR			ANTERIORE FRONT	POSTERIORE REAR		
			PASTIGLIA ORGANICA ORGANIC						PASTIGLIA SINTERIZZATA SINTERED			
			OMOLOGATA HOMOLOGATED	NON OMOLOGATA NOT HOMOLOGATED	GANASCE BRAKE SHOES	OMOLOGATA HOMOLOGATED	NON OMOLOGATA NOT HOMOLOGATED	GANASCE BRAKE SHOES				
22 510		22 512	22 510		22 512	22 510	22 510					
100	Cinderella 100	99>	3240	0140			0091					
100	Jet 100	99>	2750					2753				
100	Jet 100 Euro X	05>	2750					2753				
100	Mio	05>	3440	1650								
100	Party 100	97>	2750					2753				
100	Super Fancy 100	95>	2750				0091	2753				
100	Super Fancy 100	99>	3240	0140			0091					
110	Star 110	03>	2750					2753				
125	Attila 125	95>	2750					2753				
125	Attila 125	99>00	2750					2753				
125	Fiddle li 125	08>10	2750					2753				
125	Gts 125	07>	0380					0383				
125	Hd 125	04>	2710									
125	Hd 125	05>06				3230						
125	Hd 125 Evo Eu3	08>10	2750					2753				
125	Hd 125 Evo Eu3	10>				3230						
125	Husky 125	96>98	1200									
125	Jet 4 125	09>	2750					2753				
125	Joy Ride 125	01>04				2710						
125	Joy Ride 125 Eu2	05>06				3230						
125	Joy Ride 125 Eu3	07>				3230						
125	Joy Ride 125 Evo	10>				3230						
125	Megalo 125	02>07	2750					2753				
125	New Duke 125	00>01	2750					2753				
125	Rs 125	05>				0350			0353			
125	Rs 21 125	02>				0350			0353			
125	Shark 125	00>				0350			0353			
125	Super Duke 125	95>	2750					2753				
125	Super Duke 125	99>02	2750				0091	2753				
125	Symphony 125	09>	2750					2753				
125	Symphony 125 D.d.	09>	2750					2753				
125	Symphony 125 S	10>	2750					2753				
125	Symphony 125 Sr	10>	2750					2753				
125	Symply 125	07>08	2750					2753				
125	Symply li 125	09>10	2750					2753				
125	Voyager 125	05>	0500									
125	Wolf Classic 125	05>	2590					2593				
125	Wolf Legend 125	02>	2590					2593				
125	Eu Mx	03	3260									
125	Joyride	01-04	3260									
125	Rs	05	3260									
125	Rs 21	02	3260									
125	Shark	00-02	3260									
150	Attila 150	00>01	2750					2753				
150	Fiddle li 150	10>	2750					2753				
150	H01 150	95>	2750					2753				
150	Joy Ride 150	01>02				2710						
150	Rs 150	05>				0350			0353			
150	Super Duke 150	96>	2750					2753				
150	Super Duke 150	99>02	2750					2753				
150	Symphony 150	09>	2750					2753				

Con Piastra - With Plate



PASTIGLIE FRENO RMS - SINTER (RICERCA PER MARCA)

RMS - SINTER BRAKE PADS (SEARCH BY BRAND)

CC	MODELLO MODEL	ANNO YEAR	RMS YOUR BEST PARTNER				SINTER			
			 ANTERIORE FRONT		 POSTERIORE REAR		 ANTERIORE FRONT	 POSTERIORE REAR		
			PASTIGLIA ORGANICA ORGANIC				PASTIGLIA SINTERIZZATA SINTERED			
			 OMOLOGATA HOMOLOGATED	 NON OMOLOGATA NOT HOMOLOGATED	 GANASCE BRAKE SHOES	 OMOLOGATA HOMOLOGATED	 NON OMOLOGATA NOT HOMOLOGATED	 GANASCE BRAKE SHOES		
			22 510	22 512	22 510	22512	22 510	22 510		
150	Symphony 150 S	10>	2750				2753			
150	Symphony 150 Sr	10>	2750				2753			
150	Eu Mx	03	3260							
150	Joyride	01>02	3260							
150	Rs	05	3260							
180	Mf 180	03>	2590				2593			
200	Hd 200	04>	2710							
200	Hd 200 Evo Eu2	05>06		3230						
200	Hd 200 Evo i Eu3	07>	2750		3230		2753			
200	Hd 200 Evo i Eu3	10>	2750		3230		2753			
200	Joy Ride 200	01>04		2710						
200	Joy Ride 200 Eu2	05>06		3230						
200	Joy Ride 200 i Eu3	07>09		3230						
200	Joy Ride 200 i Evo	10>		3230						
200	Joyride	01>04	3260							
250	Gts 250	07>	0380		3230		0383			
250	Joy Max 250	06>07	0500		3230					
250	Voyager 250	05>	0500							
300	Citycom 300	08>09	2750		2750		2753	2753		
300	Citycom 300 Efi	10>	2750		2750		2753	2753		
300	Gts 300	09>	0380				0383			
300	Joy Max 300 Evo	09>		3230						
300	Joy Max 300 Evo i	10>		3230						
400	Maxsym 400 i	11	2830				2833			
400	Maxsym 400 i	12>	3470				3473			
500	Gt 500	07>	0380		2710		0383			
600	Maxsym 600 i	14>	3470				3473			
SYM ATV										
180	Track Runner 180	06>07		3230						
250	Quad Lander 250	06>07		3230						
TGB										
50	203 50	02>	0040							
50	203 50	05>	0580				0583			
50	303 R 50	99>	0040							
50	Akros 50	99>	0040							
50	Akros 50 Tec 5	99>	0580				0583			
50	Apollo 50	99>	0580				0583			
50	Ergon 50	96>	0040							
50	Fire 50	03>	0580				0583			
50	Hiw's 50	99>	0040							
50	Sky 50	03>	0580				0583			
50	Trigger 50	99>	0040							
90	101 S 90	99>	0040							
90	202 S 90	99>	0040							
90	Akros 90	99>	0040							
90	Apollo 90	99>	0580				0583			
90	Ergon 90	99>	0040							
90	Hiw's 90	99>	0040							
90	Trigger 90	99>	0040							
125	101 S 125	99>	0040							
125	202 T 125	99>	0040							
125	303 R 125	99>	0040							

Con Piastra - With Plate

PASTIGLIE FRENO RMS - SINTER (RICERCA PER MARCA)

RMS - SINTER BRAKE PADS (SEARCH BY BRAND)



CC	MODELLO MODEL	ANNO YEAR	RMS YOUR BEST PARTNER				SINTER			
			 ANTERIORE FRONT		 POSTERIORE REAR		 ANTERIORE FRONT	 POSTERIORE REAR		
			PASTIGLIA ORGANICA ORGANIC				PASTIGLIA SINTERIZZATA SINTERED			
			 OMOLOGATA HOMOLOGATED	 NON OMOLOGATA NOT HOMOLOGATED	 GANASCE BRAKE SHOES	 OMOLOGATA HOMOLOGATED	 NON OMOLOGATA NOT HOMOLOGATED	 GANASCE BRAKE SHOES		
			22 510		22 512	22 510		22 512	22 510	22 510
309	309 Racing	05>	0040							
309	309 Rs	00>	0040							
507	507	05>	0040							
	Buffalo	03>			0350			0353		
	Bunny	97>	0040							
	Double X	05>	0040							
TM										
80	All Models 80	90>93			1200					
80	All Models 80	94>	0430		1330			1333		
80	All Models 80	>85	0010				0013			
80	Cross 80	96>00			1330			1333		
80	Gs 80	86>89			0010			0013		
80	Junior 80	96>00	0040		2850			2853		
80	Mc 80	86>89			0010			0013		
125	All Models 125	90>93			1200					
125	All Models 125	94>95	0430		1330			1333		
125	All Models 125	96>00	0430		1330			1333		
125	All Models 125	01>04	0430		2630			2633		
125	All Models 125	05>	0430		1450			1453		
125	All Models 125	>85	0010				0013			
125	Cross - Enduro 125	89>90	0530				0533			
125	Cross - Enduro 125	91>95	0530		1330		0533	1333		
125	Cross 80	96>00	0430							
125	Gs 125	86>89			0010			0013		
125	Mc 125	86>89			0010			0013		
125	Smr 125	05>	0520		2630		0523	2633		
250	250 E	95>00	0430		1330			1333		
250	250 F	01>04	0430		2630			2633		
250	250 F	05>	0430		1450			1453		
250	All Models 250	95>00	0430		1330			1333		
250	All Models 250	01>04	0430		2630			2633		
250	All Models 250	05>	0430		1450			1453		
250	Enduro 250 F	00>	0430		1330			1333		
250	Enduro 250 F	01>04	0430		2630			2633		
250	Enduro 250 F	05>	0430		1450			1453		
300	All Models 300	98>00	0430		1330			1333		
300	All Models 300	01>04	0430		2630			2633		
300	All Models 300	05>	0430		1450			1453		
320	All Models 320	96>97	0430		1330			1333		
400	400 F	00>	0430		1330			1333		
400	All Models 400 4T	01>	0430		2630			2633		
400	Smf 400 F	02>	0520		2630		0523	2633		
400	Smr 400 F	03>	0520		2630		0523	2633		
450	All Models 450 F	02>04	0430		2630			2633		
450	All Models 450 F	05>	0430		1450			1453		
450	Smr 450 F	04>	0520		2630		0523	2633		
450	Smx 450 F	03>	0520		2630		0523	2633		
450	Smx 450 F	04>	2860		2630		2863	2633		
530	All Models 530 F	01>04	0430		2630			2633		
530	All Models 530 F	05>	0430		1450			1453		
530	Smr 530 F	03>	0520		2630		0523	2633		
600	Smx 600 F	03>	0520		2630		0523	2633		

Con Plastra - With Plate



PASTIGLIE FRENO RMS - SINTER (RICERCA PER MARCA)

RMS - SINTER BRAKE PADS (SEARCH BY BRAND)

CC	MODELLO MODEL	ANNO YEAR	RMS YOUR BEST PARTNER				SINTER			
			ANTERIORE FRONT		POSTERIORE REAR		ANTERIORE FRONT	POSTERIORE REAR		
			PASTIGLIA ORGANICA ORGANIC				PASTIGLIA SINTERIZZATA SINTERED			
			22 510	22 512	22 510	22 512	22 510	22 510		
600	Smx 660 F	04>			2630		2633			
660	Smx 660 F	04>	2860				2863			
TOMOS										
50	Bt 50 S	89>	0030							
50	Mc 50 Senjor Pro	04>	3210		3210					
50	N 50 At, Bt	91>	0030							
50	Revival 50	02>	0190			0193				
50	Se 50	05>	0740		0080		0083			
50	Streetmate 50	03>	0190			0193				
80	City 80	89>	0030							
83	K 83	-		0191		0191				
83	M 83	-		0191		0191				
125	Se 125	05>	0740		0080		0083			
TORNAX										
80	Rx 80	-	0010				0013			
TRESOLDI										
80	Cr 80	85>	0010		0030		0013			
TRIUMPH										
600	Daytona 600	04>	3030		2610	3033	2613			
600	Speed Four 600	03>	3030		2610	3033	2613			
600	Tt 600	00>03	3030		2610	3033	2613			
650	Daytona 650	05>	3030		2610	3033	2613			
675	Daytona 675	06>08			2610	2993	2613			
675	Daytona R Triple 675	11>			2610	2923	2613			
675	Daytona Triple 675	09>			2610		2613			
675	Street Triple 675	08>	0870		2610	0873	2613			
675	Street Triple R 675	09>			2610	2993	2613			
675	Daytona R (Pinze radiali - Rad.cal)	11-13				3333				
750	Bonneville 750 Uk	87>	3150		3150	3153	3153			
750	Daytona 750	91>92	3030			3033				
750	Trident 750 (Pinza Dx)	91>	1070		1070	1073	1073			
750	Trident 750 (Pinza Sx)	91>	1420		1070	1423	1073			
800	America 800	03>06	0870		1420	0873	1423			
800	Bonneville 800	01>04	0870		1420	0873	1423			
800	Bonneville 800 America	02>	0870		1420	0873	1423			
800	Bonneville 800 T 100 Paul Smith	06>08	0870		1420	0873	1423			
800	Bonneville 800 T100 Centennial Edition	02>04	0870		1420	0873	1423			
800	Speedmaster 800	03>04	0870		1420	0873	1423			
800	Tiger 800	11>	0870		2610	0873	2613			
800	Tiger 800 Xc	11>	0870		2610	0873	2613			
900	Adventurer 900	96>	0870		2640	0890	2643			
900	America 900	07>	0870		1420	0873	1423			
900	Bonneville 900	05>08	0870		1070	0873	1073			
900	Bonneville 900	09>	0870		1420	0873	1423			
900	Bonneville 900 Se	09>	0870		1420	0873	1423			
900	Bonneville 900 T100	05>08	0870		1070	0873	1073			
900	Bonneville 900 T100	09>	0870		1420	0873	1423			
900	Daytona 900	91>94	3030			3033				
900	Daytona Sprint 900	94>	3030		1070	3033	1073			
900	Daytona Sprint 900 (Pinza Dx)	93>	1420		1070	1423	1073			
900	Daytona Sprint 900 (Pinza Sx)	93>	1070		1070	1073	1073			
900	Legend 900 Tt	99>	0870		2640	0890	2643			

Con Piastra - With Plate

PASTIGLIE FRENO RMS - SINTER (RICERCA PER MARCA)

RMS - SINTER BRAKE PADS (SEARCH BY BRAND)



CC	MODELLO MODEL	ANNO YEAR	RMS YOUR BEST PARTNER				SINTER			
			 ANTERIORE FRONT		 POSTERIORE REAR		 ANTERIORE FRONT	 POSTERIORE REAR		
			PASTIGLIA ORGANICA ORGANIC				PASTIGLIA SINTERIZZATA SINTERED			
			 OMOLOGATA HOMOLOGATED	 NON OMOLOGATA NOT HOMOLOGATED	 GANASCE BRAKE SHOES	 OMOLOGATA HOMOLOGATED	 NON OMOLOGATA NOT HOMOLOGATED	 GANASCE BRAKE SHOES		
			22 510		22 512	22 510		22 512	22 510	22 510
900	Scrambler 900	06>	0870		1420		0873	1423		
900	Speed Triple 900	94>	3030		1070		3033	1073		
900	Speed Triple 900 T509	97>98	3030		1420		3033	1423		
900	Speedmaster 900	05>	0870		1420		0873	1423		
900	Thruxtton 900	04>	0870		1420		0873	1423		
900	Thunderbird 900	96>	0870		2640	0890	0873	2643		
900	Thunderbird 900 Sport	03>	0870		2640	0890	0873	2643		
900	Tiger 900	99>00	0870		2640	0890	0873	2643		
900	Tiger 900 (Pinza Dx)	93>98	1070		1420		1073	1423		
900	Tiger 900 (Pinza Sx)	93>98	1420		1420		1423	1423		
900	Trident 900 (Pinza Dx)	91>	1070		1420		1073			
900	Trident 900 (Pinza Sx)	91>	1420		1420		1423	1423		
900	Trophy 900	96>	3030				3033			
900	Trophy 900 (Pinza Dx)	91>95	1070		1420		1073	1423		
900	Trophy 900 (Pinza Sx)	91>95	1420		1420		1423	1423		
950	Daytona 950 T595	95>98	3030		1420		3033	1423		
955	Daytona 955	99>	3030		1420		3033	1423		
955	Daytona 955 Centennial	02>	3030		1420		3033	1423		
955	Speed Triple 955	99>	3030		1420		3033	1423		
955	Sprint Rs 955	00>	3030		1420		3033	1423		
955	Sprint St 955	99>04	3030		1420		3033	1423		
955	Tiger 955	01>04	0870		2640	0890	0873	2643		
955	Tiger 955	05>06	0870		1070		0873	1073		
1000	Daytona 1000	91>95	3030				3033			
1000	Trophy 1000 (Pinza Dx)	91>95	1070		1420		1073	1423		
1000	Trophy 1000 (Pinza Sx)	91>95	1420		1420		1423	1423		
1050	Speed Triple 1050	05>07			1420		2993	1423		
1050	Speed Triple 1050	08>	2860		1420		2863	1423		
1050	Sprint Gt 1050 Abs	11>	3030		1420		3033	1423		
1050	Sprint St 1050	05>	3030		1420		3033	1423		
1050	Tiger 1050	07>			1070		2993	1073		
1050	Tiger Se 1050	09>			1070		2993	1073		
1200	Daytona 1200	91>	3030				3033			
1200	Trophy 1200	96>03	3030				3033			
1200	Trophy 1200 (Pinza Dx)	91>95	1070		1420		1073	1423		
1200	Trophy 1200 (Pinza Sx)	91>95	1420		1420		1423	1423		
1600	Thunderbird 1600	09>	3030		1010		3033	1013		
1600	Thunderbird 1600 Storm	11>	3030		1010		3033	1013		
2300	Rocket Iii 2300	04>	3030		1010		3033	1013		
2300	Rocket Iii 2300 Classic	07>	3030		1010		3033	1013		
2300	Rocket Iii 2300 Roadter	10>	3030		1010		3033	1013		
UVM										
50	Be There 50	99>	0040							
50	Bingo 50	99>	0040							
125	Be There 125	99>	0040							
125	Bingo 125	99>	0040							
125	Paragon 125	99>	0040							
VERTEMATI										
450	C 450 Cross	03>	0430		1330			1333		
450	E 450 Enduro	02>	0430		1330			1333		
450	Sr 450 Motard	03>	1150		1330		1153	1333		
450	Sr 450 Motard Racing	03>	1150		1330		1153	1333		



PASTIGLIE FRENO RMS - SINTER (RICERCA PER MARCA)

RMS - SINTER BRAKE PADS (SEARCH BY BRAND)

CC	MODELLO MODEL	ANNO YEAR	RMS YOUR BEST PARTNER				SINTER			
			ANTERIORE FRONT		POSTERIORE REAR		ANTERIORE FRONT	POSTERIORE REAR		
			PASTIGLIA ORGANICA ORGANIC				PASTIGLIA SINTERIZZATA SINTERED			
			OMOLOGATA HOMOLOGATED	NON OMOLOGATA NOT HOMOLOGATED	GANASCE BRAKE SHOES	OMOLOGATA HOMOLOGATED	NON OMOLOGATA NOT HOMOLOGATED	GANASCE BRAKE SHOES	OMOLOGATA HOMOLOGATED	NON OMOLOGATA NOT HOMOLOGATED
			22 510	22 512	22 510	22 512	22 510	22 510		
500	C 500 Cross	>02	0430		1330			1333		
501	E 501 Enduro	03>	0430		1330			1333		
501	S 501 Motard	02>	1150		1330		1153	1333		
570	C 570 Cross	03>	0430		1330			1333		
570	E 570 Enduro	03>	0430		1330			1333		
600	Sr 600 Motard Racing	03>	1150		1330		1153	1333		
VICTORY										
1500	Kingpin 1500	04>05	1100		1010			1103 1013		
1500	Touring Cruiser 1500	03>06	1100		1010			1103 1013		
1500	V92c Cruiser 1500	98>02	1100		1010			1103 1013		
1500	V92c Deluxe 1500	01>02	1100		1010			1103 1013		
1500	V92sc Sport Cruise 1500	00>02	1100		1010			1103 1013		
1500	Vegas 1500	03>05	1100		1010			1103 1013		
1500	Vegas 8-Ball 1500	05>	1100		1010			1103 1013		
1634	Hammer 1634	05>07	1100		1010			1103 1013		
1634	Hammer 1634	08>	3030		2640 0890			3033 2643		
1634	Hammer S 1634	06>08	1100		1010			1103 1013		
1634	Kingpin 1634	06>07	1100		1010			1103 1013		
1634	Kingpin 1634 All Models	08>	3030		2640 0890			3033 2643		
1634	Kingpin Tour 1634	06>07	1100		1010			1103 1013		
1634	Vegas 1634	06>07	1100		1010			1103 1013		
1634	Vegas 1634	08>	3030		2640 0890			3033 2643		
1634	Vegas 8 Ball 1634	06>07	1100		1010			1103 1013		
1634	Vegas Jackpot 1634	06>07	1100		1010			1103 1013		
1634	Vegas Jackpot 1634	08>	3030		2640 0890			3033 2643		
1731	Cross Country 1731	10>	0970		2640 0890			0973 2643		
1731	Cross Roads 1731	10>	0970		2640 0890			0973 2643		
1731	Hammer 1731	09>	3030		2640 0890			3033 2643		
1731	Hammer S 1731	09>	3030		2640 0890			3033 2643		
1731	Vegas Jackpot 1731	09>	3030		2640 0890			3033 2643		
1731	Vision 1731 All Models	08>	0970		2640 0890			0973 2643		
VOR										
400	All Models 400	00>	0430		1330			1333		
400	En 400	02>	0430		1330			1333		
450	All Models 450	00>	0430		1330			1333		
450	Sm 450	02>	0520		1330		0523	1333		
492	All Models 492	99>	0430		1330			1333		
492	Supermotard 492	00>	0520		1330		0523	1333		
495	All Models 495	99>	0430		1330			1333		
500	Super Motard 500	00>01	0520		1330		0523	1333		
503	All Models 503	00>	0430		1330			1333		
530	All Models 530	02>	0430		1330			1333		
530	En 530	02>	0430		1330			1333		
530	Mx 530	02>	0430		1330			1333		
530	Sm 530	02>	0520		1330		0523	1333		
VOXAN										
1000	Cafe' Racer 1000	01>	0520		0490		0523	0493		
1000	Roadster 1000	01>	0520		0490		0523	0493		
1000	Scrambler 1000	01>03	0870				0873			
1000	Vb1 1000 Evo	04>	1100		0490		1103	0493		

Con Piastra - With Plate

PASTIGLIE FRENO RMS - SINTER (RICERCA PER MARCA)

RMS - SINTER BRAKE PADS (SEARCH BY BRAND)



CC	MODELLO MODEL	ANNO YEAR								
			 ANTERIORE FRONT		 POSTERIORE REAR		 ANTERIORE FRONT	 POSTERIORE REAR		
			PASTIGLIA ORGANICA ORGANIC				PASTIGLIA SINTERIZZATA SINTERED			
			 OMOLOGATA HOMOLOGATED	 NON OMOLOGATA NOT HOMOLOGATED	 GANASCE BRAKE SHOES	 OMOLOGATA HOMOLOGATED	 NON OMOLOGATA NOT HOMOLOGATED	 GANASCE BRAKE SHOES		
			22 510	22 512	22 510	22 512	22 510	22 510		
YAMAHA										
50	50 Axis Profoot	94>	0180			0091				
50	50 Beluga	90>		0051						
50	50 Bw's	92>94		0051		0051				
50	50 Bw's R	95>	0190			0051	0193			
50	50 Fly One	92>	2730	1430						
50	50 Grafix	93>		0051		0051				
50	50 Slider	00>	0280							
50	50 Trafic	93>		0051		0051				
50	50 Trunk	94>	0180			0091				
50	50 Zuma	96>	0190			0051	0193			
50	Bw 50	06>				0480				
50	Bw 50	91>		0051		0051				
50	Bw 50 Bump	97>	0190			0051	0193			
50	Bw 50 Next Generation	96>	0190			0051	0193			
50	Bw 50 Sports Spec R	02>	0190			0051	0193			
50	Bw 50 Spy	95>99	0190			0061	0193			
50	Bws Easy	13>13	0190			0480				
50	Bws Naked	09>13	0190			0480				
50	Cr 50 Target	91>	0180			0061				
50	Cr 50 Z	92>	0180			0061				
50	Ct 50 Super Sport	90>		0061		0061				
50	Cy 50 Jog	90>				0051				
50	Dt 50 R	04>	0360		2810		0363			
50	Dt 50 R	93>	2730	1430		0051				
50	Dt 50 R	98>03	0070			0061				
50	Dt 50 X Supermotard	04>	0360		2810		0363			
50	Ew 50 Slider	00>	0190				0193			
50	Fzr 50	90>91	1070				1073			
50	Fzr 50	92>	1420		1790		1423			
50	Joc 50	90>		0051		0051				
50	Jog 50 (España)	88>	0180							
50	Jog 50 (Italia)	93>	0180			0091				
50	Jog 50 R	02>	3210							
50	Jog 50 R	06>12	0190			0480				
50	Jog 50 Z (Italia)	93>	3210			0091				
50	Mini 50 L Shaft	83>				0051				
50	Rs 50 Champ	88>	0180							
50	Tdr 50	90>	2730	1430	2730	1430				
50	Tzm 50 R	94>	1070		2730	1430	1073			
50	Tzr 50	03>05	0360		0080		0363			
50	Tzr 50	90>92	1070		2730	1430	1073			
50	Tzr 50	93>02	1070		0080		1073			
50	V 50 M	83>		0051		0051				
50	Why 50	97>	0190			0051	0193			
50	Ya 50 Axis	93>	0180			0091				
50	Ye 50 Zest	92>	3210			0061				
50	Ye 50 Zest	93>	0180							
50	Ym 50 Breeze	94>	0190			0051	0193			
50	Yn 50 Neo's	07>13				0480				
50	Yn 50 Neo's	97>	3210			0061				
50	Yn 50 Neo's 4	09>13	0190			0480				

Con Piastra - With Plate



PASTIGLIE FRENO RMS - SINTER (RICERCA PER MARCA)

RMS - SINTER BRAKE PADS (SEARCH BY BRAND)

CC	MODELLO MODEL	ANNO YEAR	RMS YOUR BEST PARTNER				SINTER			
			ANTERIORE FRONT		POSTERIORE REAR		ANTERIORE FRONT	POSTERIORE REAR		
			PASTIGLIA ORGANICA ORGANIC				PASTIGLIA SINTERIZZATA SINTERED			
			OMOLOGATA HOMOLOGATED	NON OMOLOGATA NOT HOMOLOGATED	GANASCE BRAKE SHOES	OMOLOGATA HOMOLOGATED	NON OMOLOGATA NOT HOMOLOGATED	GANASCE BRAKE SHOES		
			22 510	22 512	22 510	22 512	22 510	22 510		
50	Yn 50 Neo's Easy	13>13	0190				0480			
50	Yq 50 Aerox Lc	97>	3210		0280					
50	Ysr 50	86>					0061			
60	Ysr 60	86>					0061			
80	80 Beluga	>89		0061			0061			
80	80 Beluga	90>		0051						
80	Dt 80 (España)	-		0051			0051			
80	Dt 80 Lc (España)	89>					0051			
80	Dt 80 Lc2	93>	2730	1430			0451			
80	Pw 80	91>					0051			
80	T 80 Townmate	83>		0051			0051			
80	Ty 80	83>					0061			
80	Tzr 80	92>95	0180		2730	1430				
80	Tzr 80	96>98	1070		2730	1430		1073		
80	V 80	83>		0051			0051			
90	90 Axis (Brasil)	-	0180							
90	Cr 90 Target	91>	0180				0061			
90	Jog 90	90>	0180							
90	Jog 90 (Brasil)	-	0180							
90	Tt-R 90	00>		0061			0061			
90	Ysr 80	86>					0061			
100	Bw' S 100	99>	0180				0451			
100	Rt 100	94>		0061			0061			
100	Rx 100	83>		0051			0051			
100	Yb 100	82>					0061			
100	Yn 100 Neo's	99>02	3210				0451			
100	Yq 100 Aerox	00>02	3210				0451			
100	Yz 100	82>		0061						
105	105 Crypton	98>	2660				0051	2663		
125	125 Bikan	91>			0730					
125	Dt 125	84>	0040							
125	Dt 125 (Italia)	86>87	0060					0063		
125	Dt 125 Lc / R	88>			2730	1430				
125	Dt 125 R	89>93	2730	1430	2730	1430				
125	Dt 125 R	99>00	2730	1430	2730	1430				
125	Dt 125 Tenere (Italia)	87>	0060					0063		
125	Dt 125 Tenere Scout	90>			2730	1430				
125	Dt 125 X Supermotard	05>	1010		1790			1013		
125	Hw 125 Xenter	12>	3250							
125	Nxc 125 Cygnus X	04>10	2720							
125	R1 125 (Yzf 125 R)	08>	0430		3070			3073		
125	Sr 125 Se	82>92					0061			
125	Td 125 R	93>	2730	1430	2730	1430				
125	Tdr 125	92>			0010			0013		
125	Tdr 125	93>	0410		2730	1430		0413		
125	Tdr 125 (Italia)	90>91			1200					
125	Tdr 125 R	93>	0400					0403		
125	Tt-R 125	00>		0061			0061			
125	Tt-R 125 Lw	00>					0061			
125	Tw 125	98>	2660				0061	2663		
125	Ty 250 R	91>93	0080					0083		
125	Tz 125	97>	3030					3033		

Con Piastra - With Plate

PASTIGLIE FRENO RMS - SINTER (RICERCA PER MARCA)

RMS - SINTER BRAKE PADS (SEARCH BY BRAND)



















CC	MODELLO MODEL	ANNO YEAR	RMS YOUR BEST PARTNER				SINTER			
			 ANTERIORE FRONT		 POSTERIORE REAR		 ANTERIORE FRONT	 POSTERIORE REAR		
			PASTIGLIA ORGANICA ORGANIC				PASTIGLIA SINTERIZZATA SINTERED			
			 OMOLOGATA HOMOLOGATED	 NON OMOLOGATA NOT HOMOLOGATED	 GANASCE BRAKE SHOES	 OMOLOGATA HOMOLOGATED	 NON OMOLOGATA NOT HOMOLOGATED	 GANASCE BRAKE SHOES		
			22 510	22 512	22 510	22 512	22 510	22 510		
125	Tz 125	98>	3030				3033			
125	Tzr 125	90>92	0730							
125	Tzr 125	93>	0410		2730	1430	0413			
125	Tzr 125 (Italia)	91>	0520		0010		0523	0013		
125	Tzr 125 (Versione Spagna)	87>	1070				1073			
125	Tzr 125 Red Rocket	93>	0520		0010		0523	0013		
125	Vp 125 X-City	08>10	0430		0490			0493		
125	Wr 125	91>97	1420		1790		1423			
125	Wr 125	98>02	0920		2630		0923	2633		
125	Wr 125 R - X	09>	0870		1330		0873	1333		
125	Xc 125 Cygnus R	96>03	2730	1430			0061			
125	Xc 125 Tr Cygnus R	96>	2730	1430			0061			
125	Xc Beluga	90>95					0451			
125	Xc K 125 Cygnus R	97>98	2730	1430			0061			
125	Xc T 125 Cygnus R	95>98					0061			
125	Xn 125 Teos	00>01	0190				0451	0193		
125	Xq 125 Maxter	01>02	0430		0490			0493		
125	Xt 125 R	05>	0080		2810		0083			
125	Xt 125 X Supermotard	05>	0740		2810					
125	Xtz 125	05>	1420				1423			
125	Xv 125 Virago	97>00	0410				0413			
125	Xvs 125 Drag Star	00>04	0410				0451	0413		
125	Ybr 125	05>	2730	1430						
125	Yp 125 Majesty	01>02	0430		0490			0493		
125	Yp 125 Majesty	98>00	0430				0451			
125	Yp E 125 Majesty	03>09	0430		0490			0493		
125	Yp R 125 X-Max	06>09	0770		0490		0773	0493		
125	Yp R 125 X-Max	10>11	2640	0890	0490		2643	0493		
125	Yp R 125 X-Max Abs	11>	2640	0890	2660		2643	2663		
125	Yw 125 Bws	10>	3250							
125	Yz 125	03>07	0920		1450		0923	1453		
125	Yz 125	08>11	2840		1450		2843	1453		
125	Yz 125	88>			2730	1430				
125	Yz 125	89>	1420				1423			
125	Yz 125	98>02	0920		2630		0923	2633		
125	Yz 125 All Models	90>97	1420				1423			
125	Yzf-R 125	08>	0430		3070			3073		
125	Xc Vity	08	3290							
125	Ybr Custom	06-12	3290							
125	Ybr Ed	07-12	3290							
125	Nxc Cygnus	10	3300							
135	T Crypton	06-13	3290							
150	Hw 150 Xenter	12>	3250							
150	Xc 150 Cygnus Gt	90>95	2730	1430			0061			
150	Xc 150 Fly One	90>95	2730	1430						
150	Xc 150 Fly One R	97>98	2730	1430						
150	Xn 150 Teos	01>02	0190				0193			
150	Xq 150 Maxter	01>02	0430		0490			0493		
150	Yp 150 Majesty	00>	0430							
150	Yp 150 Majesty	01>02	0430		0490			0493		
175	Dt 175	00>	2660				2663			
180	Yp E 180 Majesty	>03	0430							

Con Piastra - With Plate



PASTIGLIE FRENO RMS - SINTER (RICERCA PER MARCA)

RMS - SINTER BRAKE PADS (SEARCH BY BRAND)

CC	MODELLO MODEL	ANNO YEAR	 YOUR BEST PARTNER							
			 ANTERIORE FRONT		 POSTERIORE REAR		 ANTERIORE FRONT	 POSTERIORE REAR		
			 PASTIGLIA ORGANICA ORGANIC				 PASTIGLIA SINTERIZZATA SINTERED			
			 OMOLOGATA HOMOLOGATED	 NON OMOLOGATA NOT HOMOLOGATED	 GANASCE BRAKE SHOES	 OMOLOGATA HOMOLOGATED	 NON OMOLOGATA NOT HOMOLOGATED	 GANASCE BRAKE SHOES		
			22 510		22 512	22 510		22512	22 510	22 510
180	Yp E 180 Majesty	03>06	0430			0490			0493	
200	Dt 200 Wr	91>	1420			1790		1423		
200	Tw 200	01>	2660				0061	2663		
200	Tw 200	87>00					0061			
200	Tw 200	94>	2660					2663		
200	Wr 200 B	91>	1420			1790		1423		
225	Bronco 225	97>	2660					2663		
225	Cellow 225	97>	2660					2663		
225	Serow 225 Xt	85>92	2730	1430			0061			
225	Serow 225 Xt	93>	2730	1430		1790				
225	Ttr 225	01>	2730	1430			0061			
225	Xt 225	01>	2660				0061	2663		
225	Xt 225	92>00	2730	1430			0061			
225	Xt 225 Serow	86>	2730	1430			0061			
250	Fzr 250 R	89>	1060					1063		
250	Fzx 250 Zeal	91>	0400					0403		
250	R1 250 Z	90>						3093		
250	Srv 250 Soulfultwin Renaissa	96>	0400					0403		
250	Tdr 250	88>						3093		
250	Tt 250 R	93>99	1420			1790		1423		
250	Tt-R 250	00>	1420			2630		1423	2633	
250	Ty 250 Z	93>95	0080			0080		0083	0083	
250	Ty 250 Z Scottish	96>	0400			1790		0403		
250	Tz 250	02>	3030					3033		
250	Tz 250	85>						3093		
250	Tz 250 A - Gp	90>01	3030					3033		
250	Tz 250 Competition	88>						3093		
250	Tzr 250	85>89						3093		
250	Tzr 250 R - Sp	91>	1060					1063		
250	Vp 250 X-City	07>11	0430			2660			2663	
250	Wr 250	98>00	0920			2630		0923	2633	
250	Wr 250 Z	91>97	1420			1790		1423		
250	Wr F 250	01>02	0920			2630		0923	2633	
250	Wr F 250	03>11	0920			1450		0923	1453	
250	Wr R 250	08>	0920			2630		0923	2633	
250	Wr X 250	08>	1420			2630		1423	2633	
250	Xg 250 Tricker	05>	2660			1790		2663		
250	Xv 250 S Virago	95>	0410				0451	0413		
250	Xvs 250 Drag Star	01>	0410				0451	0413		
250	Ybr 250	07>	1070					1073		
250	Yd 250 S	91>	0730							
250	Yp 250 Majesty	00>03	0410			2660		0413	2663	
250	Yp 250 Majesty	96>98	0410				0460	0413		
250	Yp 250 Majesty Abs	03>	0410			2660		0413	2663	
250	Yp 250 Majesty Dx	98>99	0410			2660		0413	2663	
250	Yp R 250 X-Max	05>09	0770			2660		0773	0493	
250	Yp R 250 X-Max	10>11	2640	0890		2660		2643	2663	
250	Yp R 250 X-Max Abs	11>	2640	0890		2660		2643	2663	
250	Yp R 250 X-Max Sport	11>	2640	0890		2660		2643	2663	
250	Yz 250	03>07	0920			1450		0923	1453	
250	Yz 250	08>11	2840			1450		2843	1453	
250	Yz 250	88>				2730	1430			

Con Piastra - With Plate

PASTIGLIE FRENO RMS - SINTER (RICERCA PER MARCA)

RMS - SINTER BRAKE PADS (SEARCH BY BRAND)















CC	MODELLO MODEL	ANNO YEAR	RMS YOUR BEST PARTNER				SINTER			
			 ANTERIORE FRONT		 POSTERIORE REAR		 ANTERIORE FRONT	 POSTERIORE REAR		
			PASTIGLIA ORGANICA ORGANIC				PASTIGLIA SINTERIZZATA SINTERED			
			 OMOLOGATA HOMOLOGATED	 NON OMOLOGATA NOT HOMOLOGATED	 GANASCE BRAKE SHOES	 OMOLOGATA HOMOLOGATED	 NON OMOLOGATA NOT HOMOLOGATED	 GANASCE BRAKE SHOES		
			22 510		22 512		22 510		22 512	
250	Yz 250	89>	1420				1423			
250	Yz 250	90>92	1420		1790		1423			
250	Yz 250	95>97	1420				1423			
250	Yz 250	98>02	0920		2630		0923	2633		
250	Yz 250 Wra/Wrb	90>94	1420		1790		1423			
250	Yz F 250	01>02	0920		2630		0923	2633		
250	Yz F 250	03>06	0920		1450		0923	1453		
250	Yz F 250	07>11	2840		1450		2843	1453		
250	Yz F 250 R25	15>					3483			
250	Yp R X-Max	14			3270			3273		
300	Xc 300 Versity	03>06	0430		0430					
300	Xc 300 Versity	05>06		0890	0570					
321	Yz F R3	15>					3483			
350	Rd 350 Ypvs	83>84			0730					
350	Tt 350	91>			2730	1430				
350	Xt 350	92>	2730	1430			0451			
360	Yz 360	89>	1420				1423			
400	400 Artesia	91>	3200		2730	1430	3203			
400	Fz 400	86>	0730							
400	Fzr 400 R	87>			0730		3093			
400	Fzr 400 Rr - Sp	91>	1060				1063			
400	Srx 400	85>86	0730							
400	Srx 400	87>89					3093			
400	Srx 400	90>			0730					
400	Wr F 400	99>02	0920		2630		0923	2633		
400	Xj 400 Diversion - R	91>94	0410				0413			
400	Xj 400 R	95>	0410		0730		0413			
400	Xvs 400	98>99	0400				0403			
400	Yp 400 Majesty	04>	0400		0800		0403	0803		
400	Yp 400 Majesty	05>06	0410		0800		0413	0803		
400	Yp 400 Majesty	07>11	0410		0800		0413	0803		
400	Yp 400 Majesty Abs	07>11	0410		0800		0413	0803		
400	Yz F 400	98>	0920				0923			
400	Yz F 400	99>	0920		2630		0923	2633		
426	Wr F 426	01>	0920		2630		0923	2633		
426	Yz F 426	99>02	0920		2630		0923	2633		
450	Wr F 450	03>11	0920		1450		0923	1453		
450	Yz F 450	03>07	0920		1450		0923	1453		
450	Yz F 450	08>11	2840		1450		2843	1453		
500	Rd 500 Lc	84>	0730							
500	Rd 500 Ypvs Lc	87>	0730							
500	Wr 500 B	91>	1420		1790		1423			
500	Xp 500 T Max	01>03	0400		1410		0403	1413		
500	Xp 500 T Max	04>07	0410		0800		0413	0803		
500	Xp 500 T Max	08>11	1060		0800		1063	0803		
500	Xp 500 T Max Abs	05>07	0410		0800		0413	0803		
500	Xp 500 T Max Abs	08>11	1060		0800		1063	0803		
500	Xp 500 T Max Sv	11>	1060		0800		1063	0803		
500	Xp 500 T Max Sv Abs	11>	1060		0800		1063	0803		
500	Xt E 500	00>	1420				1423			
530	Xp 530 T-Max	12>	1060		0800		1063	0803		
535	Xv 535 Dx Virago	01>	0400				0403			



PASTIGLIE FRENO RMS - SINTER (RICERCA PER MARCA)

RMS - SINTER BRAKE PADS (SEARCH BY BRAND)

CC	MODELLO MODEL	ANNO YEAR	 YOUR BEST PARTNER					
			 ANTERIORE FRONT		 POSTERIORE REAR		 ANTERIORE FRONT	 POSTERIORE REAR
			PASTIGLIA ORGANICA ORGANIC				PASTIGLIA SINTERIZZATA SINTERED	
								
			OMOLOGATA HOMOLOGATED	NON OMOLOGATA NOT HOMOLOGATED	GANASCE BRAKE SHOES	OMOLOGATA HOMOLOGATED	NON OMOLOGATA NOT HOMOLOGATED	GANASCE BRAKE SHOES
22 510		22 512	22 510		22512	22 510	22 510	
535	Xv 535 Virago	95>01	0400		0403			
600	Fz 600	87>	0730					
600	Fz6 600	04>07	0410		0930	0413	0933	
600	Fz6 600 Fazer	04>07	0410		0930	0413	0933	
600	Fz6 600 Fazer Abs	06>07	0410		0930	0413	0933	
600	Fz6 600 Fazer S2	07>08	1060		0930	1063	0933	
600	Fz6 600 Fazer S2 Abs	08>	1060		0930	1063	0933	
600	Fz6 600 Ns	05>06	0410		0930	0413	0933	
600	Fz6 600 S2	07>08	1060		0930	1063	0933	
600	Fzr 600	89>	0730					
600	Fzr 600 R	90>	0730					
600	Fzr 600 R	91>	0730					
600	Fzs 600 Fazer	98>	1060		1063			
600	Fzs 600 Sp Fazer	00>03	1060		1063			
600	Srx 600	87>			3093			
600	Tt 600	93>	0430		1790			
600	Tt 600 N	85>88	2730	1430				
600	Tt 600 R	98>	0430		1330	1333		
600	Tt 600 R (Sportkit)	94>97	0430		1790			
600	Tt-R 600 R	00>	0430		1330	1333		
600	Xj 600 Radian	84>91	0730		0730			
600	Xj 6F 600 Diversion	10>11	0410		2610	0413	2613	
600	Xj 6Fa 600 Diversion	11>	0410		2610	0413	2613	
600	Xj 6N 600	09>10	0410		2610	0413	2613	
600	Xj 6S 600 Diversion	09>11	0410		2610	0413	2613	
600	Xj S 600 Diversion	92>97	0400		0403			
600	Xj S 600 Diversion	98>02	0410		0413			
600	Xt E 600	90>02	3200		2730	1430	3203	
600	Xt K 600	91>93	3200		2730	1430	3203	
600	Yzf 600 R	>94			0730			
600	Yzf 600 R Thunder Cat	95>98	1060		0730	1063		
600	Yzf 600 R6	99>02	1060		2660	1063	2663	
600	Yzf 600 R6	03>11	1060		0930	1063	0933	
650	Xvs 650 A Drag Star Classic	98>05	0400		0403			
650	Xvs 650 Drag Star	97>02	0400		0403			
660	Mt-03 660	06>11	0410		1330	0413	1333	
660	Szr 660	96>	0520		0010	0523	0013	
660	Xt R 660	04>11	1010		1330	1013	1333	
660	Xt X 660	04>11	1100		1330	1103	1333	
660	Xt Z 660 Tenere	91>96	3200		2730	1430	3203	
660	Xt Z 660 Tenere	08>10	0430		1330	1333		
750	Fz 750	85>	0730		0730			
750	Fz 750 Genesis	87>	0730		0730			
750	Fzr 750 (O W01)	89>91	3030		0730	3033		
750	Fzr 750 Genesis	87>			0730	3123		
750	Fzx 750 Fazer	86>	0730		0730			
750	Tzr 750 W	89>	3030		0730			
750	Xj 750 F	84>	0730		0730			
750	Xt Z 750 Super Tenere (Pinza Dx)	89>95	1420		1423			
750	Xt Z 750 Super Tenere (Pinza Sx)	89>95	1070		1073			
750	Xv 750	89>93	0730					
750	Xv 750 Virago	94>	0400		0403			

Con Piastra - With Plate

PASTIGLIE FRENO RMS - SINTER (RICERCA PER MARCA)

RMS - SINTER BRAKE PADS (SEARCH BY BRAND)



CC	MODELLO MODEL	ANNO YEAR	RMS YOUR BEST PARTNER				SINTER			
			 ANTERIORE FRONT		 POSTERIORE REAR		 ANTERIORE FRONT	 POSTERIORE REAR		
			PASTIGLIA ORGANICA ORGANIC				PASTIGLIA SINTERIZZATA SINTERED			
			 OMOLOGATA HOMOLOGATED	 NON OMOLOGATA NOT HOMOLOGATED	 GANASCE BRAKE SHOES	 OMOLOGATA HOMOLOGATED	 NON OMOLOGATA NOT HOMOLOGATED	 GANASCE BRAKE SHOES		
			22 510		22 512		22 510		22 512	
750	Yzf 750 R7 (Ow02) Road Version	99>	1060				1063			
750	Yzf 750 Rr-Sp	93>98			0730					
800	Fz8-N 800	11>	1060		0930		1063 0933			
800	Fz8-Na 800	11>	1060		0930		1063 0933			
800	Fz8-S 800	11>	1060		0930		1063 0933			
800	Fz8-Sa 800	11>	1060		0930		1063 0933			
850	Tdm 850	91>95			0730		3093			
850	Tdm 850	96>			0730					
850	Trx 850	95>	1100		0730		1103			
900	Tdm 900	02>05	1060		3130		1063 3133			
900	Tdm 900 A	05>08	1060		3130		1063 3133			
900	Xj 900	83>	0730		0730					
900	Xj 900	85>	0730		0730					
900	Xj 900 F	85>94	0730		0730					
900	Xj 900 Seca Diversion	95>	0400		0730		0403			
950	Xvs 950 A Midnight Star	09>11	0400		3130		0403 3133			
1000	Fz1 1000	06>09	1060		0930		1063 0933			
1000	Fz1 1000 Fazer	06>09	1060		0930		1063 0933			
1000	Fz1 1000 Fazer Abs	07>08	1060		0930		1063 0933			
1000	Fz1 1000 Fazer Abs	11>	1060		0930		1063 0933			
1000	Fz1 1000 N - Na	11>	1060		0930		1063 0933			
1000	Fzr 1000 Ex-Up	91>93			0730					
1000	Fzr 1000 Genesis - Ex-Up	86>88			0730		3093			
1000	Fzr 1000 R	94>			0730					
1000	Fzr 1000 R - Ex-Up	89>90			0730					
1000	Fzs 1000 Fazer	01>05	1060				1063			
1000	Gts 1000	93>			0730					
1000	Xv 1000 Virago	86>	0730							
1000	Yzf 1000 R Thunder Ace	96>	1060		0730		1063			
1000	Yzf 1000 R1	98>01	1060				1063			
1000	Yzf 1000 R1	02>03	1060		2660		1063 2663			
1000	Yzf 1000 R1	04>06	1060		0930		1063 0933			
1000	Yzf 1000 R1	07>12			0930		2973 0933			
1100	Bt 1100 Bulldog	02>06	1060		0730		1063			
1100	Fj 1100 J	84>84	0730		0730					
1100	Xv 1100 Virago	86>93	0730							
1100	Xv 1100 Virago	94>98	0400				0403			
1100	Xv 1100 Virago	99>	0410		0730		0413			
1100	Xvs 1100 A Drag Star Classic	00>	0410		0730		0413			
1100	Xvs 1100 A V-Star Star Classic	01>	0410		0730		0413			
1100	Xvs 1100 Drag Star	99>	0410		0730		0413			
1200	1200 Venture	84>	0730		0730					
1200	1200 Venture Royale	87>	0730		0730					
1200	Fj 1200	86>87	0730		0730					
1200	Fj 1200	88>			0730		3123			
1200	Fj 1200 Abs	91>			0730		3123			
1200	Fj 1200 W - Wc	89>91			0730		3093			
1200	V-Max 1200 (Ymx 12N)	93>			0730					
1200	V-Max 1200 (Ymx 12N)	>92	0730		0730					
1200	Xjr 1200	94>			0730		3123			
1200	Xjr 1200	95>	1100		0730		1103			
1200	Xtz 1200 Super Tenere	10>11	1060		3130		1063 3133			

Con Piastra - With Plate



PASTIGLIE FRENO RMS - SINTER (RICERCA PER MARCA)

RMS - SINTER BRAKE PADS (SEARCH BY BRAND)

CC	MODELLO MODEL	ANNO YEAR	RMS YOUR BEST PARTNER				SINTER			
			ANTERIORE FRONT		POSTERIORE REAR		ANTERIORE FRONT	POSTERIORE REAR		
			PASTIGLIA ORGANICA ORGANIC				PASTIGLIA SINTERIZZATA SINTERED			
			OMOLOGATA HOMOLOGATED	NON OMOLOGATA NOT HOMOLOGATED	GANASCE BRAKE SHOES	OMOLOGATA HOMOLOGATED	NON OMOLOGATA NOT HOMOLOGATED	GANASCE BRAKE SHOES		
			22 510	22 512	22 510	22 512	22 510	22 510		
1200	Xvz 1200 12 Ttd	85>	0730		0730					
1300	1300 Stryker	11>	0400		3130		0403	3133		
1300	Fjr 1300	01>04	1060		3130		1063	3133		
1300	Fjr 1300 A	03>05	1060		3130		1063	3133		
1300	Fjr 1300 A Abs	06>08	0380		3130		0383	3133		
1300	Fjr 1300 A Abs	11>	0380		3130		0383	3133		
1300	Fjr 1300 Abs	06>	0380		3130		0383	3133		
1300	Fjr 1300 As	06>08	0380		3130		0383	3133		
1300	Xjr 1300	99>01	1060		0730		1063			
1300	Xjr 1300	02>11	1060				1063			
1300	Xjr 1300 Sp	01>01	1060		0730		1063			
1300	Xv 1300 Ah/Ath Royal Star	96>					3123	3093		
1300	Xvs 1300 A Midnight Star	07>	0410		3130		0413	3133		
1300	Xvz 1300 Td	88>					3093	3093		
1300	Xvz 1300 Tf Royal Star Venture	99>	0400				0403	3093		
1600	Xv 1600 Road Star Silverado	99>02	0400				0403	3093		
1600	Xv 1600 Wild Star Silverado	99>02	0400				0403	3093		
1670	Xv 1670 Royals Star Warrior	02>	1060		3130		1063	3133		
1700	Mt-01 1700	05>06	1060		2640	0890	1063	2643		
1700	Mt-01 1700	07>			2640	0890	2973	2643		
1700	Mt-01 1700	09>			2640	0890	2973	2643		
1700	Mt-01S 1700	09>			2640	0890	2973	2643		
1700	V Max 1700	09>10			3130		2973	3133		
1700	Xv 1700 Pc Road Star Warrior	03>	1060		3130		1063	3133		
1700	Xv 1700 Road Star Warrior	02>	1060				1063	3093		
1700	Xv 1700 Warrior	03>04	1060		3130		1063	3133		
1900	Xv 1900 A Midnight Star	07>09	1060		3130		1063	3133		
1900	Xv 1900 Midnight Star	06>	1060		3130		1063	3133		
YAMAHA ATV										
60	Ys 60 S (Moto4)	86>				0051				
60	Yt 60 L/N Tri Zinger	84>85				0051				
80	Yfm 80 Badger	92>01			0061					
80	Yfm 80 T/U	87>88			0051					
100	Yfm 100 T/U Champ	87>			0061					
100	Yfm 100 T/U Champ	87>88			0051					
100	Yfm 100 W/A/B Champ	89>91			0061					
125	Yfa 1 125 Breeze	89>91			0061					
125	Yfa 1 125 Breeze	92>02			0061					
175	Yt 175 J/K (Tri Moto)	82>83			0061					
200	Yfm 200 All Models (Moto 4)	85>89			0061					
200	Yfs 200 Blaster	88>01			0061					
200	Yfs 200 R Blaster	03>	1440		2850			2853		
200	Ytm 200 All Models (Tri Moto)	83>85			0061					
225	Yfm 225 S/T/U (Moto 4)	86>88			0061					
225	Ytm 225 All Models (Tri Moto)	85>86			0061					
250	Yfb 250 D/E/F Timberwolf	92>94			0061					
250	Yfm 250 An Bruin 2X4	05>	1440							
250	Yfm 250 Bear Traker	01>	1440							
250	Ytz 250 N/S (Tri Moto)	85>86	2730	1430	2730	1430				
350	Yfm 350 Bruin 2X4 / 4X4	04>	1440							
350	Yfm 350 Ert/Eru	87>88			0061					
350	Yfm 350 F Wolverine	95>01	1440		2850			2853		

Con Piastra - With Plate

PASTIGLIE FRENO RMS - SINTER (RICERCA PER MARCA)

RMS - SINTER BRAKE PADS (SEARCH BY BRAND)



CC	MODELLO MODEL	ANNO YEAR	RMS YOUR BEST PARTNER				SINTER			
			 ANTERIORE FRONT		 POSTERIORE REAR		 ANTERIORE FRONT	 POSTERIORE REAR		
			PASTIGLIA ORGANICA ORGANIC				PASTIGLIA SINTERIZZATA SINTERED			
			 OMOLOGATA HOMOLOGATED	 NON OMOLOGATA NOT HOMOLOGATED	 GANASCE BRAKE SHOES	 OMOLOGATA HOMOLOGATED	 NON OMOLOGATA NOT HOMOLOGATED	 GANASCE BRAKE SHOES		
			22 510		22 512		22 510		22 512	
350	Yfm 350 Fwb/Lc Big Bear	99>	1440							
350	Yfm 350 Fwt/Fwu Big Bear	87>88			2850			2853		
350	Yfm 350 R Raptor	04>	2850		2850		2853	2853		
350	Yfm 350 X Warrior	90>01	1440		2850			2853		
350	Yfm 350 Xt	87>	2730 1430		2850			2853		
350	Yfm 350 Xu Warrior	88>	2730 1430		2850			2853		
350	Yfm 350 Xw Warrior	89>	1440		2850			2853		
350	Yfz 350 Banshee	90>01	1440		2850			2853		
350	Yfz 350 Banshee T/U/W	87>89	2730 1430		2850			2853		
400	Yfm 400 Big Bear 2Wd Nm/Nmc	00>	1440							
400	Yfm 400 F Big Bear	00>01	1440							
400	Yfm 400 F Big Bear 4Wd	01>	1440							
400	Yfm 400 Fam/Fan Kodiak	00>01	1440		2870			2873		
400	Yfm 400 Fwn Big Bear 4Wd	00>	1440		2870			2873		
400	Yfm 400 Kodiak 2Wd Am/An	00>01	1440		2870			2873		
400	Yfm 400 N Big Bear 2Wd	00>	1440		2870			2873		
450	Yfm 450 Far Kodiak	03>	1440		2870			2873		
450	Yzf 450 S (Pinza Dx)	04>	1420		2850		1423	2853		
450	Yzf 450 S (Pinza Sx)	04>	1070		2850		1073	2853		
600	Yfm 600 Grizzly	02>05	2850				2853			
600	Yfm 600 Grizzly 4X4	98>01	2850				2853			
600	Yfm 600 Grizzly Hunter Edition	01>	2850				2853			
600	Yfm 600 Grizzly Hunting	00>	2850				2853			
660	Rhino 660 (Pinza Dx)	05>	1070				1073			
660	Rhino 660 (Pinza Sx)	05>	1420				1423			
660	Yfm 660 Grizzly	02>	2850				2853			
660	Yfm 660 Raptor Rn	01>	2850		2850		2853	2853		
660	Yxr 660 Rhino 4X4 (Pinza Sx)	04>06			3180			3183		
660	Yxr 660 Rhino 4X4 (Pinza Dx)	04>06	1070				1073			
660	Yxr 660 Rhino 4X4 (Pinza Sx)	04>06	1420				1423			
700	Yfm 700 Raptor (Pinza Dx)	06>07	1070		3180		1073	3183		
700	Yfm 700 Raptor (Pinza Sx)	06>07	1420		3180		1423	3183		
ZANELLA										
50	Racing Moped 50	92>	0010					0013		
125	Rza 125	92>	0010					0013		
ZUNDAPP										
80	Ks 80 Super	80>	0010				0013			
80	Ks 80 Touring K	82>	0030							
80	Ks 80 Touring L	82>	0030							
125	Ks 125	82>	3150				3153			
175	Ks 175	82>	3150				3153			



RMS
YOUR BEST PARTNER

The background of the entire page is a repeating pattern of various motorcycle-related icons in a light grey color. These icons include a motorcycle silhouette, a brake disc, a battery, a wrench, a screwdriver, a nut, a bolt, a spring, a gear, and a chain link. The icons are arranged in a grid-like fashion, creating a textured, technical background.

▶ DISCHI FRENO

BRAKE DISCS

The logo for RMS features the letters 'RMS' in a bold, blue, sans-serif font. A red horizontal line is positioned below the 'M' and 'S', and a green horizontal line is positioned below the 'R'. To the left of the 'R' is a small white right-pointing triangle. Below the 'RMS' text, the tagline 'YOUR BEST PARTNER' is written in a smaller, blue, sans-serif font.

▶ **RMS**
YOUR BEST PARTNER



DISCHI FRENO

BRAKE DISCS

APRILIA

22 516 0020



(R.O. AP8213383)

Ø esterno mm Ø External mm	Ø interno mm Ø Internal mm	Spessore mm Thickness mm	Ø Fori Fiss. mm Ø Fixing holes mm
155	40,7	3,6	10,7



22 516 0040



(R.O. AP8213381)

Ø esterno mm Ø External mm	Ø interno mm Ø Internal mm	Spessore mm Thickness mm	Ø Fori Fiss. mm Ø Fixing holes mm
220	60	4	6,5



22 516 0050



(R.O. AP8113541)

Ø esterno mm Ø External mm	Ø interno mm Ø Internal mm	Spessore mm Thickness mm	Ø Fori Fiss. mm Ø Fixing holes mm
220	60	4	8



MODELLO MODELS	CC	ANNO YEAR	ANT FRONT	POST. REAR
Amico	50	94	.	.
Sonic	50	98-07	.	.
Sonic Gp	50	98-08	.	.

MODELLO MODELS	CC	ANNO YEAR	ANT FRONT	POST. REAR
Scarabeo	50	98-05	.	.
Scarabeo 4T	50	02-06	.	.
Scarabeo 4T Rst Eu3	50	08-10	.	.
Scarabeo Ditech	50	01-04	.	.
Scarabeo Quattro	50	09	.	.
Scarabeo Street	50	05-06	.	.
Scarabeo Street 2T Rst	50	06-10	.	.
Scarabeo 4T 4V	50	09-14	.	.
Scarabeo 2T	50	09-14	.	.
Scarabeo 4T	100	01-14	.	.
Scarabeo 4T Rst	100	06-09	.	.
Scarabeo Motore Minarelli	100	00	.	.
Scarabeo Motore Yamaha	100	00	.	.

MODELLO MODELS	CC	ANNO YEAR	ANT FRONT	POST. REAR
Leonardo	125	96-02	.	.
Leonardo St	125	01-04	.	.
Scarabeo Motore Rotax	125	99-03	.	.
Sport City Cube	125	08-10	.	.
Sport City Eu3	125	06-08	.	.
Sport City	125	04-06	.	.
Leonardo	250	99-04	.	.
Leonardo St	250	01	.	.
Sport City Cube	250	08-12	.	.
Sport City Street	300	12	.	.

22 516 0200



(R.O. AP8213231)

Ø esterno mm Ø External mm	Ø interno mm Ø Internal mm	Spessore mm Thickness mm	Ø Fori Fiss. mm Ø Fixing holes mm
190	58	4	8



22 516 0250



(R.O. AP8113697)

Ø esterno mm Ø External mm	Ø interno mm Ø Internal mm	Spessore mm Thickness mm	Ø Fori Fiss. mm Ø Fixing holes mm
260	60	4	8,5



22 516 2131



NEW

(R.O. AP8133601)

Ø esterno mm Ø External mm	Ø interno mm Ø Internal mm	Spessore mm Thickness mm	Ø Fori Fiss. mm Ø Fixing holes mm
190	68	4,1	8,5



MODELLO MODELS	CC	ANNO YEAR	ANT FRONT	POST. REAR
Area 51	50	98-00	.	.
Gulliver	50	95-98	.	.
Gulliver Lc	50	96-98	.	.
Mojito	50	04-08	.	.
Mojito Custom	50	99-03	.	.
Mojito Custom 2T Piaggio	50	04-10	.	.
Mojito Retro	50	99-03	.	.
Rally	50	95-03	.	.
Rally Liquid Cooled	50	96-99	.	.
Scarabeo	50	98	.	.
Scarabeo	50	99-05	.	.
Scarabeo Ditech	50	01-04	.	.
Sr	50	93-96	.	.
Sr Ditech Eu2	50	02-03	.	.
Sr H2O Ditech e Carburatore	50	00-03	.	.
Sr Liquid Cooled	50	94-96	.	.
Sr R Factory Motore Aprilia	50	05	.	.
Sr R R Factory	50	04-10	.	.
Sr Stealth, Racing	50	97-99	.	.
Sr Street	50	03-12	.	.
Sr Www	50	97-01	.	.
Sr ie e Carburatore	50	14	.	.
Sr R Factory ie e Carburatore	50	10-14	.	.
Leonardo	125	96-01	.	.
Leonardo St	125	01-04	.	.
Mojito	125	03-08	.	.
Mojito Retro' - Custom	125	99-01	.	.
Sr	125	99-01	.	.

MODELLO MODELS	CC	ANNO YEAR	ANT FRONT	POST. REAR
Scarabeo	125	03-06	.	.
Scarabeo Eu3	125	06-07	.	.
Scarabeo Motore Rotax	125	99-04	.	.
Scarabeo Motore Piaggio	125	06	.	.
Sport City	125	04-06	.	.
Sport City Eu3	125	06-08	.	.
Sport City Cube	125	08-10	.	.
Sport City Street	125	12	.	.
Scarabeo Light	250	06-08	.	.
Sport City	250	08-12	.	.
Scarabeo Light	300	09-10	.	.
Sport City Street	300	12	.	.
Scarabeo Light	400	06-08	.	.
Atlantic	500	01-04	.	.
Scarabeo	500	03-06	.	.

MODELLO MODELS	CC	ANNO YEAR	ANT FRONT	POST. REAR
Sr R Factory ie e Carburatore	50	10-14	.	.
Sr R R Factory	50	04-09	.	.
Atlantic	125	03-05	.	.
Atlantic Eu3	125	06-12	.	.
Atlantic	300	10-11	.	.



APRILIA

22 516 2141



NEW

22 516 2151



NEW

22 516 2070



(R.O. AP8133606)

Ø esterno mm Ø External mm	Ø interno mm Ø Internal mm	Spessore mm Thickness mm	Ø Fori Fiss. mm Ø Fixing holes mm
240	105	4,5	6,6



(R.O. AP8133627)

Ø esterno mm Ø External mm	Ø interno mm Ø Internal mm	Spessore mm Thickness mm	Ø Fori Fiss. mm Ø Fixing holes mm
240	125	4,1	6,6



(R.O. 56393R)

Ø esterno mm Ø External mm	Ø interno mm Ø Internal mm	Spessore mm Thickness mm	Ø Fori Fiss. mm Ø Fixing holes mm
260	125	5	6,5



MODELLO MODELS	CC	ANNO YEAR	ANT FRONT	POST. REAR
Atlantic	125	03-05	•	
Atlantic Eu3	125	06-08	•	
Atlantic Eu3	125	10-11	•	
Atlantic	300	10-11	•	

MODELLO MODELS	CC	ANNO YEAR	ANT FRONT	POST. REAR
Scarabeo Mot. Piaggio Eu3	125	06		•
Scarabeo	125	03-06		•
Scarabeo Light	400	06-08		•
Scarabeo Light	500	06-08		•

MODELLO MODELS	CC	ANNO YEAR	ANT FRONT	POST. REAR
Sr Max	300	10		•

ATALA

22 516 2161



NEW

22 516 0120



(R.O. 852437)

Ø esterno mm Ø External mm	Ø interno mm Ø Internal mm	Spessore mm Thickness mm	Ø Fori Fiss. mm Ø Fixing holes mm
240	125	4,1	6,6



Ø esterno mm Ø External mm	Ø interno mm Ø Internal mm	Spessore mm Thickness mm	Ø Fori Fiss. mm Ø Fixing holes mm
155	39	4,1	6,5



MODELLO MODELS	CC	ANNO YEAR	ANT FRONT	POST. REAR
Scarabeo Light	250	06-08		•
Scarabeo Light	300	09-10		•

MODELLO MODELS	CC	ANNO YEAR	ANT FRONT	POST. REAR
At 10	50	-		•

BENELLI

22 516 0010



(R.O. 810011A0)

Ø esterno mm Ø External mm	Ø interno mm Ø Internal mm	Spessore mm Thickness mm	Ø Fori Fiss. mm Ø Fixing holes mm
190	58	4	9



MODELLO MODELS	CC	ANNO YEAR	ANT FRONT	POST. REAR
491 Gt	50	98-99		•
491 Racing	50	98-99		•
491 Rr	50	98-01		•
491 Rr Morini	50	03-04		•
491 Sp	50	99		•
491 Sport	50	98-99		•
491 St	50	-		•
491 St Morini	50	03		•
K2	50	98-01		•
K2	100	99-01		•



DISCHI FRENO
BRAKE DISCS

BETA

22 516 0010

22 516 0200

(R.O. 1333290000)

Ø esterno mm Ø External mm	Ø interno mm Ø Internal mm	Spessore mm Thickness mm	Ø Fori Fiss. mm Ø Fixing holes mm
190	58	4	9

(R.O. 1339300000)

Ø esterno mm Ø External mm	Ø interno mm Ø Internal mm	Spessore mm Thickness mm	Ø Fori Fiss. mm Ø Fixing holes mm
190	58	4	8



MODELLO MODELS	CC	ANNO YEAR	ANT FRONT	POST. REAR
Ark Air	50	96-08	.	.
Ark Lc	50	96-03	.	.
Ark Lc Serie K	50	04-08	.	.
Elkon	50	99-03	.	.

MODELLO MODELS	CC	ANNO YEAR	ANT FRONT	POST. REAR
Ark Lc	50	96-03	.	.
Ark Lc Serie K	50	04-08	.	.
Elkon	50	99-03	.	.
Quadra Chrono 502	50	95-99	.	.
Tempo	50	96-99	.	.

DERBI

22 516 0140

22 516 2111

NEW

(R.O. 564520)

Ø esterno mm Ø External mm	Ø interno mm Ø Internal mm	Spessore mm Thickness mm	Ø Fori Fiss. mm Ø Fixing holes mm
175	73	4	6,5

(R.O. 56391R)

Ø esterno mm Ø External mm	Ø interno mm Ø Internal mm	Spessore mm Thickness mm	Ø Fori Fiss. mm Ø Fixing holes mm
220	105	4,1	6,6



MODELLO MODELS	CC	ANNO YEAR	ANT FRONT	POST. REAR
Gp Open Eu2	50	06-09	.	.

MODELLO MODELS	CC	ANNO YEAR	ANT FRONT	POST. REAR
Gp1 Open Eu2	50	06-09	.	.
Sonar 2T	50	09	.	.
Gp1 Low Seat Eu3	125	07-08	.	.
Sonar 4T	125	09	.	.
Sonar 4T	150	09	.	.
Gp1 Low Seat Eu3	250	07-08	.	.



GILERA

22 516 0020

(R.O. 271594)

Ø esterno mm Ø External mm	Ø interno mm Ø Internal mm	Spessore mm Thickness mm	Ø Fori Fiss. mm Ø Fixing holes mm
155	40,7	3,6	10,7



22 516 0140

(R.O. 564520)

Ø esterno mm Ø External mm	Ø interno mm Ø Internal mm	Spessore mm Thickness mm	Ø Fori Fiss. mm Ø Fixing holes mm
175	73	4	6,5



22 516 0160

(R.O. 563246)

Ø esterno mm Ø External mm	Ø interno mm Ø Internal mm	Spessore mm Thickness mm	Ø Fori Fiss. mm Ø Fixing holes mm
200	96	4	6,5



MODELLO MODELS	CC	ANNO YEAR	ANT FRONT	POST. REAR
Easy Moving	50	95-96	.	.

MODELLO MODELS	CC	ANNO YEAR	ANT FRONT	POST. REAR
Runner	50	97-00	.	.
Runner Poggiali	50	02	.	.
Runner Purejet	50	02-11	.	.
Runner Sp	50	02-12	.	.
Runner Sp Special Edition	50	07	.	.
Stalker	50	97-04	.	.

MODELLO MODELS	CC	ANNO YEAR	ANT FRONT	POST. REAR
Dna	50	00-07	.	.
Dna Gp Experience	50	03-04	.	.
Ice	50	01-05	.	.
Runner Vx-Vxr	125	00-04	.	.
Runner Vx-Vxr	180	00-04	.	.
Runner Vx-Vxr	200	00-04	.	.

22 516 0180

(R.O. 561714)

Ø esterno mm Ø External mm	Ø interno mm Ø Internal mm	Spessore mm Thickness mm	Ø Fori Fiss. mm Ø Fixing holes mm
220	58	4	6,5



22 516 0190

(R.O. 564573)

Ø esterno mm Ø External mm	Ø interno mm Ø Internal mm	Spessore mm Thickness mm	Ø Fori Fiss. mm Ø Fixing holes mm
220	105	4	6,5



22 516 0200

(R.O. 56408R)

Ø esterno mm Ø External mm	Ø interno mm Ø Internal mm	Spessore mm Thickness mm	Ø Fori Fiss. mm Ø Fixing holes mm
190	58	4	8



MODELLO MODELS	CC	ANNO YEAR	ANT FRONT	POST. REAR
Runner	50	97-00	.	.
Runner Poggiali	50	02	.	.
Runner Purejet	50	02-04	.	.
Runner Sp	50	02-04	.	.
Runner Fx-Fxr	125	97-02	.	.
Runner Vx-Vxr	125	00-04	.	.

MODELLO MODELS	CC	ANNO YEAR	ANT FRONT	POST. REAR
Runner Purejet	50	05-11	.	.
Runner Sp	50	05-09	.	.
Runner 4T St	125	08-13	.	.
Runner Vx	125	05-06	.	.
Runner Vx Race	125	06	.	.
Runner Vx Sc	125	06-07	.	.
Runner Vxr	200	05-11	.	.

MODELLO MODELS	CC	ANNO YEAR	ANT FRONT	POST. REAR
Stalker	50	97-11	.	.
Stalker Special Edition	50	07-08	.	.
Storm	50	94-95	.	.
Typhoon Xr	50	00	.	.
Typhoon	50	94-97	.	.
Typhoon X-Xr	125	99-00	.	.
Typhoon	125	95-98	.	.



DISCHI FRENO

BRAKE DISCS

GILERA

22 516 0230



(R.O. 564371)

Ø esterno mm Ø External mm	Ø interno mm Ø Internal mm	Spessore mm Thickness mm	Ø Fori Fiss. mm Ø Fixing holes mm
240	125,5	4	6,5



22 516 2060



(R.O. 649163)

Ø esterno mm Ø External mm	Ø interno mm Ø Internal mm	Spessore mm Thickness mm	Ø Fori Fiss. mm Ø Fixing holes mm
240	125	5	6,5



22 516 2070



(R.O. 56393R)

Ø esterno mm Ø External mm	Ø interno mm Ø Internal mm	Spessore mm Thickness mm	Ø Fori Fiss. mm Ø Fixing holes mm
260	125	5	6,5



MODELLO MODELS	CC	ANNO YEAR	ANT FRONT	POST. REAR
Dna	50	00-07	•	
Dna Gp Experience	50	03-04	•	
Dna	125	01	•	•
Runner Fx-Fxr	125	97-02		•

MODELLO MODELS	CC	ANNO YEAR	ANT FRONT	POST. REAR
Nexus Eu3 le	125	08-10		•
Nexus Eu3	300	08		•
Fuoco	500	07-10		•
Nexus Eu3	500	09		•

MODELLO MODELS	CC	ANNO YEAR	ANT FRONT	POST. REAR
Nexus Eu3 ie	125	07-11	•	
Nexus Eu3	250	06	•	
Nexus Eu3	300	08-11	•	
Nexus Eu3	500	06-11	•	

22 516 2111



NEW

(R.O. 56391R-56484R)

Ø esterno mm Ø External mm	Ø interno mm Ø Internal mm	Spessore mm Thickness mm	Ø Fori Fiss. mm Ø Fixing holes mm
220	105	4,1	6,6



22 516 2121



NEW

(R.O. 601749-649226-56394R)

Ø esterno mm Ø External mm	Ø interno mm Ø Internal mm	Spessore mm Thickness mm	Ø Fori Fiss. mm Ø Fixing holes mm
240	105	4,1	6,6



MODELLO MODELS	CC	ANNO YEAR	ANT FRONT	POST. REAR
Runner Purejet	50	08	•	
Runner Purejet St	50	07	•	
Runner Sp	50	05-07	•	
Runner Sp Special Edition	50	07	•	
Runner Sp St & Simoncelli	50	08-09	•	
Runner Purejet	50	10	•	
Runner Sp	50	10	•	
Runner Vx	125	05-06		•
Runner Vx 4T Eu3	125	06-07		•
Runner Vxr	200	05-06		•
Runner Vxr Eu3	200	07		•

MODELLO MODELS	CC	ANNO YEAR	ANT FRONT	POST. REAR
Runner Vx	125	05-06	•	
Runner Vx 4T Eu3	125	06-07	•	
Runner Vx 4T St Eu3	125	08-10	•	
Runner Vxr	200	05-06	•	
Runner Vxr Eu3	200	07	•	
Runner Vxr 4T St Eu3	200	08-10	•	
Fuoco Eu3	500	07-11	•	



HONDA

22 516 0070

(R.O. 45351-GBY-910ZA)

Ø esterno mm Ø External mm	Ø interno mm Ø Internal mm	Spessore mm Thickness mm	Ø Fori Fiss. mm Ø Fixing holes mm
220	88	4,1	10,3



MODELLO MODELS	CC	ANNO YEAR	ANT FRONT	POST. REAR
Sh	50	96-01	•	
Sh Scoopy	50	96-01	•	
Sh	100	96-00	•	
Sh Scoopy	100	96-00	•	

22 516 0210

(R.O. 45121-GAV-700ZB)

Ø esterno mm Ø External mm	Ø interno mm Ø Internal mm	Spessore mm Thickness mm	Ø Fori Fiss. mm Ø Fixing holes mm
190	58	4	10,7



MODELLO MODELS	CC	ANNO YEAR	ANT FRONT	POST. REAR
Sj Bali	50	93-99	•	
Sky	50	97	•	
Sj Bali	100	96-99	•	

22 516 2200

(R.O. 45351-KGF-900)

Ø esterno mm Ø External mm	Ø interno mm Ø Internal mm	Spessore mm Thickness mm	Ø Fori Fiss. mm Ø Fixing holes mm
220	105	4	10,5



MODELLO MODELS	CC	ANNO YEAR	ANT FRONT	POST. REAR
Chiocciola	125	00-08	•	
Dylan	125	01-06	•	
Sh 125	125	00-08	•	
Sh 125 (Tamburo - Rear Drum)	125	09	•	
Ps I	125	06	•	
Chiocciola	150	00-08	•	
Dylan	150	01-06	•	
Sh 150	150	01-08	•	
Sh 150 (Tamburo - Rear Drum)	150	09	•	
Ps I	150	06	•	

22 516 0350

(R.O. 45351-KRJ-901 • 45351-KTF-891)

Ø esterno mm Ø External mm	Ø interno mm Ø Internal mm	Spessore mm Thickness mm	Ø Fori Fiss. mm Ø Fixing holes mm
240	105	4	10,5



MODELLO MODELS	CC	ANNO YEAR	ANT FRONT	POST. REAR
Silver Wing	125	07-12	•	
Pantheon	125	03-07	•	
Sh - I (Rear disc)	125	10-16	•	
Pantheon	150	03-07	•	
Sh - I (Rear disc)	150	10-16	•	
Foresight	250	99-07	•	

22 516 0360

(R.O. 43251-MV4-00)

Ø esterno mm Ø External mm	Ø interno mm Ø Internal mm	Spessore mm Thickness mm	Ø Fori Fiss. mm Ø Fixing holes mm
220	105	5	10,6



MODELLO MODELS	CC	ANNO YEAR	ANT FRONT	POST. REAR
Pantheon	125	03-07	•	
Silver Wing	125	08>	•	
Pantheon	150	03-07	•	
Silver Wing	150	07>	•	
Foresight	250	99-07	•	
Forza Nss	250	00-04	•	
Jazz	250	01-04	•	
Cbr Rr	600	07-14	•	
Nx Dominator	650	88-92	•	
Cbr Rr	1000	06-15	•	

22 516 2090

(R.O. 45351-KTW-901)

Ø esterno mm Ø External mm	Ø interno mm Ø Internal mm	Spessore mm Thickness mm	Ø Fori Fiss. mm Ø Fixing holes mm
256	144	4,5	10,5



MODELLO MODELS	CC	ANNO YEAR	ANT FRONT	POST. REAR
Forza	125	15	•	
Forza	250	08-13	•	
Sh 300	300	06-14	•	
Forza	300	14-15	•	
Silver Wing	400	06-08	•	
Silver Wing	600	01-06	•	



DISCHI FRENO

BRAKE DISCS

HONDA

22 516 2100

(R.O. 43251-KTW-901)

Ø esterno mm Ø External mm	Ø interno mm Ø Internal mm	Spessore mm Thickness mm	Ø Fori Fiss. mm Ø Fixing holes mm
256	144	5	10,5

22 516 2260

(R.O. 43251-KTF-891)

Ø esterno mm Ø External mm	Ø interno mm Ø Internal mm	Spessore mm Thickness mm	Ø Fori Fiss. mm Ø Fixing holes mm
240	105	5	10,5

22 516 2550

NEW

(R.O. 43251-MGS-D31)

Ø esterno mm Ø External mm	Ø interno mm Ø Internal mm	Spessore mm Thickness mm	Ø Fori Fiss. mm Ø Fixing holes mm
240	120	5	10



MODELLO MODELS	CC	ANNO YEAR	ANT FRONT	POST. REAR
Sh 300	300	07-15		•

MODELLO MODELS	CC	ANNO YEAR	ANT FRONT	POST. REAR
SH I	125-150	10-16		•

MODELLO MODELS	CC	ANNO YEAR	ANT FRONT	POST. REAR
Ctx Abs	700	14		•
Ctx Dual Clutch	700	14-16		•
Ctx N Abs	700	14		•
Ctx N Dual Clutch	700	14		•
Integra 35 Kw	700	12		•
Integra	700	12-13		•
Integra Matt Black	700	13		•
Nc Abs	700	12-13		•
Nc Abs 35 Kw	700	12-13		•
Nc Abs Dct 35 Kw	700	12-13		•
Nc Abs Dct	700	12-14		•
Nc Abs 35 Kw	700	12		•
Nc Dct	700	14		•
Nc Integra Sport	750	14-15		•
Nc Integra	750	14-15		•
Nc S Abs	750	14-15		•
Nc S Abs White	750	15		•
Nc S Dct	750	14-15		•
Nc Abs Dct Special	750	14		•
Nc Abs Dct	750	14-15		•

22 516 2540

NEW

(R.O. 45251-MGS-D81)

Ø esterno mm Ø External mm	Ø interno mm Ø Internal mm	Spessore mm Thickness mm	Ø Fori Fiss. mm Ø Fixing holes mm
320	210	5	10

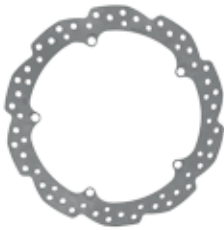

MODELLO MODELS	CC	ANNO YEAR	ANT FRONT	POST. REAR
Ctx Abs	700	14		•
Ctx Dual Clutch	700	14-16		•
Ctx N Abs	700	14		•
Ctx N	700	14		•
Integra	700	12-13		•
Integra 35 Kw	700	12		•
Integra Matt Black	700	13		•
Nc Abs 35 Kw	700	12-13		•
Nc Abs	700	12-13		•
Nc 35 Kw	700	12-13		•
Nc	700	13		•
Nc Abs Dct 35 Kw	700	12-13		•
Nc Abs Dct	700	12-14		•
Nc Abs 35 Kw	700	12-13		•
Nc X	700	12-13		•
Nc Dct	700	14		•
Nc Integra	750	14-15		•
Nc Integra Sport	750	14-15		•
Nc S Abs	750	14-15		•
Nc S Abs White	750	15		•
Nc S Dct	750	14-15		•
Nc S	750	14		•
Nc Abs	750	14-15		•
Nc Abs Dct	750	14-15		•
Nc Abs Dct Special	750	14		•
Nc X	750	14		•

ITALJET

22 516 0020

Ø esterno mm Ø External mm	Ø interno mm Ø Internal mm	Spessore mm Thickness mm	Ø Fori Fiss. mm Ø Fixing holes mm
155	40,7	3,6	10,7



MODELLO MODELS	CC	ANNO YEAR	ANT FRONT	POST. REAR
Bazooka	50	-		•
Pista	50	-		•



KYMCO

22 516 2210



(R.O. 00145010)

Ø esterno mm Ø External mm	Ø interno mm Ø Internal mm	Spessore mm Thickness mm	Ø Fori Fiss. mm Ø Fixing holes mm
260	-	4,2	10,5



22 516 2220



(R.O. 00143057)

Ø esterno mm Ø External mm	Ø interno mm Ø Internal mm	Spessore mm Thickness mm	Ø Fori Fiss. mm Ø Fixing holes mm
240	-	4	10,5



22 516 2230



(R.O. 00143068)

Ø esterno mm Ø External mm	Ø interno mm Ø Internal mm	Spessore mm Thickness mm	Ø Fori Fiss. mm Ø Fixing holes mm
240	-	5	10,5



MODELLO MODELS	CC	ANNO YEAR	ANT FRONT	POST. REAR
Agility 2T R16	50	10-12	•	
Agility 4T R16	50	08-12	•	
People S 4T - S	50	05-08	•	
Agility Plus 2T	50	14	•	
Agility Plus 4T	50	14	•	
Agility R16	125	08-12	•	
Agility Plus	125	14-16	•	
People S Dd Eu 3	125	07-08	•	
People S	125	05	•	
Agility R16	150	08-09	•	
Agility R16	200	10-12	•	
Agility Plus	200	14-16	•	
People S I	200	07	•	
People S	200	05	•	
People S I	250	07	Ant./Sx	
People S	250	06	Ant./Sx	
People S I	300	08	Ant./Sx	

MODELLO MODELS	CC	ANNO YEAR	ANT FRONT	POST. REAR
Agility Plus	125	14-16		•
Agility R16	125	08-12	•	
Agility R16	150	08-09	•	
Agility R16	200	10-12	•	
Agility Plus	200	14-16	•	

MODELLO MODELS	CC	ANNO YEAR	ANT FRONT	POST. REAR
Downtown	125	09		•
Downtown I	200	10		•
Downtown I	300	09-11		•

22 516 2240



(R.O. 00143088)

Ø esterno mm Ø External mm	Ø interno mm Ø Internal mm	Spessore mm Thickness mm	Ø Fori Fiss. mm Ø Fixing holes mm
240	88	5	10,5



22 516 2250



(R.O. 00145128)

Ø esterno mm Ø External mm	Ø interno mm Ø Internal mm	Spessore mm Thickness mm	Ø Fori Fiss. mm Ø Fixing holes mm
200	58,2	4	10,5



22 516 2290



(R.O. 00145090)

Ø esterno mm Ø External mm	Ø interno mm Ø Internal mm	Spessore mm Thickness mm	Ø Fori Fiss. mm Ø Fixing holes mm
260	58	4	10,5



MODELLO MODELS	CC	ANNO YEAR	ANT FRONT	POST. REAR
Downtown Abs I	300	11		•
Downtown Abs	300	10		•

MODELLO MODELS	CC	ANNO YEAR	ANT FRONT	POST. REAR
Agility 4T Carry	50	11	•	
Agility Rs Naked 2T	50	10	•	
Agility Rs	50	09	•	
Agility Rs	125	09	•	

MODELLO MODELS	CC	ANNO YEAR	ANT FRONT	POST. REAR
Downtown i	125	09-16		•
K-Xct i	125	12-14		•
Downtown i	200	10		•
Downtown i	300	09-11		•
K-Xct i	300	12		•
Downtown i	350	15-16		•



DISCHI FRENO

BRAKE DISCS

KYMCO

22 516 2300

(R.O. 00145121)

Ø esterno mm Ø External mm	Ø interno mm Ø Internal mm	Spessore mm Thickness mm	Ø Fori Fiss. mm Ø Fixing holes mm
260	58	4	10,3

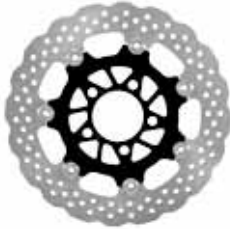
22 516 2310

(R.O. 00143120)

Ø esterno mm Ø External mm	Ø interno mm Ø Internal mm	Spessore mm Thickness mm	Ø Fori Fiss. mm Ø Fixing holes mm
260	125	4,80	10,5

22 516 2320

(R.O. 00156320)

Ø esterno mm Ø External mm	Ø interno mm Ø Internal mm	Spessore mm Thickness mm	Ø Fori Fiss. mm Ø Fixing holes mm
260	-	4,2	10,5



MODELLO MODELS	CC	ANNO YEAR	ANT FRONT	POST. REAR
Downtown Abs i	300	11	•	
Downtown Abs	300	10	•	
K-Xct i Abs	300	14	•	

MODELLO MODELS	CC	ANNO YEAR	ANT FRONT	POST. REAR
People Gti	125	10-14	•	•
People Gti	200	10-14	•	•
People Gti Abs	300	12-14	•	•
People Gti	300	10-14	•	•

MODELLO MODELS	CC	ANNO YEAR	ANT FRONT	POST. REAR
People S Dd Eu3	125	07-08		•
People S I	200	07		•
People Lc	250	03-04	•	•
People S I	250	07	Ant. Dx	•
People S	250	06	Ant. Dx	•
People S I	300	08	Ant. Dx	•

22 516 2360

(R.O. 00145000)

Ø esterno mm Ø External mm	Ø interno mm Ø Internal mm	Spessore mm Thickness mm	Ø Fori Fiss. mm Ø Fixing holes mm
240	128	4	10,5

22 516 2410

(R.O. 00145246)

Ø esterno mm Ø External mm	Ø interno mm Ø Internal mm	Spessore mm Thickness mm	Ø Fori Fiss. mm Ø Fixing holes mm
225	88	4	10,5

22 516 2481
**NEW**

(R.O. 00143197)

Ø esterno mm Ø External mm	Ø interno mm Ø Internal mm	Spessore mm Thickness mm	Ø Fori Fiss. mm Ø Fixing holes mm
240	125	5	10



MODELLO MODELS	CC	ANNO YEAR	ANT FRONT	POST. REAR
Super 8 2T - 4T	50	09-13	•	
Super 8	50	07	•	
Super 8	125	08-09	•	

MODELLO MODELS	CC	ANNO YEAR	ANT FRONT	POST. REAR
People One I	125	13-16	•	

MODELLO MODELS	CC	ANNO YEAR	ANT FRONT	POST. REAR
X Citing I Abs E4	400	16		•
X Citing I Abs	400	14-15		•
X Citing I	400	13-15		•



MALAGUTI

22 516 0010

22 516 0120

22 516 0240

(R.O.11943000)

Ø esterno mm Ø External mm	Ø interno mm Ø Internal mm	Spessore mm Thickness mm	Ø Fori Fiss. mm Ø Fixing holes mm
190	58	4	9

(R.O.11939800)

Ø esterno mm Ø External mm	Ø interno mm Ø Internal mm	Spessore mm Thickness mm	Ø Fori Fiss. mm Ø Fixing holes mm
155	39	4,1	6,5

(R.O.11946500)

Ø esterno mm Ø External mm	Ø interno mm Ø Internal mm	Spessore mm Thickness mm	Ø Fori Fiss. mm Ø Fixing holes mm
200	58	4	9,4



MODELLO MODELS	CC	ANNO YEAR	ANT FRONT	POST. REAR
Crosser Cr1	50	95-98	•	
F12 Lc Rst Eu2	50	08		•
F12 Phantom	50	94-98	•	
F12 Phantom Lc	50	94-98	•	
F12 Phantom Lc Eu1	50	99-00		•
F12 Phantom Lc Rst Eu1	50	01-02		•
F12 Phantom Lc Rst Eu2	50	02		•
F12 Phantom Lc Rst Eu2-2.3	50	03-04		•
F12 Phantom Lc Twin Disks	50	98	•	•
F15 Fire Fox	50	96-98	•	
F15 Fire Fox Eu2	50	02-03		•
F15 Fire Fox Rst Eu2-2.3	50	03-04		•
F15 Fire Fox Twin Disks & Special	50	98-99	•	•
F15 Fire Fox T. Disks Digit Kat	50	98-00		•
F15 Lc Rst Eu2	50	04-05		•
F15 Lc-Tds Rst Eu1	50	01		•
F12 Phantom	100	99-00		•

MODELLO MODELS	CC	ANNO YEAR	ANT FRONT	POST. REAR
F10 Ac	50	08	•	
F10 Ac Eco	50	09-10		•
F10 Jet Line	50	92-98	•	
F10 Kat	50	99-00	•	
F10 Rst Eu1	50	01-02		•
F10 Rst Eu2	50	06		•
F10 Rst Eu2	50	02-03		•
F10 Rst Eu2-2.3	50	03-04		•
Yesterday - Yesterday Eu	50	97-00		•

MODELLO MODELS	CC	ANNO YEAR	ANT FRONT	POST. REAR
Ciak Elettrico	0	00-01	•	
F12 Aria Rst Eu2	50	06		•
F12 Lc Rst Eu2	50	08		•
F12 Phantom Eu1	50	99-00		•
F12 Phantom Lc Eu1	50	99-00		•
F12 Phantom Lc Rst Eu1	50	01-02		•
F12 Phantom Lc Rst Eu2	50	02		•
F12 Phantom Lc Rst Eu2-2.3	50	03-04		•
F12 Phantom Rst Eu1	50	01-02		•
F12 Phantom Rst Eu2	50	02		•
F12 Phantom Rst Eu2-2.3	50	03-04		•
F15 Fire Fox Air Cooled	50	05-06		•
F15 Fire Fox Eu2	50	02-03		•
F15 Fire Fox Rst Eu2-2.3	50	03-04		•
F15 Fire Fox T. Disks Digit Kat	50	98-00		•
F15 Lc Rst Eu2	50	04-05		•
F15 Lc-Tds Rst Eu1	50	01		•
F12 Phantom	100	99-00		•

MBK

22 516 0020

22 516 0130

22 516 0200

(R.O.2NA258310000)

Ø esterno mm Ø External mm	Ø interno mm Ø Internal mm	Spessore mm Thickness mm	Ø Fori Fiss. mm Ø Fixing holes mm
155	40,7	3,6	10,7

(R.O.4VUF582T0000)

Ø esterno mm Ø External mm	Ø interno mm Ø Internal mm	Spessore mm Thickness mm	Ø Fori Fiss. mm Ø Fixing holes mm
180	48	3,5	10

(R.O.5ADF58310000)

Ø esterno mm Ø External mm	Ø interno mm Ø Internal mm	Spessore mm Thickness mm	Ø Fori Fiss. mm Ø Fixing holes mm
190	58	4	8



MODELLO MODELS	CC	ANNO YEAR	ANT FRONT	POST. REAR
Cw R Booster Road (Ita)	50	94-95	•	
Ye Evolis	50	92-95	•	
Ym Fizz [I]	50	94-95	•	
Ya R Forte (Che-Ita)	50	94-96	•	
Cr Z Target	50	91-95	•	

MODELLO MODELS	CC	ANNO YEAR	ANT FRONT	POST. REAR
Cw Booster	50	04	•	
Cw Booster	50	01-02		•
Cw Booster Naked	50	03		•
Cw Rs Booster Ng [I]	50	95-98		•
Cw Rsp Booster Rocket [I]	50	97-98		•
Cw Booster Spirit	50	99-00		•
Cw Booster Spirit Eu2	50	02-03		•
Cw Rxs Booster Track	50	96-98		•

MODELLO MODELS	CC	ANNO YEAR	ANT FRONT	POST. REAR
Yn R Ovetto Eu1	50	02-04		•
Yn R Ovetto Eu2	50	02-03		•
Yn Ovetto	100	97-02		•



DISCHI FRENO

BRAKE DISCS

MBK

22 516 0210



(R.O. 5JHF58310000)

Ø esterno mm Ø External mm	Ø interno mm Ø Internal mm	Spessore mm Thickness mm	Ø Fori Fiss. mm Ø Fixing holes mm
190	58	4	10,7



22 516 2050



(R.O. 1B9F582W0100)

Ø esterno mm Ø External mm	Ø interno mm Ø Internal mm	Spessore mm Thickness mm	Ø Fori Fiss. mm Ø Fixing holes mm
240	92	5	8,5



22 516 2330



(R.O. 4HC2582T0000)

Ø esterno mm Ø External mm	Ø interno mm Ø Internal mm	Spessore mm Thickness mm	Ø Fori Fiss. mm Ø Fixing holes mm
245	115	4	8,5



MODELLO MODELS	CC	ANNO YEAR	ANT FRONT	POST. REAR
Cw Rs Booster Ng	50	99-03	•	
Yq Nitro	50	97-04	•	•
Ew Stunt	50	00-02	•	
Yq Nitro	100	00-02	•	

MODELLO MODELS	CC	ANNO YEAR	ANT FRONT	POST. REAR
Kilibre	300	03-06		•

MODELLO MODELS	CC	ANNO YEAR	ANT FRONT	POST. REAR
Yp Skyliner	250	00-03	•	
Yp Skyliner Abs	250	03	•	

PEUGEOT

22 516 0300



(R.O. 5GM2582W0000)

Ø esterno mm Ø External mm	Ø interno mm Ø Internal mm	Spessore mm Thickness mm	Ø Fori Fiss. mm Ø Fixing holes mm
230	116	5	8,6



22 516 2370



(R.O. 5EUF58310000)

Ø esterno mm Ø External mm	Ø interno mm Ø Internal mm	Spessore mm Thickness mm	Ø Fori Fiss. mm Ø Fixing holes mm
220	88	4	8,4



22 516 0010



(R.O. 746302)

Ø esterno mm Ø External mm	Ø interno mm Ø Internal mm	Spessore mm Thickness mm	Ø Fori Fiss. mm Ø Fixing holes mm
190	58	4	9



MODELLO MODELS	CC	ANNO YEAR	ANT FRONT	POST. REAR
Yp Skyliner Abs	250	03		•
Yp Skyliner	250	00-03		•

MODELLO MODELS	CC	ANNO YEAR	ANT FRONT	POST. REAR
Yh Flipper Catalitico	50	99-00	•	
Yh Flipper Eu2	50	03-04	•	
Yh Flipper	50	98	•	
Yh Flipper	50	01-02	•	

MODELLO MODELS	CC	ANNO YEAR	ANT FRONT	POST. REAR
Buxy	50	94-97	•	
Elyseo	50	99	•	
Speedake	50	95-97	•	
Squab	50	95-97	•	
Sv Geo	50	91-95	•	
Vivacity	50	99	•	
Vivacity Catalitico	50	99-02	•	
Vivacity Vsx-Xr	50	02-04	•	
Looxor	100	01	•	
Sv L	100	98	•	
Trekker	100	98	•	
Vivacity	100	99-01	•	
Sv Geo	125	91-95	•	



PEUGEOT

22 516 0350



(R.O. 755162)

Ø esterno mm Ø External mm	Ø interno mm Ø Internal mm	Spessore mm Thickness mm	Ø Fori Fiss. mm Ø Fixing holes mm
240	105	4	10,5



22 516 2181



NEW

(R.O. 746302)

Ø esterno mm Ø External mm	Ø interno mm Ø Internal mm	Spessore mm Thickness mm	Ø Fori Fiss. mm Ø Fixing holes mm
190	58	3,5	12



22 516 2191



NEW

(R.O. 766424)

Ø esterno mm Ø External mm	Ø interno mm Ø Internal mm	Spessore mm Thickness mm	Ø Fori Fiss. mm Ø Fixing holes mm
226	70	3,5	8,3



MODELLO MODELS	CC	ANNO YEAR	ANT FRONT	POST. REAR
Sv	250	01-02	.	.

MODELLO MODELS	CC	ANNO YEAR	ANT FRONT	POST. REAR
City Star	50	-	.	.
Ludix 12 Rs	50	-	.	.
Ludix 14	50	-	.	.
Tkr	50	-	.	.
Tkr2	50	-	.	.
Vivacity	50	-	.	.
Vivacity 2	50	-	.	.
Looxor	100	-	.	.
Tkr E	100	-	.	.

MODELLO MODELS	CC	ANNO YEAR	ANT FRONT	POST. REAR
Jet	50	-	.	.

22 516 2451



NEW

(R.O. 771184)

Ø esterno mm Ø External mm	Ø interno mm Ø Internal mm	Spessore mm Thickness mm	Ø Fori Fiss. mm Ø Fixing holes mm
260	120	5	8,25



22 516 2461



NEW

(R.O. 771049)

Ø esterno mm Ø External mm	Ø interno mm Ø Internal mm	Spessore mm Thickness mm	Ø Fori Fiss. mm Ø Fixing holes mm
226	115	5	6,2



22 516 2441



NEW

(R.O. 770503)

Ø esterno mm Ø External mm	Ø interno mm Ø Internal mm	Spessore mm Thickness mm	Ø Fori Fiss. mm Ø Fixing holes mm
240	125	6	6



MODELLO MODELS	CC	ANNO YEAR	ANT FRONT	POST. REAR
Satelis	125	-	.	.
Geopolis ie	125	06-12	.	.
Geopolis	250	06-09	.	.
Geopolis	300	10-14	.	.
Geopolis	400	08-12	.	.
Satelis	400	-	.	.
Geopolis	500	08-12	.	.
Satelis	500	-	.	.

MODELLO MODELS	CC	ANNO YEAR	ANT FRONT	POST. REAR
Geopolis	125	-	.	.

MODELLO MODELS	CC	ANNO YEAR	ANT FRONT	POST. REAR
Geopolis S-Sc	250	-	.	.
Satelis S-Sc-Es	250	-	.	.
Geopolis	400	-	.	.
Metropolis	400	-	.	.
Satelis	400	-	.	.
Geopolis	500	-	.	.
Satelis	500	-	.	.



DISCHI FRENO

BRAKE DISCS

PGO

22 516 0020

(R.O. 2NA258310000)

Ø esterno mm Ø External mm	Ø interno mm Ø Internal mm	Spessore mm Thickness mm	Ø Fori Fiss. mm Ø Fixing holes mm
155	40,7	3,6	10,7



MODELLO MODELS	CC	ANNO YEAR	ANT FRONT	POST. REAR
Big Max	50	-	•	

PIAGGIO

22 516 0020

(R.O. 271594)

Ø esterno mm Ø External mm	Ø interno mm Ø Internal mm	Spessore mm Thickness mm	Ø Fori Fiss. mm Ø Fixing holes mm
155	40,7	3,6	10,7



MODELLO MODELS	CC	ANNO YEAR	ANT FRONT	POST. REAR
Zip	50	95-96	•	
Zip Fast Raider	50	93-94	•	
Zip Fast Raider Rst	50	96-97	•	

22 516 0140

(R.O. 564520)

Ø esterno mm Ø External mm	Ø interno mm Ø Internal mm	Spessore mm Thickness mm	Ø Fori Fiss. mm Ø Fixing holes mm
175	73	4	6,5



MODELLO MODELS	CC	ANNO YEAR	ANT FRONT	POST. REAR
Nrg Extreme	50	99-00	•	
Nrg Mc3	50	01-04	•	
Nrg Power Dd	50	05-15	•	
Nrg Power Dd Serie Speciale	50	07-12	•	
Nrg Power Purejet	50	04-11	•	
Nrg Purejet	50	02-04	•	
Nrg Rst Mc2	50	96-98	•	
Zip	50	00-04	•	
Zip 4T	50	00-13	•	
Zip 4T	100	06-10	•	
Zip	125	00-02	•	

22 516 0160

(R.O. 563246)

Ø esterno mm Ø External mm	Ø interno mm Ø Internal mm	Spessore mm Thickness mm	Ø Fori Fiss. mm Ø Fixing holes mm
200	96	4	6,5



MODELLO MODELS	CC	ANNO YEAR	ANT FRONT	POST. REAR
Fly 2T	50	05-11	•	
Fly 4T Motore Chn	50	06-07	•	
Sfera Rst	50	95-97	•	
Free Delivery	50	00-01	•	
Free FL	50	95-02	•	
Vespa Et2 Iniezione	50	97-00	•	
Vespa Et2	50	97-05	•	
Vespa Et4	50	00-05	•	
Vespa Lx 2T-4T	50	05-13		•
Vespa Lxv 2T	50	06-08		•
Vespa Primavera 2T	50	13-15	•	
Vespa Primavera 4T 4V	50	13-16	•	
Vespa S 2T	50	08-12	•	
Vespa S 4T 4V	50	08-12	•	
Vespa Sprint 2T	50	14-16	•	
Vespa Sprint 4T 4V	50	14-16	•	
Zip Sp	50	96-13	•	
Fly 4T	100	06-08	•	
Fly	100	05-11	•	
Hexagon Gtx	125	00	•	
Hexagon Lx4	125	98-99	•	
Hexagon Lx-Lxt	125	98-99	•	•

22 516 0180

(R.O. 561714)

Ø esterno mm Ø External mm	Ø interno mm Ø Internal mm	Spessore mm Thickness mm	Ø Fori Fiss. mm Ø Fixing holes mm
220	58	4	6,5



MODELLO MODELS	CC	ANNO YEAR	ANT FRONT	POST. REAR
Nrg Extreme	50	99-00	•	
Nrg Mc3	50	01-04	•	
Nrg Purejet	50	02-04	•	
Skipper 4T	125	00-02	•	
Skipper Lx	125	98-99	•	



PIAGGIO

22 516 0190

(R.O. 564573)			
Ø esterno mm Ø External mm	Ø interno mm Ø Internal mm	Spessore mm Thickness mm	Ø Fori Fiss. mm Ø Fixing holes mm
220	105	4	6,5



22 516 0200

(R.O. 56408R)			
Ø esterno mm Ø External mm	Ø interno mm Ø Internal mm	Spessore mm Thickness mm	Ø Fori Fiss. mm Ø Fixing holes mm
190	58	4	8



22 516 0230

(R.O. 564371)			
Ø esterno mm Ø External mm	Ø interno mm Ø Internal mm	Spessore mm Thickness mm	Ø Fori Fiss. mm Ø Fixing holes mm
240	125,5	4	6,5



MODELLO MODELS	CC	ANNO YEAR	ANT FRONT	POST. REAR
Liberty	50	97-05	.	.
Liberty 2T	50	06-08	.	.
Liberty 2T-4T Rst	50	04	.	.
Liberty 2T-4T Sport	50	06-08	.	.
Liberty 4T	50	00-08	.	.
Liberty Ptt Eu2	50	04-15	.	.
Nrg Power Dd	50	05-12	.	.
Nrg Power Dt	50	06-15	.	.
Nrg Power Purejet	50	04-11	.	.
Nrg Purejet	50	10	.	.
Free	100	02-03	.	.
Fly 4T 3V	125	12-13	.	.
Liberty	125	98-02	.	.
Liberty 4T	125	06-15	.	.
Liberty Rst	125	04-05	.	.
Liberty Rst Ptt	125	05-11	.	.
Liberty Sport	125	06	.	.
Super Hexagon Gtx 12	125	01-02	.	.
Vespa Granturismo	125	03-07	.	.
Vespa Gts	125	07-16	.	.
Vespa Gtv	125	06-08	.	.
Liberty 4T Eu3	150	08	.	.
Liberty 4T Sport Eu3	150	08	.	.
Liberty - Liberty Sport	200	06	.	.
Liberty Rst	200	04	.	.
Liberty	200	06	.	.
Liberty 4T Sport Eu3	200	06-07	.	.
Vespa Granturismo	200	06-07	.	.
Vespa Gt 60	250	06-07	.	.
Vespa Gts	250	05-16	.	.
Vespa Gtv	250	06-09	.	.
Vespa Gts	300	10-16	.	.
Vespa Gtv	300	10-13	.	.

22 516 0250

(R.O. 1C001582)			
Ø esterno mm Ø External mm	Ø interno mm Ø Internal mm	Spessore mm Thickness mm	Ø Fori Fiss. mm Ø Fixing holes mm
260	60	4	8,5



MODELLO MODELS	CC	ANNO YEAR	ANT FRONT	POST. REAR
Medley 4T Ie Abs	125	16	.	.
Medley 4T Ie Abs	150	16-17	.	.

MODELLO MODELS	CC	ANNO YEAR	ANT FRONT	POST. REAR
Nrg Rst Mc2	50	96-98	.	.
Nrg	50	94-96	.	.
Ntt	50	95-96	.	.
Typhoon	50	01-11	.	.

22 516 2060

(R.O. 649163)			
Ø esterno mm Ø External mm	Ø interno mm Ø Internal mm	Spessore mm Thickness mm	Ø Fori Fiss. mm Ø Fixing holes mm
240	125	5	6,5



MODELLO MODELS	CC	ANNO YEAR	ANT FRONT	POST. REAR
Mp3 ie	125	08-12	.	.
Mp3 Yourban	125	11-13	.	.
Super Hexagon Gtx	125	01-02	.	.
X Evo	125	07	.	.
X7 Eu3	125	08	.	.
X7 Evo Ie Eu3	125	09	.	.
X8	125	05-06	.	.
X8 Premium Eu2	125	06	.	.
X8 Premium Eu3	125	06-07	.	.
Super Hexagon Gtx	180	01-04	.	.
X8	200	04-05	.	.
Mp3	250	06-08	.	.
Mp3 Lt	250	09	.	.
Mp3 Mic	250	08-10	.	.
X Evo	250	07	.	.
X7 Eu3	250	08	.	.
X8 Eu3	250	05-08	.	.
X7 Evo Ie Eu3	300	09	.	.
Mp3	300	10-14	.	.
Mp3 Yourban ERL	300	11-15	.	.
Beverly Eu3	400	06-08	.	.
Beverly Tourer Eu3	400	08-10	.	.
Mp3 - Mp3 Lt	400	07-08	.	.
Mp3 Mic	400	08-10	.	.
X Evo	400	07-10	.	.
X8 Eu3	400	06-08	.	.
Beverly	500	02-06	.	.
Beverly Cruiser	500	07-12	.	.
Beverly Eu3	500	06-08	.	.
X9 Evolution	500	06-07	.	.

MODELLO MODELS	CC	ANNO YEAR	ANT FRONT	POST. REAR
X9	125	01-02	.	.
X9 Evolution	125	03-07	.	.
X9 Amalfi	180	00-03	.	.
X9	200	02-03	.	.
X9 Evolution	200	03	.	.
X9	250	00-01	.	.
X9 Evolution	250	04-06	.	.
X Evo	400	07-11	.	.
X8 Eu3	400	06-08	.	.

22 516 2070

(R.O. 56393R)			
Ø esterno mm Ø External mm	Ø interno mm Ø Internal mm	Spessore mm Thickness mm	Ø Fori Fiss. mm Ø Fixing holes mm
260	125	5	6,5



MODELLO MODELS	CC	ANNO YEAR	ANT FRONT	POST. REAR
X Evo	125	07	.	.
X7 Eu3	125	08	.	.
X7 Evo Ie Eu3	125	09	.	.
X8	125	05-06	.	.
X8 Premium Eu2	125	06	.	.
X8 Premium Eu3	125	06-07	.	.
X8 Street Eu2	125	06-07	.	.
X8	200	05-07	.	.
X Evo	250	07	.	.
X7 Eu3	250	08	.	.
X8 Eu3	250	05-08	.	.
Carnaby Cruiser	300	09	.	.
X7 Evo Ie Eu3	300	09	.	.
Beverly Eu3	400	06-07	.	.
Beverly Tourer Eu3	400	08-10	.	.
Beverly Cruiser	500	07-11	.	.
X9 Evolution	500	06-07	.	.



DISCHI FRENO

BRAKE DISCS

PIAGGIO

22 516 2080

(R.O. 56397R)

Ø esterno mm Ø External mm	Ø interno mm Ø Internal mm	Spessore mm Thickness mm	Ø Fori Fiss. mm Ø Fixing holes mm
260	125	4	6,5

22 516 2111
**NEW**

(R.O. 56391R-56484R)

Ø esterno mm Ø External mm	Ø interno mm Ø Internal mm	Spessore mm Thickness mm	Ø Fori Fiss. mm Ø Fixing holes mm
220	105	4,1	6,6

22 516 2121
**NEW**

(R.O. 601749-649226-56394R)

Ø esterno mm Ø External mm	Ø interno mm Ø Internal mm	Spessore mm Thickness mm	Ø Fori Fiss. mm Ø Fixing holes mm
240	105	4,1	6,6



MODELLO MODELS	CC	ANNO YEAR	ANT FRONT	POST. REAR
Beverly Tourer Eu3	125	08-10	•	
Carnaby	125	07-10	•	
Carnaby	200	07-08	•	
Beverly	250	06-07	•	
Beverly Cruiser	250	07-10	•	
Beverly le Eu3	250	06-08	•	
Beverly Tourer Eu3	250	08-10	•	
Carnaby	250	08	•	
Beverly 300 le Tourer	300	09	•	
Carnaby Cruiser	300	09		•

MODELLO MODELS	CC	ANNO YEAR	ANT FRONT	POST. REAR
Liberty 2T/4T/Sport	50	07-08	•	
Liberty 4T	50	05-08	•	
Liberty 4T Delivery Tnt	50	09	•	
Nrg Power Dd S. Speciale	50	07-10	•	
Nrg Power Dt-Serie Speciale	50	07-08	•	
Nrg Power Purejet	50	10-11	•	
Nrg Purejet	50	10	•	
Liberty Sport	125	06	•	
Liberty 4T Eu3	125	07-08	•	
Liberty 4T Eu3 Delivery	125	08	•	
Liberty 4T Sport Eu3	125	06-08	•	
Vespa Granturismo Eu3	125	06-07	•	
Vespa Gts Eu3	125	07-10	•	•
Vespa Gts 4T le Super	125	09-11	•	•
Vespa Gtv 4T Navy Eu3	125	08	•	•
Liberty 4T Eu3	150	08	•	•
Liberty 4T Sport Eu3	150	08	•	
Liberty 4T Eu3	200	07-08	•	
Liberty 4T Sport Eu3	200	06-07	•	
Vespa Gt 60 Eu3	250	06-07	•	
Vespa Gts, Gts Abs	250	05-10	•	•
Vespa Gtv	250	06-09	•	•
Vespa Gtv 4T Navy Eu3	250	08	•	•
Vespa Gts Super	300	08-10	•	•
Vespa Gts Super Sport	300	10	•	•
Vespa Gtv Via Monten.	300	10	•	•
Vespa Gtv 4T 4V le	300	10-11	•	•

MODELLO MODELS	CC	ANNO YEAR	ANT FRONT	POST. REAR
Mp3 Ibrido	125	09-10	•	
Mp3 le	125	08-09	•	
Mp3 Yourban Erl	125	11-13	•	
Mp3 Lt	250	09	•	
Mp3 Mic	250	08-09	•	
Mp3 Yourban Erl	300	11-15	•	
Mp3 300 le Lt	300	10-11	•	
Mp3 300 le Mic	300	10-11	•	
Mp3 4T 4V le Lt Ibrido	300	10-13	•	
Mp3 Mic	400	08-11	•	
Mp3 le Lt- Mp3 le Lt Sport	400	08-10	•	
Mp3 Lt Sport	500	11-13	•	
Mp3 RL Sport	500	11-12	•	

22 516 2171
**NEW**

(R.O. 56478R)

Ø esterno mm Ø External mm	Ø interno mm Ø Internal mm	Spessore mm Thickness mm	Ø Fori Fiss. mm Ø Fixing holes mm
240	125	4,4	6,6



MODELLO MODELS	CC	ANNO YEAR	ANT FRONT	POST. REAR
Liberty Moc 2T & Elle	50	09-13	•	
Liberty Moc 4T & Elle	50	09-16	•	
Liberty Moc 4T & Elle	125	09-10	•	
Liberty 4T 2V le Eu 3	125	09-13	•	
Liberty 4T 2V le Ptt-Ita	125	12-13	•	
Liberty 4T 3V le Eu 3	125	12-14	•	
Liberty Moc 4T Eu 3	150	09-13	•	

22 516 2401
**NEW**

(R.O. 666761)

Ø esterno mm Ø External mm	Ø interno mm Ø Internal mm	Spessore mm Thickness mm	Ø Fori Fiss. mm Ø Fixing holes mm
220	95	4	6



MODELLO MODELS	CC	ANNO YEAR	ANT FRONT	POST. REAR
Fly 4T 2V	50	12-15	•	
Fly 4T 4V	50	12-13	•	
Typhoon 2T	50	10-12	•	
Fly 4T 3V le Eu3	125	12-15	•	
Typhoon 4T 2V	125	10-11	•	



SUZUKI

22 516 0370

(R.O. 59221-14G00-000)

Ø esterno mm Ø External mm	Ø interno mm Ø Internal mm	Spessore mm Thickness mm	Ø Fori Fiss. mm Ø Fixing holes mm
260	121	4,5	10,3



MODELLO MODELS	CC	ANNO YEAR	ANT FRONT	POST. REAR
An Burgman	250	03-06	•	
An Burgman	400	03-15	•	
An Burgman	650	04-11	•	

SYM

22 516 2491 **NEW**

(R.O. 45121H3A000)

Ø esterno mm Ø External mm	Ø interno mm Ø Internal mm	Spessore mm Thickness mm	Ø Fori Fiss. mm Ø Fixing holes mm
273	172	4	10



MODELLO MODELS	CC	ANNO YEAR	ANT FRONT	POST. REAR
Mx Eu2	125	03-04	•	•
Mx	125	02	•	•
Joyride Eu2	125	03-06	•	•
Joyride Eu3	125	07	•	•
Joyride Evo	125	09-14	•	•
Joyride	125	01-02	•	•
Shark	125	99-02	•	•
Vs Eu3	125	07-08	•	•
Vs	125	06	•	•
Mx Eu2	150	02-04	•	•
Joyride	150	01-02	•	•
Shark	150	00-01	•	•
Vs Eu3	150	07-08	•	•
Vs	150	06	•	•
Joyride Eu2	200	03-06	•	•
Joyride Evo I	200	09-14	•	•
Joyride I Eu3	200	07-09	•	•
Joyride I Evo	200	10	•	•
Joyride	200	03	•	•

22 516 2501 **NEW**

(R.O. 43121H9A000)

Ø esterno mm Ø External mm	Ø interno mm Ø Internal mm	Spessore mm Thickness mm	Ø Fori Fiss. mm Ø Fixing holes mm
200	75	4	10,5

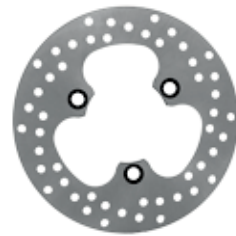

MODELLO MODELS	CC	ANNO YEAR	ANT FRONT	POST. REAR
Gts - Gts Joymax	125	06-07	•	
Joyride Eu2	125	03-06	•	
Joyride Eu3	125	07	•	
Joyride Evo	125	09-14	•	
Joyride	150	01-02	•	
Joyride Eu2	200	03-06	•	
Joyride Evo I	200	09-14	•	
Joyride I Eu3	200	07-09	•	
Joyride I Evo	200	10	•	
Joyride	200	03	•	

22 516 2511 **NEW**

(R.O. 45121HHA000)

Ø esterno mm Ø External mm	Ø interno mm Ø Internal mm	Spessore mm Thickness mm	Ø Fori Fiss. mm Ø Fixing holes mm
220	95	4	10,5



MODELLO MODELS	CC	ANNO YEAR	ANT FRONT	POST. REAR
Hd Eu2	125	03-04	•	
Hd Eu3	125	07-08	•	
Hd Evo Eu3	125	07-11	•	
Hd Evo Tamburo Eu3	125	08-09	•	
Hd Evo	125	05-06	•	
Hd Eu2	200	03-04	•	
Hd Eu3 I	200	07	•	
Hd Evo Eu2	200	05-06	•	
Hd Evo Eu3 I	200	07	•	
Hd Evo I Eu3	200	10-12	•	
Hd Evo I Tamburo Eu3	200	08-09	•	

22 516 2521 **NEW**

(R.O. 43121HMA000 - 43121HMA000KB)

Ø esterno mm Ø External mm	Ø interno mm Ø Internal mm	Spessore mm Thickness mm	Ø Fori Fiss. mm Ø Fixing holes mm
220	110	5	10



MODELLO MODELS	CC	ANNO YEAR	ANT FRONT	POST. REAR
Hd Evo Eu3	125	07-11	•	
Hd Evo	125	05-06	•	
Hd Evo Eu2	200	05-06	•	
Hd Evo Eu3 I	200	07	•	
Hd Evo I Eu3	200	10-12	•	
Gts	250	06-08	•	
Joymax Eu3 I	250	07-08	•	
Joymax	250	05-07	•	
Joymax Evo I	300	10	•	
Joymax Evo	300	09	•	

22 516 2531 **NEW**

(R.O. 45121HMA000 - 45121HMB00SH)

Ø esterno mm Ø External mm	Ø interno mm Ø Internal mm	Spessore mm Thickness mm	Ø Fori Fiss. mm Ø Fixing holes mm
240	90	4	10



MODELLO MODELS	CC	ANNO YEAR	ANT FRONT	POST. REAR
Gts	125	06-07	•	
Gts Joymax	125	06-07	•	
Gts	250	06-08	•	
Joymax Eu3 I	250	07-08	•	
Joymax	250	05-07	•	
Joymax Evo I	300	10	•	



DISCHI FRENO

BRAKE DISCS

YAMAHA

22 516 0020

(R.O. 2NA258310000)

Ø esterno mm Ø External mm	Ø interno mm Ø Internal mm	Spessore mm Thickness mm	Ø Fori Fiss. mm Ø Fixing holes mm
155	40,7	3,6	10,7

22 516 0130

(R.O. 4VUF582T0000)

Ø esterno mm Ø External mm	Ø interno mm Ø Internal mm	Spessore mm Thickness mm	Ø Fori Fiss. mm Ø Fixing holes mm
180	48	3,5	10

22 516 0200

(R.O. 5ADF58310000)

Ø esterno mm Ø External mm	Ø interno mm Ø Internal mm	Spessore mm Thickness mm	Ø Fori Fiss. mm Ø Fixing holes mm
190	58	4	8



MODELLO MODELS	CC	ANNO YEAR	ANT FRONT	POST. REAR
Ya R Axis	50	95-96	•	
Ym Breeze	50	94-95	•	
Cr Z	50	91-95	•	

MODELLO MODELS	CC	ANNO YEAR	ANT FRONT	POST. REAR
Bw'S	50	04-16	•	
Bw'S Bump	50	97-98	•	
Bw'S Naked	50	03-16	•	
Bw'S Next Generation	50	97-98	•	
Bw'S Original	50	99-03	•	
Bw'S R	50	01	•	
Cw L Bw's	50	03-04	•	

MODELLO MODELS	CC	ANNO YEAR	ANT FRONT	POST. REAR
Yn Neo'S	50	97-06	•	
Yn Neo'S Eu2	50	02-03	•	
Yn Neo'S	100	99-02	•	

22 516 0210

(R.O. 5JHF58310000)

Ø esterno mm Ø External mm	Ø interno mm Ø Internal mm	Spessore mm Thickness mm	Ø Fori Fiss. mm Ø Fixing holes mm
190	58	4	10,7

22 516 0300



(R.O. 5GM2582W0000)

Ø esterno mm Ø External mm	Ø interno mm Ø Internal mm	Spessore mm Thickness mm	Ø Fori Fiss. mm Ø Fixing holes mm
230	116	5	8,6

22 516 0310

(R.O. 5GJ2582T0000)

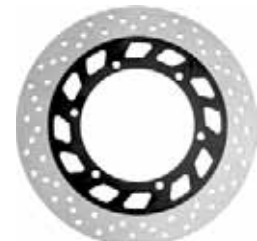
Ø esterno mm Ø External mm	Ø interno mm Ø Internal mm	Spessore mm Thickness mm	Ø Fori Fiss. mm Ø Fixing holes mm
282	132	5	8,6



MODELLO MODELS	CC	ANNO YEAR	ANT FRONT	POST. REAR
Yq Aerox	50	01-02	•	•
Yq Aerox	50	04-08	•	•
Yq Aerox	50	97-98	•	•
Yq L Aerox Eu2	50	03	•	•
Yq Aerox R	50	99	•	•
Bw'S Next Generation	50	99-06	•	
Bw'S Next Generation Cat.	50	99-00	•	
Ew Slider	50	00-02	•	
Yq Aerox	100	00-02	•	

MODELLO MODELS	CC	ANNO YEAR	ANT FRONT	POST. REAR
Yp Majesty	250	00-03		•
Yp Majesty Abs	250	03		•

MODELLO MODELS	CC	ANNO YEAR	ANT FRONT	POST. REAR
Xp T-Max	500	01-03	•	



YAMAHA

22 516 0320

(R.O. 5VU2582W0000)			
Ø esterno mm Ø External mm	Ø interno mm Ø Internal mm	Spessore mm Thickness mm	Ø Fori Fiss. mm Ø Fixing holes mm
267	132	5	8,5

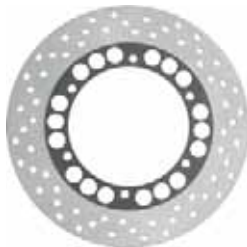

22 516 0390

(R.O. 5CG2582W0000)			
Ø esterno mm Ø External mm	Ø interno mm Ø Internal mm	Spessore mm Thickness mm	Ø Fori Fiss. mm Ø Fixing holes mm
230	84	5	8,5



22 516 2040

(R.O. 1B9F582U0000)			
Ø esterno mm Ø External mm	Ø interno mm Ø Internal mm	Spessore mm Thickness mm	Ø Fori Fiss. mm Ø Fixing holes mm
267	132	5	8,5



MODELLO MODELS	CC	ANNO YEAR	ANT FRONT	POST. REAR
Xp T-Max Abs	500	05-07		•
Xp T-Max Black - Night	500	07		•
Xp T-Max Black Max	500	06		•
Xp T-Max	500	01-07		•
Xj S Diversion	900	95-01		•
Fzs fazer	1000	01-05		•
Bt Bulldog	1100	05-97		•
Xjr	1200	95-97		•
Xjr - Xjr P	1300	99-01		•
Xjr	1300	02-13		•
Xjr C	1300	15		•

MODELLO MODELS	CC	ANNO YEAR	ANT FRONT	POST. REAR
Yp Majesty Dx	250	98-99		•

MODELLO MODELS	CC	ANNO YEAR	ANT FRONT	POST. REAR
Yp R X-Max Abs	125	11		•
Yp R X-Max	125	06-14		•
Yp Ra X-Max Abs	125	13-14		•
Yp Ra Black X-Max	250	09		•
Yp R X-Max Sport	250	11-12		•
Yp R X-Max	250	05-14		•
Yp Ra X-Max Abs	250	11-14		•
Yp X-Max	400	13-16		•
Yp Majesty	400	12-13		•

22 516 2050

(R.O. 1B9F582W0100)			
Ø esterno mm Ø External mm	Ø interno mm Ø Internal mm	Spessore mm Thickness mm	Ø Fori Fiss. mm Ø Fixing holes mm
240	92	5	8,5



22 516 2270

(R.O. 4B52582V0000)			
Ø esterno mm Ø External mm	Ø interno mm Ø Internal mm	Spessore mm Thickness mm	Ø Fori Fiss. mm Ø Fixing holes mm
267	132,25	5,10	8,5



22 516 2280

(R.O. 5C2F58310000)			
Ø esterno mm Ø External mm	Ø interno mm Ø Internal mm	Spessore mm Thickness mm	Ø Fori Fiss. mm Ø Fixing holes mm
190	-	3,55	8,5



MODELLO MODELS	CC	ANNO YEAR	ANT FRONT	POST. REAR
Yp R X-Max	125	06-13		•
Vp X-City	125	08-11		•
Yp R X-Max	250	05-13		•
Vp X-City	250	07-14		•
Xc Versity	300	03-06		•

MODELLO MODELS	CC	ANNO YEAR	ANT FRONT	POST. REAR
Xp T-Max Abs Sv	500	11		•
Xp T-Max Abs	500	08-11		•
Xp T-Max Sv	500	11		•
Xp T-Max White Max	500	10		•
Xp T-Max	500	08		•
Xp T-Max	500	09-11		•

MODELLO MODELS	CC	ANNO YEAR	ANT FRONT	POST. REAR
Cs Jog R	50	06-15		•
Yn F Neo's 4	50	09-15		•
Yn Neo's	50	07-16		•



DISCHI FRENO

BRAKE DISCS

YAMAHA

22 516 2330



(R.O. 4HC2582T0000)

Ø esterno mm Ø External mm	Ø interno mm Ø Internal mm	Spessore mm Thickness mm	Ø Fori Fiss. mm Ø Fixing holes mm
245	115	4	8,5



22 516 2340



(R.O. 5VU2581T0100-1SDF81T0000)

Ø esterno mm Ø External mm	Ø interno mm Ø Internal mm	Spessore mm Thickness mm	Ø Fori Fiss. mm Ø Fixing holes mm
267	132	4	8,5



22 516 2350



(R.O. 4B52581T0000)

Ø esterno mm Ø External mm	Ø interno mm Ø Internal mm	Spessore mm Thickness mm	Ø Fori Fiss. mm Ø Fixing holes mm
267	132	4	8,5



MODELLO MODELS	CC	ANNO YEAR	ANT FRONT	POST. REAR
Yp Majesty	250	00-03	•	
Yp Majesty	250	96-98	•	
Yp Majesty Abs	250	03	•	
Yp Majesty Dx	250	98-99	•	

MODELLO MODELS	CC	ANNO YEAR	ANT FRONT	POST. REAR
Yp X-Max	400	13-16	•	
Yp Ra X-Max Abs	400	14-16	•	
Xp T-Max Abs	500	06-07	•	
Xp T-Max Black Max-Night Max	500	06-07	•	
Xp T-Max	500	04-07	•	

MODELLO MODELS	CC	ANNO YEAR	ANT FRONT	POST. REAR
Xp T-Max	500	08-11	•	
Xp T-Max Abs	500	08-11	•	
Xp T-Max Sv	500	08-11	•	
Xp T-Max Abs	500	08-11	•	

22 516 2370



(R.O. 5EUF58310000)

Ø esterno mm Ø External mm	Ø interno mm Ø Internal mm	Spessore mm Thickness mm	Ø Fori Fiss. mm Ø Fixing holes mm
220	88	4	8,4



22 516 2380



(R.O. 1B72582W0000)

Ø esterno mm Ø External mm	Ø interno mm Ø Internal mm	Spessore mm Thickness mm	Ø Fori Fiss. mm Ø Fixing holes mm
245	115	5	8,4



22 516 2390



(R.O. 5B2F582T0000)

Ø esterno mm Ø External mm	Ø interno mm Ø Internal mm	Spessore mm Thickness mm	Ø Fori Fiss. mm Ø Fixing holes mm
270	128	5	8,4



MODELLO MODELS	CC	ANNO YEAR	ANT FRONT	POST. REAR
Yh Why Eu1	50	99-00	•	
Yh Why Eu1	50	03-05	•	
Yh Why	50	98-06	•	

MODELLO MODELS	CC	ANNO YEAR	ANT FRONT	POST. REAR
Yp R X-Max Abs	125	11-16	•	
Yp Ra X-Max Abs	250	11-16	•	

MODELLO MODELS	CC	ANNO YEAR	ANT FRONT	POST. REAR
Yp X-City	125	08-11	•	
Yp X-City	250	07-15	•	

22 516 2430



(R.O. 1SDF582W0000)

Ø esterno mm Ø External mm	Ø interno mm Ø Internal mm	Spessore mm Thickness mm	Ø Fori Fiss. mm Ø Fixing holes mm
266	132	5	8,2



MODELLO MODELS	CC	ANNO YEAR	ANT FRONT	POST. REAR
Yp R X-Max Momodesign	400	14	•	
Yp R X-Max	400	13-15	•	
Yp Ra X-Max Abs	400	14-16	•	
Yp Ra X-Max Momodesign Abs	400	14-15	•	



22 514 0060 

Ape 50 1 Serie
(R.O. 117446)



22 514 0070 

Ape 50 • P 50 • Tm P50 • 50 Fl 2 • A 89-95 •
50fl 3 Europa 96-98 • Rst Mix 50 A 99
(R.O. 1745292)



22 514 0150 

Ape 50 • Fl • Fl 2 A 89-95 • Fl 3 Europa A.96-
99 • Rst Mix A 99-05
(R.O. 2457652)



22 514 0080 

Ape 175 Mp
(R.O. 076031)



22 514 0090 

Ape 175 Mp
(R.O. 076032)



22 514 0100 

Mp 600 • P 601 A 78-96
(R.O. 137891)



22 514 0110 

Mp 600 • P 601 A 78-96
(R.O. 137894)



22 514 0120 

Ape Car P 3 • Ape Tm P 703 • P 703 A 84-99
Tm P 703 • P 703-V.Diesel Car • Max Diesel 86-
96 • Ape Tm P 703 A 84 • Car Diesel A.86-96
(R.O. 245194)



22 514 0130 

Ape Car P 3
(R.O. 245193)



22 514 0140 

Ape Poker • Benzina-Diesel A.93
(R.O. 227549)



22 514 0160 

Cosa 1-2
(R.O. 248846)



22 514 0170 

Cosa 1-2
(R.O. 228828)



SERIE GUARNIZIONI CILINDRETTI FRENI - BRAKE CYLINDER GASKET SETS

22 514 0010 

Anteriore - Front Ape Mp-Car (4 Pezzi - 4 Pcs)

22 514 0030 

Posteriore - Rear Ape 50 (8 Pezzi - 8 Pcs)

22 514 0050 

Posteriore - Rear Ape Tm P602 (8 Pezzi - 8 Pcs)

22 514 0020 

Anteriore - Front Ape Tmp 602(4 Pezzi - 4 Pcs)

22 514 0040 

Posteriore-Rear Ape Mp-Car-Mpr-Mpv-175 Mp
(8 Pezzi - 8 Pcs)





POMPE FRENO BRAKE MASTER CYLINDER

22 513 0040



Ape 50 • P 50 • Tm P50 • 50 FL 2 A 89-95
50 FL 3 Europa 96-98 • Rst Mix 50 A 99
(R.O. 249519)



22 513 0060



Mp 600 • P 601 A 78-96
(R.O. 140251)



22 513 0080



Ape Car P 3
(R.O. 1800365)



22 513 0090



Ape Tm P 703 • P 703 A 84-99 • Tm P 703
P 703-V.Diesel Car • Max Diesel 86-96
(R.O. 249520)



22 513 0100



Ape Tm P 703 A 84 • Car Diesel A 86-96
(R.O. 179379)



22 513 0110



Ape Poker • Benzina-Diesel A 93
(R.O. 265195)



22 513 0120



Cosa 1-2
(R.O. 229254)



22 513 0130



Ape Tm P602 82-83
(R.O. 197433)



22 513 0140



220: Ape Car P2 seconda serie-P3 1 serie
(R.O. 229217)



SERIE GUARNIZIONI POMPE FRENO - MASTER BRAKE CYLINDER GASKET SETS

22 513 0010



Ape 50

22 513 0030



Ape Tm P602 P703

22 513 0020



Ape Pp • Car • Ad1 • 175 Mp



TABELLA APPLICAZIONI POMPE FRENO E CILINDRETTI - BRAKE MASTER CYLINDER AND CYLINDER APPLICATION CHART

MODELLO - MODEL	SERIE GUARNIZIONI CILINDRETTI FRENI BRAKE CYLINDER GASKET SETS	POMPA FRENO MASTER CYLINDER	CILINDRETTO POSTERIORE DX REAR RH CYLINDER	CILINDRETTO POSTERIORE SX REAR LH CYLINDER	CILINDRETTO ANTERIORE FRONT CYLINDER
Ape 50 • P 50 • Tm P50 • 50 FL 2 A 89-95 • 50 FL 3 Europa 96-98 • Rst Mix 50 A 99	22 513 0010	22 513 0040 (R.O. 249519)	22 514 0070 (R.O. 1745292)	22 514 0070 (R.O. 1745292)	-
Ape 50 1 Serie	-	-	22 514 0060 (R.O. 117446)	22 514 0060 (R.O. 117446)	-
Ape 50 • FL • FL 2 A 89-95 • FL 3 Europa A 96-99 • Rst Mix A 99-05	-	22 513 0040 (R.O. 249519)	22 514 0150 (R.O. 2457652)	22 514 0150 (R.O. 2457652)	-
Ape 175 Mp	-	-	22 514 0080 (R.O. '076031)	22 514 0090 (R.O. '076032)	-
Mp 600 • P 601 A 78-96	-	22 513 0060 (R.O. 140251)	22 514 0110 (R.O. 137894)	22 514 0110 (R.O. 137894)	22 514 0100 (R.O. 137891)
Ape Car P 3	-	22 513 0080 (R.O. 1800365)	22 514 0130 (R.O. 245193)	22 514 0130 (R.O. 245193)	22 514 0120 (R.O. 245194)
Ape Tm P 703 • P 703 A 84-99 • Tm P 703 • P 703 V.Diesel Car • Max Diesel 86-96	-	22 513 0090 (R.O. 249520)	22 514 0130 (R.O. 245193)	22 514 0130 (R.O. 245193)	22 514 0120 (R.O. 245194)
Ape Tm P 703 A.84 • Car Diesel A.86-96	-	22 513 0100 (R.O. 179379)	22 514 0130 (R.O. 245193)	22 514 0130 (R.O. 245193)	22 514 0120 (R.O. 245194)
Ape Poker • Benzina-Diesel A.93	-	22 513 0110 (R.O. 265195)	22 514 0140 (R.O. 227549)	22 514 0140 (R.O. 227549)	-
Ape Tm P 602	22 513 0030	22 513 0130 (R.O. 197433)	22 514 0130 (R.O. 245193)	-	-
Cosa 1 - Cosa 2	-	22 513 0120 (R.O. 229254)	-	22 514 0170 (R.O. 228828)	22 514 0160 (R.O. 248846)



22 508 5020 

TAMBURO FRENO POSTERIORE
REAR BRAKE DRUM
PIAGGIO: Vespa 50 Special • Elestart
Vespa 125 Primavera • Et3
(R.O. 100412)



22 508 5040 

TAMBURO FRENO POST. MOZZO 27 mm
REAR BRAKE DRUM HUB 27 mm
PIAGGIO 125-150-200: Vespa Px
Sprint GL • Rally
(R.O. 078480)



22 508 5050 

TAMBURO FRENO POST. MOZZO 30 mm
REAR BRAKE DRUM HUB 30 mm
PIAGGIO: Vespa Pxe Arcobaleno
125-150-200 81-97
(R.O. 194433)



22 508 5053 

NEW

TAMBURO FRENO POSTERIORE
REAR BRAKE DRUM
PIAGGIO: Vespa Px 125-150 • 200 Arcobaleno
VSX1T-VNX2T-VLX1T-V81XT
(R.O. 194433)



22 508 5070 

TAMBURO FRENO POSTERIORE
REAR BRAKE DRUM
PIAGGIO: Vespa 150 Super - P 150 S
Vbc1, Vnc1
(R.O. 110375-157743)



22 508 5080 

TAMBURO FRENO POSTERIORE MOZZO
31,5 mm
REAR BRAKE DRUM HUB 31,5 mm
PIAGGIO: Vespa T5 e Px 11
(R.O. 2427724)



22 508 8023 

NEW

TAMBURO POSTERIORE - REAR DRUM
PIAGGIO 125: Vespa Vna - Vnb
(R.O. 023831)



12 195 0060 

MOLLA GANASCIA
BRAKE SHOES SPRING
PIAGGIO: Vespa 50 • Pk
(R.O. 025990)



12 195 0070 

MOLLA GANASCIA
BRAKE SHOES SPRING
PIAGGIO: Vespa 50- Px 125-150-200
(R.O. 078522)



12 195 0080 

ANELLO GANASCIA - BRAKE SHOES CLIP
PIAGGIO: Vespa
(R.O. 000061)



12 195 0100 

MOLLA PEDALE FRENO-BRAKE PEDAL SPRING
Vespa 50-90-125 Primavera • Et3
(R.O. 70994)



22 508 4000 

TAPPO IN ACCIAIO PER TAMBURIO POST. Ø 39
INOX REAR DRUM PLUG Ø 39
PIAGGIO: Vespa
(R.O. 182546)



22 508 4010 

TAPPO IN ACCIAIO PER TAMBURIO ANT. Ø 32
INOX REAR DRUM PLUG Ø 32
PIAGGIO: Vespa • Ape 50
(R.O. 181757)



22 508 4023 

TAPPO TAMBURIO - DRUM PLUG
Vespa PX 125-150-200
VNX-VLX-VSX
Plastica/Plastic Type
(R.O. 198015)





CERCHI RUOTA VINTAGE

VINTAGE WHEEL RIMS

22 500 0010



COLORE GRIGIO ORIGINALE

ORIGINAL GRAY COLOR

Vespa 50- Special-Elestart-FL2 • N-Hp-Pk-125
Primavera-Et3 • Gtr-GL Sprint-Sprint Veloce
Ts 125-Px-Pe-Rally 200 Px 11
(3.50-10")
(R.O. 137757-84631)



22 500 0011



COLORE NERO - BLACK COLOR

Vespa 50- Special-Elestart-FL2 • N-Hp-Pk-125
Primavera-Et3 • Gtr-GL Sprint-Sprint Veloce
Ts 125-Px-Pe-Rally 200 Px 11
(3.50-10")



22 500 0012



COLORE GRIGIO ORIGINALE

ORIGINAL GRAY COLOR

Vespa 50- Special-Elestart-FL2 • N-Hp-Pk-125
Primavera-Et3 • Gtr-GL Sprint-Sprint Veloce
Ts 125-Px-Pe-Rally 200 Px 11
(3.50-10")
Prodotto in India - *Made in India*
(R.O. 137757-84631)



22 500 0013



COLORE ROSSO - RED COLOR

Vespa 50- Special-Elestart-FL2 • N-Hp-Pk-125
Primavera-Et3 • Gtr-GL Sprint-Sprint Veloce
Ts 125-Px-Pe-Rally 200 Px 11
(3.50-10")



22 500 0015



COLORE BIANCO - WHITE COLOR

Vespa 50- Special-Elestart-FL2 • N-Hp-Pk-125
Primavera-Et3 • Gtr-GL Sprint-Sprint Veloce
Ts 125-Px-Pe-Rally 200 Px 11
(3.50-10")



22 500 0016



CROMATO - CHROMED

Vespa 50- Special-Elestart-FL2 • N-Hp-Pk-125
Primavera-Et3 • Gtr-GL Sprint-Sprint Veloce
Ts 125-Px-Pe-Rally 200 Px 11
(3.50-10")
(R.O. 610120M)



22 500 0017



CROMATO LUSO - TOP QUALITY CHROMED

Vespa 50- Special-Elestart-FL2 • N-Hp-Pk-125
Primavera-Et3 • Gtr-GL Sprint-Sprint Veloce
Ts 125-Px-Pe-Rally 200 Px 11
(3.50-10")
(R.O. 610120M)



22 500 0020



**COLORE ROSSO TUBELESS
TUBELESS RED COLOR**

Vespa 50- Special-Elestart-FL2 • N-Hp-Pk-125
Primavera-Et3 • Gtr-GL Sprint-Sprint Veloce
Ts 125-Px-Pe-Rally 200 Px 11
(3.50-10")
(R.O. 137757-84631)



22 500 0021



**COLORE BIANCO TUBELESS
TUBELESS WHITE COLOR**

Vespa 50- Special-Elestart-FL2 • N-Hp-Pk-125
Primavera-Et3 • Gtr-GL Sprint-Sprint Veloce
Ts 125-Px-Pe-Rally 200 Px 11
(3.50-10")
(R.O. 137757-84631)





22 500 0022



NEW

COLORE BLU TUBELESS
TUBELESS BLU COLOR

Vespa 50- Special-Elestart-FL2 • N-Hp-Pk-125
Primavera-Et3 • Gtr-GL Sprint-Sprint Veloce
Ts 125-Px-Pe-Rally 200 Px 11
(3.50-10")
(R.O. 137757-84631)



22 500 0023



NEW

COLORE NERO TUBELESS
TUBELESS BLACK COLOR

Vespa 50- Special-Elestart-FL2 • N-Hp-Pk-125
Primavera-Et3 • Gtr-GL Sprint-Sprint Veloce
Ts 125-Px-Pe-Rally 200 Px 11
(3.50-10")
(R.O. 137757-84631)



22 500 0024



NEW

COLORE GRIGIO TUBELESS
TUBELESS GRAY COLOR

Vespa 50- Special-Elestart-FL2 • N-Hp-Pk-125
Primavera-Et3 • Gtr-GL Sprint-Sprint Veloce
Ts 125-Px-Pe-Rally 200 Px 11
(3.50-10")
(R.O. 137757-84631)



22 500 0014



NEW

COLORE GRIGIO - GRAY COLOR

VESPA 125-150
(R.O. 1103765)



22 500 0018



COLORE GRIGIO - GRAY COLOR

Vespa 150 VL1/2/3 • Vb1 • Vba1 • Vbb1/2 •
Vespa 125 V30 • V33 • Vm1/2 • Vu1T • Vn1/2 •
Vna 1/2 • Vnb1/2/3/4/5/6
(3.50-8")
(R.O. 014984)



22 500 0019



NEW

COLORE GRIGIO - GRAY COLOR

INNOCENTI Lambretta LI 3°SERIE





FORCELLE
FRONT FORKS

12 157 0050 

PIAGGIO 50: Vespa Pk FL2
(R.O. 266303)



12 157 0080 

PIAGGIO 50: Vespa Rush • N • Pk
125: Pk XL
(R.O. 265752)



12 157 0090 

PIAGGIO 125-150: Vespa Px • **200:** Vespa PE
Fino al 1981 con perno Ø 16 mm
Until 1981 with Ø 16 mm axle
(R.O. 183435)



12 157 0100 

PIAGGIO 125-150: Vespa Px • **200:** Vespa Pe
Dal 1982 con perno Ø 20 mm
From 1982 with Ø 20 mm axle
(R.O. 178050)



12 157 0110 

PIAGGIO 50: Vespa Pk Automatica
Plurimatic
(R.O. 244830)



12 157 0120 

PIAGGIO 125: Vespa Px Arc. 83> • **150:** Vespa
Px Arc. 83> • **200:** Vespa Px Arc. 83>
Con perno Ø 22 mm - *With Ø 22 mm axle*
(R.O.216744)



12 157 0170 

PIAGGIO 150: Vespa Sprint ruota 10" - *Wheel 10"*
(R.O. 152339)



12 157 0150 

PIAGGIO 50-125: Vespa Primavera Et3
(R.O.183678)



12 157 0160 

PIAGGIO 150: Vespa Super ruota 8" - *Wheel 8"*
(R.O. 152332)



TESTE E STELI FORCELLE FRONT FORK AND STEERING STEM COUPLE



12 157 0190 

MBK 50: Cw Rs Booster Ng 95-03 • Cw Rst Booster Rocket 97-98 • Yq Nitro 97-00
YAMAHA 50: Bw's Next Generation 99-06 • Cw Rs Spy 95-98 • Yq Aerox 97-02 • Yq Aerox R 99-00
(R.O. 5BRF33400200)

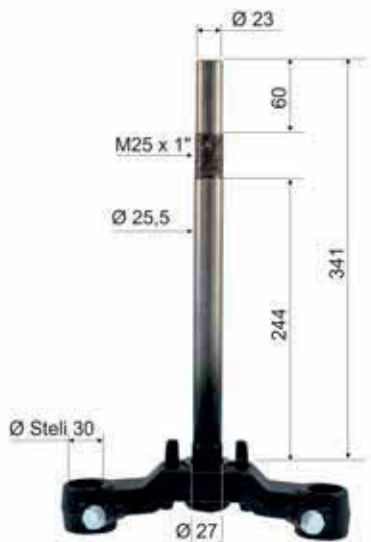

12 157 0460 

HONDA 125-150: Sh 01-12
(R.O. 53219-KPR-900 • 53219-KPR-901)



12 157 0490 

HONDA 125-150: Sh ie 13-16
(R.O. 53219-K01-900)



12 157 0480 

HONDA 300: Sh 07-15
(R.O. 53219-KTW-900)



12 158 0060 

COPPIA STELI FORCELLA - INNER TUBES
MBK 50-100: Ovetto 97-00
YAMAHA 50-100: Neo's 97-00
Per Forcella Paioli - *For Paioli Fork*
(R.O. 5ADF3110)



12 158 0070 

COPPIA STELI FORCELLA - INNER TUBES
MBK 50: Booster Spirit 99 • Spirit kat 99-00
YAMAHA 50: Bw's Original e kat 99/00
Per Forcella KYB - *For KYB fork*
(R.O. 4VUF3110)

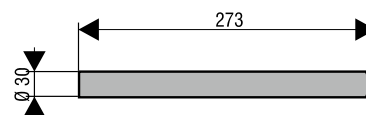

12 157 0810 

BRACCIO SOSPENSIONE Ø22 MM ASSE
AXLE ARM SUSPENSION
PIAGGIO 125-150-200: Vespa Px-Pxe Arcobaleno-VNX-VLX-VSX-VNX2-VLX2-VSX2
(R.O. 178051)



22 518 0180 

ASSE RUOTA ANTERIORE - FRONT AXLE
PIAGGIO 50-90-125: Vespa Primavera -Et3-V5A2T-V5B1T-VMA2-V9A1
(R.O. 100483)



22 518 0193 

KIT PERNO MOZZO - HUB PIN KIT
PIAGGIO: Vespa 125-150
Vba-Vbb-Vna-Vnb-Vnc-Vbc

NEW





KIT PERNO SOSPENSIONE ANTERIORE

FRONT SUSPENSION PIN



22 518 0020



PIAGGIO: Vespa 50 • Pk 50 • Pk 50S • Pk 50 XL
• 125 Primavera • 125 ET3
(R.O. Gabbia - *Cage* 090457 • Perno - *Pin* 070181)

22 518 0030



PIAGGIO: Vespa Px • Pe > 82
2 Gabbie - *Cages* Ø 12 x 18 x 12
2 Guarnizioni - *Gaskets*
1 Perno - *Pin* Ø 12 x 50
(R.O.174099 • 138725 • 174098)

22 518 0040



PIAGGIO: Vespa Pk 50 • Rush • N • HP • FL
Pk 125 • ET4 • Sfera • Quartz • Zip Sp 96
Skipper • Exagon • Px • PE 82 > • Cosa • 1 • 2
2 Gabbie - *Cages* Ø 16 x 22 x 14
2 Guarnizioni - *Gaskets*
1 Perno - *Pin* Ø 16 x 56
(R.O. 137146 • 119219 • 177451)

22 518 0060



PIAGGIO: Vespa 125-150 dal 1963 • Ape 50
2 Gabbie - *Cages* Ø 12 x 20 x 12
2 Rondelle - *Washer* Ø 12 x 23 x 2
1 Perno - *Pin* Ø 12 x 104
(R.O. 016781)

22 518 0170



PIAGGIO: Vespa Sprint 125-150-180-200
(R.O. 091621)

22 518 0070



PIAGGIO 50-250: Ape
2 Gabbie - *Cages* Ø 16 x 22 x 14
2 Guarnizioni - *Gaskets*
1 Perno - *Pin* Ø 16 x 71
Perno per ingrassaggio - *With nipple grease*
(R.O.154676)

22 518 0080



PIAGGIO: Ape P 50 •
2 Gabbie - *Cages* Ø 16 x 22 x 14
2 Guarnizioni - *Gaskets*
1 perno - *Pin* Ø 16 x 75

22 518 0090



PIAGGIO 50: Ape P
2 Gabbie - *Cages* Ø 16 x 22 x 14
2 Guarnizioni - *Gaskets*
1 Perno - *Pin* 16 x 75
Perno per ingrassaggio - *With nipple grease*

22 518 0110



PIAGGIO: Ape Mp
2 Gabbie - *Cages* Ø 18 x 24 x 13
2 Guarnizioni - *Gaskets*
1 Perno - *Pin* 18 x 74
Perno per ingrassaggio - *With nipple grease*

22 518 0130



PIAGGIO: Ape Car • Ape 501 • 601 V
2 Gabbie - *Cages* Ø 18 x 24 x 13
2 Guarnizioni - *Gaskets*
1 Perno - *Pin* 18 x 84

22 518 0140



PIAGGIO: Ape Tm • P 602 Ultimo tipo
2 Gabbie - *Cages* Ø 18 x 24 x 15
2 Guarnizioni - *Gaskets*
1 Perno - *Pin* 18 x 91

22 518 0150



PIAGGIO: Ape Tm - P 602 Ultimo tipo
2 Gabbie - *Cages* Ø 18 x 24 x 15
2 Guarnizioni - *Gaskets*
1 Perno - *Pin* 18 x 91
Perno per ingrassaggio - *With nipple grease*



APRILIA

18 422 0010

SUPERIORE - UPPER

50: Sport City One 2T 08-11
(R.O. 56002R)



18 422 0020

INFERIORE - LOWER

50: Sport City One 2T 08-11
(R.O. 56003R)



18 422 0100

COMPLETA - COMPLETE

50: Sport City One 2T 08-11
(R.O. 56002R+56003R)



18 422 0140

COMPLETA - COMPLETE

50: Area 51 98-00 • Gulliver 95-98 • Gulliver Lc 96-98 • Rally 95-03 • Rally Liquid Cooled 96-99 • Scarabeo 93-05 • Scarabeo Street 05-06 • Scarabeo Street 2T Rst 06-09 • Scarabeo 2T Net 09-10 • Scarabeo 4T 4V Net 10-12 • Sr 93-96 • Sr Www 97-01 • Sr Street 03-12 • Sr Ditech Eu2 02-04 • Sr H2O Ditech E Carb 00-04 • Sr Liquid Cooled 94-96 • Sr Stealth, Racing 97-99
100: Scarabeo 4T 10-12 • Scarabeo 4T Net / Eu3 10
(R.O. AP8203666)



18 422 0300

SUPERIORE - UPPER

50: Sport City One 4T 50 08-10
125: Sport City One 4T Eu3 08-11
(R.O. CM061303)



18 422 0350

COMPLETA - COMPLETE

125: Leonardo 96-02 • Leonardo ST 01-04 • Sport City 04-06 • Scarabeo 03-06 • Scarabeo Eu 3 06-07 • Scarabeo Mot. Rotax 99-04 • Sport City 04-06 • Sport City Eu 3 06-08 • Sport City Cube 08-10 • Sport City Street 12
150: Leonardo 96-02 • Scarabeo 96-02
200: Sport City 04-06 • Scarabeo 96-02
250: Leonardo 99-04 • Leonardo St 01 • Sport City Cube 08-10
300: Sport City Street 12
500: Atlantic 01-04
(R.O. AP8123794-8123685)



CPI

18 422 0450

COMPLETA - COMPLETE

250: Scarabeo Light 06-08
300: Scarabeo Light 09-10
400: Scarabeo Light 06-08
(R.O. 6008725)



18 422 0380

COMPLETA - COMPLETE

50: Aragon 2T



18 422 0480

COMPLETA - COMPLETE

50: Gtr Lc - Hussar - Oliver - Popcorn





SERIE CALOTTE STERZO
STEERING HEAD BEARING SET

DERBI

18 422 0010

SUPERIORE - UPPER

50: Gp1 Open Eu2 06-09
125: Gp1 Eu2 06 • Gp1 Low Seat Eu3 07-08
125-150: Boulevard 02-04 • Boulevard Eu3 04-07
200: Boulevard 05
250: Gp1 06-07 • Gp1 Low Seat Eu3 07-08
(R.O. 56002R)



18 422 0020

INFERIORE - LOWER

50: Gp1 Open Eu2 06-09
125: Gp1 Eu2 06 • Gp1 Low Seat Eu3 07-08
125-150: Boulevard 02-04 • Boulevard Eu3 04-07
200: Boulevard 05
250: Gp1 06-07 • Gp1 Low Seat Eu3 07-08
(R.O. 56003R)



18 422 0100

COMPLETA - COMPLETE

50: Gp1 Open Eu2 06-09
125: Gp1 Eu2 06 • Gp1 Low Seat Eu3 07-08
125-150: Boulevard 02-04 • Boulevard Eu3 04-07
200: Boulevard 05
250: Gp1 06-07 • Gp1 Low Seat Eu3 07-08
(R.O. 56002R+56003R)



GILERA

18 422 0300

SUPERIORE - UPPER

50: Boulevard 2T 09-12 • Boulevard 4T Eu2 09
125: Variant Sport 4T E3 12
125-150: Boulevard 4T Eu3 08-12
(R.O. CM061303)



18 422 0010

SUPERIORE - UPPER

50: Easy Moving 95-96 • Ice 01-05 • Runner 97-00
• Runner Poggiali 02 • Runner Purejet 02-06 •
Runner Sp 02-04 • Stalker 97-04 • Storm 94-95 •
Typhoon 94-97 • Typhoon X 98-99 • Typhoon Xr 00
125: Typhoon 95-98 • Typhoon X-Xr 99-00
125-180:
Runner Fx-Fxr 97-02
125-180-200:
Runner Vx Vxr 00-04
(R.O. 56002R)



18 422 0020

INFERIORE - LOWER

50: Easy Moving 95-96 • Ice 01-05 • Runner 97-00 •
Runner Poggiali 02 • Runner Purejet 02-06 • Runner
Sp 02-04 • Stalker 97-04 • Storm 94-95 • Typhoon 94-
97 • Typhoon X 98-99 • Typhoon Xr 00
125: Typhoon 95-98 • Typhoon X-Xr 99-00
125-180: Runner Fx-Fxr 97-02
125-180-200: Runner Vx Vxr 00-04
(R.O. 56003R)



18 422 0100

COMPLETA - COMPLETE

50: Easy Moving 95-96 • Ice 01-05 • Runner 97-00 •
Runner Poggiali 02 • Runner Purejet 02-06 • Runner
Sp 02-04 • Stalker 97-04 • Storm 94-95 • Typhoon
94-97 • Typhoon X 98-99 • Typhoon Xr 00
125: Typhoon 95-98 • Typhoon X-Xr 99-00
125-180: Runner Fx-Fxr 97-02
125-180-200: Runner Vx Vxr 00-04
(R.O. 56002R+56003R)



18 422 0300

SUPERIORE - UPPER

50: Runner Purejet 07 • Runner Purejet St 08 •
Runner Sp 05-07 • Runner Sp Special Edition 07
• Runner Sp St & Simoncelli 08-09 • Stalker 05-
11 • Stalker Naked 08 • Stalker Special Edition
07-08 • Storm Eu2 07
125: Runner Vx 05-06 • Runner Vx 4T Eu3 06-'07
• Runner Vx 4T St Eu3 08-10 • Runner Vx Race 06
• Runner Vx Sc 06-07
200: Runner Vxr 05-06 • Runner Vxr 4T St Eu3
08-09 • Runner Vxr Eu3 07 • Runner Vxr Race 06
500: Fuoco Eu 3 07-11
(R.O. CM061303)



18 422 0510

COMPLETA - COMPLETE

125: Nexus Eu3 le 08 • Nexus Eu3 07-08
300: Nexus Eu3 08
(R.O. 6009215)





GILERA

18 422 0520 

COMPLETA - COMPLETE

500: Fuoco Eu3 07-13
(R.O. 6019175)



18 422 0540 

COMPLETA - COMPLETE

500: Fuoco 4T-4V Ie Eu3 13
(R.O. 6670825)



HONDA

18 422 0170 

COMPLETA - COMPLETE

50: Sky



18 422 0180 

COMPLETA - COMPLETE

50: Sh 96>



18 422 0260 

COMPLETA - COMPLETE

125-150: @ • Dylan • Sh



18 422 0322 

SUPERIORE - UPPER

400: Silver Wing



NTN

18 422 0332 

INFERIORE - LOWER

400: Silver Wing



NTN

18 422 0342 

NTN

18 422 0340 

COMPLETA - COMPLETE

400: Silver Wing





SERIE CALOTTE STERZO
STEERING HEAD BEARING SET

HONDA

18 422 0360 

COMPLETA - COMPLETE
125-150: Pantheon 2T/4T
250: Foresight



18 422 0370 

COMPLETA - COMPLETE
300: Sh 08-10



ITALJET

18 422 0270 

COMPLETA - COMPLETE
50-125-150: Torpedo



KYMCO

18 422 0200 

COMPLETA - COMPLETE
50: B&W 02 • Dink 98-02 • Dink Classic Eu2 03 • Heroism 95-97 • People 99
125: B&W 00 • B&W Eu2 00 • Dink 97-98 • Dink Lx 98-00 • Grand Dink 01-02 • Heroism 95-97 • Movie 99-00 • Movie XI 01 • People 99-00 • People Eu2 03 • Vivio 00
150: B&W 00 • B&W Eu2 00 • Dink 97-98 • Dink Lx 98-00 • Grand Dink 01-02 • Heroism 95-97 • Movie 99-00 • Movie XI 01 • People 99-00 • People Eu2 03 • Vivio 00
250: B&W 00 • Grand Dink 01-02 • People 0'03 • Yup 03



18 422 0210 

COMPLETA - COMPLETE
50: Cx 93 • Cx Super 94-97 • Dj W 94-00 • Dj X 91-92 • Djy 93 • Fever Zx 99-00 • Fever Zx Eu2 03-04 • Filly 98-00 • Filly Lx 01-02 • K12 95-00 • Kb 95-00 • Sniper 93 • Sniper Dd 94-96 • Super 9 00 • Super 9 Sport Eu2 03-04 • Top Boy 97-00 • Vitality 2T 04 • Vitality 4T 04 • Yup 02 • Yup Eu2 03 (R.O. 155027)



18 422 0322 

SUPERIORE - UPPER
125: Downtown I 09 • Gran Dink 12 • K-Xcti 12 People Gti 10
200: Downtown I 10 • People Gti 10
250: People S i 07 • People S 06 • Venox Eu3 07 • X Citing I 05-07
300: Downtown I/Abs/Abs i 09-11 • Grand Dink 12 • K Xcti 12 • People Gti / Abs 10-12 • People S I 08 • X Citing I/R 08-09
400: X Citing I 13
500: X Citing I/R 05-09
700: My Road I 11 (R.O. 00155125)



NTN

18 422 0332 

INFERIORE - LOWER
125: Downtown I 09 • Gran Dink 12 • K-Xcti 12 People Gti 10
200: Downtown I 10 • People Gti 10
250: People S i 07 • People S 06 • Venox Eu3 07 • X Citing I 05-07
300: Downtown I/Abs/Abs i 09-11 • Grand Dink 12 • K Xcti 12 • People Gti / Abs 10-12 • People S I 08 • X Citing I/R 08-09
400: X Citing I 13
500: X Citing I/R 05-09
700: My Road I 11 (R.O. 00155125)



NTN

18 422 0342 

COMPLETA - COMPLETE
125: Downtown I 09 • Gran Dink 12 • K-Xcti 12 People Gti 10
200: Downtown I 10 • People Gti 10
250: People S i 07 • People S 06 • Venox Eu3 07 • X Citing I 05-07
300: Downtown I/Abs/Abs i 09-11 • Grand Dink 12 • K Xcti 12 • People Gti / Abs 10-12 • People S I 08 • X Citing I/R 08-09
400: X Citing I 13
500: X Citing I/R 05-09
700: My Road I 11 (R.O. 00155125)



NTN

18 422 0460 

COMPLETA - COMPLETE
50-125-150: Agility 08-12





MALAGUTI

18 422 0230 

SUPERIORE - UPPER

50: Ciak 99-00 • Ciak Master 04 • Ciak Master Eu2 06 • Ciak Mono Eu2 03 • Ciak Mono Eu2 2.3 03 • Ciak Td 00-01 • F10 Ac 08 • F10 Ac Eco 09 • F10 Jet Line 92-98 • F10 Kat 99-00 • F10 Rst Eu1 01-02 • F10 Rst Eu2-2.3 03-04 • F10 Rst Eu2 06 • F10 Rst Eu2 02-03 • Yesterday Euro 97-00



18 422 0240 

INFERIORE - LOWER

50: Ciak 99-00 • Ciak Master 04 • Ciak Master Eu2 06 • Ciak Mono Eu2 03 • Ciak Mono Eu2 2.3 03 • Ciak Td 00-01 • F10 Ac 08 • F10 Ac Eco 09 • F10 Jet Line 92-98 • F10 Kat 99-00 • F10 Rst Eu1 01-02 • F10 Rst Eu2-2.3 03-04 • F10 Rst Eu2 06 • F10 Rst Eu2 02-03 • Yesterday Euro 97-00



18 422 0150 

COMPLETA - COMPLETE

50: Ciak 99-00 • Ciak Master 04 • Ciak Master 4T 05-06 • Ciak Master Eu2 06 • Ciak Mono Eu2 03 • Ciak Mono Eu2 2.3 03 • Ciak Td 00-01 • F10 Ac 08 • F10 Ac Eco 09 • F10 Jet Line 92-98 • F10 Kat 99-00 • F10 Rst Eu2-2.3 03-04 • F10 Rst Eu2 06 • F10 Rst Eu2 02-03 • Yesterday Euro 97-00



18 422 0220 

COMPLETA - COMPLETE

50: Crosser Cr1 95-98 • F10 Rst Eu1 01-02 • F12 Aria Rst Eu2 06 • F12 Lc Rst Eu2 06 • F12 Phantom 94-98 • F12 Phantom Eu1 99-00 • F12 Phantom Lc 94-98 • F12 Phantom Lc Eu1 99-00 • F12 Phantom Lc Rst Eu1 01-02 • F12 Phantom Lc Rst Eu2 02 • F12 Phantom Lc Rst Eu2-2.3 03-04 • F12 Phantom Lc Twin Disks 98 • F15 Fire Fox 96-98 • F15 Fire Fox Air Cooled 05-06 • F15 Fire Fox Eu2 02-03 • F15 Fire Fox Rst Eu2-2.3 03-04 • F15 Fire Fox Twin Disks & Special 98-99 • F15 Fire Fox Twin Disks Digit Kat 98-00 • F15 Lc Rst Eu2 04-05 • F15 Lc-Tds Rst Eu1 01 (R.O. 10401700)



18 422 0310 

COMPLETA - COMPLETE

50: Centro 4T 08 • Centro Sl 4T 10 • F12R Phantom Ac 07-10 • F12R Phantom Lc 07-10
100: Ciak 99-00
125: Blog le 09-11 • Centro le 08-09 • Centro Sl le 09-11 • Ciak 00-01 • Ciak Master 04 • Ciak Master Eu3 06 • Ciak Rst Eu2 03 • F18 Warrior 00-02 • Madison 3 06-09 • Phantom Max 03
150: Ciak 00-02 • Ciak Master 04 • F18 Warrior 00-02 • Ciak Restyling Eu2 03
160: Blog le 09-11 • Centro le 09-11 • Centro Sl le 09
200: Ciak Master Eu2 06 • Phantom Max 03
250: Madison 3 06-09 • Phantom Max 04 (R.O. 10403000)



MBK

18 422 0230 

SUPERIORE - UPPER

50: Booster 90-04 • Booster Road (Ita) 94-95 • Evolis 92-95 • Fizz 94-95 • Forte (Che-Ita) 94-96 • 02-03 • New Sorriso 95-96 • Nitro Jaguar 04 • Nitro Eu2 03 • Nitro 02-04 • Ovetto Eu1-Eu2 02-04 • Sorriso 91-95 • Stunt 00-02 • Target 91-95 • Mach G Eu1/2 02-04
100: Booster 99-01 • Nitro 00-02
125: Flame /F/R 95-00 • Doodo 00-01 • Thunder 01-02 • Skyliner 98-03
150: Vertex 97 • Doodo 01-02 • Thunder 01-02 • Skyliner 00-02
180: Skyliner 03
250: Skyliner 00-03
Skyliner Abs 03
300: Kilibre 03



18 422 0240 

INFERIORE - LOWER

50: Booster 90-04 • Booster Road (Ita) 94-95 • Evolis 92-95 • Fizz 94-95 • Forte 94-96 • New Sorriso 95-96 • Ovetto Eu1-Eu2 02-04 • Sorriso 91-95 • Target 91-95 • Mach G Eu1/2 02-04



18 422 0150 

COMPLETA - COMPLETE

50: Booster 90-04 • Booster Road (Ita) 94-95 • Evolis 92-95 • Fizz 94-95 • Forte 94-96 • New Sorriso 95-96 • Mach Eu1/2 02-04 • Ovetto Eu1-Eu2 02-04 • Sorriso 91-95 • Target 91-95





SERIE CALOTTE STERZO
STEERING HEAD BEARING SET

MBK

18 422 0250 

INFERIORE - LOWER

50: Nitro 02-04 • Nitro Eu2 03 • Stunt 00-02
Nitro Jaguar 04

100: Nitro 00-02

125: Doodo 00-01 • Thunder 01-02 • Skyliner
98-03

150: Doodo 00-01 • Skyliner 00-02 • Thunder
01-02

180: Skyliner 03



18 422 0280 

COMPLETA - COMPLETE

50: Nitro 01-04 • Nitro Eu2 03 • Nitro Jaguar 04
• Stunt 00-02

100: Nitro 00-02

125: Doodo 00-01 • Skyli-
ner 98-03 • Thunder 01-02

150: Doodo 01-02 • Skyli-
ner 00-02 • Thunder 01-02
• Vertex 97

180: Skyliner 03



18 422 0160 

COMPLETA - COMPLETE

50: Booster 01-03 • Booster Ng 95-03 • Booster
Ng Eu1 99-00 • Booster

Naked 03 • Booster Rocket
97-98 • Booster Spirit 96-00

• Booster Spirit Eu2 02-03
• Booster Track 96-98 •

Flipper 98-02 • Flipper Eu2
03-04 • Flipper Kat 99-00 •

Ovetto 97-01 • Nitro 97-01
100: Ovetto 00-02



PEUGEOT

18 422 0390 

COMPLETA - COMPLETE

100: Booster 99-01

125: Flame /F/R 95-00



18 422 0430 

COMPLETA - COMPLETE

300: Kilibre 03



18 422 0180 

COMPLETA - COMPLETE

50: Metropolis Lm 91 • Sv Geo 50 91-95

100: Sv L 100 98

125: Sv Geo 91-95
(R.O. 704980)



18 422 0290 

COMPLETA - COMPLETE

50: Elyseo 99 • Elystar 03-05 • Jetforce 03 •
Looxor 01-03 • Ludix 04 • Speedfight 01-03 •

Trekker 98-00 • Vivacity 99-00 • **100:** Elyseo 00-
01 • Looxor 01 • Speedfight 97-00 • X-Fight 00

125: Elystar 02-03 • Jetforce 03-04 • Looxor 02-
03 • **150:** Elystar 02-03 • Jetforce 03-04 • Looxor

02-03



18 422 0550 

COMPLETA - COMPLETE

125: Geo C • Es • Exn • Ex • E • Sc • S • X

Sat C • S • Sc • E • Ex • Esc • E Millesim • K15 • K15 Bx
• K15 C • K15 Scx • K15 Sc • K15 Wx • Sat 2 C • S • Sc

250: Geo C • Sc • S • X • Sat C • Es • Ex • E • Nx • Sc • S • X

300: Geo St • Xn • X • Sat 2

400: Geo C • Sc • S • Xn • X • Sat C • Sc • S • Xn • X

500: Geo • Sat C • Sc • S • X



18 422 0560 

COMPLETA - COMPLETE

50: Fight 3 • 3E • 3Lc • 3Lcx • Kisbee • Kisbee U •
Kisbee X • Viva 3L • 2T • 4T

125: Viva 3L 4T • Vivacity





PIAGGIO

18 422 0010

SUPERIORE - UPPER

50: Fly 2T 05-07 • Liberty 97-05 • Liberty 2T Rst 04 • Liberty 4T 00-02 • Liberty 4T Rst 04 • Liberty Ptt Eu2 04-05 • Nrg 94-96 • Nrg Extreme 99-00 • Nrg Power Dd 05 • Nrg Power Purejet 04-05 • Nrg Purejet 02-04 • Nrg Rst Mc2 96-98 • Ntt 95-96 • Quartz 92-96 • Sfera 91-93 • Sfera Maquillage 2 94 • Sfera Rst 95-97 • Typhoon 01-04 • Vespa Et2 Iniez 97-00 • Vespa Et4 00-05 • Vespa Lx 2T Touring 10 • Vespa Lx 4T-4V Touring 10 • Vespa N 89-90 • Vespa Pk Autom 84-89 • Vespa Pk XI 85-88 • Vespa Pk XI Plurimatic 85-90 • Vespa Pk XI Rush 88-89 • Zip 00-04 • Zip 95-96 • Zip 4T 00-05 • Zip Bimodale 94-97 • Zip Fast Raider 93-94 • Zip Fast Raider Rst 96-97 • Zip Rst 96-99 • Zip Sp 96-04

80: Skr City 99 • **100:** Free 02-03

125: Cosa 2 91-97 • Cosa Cl-Clx 88-91 • Hexagon 94-97 • Hexagon Gtx 00 • Hexagon Lx-Lxt 98-99 • Hexagon Lx4 98-99 • Liberty 98-02 • Sfera 95-97 • Skipper 94-97 • Skipper 4T 00-02 • Skipper Lx 98-99 • Super Hexagon Gtx 12" 01-02 • Vespa Et4 96-02 • Vespa Pk XI 86-89 • Vespa Px Eu2 01-07 • Vespa S 4T le 09 • Zip 00-02

200: Liberty Rst 04

250: Hexagon Gt-Gtx 98-00

(R.O. 56002R)



18 422 0020

INFERIORE - LOWER

50: Fly 2T 05-07 • Liberty 97-05 • Liberty 2T Rst 04 • Liberty 4T 00-02 • Liberty 4T Rst 04 • Liberty Ptt Eu2 04-05 • Nrg 94-96 • Nrg Extreme 99-00 • Nrg Power Dd 05 • Nrg Power Purejet 04-05 • Nrg Purejet 02-04 • Nrg Rst Mc2 96-98 • Ntt 95-96 • Quartz 92-96 • Sfera 91-93 • Sfera Maquillage 2 94 • Sfera Rst 95-97 • Typhoon 01-04 • Vespa Et2 Iniez 97-00 • Vespa Et4 00-05 • Vespa Lx 2T Touring 10 • Vespa Lx 4T-4V Touring 10 • Vespa N 89-90 • Vespa Pk Autom 84-89 • Vespa Pk XI 85-88 • Vespa Pk XI Plurimatic 85-90 • Vespa Pk XI Rush 88-89 • Zip 00-04 • Zip 95-96 • Zip 4T 00-05 • Zip Bimodale 94-97 • Zip Fast Raider 93-94 • Zip Fast Raider Rst 96-97 • Zip Rst 96-99 • Zip Sp 96-04

80: Skr City 99 • **100:** Free 02-03

125: Cosa 2 91-97 • Cosa Cl-Clx 88-91 • Hexagon 94-97 • Hexagon Gtx 00 • Hexagon Lx-Lxt 98-99 • Hexagon Lx4 98-99 • Liberty 98-02 • Sfera 95-97 • Skipper 94-97 • Skipper 4T 00-02 • Skipper Lx 98-99 • Super Hexagon Gtx 12" 01-02 • Vespa Et4 96-02 • Vespa Pk XI 86-89 • Vespa Px Eu2 01-07 • Vespa S 4T le 09 • Zip 00-02

200: Liberty Rst 04 • **250:** Hexagon Gt-Gtx 98-00

(R.O. 56003R)



18 422 0100

COMPLETA - COMPLETE

50: Fly 2T 05-07 • Liberty 97-05 • Liberty 2T Rst 04 • Liberty 4T 00-02 • Liberty 4T Rst 04 • Liberty Ptt Eu2 04-05 • Nrg 94-96 • Nrg Extreme 99-00 • Nrg Power Dd 05 • Nrg Power Purejet 04-05 • Nrg Purejet 02-04 • Nrg Rst Mc2 96-98 • Ntt 95-96 • Quartz 92-96 • Sfera 91-93 • Sfera Maquillage 2 94 • Sfera Rst 95-97 • Typhoon 01-04 • Vespa Et2 Iniez 97-00 • Vespa Et4 00-05 • Vespa Lx 2T Touring 10 • Vespa Lx 4T-4V Touring 10 • Vespa N 89-90 • Vespa Pk Autom 84-89 • Vespa Pk XI 85-88 • Vespa Pk XI Plurimatic 85-90 • Vespa Pk XI Rush 88-89 • Zip 00-04 • Zip 95-96 • Zip 4T 00-05 • Zip Bimodale 94-97 • Zip Fast Raider 93-94 • Zip Fast Raider Rst 96-97 • Zip Rst 96-99 • Zip Sp 96-04

80: Skr City 99 • **100:** Free 02-03

125: Cosa 2 91-97 • Cosa Cl-Clx 88-91 • Hexagon 94-97 • Hexagon Gtx 00 • Hexagon Lx-Lxt 98-99 • Hexagon Lx4 98-99 • Liberty 98-02 • Sfera 95-97 • Skipper 94-97 • Skipper 4T 00-02 • Skipper Lx 98-99 • Super Hexagon Gtx 12" 01-02 • Vespa Et4 96-02 • Vespa Pk XI 86-89 • Vespa Px Eu2 01-07 • Vespa S 4T le 09 • Zip 00-02

200: Liberty Rst 04

250: Hexagon Gt-Gtx 98-00

(R.O. 56002R+56003R)



18 422 0300

SUPERIORE - UPPER

50: Fly 4T 05-07 • Fly 4T Motore Chn 06-07 • Liberty 2T 06-08 • Liberty 2T Sport 06-08 • Liberty 4T 05-08 • Liberty 4T Sport 06 • Liberty Moc 4T & Elle 09-11 • Nrg Mc3 01-04 • Nrg Power Dd 06-10 • Nrg Power Dd Serie Speciale 07-08 • Nrg Power Dt 06-08 • Nrg Power Pur Jet 06-09 • Typhoon 05-09 • Vespa 67-82 • Vespa Et2 97-05 • Vespa Lx 2T 05-08 • Vespa Lx 2T Fl 09-10 • Vespa Lx 4T 05-08 • Vespa Lx 4T-4V 09 • Vespa Lxv 2T 06-08 • Vespa Lxv 2T Navy 08 • Vespa Pk 82-84 • Zip 2T 08-10 • Zip 4T 06-08 • Zip Sp Eu2 06-09 • **100:** Fly 4T 06-07 • **125:** Fly 05-07 • Fly Eu3 07 • Liberty 4T 06-07 • Liberty 4T Eu3 07-08 • Liberty 4T Eu3 Delivery 08 • Liberty 4T Sport Eu3 06-08 • Liberty Rst Ptt 05-11 • Liberty Sport 06 • Mp3 07-08 • Mpe le 08-09 • Vespa Granturismo0 03-07 • Vespa Granturismo Eu3 06-07 • Vespa Gts Eu3 07-09 • Vespa Gtv 07-08 • Vespa Gtv 4T Navy Eu3 08 • Vespa Lx 05-06 • Vespa Lx 4T Fl 09 • Vespa Lx Eu3 06-08 • Vespa Lxv 4T Eu3 06-09 • Vespa Lxv 4T Navy Eu3 08 • Vespa Px 98-01 • Vespa Px 30 Anni 07-08 • Vespa Px T5 85-89 • Vespa Pxe Arcobaleno 81-97 • Vespa S 4T Eu3 07-08 • **150:** Fly 05-07 • Liberty 4T Eu3 08 • Liberty 4T Sport Eu3 08 • Liberty Moc 4T 09-10 • Vespa Lx 05-06 • Vespa Lx 4T Fl 09 • Vespa Lx Eu3 06-08 • Vespa S 4T 08-09 • **200:** Liberty 06 • Liberty 4T Eu3 07-08 • Liberty 4T Sport Eu3 06-07 • Liberty Sport 06 • Vespa Granturismo 06-07 • **250:** Mp3 06-08 • Mp3 Lt 09 • Mp3 Mic 08-09 • Vespa Gt 60 Eu3 06-07 • Vespa Gts, Gts Abs 05-10 • Vespa Gtv 06-09 • Vespa Gtv 4T Navy Eu3 08 • **300:** Mp3 300 le Lt 10 • Vespa Gts Super 08-09 • **400:** Mp3 07-08 • Mp3 Mic 08-09

(R.O. CM061303)





SERIE CALOTTE STERZO
STEERING HEAD BEARING SET

PIAGGIO

18 422 0450



COMPLETA - COMPLETE

125: Beverly Eu3 07-08 • Beverly Rst 4T 4V le Eu3 10-13 • Beverly Tourer Eu3 07-10 • Beverly Eu3 Mic /Sport 07-08 • Carnaby 07-10

200: Carnaby 07-08

250: Beverly 06-07

Beverly Cruiser 07-09

Beverly Eu3 Mic 07

Beverly le Eu3 06-08

Beverly Sport 06-08

Beverly Tourer Eu3 08-09

Carnaby 08

300: Beverly Rst 4T 4V

le Eu3 10-13

Beverly Tourer Eu3 09-10

Carnaby Cruiser 09-12

350: Beverly 4T 4V le

Eu3 Sport 11-13

(R.O. 6008725)



18 422 0510



COMPLETA - COMPLETE

125: X7 Eu3 08 • X7 Evo le Eu3 09-10

250: X7 Eu3 08 • X Evo 07-13

300: X7 Evo le Eu3 09-10

400: X8 Eu3 06-08

(R.O. 6009215)



18 422 0110



COMPLETA - COMPLETE

50: Boss 88-89 • Bravo 3 87-90 • Bravo Erre 2 75-81 • Si 79-88 • Si FI2 91-97 • Si Mix 96-99 • Superbravo 3 87-90

• Superbravo 85-90

(R.O. 564746)



18 422 0270



COMPLETA - COMPLETE

50: Boss 88-89 • Bravo 3 87-90 • Bravo erre 2 75-81 • Free Delivery 00-01 • Free FL 95-02 • Free 92-94 • Si FL2 91-97 • Si Mix 96-99 • Si 79-88 • Superbravo 3 87-90 • Superbravo 85-90 • Zip 92-96

125: Mp3 Ibrido 09

250: Mp3 Mic 08-09 • Mp3 06-08

400: Mp3 Mic 08-11 • Mp3 07-08

(R.O. 564746)



18 422 0520



COMPLETA - COMPLETE

125: Mp3 le 08-09 • Mp3 Ibrido 09-10 > • Mp3 le Touring 11-12 • Mp3 06-08

250: Mp3 Lt 09 • Mp3 Mic 08-09

300: Mp3 le Lt 10-11 • Mp3 le Mic 10-11 • Mp3

4T 4V le Lt Ibrido 10-11 • Mp3 4T 4V le Erl Ibrido

10-13 • Mp3 le Lt Touring 11-12 • Mp3 le Lt - le

Lt Sport 11-13 • Mp3 le Touring 11-12

400: Mp3 RL Touring 11 • Mp3 07-08 • Mp3 le

Lt - Mp3 le Lt Sport 08-10 •

Mp3 le Lt Touring 11 • Mp3

Mic 08-11

500: Mp3 Lt Sport - Business

11-12 • RL Sport - Business

11-12

(R.O. 601957)



18 422 0030



SUPERIORE - UPPER

50: Ape FI • FI2 89-95 • Ape FI3 Europa 96-99 • Ape P 80-85 • Ape Tm P 85-89 • Ape Mix 2T 98-08 • Rst Mix 99-03

(R.O. 493616)



18 422 0050



SUPERIORE - UPPER

220: Ape Car P2-P3 78-85 • Mp P501-P601 78-96

420: Ape Car- Max Diesel 86-96

(R.O. 153507)



18 422 0013



NEW

COMPLETA - COMPLETE

50: Vespa • Pk

90-125: Vespa

125: Primavera • ET3 • Px • Cosa • T5

150: Sprint • Super-TS • Px

200: Rally

V5A2-V5B1-V9A1-VMA2-VMB1-

VLA-VLBVNL2T-VSE1T-VMX-VLX-

V5XVNX5T-VNX2-VLX2-VSX2-V5X1T-

VMX1T-VLR1T-VLR-VSR1

(R.O. 56002R-56003R)





PIAGGIO

18 422 0080 

SUPERIORE - UPPER

220: Ape Tm 09-12 • Ape Tm P602 82-83 • Ape Tm P703-P703V, FI2 84-05

420: Ape Tm D Lcs 05-12 • Ape Tm P703-P703V Diesel 87-04
(R.O. 493618)



18 422 0090 

INFERIORE - LOWER

220: Ape Tm 09-12 • Ape Tm P602 82-83 • Ape Tm P703-P703V, FI2 84-05

420: Ape Tm D Lcs 05-12 • Ape Tm P703-P703V Diesel 87-04
(R.O. 493619)



18 422 0540 

COMPLETA - COMPLETE

125: Mp3 Yourban Erl 11-12
300: Mp3 Yourban Erl 11•Mp3 Yourban Lt Erl 11-12
(R.O. 6670825)



18 422 0583 

COMPLETA - COMPLETE

125: Vespa VNA



18 422 0570 

COMPLETA - COMPLETE

50: Ciao
(R.O. 814231)



SCOOTER CINESI

18 422 0470 

COMPLETA - COMPLETE

Baotian - Bt50Qt9-Qt12



18 422 0480 

COMPLETA - COMPLETE

Baotian - Bt 49 Qt-18
Keeway - F-Act 50-Flash



SUZUKI

18 422 0400 

COMPLETA - COMPLETE

125: Marauder 98-10 • Vanvan 03-10
Burgman 02-10 • Intruder 00-07
150: Burgman 02-06
200: Burgman 07-10
250: Burgman 98-06
Marauder 99-07
Intruder 00-07
400: Burgman 99-06





SERIE CALOTTE STERZO
STEERING HEAD BEARING SET

SYM

18 422 0490



COMPLETA - COMPLETE

50: Fiddle II 08 • Fiddle II S 09-13 • Jet 4 09-10
• Jet 4 R2T 11-13 • Symphony 09 • Symphony
S 10-12 • Symphony Sr 10-12 • Symply 07-08
• Symply II 09 • X Pro 13
- **125:** Eu Mx / E2 02-04 •
Fiddle II 08-10 • Jet V 11 • Jet
4 09-10 • Shark 99-02 • Sym-
phony S 09-12 • Symphony
Sr 10-12 • Symphony 09 •
Symply 07-08 • Symply II
09-10 • Vs Eu3 06-08 • X Pro
13 - **150:** Eu Mx / Eu2 02-04
• Fiddle II 10-12 • Shark
00-01 • Symphony 09-12 •
Symphony Sr 10-12 • Vs /
Eu3 06-08



18 422 0500



COMPLETA - COMPLETE

250: Joymax Eu3 I 07-08
300: Joymax Evo 09 • Evo I 10



YAMAHA

18 422 0230



SUPERIORE - UPPER

50: Aerox 02-11 • Aerox Eu2 03 • Axis 95-96 •
Breeze 94-95 • Cts 90-95 • Jog Z 95 • Jog R 02-11
• Jor Eu2 02-05 • Neo'S 02-11 • Neo'S Eu2 02-03
• Neo'S 4 09-11 • Slider 00-02 • Bw's Naked 04-
11 • Bw's 04-11 • Crz 91-95
100: Aerox 00-02 • Bw'S 99-01
125: Beluga 90-95 • Cygnus /R 95-03 • X City 08-
10 • Maxster 01-02 • Majesty 98-09 • Teo's 00
150: Beluga 01-02 • Cygnus 01-02 • Flyone /R 90-
98 • Majesty 00-02 • Maxster 01-02 • Teo'S 01-02
180: Majesty 03-06
250: X City 07-1
Majesty 96-03
Majesty Dx 98-99
Majesty Abs 03
300: Versity 03-06



18 422 0240



INFERIORE - LOWER

50: Axis 95-96 • Bw's Naked 04-11 • Bw's
04-11 • Breeze 94-95 • Crz 91-95
Cts /Ss 90-95 • Giggie 08 • Jog Z 95 • Jog
Eu2 02-05 • Jog R 02-11 • Neo'S 02-11 •
Neo'S Eu2 02-03 • Neo's 4 09-11
Slider 02



18 422 0150



COMPLETA - COMPLETE

50: Axis 95-96 • Breeze 94-95 • Bw's Naked 04-
11 • Bw's 04-11 • Cts /Ss 90-95 • Crz 91-95 • Jog Z
95 • Jog R Eu2 02-05 • Jog R 02-11 • Neo'S 02-11
• Neo'S Eu2 02-03 • Neo's 4 09-11 • Slider 02



18 422 0250



INFERIORE - LOWER

50: Aerox 01-13 • Aerox Eu2 03 • Slider 00-02
Aerox Naked 13
100: Aerox 00-02 • Slider 00-02
125: Majesty 01-05 • X Max 07-09 • Yzfr 08-11 •
150: Majesty 01-02
180: Majesty 03-06
250: X Max 05-09 • Black X Max 09



18 422 0280



COMPLETA - COMPLETE

50: Ew Slider 00-02 • Aerox 01-13
Aerox Eu 2 03 • Aerox Naked 13
100: Aerox 00-02
125: Majesty 98-09 • Maxster 01-02 • Teo's 00
150: Majesty 00 • Maxster 01-02 • Teo's 01-02



18 422 0160



COMPLETA - COMPLETE

50: Bw's bump 97-98 • Bw's Naked 03 • Bw's 03
• Bw's Next Generation 97-06 • Next Generation
Kat 99-00 • Bw's Original Eu2 02-05 • Bwis Ori-
ginal 97-02 • Bw's R 01 • Spy 95-98 • Way 98-06
• Way Eu1/2 99-05 • Neo's 97-01 • Aerox R 99-00
• Aerox 97-02
100: Neo's 99-01





YAMAHA

18 422 0400

COMPLETA - COMPLETE

500: T Max Abs 05-07 • T Max 01-07
T Max Black Max / Night Max 06-07



18 422 0410

COMPLETA - COMPLETE

500: T-Max 08-11 • T Max Abs Sv 11 • T Max
Abs 08-11 • T Max Sv 11 • T Max White Max 10



18 422 0430

COMPLETA - COMPLETE

125: Vpx - X-City 08-10
250: X-City 07-11
300: Versity 03-06



18 422 0420

COMPLETA - COMPLETE

125: Yp R X-Max 10-11
• X Max Abs 11
250: X Max 10-11
• X Max Abs Sport 11



18 422 0390

COMPLETA - COMPLETE

100: Bw'S 99-01
125: Bw'S 10 • Beluga 90-95
• Cygnus SX 04-11
• Cygnus R 97-03
• Cygnus 95-98
150: Flyone 90-95
• Flyone R 97-98



18 422 0440

COMPLETA - COMPLETE

125: Xmax 06-09
250: Black X Max 09
• X Max 05-09





GABBIETTE STERZO - GROSSE SFERE - BALL CAGES - BALL SETS



Grosse sfere Conf. (144 Pz.)
Grs ball set (144 Pcs)

18 424 0010 

GABBIETTE STERZO SUPERIORE SFERE 1/8"
UPPER BALL CAGES

Confez. 50 pz. • 50 Pcs ball set
PIAGGIO Vespa • (R.O. 077024)

18 424 0200 

5 Conf. Grosse sfere 1/8" (Tot. 720 Pz.)
5 Grs ball set 1/8" (Tot. 720 Pcs)

18 424 0210 

5 Conf. Grosse sfere 5/32" (Tot. 720 Pz.)
5 Grs ball set 5/32" (Tot. 720 Pcs)

18 424 0020 

GABBIETTE STERZO INFERIORE SFERE 1/4"
LOWER BALL CAGES

Confez. 50 pz. • 50 Pcs ball set
PIAGGIO Vespa • (R.O. 077023)

18 424 0220 

5 Conf. Grosse sfere 3/16" (Tot. 720 Pz.)
5 Grs ball set 3/16" (Tot. 720 Pcs)

18 424 0230 

5 Conf. Grosse sfere 7/32" (Tot. 720 Pz.)
5 Grs ball set 7/32" (Tot. 720 Pcs)

18 424 0043 

NEW

KIT GABBIETTE STERZO
SFERE 1/4" ; 1/8"
UPPER BALL CAGES

Varioius VESPA Models
(R.O. 077023-077024)

18 424 0240 

5 Conf. Grosse sfere 1/4" (Tot. 720 Pz.)
5 Grs ball set 1/4" (Tot. 720 Pcs)

18 424 0250 

5 Conf. Grosse sfere 5/16" (Tot. 720 Pz.)
5 Grs ball set 5/16" (Tot. 720 Pcs)

18 424 0030 

GABBIETTE SUPERIORI 5/32"
UPPER BALL CAGES 5/32"

Conf. 50 pz. (50/Pcs Packing)
per ricambio serie 18 422 0300
for replace 18 422 0300
PIAGGIO-GILERA

18 424 0260 

5 Conf. Grosse sfere 11/32" (Tot. 720 Pz.)
5 Grs ball set 11/32" (Tot. 720 Pcs)

12 186 0050
DADO 9MA - NUT 9MA

Various Vespa models

Confezione 10 pz. - 10 Pcs Packing

(R.O. 020209)

12 185 0210
DADO VOLANO M 10X1,25 - FLYWHEEL NUT MOTORE MINARELLI 50

Confezione 10 pz. - 10 Pcs Packing

(R.O. 74921000)

12 185 0220
DADO PULEGGIA MOTRICE M10x1,25**DRIVING PULLEY NUT M10x1,25**

Confezione 10 pz. - 10 Pcs Packing

MINARELLI YAMAHA 50

(R.O.74918100)

PIAGGIO: Sfera 125 • Et4 • Hexagon Lx4 125 •

Liberty 125 98-00

GILERA: Easy moving • Storm • Typhoon**PIAGGIO:** Zip Free tutti • Nrg • Ntt

Sfera 50 • Quartz • Skr City • Nrg Rst Mc2

(R.O. Volano 436789 • Puleggia 021110)

12 185 0230
DADO CAMPANA**FRIZIONE POSTERIORE Ø 10x1****DRIVEN PULLEY DRUM NUT Ø 10x1**

Confezione 10 pz. - 10 Pcs Packing

MINARELLI YAMAHA 50

(R.O. 74920400)

12 186 0320
DADO PIGNONE - NUT

Confezione 5 pz. - 5 Pcs Packing

PIAGGIO 50-90-125: Vespa**125:** Primavera • Et3

(R.O. 001508)

12 186 0330
DADO FRIZIONE - FLYWHEEL NUT

Confezione 5 pz. - 5 Pcs Packing

PIAGGIO 125: Vespa Primavera • Et3

(R.O. 001510)

12 185 8460
DADO PERNO RUOTA - WHEEL PIN NUTS

Confezione 10 pz. - 10 Pcs Packing

PIAGGIO 50-90-125: Vespa Primavera

(R.O. 015222)

12 186 0340
DADO CERCHIO RUOTA - WHEEL NUT

Confezione 4 pz. - 4 Pcs Packing

PIAGGIO 125: Vespa

(R.O. 019411)

12 185 5000
SCODELLINO DADO RUOTA POST./ANT.**REAR FRONT WHEEL SHAFT CAP**

Confezione 10 pz. - 10 Pcs Packing

GILERA-PIAGGIO 50-125-150-180-500

Vespa Px • Cosa • Ape

(R.O. 194423)

12 185 0330
NEW**DADO FRIZIONE M 36X1-CLUTCH NUT M 36 X 1**

Conf. 10 pz. (10/Pcs Packing)

GILERA 125: Dna 01 • Nexus Eu 3 07 • Runner

Fx 97-02 • Vx 02 00-07 • Typhoon: X • Xr 95-00

180: Dna 01 • Runner: Fxr 97-02 • Vxr 00-01**200:** Runner Vxr 02-06**250:** Nexus: Eu3 • Sp Eu 3 06-07**PIAGGIO 125:** Beverly: 01-03 • Eu3 Mic 07 • Eu

3 Sport 07 • Eu 3 07 • Rst 04-07 • Carnaby 07 •

Fly 05-06 • Hexagon: 94-97 • Gtx 00 • Lx 98-99 •

Liberty: 00-02 • 4T 06 • Rst PP 05-06 • Rst 04-05

• Sport 06 • Mp3 07 • Skypper: 94-97 • 4T 00-02

• Lx 98-99 • S. Hexagon Gtx 12" 01-02 • Vespa:

Et4 99-02 • Gt 03-06 • Lx Eu 3 06-07 • Lx 05-06 •

Lxv 4T 06 • X Evo 07 • X8 04-06 • Premium Eu2

06 • Street Eu2 06 • X9 Evolution 03-06 • X9 01-

02 • Zip 00-02

150: Hexagon 94-97 • Liberty 00-02 • Skypper

94-97 • 4T 00-02 • Lx 98-99 • Vespa Et4 99-02 •

Fly 05 • Vespa Gt 60 Eu3 06-07 • Lx Eu3 06-07 •

Lx 05-06 • X8 Street Eu2 06

180: Hexagon Gtx 00 • Lxt 98-99 • Super Hexa-

gon Gtx 12" 01-02 • X9 Amalfi 00-03

200: Beverly 01-03 • Vespa Gran Turismo 03-05 •

X8 04 • Carnaby 07 • Liberty 06 • Rst 04 • Sport 06

• Vespa Gt 06 • X8 05-06 • X9 02-03 • Evolution 03

250: Beverly 06-07 • Cruiser 07 • ie Eu3 06-07

Rst 04-05 • Sport 06 • Mp3 06-07 • Vespa Gts 05-06

• Gtv 06 • X8 05-06 • Evo 07 • X9 Evolution 04-06

(R.O. 433232)





DADI - RONDELLE

NUTS - WASHERS

12 185 0240 

**DADO RUOTA POSTERIORE
AUTOBLOCCANTE M14x1,5**
REAR WHEEL SHAFT SELF LOCK NUT M14x1,5
Confezione 10 pz. - 10 Pcs Packing
MINARELLI YAMAHA 50
MALAGUTI 125-150-250: Madison
(R.O. 1850100)



12 185 0290 

DADO ALBERO PRIMARIO M 9x1,25
PRIMARY SHAFT NUT M 9x1,25
Confezione 10 pz. - 10 Pcs Packing
PIAGGIO 125-150-200: Vespa Pxe Arcobale-
no • Px • Px T5 • Cosa 2 • Cosa CL • CLX • Rally
(R.O. 015231)



12 185 0250 

DADO TUBO SCARICO FLANGIATO M 7x1
SILENCER NUT M7x1
Confezione 10 pz. - 10 Pcs Packing
GILERA 125-180: Runner Vx-Vxr 00> Dna
PIAGGIO 125: Sfera • Zip 00
125-150: Skipper 4T • Vespa Et4 99>
125-180: Super Hexagon Gtx
180: X9 Amalfi
(R.O. 436947)



12 185 0340 

**KIT DADO SCODELLINO COPIGLIA
PER ALBERO RUOTA POSTERIORE**
REAR WHEEL SHAFT NUT CAP SET
GILERA-PIAGGIO
(R.O. 194423-563728)



12 185 0270 

DADO VOLANO FLANGIATO M 10x1,25
FLYWHEEL NUT M10x1,25
Confezione 10 pz. - 10 Pcs Packing
GILERA 50: Runner • Stalker • Dna • Ice
PIAGGIO 50: Diesis • Liberty 2T 97-01
Nrg Mc3 • Nrg Extreme • Purejet • Typhoon 01
Vespa Et2 • Et2 iniezione • Et4 00-01 • Zip 00
• Free 100
(R.O. 289005)



12 185 0460 

DADO MOZZO FRIZIONE POSTERIORE
REAR CLUTCH HUB NUT
Confezione 10 pz. - 10 Pcs Packing
PIAGGIO 400: Beverly Eu3 06-07 • Mp3 07
Xevo 07-08 • Eu3 06-08
500: Beverly 02-06 • Cruiser Eu3 06-08 • X9 01-
02 • Evolution 03-07 • Evolution Abs 06-07



12 185 0310 

DADO MOZZO FRIZIONE POSTERIORE M 28x1
REAR CLUTCH HUB NUT M28x1
Confezione 10 pz. - 10 Pcs Packing
HONDA 125-150: @ • Sh
MINARELLI-YAMAHA-MBK-MALAGUTI 50
(R.O. 74921900)
GILERA-PIAGGIO 50: (R.O. 289955)



12 185 0320 

DADO MOZZO FRIZIONE POSTERIORE M 38x1
REAR CLUTCH HUB NUT M38x1
Confezione 10 pz. - 10 Pcs Packing
PIAGGIO 50: Sfera 91-93 • Zip 92-94
80: Skr City
125: Sfera 95-97 • Liberty 98-00 • Vespa Et4
96-99 • Hexagon Lx4 98>
(R.O. 285017)



12 185 0400 

DADO VOLANO - FLYWHEEL NUT
Confezione 10 pz. - 10 Pcs Packing
PIAGGIO 50-90-125: Vespa Primavera • Et3
(R.O. 001545)



12 185 0350 

DADO ALBERO RUOTA POSTERIORE
REAR WHEEL SHAFT NUT
Confezione 10 pz. - 10 Pcs Packing
GILERA-PIAGGIO 50-125-150-180-250-500
(R.O. 563728)



12 185 0360 

**DADO FRESATO FISSA TAMBURO
RUOTA POSTERIORE**
REAR WHEEL DRUM SECURING NUT
Confezione 5 pz. - 5 Pcs Packing
PIAGGIO 50-90-125: Vespa Et3
(R.O. 002314)



12 185 0390 

DADO CAMPANA FRIZIONE
CLUTCH RING NUT
Confezione 10 pz. - 10 Pcs Packing
PIAGGIO 125-150-200: Vespa Px • Pe
(R.O. 020375)





12 185 0410 

DADO VOLANO M 12 x 1,25 H 10
FLYWHEEL NUT M 12 x 1,25 H 10
Confezione 10 pz. - *10 Pcs Packing*
GILERA 125-180: Runner • Vx-Vxr
125-180: Dna 00>
PIAGGIO 50: Ape tutti i modelli
125: Zip 125-00> • Beverly 00-01
125-150: Skipper 4T • Liberty 01> • Vespa Et4
99> • Px • Pe • Pk Rush • N • FL • Cosa 92-97
125-180: S. Hexagon Gtx 00>
180: X9 Amalfi 00>
(R.O. 486324)



12 185 0430 

DADO TESTA CILINDRO
MARMITTA - CARROZZERIA M6X1
CYLINDER HEAD - MUFFLER - BODYWORK
NUT M6X1
Confezione 10 pz. - *10 Pcs Packing*
GILERA-PIAGGIO 50-125-150-180-200-250-500



12 185 0440 

KIT DADO RONDELLA RUOTA POST.
REAR WHEEL SHAFT NUT AND WASHER SET
MINARELLI-YAMAHA 50



12 185 0450 

KIT DADO RONDELLA PULEGGIA MOTRICE
DRIVING PULLEY NUT AND WASHER SET
MINARELLI-YAMAHA 50



12 185 5010 

SCODELLINO FERMA DADO FRIZIONE
CLUTCH RING NUT SECURING WASHER
Confezione 50 pz. - *50 Pcs Packing*
PIAGGIO 125-150-200: Vespa Px • Pe • Cosa
(R.O. 22313)



12 185 5050 

RONDELLA PIANA CON INCAVO INTERNO
PER DADO FISSAGGIO RUOTA POSTERIORE
REAR WHEEL SHAFT WASHER
Confezione 10 pz. - *10 Pcs Packing*
MINARELLI-YAMAHA 50
Fori interni - *Internal* Ø 14 e Ø 17
Ø esterno - *external* 28
Spessore - *thickness* 5 mm



12 185 5060 

RONDELLA CONICA PER DADO FISSAGGIO
PULEGGIA MOTRICE
DRIVE PULLEY CONICAL WASHER
Confezione 10 pz. - *10 Pcs Packing*
MINARELLI-YAMAHA 50



12 185 6050 

BULLONE Ø 6 x 1 - BOLT Ø 6x1
Confezione 10 pz. - *10 Pcs Packing*
MINARELLI-YAMAHA 50



12 185 9110 

RONDELLA GROWER IN ALLUMINIO
ALLOY GROWER WASHER
12x20x2 Tappo olio Honda Sh 300
12x20x2 Oil tap Honda Sh 300
Confezione 10 pz. - *10 Pcs Packing*



12 185 8620 

COLONNINA CUFFIA - SPACER
PIAGGIO 125-150-200: Vespa Px
Confezione 10 pz. - *10 Pcs Packing*
(R.O. 014447)



12 186 0290 

COLONNINA CUFFIA
COOLING HOOD SPACER
PIAGGIO 200: Vespa
Confezione 10 pz. - *10 Pcs Packing*
(R.O. 015239)





DADI - RONDELLE

NUTS - WASHERS

12 185 0260 

Dado M10x1,25 - Nut

Confezione 10 pz. - 10 Pcs Packing
(R.O. 289519)



DADO M 10 X 1,25 - NUT	PULEGGIA CONDOTTA DRIVEN PULLEY	MOTRICE DRIVING PULLEY	VOLANO FLYWHEEL
GILERA 50: Dna 00-01	•	•	
Easy Moving 95-96	•	•	
Runner 97-00	•	•	
Storm 94-95	•	•	
Stalker 97-01	•	•	
Typhoon X 98-99	•	•	
Typhoon XR 00	•	•	
Typhoon 94-97	•	•	
PIAGGIO 50: Diesis 01	•	•	
Free 92>	•	•	
Free delivery 00>	•	•	
Liberty 4T 00>	•	•	•
Liberty 2T 97>	•	•	
Nrg 94-96	•	•	
Nrg Mc3 01	•	•	
Nrg Extreme 99-00	•	•	
Nrg Rst Mc2 96-98	•	•	
Ntt 95-96	•	•	
Quartz 92-96	•	•	
Sfera base 91-93	•	•	
Sfera Maquillage 2 94	•	•	
Sfera Rst 95-97	•	•	
Typhoon 01	•	•	
Velofax 96-99	•	•	
Vespa Et4 00-01	•	•	
Vespa Et2 97-01	•	•	
Vespa Et2 iniezione	•	•	
Zip Rst 96-99	•	•	
Zip fast Raider 93-97	•	•	
Zip SP 96-97	•	•	
Zip Base 92-94	•	•	
Zip 00	•	•	
Zip 4 00	•	•	•
Zip & Zip Bimod. 94-97	•	•	
PIAGGIO 80: Skr City 99	•	•	
PIAGGIO 125: Hexagon Lx4 98-99	•	•	•
Liberty 98-00	•	•	•
Vespa Et4 96-99	•	•	•
Sfera 95-97 (R.O. 289519)	•	•	•

12 185 0280 

Dado M12x1,25 - Nut

Confezione 10 pz. - 10 Pcs Packing



DADO M 10 X 1,25 - NUT	PULEGGIA CONDOTTA DRIVEN PULLEY	MOTRICE DRIVING PULLEY	VOLANO FLYWHEEL
GILERA: Dna 125-180		•	•
Runner Fx-Fxr 125-180	•	•	•
Runner Vx-Vxr 125-180		•	•
Typhoon 125 95-98	•	•	•
Typhoon 125 95-98	•	•	•
PIAGGIO: Hexagon Lx-Lxt 125-180	•	•	•
Hexagon 125-180 94-97	•	•	•
Liberty 125-150 00-01		•	•
Super Hexagon Gtx125-180		•	•
Skipper 4T 125-150-200 01		•	•
Skipper 125-150 98-99	•	•	•
Skipper Lx 125-150 98-99	•	•	•
Vespa Et4 125-150 99-01		•	•
X9 Amalfi 180 00-01		•	•
Zip 125 00		•	•
(R.O.436783)			

18 420 0020 

DADO SUPERIORE STERZO PASSANTE

STEERING UPPER NUT

PIAGGIO: Si • Bravo P • Bravo 3
(R.O. 184431)





12 185 0470 

DADO FRIZIONE - CLUTCH NUT

Confezione 10 pz. - 10 Pcs Packing

MBK 125: Xc Flame F 00 • Xc X Flame R 95-99 • Xc T Flame 95-99 • Xn Doodo 00-01 • Yp Skyliner 98-02

150: Xc Vertex 97 • Yp Skyliner 00-02

250: Yp Skyliner Abs 03 • Yp Skyliner 00-03

300: Xc Kilibre 03

YAMAHA 125: Nxc Cygnus X 04-11 • Xc Beluga 90-95 • Xc Cygnus R 99-03 • Xc K Cygnus R 97-98 • Xc T Cygnus 95-98 • Xn Teo's 00 • Yp Majesty 98-02 • Yw Bw's 10

150: Xc Fly One R 97-98 • Xc Fly One 90-95 • Yp Majesty 00-02

250: Vp X-City 07-12 • Yp Majesty Abs 03 • Yp majesty Dx 98-99 • Yp Majesty 95-03 • Yp R Black X-Max 09 • Yp R X-Max Abs 11-12 • Yp R X-Max Sport 11-12 • Yp R X-Max 05-12

300: Xc Versity 03-06

400: Yp Majesty Abs 07-11 • Yp Majesty 04-11

500: Xp T-Max Abs Sv 11 • Xp T-Max Abs 05-11 • Xp T-Max Black Max - Night Max 07 • T Max Black Max 06 • Xp T-Max Sv 11 • Xp T-Max White Max 10 • Xp T-Max 01-11

530: Xp T-Max Abs 12 • Xp T-Max 12
(R.O. 901703627900)



12 185 8570 

BALESTRINO FRIZIONE

CLUTCH PUSH RING

PIAGGIO 50: Ciao • Si

(R.O. 220441)

12 185 8520 

RONDELLA DI FERMO - WASHER - RONDELLE

Confezione 20 pz. - 20 Pcs Packing

PIAGGIO 125-150-200: Vespa Px • Pxe Arcobaleno VNX-VLX-VSX-VNX2-VLX2-VSX2

(R.O. 016305)



12 185 8500 

PIASTRINA ELASTICA - PLATE FIXING PRING

Confezione 20 pz. - 20 Pcs Packing

PIAGGIO 125-150-200: Vespa Px • Pxe Arcobaleno VNX-VLX-VSX-VNX2-VLX2-VSX2

(R.O. 181475)



12 185 8510 

RONDELLA - WASHER

Confezione 20 pz. - 20 Pcs Packing

PIAGGIO 125-150-200: Vespa Px • Pxe Arcobaleno VNX-VLX-VSX-VNX2-VLX2-VSX2

(R.O. 139890)



12 185 8580 

DISTANZIALE PERNO RUOTA - PIN SPACER

Confezione 20 pz. - 20 Pcs Packing

PIAGGIO 150: Vespa GL • Sprint-Rally

(R.O. 99474)



12 185 8530 

**RONDELLA DI SPALLAMENTO
CRANK SHAFT WASHER**

Confezione 20 pz. - 20 Pcs Packing

PIAGGIO 50: Ciao • Si - (R.O. 102943)

12 185 8540 

**RONDELLA MOZZO POSTERIORE
HUB WASHER**

Confezione 20 pz. - 20 Pcs Packing

PIAGGIO 50: Ciao • Si

(R.O. 131514)

12 185 8550 

**RONDELLA PULEGGIA POSTERIORE
REAR PULLEY WASHER**

Confezione 20 pz. - 20 Pcs Packing

PIAGGIO 50: Ciao • Si - (R.O. 103556)

12 185 8560 

RONDELLA PULEGGIA - PULLEY WASHER

Confezione 20 pz. - 20 Pcs Packing

PIAGGIO 50: Ciao • Si

(R.O. 103557)





DADI - RONDELLE

NUTS - WASHERS

12 185 6100 

VITE TESTA CON INSERTO A CROCE PER CARROZZERIA - BODYWORK SCREW

Confezione 10 pz. - 10 Pcs Packing

GILERA: Typhoon 50 • Stalker • Storm

Runner 50-125-180 • Vx • Vxr 125-180

Dna 50-125-180

PIAGGIO: Sfera 50-125 • Et2 • Et4

Skipper 4t • Super Hexagon Gt

Hexagon Lx4

Hexagon Lx

Lxt • Liberty

50-125-150

Zip 50-125

Zip 4 • Nrg • Mc2

Mc3-X9 180-500

Ape 50 Rst Mix

(R.O. 298086-575249)

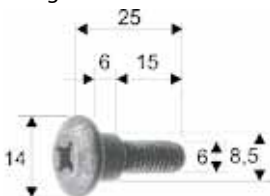

12 185 8640 

VITE PER LEVA - SCREW WITH NUT

Confezione 5 pz. - 5 Pcs Packing

Vari Modelli Vespa - Various Vespa Models

(R.O. 6610283M)



12 185 6120 

VITE LEVA FRENO E FRIZIONE

LEVERS SECURING SCREW

Confezione 50 pz. - 50 Pcs Packing

PIAGGIO: Vespa 50-90-125

Primavera Et3 • Px • Pe

(R.O. 150235-012136)



12 185 0480 

VITE FISSAGGIO RUOTA - WHEEL FIXING BOLT

Confezione 4 pz. - 4 Pcs Packing

PIAGGIO: Vespa 50-90 V5SA1-V9A1

(R.O. 070156)



12 185 8450 

VITE + DADO MANUBRIO

HANDLE BAR SCREW + NUT

Confezione 5 pz. - 5 Pcs Packing

PIAGGIO: Vespa

(R.O. 0015542-070620)



12 185 0370 

VITE PARAFANGO

SCREW MUDGUARD

Confezione 25 pz. - 25 Pcs Packing

Tutti i modelli Vespa - Vespa All models

(R.O. 014467)



12 185 8630 

BULLONE AMMORTIZZATORE POSTERIORE

BOLT

Confezione 5 pz. - 5 Pcs Packing

Tutti i modelli Vespa - Vespa All models

(R.O. 014689)



12 185 8900 

VITE PER MARMITTA - BOLT MUFFLER

Confezione 10 pz. - 10 Pcs Packing

PIAGGIO 125-150-200: Vespa Px

(R.O. 014691)



12 185 8490 

BULLONE RUOTA DI SCORTA - BOLT

Confezione 5 pz. - 5 Pcs Packing

PIAGGIO 125-150-200: Vespa Px- Vespa

125-T5

(R.O. 159873)



12 186 0270 

KIT PRIGIONIERO TAMBURO - DRUM KIT STUD

PIAGGIO: Vespa Px 125-150-200

• Vespa GL Sprint 150





PRIGIONIERI BULLONI - STUDS BOLTS

12 185 6000

PRIGIONIERO SCARICO Ø 6 X 33 mm
STUD FOR SECURING EXHAUST PIPE

Confezione 50 pz. - 50 Pcs Packing

PIAGGIO: Vespa 50 tutte • Ape P50
(R.O. 003918)

PEUGEOT: Buxy • Speedake • SV Geo-
Squab • Speedfight • Trekker

12 185 6030

PRIGIONIERO CILINDRO Ø 7 X 109 mm
CYLINDER SECURING STUD

Confezione 20 pz. - 20 Pcs Packing

MINARELLI-YAMAHA: Scooter 50
(cilindro orizzontale) raffr. aria-acqua
(R.O. 7491880-901160735300)

12 185 8740

PRIGIONIERO CARTER Ø 7 X 52 mm
ENGINE CASE STUD

PIAGGIO: Vespa Px-GL-Sprint
(R.O. 239153)

12 185 6010

PRIGIONIERO SCARICO Ø 6 X 26 mm
EXHAUST PIPE STUD

Confezione 50 pz. - 50 Pcs Packing

PIAGGIO: Scooter 50-125-180-500
(R.O. 239397)

12 185 6040

PRIGIONIERO CILINDRO Ø 7 X 142 mm
CYLINDER SECURING STUD

Confezione 20 pz. - 20 Pcs Packing

PIAGGIO: Vespa 125-Et3 - (R.O. 150656)

12 186 0250

PRIGIONIERO FLANGIA TAMBURO POST.
REAR DRUM FLANGE STUD

Confezione 10 pz. - 10 Pcs Packing

Vespa 50-90-125 Primavera ET3 - PK 50-125

Confezione 10 pz. - 10 Pcs Packing

(R.O. 000456)



12 185 6020

PRIGIONIERO CILINDRO Ø 6 X 106 mm
CYLINDER SECURING STUD

Confezione 20 pz. - 20 Pcs Packing

GILERA-PIAGGIO: Scooter 50

raffr. aria-acqua

(R.O. 239382)

MBK: cilindro verticale

(R.O. 901160641800)

12 185 6130

PRIGIONIERO CILINDRO Ø 8 X 160 mm
CYLINDER SECURING STUD

Confezione 20 pz. - 20 Pcs Packing

PIAGGIO: Vespa 200 • Cosa • Ape

(R.O. 016058)

12 186 0260

PRIGIONIERO BASE CILINDRO
CYLINDER STUD

Confezione 10 pz. - 10 Pcs Packing

Vespa 50-90-125 Primavera ET3 - PK 50-125

(R.O. 004515)

VITI CARTER MOTORE - CRANCKCASE SCREWS

Confezione 5 pz. - 5 Pcs Packing



M7 X L	MODELLI - MODELS	R.O.	CODICE - CODE	BARCODE
M7 x 45 mm	Vespa 50 - 90 - 125 Primavera ET3	008420	12 185 8660	
M7 x 50 mm	Vespa PX 125 - 150 - 200	239149	12 185 8690	
M7 x 54 mm	Vespa 50 - 90 - 125 Primavera ET3	008421	12 185 8670	
M7 x 65 mm	Vespa 50 - 90 - 125 Primavera ET3	008499	12 185 8650	
M7 x 80 mm	Vespa 50 - 90 - 125 Primavera ET3	008419	12 185 8680	
M7 x 90 mm	50: Ape FL-FL2-FL3 • Ape P • Ape Tm 220: Ape Car P2-P3 • Ape Tm P 703	015647	12 185 8760	
M7 x 95 mm	Vespa PX 125 - 150 - 200	239150	12 185 8700	

KIT BULLONI CARTER MOTORE
CRANCKCASE BOLTS KIT



MODELLI - MODELS	CODICE - CODE	BARCODE
Vespa 50 - 90 - 125 Primavera ET3	12 186 0120	
Vespa PX 125 - 150	12 186 0130	
Vespa PE 200	12 186 0140	



DADI - RONDELLE

NUTS - WASHERS

12 186 0110



KIT BULLONE MOTORE

ENGINE BOLT KIT

PIAGGIO 50-90-125: Vespa Primavera ET3 - PK 50-125



12 186 0160



KIT PRIGIONIERI CILINDRO

CYLINDER STUDS KIT

VESPA 50 - 125 Primavera - ET3



NEW

12 186 0353



KIT BULLONE MOTORE

ENGINE KIT BOLT

PIAGGIO 125-150-200: Vespa Sprint • GL

• Super

VNX - VLX - VSX - VLA - VLB - VBC



12 186 0363



KIT TUBO MOTORE COMPLETO

ENGINE TUBE KIT

PIAGGIO 125-150-200: Vespa Sprint • GL

• Super

VNX - VLX - VSX - VLA - VLB - VBC



12 186 0333



BULLONE CARBURATORE

CARBURATOR BOLT

Confezione 5 pz. - *5 Pcs Packing*

PIAGGIO 125-150-200: Vespa VNX - VLX - VSX

(R.O. 049542)



12 185 8430



CHIAVETTA VOLANO - FLYWHEEL KEY

Confezione 50 pz. - *50 Pcs Packing*

12,6 x 5 x 3 (mm)

PIAGGIO: Vespa

(R.O. 000267)



12 185 8440



CHIAVETTA FRIZIONE - CLUTCH KEY

Confezione 100 pz. - *100 Pcs Packing*

6,45 x 15,3 x 4 (mm)

PIAGGIO: Vespa

(R.O. 000097)





			
CODICE RMS RMS CODE	DIMENSIONI DIMENSIONS	QUANTITÀ QUANTITY	BARCODE
DADO ZINCATO - GALVANIZED NUT			
12 185 8840	M 4	100 Pz.	
12 185 8850	M 5	100 Pz.	
12 185 8860	M 6	100 Pz.	
12 185 8870	M 7	100 Pz.	
12 185 8880	M 8	100 Pz.	

			
CODICE RMS RMS CODE	DIMENSIONI DIMENSIONS	QUANTITÀ QUANTITY	BARCODE
VITE TESTA TAGLIO ZINCATA - GALVANIZED SCREW			
12 185 8890	M6 x 12 mm	25 Pz.	
Per copri ventola Vespa - For Vespa fan cover			

			
CODICE RMS RMS CODE	DIMENSIONI DIMENSIONS	QUANTITÀ QUANTITY	BARCODE
RONDELLA PIANA ZINCATA - GALVANIZED WASHER			
12 185 8810	Ø 5 mm	100 Pz.	
12 185 8820	Ø 6 mm	100 Pz.	
12 185 8720	Ø 7 mm	100 Pz.	
12 185 8830	Ø 8 mm	100 Pz.	

			
CODICE RMS RMS CODE	DIMENSIONI DIMENSIONS	QUANTITÀ QUANTITY	BARCODE
VITE TESTA PHILIPS ZINCATA - PHILIPS GALVANIZED SCREW			
12 185 8610	M5 x 35 mm	25 Pz.	
Per copri manubrio Vespa Px - For Vespa Px handle bar			

			
CODICE RMS RMS CODE	DIMENSIONI DIMENSIONS	QUANTITÀ QUANTITY	BARCODE
RONDELLA GROWER ZINCATA - GROWER GALVANIZED WASHER			
12 185 8790	Ø 5 mm	100 Pz.	
12 185 8800	Ø 6 mm	100 Pz.	
12 185 8730	Ø 7 mm	100 Pz.	
12 185 8780	Ø 8 mm	100 Pz.	
12 186 0060	Ø 9 mm	100 Pz.	
12 186 0070	Ø 10 mm	100 Pz.	

			
CODICE RMS RMS CODE	DIMENSIONI DIMENSIONS	QUANTITÀ QUANTITY	BARCODE
VITETESTA ESAGONALE ZINCATA - GALVANIZED HEXAGONAL SCREW			
12 185 8910	M 5 X 16 mm	100 Pz.	
12 185 8920	M 5 X 20 mm	100 Pz.	
12 185 8930	M 5 X 25 mm	100 Pz.	
12 185 8940	M 6 X 16 mm	100 Pz.	
12 185 8950	M 6 X 20 mm	100 Pz.	
12 185 8960	M 6 X 25 mm	100 Pz.	
12 186 0080	M 7 X 16 mm	100 Pz.	
12 186 0090	M 7 X 20 mm	100 Pz.	
12 186 0100	M 7 X 25 mm	100 Pz.	
12 185 8970	M 8 X 16 mm	100 Pz.	
12 185 8980	M 8 X 20 mm	100 Pz.	
12 185 8990	M 8 X 25 mm	100 Pz.	
12 185 8900	M 10 X 80 mm	100 Pz.	



FASCETTE CLAMPS

12 185 9030 

FASCETTA BANDA PIENA - CLAMP Ø 15-25 mm
Confezione 10 pz. - 10 Pcs Packing

12 185 9040 

FASCETTA BANDA PIENA - CLAMP Ø 20-32 mm
Confezione 10 pz. - 10 Pcs Packing

12 185 9050 

FASCETTA BANDA PIENA - CLAMP Ø 32-50 mm
Confezione 10 pz. - 10 Pcs Packing

12 185 9060 

FASCETTA BANDA PIENA - CLAMP Ø 50-70 mm
Confezione 10 pz. - 10 Pcs Packing



12 185 9000 

COLLARE TUBO BENZINA
FUEL CLAMP Ø 20 mm
Confezione 10 pz. - 10 Pcs Packing

12 185 9010 

COLLARE TUBO BENZINA
FUEL CLAMP Ø 10-12 mm
Confezione 10 pz. - 10 Pcs Packing

12 185 9020 

COLLARE TUBO BENZINA
FUEL CLAMP Ø 12-14 mm
Confezione 10 pz. - 10 Pcs Packing

12 186 0020 

COLLARE TUBO BENZINA
FUEL CLAMP Ø 14-16 mm
Confezione 10 pz. - 10 Pcs Packing

NEW



12 185 9070 

PASSACAVO GOMMATO - GROMMET Ø 8 mm
Confezione 10 pz. - 10 Pcs Packing

12 185 9080 

PASSACAVO GOMMATO - GROMMET Ø 12 mm
Confezione 10 pz. - 10 Pcs Packing

12 185 9090 

PASSACAVO GOMMATO - GROMMET Ø 16 mm
Confezione 10 pz. - 10 Pcs Packing

12 186 0000 

PASSACAVO GOMMATO - GROMMET Ø 20 mm
Confezione 10 pz. - 10 Pcs Packing

NEW



12 186 0023 

PIASTRINA FERMA GUAINA - CABLE PLATE
PIAGGIO 125-150-200: Vespa Px • Pxe
Arcobaleno
VNX-VLX-VSX-VNX2-VLX2-VSX2
(R.O. 0823854)

12 186 0033 

LEVA FRENO - BRAKE LEVER
PIAGGIO 125-150-200: Vespa Px • Pxe
Arcobaleno
VNX-VLX-VSX-VNX2-VLX2-VSX2
(R.O. 1011014)





12 186 0200 

PIASTRINA PER VITE AUTOFILETTANTE

Ø 2,9 mm

SELF THREADING PLATE Ø 2,9 mm

Per fissaggio Clacson Vespa 50 N-L-R

Primavera 125: GL-Super 125-150 Ss 180 Gt •

125 Sprint 150 rally 180-200-T5 125

Confezione 100 pz. - 100 Pcs Packing



12 186 0210 

PIASTRINA PER VITE AUTOFILETTANTE

Ø 3,5 mm

SELF THREADING PLATE Ø 3,5 mm

Per fissaggio bordo scudo inferiore Vespa Lx-Lx

FL 2T-4T 50-125-150 - Vespa S 2T-4T 50-125-150

Applicazioni varie - *Various applications:*

Beverly-Fly-Free-Liberty-Nrg-Skipper-X9-Zip-

Porter

Confezione 100 pz. - 100 Pcs Packing



12 186 0220 

PIASTRINA PER VITE AUTOFILETTANTE

Ø 4,2 mm

SELF THREADING PLATE Ø 4,2 mm

Applicazioni varie - *Various applications:*

Beverly-Carnaby-Fly-Free-Hexagon-Liberty

-Mp3-Nrg-Sfera-Skipper-Vespa Et2-Et4-Grantu-

rismo-Gts-Gtv-Lx-Vespa S 2T-4T-X Evo-X7-X8-

X9-Zip-Typhoon-Ape Calessino -Car-MP601-

Poker Benzina/Diesel

Confezione 100 pz. - 100 Pcs Packing



12 186 0230 

PIASTRINA BRUNITA PER VITE

AUTOFILETTANTE Ø 4,2 mm

SELF THREADING PLATE Ø 4,2 mm

Applicazioni varie - *Various applications:*

Beverly-Carnaby-Fly-Liberty-Mp3-Nrg-Vespa

Granturismo Gts-Vespa Lx-Vespa S 2T/4T-X Evo-

X7-X8-X9 Evolution-Zip 2T/4T-Ape Tm D Lcs

Confezione 100 pz. - 100 Pcs Packing



12 186 0240 

PIASTRINA PER VITE M 6 - PLATE M 6

Applicazioni varie - *Various applications:*

Beverly-Carnaby-Diesis-Fly-Free-Hexagon-

Liberty-Mp3-Nrg-Ntt-Sfera-Skipper-Skr-Vespa-

Granturismo-Lx-Lxv-Vespa S 2T/4T-X-Evo-X7-

X8-X9-Zip-Ape Rst Mix-Poker Benzina-Tm D

Lcs-Porter

Confezione 100 pz. - 100 Pcs Packing





RUBINETTI BENZINA

FUEL COCKS

12 167 0020



GILERA		
Easy Moving	50	95-96
Ice	50	01
Stalker	50	97-01
Storm	50	94-95
Typhoon - Typhoon X	50	98-99
Typhoon Xr	50	00
Typhoon	125	95-98
Typhoon X-Xr	125	99-00

MALAGUTI		
Crosser Cr1	50	95-98
Yesterday - Yesterday EU	50	97-00
F10 Jet Line-Kat-Restyling	50	92-02
F10 Restyling EU 2-2.3	50	02-03
F12 Phantom Lc Twin Disks	50	98
F12 Phantom-Phantom Lc	50	94-98
F12 Phantom EU 1 - Lc	50	99-00
F12 Phantom Restyling-Lc	50	01-02
F12 Phantom Rest. EU 2-Lc	50	02
F12 Phantom Rest. EU 2-2,3	50	03
F12 Phant. Lc Res. EU 2-2.3	50	03
F15 Fire Fox - Fire Fox EU 2	50	96-03
F15 Fire Fox T. D. & Special	50	98-99
F15 Fire Fox T. D. Digit Kat	50	98-00
F15 Lc-Tds Restyling EU 1	50	01
F12 Phantom - (R.O. 09304500)	100	99-00

MBK		
Nitro	50	97-98
Ovetto R - R Eu1- Eu2	50	97-03

PIAGGIO		
Free - Free Delivery - FL	50	00-01
Liberty	50	97-02
Nrg Rst Mc2 - Ntt	50	96-98
Nrg Extreme - Mc3	50	99-02
Vespa Et2 - Et2 iniezione	50	97-01
Sfera Rst	50	95-97
Sfera base	50	91-93
Sfera Maquillage 2	50	94
Quartz	50	92-96
Typhoon	50	01
Zip & Zip Bimodale	50	94-97
Zip Base - Rst - Sp	50	92-00
Zip Fast Raider - Rst	50	93-97
Skr City	80	99
Vespa Et4	125	96-99
Liberty	125	98-00
Sfera	125	95-97
Skipper - Skipper Lx - (R.O. 575331)	125-150	94-99

YAMAHA		
Aerox	50	97-98
Neo's R - Neo's EU 2 - (R.O. 5ADF45000000)	50	97-03



12 167 0240



MALAGUTI		
Madison	125	99-01
Madison T	150	99-01
Madison Restyling - (R.O. 09305900)	125	02

MBK		
Skyliner	125	98-00
Skyliner	150	00

YAMAHA		
Majesty	125	98-00
Majesty - (R.O. 5DSF450000)	150	00



12 167 0260



HONDA		
Sh		50
Scoopy		125-150

BAOTIAN-SCOOTER CINESI		
Serbatoio in metallo		50



12 167 0220



GILERA		
Dna	50	00-01
Runner	50	97-00
Dna	125-180	01
Runner vx-Vxr	125-180-200	00-02

PIAGGIO		
Free - (R.O. 577881)	100	02



12 167 0270



HONDA		
Sh		125-150



12 167 0250



MBK 50:		
Cw Booster		90-04
Cwr Booster Road		94-95
Ye Evolis		92-95
Ym Fizz		94-95
Cw Booster Spirit		96-00
CWL Booster		01-03
Cw Sp Booster Spirit Eu2		02
Cw Booster Spirit Eu2		02-03
CWL Booster Spirit		03
CW Booster Naked		03

YAMAHA 50:		
Ym Breeze		94-95
Bw's Original		97-02
Bw's R		01
Cw Sp Bw's Original Eu2		02
Cw Bw's Original Eu2		02-03
CWL Bw's		03
Bw's Naked		03





12 167 0230 

PIAGGIO:		
Liberty 4T	50	00-02
Vespa Et2	50	97-01
Vespa Et4	50	00-02
Zip - Zip Sp	50	01-02
Zip 4	50	00
Liberty	125	98-00
Liberty	125-150	00-02
Vespa Et4	125-150	99-02
Skipper 4T	125-150	00/-02
Vespa Granturismo	125-200	03
Zip - (R.O. 575321)	125	00
Boulevard	125	02-04
Boulevard Eu2	125	04-07
Boulevard 2T	50	09-14
Boulevard 4T	100	10-11
Boulevard 4T E3	150	10
Boulevard 4T Eu2 25 K/h	50	09
Boulevard 4T Eu3	125	08-12
Boulevard Eu2	200	05-06
Gp1 Eu2	50	05
Gp1 Race Eu2	50	05-07
Sonar 2T	50	09
Sonar 4T	125	09-11
Sonar 4T	150	09
Variant Sport 2T	50	12
Variant Sport 4T E3	125	12

12 167 0090 

PIAGGIO:	
Ciao - Sc - Px - FL - Teen - (R.O. 143559)	50



12 171 0010 

SONDA RISERVA - FUEL SENSOR

GILERA:		
Easy Moving	50	95-96
PIAGGIO:		
Zip & Zip Bimodale	50	94-97
Zip Base	50	92-96
Zip Rst	50	96-99
Zip Fast Raider Rst	50	96-97
Zip fast Raider	50	93-94
Zip Sp - (R.O. 259346)	50	96-00



12 167 0170 

PIAGGIO: (Senza Riserva - Without reserve)		
Vespa Pxe Arcobaleno	125-150-200	81-97
Vespa Px T5	125	85-89
Vespa Px - (R.O. 217872)	125-150-200	98-01

12 167 0150 

PIAGGIO:	
Vespa Et3 - (R.O. 139938)	50-125

12 167 0050 

PIAGGIO: (Con Riserva - With reserve)		
Vespa Px	125-150-200	77>
(R.O. 158793)		



12 167 0180 

PIAGGIO:		
Ape P	50	80-85
Tm P - (R.O. 118092)	50	85-89



12 167 0190 

PIAGGIO:		
Ape FL - FL2	50	89-95
Ape Rst Mix	50	99-03
Ape FL3 Europa	50	96-99
Ape Tm P602	220	82-83
Ape Tm P703/P703V/FL2 - (R.O. 189320)	220	84-01



12 167 0200 

PIAGGIO:		
Ape MP P501 / P601 - (R.O. 118422)	220	78-96





RUBINETTI BENZINA

FUEL COCKS

12 167 0080



PIAGGIO:

Si - Si FL2 - Si Mix - (R.O. 254724) 50 79-99

12 167 0010



STANDARD:

Ciclomotore / Moped Ø 10 x 1

12 167 8023



Vespa Old Model
Con vaschetta in alluminio
With aluminium bowl

12 167 8033



Vespa Old Model
Con vaschetta in vetro
With glass bowl



ASTA RUBINETTO - FUEL TAP LEVER

12 168 0020



ASTA RUBINETTO - FUEL TAP LEVER

PIAGGIO: Px Pe-Px Pe Arcobaleno
Lunghezza 175 mm. - *Lenght 175 mm.*
(R.O. 103202)

12 168 0040



ASTA RUBINETTO - FUEL TAP LEVER

PIAGGIO: Vespa 50-90-125 Primavera Et3
Lunghezza 200 mm. - *Lenght 200 mm.*
(R.O. 098514)



12 183 0040



**GOMMINO ASTA RUBINETTO
FUEL ROD RUBBER**

PIAGGIO 125-150-200: Vespa Px • Px E
(R.O. 194631)

12 183 0340



**GOMMINO ASTA RUBINETTO NERO
FUEL ROD RUBBER (BLACK COLOUR)**

12 183 0341



**GOMMINO ASTA RUBINETTO GRIGIO
FUEL ROD RUBBER (GREY COLOUR)**

PIAGGIO: Vespa 50-90-Primavera Et3
V5A1-V5B1-V5B2-V5SA1-V9A1-VMA2-VMB1
(R.O. 132538-047460)

12 183 0530



**GUARNIZIONE RUBINETTO BENZINA
FUEL TAP GASKET**

PIAGGIO: Vespa 50-90-125 Primavera -Et3-150
GL-Gs-160 Gs-180 Ss
V5A-V5A1T-V5SS1T-V9A1T-V9SS1T-V33TVM1/
2T-VU1T-VN1/2T-VNA1T-VNB1/2/3/4/5/T-VNC1T-
VMA1T-VNL2T-VB1T-VBA1-VBB1TVBC-VLA1T-
VS1T-VSB1T-VSC1T
(R.O. 13836)





TUBO PER BENZINA - FUEL HOSE

PVC PLASTIFICATO • 63ShA - PLASTIFIED PVC • 63ShA



12 169 0010 

Miscelatore - Ø 2,2 x 4 - mt. 5
Mixer oil hose

12 169 0080 

Miscelatore Ø 2,5 x 5 - mt. 5
Mixer oil hose

12 169 0020 

Scarico residui benzina - Ø 3 x 5 - mt. 5
Fuel surplus hose

12 169 0030 

Ciclomotore - Ø 4 x 7 - mt. 5 - *Moped*

12 169 0039 

Ciclomotore - Ø 4 x 7 - mt. 50 - *Moped*

12 169 0040 

Scooter - Ø 5 x 10 - mt. 5 - *Scooter*

12 169 0049 

Scooter - Ø 5 x 10 - mt. 50 - *Scooter*

12 169 0050 

Moto - Ø 6 x 9 - mt. 5 - *Motorbike*

12 169 0059 

Moto - Ø 6 x 9 - mt. 50 - *Motorbike*

12 169 0060 

Vespa e auto - Ø 7 x 12 - mt. 5 - *Vespa and car*

12 169 0069 

Vespa e auto - Ø 7 x 12 - mt. 50 - *Vespa and car*

12 169 0070 

Scooter Piaggio - Ø 7 x 14 - mt. 5
Scooter Piaggio

12 169 0090 

Ø 5 x 7 - mt. 5

TUBO PER BENZINA VERDE - UNLEADED FUEL HOSE

PVC + 30% PU • 65ShA • SPECIFICO PER BENZINA VERDE ED OLIO - SPECIFIC FOR UNLEADED FUEL AND OIL



12 169 0031 

Ciclomotore - Ø 4 x 7 - mt. 5 - *Moped*

12 169 0041 

Scooter - Ø 5 x 10 - mt. 5

12 169 0051 

Moto - Ø 6 x 9 - mt. 5 - *Motorbike*

12 169 0061 

Vespa e auto - Ø 7 x 12 - mt. 5 - *Vespa and car*

12 169 0071 

Scooter Piaggio - Ø 7 x 14 - mt. 5

12 169 0091 

Ø 5 x 7 - mt. 5

MISURINI CENTILTRATI - DOSAGE BEAKERS

14 274 0010 

Misurino centilitrato da 10 cl.
Oil dosage beaker 2% - 10 cl.
(R.O. 085058)



14 274 0020 

Misurino centilitrato da 10 cl.
Doppia centilitratura 2/4%
Dosage beaker 2/4% 10 cl.
(Con coperchio)



12 168 0060 

Raccordo rapido tubo benzina 6 mm
6 mm fuel hose quick connector

12 168 0070 

Raccordo rapido tubo benzina 8 mm
8 mm fuel hose quick connector





POMPE BENZINA
FUEL PUMPS

12 166 0030



SUZUKI 250 : Burgman 03-06

400: Burgman 03-06

Pressione di esercizio 3 Bar - Working pressure 3 Bar

Portata 100 l/h - Flow 100 l/h

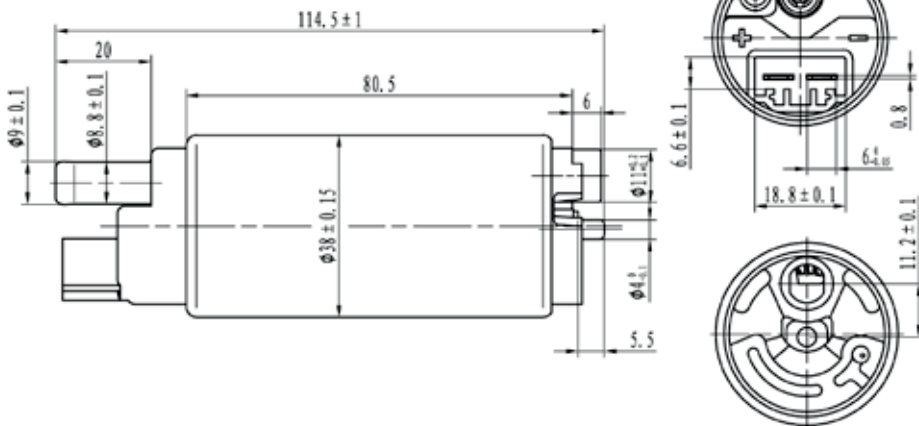

12 166 0040



SUZUKI 125 : Burgman 07-12 • Ux Sixteen 08-11

YAMAHA 125 : X-Max 08-12

250: X-Max 07-12

400: Majesty 04-11

500: T-Max 04-11

530: T-Max 12-16

Pressione di esercizio 3 Bar - Working pressure 3 Bar

Portata 35 l/h - Flow 35 l/h

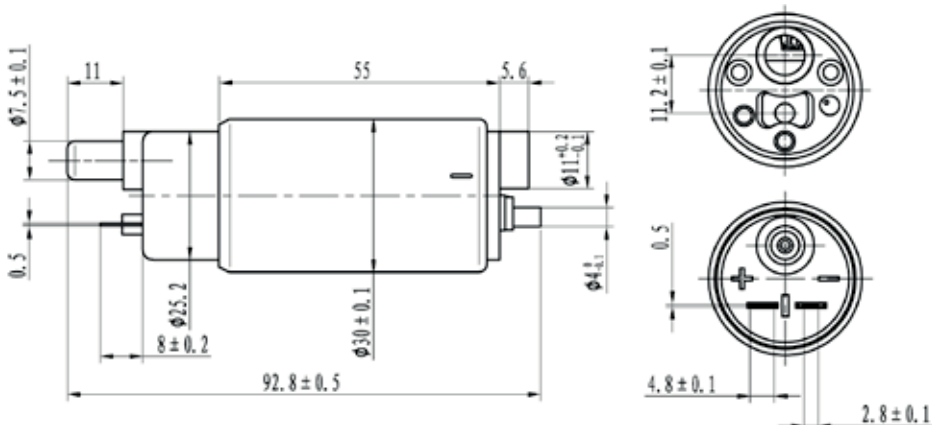

12 166 0050



APRILIA 400-500: Scarabeo Light 06-08

1000: Rsv 98-05 • SL Falco 00-03 • Etv Capo Nord 01-07

PIAGGIO 400: Beverly Eu3 06-07 • Beverly Tourer 08-10

500: Beverly 02-06 • Beverly Cruiser 07-12

• Beverly Eu3 06-08

PEUGEOT 400: Geopolis

500: Satelis

Pressione di esercizio 3 Bar - Working pressure 3 Bar

Portata 100 l/h - Flow 100 l/h

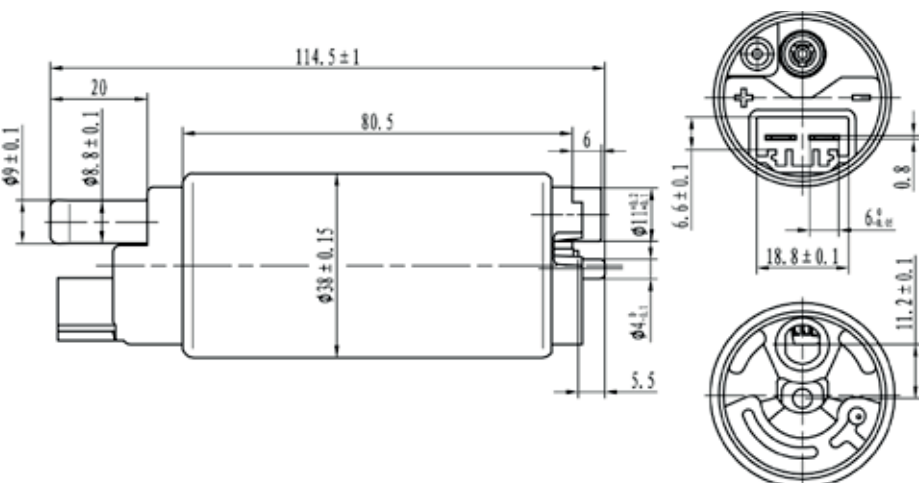



12 166 0060

APRILIA 125: Rs4 11-13 • Sr Max 11-13
250: Scarabeo Light 06-08 • Sportcity Cube le 08-10
300: Scarabeo Light le 09-10 • Sportcity Cube le 09-10 • Sportcity Street 12 • Sr Max 11-13
GILERA 125: Nexus Eu3 le 08-10
300: Nexus Eu3 08-11
DERBI 250: Gp1 Low Seat Eu3 07-08
300: Rambla 10-11
HUSQVARNA 630: Te • Sms
MALAGUTI 125: Blog le 09-11 • Centro le 08-09 • Centro SL 09-11
160: Blog le 09-11 • Centro le 09-11 • Centro SL 09-11
250: Password Eu3 07-08
PEUGEOT 250: Modelli Motore Piaggio (Piaggio Engine Models)
PIAGGIO 125: Beverly Rst 4T 4V le Eu3 10-13 Vespa Gts 4T le Super 09-13 • Vespa Lx 4T 3V le Touring 12-13 • Vespa Lx 4T Eu3 Touring 10-11 • Vespa Lx Eu3 le 09-11 • Vespa Lxv 4T le 10-12 • Vespa S4T 3V le 12 • Vespa S4T le & College 09-11

150: Vespa Lx 4T 3V le Touring 12-13 • Vespa Lx Eu3 le 09-11 • Vespa Lx Touring 10-12 • Vespas 4T le & College 09-12
250: Beverly Cruiser 07-09 • Beverly le Eu3 06-08 Beverly Mic Eu3 07 • Beverly Sport 06-08 • Carnaby 08 • Mp3 06-08 • X8 Eu3 05-08
300: Beverly Rst 4T 4V le Eu3 10-13 • Beverly Tourer Eu3 09-10 • Carnaby Cruiser 09-12
350: Beverly 4T 4V le Eu3 Sport Touring 11-13 • Vespa Gts le 12-13 • Vespa Gts le Touring 11-12 • Vespa Gts Super 08-13 • Vespa Gts Super Sport 10-13 • Vespa Gtv Montenapoleone 10 • Vespa Gtv 4T 4V le 10-13
Senza cablaggi - No wires
 Pressione di esercizio 3 Bar - Working pressure 3 Bar
 Portata 35 l/h - Flow 35 l/h
 (R.O. 640516)

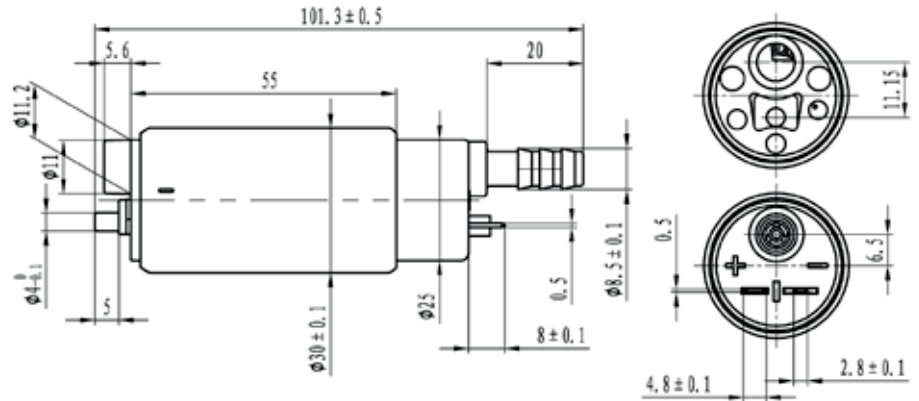

12 166 0070

SUZUKI 400: Burgman 07-14
 Pressione di esercizio 3 Bar - Working pressure 3 Bar
 Portata 60 l/h - Flow 60 l/h

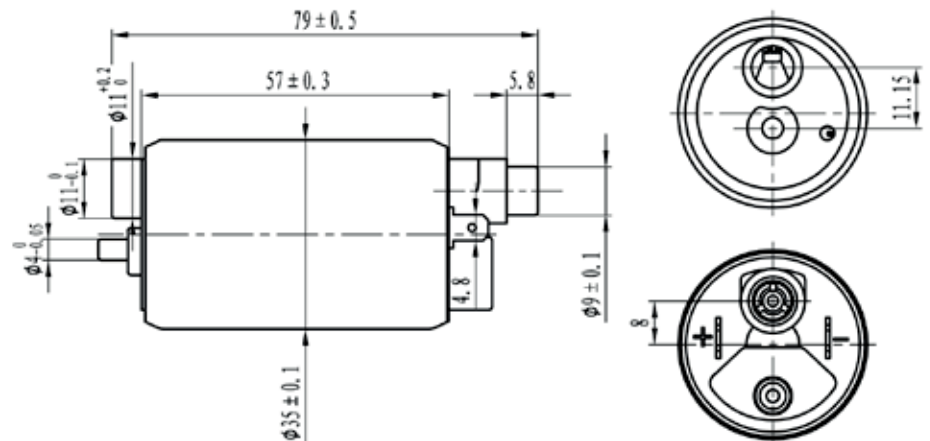



POMPE BENZINA FUEL PUMPS

12 166 0080



HONDA 125-150-300: Sh 05-12

KAWASAKI 650: Er6-F 06-11 • Er6-F Abs 06-11 •
Er6-N 06-11 • Er6-N Abs 06-11 • Kle Versys 07-13
Kle Versys Abs 07-13

Pressione di esercizio 3 Bar - Working pressure 3 Bar
Portata 35 l/h - Flow 35 l/h

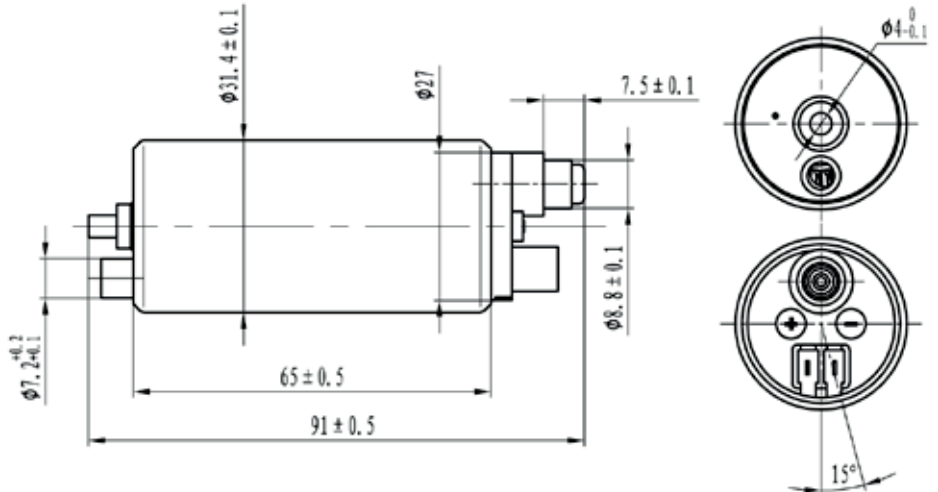

12 166 0090



NEW

BMW 750: K75 86-96 • K75 C 85-90 • K75 Rt 86-05
K75 S 86-95 • K75 S Spezial 86-88

1000: K1 89-93 • K100 84-90 • K100 Lt 87-91
K100 Rs 84-92 • K100 Rt 84-89 • K1100 Lt 92-97
K100 Lt Limited 90-91

1100: K1100 Lt Cat Con. 89-96 • K1100 Lt Cat
Con. Abs 89-96

DUCATI 888: 888 87-93

907: 907 le 87-93

Pressione di esercizio 5 Bar - Working pressure 5 Bar
Portata 100 l/h - Flow 100 l/h

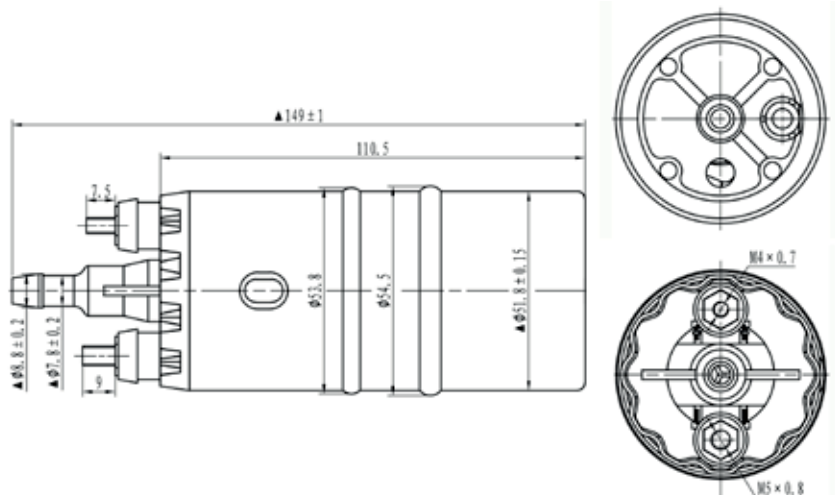

12 166 0100



NEW

BMW 750: K75 86-96

850: R 850 R 96-97

1100: R 1100 Gs 94-07 • R 1100 R 95-01

• R 1100 Rs 92-01 • R 1100 Rt 95-02 • R 1100 S 97-05
K 1100 Lt 92-97 • K 1100 Rs 93-96

1150: R 1150 Adventure 02-06 • R 1150 Gs 99-04
R 1150 Rs 01-04 • R 1150 Rt 00-06

1200: K 1200 Gt 02-05 • K 1200 Lt 97-09 • K 1200
Rs 96-05 • R 1200 C 96-05 • R 1200 C lindep. 01-04
R 1200 CL 02-05 • R 1200 Mountack 03-05

Pressione di esercizio 3 Bar - Working pressure 3 Bar
Portata 100-130 l/h - Flow 100-130 l/h

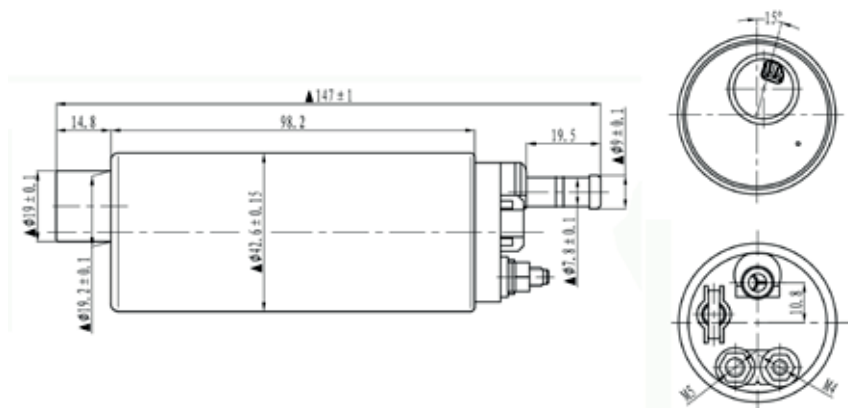



12 166 0110  **NEW**

BMW 650: F 650 Gs 01-12 • F 650 Cs 01-05 • G 650 Gs 09-14 • G 650 X 07-09
700: F 700 Gs 08-14
800: F 800 Gs 08-14 • F 800 Gt 13-14 • F 800 R 09-13 • F 800 St 06-12
900: R 900 Rt 05-10
1000: HP4 13-14 • S 1000 Rr 09-14
1150: R 1150 R 01-06
1200: HP2 06-10 • K 1200 Gt 04-08 • K 1200 R 05-10 • R Nine T 14 • R 1200 Gs 04-14 • R 1200 R 06-14 • R 1200 Rt 06-14 • R 1200 S 06 • R 1200 St 05-07
1300: K 1300 Gt 09-10 • K 1300 R 09-10 • K 1300 S 09-14
1600: K 1600 Gt 11-14 • K 1600 GTL 11-14
 Pressione di esercizio 3 Bar • Working pressure 3 Bar
 Portata 120 l/h • Flow 120 l/h

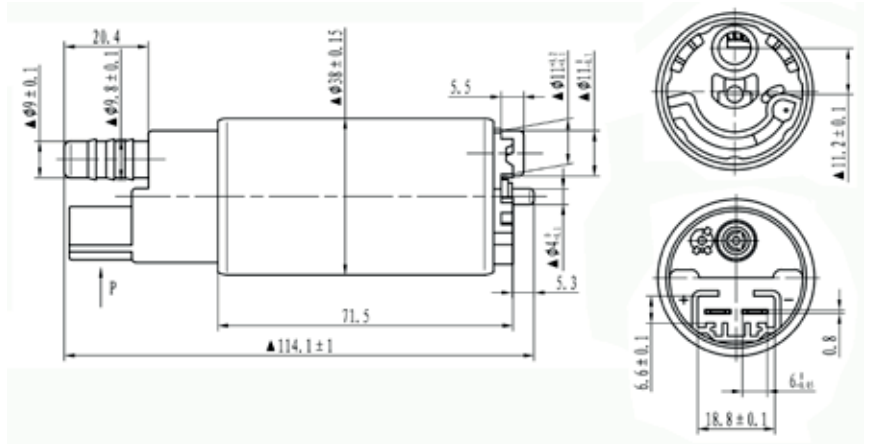

12 166 0010 

BETA 50: Tempo 94-99 • Quadra-Chrono 502 95-99
GILERA 50: Runner Poggiali 02 • Runner Sp 02-04 • Runner 97-00
125: Runner Fx-Fxr 97-02 • Typhoon X-Xr 99-00 • Typhoon 95-98 (R.O. 82592R)
MALAGUTI 50: Ciak Master Eu2 06 • Ciak Master 04 • Ciao Mono Eu2 2,3 03 • Ciak Mono Eu2 03 • Ciak Td 00-01 • Ciak 99-00 (R.O. 09305700)
PIAGGIO 125: Hexagon 94-97 (R.O. 82592R)



12 166 0020 

GILERA 50: Dna Gp Experience 03-04 • Dna 00-07 • Runner Purejet St 08 • Runner Purejet 05-11 • Runner Sp Special Edition 07 • Runner Sp St & Simoncelli 08-09 • Runner Sp 05-12
125: Runner 4T St Eu3 08-16 • Runner Vx Race 06 • Runner Vx Sc 06-07 • Runner Vx-Vxr 02-04 • Runner Vx 05-06
200: Runner Vxr 4T St Eu3 08-11 • Runner Vxr Eu3 07 • Runner Vxr Race 05-06 • Runner Vxr 05-06 (R.O. CM120901)
PIAGGIO 50: Fly 4T 2V 25-30 Km-h 12-17 • Fly 4T 2V 13-15 • Fly 4V 12-13 • Nrg Power Dd Serie Speciale 07-12 • Nrg Power Dd 05-06 • Nrg Power Dt Serie Speciale 07-08 • Nrg Power Dt 06 • Nrg Power Purejet 04-11 • Nrg Purejet 10
125: Beverly Rst 04-07 • Beverly 01-03 • Hexagon Gtx 00 • Hexagon Lx-Lxt 98-99 • Hexagon Lx4 98-99 • Mp3 06-08 • Super Hexagon Gtx 12 01-02 • Vespa Granturismo Eu3 06-07 • Vespa Granturismo 03-07 • Vespa Gtv 06-08 • X Evo 07-16 • X8 Premium Eu2 06 • X8 Premium Eu3 06-07 • X8 Street Eu2 06-07 • X8 04-06 • X9 Evolution 03-06 • X9 01-02
150: X8 Street Eu2 06-08
180: X9 Amalfi 00-03
200: Vespa Granturismo 06-07 • X8 05-07 • X9 Evolution 03 • X9 02-03
250: Beverly Rst 04-05 • Beverly 06-07 • X9 Evolution 04-06 (R.O. CM120901)



10 011 0050 

POMPA OLIO-OIL PUMP
MISCELATORE SCOOTER
MINARELLI • MBK • YAMAHA 50cc





TAPPI BENZINA - OLIO MOTORE

FUEL CAP - OIL FILLER CAP

12 165 0010 

TAPPO SERBATOIO BENZINA - FUEL CAP

MBK: Nitro 50 97-02

YAMAHA: Aerox 50 97-02



12 165 0030 

TAPPO SERBATOIO BENZINA

(CON GUARNIZIONE)

FUEL CAP (WITH GASKET)

PIAGGIO: Ciao P • Px

(R.O. 182356)



12 165 0042 

TAPPO SERBATOIO - FUEL CAP

PIAGGIO 50: Vespa FL • N • Pk

125-150-200: Vespa Px • T5

(R.O. 575825)



12 165 0053 

TAPPO OLIO MISCELATORE

OIL TANK CAP

PIAGGIO 125-150-200:

Vespa Px Arcobaleno-T5

(R.O. 102585)



12 165 0063 

KIT TAPPO SERBATOIO

KIT TANK CAP



12 185 6070 

TAPPO SCARICO OLIO MOTORE

ENGINE OIL CUP

Conf. 20 pz. - 20/Pcs Packing

PIAGGIO-GILERA:

Scooter 50-125-150 • Typhoon

Hexagon Lx4 • Sfera-Liberty

Et4 • Skipper • Hexagon

Vespa 50-125-150-200

Ape 50

(R.O. 138345)



12 185 6140 

TAPPO OLIO - OIL FILLER CAP

HONDA 150: Sh

(R.O. 12361-KGF-305)

Conf. 5 pz. - 5/Pcs Packing



12 186 0010 

TAPPO OLIO - OIL PLUG

Vari Modelli Vespa - Various Vespa Models

(R.O. 030280)



12 183 0300 

GUARNIZIONE TAPPO BENZINA

GASKET FUEL CAP

PIAGGIO: Vespa Px 125-150 • P 200

VNX-VLX-VBX -T5 VNX5T

Vespa 125

VN1-VN2-VNA-VNB

(R.O. 002319)

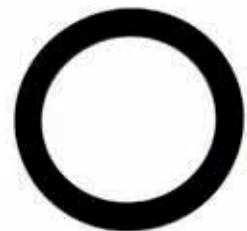

12 183 0370 

GUARNIZIONE TAPPO BENZINA

GASKET FUEL CAP

PIAGGIO: Vespa 50-90-Primavera Et3

V5A1-V5B1-V5B2-V5SA1-V9A1-VMA2-VMB1

(R.O. 071734)





16 368 0004



NEW

16 368 0014



NEW

16 368 0044



NEW

CONTACHILOMETRI - SPEEDOMETER

PIAGGIO 50: Vespa N - L - R
Scala 80 Km/h
Completo di trasmissione
e pignoncino rocchetto
With pinions and transmission
(R.O. 190748)



CONTACHILOMETRI - SPEEDOMETER

PIAGGIO 50: Vespa Special Elestart
Scala 80 Km/h
Completo di trasmissione
e pignoncino rocchetto
With pinions and transmission
(R.O. 123474)



CONTACHILOMETRI - SPEEDOMETER

PIAGGIO 200: Vespa Rally
Scala 120 Km/h
Completo di trasmissione
e pignoncino rocchetto
With pinions and transmission
(R.O. 141712)



16 368 0074



NEW

16 368 0093



NEW

16 368 0094



NEW

CONTACHILOMETRI - SPEEDOMETER

PIAGGIO 125: Vespa Primavera
Scala 120 Km/h
Completo di trasmissione
e pignoncino rocchetto
With pinions and transmission
(R.O. 121051)



CONTACHILOMETRI - SPEEDOMETER

PIAGGIO 125-150-200: Vespa PX
Scala 120 Km/h
Completo di trasmissione
e pignoncino rocchetto
With pinions and transmission
(R.O. 190523)



CONTACHILOMETRI - SPEEDOMETER

PIAGGIO 125-150-200: Vespa PX 1° Serie
Scala 120 Km/h
Completo di trasmissione
e pignoncino rocchetto
With pinions and transmission



16 368 0104



NEW

16 368 0114



NEW

16 368 0123



NEW

CONTACHILOMETRI - SPEEDOMETER

PIAGGIO 50: Vespa N - L - R
Scala 60 Km/h
Completo di trasmissione
e pignoncino rocchetto
With pinions and transmission



CONTACHILOMETRI - SPEEDOMETER

PIAGGIO 150: Vespa GL
Scala 100 Km/h
Completo di trasmissione
e pignoncino rocchetto
With pinions and transmission
(R.O. 089377)



CONTACHILOMETRI - SPEEDOMETER

PIAGGIO 150-160: Vespa Gs
Scala 120 Km/h
Completo di trasmissione
With transmission
(R.O. 098473)





CONTACHILOMETRI SPEEDOMETER

TRASMISSIONI PER KIT CONTACHILOMETRI - TRANSMISSIONS FOR SPEEDOMETER KIT

CC	MODELLO - MODEL	CODICE RMS - RMS CODE	RIF. ORIGINALE - OEM CODE
50-90-125	Vespa Primavera Modifica-Modified Per contaKm-For Speedometer: 16 368 0004 - 16 368 0014 16 368 0074 - 16 368 0104	16 363 1011 NEW	-
125-150-200	Vespa Px - Vespa Px 1° serie Modifica-Modified Per ContaKm-For Speedometer: 16 368 0093 - 16 368 0094	16 363 1051 NEW	-
150	Vespa GL Modifica-Modified Per ContaKm-For Speedometer: 16 368 0114 - 16 368 0044	16 363 1901 NEW	-
150	Vespa Gs Modifica-Modified Per ContaKm-For Speedometer: 16 368 0123	16 363 2131 NEW	-

16 368 0023



CONTACHILOMETRI - SPEEDOMETER

Vespa 125
VNA-VNB
Scala 90 Km/h
(R.O. 083205)



16 368 0033



CONTACHILOMETRI - SPEEDOMETER

Vespa 125 Struzzo
Scala 100 Km/h
Grigio - Grey



16 368 0053



CONTACHILOMETRI - SPEEDOMETER

Vespa 125-150
Scala 100 Km/h
Verde - Green
(R.O. 015019)



16 368 0063



CONTACHILOMETRI - SPEEDOMETER

Vespa 125
Scala 90 Km/h
Nero - Black





16 368 0303 

TRASPARENTE CONTACHILOMETRI
SPEEDOMETER TRANSPARENT

Vespa 125-150
V30T-V33T-VM1/2T
VN1/2T-VL1/2/3T
(R.O. 017713)



16 368 0313 

TRASPARENTE CONTACHILOMETRI
SPEEDOMETER TRANSPARENT

Vespa 150 VB1T
Vespa 150 Gs VS1/2/3/4T
(R.O. 024818)



16 368 0323 

TRASPARENTE CONTACHILOMETRI
SPEEDOMETER TRANSPARENT

Vespa 125
VNA1/2T-VNB1/2/3/4/5/6T
(R.O. 083202)



16 368 0333 

TRASPARENTE CONTACHILOMETRI
SPEEDOMETER TRANSPARENT

Vespa 125: VNL2
Vespa 150 GL: VLA-VBA1-VBB1T
Vespa 150 Gs: VS5T
Vespa 160 Gs: VSB1T
Vespa 180 Ss: VSC1T
(R.O. 084803)



16 368 0343 

TRASPARENTE CONTACHILOMETRI
SPEEDOMETER TRANSPARENT

Vespa 125 Primavera VMA2T
(R.O. 100619)



16 368 0353 

TRASPARENTE CONTACHILOMETRI
SPEEDOMETER TRANSPARENT

Vespa 50 Special V5B3T
(R.O. 610356M)



16 368 0203 

CORNICE CONTACHILOMETRI
SPEEDOMETER RING

Vespa 125 VNA-VNB
(R.O. 83204)



16 368 0213 

CORNICE CONTACHILOMETRI
SPEEDOMETER RING

Vespa 50 Special V5A2/3-V5B1/2/3
(R.O. 610355M)



16 368 0223 

CORNICE CONTACHILOMETRI
SPEEDOMETER RING

Vespa 125 V30



16 368 0233 

CORNICE CONTACHILOMETRI
SPEEDOMETER RING

Vespa 125 Primavera
150 Super-Gtr-Ts • Sprint-Rally
(R.O. 151837)



16 368 0243 

CORNICE CONTACHILOMETRI
SPEEDOMETER RING

Vespa 125: VNL2
Vespa 150 GL: VLA-VBA1-VBB1T
Vespa 150 Gs: Vs5T
Vespa 160 Gs: VSB1T
Vespa 180 Ss: VSC1T
(R.O. 084202)



14 268 0410 

COPERCHIO CONTACHILOMETRI
SPEEDOMETER COVER

PIAGGIO 50: Vespa Special Elestart
(R.O. 123678)





PARAFANGHI
MUDGUARDS

14 268 0070 

PARAFANGO ANTERIORE PIAGGIO
STEEL FRONT MUDGUARD
PIAGGIO 50-125: Vespa Primavera Et3
(R.O. 183680)



14 268 0080 

PARAFANGO ANTERIORE PIAGGIO
STEEL FRONT MUDGUARD
PIAGGIO: Vespa Px-Pe
(R.O. 1774976)



14 268 0120 

PARAFANGO POSTERIORE PLASTICA CON
SAGOMA PORTATARGA
PLASTIC REAR MUDGUARD WITH PLATE
HOLDER
PIAGGIO: Pk 82-84 Si FL2
(R.O. 924800)



14 268 0140 

PARAFANGO ANTERIORE PIAGGIO
STEEL FRONT MUDGUARD
PIAGGIO: Vespa Sprint Veloce
(R.O. 120604)



14 268 0150 

PARAFANGO ANTERIORE PIAGGIO
STEEL FRONT MUDGUARD
PIAGGIO 50: Pk XL Plurimatic 85-90
• Pk XL Rush 88-89 • Pk XL 85-88
50-125: Pk 82-84
125: Pk XL 86-89
(R.O. 226754)



14 268 0130 

PARAFANGO ANTERIORE PIAGGIO
STEEL FRONT MUDGUARD
PIAGGIO 125-150-200: Vespa Px Freno a
disco - Brake disc Px 98-01
Px 30 anni 07-08
(R.O. 5638116)



14 268 0200 

PARAFANGO ANTERIORE
FRONT MUDGUARD
PIAGGIO 50: Ciao Px
(R.O. 187170)



14 268 0210 

PARAFANGO POSTERIORE
REAR MUDGUARD
PIAGGIO 50: Ciao Px
(R.O. 188095)



14 268 0220 

PARAFANGO ANTERIORE INOX
FRONT MUDGUARD INOX TYPE
PIAGGIO 50: Ciao Px
(R.O. 233678)



14 268 0230 

PARAFANGO POSTERIORE INOX
REAR MUDGUARD INOX TYPE
PIAGGIO 50: Ciao Px
(R.O. 188746)



14 268 0240 

PARAFANGO ANTERIORE
FRONT MUDGUARD
PIAGGIO 50: Si • FL2
(R.O. 267651)



14 268 0320 

PARAFANGO ANTERIORE
FRONT MUDGUARD
PIAGGIO 50: Vespa Et4 00-05 • Vespa Et2 97-05
• Vespa Et2 Iniezione 97-00 •
125: Vespa Et4 96-02
(R.O. 8249005)





14 268 0330 

PARAFANGO ANTERIORE
FRONT MUDGUARD

PIAGGIO VESPA 50: N 89-90 • FL2 Hp 91-97 • FL2 Automatica 90-91 • FL 90 • **125:** FL 89-90 (R.O. 911100)



14 268 0340 

PARAFANGO ANTERIORE
FRONT MUDGUARD

PIAGGIO VESPA 50: Lxv 2T Navy 08 • Lxv 2T 06-09 • Lx 4T 4V Touring 10-13 • Lx 4T 4V 09-13 • Lx 4T 05-08 • Lx 2T Touring 30 Km 10-13 • Lx 2T 05-13 • **125:** Lxv ie 4T 10-13 • Lxv 4T Navy Eu3 07-08 • Lxv 4T Eu3 06-09 • Lx Eu3 ie 09-11 • Lx Eu3 06-08 • Lx 4T FL 09 • Lx 4T Eu3 Touring 10-11 • Lx 4T 3V ie Touring 12-13 • Lx 05-06 • Lx Touring 10-12 • Lx Eu3 ie 09-11 • Lx Eu3 06-08 • Lx 4T 3V ie Touring 12-13 (R.O. 666528)



14 268 0350 

PARAFANGO ANTERIORE
FRONT MUDGUARD

PIAGGIO VESPA 125: Gts Eu3 07-12 • Gts 4T ie Super 09-15 • Granturismo Eu3 06-07 • **250:** Gts 05-14 • **300:** Gts Super Sport 10-13 • Gts Super 08-15 • Gts ie Touring 11-15 (R.O. 651029)



14 268 0360 

PARAFANGO ANTERIORE
FRONT MUDGUARD

PIAGGIO: Liberty >04 Ruota 16" Stretta (R.O. 5749525)



14 268 0370 

PARAFANGO ANTERIORE
FRONT MUDGUARD

PIAGGIO: Liberty 04-08 Ruota 16" Larga



14 268 0380 

PARAFANGO ANTERIORE
FRONT MUDGUARD

PIAGGIO 125: Beverly Tourer Eu3 07-10 • **250:** Beverly Tourer Eu3 07-09 • Beverly Eu3 Mic 07 • Beverly Cruiser 07-09 • **300:** Beverly Tourer Eu3 09-10 • **400:** Beverly Tourer Eu3 08-10 • **500:** Beverly Cruiser 07-12 (R.O. 653588)



14 268 0390 

PARAFANGO ANTERIORE
FRONT MUDGUARD

PIAGGIO 125: Beverly Rst 4T 4V ie Eu3 10-15 • **350:** Beverly 4T 4V ie Eu3 Sport Touring 11-14 (R.O. 667197)



14 268 0510 

PARAFANGO ANTERIORE GREZZO
FRONT MUDGUARD RAW BLACK

HONDA 125-150: Sh 13-16



NEW

14 268 0520 

PARAFANGO ANTERIORE NERO METALLIZZATO
FRONT MUDGUARD BLACK METALLIZED PAINTED

HONDA 125-150: Sh 13-16

NEW





PARAFANGHI
MUDGUARDS

14 268 0530



NEW

PARAFANGO ANTERIORE BIANCO METALLIZZATO
FRONT MUDGUARD WHITE METALLIZED PAINTED
HONDA 125-150: Sh 13-16



14 268 0570



NEW

PARAFANGO ANTERIORE GREZZO NERO
FRONT MUDGUARD RAW BLACK
YAMAHA 125: X Max 14-16
250: X Max 14-16
400: X Max 13-17
(R.O. 37PF151100PB)



14 268 0580



NEW

PARAFANGO ANTERIORE GREZZO BIANCO
FRONT MUDGUARD RAW WHITE
YAMAHA 125: X Max 14-17
250: X Max 14-16
400: X Max 13-17
(R.O. 37PF151100PL)



14 268 0700



NEW

PARAFANGO ANTERIORE NERO METALLIZZATO
FRONT MUDGUARD BLACK METALLIZED PAINTED
YAMAHA 125: X Max 14-16
250: X Max 14-16
400: X Max 13-17
(R.O. 37PF151100PB)



14 268 0710



NEW

PARAFANGO ANTERIORE BIANCO METALLIZZATO
FRONT MUDGUARD WHITE METALLIZED PAINTED
YAMAHA 125: X Max 14-17
250: X Max 14-16
400: X Max 13-17
(R.O. 37PF151100PL)



14 268 0670



NEW

PARAFANGO ANTERIORE NERO GREZZO
FRONT MUDGUARD RAW BLACK
HONDA 300: Sh 07-16



14 268 0680



NEW

PARAFANGO ANTERIORE NERO METALLIZZATO
FRONT MUDGUARD BLACK METALLIZED PAINTED
HONDA 300: Sh 07-16



14 268 0690



NEW

PARAFANGO ANTERIORE BIANCO METALLIZZATO
FRONT MUDGUARD WHITE METALLIZED PAINTED
HONDA 300: Sh 07-16



14 266 0060



CRESTA PARAFANGO ALLUMINIO
ALLOY FENDER CREST
PIAGGIO 50: Vespa Special
(R.O. 124708)



14 266 0070



CRESTA PARAFANGO ALLUMINIO
ALLOY FENDER CREST
PIAGGIO 125-150-160 Vespa Gs
(R.O. 097214)



14 266 0080



CRESTA PARAFANGO ALLUMINIO
ALLOY FENDER CREST
PIAGGIO 50: Vespa
90-125: Vespa Primavera Et3
(R.O. 150070)





14 268 0250 

PIAGGIO 125-150-200: Vespa Px 1° serie
VNX-VLX-VSX
(R.O. 139829)



14 268 0260 

PIAGGIO 125-150-200: Vespa Pxe Arcobaleno
VNX-VLX-VSX-VNX2-VLX2-VSX2
(R.O. 904600)



14 268 0270 

PIAGGIO 125-150-200: Vespa Px 1° serie
(R.O. 174014)



14 268 0310 

PIAGGIO: Vespa Px freno a disco
(R.O. 6224306)



14 268 0430 

PIAGGIO 50-125: Vespa Pk
(R.O. 178933)



14 268 0440 

PIAGGIO 50: Vespa Pk
(R.O. 178637)



14 268 0450 

PIAGGIO 50-125: Vespa Pk XL
(R.O. 226730)



14 268 0460 

PIAGGIO 50: Vespa FL 90 • Vespa FL2 Automatica 90-91 • Vespa FL2 Hp 91-97
125: Vespa FL 89-90
(R.O. 921700)



14 268 0470 

PIAGGIO 50: Vespa Lx 2T Touring 30 Km 10-13 • Vespa Lx 2T 05-13 • Vespa Lx 4T-4V Touring 10-13 • Vespa Lx 4T-4V 09-13
125: Vespa Lx 4T 3V ie Touring 12-13 • Vespa Lx 4T Eu3 Touring 10-11 • Vespa Lx 4T FL 09 • Vespa Lx Eu3 ie 09-11 • Vespa Lx Eu3 06-08 • Vespa Lx 05-06 • Vespa Lx 05-06
150: Vespa It 4T 3V ie 14 • Vespa Lx 4T 3V ie Touring 12-13 • Vespa Lx 4T FL 09 • Vespa Lx Eu3 ie 09-11 • Vespa Lx Eu3 06-08 • Vespa Lx touring 10-12 • Vespa Lx 05-06
(R.O. 652935)



14 268 0480 

PIAGGIO 300: Vespa Gts
(R.O. 1B001185)



14 268 0490 

PIAGGIO 50: Liberty 4T 00-02 • Liberty 97-05 • Vespa Et2 Iniezione 97-00 • Vespa Et2 97-05 • Vespa Et4 00-05
125: Liberty 99-12 • Vespa Et4 96-02
(R.O. 4272005)



14 268 0513 

PARTE INFERIORE MANUBRIO
LOWER HANDLEBAR
Molli freno a disco - *Brake disc model*
PIAGGIO: Vespa Px • LML
(R.O. 5637895)

NEW





PARTICOLARI CARROZZERIA PIAGGIO

PIAGGIO BODYWORK PARTS

14 260 0010



CALANDRA STERZO
STEERING COLUMN COVER

PIAGGIO 50: Vespa Special • Revival
(R.O. 143593)



14 260 0011



CALANDRA STERZO
STEERING COLUMN COVER

PIAGGIO 50: Vespa Special • V581
(R.O. 143593)



14 260 0020



CALANDRA STERZO
STEERING COLUMN COVER

PIAGGIO 125-150-200: Vespa 1 serie
(R.O. 183779)



14 260 0050



CALANDRA STERZO
STEERING COLUMN COVER

PIAGGIO 50-125: Vespa Pk Plurimatic - Rush
(R.O. 9007005)



14 260 0060



CALANDRA STERZO
STEERING COLUMN COVER

PIAGGIO 50-125: Vespa Pk FL - FL2 Automatica
(R.O. 910000)



14 260 0070



CALANDRA STERZO
STEERING COLUMN COVER

PIAGGIO 125-150-200: Vespa Px Arcobaleno
(R.O. 219118)



14 260 0080



CALANDRA STERZO
STEERING COLUMN COVER

PIAGGIO 125: Vespa Px T5
(R.O. 232893)



14 260 0090



CALANDRA STERZO
STEERING COLUMN COVER

PIAGGIO 50-125: Vespa Pk
(R.O. 219564)



14 260 0100



NEW

CALANDRA STERZO
STEERING COLUMN COVER

PIAGGIO 50-125: Vespa Et2-Et4
(R.O. 4722005)





14 260 0110



NEW

14 260 0120



NEW

14 260 0300



NEW

CALANDRA STERZO
STEERING COLUMN COVER
PIAGGIO 50-125: Vespa Lx
(R.O. 6575885)



CALANDRA STERZO
STEERING COLUMN COVER
PIAGGIO 125-250-300: Vespa Gt-Gts-Gtv
(R.O. 621143)



GRIGLIA STERZO - STEERING COVER GRILL
PIAGGIO: Vespa 125 T5 VNX5
(R.O. 232894)



14 260 0040



MODANATURA CALANDRA
STEERING MOULDING
PIAGGIO 50: Vespa 50 Special- Elestart
V5B1-V5A3T
(R.O. 123576)



14 260 0200



GRIGLIA CALANDRA - HORN COVER GRILL
PIAGGIO 125-150: Vespa Px modello freno a
disco VNX2T-VLX1-VSX1T
(R.O. 564221)



14 260 0201



GRIGLIA PER CALANDRA VESPA NERA
HORN COVER GRILL BLACK COLOUR
PIAGGIO 125-150-200: Vespa Pxe Arcobaleno
(R.O.219119)



14 262 0050



COPERCHIO PLASTICA GRIGIO
GREY PLASTIC HUB COVER
PIAGGIO: Vespa Px
(R.O. 178048)



14 262 0051



COPERCHIO PLASTICA NERO
BLACK PLASTIC HUB COVER
PIAGGIO: Vespa Px
(R.O. 232927)



14 262 0040



COPERCHIO MOZZO-ALLUMINIO
ALUMINIUM HUB COVER
PIAGGIO 50-90-125: Vespa Primavera -Et3
V5A1-V5B1-V5B2-V5SA1-V9A1-VMA2-VMB1-
VMX1T
(R.O. 070177)





PARTICOLARI CARROZZERIA PIAGGIO

PIAGGIO BODYWORK PARTS

14 268 0090



PROTEZIONE POSTERIORE SCOCCA
REAR FRAME PROTECTION

PIAGGIO: Vespa Px • Pe Arcobaleno
(R.O. 219110)



14 268 0160



PROTEZIONE POSTERIORE SCOCCA
REAR FRAME PROTECTION

PIAGGIO 125-150-200: Vespa Pxe
VNX2-VLX2-VSX2
(R.O. 219110)



14 268 0190



NEW

PROTEZIONE SCOCCA
REAR FRAME PROTECTION

PIAGGIO: Vespa 125 Px 11-15 • Px 98-01 • Px
Eu2 01-07 • Px 30 Anni 07-08 • Vespa 150
Px 11-15
(R.O. 5769690090)



12 181 0033



GANCIO PORTABORSE NERO
BLACK BAG HOOK

PIAGGIO 125: Vespa T5 VNX5T
Nero/Black
(R.O. 227153)



12 181 0030



GANCIO PORTABORSA ZINCATO
HOO FOR BAG GALVANIZED

PIAGGIO: Vespa tutti i modelli
(R.O. 057468)



12 181 0050



GANCIO PORTABORSA
BAG HOOK

PIAGGIO: Vespa
(R.O. 011653)



14 256 0100



COPPIA COPERTURE LATERALI
COUPLE COVERS

PIAGGIO 50: Ciao con variat. colore nero 80-88
Ciao with autom.speed black colour 80-88
(R.O. 9223005-9224005)



14 256 0150



COPPIA POGGIAPIEDI NERI
BLACK FLOOR BOARD COUPLE

PIAGGIO 50: Si • Si FL 2
(R.O. 228989)



14 256 0090



CP. COPERTURE LATERALI COPRIMOTORE
COUPLE PROTECTION FRAME

PIAGGIO 50: Si • FL2
(R.O. 497488)



12 185 8590



VITE FISSAGGIO RAPIDO mm 34
FAST LOCK SCREW mm 34

PIAGGIO 50: Ciao • Si
(R.O. 185818)



12 185 8600



VITE FISSAGGIO RAPIDO mm 31
FAST LOCK SCREW mm 31

PIAGGIO 50: Ciao • Si
(R.O. 132871)



12 189 0120



MOLLA RITEGNO FIANCATINE
PROTECTION FRAME SPRING

PIAGGIO 50: Ciao • Si
(R.O. 122957)



12 171 0030



NEW

SONDA LIVELLO OLIO - OIL SENSOR LEVEL

PIAGGIO 50: Free Delivery 00-01 • Free FL 95-02 • Free 92-94 • Zip Bimodale 94-97 • Zip Fast Raider Rst 96-97 • Zip Fast Raider 93-94 • Zip Rst 96-99 • Zip Sp 96-00 • Zip 92-96 (R.O. 259007)



12 171 0040



NEW

SONDA LIVELLO OLIO - OIL SENSOR LEVEL

PIAGGIO 50: Fly 2T 05-11 • Fly 4T 25-30 Km/h 08-11 • Fly 4T 2V 25-30 Km/h 12-17 • Fly 4T Motore Chn 06-07 • Fly 4T 05-07
100: Fly 4T 06-14
125: Beverly Eu3 3 Mic 07 • Beverly Eu3 Sport 07-08 • Beverly Eu3 07-08 • Beverly Rst 4T 4V ie Eu3 10-15 • Beverly Rst 05-07 • Beverly Tourer Eu3 07-10 • Fly Eu3 07-11 • Fly 05-07 • Vespa Gts ie Abs E4 16-17
150: Fly Eu3 08-11 • Fly 05-07 • Vespa Gts 4T E4 Abs (Emea) 16-17
200: Beverly 06-07
300: Beverly Rst 4T 4V ie Eu3 10-15 (R.O. CM025706)



12 167 8010

**RACCORDO OLIO - OIL PIPE CONNECTING PICE**

GILERA 50: Eaglet - Eaglet Automatico 96-97 • Ice 01 • Easy Moving 95-96 • Stalker - Storm - Dna 97-01 • Runner - FL - Purejet - Poggiali 97-02 • Typhoon X-Xr 98-00
 50-125: Typhoon-Typhoon Xr 94-00
 125-180: Runner Fx-Fxr 97-02
PIAGGIO 50: Ape Rst Mix 99-03 • Free-Free Delivery-FL 92-01 • Liberty 97-02 • Nrg Purejet-Extreme 99-02 • Ntt-Nrg-Nrg Mc3 94-02 • Nrg Rst Mc2 96-98 • Puch P1-Tre 93-98 • Sfera Maquillage 2-Base-Rst 91-97 • Vespa Et2-Et2 Iniezione 97-01 • Vespa FL2 Automatica 90-91 • Vespa Pk XL Plurimatic 85-90 • Velofax 96-99 • Quartz 92-96 • Typhoon 01 • Zip Fast Raider Rst-Rst 93-99 • Zip & Zip Bimodale-Base-Sp 94-97 • Vespa Pk S Automatica 84-89
80: Skr City 99
125: Haxagon Lx4 98-99 Vespa Pk Automatica 84-89 • Vespa Pk S Automatica 84-89 • Skipper - Skipper Lx 94-99 • Cosa 2 - Cosa CL-CLX 88-97
150: Skipper - Skipper Lx 94-99 • Cosa 2 - Cosa CL-CLX 88-97
200: Cosa 2 - Cosa CL-CLX 88-97 (R.O. 574362)



12 173 0010

**SERBATOIO OLIO APE****OIL TANK APE**

Con indicatore riserva
 With reserve indicator

PIAGGIO: Ape
 (R.O. 263449)



12 173 0033

**SERBATOIO OLIO - OIL TANK**

PIAGGIO 125-150-200: Vespa Px Arcobaleno T5 VNX-VLX-VSX-VNX5T-VNX2-VLX2-VSX2 (R.O. 297175)



12 171 0020

**SPIA OLIO VESPA - OIL BOWL**

PIAGGIO: Vespa Pxe 125-150-200 Arcobaleno • Vespa Px T5 125 • Vespa Px 125 anni 30 • Vespa Px 125 -150 modello 11 • Rally 200 (R.O.623140 • 155526)





PARTICOLARI CARROZZERIA PIAGGIO

PIAGGIO BODYWORK PARTS

12 173 0030



NEW

12 173 0040



NEW

12 173 0050



NEW

SERBATOIO - TANK

PIAGGIO: Vespa 125 T5
Vespa Px 125-150-200
Modello senza miscelatore
Model without mixer
(R.O. 2280825)



SERBATOIO - TANK

PIAGGIO: Vespa 125 T5
Vespa Px 125-150-200
Modello con miscelatore
Model with mixer
(R.O. 2283725)



SERBATOIO - TANK

PIAGGIO: Vespa Px
Vespa Px 125-150-200
Modello senza miscelatore
Model without mixer
(R.O. 2194672)



12 173 0020



SERBATOIO BENZINA VESPA TANK VESPA

PIAGGIO 50-90-125: Primavera Et3
(R.O. 138617)



12 173 0043



NEW

TRASMETTITORE LIVELLO BENZINA FUEL GAUGE

Adatto per 12 173 0030
Fit on 12 173 0030
(R.O. 218585)



14 268 0280



PARASPRUZZO MUDGUARD FLAP

PIAGGIO 50: Vespa FL2 V5N1
(R.O. 266308)



14 268 0290



PARASPRUZZO MUDGUARD FLAP

PIAGGIO 50: Vespa FL 2 V5N1
(R.O. 256940)



14 268 0170



PARASPRUZZO MUDGUARD FLAP

PIAGGIO: Varie Vespa - *Various Vespa*
(R.O. 610062M)



14 268 0420



PARASPRUZZO - FLAP

PIAGGIO 50: Si FL2
(R.O. 269208)



14 268 0560



NEW

PARASPRUZZO - SPLASH GUARD

PIAGGIO: VESPA PK 50 -125 XL
(R.O. 9044005)





14 280 0000 

PORTAPACCO ANTERIORE CROMATO
CHROMED FRONT CARRIER

PIAGGIO: Vespa Px
LML

(R.O.610271M)



14 280 0071 

PORTAPACCO ANTERIORE NERO
BLACK FRONT CARRIER

PIAGGIO: Vespa Px
LML



14 280 0030 

PARAURTI - FRONT BUMPER

PIAGGIO: Vespa Px
LML

(R.O. 610272M)



14 280 0031  **NEW**

PARAURTI ANTERIORE - FRONT BUMPER

PIAGGIO: Vespa Px
LML



14 280 0010 

PORTAPACCO POSTERIORE CROMATO
CHROMED REAR CARRIER

PIAGGIO: Vespa Px
LML

(R.O.610270M)



14 280 0001 

PORTAPACCO POSTERIORE NERO
BLACK REAR CARRIER

PIAGGIO: Vespa Px
LML



14 280 0020 

PORTABAULETTO POSTERIORE CROMATO
CHROMED CARRIER FOR BAG

PIAGGIO: Vespa Px
LML





PARTICOLARI CARROZZERIA PIAGGIO

PIAGGIO BODYWORK PARTS

14 267 0040



TAPPETINO IN GOMMA
RUBBER MAT

PIAGGIO: Vespa 50-90 • Primavera



14 267 0050



TAPPETINO IN GOMMA
RUBBER MAT

PIAGGIO: Vespa 125 Et3



14 267 0060



TAPPETINO IN GOMMA
RUBBER MAT

PIAGGIO: Vespa Px 125-150-200



14 267 0070



TAPPETINO IN GOMMA
RUBBER MAT

PIAGGIO: Vespa Pk 50



14 267 0080



TAPPETINO IN GOMMA
RUBBER MAT

PIAGGIO: Vespa Pk • XL 50



14 267 0090



TAPPETINO IN GOMMA
RUBBER MAT

PIAGGIO: Vespa 150 GL • Sprint



14 267 0100



TAPPETINO IN GOMMA
RUBBER MAT

LAMBRETTA: Li • DL



14 267 0120



TAPPETINO IN GOMMA
RUBBER MAT

PIAGGIO: Vespa Sprint • GL





14 267 0020 

TAPPETINO CENTRALE IN GOMMA
CENTRAL RUBBER MAT

PIAGGIO: Vespa Px 1° serie
(R.O. 180052)



14 267 0030 

TAPPETINO CENTRALE IN GOMMA
CENTRAL RUBBER MAT

PIAGGIO 125: Vespa Primavera • Et3
(R.O. 100445)



14 267 0010 

TAPPETINO CENTRALE IN GOMMA
CENTRAL RUBBER MAT

PIAGGIO: Vespa GL 150 • Sprint • Sprint
veloce Rally
(R.O. 085072)



14 267 0130 

TAPPETINO CENTRALE IN PLASTICA
CENTRAL PLASTIC MAT

PIAGGIO: Vespa Px T5 VNX5T
(R.O. 226093)



14 268 0300 

TAPPETINO CENTRALE IN PLASTICA
CENTRAL PLASTIC MAT

PIAGGIO: Vespa 50 Pk XL V5X3
(R.O. 253014)



14 266 0200 

COPPIA LISTELLI ACCIAIO INOX
FLOOR RUNNERS FOR FLOOR MAT

PIAGGIO: Vespa GL 150 • Sprint 150 • Super
150 • Vespa 150 Mod. 59 • Vespa 125 Mod. 62
Vespa Gs 160 62-64 • Gtr 125 • Rally 180-200
(R.O. 085073/74)



14 266 0210 

COPPIA LISTELLI ACCIAIO INOX
FLOOR RUNNERS FOR FLOOR MAT

PIAGGIO: Vespa 50-90 • Primavera Et3
(R.O. 100446/7)



14 266 0220 

COPPIA LISTELLI ACCIAIO INOX
FLOOR RUNNERS FOR FLOOR MAT

PIAGGIO: Vespa Px 125-150-200
(R.O. 180048)





PARTICOLARI CARROZZERIA PIAGGIO

PIAGGIO BODYWORK PARTS

14 266 0030



NEW

14 266 0040



NEW

14 266 0090



NEW

STRISCE PEDANA - FOOTREST STRIPES

PIAGGIO: Vespa 50-90-125 • Primavera - Et3
V5a1-V5b1-V5b2-V5sa1-V9a1-Vma2-
Vmb1-Vmx1t
(R.O. 610232M)

STRISCE PEDANA - FOOTREST STRIPES

PIAGGIO: Vespa Px 125-150-200
Vnx-VLX-Vsx
(R.O. 610231M)

STRISCE PEDANA - FOOTREST STRIPES

PIAGGIO: Vespa 150 GL Sprint • Sprint Veloce
-180-200 Rally • VLA-VLB-VLB1t-VNL2t
Vsd1t-Vse1t
(R.O. 610233M)



14 266 0030



SERIE STRISCE PEDANA

FLOOR RUNNER KIT

PIAGGIO 50-90-125: Vespa ET3 in alluminio
Completa di gomma e puntalini
Alloy with rubber and terminals
(R.O. 610232M)

14 266 0040



SERIE STRISCE PEDANA

FLOOR RUNNER KIT

PIAGGIO: Vespa Px Pe Arcobaleno in alluminio
Completa di gomma e puntalini
Alloy with rubber and terminals
(R.O. 610231M)

14 266 0090



SERIE STRISCE PEDANA

FLOOR RUNNER KIT

PIAGGIO 150-180-200: Vespa GL-Sprint-
Sprint Veloce Rally
VLA-VLB-VLB1T-VNL2T-VSD1T-VSE1T
(R.O. 610233M)



14 256 0050



SACCA PORTATUTTO - TOOLBOX

PIAGGIO 50-125: Vespa Pk • FL • Hp • Rush N
(R.O. 219383)

14 256 0030



SACCA PORTATUTTO - TOOLBOX

PIAGGIO 50-90: Vespa
125: Vespa Primavera • Et3
(R.O. 100389)

14 256 0143



NEW

PORTAOGGETTI - STORAGE

PIAGGIO 125: Vespa T5
(R.O. 233112)





14 264 0050 

PROFILO SCUDO PLASTICA
BLACK LEGSHIELD FRAME PROFILE

PIAGGIO: Vespa Px • Pe • T5

Colore nero - *Black colour*

(R.O. 226097)



14 264 0040 

PROFILO SCUDO PLASTICA
BLACK LEGSHIELD FRAME PROFILE

PIAGGIO: Vespa Px • Pe

Metallizzato grigio - Silver colour

(R.O. 218944)



14 264 0130 

PROFILO SCUDO IN ALLUMINIO
ALUMINIUM LEGSHIELD FRAME PROFILE

PIAGGIO: Vespa 50 • 50 Special • Vespa 90 • Vespa 125 Primavera • Et3

Tipo originale

Original type

(R.O. 070416)

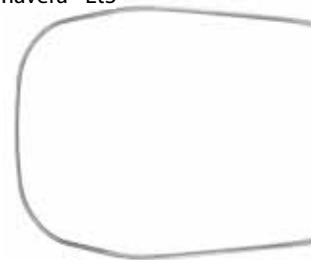

14 264 0220 

PROFILO SCUDO GOMMA
LEGSHIELD FRAME PROFILE

PIAGGIO: Vespa 50 Pk XL-125 - V5N1T-V5N2T-V5X5T-V5X4T-V5X3T-VMX7T-VMX6T

(R.O.256938)



14 264 0101 

PROFILO SCUDO 165 CM - RUBBER PROFILE

PIAGGIO 50-90-125: Vespa Primavera -Et3

V5A1-V5B1-V5B2-V5SA1-V9A1-VMA2-VMB1-VMX1T



14 264 0190 

PROFILI SCUDO SINISTRO
LEFT PROFILE LEGSHIELD

PIAGGIO 125: Granturismo Eu3 06-07 • Granturismo 03-07 • Gts 4T ie Super 09-04 • Gts Eu3 07-12 • Gtv 4T Navy Eu3 08 • Gtv 06-08

200: Gt Granturismo 06-07

250: Gt 60 Eu3 06-07 • Gts Abs 05-12 • Gts 05-13 • Gtv 4T Navy Eu3 07 • Gtv 05-09

300: Gts ie Touring 11-12 • Gts ie 12-14 • Gts Super Sport 10-13 • Gts Super 08-14 • Gtv 4T 4V ie 10-13 • Gtv Via Montenapoleone 10 (R.O. 577180)



14 264 0180 

PROFILI SCUDO DESTRO
RIGHT PROFILE LEGSHIELD

PIAGGIO 125: Granturismo Eu3 06-07 • Granturismo 03-07 • Gts 4T ie Super 09-04 • Gts Eu3 07-12 • Gtv 4T Navy Eu3 08 • Gtv 06-08

200: Gt Granturismo 06-07

250: Gt 60 Eu3 06-07 • Gts Abs 05-12 • Gts 05-13 • Gtv 4T Navy Eu3 07 • Gtv 05-09

300: Gts ie Touring 11-12 • Gts ie 12-14 • Gts Super Sport 10-13 • Gts Super 08-14 • Gtv 4T 4V ie 10-13 • Gtv Via Montenapoleone 10 (R.O. 577181)



14 264 0210 

PROFILI SCUDO SINISTRO
LEFT PROFILE LEGSHIELD

PIAGGIO 50: Lx 2T Touring & 30 Km 10-13 • Lx 2T 05-08 • Lx 2T 09-13 • Lx 4T-4V Touring 10-13 • Lx 4T-4V 09-13 • Lx 4T 05-08 • Lxv 2T Nav y 08 • Lxv 2T 06-09 • S2t & college 07-12 • S4t 4v & College 08-12

125: Lx 4T 3V ie - Touring 12-13 • Lx 4T Eu3 Touring 10-11 • Lx 4T FL 09 • Lx Eu3 ie 09-11 • Lx Eu3 06-08 • Lx 05-06 • Lxv 4T Eu3 06-09 • Lxv 4T Navy Eu3 07-08 • Lxv ie 4T 10-13 • S 4T 3V ie 12 • S 4T Eu3 07-08 • S 4T ie & College 09-11

150: Lx 4T 3V ie - Touring 12-13 • Lx 4T FL 09 • Lx Eu3 ie 09-11 • Lx Eu3 06-08 • Lx Touring 10-12 • Lx 05-06 • S 4T ie & College 09-12 • S 4T 08-09 (R.O. 622187)



14 264 0200 

PROFILI SCUDO DESTRO
RIGHT PROFILE LEGSHIELD

PIAGGIO 50: Lx 2T Touring & 30 Km 10-13 • Lx 2T 05-08 • Lx 2T 09-13 • Lx 4T-4V Touring 10-13 • Lx 4T-4V 09-13 • Lx 4T 05-08 • Lxv 2T Navy 08 • Lxv 2T 06-09 • S2t & college 07-12 • S4t 4v & College 08-12

125: Lx 4T 3V ie - Touring 12-13 • Lx 4T Eu3 Touring 10-11 • Lx 4T FL 09 • Lx Eu3 ie 09-11 • Lx Eu3 06-08 • Lx 05-06 • Lxv 4T Eu3 06-09 • Lxv 4T Navy Eu3 07-08 • Lxv ie 4T 10-13 • S 4T 3V ie 12 • S 4T Eu3 07-08 • S 4T ie & College 09-11 • **150:** Lx 4T 3V ie - Touring 12-13 • Lx 4T FL 09 • Lx Eu3 ie 09-11 • Lx Eu3 06-08 • Lx Touring 10-12 • Lx 05-06 • S 4T ie & College 09-12 • S 4T 08-09 (R.O. 622188)





PARTICOLARI CARROZZERIA PIAGGIO

PIAGGIO BODYWORK PARTS



14 264 0070 

PROFILO IN GOMMA COFANO LATERALE
SIDEPANEL BLACK RUBBER STRIP

PIAGGIO: Vespa Px-Pe
(Rotoli da 12 Mt Nero - 12 Mt roll black)

14 264 0100 

PROFILO IN GOMMA SCUDO
FRAME BLACK RUBBER STRIP

PIAGGIO 50: Vespa Et3 • Px-Pe
(CM 165 Nero - 165 Cm Black)

14 264 0080 

PROFILO IN GOMMA
WINDSHIELD BLACK RUBBER STRIP
PER CUPOLINO STANDARD

(Rotoli da 12 Mt Nero - 12 Mt roll black)

14 264 0110 

PROFILO IN GOMMA
TRA BAULETTO E SCUDO
RUBBER PROFILE PACK

Vespa Px • Pe (Cm 160 Nero - 160 Cm Black)
(R.O. 219165)

14 264 0060 

PROFILO IN GOMMA BORDO SCUDO
BLACK RUBBER STRIP

PIAGGIO 50: Vespa Et3 Px-Pe-Pk
(Rotoli da 8 Mt Nero - 8 Mt roll black)

14 264 0090 

PROFILO IN GOMMA PER FILTRO ARIA
AIR FILTER RUBBER STRIP

PIAGGIO 50-150: Vespa • Px
(Rotoli da 10 Mt Nero - 10 Mt roll black)
(R.O. 058853-279882)

14 264 0120 

PROFILO COFANO LATERALE
SIDEPANEL BLACK RUBBER STRIP

PIAGGIO: Vespa Px Arcobaleno
(Cm 110 Nero - 110 Cm Black)

14 264 0140 

PROFILO IN GOMMA PEDANA
FLOOR RUNNER RUBBER

PIAGGIO 50-90-125: Vespa Primavera • Et3
V5A1-V5B1-V5B2-V5SA1-V9A1-VMA2-VMB1-
VMX1T
(R.O. 154777)

14 264 0150 

PROFILO IN GOMMA PEDANA
FLOOR RUNNER RUBBER

PIAGGIO 150: Vespa Sprint • GL • Sprint Velo-
ce • Super
180-200: Rally VLA-VLB-VSD1T-VSE1T
(R.O. 94625)

14 264 0160 

PROFILO IN GOMMA PEDANA
FLOOR RUNNER RUBBER

Vespa Px • Pe • Pk - VNX - VSX - VLX
(R.O. 154778)

14 264 0170 

PROFILO COFANO 3 MT
3 MT SIDEPANEL RUBBER SCRIPT

PIAGGIO 125-150: Vespa Gs - V30-V33T-VM1-
2T-VN1-2T-VNA1-2T-VNB1-2-3-4-5-6-VL1-2-3-
VB1T-VBA1TVBB1- 2T-VS1-2-3-4-5
(R.O. 011751)



14 264 0500 

KIT GOMMINI TELAIO - FRAME RUBBERS KIT

VESPA 50-90	QUANTITÀ QUANTITY
12 183 0230 Cappuccio candela - <i>Spark plug</i>	1
12 183 0290 Tappo mozzo anteriore - <i>Plug hub</i>	1
12 183 0320 Tassello feritoia volano - <i>Flywheel plug</i>	1
12 183 0340 Asta rubinetto benzina - <i>Tie rod</i>	1
12 183 0350 Ammortizzatore posteriore - <i>Rear damper</i>	1
12 183 0370 Tappo benzina - <i>Fuel cap</i>	1
12 183 0380 Tampone di scontro carter - <i>Buffer</i>	2
12 183 0410 Passacavo telaio - <i>Frame buffer</i>	1
12 183 0430 Clacson - <i>Horn</i>	1
12 183 0490 Sportello motore - <i>Engine door</i>	6
12 183 0460 Fondello bloccasterzo - <i>Lock</i>	1
12 183 0500 Pedale freno - <i>Brake</i>	1
12 183 0530 Rubinetto benzina - <i>Fuel cock</i>	1
12 183 0560 Bobina - <i>Coil</i>	1
12 183 0600 Ammortizzatore anteriore - <i>Front damper</i>	2

Composto da pezzi 22 - *Made by 22 pcs*

14 264 0540 

NEW

KIT GOMMINI TELAIO - FRAME RUBBERS KIT

VESPA GL SPRINT	QUANTITÀ QUANTITY
10 070 6210 Coperchio frizione - <i>Clutch cover</i>	1
12 183 0090 Passacavo - <i>Grommet</i>	1
12 183 0300 Tappo benzina - <i>Fuel cap</i>	1
12 183 0330 Depuratore - <i>Air cleaner</i>	1
12 183 0340 Asta rubinetto - <i>Tie rod</i>	1
12 183 0350 Ammortizzatore posteriore - <i>Rear damper</i>	1
12 183 0360 Passacavo telaio - <i>Frame grommet</i>	1
12 183 0400 Tampone di scontro carter - <i>Buffer</i>	2
12 183 0430 Clacson - <i>Horn</i>	1
121850450 Gommino pedale freno - <i>Pedal Rubber</i>	1
12 183 0460 Fondello bloccasterzo - <i>Lock</i>	1
12 183 0510 Tampone motore - <i>Engine buffer</i>	1
12 183 0520 Tampone motore - <i>Engine buffer</i>	1
12 183 0530 Rubinetto benzina - <i>Fuel cock</i>	1
12 183 0560 Bobina - <i>Coil</i>	1
12 183 0843 Cappuccio Candela - <i>Spark Plug cap</i>	1
12 183 0900 Leva messa in moto - <i>Starter lever</i>	1
14 264 0543 Kit gommini cofano - <i>Rubber hood kit</i>	1

Composto da pezzi 19 - *Made by 19 pcs*

14 264 0520 

KIT GOMMINI TELAIO - FRAME RUBBERS KIT

VESPA PX	QUANTITÀ QUANTITY
12 183 0230 Cappuccio candela - <i>Spark plug</i>	1
12 183 0080 Leva messa in moto - <i>Kick starter lever</i>	1
10 070 6210 Coperchio frizione - <i>Clutch cover</i>	1
12 183 0090 Passacavo - <i>Grommet</i>	1
12 183 0110 Passacavo cofano - <i>Cowl grommet</i>	1
12 183 0300 Tappo benzina - <i>Fuel cap</i>	1
12 183 0330 Depuratore - <i>Air cleaner</i>	1
12 183 0340 Asta rubinetto - <i>Tie rod</i>	1
12 183 0350 Ammortizzatore posteriore - <i>Rear damper</i>	1
12 183 0360 Passacavo telaio - <i>Frame grommet</i>	1
12 183 0400 Tampone di scontro carter - <i>Buffer</i>	2
12 183 0420 Tubetto cofano - <i>Tube cowl</i>	2
12 183 0460 Fondello bloccasterzo - <i>Lock</i>	1
12 183 0470 Soffietto cavo frizione - <i>Clutch cable folding</i>	1
12 183 0480 Pedale freno - <i>Brake pedal</i>	1
12 183 0510 Tampone motore - <i>Engine buffer</i>	1
12 183 0520 Tampone motore - <i>Engine buffer</i>	1

Composto da pezzi 21 - *Made by 21 pcs*

14 264 0530 

KIT GOMMINI TELAIO - FRAME RUBBERS KIT

VESPA PK	QUANTITÀ QUANTITY
12 183 0230 Cappuccio candela - <i>Spark plug</i>	1
12 183 0290 Tappo mozzo anteriore - <i>Plug hub</i>	1
12 183 0340 Asta rubinetto benzina - <i>Tie rod</i>	1
12 183 0370 Tappo benzina - <i>Fuel cap</i>	1
12 183 0390 Tampone di scontro carter - <i>Buffer</i>	1
12 183 0480 Pedale freno - <i>Brake pedal</i>	1
12 183 0490 Sportello motore - <i>Engine door</i>	6
12 183 0530 Rubinetto benzina - <i>Fuel cock</i>	1
12 183 0560 Bobina - <i>Coil</i>	1
12 183 0570 Cappuccio Centralina - <i>Ignition Device</i>	1
12 183 0600 Ammortizzatore anteriore - <i>Front damper</i>	2

Composto da pezzi 17 - *Made by 17 pcs*





PARTICOLARI CARROZZERIA PIAGGIO

PIAGGIO BODYWORK PARTS

12 183 0490 

TAMPONE COFANO MOTORE SIDEANEL BUFFER

Vespa 50-90-Primavera Et3
V5A1-V5B1-V5B2-V5SA1-V9A1-VMA2-VMB1
(R.O. 232222)



14 264 0543 

KIT GOMMINI COFANO KIT RUBBER HOOD COWLS

PIAGGIO 150: Vespa Sprint VLB1T



14 264 0553 

KIT GOMMINI PORTELLO KIT RUBBER DOOR

PIAGGIO 50: Vespa 1 serie V5A1T



14 264 0563 

KIT GOMMINI PORTELLO KIT RUBBER DOOR

PIAGGIO 50: Vespa special V5B3T



14 264 0573 

KIT GOMMINI COFANO KIT RUBBER COWLS

PIAGGIO 125-150-200: Vespa Px
VN1T-VLX1T-VSX1T



14 264 0583 

KIT GOMMINI COFANO KIT RUBBER COWLS

PIAGGIO 125-150-200: Vespa Px
VN1T-VLX1T-VSX1T



12 183 0420 

TUBETTO COFANO SIDEANEL RUBBER TUBE

PIAGGIO 125-150-200: Vespa Px • P200 E
VNX-VLX-VBX -T5 VNX5T
Vespa Pxe VNX2-VLX2-VSX1
(R.O. 024021)



12 183 0590 

TAMPONE BAULETTO RUBBER BUFFER GLOVE BOX

PIAGGIO 125-150-200: Vespa Px • T5 • Pxe
Arcobaleno • Cosa
(R.O. 149908)



12 183 0863 

GOMMINI COFANI - RUBBER HOOKS

PIAGGIO 125-150-200: Vespa Px
VNX-VLX-VSX-VNX2-VLX2-VSX2
(R.O. 178689)



12 183 0620 

CAPPUCCIO PRESA CORRENTE RUBBER SOCKET

PIAGGIO 50-90-125: Vespa Primavera Et3
V5A1-V5A2T-V5B1T-V9A1-VMB1
(R.O. 161125)



14 268 0540 

PORTELLO BAULETTO - GLOVEBOX DOOR

PIAGGIO: Vespa Pk50-125 • Va51t-Vam1t
(R.O. 216467)



14 268 0550 

PULSANTE PORTELLO - BUTTON GLOVE BOX

PIAGGIO: Vespa Pk50-125 • Va51t-Vam1t
(R.O. 216624)



12 181 0073 

NEW

MANIGLIETTA COFANO - HOOD HANDLE

PIAGGIO: Vespa >1958
(R.O. 610399M)



12 181 0063 

GANCI COFANI - COWL HOOKS

PIAGGIO 125-150-200: Vespa Px
VNX-VLX-VSX-VNX2-VLX2-VSX2
(R.O. 227229 • 244093)





12 183 0090 

PASSACAVO TUBO BENZINA
FUEL HOSE GROMMET

PIAGGIO: Vespa Px
(R.O. 084262)



12 183 0110 

PASSACAVO COFANO MOTORE
COWL GROMMET

PIAGGIO: Vespa Px
(R.O. 156946)



12 183 0360 

PASSACAVO TELAIO
GROMMET

PIAGGIO: Vespa Pxe 125-150-200
VNX2-VLX2-VSX1
(R.O. 048171)



12 183 0410 

PASSACAVO TELAIO
FRAME GROMMET

PIAGGIO: Vespa 50-90-Primavera Et3
V5A1-V5B1-V5B2-V5SA1-V9A1-VMA2-VMB1
(R.O. 070219)



12 183 0830 

PASSACAVO TELAIO
FRAME GROMMET

PIAGGIO: Vespa 50-125 Pk
V5X1T-VMX1T
(R.O. 241071)



12 183 0470 

SOFFIETTO PROTEZIONE CAVI
RUBBER BELLOW CABLE

PIAGGIO: Vespa Px • Pe • Pxe Arcobaleno
VNX - VLX - VSX - VNX2 - VLX2 - VSX2
(R.O. 156425)



12 183 0450 

GOMMINO PEDALE FRENO
BRAKE PEDAL RUBBER

PIAGGIO: Vespa 125-150 Gs • 160-180 Ss
• Rally 180-200
(R.O. 093100)

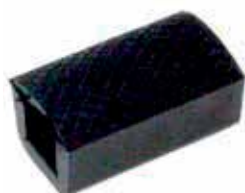

12 183 0480 

GOMMINO PEDALE FRENO
BRAKE PEDAL RUBBER

PIAGGIO: Vespa Px • Pe - VNX - VLX - VSX
(R.O. 182051)



12 183 0500 

GOMMINO PEDALE FRENO
BRAKE PEDAL RUBBER

PIAGGIO 125: Vespa Primavera-Et3
V5SS-V5A1T-V9SS-VNA1/2T-VMB1
(R.O. 100426)



12 153 0190 

PEDALE E PIASTRA FRENO COMPLETO
BRAKE PEDAL ASSY

PIAGGIO: Vespa Px • Pe
VNX - VLX - VSX - VNX2 - VLX2 - VSX2
(R.O. 182049-138474)



12 153 0313 

PEDALE FRENO
BRAKE PEDAL

PIAGGIO 150: Vespa GL-Sprint-Super- Sprint
veloce VLB-VLA-VBC
(R.O. 094451)





PARTICOLARI CARROZZERIA PIAGGIO

PIAGGIO BODYWORK PARTS

14 270 0010 

PORTATARGA EUROPEO - PLATE HOLDER

In nylon antiurto predisposto per il montaggio su tutte le moto e scooter

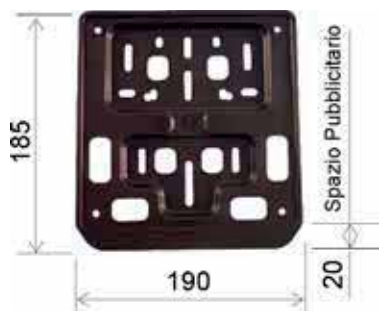

14 270 0040 

PORTATARGA EUROPEO - PLATE HOLDER

Per Ciclomotori e Scooter 50 cc



14 270 0390 

PORTATARGA EUROPEO IN ACCIAIO

STEEL PLATE HOLDER

170 x 170 mm

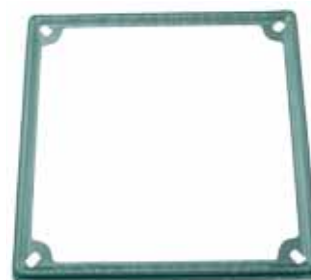

12 151 0020 

COPPIA PEDALI

PEDALS PAIR

PIAGGIO: Ciao • Si • Bravo

Grillo • Tipo originale - Standard type

(R.O. 191643)



12 185 6150 

CHIAVELLA CON DADO FORATO PER

PEDALI

KEY FOR MOPED PEDALS

Conf. Da 144 pz. - 144/Pcs Packing

(R.O. 114 219)



12 153 0210 

COPPIA PEDIVELLE

LH-RH CRANK LEVERS

PIAGGIO: Ciao

(R.O. 180888/9)



12 183 0120 

BUSSOLA PEDALIERA

AXLE BUSH

PIAGGIO: Si

(R.O. 141737)



12 153 0300 

ASSE PEDALIERA

CRANKLE SPINDLE

PIAGGIO: Ciao

(R.O. 188073)



14 274 0130 

MANIGLIA IN PLASTICA PER PORTA LATERALE

HANDLE LATERAL DOOR

PIAGGIO 50: Ape

(R.O. 255813)



26 720 0610 



SPAZZOLA TERGICRISTALLO

WIPER BLADE

Lunghezza 380 mm - Length 380 mm

PIAGGIO 50: Ape Mix 2T 98-08

220: Ape Mp P501-P601 78-96 • Ape Tm P602

82-83 • Ape Tm P703-P703V FL2 84-05

420: Ape Poker Benzina 93 • Ape Poker Diesel

93-97 • Ape Tm P703-P703V Diesel 87-04

(R.O. 438013)



26 720 0690 



SPAZZOLA TERGICRISTALLO

WIPER BLADE

Lunghezza 406 mm - Length 406 mm

PIAGGIO 1000: Porter 92-98

1200: Porter Diesel 95-00

1300: Porter 16V Pick Up 98-09 • Porter 16V Van

1400: Porter Pick Diesel 98-05 • Porter Van

Diesel 98-05

(R.O. 438042)





12 185 8400 

PERNO ANCORAGGIO SELLA TIPO CORTO
SADDLE PIN TYPE SHORT

PIAGGIO 50-90: Vespa Primavera Et3
V5A1-V5B1-V5B2-V5SA1-V9A1-VMA2-VMB1
(R.O. 56729)



12 185 8410 

PERNO ANCORAGGIO SELLA TIPO LUNGO
SADDLE PIN TYPE LONG

PIAGGIO 50-90: Vespa Primavera Et3
V5A1-V5B1-V5B2-V5SA1-V9A1-VMA2-VMB1
(R.O. 139318)



12 185 8420 

PERNO ANCORAGGIO SELLA
SADDLE PIN

PIAGGIO 125-150-200: Vespa Px P200E
VNX-VLX-VBX -T5 VNX5T
Vespa Pxe 125-150-200 VNX2-VLX2-VSX1
(R.O. 240165)



12 183 0940 

NEW

TAMPONE SELLA - SADDLE BUFFER

PIAGGIO: Vespa Px 125-150-200
Vn1-Vn2-Vs1
(R.O. 267420)



22 508 8033 

NEW

DISCO PARAPOLVERE - DUST DISC

PIAGGIO 125: Vespa 125-150 • Vba-Vbb-
Vna-Vnb-Vnc-Vbc
(R.O. 110379)



22 508 8043 

NEW

DISCO PARAPOLVERE - DUST DISC

PIAGGIO: Vespa Px 125-150-200 • T5 • Rally
200 - 150 Sprint • Vnx2-Vlx1-Vsx1
Vnx5t-Vse1t-Vlb
(R.O. 078482)



12 187 0613 

NEW

CAMMA FRENO - BRAKE CAM

PIAGGIO: Vespa 125-150
Vba-Vbb-Vna-Vnb-Vnc-Vbc
(R.O. 131942)



12 186 0373 

NEW

FERMO DADO RUOTA ANTERIORE
FRONT WHEEL NUT LOCK

PIAGGIO: Vespa Px 125-150-200
Vnx2-Vnx1-Vsx1
(R.O. 177609)



14 258 0170 

FLANGIA RUOTA POSTERIORE
REAR WHEEL FLANGE

PIAGGIO 50: Ciao • Si • Bravo • Grillo
(R.O. 124963)



12 183 0290 

TAPPO MOZZO ANTERIORE
FRONT HUB PLUG

PIAGGIO 50-90-125: Vespa Primavera
VSA1/2T-V5B1/3T - V5A 3T - V5B2T - V5B4T -
V5SS1T
(R.O. 071053)



24 648 0440 

SPIE INDICATRICI - INDICATOR LIGHTS

PIAGGIO 125-150-200: Vespa Px I° serie
VNX-VLX-VSX-VLB-VBC
(R.O. 139980-163682)



14 268 0180 

PROTEZIONE RUOTA DI SCORTA 10"
SPARE WHEEL COVER 10"

PIAGGIO: Vespa Px-Pe VNZ-VLX-VSX
(R.O. 226824)





PARTICOLARI CARROZZERIA PIAGGIO

PIAGGIO BODYWORK PARTS

12 168 0083



ASTA STARTER - CHOKE TIE ROD
PIAGGIO 125-150-200: Vespa PX
VNX-VLX-VSX
(R.O. 580938)



12 183 0330



TAPPO VASCHETTA CARBURATORE
RUBBER PLUG CARBURATOR CAISING
PIAGGIO: Vespa Px 125-150-200 Pxe
VNX - VLX - VBX - VNX2 - VLX2 - VSX1
(R.O. 050274)



24 614 0510



BOCCOLA COLLEGAMENTO-BUSH CONNECTOR
PIAGGIO VESPA: 50: Px 30 anni 07-08 • Px Eu2
01-07 • Px T5 85-89 • Px 98-13 • Pxe Arcobaleno
81-97 • 150: Px 11-13
(R.O. 216053)



14 270 0030



PORTABOLLO - ROAD TAX HOLDER
PIAGGIO:
Vari modelli Vespa - *Various Vespa models*



14 280 0050



ASTA BANDIERA - FLAGPOLE
PIAGGIO:
Vari modelli Vespa - *Various Vespa models*
(R.O. 610013M)



12 187 0040



TAPPO SUL MANUBRIO
HANDLEBAR COVER PLUG
GILERA 50: Ice 01
PIAGGIO 50: Liberty 97-02 • 4T 00-02
100: Free 02
(R.O. 562897)



14 274 0140



CINGHIA FERMA PORTIERA
SAFETY BELT FOR DOOR
PIAGGIO 50: Ape tutti i tipi
200: Ape Car P2-P3 78-85 • Ape Mp P501-P601
(R.O. 175074)



▶ TARGHETTE

BADGES





TARGHETTE PER SCUDO

FRONT SHIELD BADGE

14 272 0040



**SCUDETTO PER SCUDO ANTERIORE
FOR FRONT SHIELD**

Esagono 26 mm
(R.O. 152280)



14 272 0100



**SCUDETTO PER SCUDO ANTERIORE
FOR FRONT SHIELD**

Esagono 31 mm
(R.O. 149876)



14 272 0110



**SCUDETTO PER SCUDO ANTERIORE
FOR FRONT SHIELD**

Esagono 42 mm
(R.O. 152290)



14 272 0430



**SCUDETTO PER SCUDO ANTERIORE
FOR FRONT SHIELD**

Scudetto rettangolare
(R.O. 080349)



14 272 0080



**SCUDETTO RESINATO ADESIVO PIAGGIO
PER CALANDRA STERZO**

*PIAGGIO ADHESIVE RESINED SHIELD
FOR HORN COVER*

Esagono 27 mm.
(R.O. 295596)



14 272 0020



**SCUDETTO RESINATO ADESIVO PIAGGIO
PER CALANDRA STERZO**

*PIAGGIO ADHESIVE RESINED SHIELD
FOR HORN COVER*

(R.O. 295486)



14 272 0050



**SCUDETTO RESINATO PER SCUDO ANTERIORE
PIAGGIO RESINED FOR FRONT SHIELD**

Esagono 32 mm.
(R.O. 574771)



14 272 0500



NEW

**SCUDETTO PER SCUDO ANTERIORE
FOR FRONT SHIELD**

Vespa PX 125-150 Millennium
PX 125-150 '11
(R.O. 576464)



14 272 0220



**TARGHETTA PER SCUDO ANTERIORE
NAMEPLATE FOR FRONT SHIELD**

(R.O. 610288M)



14 272 0240



**TARGHETTA PER SCUDO ANTERIORE
NAMEPLATE FOR FRONT SHIELD**

(R.O. 151727)



14 272 0250



**TARGHETTA PER SCUDO ANTERIORE
NAMEPLATE FOR FRONT SHIELD**



14 272 0290



**TARGHETTA PER SCUDO ANTERIORE
NAMEPLATE FOR FRONT SHIELD**

(R.O. 141345)



TARGHETTE PER SCUDO
FRONT SHIELD BADGE



14 272 0330 

TARGHETTA PER SCUDO ANTERIORE
NAMEPLATE FOR FRONT SHIELD
(R.O. 90556)



14 272 0310 

TARGHETTA PER SCUDO ANTERIORE
NAMEPLATE FOR FRONT SHIELD
(R.O. 151713)



14 272 0340 

TARGHETTA PER SCUDO ANTERIORE
NAMEPLATE FOR FRONT SHIELD
(R.O. 90496)



14 272 0160 

TARGHETTA PER SCUDO ANTERIORE
NAMEPLATE FOR FRONT SHIELD
(R.O. 577082)



14 272 0400 

TARGHETTA PER SCUDO ANTERIORE
NAMEPLATE FOR FRONT SHIELD
(R.O. 121080)



14 272 0380 

TARGHETTA PER SCUDO ANTERIORE
NAMEPLATE FOR FRONT SHIELD



14 272 0170 

TARGHETTA PER SCUDO ANTERIORE
NAMEPLATE FOR FRONT SHIELD
Interasse perni 80 mm - Pin distance 80 mm
(R.O. 152541)



14 272 0180 

TARGHETTA PER SCUDO ANTERIORE
NAMEPLATE FOR FRONT SHIELD
(R.O. 197601)



14 272 0520 

TARGHETTA PER SCUDO ANTERIORE
NAMEPLATE FOR FRONT SHIELD
PIAGGIO: Vespa Gt R • VNL2T
(R.O. 151716)



14 272 0640 

TARGHETTA PER SCUDO ANTERIORE
NAMEPLATE FOR FRONT SHIELD
PIAGGIO 50-125: Vespa Pk V5X1T • VMX1T
(R.O. 195629)



14 272 0850 

TARGHETTA PER SCUDO ANTERIORE
NAMEPLATE FOR FRONT SHIELD
PIAGGIO 160: Vespa Gs • VSB1
(R.O. 057182)



14 272 0870 

TARGHETTA PER SCUDO ANTERIORE
NAMEPLATE FOR FRONT SHIELD
PIAGGIO: Vespa GL • VS1 (mm 165)
(R.O. 094793)





TARGHETTE PER SCUDO
FRONT SHIELD BADGE

14 272 0900



TARGHETTA PER SCUDO ANTERIORE
NAMEPLATE FOR FRONT SHIELD
PIAGGIO: Vespa VNB
(R.O. 086325)

Vespa

14 272 0880



TARGHETTA PER SCUDO ANTERIORE BLU
FRONT SHIELD BLUE NAMEPLATE
PIAGGIO: Vespa GL VS1
(R.O. 094793)

Vespa GL

14 272 0920



TARGHETTA PER SCUDO ANTERIORE VERDE
FRONT SHIELD GREEN NAMEPLATE
PIAGGIO: Vespa VN1T • VN2 • VNA1
(R.O. 023659)

Vespa

14 272 0930



TARGHETTA PER SCUDO ANTERIORE BLU
FRONT SHIELD BLUE NAMEPLATE
PIAGGIO: Vespa VN1T • VN2 • VNA1
(R.O. 023669)

Vespa

14 272 0810



TARGHETTA PER SCUDO ANTERIORE
NAMEPLATE FOR FRONT SHIELD
PIAGGIO 50: Vespa • V5A
(R.O. 090944)

Vespa 50

14 272 0820



TARGHETTA PER SCUDO ANTERIORE
NAMEPLATE FOR FRONT SHIELD
PIAGGIO 150: Vespa VBA • VBB
(R.O. 084809)

Vespa 150

14 272 0830



TARGHETTA PER SCUDO ANTERIORE
NAMEPLATE FOR FRONT SHIELD
PIAGGIO 150: Vespa Gs • VS1/2/3/4/5
(R.O. 023902)

Vespa Gs

14 272 0840



TARGHETTA PER SCUDO ANTERIORE
NAMEPLATE FOR FRONT SHIELD
PIAGGIO 150: Vespa Gs • VS1/2/3/4/5
(R.O. 023902)

Vespa Gs

14 272 0860



TARGHETTA PER SCUDO ANTERIORE
NAMEPLATE FOR FRONT SHIELD
PIAGGIO 150: Vespa GL • VS1
(R.O. 094793)

Vespa GL

14 272 0910



TARGHETTA PER SCUDO ANTERIORE
NAMEPLATE FOR FRONT SHIELD
PIAGGIO: Vespa VN1T • VN2 • VNA1
(R.O. 023659)

Vespa

14 272 0980



TARGHETTA PER SCUDO ANTERIORE
NAMEPLATE FOR FRONT SHIELD
PIAGGIO 125-150-200: Vespa Px • Arcobale-
no • VNX2 • VLX2 • VSX2
(R.O. 194955)

vespa

14 272 1200



TARGHETTA PER SCUDO ANTERIORE
NAMEPLATE FOR FRONT SHIELD
PIAGGIO 50: Vespa S 4T 4V
125: Vespa Gts 4T ie Super • Vespa S 4T 3V ie
300: Vespa Gts Super Sport
(R.O. 672060)

Vespa

TARGHETTE PER SCUDO
FRONT SHIELD BADGE



14 272 0890 

TARGHETTA PER SCUDO ANTERIORE
NAMEPLATE FOR FRONT SHIELD

PIAGGIO: Vespa VNB
(R.O. 086325)



14 272 1190 

TARGHETTA PER SCUDO ANTERIORE
NAMEPLATE FOR FRONT SHIELD

PIAGGIO 150: Vespa Sprint-Super-Rally Vlb1t-
Vbc1t-Vsc1t
(R.O. 91888)



14 272 0440 

TARGHETTA PER CALANDRA ANTERIORE
NAMEPLATE FOR HORN COVER

PIAGGIO 125-150-200: Vespa Px 1 serie
(R.O.181329)



14 272 0450 

TARGHETTA PER CALANDRA ANTERIORE
NAMEPLATE FOR HORN COVER

PIAGGIO 125-150-200: Vespa Pxe Arcobaleno
• Vespa Px T5
(R.O.232895)





TARGHETTE POSTERIORI

REAR BADGE

14 272 0320 

TARGHETTA POSTERIORE
NAMEPLATE REAR
(R.O. 121012)

Vespa Rally

14 272 0350 

TARGHETTA POSTERIORE
NAMEPLATE REAR
(R.O. 151715)

Primavera

14 272 0270 

TARGHETTA POSTERIORE
NAMEPLATE REAR
(R.O. 90653)

150 Sprint

14 272 0280 

TARGHETTA POSTERIORE
NAMEPLATE REAR
(R.O. 121081)

150 Super

14 272 0410 

TARGHETTA POSTERIORE
NAMEPLATE REAR
(R.O. 151714)

Grand Turismo

14 272 0300 

TARGHETTA POSTERIORE
NAMEPLATE REAR
(R.O. 90653)

Vespa Sprint

14 272 0360 

TARGHETTA POSTERIORE
NAMEPLATE REAR
(R.O. 126072)

Special

14 272 0370 

TARGHETTA POSTERIORE
NAMEPLATE REAR
(R.O. 100042)

Super Sport

14 272 0260 

TARGHETTA POSTERIORE
NAMEPLATE REAR
(R.O. 150498)

125 Super

14 272 0420 

TARGHETTA POSTERIORE
NAMEPLATE REAR
(R.O. 120792)

Rally

14 272 0540 

TARGHETTA POSTERIORE
NAMEPLATE REAR
PIAGGIO 50: Vespa 50 S • V5A1
(R.O. 152510)

vespa 50s

14 272 0550 

TARGHETTA POSTERIORE
NAMEPLATE REAR
PIAGGIO 50: Vespa Special V5B3T
(R.O. 152511)

50 special



14 272 1270



NEW

14 272 0570



14 272 0580



TARGHETTA POSTERIORE

NAME PLATE REAR

VESPA PK50 XL Rush
V5X4T
(R.O. 229276)

TARGHETTA POSTERIORE

NAMEPLATE REAR

PIAGGIO 200: Vespa Rally • VSE1T
(R.O. 152515)

TARGHETTA POSTERIORE

NAMEPLATE REAR

PIAGGIO 125: Vespa Et3 • VMB1
(R.O. 158562)



14 272 0530



14 272 0950



14 272 1020



TARGHETTA POSTERIORE

REAR NAMEPLATE

PIAGGIO 50: Vespa • V5A1
(R.O. 152509)

TARGHETTA POSTERIORE

REAR NAMEPLATE

PIAGGIO 125: Vespa Primavera • VMA2
(R.O. 145340)

TARGHETTA POSTERIORE

REAR NAMEPLATE

PIAGGIO 125: Vespa Ts • VNL3T
(R.O. 156202)



14 272 0510



14 272 0960



14 272 0970



TARGHETTA POSTERIORE

REAR NAMEPLATE

PIAGGIO 90: Vespa • V9A1
(R.O. 145341)

TARGHETTA POSTERIORE

REAR NAMEPLATE

PIAGGIO 150: Vespa Sprint Veloce • VLB1T
(R.O. 145342)

TARGHETTA POSTERIORE

REAR NAMEPLATE

PIAGGIO 50: Vespa Elestart • V5B4T
(R.O. 152512)





TARGHETTE ADESIVE
LABELS

14 272 0470

ETICHETTA MISCELA 2%
2% FUEL MIXTURE LABEL
10 pezzi - 10 pcs
(R.O. 610054M003)



14 272 0480

ETICHETTA MISCELA 2%
2% FUEL MIXTURE LABEL
10 pezzi - 10 pcs
(R.O. 610054M00R)



14 272 0490

ETICHETTA MISCELA 5%
5% FUEL MIXTURE LABEL
10 pezzi - 10 pcs
(R.O. 61 0054M001)



14 272 1030

ETICHETTA RODAGGIO ROSSA
RUNNING RED LABEL
Vespa Gs 150
10 pezzi - 10 pcs
(R.O. 610292M)



14 272 1040

ETICHETTA RODAGGIO ROSSA
RUNNING RED LABEL
Vespa Rally 180
10 pezzi - 10 pcs
(R.O. 610170M)



14 272 1050

ETICHETTA RODAGGIO ROSSA
RUNNING RED LABEL
Vespa 50-90
10 pezzi - 10 pcs
(R.O. 610170M002)



14 272 1060

ETICHETTA RODAGGIO BLU
RUNNING BLUE LABEL
Vespa Rally 180
10 pezzi - 10 pcs
(R.O. 610170M001)



14 272 1070

ETICHETTA RODAGGIO BLU
RUNNING BLUE LABEL
Vespa 50-90
10 pezzi - 10 pcs
(R.O. 610170M003)



14 272 1080

ETICHETTA BENZINA
FUEL LABEL

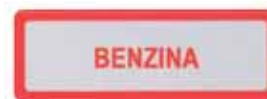

14 272 1230

TARGHETTA NON OSTRUIRE IL FORO ROSSA
RED LABEL
4 pezzi - 4 pcs
(R.O. 610176M)



14 272 1240

TARGHETTA NON OSTRUIRE IL FORO BLU
BLU LABEL
4 pezzi - 4 pcs
(R.O. 610176M0001)





14 272 0150 

TARGHETTA PER COFANO LATERALE
NAMEPLATE FOR SIDE PANEL
(R.O. 577081)

14 272 0190 

TARGHETTA PER COFANO LATERALE
NAMEPLATE FOR SIDE PANEL
(R.O. 575795)

14 272 0200 

TARGHETTA PER COFANO LATERALE
NAMEPLATE FOR SIDE PANEL
(R.O. 575796)



PX125

PX150

14 272 0460 

TARGHETTA PER COFANO LATERALE
NAMEPLATE FOR SIDE PANEL
PIAGGIO 150: Vespa Px 11
(R.O. 656220)

14 272 0600 

TARGHETTA PER COFANO LATERALE
NAME PLATE FOR SIDE PANEL
PIAGGIO 200: Vespa Pe • VSX
(R.O. 181328)

14 272 0610 

TARGHETTA PER COFANO LATERALE
NAMEPLATE FOR SIDE PANEL
PIAGGIO 150: Vespa Px • VLX
(R.O. 182117)



P200E

P150X

14 272 0620 

TARGHETTA PER COFANO LATERALE
NAMEPLATE FOR SIDE PANEL
PIAGGIO 125: Vespa Px E • VNX
(R.O. 194717)

14 272 0630 

TARGHETTA PER COFANO LATERALE
NAMEPLATE FOR SIDE PANEL
PIAGGIO 150: Vespa Px E • VLX
(R.O. 194718)

14 272 0670 

TARGHETTA PER COFANO LATERALE
NAMEPLATE FOR SIDE PANEL
PIAGGIO 125: Vespa Pk S • Vmx1T
(R.O. 195635)

PX125E

PX150E

PK 125 S

14 272 0680 

TARGHETTA PER COFANO LATERALE
NAMEPLATE FOR SIDE PANEL
PIAGGIO 200: Vespa Px E • VSX
(R.O. 195641)

14 272 0660 

TARGHETTA PER COFANO LATERALE
NAME PLATE FOR SIDE PANEL
PIAGGIO 125: Vespa Pk • VMX1T
(R.O. 195634)

14 272 0690 

TARGHETTA PER COFANO LATERALE
NAME PLATE FOR SIDE PANEL
PIAGGIO 50: Vespa Elestart • V5B2T
(R.O. 196459)

PX200E

PK 125

elestart



TARGHETTE LATERALI

SIDE PANEL BADGE

14 272 0700 

TARGHETTA PER COFANO LATERALE
NAMEPLATE FOR SIDE PANEL

PIAGGIO 125: Vespa Px E Elestart • VNX2
(R.O. 198179)



14 272 0710 

TARGHETTA PER COFANO LATERALE
NAMEPLATE FOR SIDE PANEL

PIAGGIO 125: Vespa Px E Arcobaleno • VNX2
(R.O. 198181)



14 272 0720 

TARGHETTA PER COFANO LATERALE
NAMEPLATE FOR SIDE PANEL

PIAGGIO 155: Vespa Pv E Arcobaleno • VLX2
(R.O. 198182)



14 272 0730 

TARGHETTA PER COFANO LATERALE
NAMEPLATE FOR SIDE PANEL

PIAGGIO 200: Vespa Px E Arcobleno • VSX2
(R.O. 198183)



14 272 0740 

TARGHETTA PER COFANO LATERALE
NAMEPLATE FOR SIDE PANEL

PIAGGIO: Vespa T5 • VNX5T
(R.O. 241316)



14 272 0750 

TARGHETTA PER COFANO LATERALE
NAME PLATE FOR SIDE PANEL

PIAGGIO 125-150-200: Cosa • VLR1T • VLR • VSR1
(R.O. 254293)



14 272 0760 

TARGHETTA PER COFANO LATERALE
NAMEPLATE FOR SIDE PANEL

PIAGGIO 50: Vespa N • V5A1T
(R.O. 256452)



14 272 0780 

TARGHETTA PER COFANO LATERALE
NAMEPLATE FOR SIDE PANEL

PIAGGIO 80: Vespa Px E • V8X5T
(R.O. 198180)



14 272 0940 

TARGHETTA PER COFANO LATERALE
NAME PLATE FOR SIDE PANEL

INNOCENTI 125-150-200: Lambretta Li 3° serie
(R.O. 19955051)



14 272 0590 

TARGHETTA PER COFANO LATERALE
NAME PLATE FOR SIDE PANEL

PIAGGIO 125: Vespa Px • VNX
(R.O. 181327)



14 272 0650 

TARGHETTA PER COFANO LATERALE
NAME PLATE FOR SIDE PANEL

PIAGGIO 50: Vespa Pk S • V5X1T
(R.O. 195631)



14 272 0770 

TARGHETTA PER COFANO LATERALE
NAME PLATE FOR SIDE PANEL

PIAGGIO 150: Vespa P S • VBX
(R.O. 182895)



TARGHETTE LATERALI
SIDE PANEL BADGE



14 272 0790 

TARGHETTA PER COFANO LATERALE
NAME PLATE FOR SIDE PANEL
PIAGGIO 150: Vespa Px E Elestart • VLX2
(R.O. 198657)



14 272 0800 

TARGHETTA PER COFANO LATERALE
NAME PLATE FOR SIDE PANEL
PIAGGIO 200: Vespa Px E Elestart • VSX2
(R.O. 198658)



14 272 0990 

TARGHETTA PER COFANO LATERALE
NAME PLATE FOR SIDE PANEL
PIAGGIO 50: Vespa Pk • V5X1T
(R.O. 195630)



14 272 1000 

TARGHETTA PER COFANO LATERALE
NAME PLATE FOR SIDE PANEL
PIAGGIO 80: Vespa Pk S Elestart • V5X2T
(R.O. 198199)



14 272 1140 

TARGHETTA PER COFANO LATERALE
NAME PLATE FOR SIDE PANEL
PIAGGIO 125: Vespa Px E • Lusso
(R.O. 199362)



14 272 1150 

TARGHETTA PER COFANO LATERALE
NAME PLATE FOR SIDE PANEL
PIAGGIO 150: Vespa Px E Lusso
(R.O. 199363)



14 272 1180 

TARGHETTA PER COFANO LATERALE
NAME PLATE FOR SIDE PANEL
PIAGGIO 200: Vespa Px E Elestart Lusso
(R.O. 199366)



14 272 1010 

TARGHETTA PER COFANO LATERALE
NAME PLATE FOR SIDE PANEL
PIAGGIO 100: Vespa Pk S Elestart • V9X1T
(R.O. 198201)



14 272 1110 

TARGHETTA PER COFANO LATERALE
NAME PLATE FOR SIDE PANEL
PIAGGIO 125-150: Vespa Px Mod. 11
(R.O. 656219)



14 272 1120 

TARGHETTA PER COFANO LATERALE
NAME PLATE FOR SIDE PANEL
PIAGGIO 200: Vespa Px 98-11 • VSX1T
(R.O. 575797)



14 272 1130 

TARGHETTA PER COFANO LATERALE
NAME PLATE FOR SIDE PANEL
PIAGGIO 80: Vespa Px E Lusso
(R.O. 199361)



14 272 1160 

TARGHETTA PER COFANO LATERALE
NAME PLATE FOR SIDE PANEL
PIAGGIO 200: Vespa Px E Lusso
(R.O. 199364)





TARGHETTE LATERALI

SIDE PANEL BADGE

14 272 1170 

TARGHETTA PER COFANO LATERALE
NAME PLATE FOR SIDE PANEL

PIAGGIO 80: Vespa Px E Elestart Lusso
(R.O. 199365)



14 272 1210 

TARGHETTA PER COFANO LATERALE
NAMEPLATE FOR SIDE PANEL

PIAGGIO 50: Vespa S 4T 4V • Vespa S 2T
125: Vespa Gts 4T ie Super • Vespa S 4T 3V ie
300: Vespa Gts Super Sport
(R.O. 672061)



14 272 1220 

TARGHETTA PER COFANO LATERALE
NAMEPLATE FOR SIDE PANEL

PIAGGIO 50: Vespa Lx 2T Touring 10-13 •
Vespa Lx 2T 05-13 • Vespa Lx 4T 4V 10-13 •
Vespa Lx 4T 05-08
(R.O. 656221)



14 272 1250 

TARGHETTA PER COFANO LATERALE
NAME PLATE FOR SIDE PANEL

PIAGGIO: Vespa Gs mercato tedesco
german model
(R.O. 226542)



14 272 1260 

TARGHETTA PER COFANO LATERALE
NAME PLATE FOR SIDE PANEL

PIAGGIO: Ciao
(R.O. 163966)



12 185 0010 

MOLLETTA FISSAGGIO TARGHETTA
PLATE FIXING SPRING

PIAGGIO: Vespa tutti i tipi
(R.O. 008108)
(Conf. 100 pz.)



14 272 1090 

PIAGGIO 200: Vespa Rally • Vse
(R.O. 610193M)



14 272 1100 

PIAGGIO 125: Vespa Et3 • VMB
(R.O. 610194M)





RMS
YOUR BEST PARTNER

▶ BATTERIE

BATTERIES



PERCHÉ SCEGLIERE LI-ON BATTERY?

Lo speciale metodo costruttivo delle batterie **LI-ON** permette di avere una batteria con un eccellente rapporto prestazioni/volume.

Per facilitare il montaggio della batteria senza intervenire sul cablaggio elettrico o creare problemi di corretto alloggiamento e fissaggio, le batterie **LI-ON** sono dotate di appositi distanziali modulari che consentono di raggiungere le dimensioni della batteria standard che si sostituisce.

Ciò permette prestazioni eccezionali, peso contenuto e facile installazione evitando soluzioni approssimative di fissaggio e di realizzazione come nel caso di batterie al litio oggi in commercio.

Le batterie **LI-ON** garantiscono una notevole versatilità per applicazioni sia racing che custom e possono essere ricaricate usando l'apposito caricabatterie **LI-ON**.

WHY CHOOSE LI-ON BATTERY?

*The special construction method of **LI-ON** allows you to have a battery with an excellent performance /volume and high versatility. It's very easy to assembly*

***LI-ON** batteries.*

*Without changing the electrical wiring system or create problems for proper housing, the **LI-ON** batteries are equipped with special modular spacers which allow to reach the same dimensions as the standard battery that you are replacing.*

This means exceptional performances, low weight and easy installation avoiding imprecise solutions for fixing and construction as in the case of lithium batteries today on the market.

***LI-ON** provide considerable versatility for both racing and custom applications and can be recharged with dedicated charger by **LI-ON**.*

DISTANZIALI MODULARI / MODULAR SPACERS

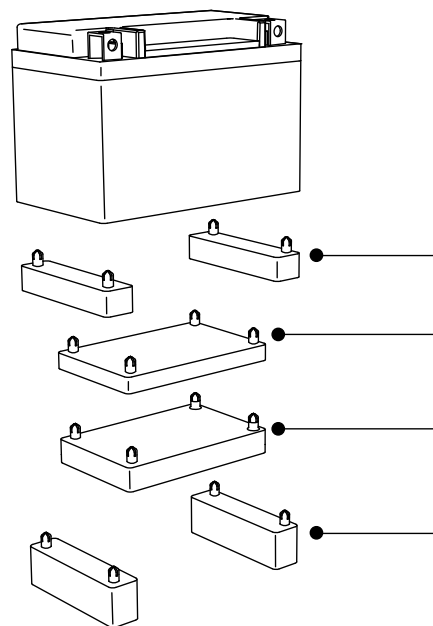

Indicatore di carica della batteria
Battery Charge Indicator



Più leggere delle batterie convenzionali al piombo-acido
Lighter than LEAD-ACID batteries



Capacità di Ricarica
Charging Capability













Cicli di Ricarica
Charging Cycles

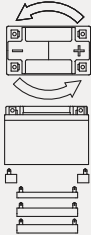

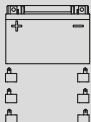
LiFePO₄ TECHNOLOGY

MODELLO MODEL	SOSTITUISCE CAN REPLACE	DIMENSIONI POLI DIMENSIONS TERMINAL (mm)	Distanziali Modulari MODULAR SPACERS (mm)	PESO WEIGHT (Kg)	CORRENTE DI CARICA CHARGE CURRENT (AMP)		SPUNTO CRANKING (CCAMP) TESTED BY ARGUS (AA500P)	BARCODE
					STD	MAX		
LTZ55 24 664 0010 	YTZ55 YTX4L-BS YTX5L-BS	 113x70x85	100x50x10 (2 pz - 2 pcs)	0,5	1	10	120	
LTZ75 24 664 0020 	YTZ75 YTX7L-BS	 113x70x85	100x50x10 (1 pz - 1 pcs) 100x50x15 (3 pz - 3 pcs)	0,6	1	12	150	
LTZ10S 24 664 0030 	YTZ10S	 150x87x93		0,9	2	20	240	
LTZ14S 24 664 0040 	YTZ12S YTZ14S	 150x87x93	86x20x17 (2 pz - 2 pcs)	1,1	2	22	290	
LT9B 24 664 0050 	YT7B-BS YT9B-BS	 150x65x92	64x20x13 (2 pz - 2 pcs)	0,7	1,5	15	190	
LT12B 24 664 0060 	YT12B-BS YT14B-BS YB16AL-A2	 150x65x92	64x20x13 (2 pz - 2 pcs) 64x19x38 (2 pz - 2 pcs)	1,1	2,5	24	290	
LTX9 24 664 0070 	YTX9-BS YTR9-BS	 150x87x105		0,7	1,5	15	180	
LTX12 24 664 0080 	YTX12-BS YTX12A-BS YB12B-B2	 150x87x93	100x50x10 (1 pz - 1 pcs) 86x20x17 (4 pz - 4 pcs)	0,9	2	18	210	

MODELLO MODEL	SOSTITUISCE CAN REPLACE	DIMENSIONI POLI DIMENSIONS TERMINAL (mm)	DISTANZIALI MODULARI MODULAR SPACERS (mm)	PESO WEIGHT (Kg)	CORRENTE DI CARICA CHARGE CURRENT (AMP)		SPUNTO CRANKING (CCAMP) TESTED BY ARGUS (AA500P)	BARCODE
					STD	MAX		
LTX14 24 664 0120 	YTX14H-BS KMX14-BS YTX14-BS HVT-8	 150x87x93	86x20x25 (4 pz - 4 pcs)	1,1	2	20	240	
LTX20H-Q 24 664 0090 	GYZ20H(L) YTX20H(L)-BS YTX20(L)-BS YB16-B-CX (S) YB16(L)-B YB18(L)-A(2) Y50-N18A-A GYZ20(L) YTX24H(L)-BS YTX15(L)-BS YTX18(L)-BS YB16H(L)-A-CX Y50-N18(L)-A-CX	 175x87x130	86x20x25 (2 pz - 2 pcs) 100x50x10 (1 pz - 1 pcs) 100x50x15 (2 pz - 2 pcs)	1,7	3,5	28	420	
LTX20CH 24 664 0100 	YTX16-BS YTX20CH-BS YB16B-A GYZ16H	 150x 87x105	86x20x17 (1 pz - 1 pcs) 86x21x25 (2 pz - 2 pcs)	1,4	3,5	28	360	
L51913 24 664 0110 	51814 51913 52015	 185x81x170		1,7	3,5	28	450	

24 670 0110 

CARICATORE - MANTENITORE PER BATTERIE AL LITIO
LITHIUM BATTERY CHARGER - MAINTAINER

- Corrente di carica - *Output current 2A*
- Adatto per batterie fino a 50 Ah - *Up to 50 Ah*
- Protezione da corto circuito - *Short circuit protection*
- Protezione contro inversione di polarità - *Polarity reverse protection*
- Protezione da sovraccarico - *Over charge protection*



BATTERIE LION R

BATTERIE AL LITIO RACING

La linea di batterie al litio **LION** si arricchisce della nuova linea **R**.

Le batterie **LION R** si contraddistinguono per la capacità di unire ad un formidabile spunto per l'avviamento dimensioni estremamente ridotte.

Ciò permette il loro posizionamento in modo facile su moto da cross, enduro, sportive racing, moto custom ed in ogni situazione dove si necessita di una batteria performante, di peso estremamente ridotto, con dimensioni ed un'autoscarica ridottissime.

Le batterie **LION R**, per via delle caratteristiche/dimensioni/spunto riescono a coprire, con solo 2 modelli, una gamma di batterie al piombo/acido che va da 5 Ah a 24 Ah con peso e dimensioni minime.

La linea **R** viene inoltre completata da un caricabatteria/mantenitore di carica professionale appositamente studiato per tenere sempre in ottimo stato le batterie **LION R**.

LION R BATTERY

RACING LITHIUM BATTERY





LION Lithium Batteries Line is enhanced of **R** version.

LION R batteries are characterized by a big cranking power and compact dimensions, that allows their placement in a easy way on motocross, offroad, supersport, custom bikes, and in any situation where needs a powerful battery, very low weight, small dimensions and with a very low selfdischarge.

R line is also completed by a battery charger/maintainer professionally designed to keep **LION R** batteries in good condition.

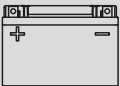
The **R** line is also complemented by a battery charger / maintainer upload professionally designed to keep the batteries in optimum state **LION R**

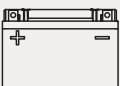

MODELLO MODEL	SOSTITUISCE CAN REPLACE	DIMENSIONI POLI DIMENSIONS TERMINAL (mm)	PESO WEIGHT (Kg)	CORRENTE DI CARICA CHARGE CURRENT (AMP)	SPUNTO CRANKING (CCAMP) TESTED BY ARGUS (AA500P)	BARCODE
				MAX		
LTR14 24 664 0130 	Batterie al piombo /acido da 5 a 14 Ah <i>Lead / acid batteries from 5 to 14 Ah</i>	 120x 60x92	0,9	14	210	
LTR24 24 664 0140 	Batterie al piombo /acido da 9 a 24 Ah <i>Lead / acid batteries from 9 to 24 Ah</i>	 148x82x135	1,4	24	360	

24 670 0130



CARICATORE - MANTENITORE PER BATTERIE AL LITIO
LITHIUM BATTERY CHARGER - MAINTAINER

- Corrente di carica 1-3 A - *Output current 1-3 A*
- Voltaggio 6-12 V - *Voltage 6-12 V*
- Protezione da corto circuito - *Short circuit protection*
- Protezione contro inversione di polarità - *Polarity reverse protection*
- Protezione da sovraccarico - *Over charge protection*



Hanno già scelto Li-On Battery:



Fornitore ufficiale



Yamaha World Endurance Official Team
French SBK Championship Team



Tourist Trophy STK 1000 - SBK 1000 - Senior TT
Road Racing SS 600

24 665 0485 

BATTERIA SLA - MAX BTX14HL (GEL)
Specifica per modelli Harley Davidson



24 665 0495 

BATTERIA SLA - MAX BTX20HL (GEL)
Specifica per modelli Harley Davidson



24 665 0505 

BATTERIA SLA - MAX BIX30HL (GEL)
Specifica per modelli Harley Davidson



24 665 0515 

BATTERIA SLA - MAX 51913
Specifica per modelli Bmw



24 665 0525 

BATTERIA SLA - MAX BTX14H
Specifica per modelli Bmw



TIPO DI BATTERIA BS	CAPACITA' AH (10HR)	CCA /EN)	DIMENSIONI mm (±2 mm)			LAYOUT	TERMINALE
			L	W	H		
24 665 0485	14	220	149	87	144		
24 665 0495	20	290	176	87	154		
24 665 0505	30	400	166	130	175*		
24 665 0515	21 (20Hr)	210	182	77	168		
24 665 0525	14	220	150	87	145		

* Disponibile con un distanziale alla base portando l'altezza a 197 mm.



• I terminali sono specificatamente disegnati per facilitare il montaggio sulle Harley Davidson.



• Speciale struttura esterna per una massima resistenza alle vibrazioni.



• La BTX20HL e la BIX30HL terminali specifici Harley Davidson.

• BTX14HL terminali specifici Harley Davidson.

NUOVA LINEA BATTERIE PRE-ATTIVATE

SLA
 FACTORY ACTIVATED
Ready to start!



CODICE	DESCRIZIONE	CCA / EN)	BARCODE
24 665 0015	Batteria BIX30L	400	
24 665 0025	Batteria 12-19	235	
24 665 0035	Batteria BTZ7S	130	
24 665 0045	Batteria BTZ10S	190	
24 665 0055	Batteria BTZ12S	215	
24 665 0065	Batteria BTZ14S	230	
24 665 0075	Batteria BT7B-4	110	
24 665 0085	Batteria BT9B-4	120	
24 665 0095	Batteria BT12B-4	210	
24 665 0105	Batteria BT14B-4	210	
24 665 0115	Batteria BB4L-B	50	
24 665 0125	Batteria BTR4A-5	35	
24 665 0135	Batteria BTX4L+	50	
24 665 0145	Batteria BTX5L	70	
24 665 0155	Batteria BB5L-B	65	
24 665 0165	Batteria BTX7A	105	
24 665 0175	Batteria BTX7L	100	
24 665 0185	Batteria BTX9	135	
24 665 0195	Batteria BB9-B	120	
24 665 0205	Batteria BB10L-B2	120	
24 665 0215	Batteria BT12A	175	
24 665 0225	Batteria BTX12	180	
24 665 0235	Batteria BTX14	200	
24 665 0245	Batteria BTX20L	270	

CODICE	DESCRIZIONE	CCA / EN)	BARCODE
24 665 0265	Batteria BT4B-5	40	
24 665 0275	Batteria BTX14AH	210	
24 665 0285	Batteria BB14L-A2	200	
24 665 0295	Batteria BTX14L	200	
24 665 0305	Batteria BTX16	230	
24 665 0315	Batteria BTX20CH	270	
24 665 0325	Batteria BTX20HL	270	
24 665 0335	Batteria BTX24HL	350	
24 665 0345	Batteria BB16CL-B	230	
24 665 0355	Batteria BTZ5S	65	
24 665 0365	Batteria BTZ6S	90	
24 665 0375	Batteria B50N18L-A	350	
24 665 0385	Batteria BB10L-A2	120	
24 665 0395	Batteria BB14L-B2	200	
24 665 0405	Batteria BB7L-B2	100	
24 665 0415	Batteria BB12AL-A2	150	
24 665 0425	Batteria BB14A-A2	170	
24 665 0435	Batteria BB16AL-A2	160	
24 665 0445	Batteria 12N5.5-3B	70	
24 665 0455	Batteria 12N5.5-4A	70	
24 665 0465	Batteria BB3L-B	35	
24 665 0475	Batteria BB7C-A	80	
24 665 0535	Batteria BTZ8V	120	
24 665 0545	Batteria 53030	280	

BS BATTERY / OEM CROSS REFERENCE

CODICE RMS RMS CODE	MODELLO BS BS MODEL	MODELLO OEM - OEM MODEL
24 665 0135	BTX4L + SLA	YTZ4V
24 665 0365	BTZ6S SLA	YTZ6V
24 665 0175	BTX7L SLA	YTZ7V
24 665 0535	BTZ8V SLA	YTZ8V
24 665 0025	SLA 12-19	YT19BL-BS

BS BATTERY / OEM CROSS REFERENCE

24 665 0525	BTX14H SLA MAX	GYZ16H
24 665 0485	BTX14HL SLA MAX	GYZ16HL
24 665 0495	BTX20HL SLA MAX	GYZ20HL
24 665 0505	BIX30HL SLA MAX	GYZ32HL
24 665 0515	51913 SLA MAX	GEL 12-19 EXIDE

MODELLO BATTERIA BATTERY MODEL	CAPACITÀ CAPACITY AH (10HR)	CCA A (-18°C)	DIMENSIONI DIMENSION			LAYOUT	TERMINALE TERMINAL	CODICE RMS RMS CODE	BARCODE
			mm (±2mm)						
			L	W	H				
BATTERIE STANDARD - STANDARD BATTERIES									
BB4L-B Con Acido a corredo <i>With electrolyte</i>	4	50	120	70	92		A	24 660 0065	
BB5L-B Con Acido a corredo <i>With electrolyte</i>	5	65	120	60	130		B	24 660 0085	
12N5.5-3B Con Acido a corredo <i>With electrolyte</i>	5,5	55	135	60	130		B	24 660 0295	
BB7-A Con Acido a corredo <i>With electrolyte</i>	8	85	135	75	133		B	24 660 0135	
BB7L-B2 Con Acido a corredo <i>With electrolyte</i>	8	124	135	75	133		A	24 660 0285	
BB9-B Con Acido a corredo <i>With electrolyte</i>	9	115	135	75	139		B	24 660 0155	
BB10L-A2 Con Acido a corredo <i>With electrolyte</i>	11	130	135	90	145		D	24 660 0445	
BB10L-BP Con Acido a corredo <i>With electrolyte</i>	11	165	135	90	145		B	24 660 0185	
BB10L-B2 Con Acido a corredo <i>With electrolyte</i>	11	130	135	90	145		D	24 660 0195	
BB12AL-A Con Acido a corredo <i>With electrolyte</i>	12	155	134	80	160		B	24 660 0255	
BB12AL-A2 Con Acido a corredo <i>With electrolyte</i>	12	155	134	80	160		B	24 660 0275	
BB12A-B Con Acido a corredo <i>With electrolyte</i>	12	155	134	80	160		B	24 660 0455	
BB12A-A Con Acido a corredo <i>With electrolyte</i>	12	155	134	80	160		B	24 660 0715	
BB14L-A2 Con Acido a corredo <i>With electrolyte</i>	14	175	134	89	166		D	24 660 0435	
BB14-A2 Con Acido a corredo <i>With electrolyte</i>	14	175	134	89	166		D	24 660 0335	
BB16AL-A2 Con Acido a corredo <i>With electrolyte</i>	16	210	207	71,5	164		F	24 660 0385	
51913 Con Acido a corredo <i>With electrolyte</i>	19 (20Hr)	210	186	82	171		G	24 660 0755	
B60-N30L-A (53030) Con Acido a corredo <i>With electrolyte</i>	30	300	184	130	170		G	24 660 0745	

TERMINAL TYPE	A	B	D	F	G
3D DRAWING					

MODELLO BATTERIA BATTERY MODEL	CAPACITÀ CAPACITY AH (10HR)	CCA A (-18°C)	DIMENSIONI DIMENSION			LAYOUT	TERMINALE TERMINAL	CODICE RMS RMS CODE	BARCODE
			mm (±2mm)						
			L	W	H				
BATTERIE SIGILLATE - MAINTANCE FREE (Tutte fornite con acido a corredo - All supplied with electrolyte)									
BTX4L-BS+	4,2	50	113	70	85		A	24 661 0025	
BTX5L-BS	4	80	113	70	105		A	24 661 0045	
BTX7L-BS	6	100	113	70	130		A	24 661 0065	
BTX7A-BS	6	105	150	87	93		A	24 661 0055	
BTZ7S-BS	6	130	113	70	105		A	24 661 0195	
BT7B-BS	6,5	85	150	65	93		A	24 661 0155	
BTX9-BS	8	135	150	87	105		A	24 661 0095	
BT9B-BS	8	110	150	68	105		A	24 661 0165	
BTZ10S-BS	8,5	190	150	88	91		A	24 661 0175	
BT9A-BS	9	120	135	75	139		A	24 661 0105	
BTX12-BS	10	180	150	87	130		A	24 661 0115	
BT12A-BS	10	175	150	88	105		A	24 661 0225	
BT12B-BS	10	210	150	69	130		A	24 661 0125	
BTZ12S-BS	11	215	150	88	110		A	24 661 0185	
BTZ14S-BS	11,2	230	150	88	110		A	24 661 0215	
BTX14-BS	12	200	150	87	145		A	24 661 0135	
BTX14L-BS	12	200	150	87	145		A	24 661 0205	
BTX16-BS	14	230	150	87	161		A	24 661 0145	
BTX20L-BS	18	270	175	87	155		A	24 661 0075	
BTX20HL-BS	18	310	175	87	155		A	24 661 0255	

TERMINAL TYPE	A	B	D	F	G
3D DRAWING					

24 670 0010 

BA10 - CARICABATTERIE AUTOMATICO

- 6V/12V - 1000mA
- Caricabatterie e mantentore di carica
- 3 livelli di carica controllata
- Protezione contro il corto circuito
- Selezione tensione di uscita a 6V/12V



24 670 0090 

BS15 - CARICABATTERIE AUTOMATICO

- 12V 1500mA
- Caricatore e mantentore
- Funzione desolfatazione
- 8 fasi di ricarica: verifica dello stato della batteria, desolfatazione, carica di avviamento leggera, carica principale, carica di assorbimento, analisi della batteria, modalità alternata di mantenimento a lungo termine e ricarica
- Adatto per batterie fino a 30Ah
- Protezione contro il corto circuito, polarità invertita e sovraccarico
- Ideale per il mantenimento della batteria durante il periodo invernale
- Pinze in dotazione



24 670 0190 

BS60 - CARICABATTERIE AUTOMATICO

- Caricabatterie automatico ad 9 fasi
- 12V 1000mA / 4000mA / 6000mA
- Caricatore e mantentore
- Funzione desolfatazione
- 9 fasi di ricarica: verifica dello stato della batteria, desolfatazione, carica di avviamento leggera, carica principale, carica di assorbimento, analisi della batteria, livellamento della carica, modalità alternata di mantenimento a lungo termine e ricarica
- Adatto per batterie fino a 120Ah
- Protezione contro il corto circuito, polarità invertita e sovraccarico



24 670 0180 

JUMP STARTER BS PB-01 12A

- Tipo di batteria: Litio ferro 12V 44Wh
- Spunto 200A
- Spunto iniziale 400A
- Dimensioni (mm): 170x82x32
- Uscite: Usb 5V 2,1A / DC 12V 10A
- Peso 408 Gr.



	BA 10	BS 15	BS 60
TIPO:	AUTOMATIC	SMART	SMART
Corrente di alimentazione <i>Input range</i>	100-240 Vac	100-240 Vac	100-240 Vac
Frequenza <i>Frequency</i>	50/60 Hz	50/60 Hz	50/60 Hz
Corrente di carica <i>Output current</i>	1A	1,5A	1/4/6A
Adatto per batterie <i>Suitable for</i>	6V&12V	12V	12V
Funzione rinnovamento <i>Rejuvenation mode</i>	-	Si Yes	Si Yes
Funzione equalizzazione <i>Equalization mode</i>	-	Si Yes	Si Yes
Capacità (Ah) - <i>Capacity</i>			
- Carica - <i>Charging range</i>	2-40	4-30	3-120
- Mantenimento - <i>Maintenance</i>	2-60	4-120	3-180
Dimensioni mm <i>Dimensions</i>	100*65*36	149*71*32	182*88*48
Peso - <i>Weight</i>	0,4 Kg	0,45 Kg	0,75 Kg
Tipi batterie - <i>Battery types</i>	GEL, AGM, PIOMBO, CALCIO		

24 670 0100**BK10 - CARICABATTERIE PROFESSIONALE MULTIPLIO**

- 12V - 1000mA x 10
- Caricabatterie e mantentore di carica fino a 10 batterie da 2 A a 40 A
- Tre livelli di controllo di carica
- Protezione interna di calore
- Regolato tramite microprocessore
- Pinze in dotazione ad alta resistenza di corrosione
- Protezione contro il corto circuito, polarità invertita e sovraccarico
- Dimensioni: 401x151x73
- Peso: 3,6 Kg.

**24 670 0140****BK15 - CARICABATTERIE PROFESSIONALE MULTIPLIO**

- 12V - 1500mA x 5
- Caricabatterie e mantentore di carica fino a 5 batterie da 2 A a 40 A
- Funzione di ricondizionamento delle piastre
- 8 Fasi di carica
- Protezione interna di calore
- Regolato tramite microprocessore
- Pinze in dotazione ad alta resistenza di corrosione
- Protezione contro il corto circuito, polarità invertita e sovraccarico

**24 670 0040****BT01 - TESTER CARICA BATTERIA**

- Mostra la condizione di carica della batteria al premere del pulsante

**24 670 0050****BT02 - TESTER BATTERIA E ALTERNATORE**

- Mostra la condizione di carica della batteria e verifica il corretto funzionamento dell'alternatore

**24 670 0060****CONNETTORE ACCENDISIGARI**

Adattabile a tutti i caricabatterie 6V-12V

**24 670 0070****CONNESSIONE PERMANENTE PER CARICA BATTERIE E BATTERIE IN MODALITA' MANTENIMENTO****24 670 0200****CL-01 PINZE PER CARICABATTERIE**

Compatibile con caricabatterie BS: BA09, BA10, BS15, BS20, BS40, BS60 BS80 & PA-03

**24 670 0210****CL-02 PINZE PER CARICABATTERIE**

Compatibile con caricabatterie BS: BA09, BA10, BS15, BS20, BS40, BS60 BS80 & PA-03





MODELLO BATTERIA BATTERY MODEL	V	A/h	SPUNTO A(EN) CRAN- CKING POWER	DIMENSIONI DIMENSIONS (mm)			PESO CON ACIDO WEIGHT WITH ELECTROLYTE	VOLUME ACIDO (L) ELECTROLYTE CAPACITY (L)	POLARITA' POLARITY	CODICE RMS RMS CODE	TERMINALE TERMINAL	BARCODE
				L	W	H						

BATTERIE STANDARD - STANDARD BATTERIES

YB4L-B Con Acido a corredo <i>With electrolyte</i>	12	4	50	121	71	93	1,5	0,30		24 660 0060	2	
YB9-B Con Acido a corredo <i>With electrolyte</i>	12	9	130	137	76	135	3,1	0,60		24 660 0150	3	
YB10L-BP Con Acido a corredo <i>With electrolyte</i>	12	11	160	135	90	145	5,0	0,81		24 660 0180	3	
YB12AL-A Con Acido a corredo <i>With electrolyte</i>	12	12	165	135	81	160	4,1	0,70		24 660 0250	3	
BB14L-A2 Con Acido a corredo <i>With electrolyte</i>	12	14	190	134	89	166	4,1	0,70		24 660 0300	5	

BATTERIE SIGILLATE (Tutte fornite con acido a corredo - MF Batteries with acid pack)

YTX4L-BS	12	3	50	110	67	86	1,7	0,27		24 661 0020	2	
YTX5L-BS	12	4	70	113	70	103	1,9	0,31		24 661 0040	2	
YTX7A-BS	12	6	80	152	88	94	2,4	0,38		24 661 0050	2	
YTX7L-BS	12	6	80	114	71	131	2,5	0,33		24 661 0060	2	
YTZ7S-BS	12	6	120	114	70	108	2,1	0,3		24 661 0190	5	
YT7B-BS	12	6,5	120	150	65	92	2,6	0,40		24 661 0150	5	
YTX9-BS	12	8	120	145	82	106	3,2	0,45		24 661 0090	2	
YT9B-BS	12	8	155	150	70	105	3,4	0,48		24 661 0160	5	
YTZ10S-BS	12	8,6	210	150	87	93	3,2	0,50		24 661 0170	5	
YTX9A-BS	12	9	140	137	76	136	3,2	0,57		24 661 0100	3	
YTX12-BS	12	10	180	149	86	131	4,0	0,60		24 661 0110	2	
YT12B-BS	12	10	160	152	70	131	4,5	0,50		24 661 0120	5	
YT12A-BS	12	10	180	150	87	106	3,2	0,54		24 661 0200	5	
YTZ12S-BS	12	11	210	150	87	110	3,7	0,62		24 661 0180	5	
YTZ14S-BS	12	11,2	230	150	87	110	3,9	0,64		24 661 0210	5	
YTX14-BS	12	12	200	149	86	147	4,5	0,69		24 661 0130	2	

TERMINALI - TERMINALS			TERMINALI - TERMINALS			TERMINALI - TERMINALS					
N°	FRONTALE FRONT	LATERALE LATERAL	SUPERIORE SUPERIOR	N°	FRONTALE FRONT	LATERALE LATERAL	SUPERIORE SUPERIOR	N°	FRONTALE FRONT	LATERALE LATERAL	SUPERIORE SUPERIOR
1				3				5			
2				4				6			

24 670 0160



CARICABATTERIE - MANTENITORE DI CARICA AUTOMATICO
AUTOMATIC BATTERY CHARGER AND MAINTAINER

- Corrente di carica - *Output current 900 mA*
- Voltaggio - *Voltage 6V / 12V*
- Completamente automatico - *Fully automatic*



24 670 0170



CARICABATTERIE - MANTENITORE DI CARICA AUTOMATICO
AUTOMATIC BATTERY CHARGER AND MAINTAINER

- Corrente di carica - *Output current 1,5 A*
- Voltaggio - *Voltage 12V*
- Completamente automatico - *Fully automatic*



24 670 0120



JUMP STARTER 8000-12V

- Tipo di batteria: *Litio ferro 12V 24Wh*
Battery type: Lithium iron 12V 24Wh
- Capacità nominale - *Nominal capacity 24Wh*
- Spunto - *Cranking 200A*
- Spunto iniziale - *Cranking peak 400A*
- Dimensioni (mm): - *Dimensions (mm): 192x100x40*
- Adattatore accendisigari incluso - *Cigarettes charger included*
- Uscite: - *Output: Usb 5V 2,1A / DC 12V 8A*
- Peso - *Weight 500 Gr.*



24 670 0150



JUMP STARTER 20000-12V

- Tipo di batteria: *Litio ferro 12V 60Wh*
Battery type: Lithium iron 12V 60Wh
- Capacità nominale - *Nominal capacity 60Wh*
- Spunto - *Cranking 500A*
- Spunto iniziale - *Cranking peak 1200A*
- Dimensioni (mm): - *Dimensions (mm): 223x140x72*
- Adattatore accendisigari incluso - *Cigarettes charger included*
- Uscite: - *Output: Usb 5V 2,1A / 5V 1A DC 12V 8A*
- Peso - *Weight 1400 Gr.*



12 183 0733



CINGHIA BATTERIA - BELT

PIAGGIO 125-150-200: Vespa Px- Cosa-T5-
Pxe Arcobaleno-VNX-VLX-VSX-VNX5T-VLR1T-
VLR-VSR1-VNX2-VLX2-VSX2
(R.O. 218812)



12 183 0743



NEW

CINGHIA BATTERIA - BELT

PIAGGIO 50-150: Vespa Pk
(R.O. 90854)



▶ CANDELE
SPARK PLUGS





CANDELE
SPARK-PLUGS

Codice RMS <i>RMS Code</i>	Codice NGK <i>NGK Code</i>	Stock N°	Terminale - Terminal		
24 621 5073	B6ES	7310		3	
24 621 5051	B6HS	4510		3	
24 621 5074	B7ES	1111		3	
24 621 5054	B7HS	5110		3	
24 621 5078	B8EG	3430		3	
24 621 5058	B8ES	2411		3	
24 621 5055	B8HS	5510		3	
24 621 5987	B9EG	3530		3	
24 621 5052	B9ES	2611		3	
24 621 5992	B9HS	5810		3	
24 621 5014	BKR7EKC	7354		2	
24 621 5066	BM6A	5921		3	
24 621 5017	BP6ES	7811		3	
24 621 5080	BP6HS	4511		3	
24 621 5064	BP7ES	2412		3	
24 621 5079	BP8ES	2912		3	
24 621 5022	BPR6ES	7822		3	
24 621 5068	BPR7ES	2023		3	
24 621 5036	BPR7HS	6422		3	
24 621 5019	BPR8ES	3923		3	
24 621 5023	BR10EG	3830		3	
24 621 5082	BR10ES	4832		3	
24 621 5081	BR6ES	4922		3	
24 621 5029	BR6HS	3922		3	
24 621 5072	BR6HSA	4296		1	
24 621 5070	BR7ES	5122		3	
24 621 5008	BR7HS	4122		3	
24 621 6023	BR8ECM	3035		2	
24 621 5045	BR8EG	3130		3	
24 621 5009	BR8ES	5422		3	
24 621 5000	BR8HS	4322		3	
24 621 5069	BR8HSA	5539		1	
24 621 5063	BR9EG	3230		3	
24 621 5044	BR9EIX	3981		3	
24 621 5050	BR9ES	5722		3	
24 621 5020	BR9HS	4522		3	
24 621 5083	C7HSA	4629		1	
24 621 5018	CPR7EA-9	3901		1	
24 621 5084	CPR8E	7411		2	
24 621 5027	CPR8EA-9	2306		1	
24 621 5071	CR10EK	2360		1	
24 621 5038	CR6HSA	2983		1	
24 621 5049	CR7E	4578		1	
24 621 5059	CR7EB	4663		2	
24 621 5041	CR7EIX	7385		3	
24 621 5037	CR7EK	7546		1	
24 621 5056	CR7EKB	4455		2	
24 621 5001	CR7HSA	4549		1	
24 621 5047	CR8E	1275		1	
24 621 5048	CR8EB	7784		2	
24 621 5003	CR8EH-9	5666		1	
24 621 5039	CR8EHIX-9	3797		1	
24 621 5042	CR8EIX	4218		3	
24 621 5060	CR8EK	3478		1	
24 621 5011	CR8EKB	4374		2	

Codice RMS <i>RMS Code</i>	Codice NGK <i>NGK Code</i>	Stock N°	Terminale - Terminal		
24 621 5006	CR9E	6263		1	
24 621 5061	CR9EB	6955		2	
24 621 5007	CR9EH-9	7502		1	
24 621 5035	CR9EHIX-9	6216		1	
24 621 5012	CR9EIA-9	6289		1	
24 621 6087	CR9EIB-9	92579		2	
24 621 5021	CR9EIX	3521		3	
24 621 5004	CR9EK	4548		1	
24 621 5030	D7EA	7912		1	
24 621 5024	D8EA	2120		1	
24 621 5552	DCPR7E	3932		3	
24 621 5559	DCPR8E	4179		2	
24 621 5053	DCPR8E	4339		3	
24 621 5076	DCPR8EIX	6546		3	
24 621 5062	DCPR8EKC	7168		2	
24 621 5025	DCPR9E	2641		2	
24 621 5026	DPR6EA-9	5531		1	
24 621 5010	DPR7EA-9	5129		1	
24 621 5002	DPR8EA-9	4929		1	
24 621 5065	DR7EA	7839		1	
24 621 5034	DR7ES	3123		1	
24 621 5005	DR8EA	7162		1	
24 621 5016	DR8ES	5423		1	
24 621 5013	DR8ES-L	2923		1	
24 621 5015	DR9EA	3437		1	
24 621 5031	ER9EH-6N	1673		1	
24 621 5613	IFR6G-11K	1314		2	
24 621 5067	IMR9C-9H	6777		1	
24 621 5033	IMR9C-9HES	5766		1	
24 621 5043	IMR9E-9HES	7556		1	
24 621 5032	JR9B	3188		1	
24 621 5091	KR8DI	4742		1	
24 621 5040	KR9CI	7795		2	
24 621 5046	LKAR8AI-9	6706		2	
24 621 5057	LMAR8A-9	4313		1	
24 621 6162	LMAR8D-J	93444		2	
24 621 6171	MAR10A-J	4706		2	
24 621 5028	MAR8B-JDS	8765		2	
24 621 6172	MAR9A-J	6869		2	
24 621 5077	PMR8B	6378		2	
24 621 6269	R0045Q-10	4216		1	
24 621 6275	R0373A-10	4940		1	
24 621 6283	R0451C-10	92278		1	
24 621 6285	R0465B-10	7506		1	
24 621 6177	SILMAR10A9S	7764		2	
24 621 6178	SILMAR9A9S	6213		2	

RMS	NGK	STOCK NUMBER
24 621 5088	L05EA	6667
24 621 5089	LD05F	8060
24 621 5090	SB05F	8080
24 621 5086	SD05F	8022
24 621 5085	VB05F	8032
24 621 5087	XD05F	8072

24 621 5085

CODICE NGK - NGK CODE: VB05F
STOCK NUMBER: 8032

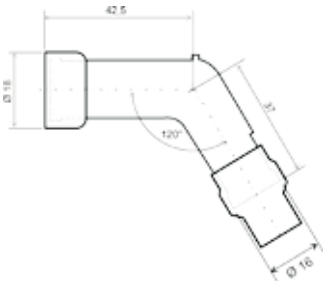

24 621 5086

CODICE NGK - NGK CODE: SD05F
STOCK NUMBER: 8022

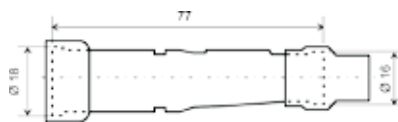

24 621 5087

CODICE NGK - NGK CODE: XD05F
STOCK NUMBER: 8072

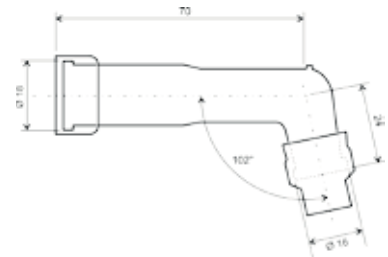

24 621 5088

CODICE NGK - NGK CODE: L05EA
STOCK NUMBER: 6667

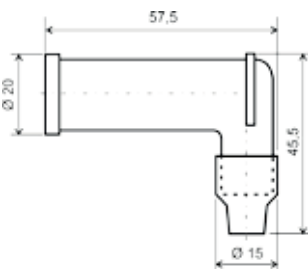

24 621 5089

CODICE NGK - NGK CODE: LD05F
STOCK NUMBER: 8060

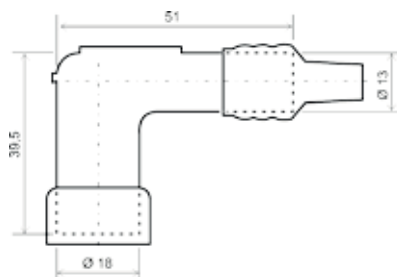

24 621 5090

CODICE NGK - NGK CODE: SB05F
STOCK NUMBER: 8080





CANDELE
SPARK-PLUGS

CODICE RMS RMS CODE	BARCODE	CODICE CHAMPION CHAMPION CODE
24 621 0700		A59C
24 621 0710		C53CX
24 621 0720		C55
24 621 0730		C55CX
24 621 0740		C55R
24 621 0750		C57
24 621 0770		C59R
24 621 0760		C61
24 621 0780		C63YC
NEW 24 621 2990		CCH587
24 621 0970		CJ6
24 621 0980		CJ7Y
24 621 0120		CJ8
24 621 1000		D14
24 621 1020		D6
24 621 1030		D9
24 621 1040		DJ8J
24 621 0790		G54V
24 621 0820		G59C
24 621 1050		H8C
24 621 1060		J12YC
24 621 1070		J4C
24 621 1080		J8C
24 621 1090		L77JC4
24 621 0200		L78C
24 621 1100		L78YC
24 621 0130		L82C
24 621 1130		L90C
24 621 0590		N3C
24 621 0110		N9YC
24 621 1720		OE004 - RN9YCC
24 621 1400		OE005 - RC9YC
24 621 0150		OE006/T10
24 621 1120		OE007 - L87YC

CODICE RMS RMS CODE	BARCODE	CODICE CHAMPION CHAMPION CODE
24 621 1690		OE008 - RN7YCC
24 621 0260		OE010-N7YC
24 621 1190		OE012 - N7BYC
24 621 1340		OE013 - RC12YC
24 621 1380		OE014 - RC7YCC
24 621 1160		OE015 - N12YC
24 621 1680		OE018 - RN7YC
24 621 1210		OE022 - N9YCC
24 621 0960		OE023 - C9YCC
24 621 1390		OE026 - RC8DMC
24 621 1470		OE031 - RES9YCC4
24 621 0100		OE037-L86C
24 621 0140		OE038/T10
24 621 1410		OE039 - RC9YC4
24 621 0330		OE042-RN12YC
24 621 1620		OE045 - RN11YCC
24 621 1710		OE048 - RN9YC4
24 621 1610		OE049 - RN11YC4
24 621 1600		OE051 - RN11YC
24 621 1320		OE052 - RA4HCX
24 621 1140		OE059 - L92YC
24 621 1570		OE064 - RL82YC
24 621 1150		OE065 - N11YC
24 621 0280		OE073-RA4HC
24 621 0340		OE074-N5C
24 621 0290		OE077-RC7BYC4
24 621 0360		OE078-N3G
24 621 0230		OE079-N4C
24 621 0240		OE083-RA6HC
24 621 0320		OE087-N6YC
24 621 0270		OE091-RN2C
24 621 0940		OE094 - RC6YCC
24 621 1640		OE098 - RN4C
24 621 0920		OE103 - A59GC

CODICE RMS <i>RMS CODE</i>	BARCODE	CODICE CHAMPION <i>CHAMPION CODE</i>	CODICE RMS <i>RMS CODE</i>	BARCODE	CODICE CHAMPION <i>CHAMPION CODE</i>
24 621 0600		OE108-RN3C	24 621 1830		REA6YC
24 621 0930		OE112 - A6GC	24 621 1460		REA8MCX
24 621 1670		OE116 - RN6YC	24 621 1480		RF11YC
24 621 0220		OE122-RG4PHP	24 621 1820		RG4HCX
24 621 1330		OE186 - RA8YCX4	24 621 0910		RG4YCX
24 621 1220		P7	24 621 1810		RG59V
24 621 1230		P8Y	24 621 0250		RG6YC
24 621 1240		P-RA7HC	24 621 1500		RG6YCA
24 621 0680		P-RG4HCC	24 621 1510		RH10C
24 621 1250		P-RG6HCC	24 621 1520		RH12
24 621 1260		P-RG7C	24 621 1530		RH8C
24 621 0400		P-RZ7HC	24 621 1540		RJ12C
24 621 1270		P-RZ9HC	24 621 1550		RJ18YC
24 621 0830		QA55V	24 621 0180		RJ19LM
24 621 0840		QC57	24 621 1560		RJ6C
24 621 0850		QC57C	24 621 0310		RL78C
24 621 0860		QC59C	24 621 0430		RL82C
24 621 0870		QC59YC	24 621 1580		RL86C
24 621 0880		QC61YC	24 621 1590		RL87YC
24 621 1280		QJ19LM	24 621 1630		RN13LYC
24 621 0890		QL55	24 621 0670		RN1C
24 621 1290		QL77JC4	24 621 1650		RN57YCC
24 621 1300		QN19V	24 621 1660		RN5C
24 621 0900		QN86	24 621 1730		RS14YC
24 621 1310		RA2HC	24 621 1740		RS14YC6
24 621 0350		RA59GC	24 621 1750		RV15YC4
24 621 0300		RA8HC	24 621 1760		RV17YC
24 621 1350		RC14YC	24 621 1770		UL81C
24 621 1360		RC7PYCBX	24 621 1780		W14
24 621 1370		RC7YC3	24 621 1790		Z6
24 621 1420		RCJ6Y	24 621 1800		Z9Y
24 621 1430		RCJ7Y			
24 621 1440		RCJ8Y			
24 621 1450		RD16			

CODICE RMS CODE RMS	BARCODE	CODICE - CODE CHAMPION POWER SPORT	CODICE - CODE NGK IRIIDIUM	CODICE - CODE NGK	APPLICAZIONI APPLICATIONS
24 621 0570		8018-1		BPR4FS BPR5FS	
24 621 0580		8071-1		BCPR7E BKR5E BKR5EVX	
24 621 0460		8332-1	BPR7EIX	BPR7ES BP7ES	Moto Guzzi anni (years) 90 Bmw boxer anni (years) 70 Yamaha monocilindrici 4T, serie Xv-Xs (Single Cyl. 4 Stroke, Xv Xs Series)
24 621 0480		8405-1	BPR5EIX	BPR4ES BP5ESA	Harley Davidson 1340
24 621 0490		8415-1	BPR6EIX	BP5ES BP6ES BPR6ES BPR5ES	Bmw boxer anni (years) 80-90 Harley Davidson anni (years) 70-80 Moto Guzzi anni (years) 90-00 Yamaha serie Xs 1100 (Xs 1100 Series)
24 621 0420		8654-1	-	CR10E CR10EK	Benelli 900 Kawasaki Serie (Series) Z-Zx-Zrx-Zzr Mv Agusta 750-910 Piaggio Vespa G.T. 125 Suzuki Serie (Series) Gsf-Sv-Gsx R Triumph 675-800-955 Yamaha Serie (Series) Fz-Fzr-Fzs-Yzf
24 621 0500		8698-1	CR8EIX CR8EIX-9 CR7EIX CR9EIX-9	CR6E CR7E CR8EK CR9EK CR9E CR8EH-9 CR9EH-9	Scooter 4T (4 Stroke) Gruppo Piaggio Peugeot Suzuki Scooter-Serie (Series) Sv-DL-Gsx R Moto Guzzi Yamaha Scooter 4T (4 Stroke), Serie (Series) Fjr-Wr 4T (4 Stroke)-Tmax Motori Kymco 4T raffreddati ad acqua (Kymco 4 Stroke water cooled engine) Kawasaki Serie (Series) Zx-Zzr-Er-Kx Honda Sh 125-150 Serie (Series) Cbr-Vfr-Transalp 90, Serie (Series) Silver Wing
24 621 0510		8809-1	DPR9EIX DR8EIX DR9EIX	D8EA D9EA DP8EA-9 DPR8EA-9 DPR9EA-9 DR7ES DR8EA DR9EA	Bmw Serie (Series) F-K 1100 1200 Buell Ducati 2V Aria (Air cooled) - 851-Serie (Series) 1000 Acqua (Water cooled) Harley Davidson Serie (Series) 883-1200 Honda Serie (Series) XL-Xr-Cbx 80-90 - Cbr Vfr 90 Kawasaki Serie (Series) Gpz-Gpx-Er-KLE Ktm 450-520-625-1000 Suzuki Serie (Series) Gsx-Dr 125 250 Yamaha Serie (Series) Xt 250>600-Fz-Fzr
24 621 0520		8810-1	DCPR7EIX	DCPR6E DCPR7E DPR7EA-9 DCPR8E	Harley Davidson 883-1200-1584 Custom Giapponesi (Japanese Custom Bike) Ktm 450-525-640
24 621 0410		8812-1	DPR7EIX-9	D6EA DP7EA-9 DPR6EA-9 DPR7EA-9	Bmw K75-K100 Harley Davidson 883-1450 Custom Giapponesi (Japanese Custom Bike) Kymco Scooter
24 621 0530		8814-1	BPR6HIX	BP6HS BP8HS BPR7HS BPR8HS	Aprilia Harley Davidson
24 621 0550		8902-1	BR8EIX	B8ES B9ES B10ES BR7ES BR8ES BR9ES	Moto Guzzi V75 Piaggio Vespa Pk 50-Cosa 125 200 Scooter gruppo Piaggio 50 2T (2 Stroke) Honda-Kawasaki-Yamaha 2T (2 Stroke)
24 621 0560		8904-1	BR9EIX BR8EIX	BR9EG BR8EG	Aprilia Rx-Rs 50 125 Cagiva 125 2T (2 Stroke) 90-00 Derbi Senda 50 Gilera 125 2T (2 Stroke) 80-90 Honda Ns-Nsr-Mtx 125 Moto Guzzi 650 750 Piaggio 2T (2 Stroke) 50>200 Husqvarna-Kawasaki-Ktm-Suzuki-Yamaha 2T (2 Stroke) Cross

DIMENSIONI CANDELE POWERSPORT - SPARK PLUGS DIMENSIONS

DIMENSIONI DIMENSIONS	CODICE RMS RMS CODE	MODELLO MODEL	A	B	C	D	TERMINALE TERMINAL
	24 621 0410	8812	12	19	18	0,8	3
	24 621 0420	8654	10	19	16	0,8	3
	24 621 0460	8332	14	19	21	0,7	2
	24 621 0470	8339	14	19	21	0,7	2
	24 621 0480	8405	14	19	21	1	2
	24 621 0490	8415	14	19	21	0,7	2
	24 621 0500	8698	10	19	16	0,8	3
	24 621 0510	8809	12	19	18	0,8	3
	24 621 0520	8810	12	19	16	1	2
	24 621 0530	8814	14	12	21	0,7	2
	24 621 0540	8883	14	12	21	0,7	2
	24 621 0550	8902	14	19	21	1	2
	24 621 0560	8904	14	19	21	0,7	2
	24 621 0570	8018	14	11,7	16	0,9	2
	24 621 0580	8071	14	19	16	0,9	2

CODICE RMS RMS CODE	BARCODE	CODICE CHAMPION CHAMPION CODE	CODICE RMS RMS CODE	BARCODE	CODICE CHAMPION CHAMPION CODE
24 621 1850		3071	24 621 2090		K97F/014
24 621 1860		3980	24 621 2110		L6VC/110
24 621 1870		8304-1/B01	24 621 2120		L76V/110
24 621 1880		8401-1/B01	24 621 2130		L78V/110
24 621 1890		8900-1/B01	24 621 2140		L78YC6/110
24 621 3010 NEW		CCH123	24 621 2150		L92LCC/012
24 621 3020 NEW		CCH514	24 621 2160		N19V
24 621 3050 NEW		CCH7696	24 621 2170		OE011
24 621 3040 NEW		CCH7859	24 621 2180		OE041
24 621 3030 NEW		CCH7953	24 621 2190		OE148
24 621 3060 NEW		CCH84051	24 621 2200		P10Y
24 621 3000 NEW		CCH955M	24 621 2210		QC10PEP/013
24 621 1900		CJ14	24 621 0620		QC10PEPB
24 621 1910		CJ4	24 621 0630		QC10WEP
24 621 1920		CJ6Y/W24	24 621 2220		QC12GMC/161
24 621 1930		CJ8Y	24 621 2230		QC12PEP/161
24 621 1940		D15Y/013	24 621 0650		QC12PEPB
24 621 1950		D16	24 621 2240		QC12YC
24 621 1960		D21/013	24 621 0640		QC8WEP
24 621 1970		D89D/014	24 621 2250		QCJ6Y
24 621 1980		DJ6J	24 621 2260		QCJ8Y
24 621 1990		DJ7J	24 621 2270		QL16V/110
24 621 2000		DJ7Y	24 621 2280		QL6VC/110
24 621 2010		H10C	24 621 2290		QL76V
24 621 2020		H12	24 621 2300		QL77CC/161
24 621 2030		J11C	24 621 2310		QL77PP/013
24 621 2040		J17LM	24 621 2320		QL78C
24 621 2050		J17LM/W24	24 621 2330		QL78V/110
24 621 2060		J19LM	24 621 2340		QL78YC/110
24 621 2070		J19LM/W24	24 621 2350		QL78YC6/110
24 621 2080		J6C	24 621 2360		QL82C/110
			24 621 2370		QL82YC/110
			24 621 2380		QL86C/110

CODICE RMS RMS CODE	BARCODE	CODICE CHAMPION CHAMPION CODE	CODICE RMS RMS CODE	BARCODE	CODICE CHAMPION CHAMPION CODE
24 621 2390		QL87YC/110	24 621 2690		RV12YC/012
24 621 2400		RC12MC4/012	24 621 2700		RV8C
24 621 2410		RC9MC4/012	24 621 2710		RV91MC/110
24 621 2420		RCJ4	24 621 2720		RV92YC
24 621 2430		RCJ8	24 621 2730		RV9YC/012
24 621 2440		RDJ6J	24 621 2740		RY4C
24 621 2450		RDJ7J	24 621 2750		RZ7C
24 621 2460		RDJ7Y	24 621 2760		RZF10
24 621 2470		RDJ8J	24 621 2770		UD16/013
24 621 2480		RDZ19H	24 621 2780		UJ11G/014
24 621 2490		RDZ4H	24 621 2790		UL18V
24 621 2500		RF10C	24 621 2800		UL77V
24 621 2510		RF14YC/013	24 621 2810		UY6/014
24 621 2520		RF9YC/012	24 621 2820		V57C-ST/003
24 621 2530		RH18Y	24 621 2830		V63C-ST/003
24 621 2540		RJ12YC	24 621 2840		W10/014
24 621 2550		RJ14YC	24 621 2850		W16Y/014
24 621 2560		RJ17LM	24 621 2860		W18/014
24 621 2570		RJ19LMC	24 621 2870		W20/014
24 621 2580		RJ88P	24 621 2880		W89D/014
24 621 2590		RJ8C	24 621 2890		XC10YC
24 621 2600		RL95YC	24 621 2900		XC12PEPB/110
24 621 2610		RN14YC/012	24 621 2910		XC12YC
24 621 2620		RN4YC	24 621 2920		XC92YC
24 621 2630		RP10HC/110	24 621 2930		XEJ8/014
24 621 2640		RS12PYP/013	24 621 2940		XEN14
24 621 2650		RS12YC/013	24 621 2950		XMJ14/014
24 621 0660		RS14PYP5	24 621 2960		XMJ17/014
24 621 2660		RS15LYC/013	24 621 2970		XMJ20/014
24 621 2670		RS17YX	24 621 2980		Y82/014
24 621 2680		RV12C			



CAPPUCCI CANDELE E CANDELETTE

SPARK PLUG BOOT - DIESEL GLOW PLUG

24 633 0140



**CAPPUCCIO CANDELA 90° SENZA
RESISTORE, INNESTO TERMINALE SAE**
*90° SPARK PLUG BOOT WITHOUT RESISTOR,
SAE CONNECTION*
(Codice Champion PRO-0U)



24 633 0150



**CAPPUCCIO CANDELA 90° CON RESISTORE,
INNESTO TERMINALE 1**
*90° SPARK PLUG BOOT WITH RESISTOR,
1 CONNECTION*
(Codice Champion PRO-5M)



24 633 0160



**CAPPUCCIO CANDELA 90° CON RESISTORE,
INNESTO TERMINALE SAE**
*90° SPARK PLUG BOOT WITH RESISTOR,
SAE CONNECTION*
(Codice Champion PRO-5U)



24 633 0170



**CAPPUCCIO CANDELA 180° CON RESISTORE,
INNESTO TERMINALE SAE**
*180° SPARK PLUG BOOT WITH RESISTOR,
SAE CONNECTION*
(Codice Champion SRO-5U)



24 621 0440



CANDELETTA DIESEL - DIESEL GLOW PLUG
PIAGGIO: Ape 0.5 D 83>
(Codice Champion CH260)



24 621 0450



CANDELETTA DIESEL - DIESEL GLOW PLUG
PIAGGIO: Porter 1.2 D 95>
(Codice Champion CH189)





24 633 0010 

Motori Minarelli 50 cc
 Innesto sulla candela \varnothing 6,3
 Spark plug cap \varnothing 6,3



24 633 0030 

Motori F. Morini 50 cc



24 633 0050 

PIAGGIO: Ciao • Bravo • Boxer • Cba • Si •
 Lambretta e applicazioni varie
 (R.O.103936)



24 633 0020 

Motori Minarelli 50 Cc
 Innesto sulla candela \varnothing 4
 Spark plug cap \varnothing 4



24 633 0040 

Motori Raffreddamento ad acqua 50 cc
 Water Cooling Engine 50 cc



12 183 0230 

PIAGGIO 50: Ape
50-125-150-200:
 Vespa tutti i modelli - All models
 (R.O. 244395)



24 633 0060 

In gomma speciale nera - Applicazioni varie
 Special black rubber - Various applications



24 633 0070 

In gomma al silicone - Silicon rubber
 Applicazioni varie - Various applications
 (colore: rosso - blu - color: red - blue)



24 633 0080 

In gomma speciale nera - Applicazioni varie
 Special black rubber - Various applications



12 183 0843 

PIAGGIO 150: Vespa Sprint • Sprint Veloce
 VLA - VLB
 (R.O. 46741)



24 633 0090 

Kit cappuccio candela - Spark plug cap set
APRILIA 50: Ditech Iniezione



24 633 0100 

In gomma al silicone - schermato
 Tenuta d'acqua-Innesto cavo \varnothing 7
 Innesto candela \varnothing 6,2
 Applicazioni: Moto, Ciclomotori, da strada e
 fuoristrada
 Silicone rubber, shielded, \varnothing 7 cable connec-
 tion, \varnothing 6,2 spark plug connections
 Applications: Street and Offroad motorcycles
 and moped.





CANDELE - CAPPUCCI CANDELE SPARK PLUGS - SPARK PLUG CAP SET

24 633 0110



In gomma al silicone - schermato
Tenuta d'acqua-Innesto cavo ø 7
Innesto candela ø 4-Ceramica candela Ø 10
Applicazioni: Moto, Ciclomotori, da strada e fuoristrada

Sylicone rubber, shielded, ø 7 cable connection, ø 4 spark plug connections, spark plug ceramic ø 10

Applications: Street and Offroad motorcycles and moped.



24 633 0120



In gomma al silicone - schermato
Tenuta d'acqua-Innesto cavo ø 7
Innesto candela ø 6,2-Ceramica candela Ø 12
Applicazioni: Moto, Ciclomotori, da strada e fuoristrada

Sylicone rubber, shielded, ø 7 cable connection, ø 4 spark plug connections, spark plug ceramic ø 12

Applications: Street and Offroad motorcycles and moped.



24 633 0130



In gomma al silicone - schermato
Tenuta d'acqua-Innesto cavo ø 7
Innesto candela ø 4-Ceramica candela Ø 12
Applicazioni: Moto, Ciclomotori, da strada e fuoristrada

Sylicone rubber, shielded, ø 7 cable connection, ø 4 spark plug connections, spark plug ceramic ø 12

Applications: Street and Offroad motorcycles and moped.



24 649 0010



Cavo candela Vespa - Ciclomotori
Spark plug cable Vespa - Moped
Rotolo da 10 mt ø mm 7
Packing 10/mtrs roll
(colore:nero - black color)



12 185 8470



12 185 8472



Attacco Candela a forcella Vespa
Spark Plugs Terminal Vespa
(Confezione 10 pz. - 10 pcs pack)
(R.O. 127966)



12 183 0560



Cappuccio Candela - Plug Device
PIAGGIO: Si
(R.O. 213751)



12 185 9100



Terminale candela Sae avvitabile
Sae Spark plug terminal with thread
(Confezione 100 pz. - 100 pcs pack)





24 648 0380 

COPPIA FRECCHE LED "DEMON" SILVER

- Alluminio Die Casting - Alloy Die Casting
- Luce Led - Led light
- Corpo Silver - Silver color
- **2 Pezzi - 2 pcs**

TRASPARENTE

E-MARK

LUCE LED

24 648 0381 

FRECCIA LED "DEMON" SILVER

- Alluminio Die Casting - Alloy Die Casting
- Luce Led - Led light
- Corpo Silver - Silver color
- **1 Pezzo - 1 pcs**

TRASPARENTE

E-MARK

LUCE LED

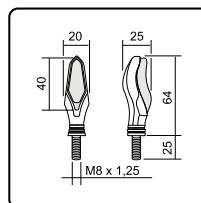

24 648 0390 

COPPIA FRECCHE LED "YAMATO" SILVER

- Alluminio Die Casting - Alloy Die Casting
- Luce Led - Led light
- Corpo Silver - Silver color
- **2 Pezzi - 2 pcs**

TRASPARENTE

E-MARK

LUCE LED

24 648 0391 

FRECCIA LED "YAMATO" SILVER

- Alluminio Die Casting - Alloy Die Casting
- Luce Led - Led light
- Corpo Silver - Silver color
- **1 Pezzo - 1 pcs**

TRASPARENTE

E-MARK

LUCE LED

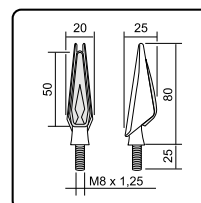

24 612 9020 

COPPIA RESISTENZE 25 W 8,2 Ω
COUPLE RESISTORS 25 W 8,2 Ω

- Con connettori - With connectors



24 612 9030 

RESISTENZA 50 W 7,5 Ω
RESISTOR 50 W 7,5 Ω

- Con connettori - With connectors



24 648 0490 

NEW

LUCE TARGA LED
PLATE NUMBER LIGHT

- Luce a led - Led light
- Universale - Universal

LUCE LED





FRECCE MOTO INDICATORS

24 648 0486



NEW

COPPIA FRECCHE LED BILUCE ANTERIORE LED INDICATORS + DAYLIGHT COUPLE

Adatte solo per anteriore - *Just for front use*
Luci di posizione anteriori incorporate
With daylight
Luce led - *Led light*
Corpo nero - *Black colour*

E-MARK

LUCE LED



24 648 0487



NEW

COPPIA FRECCHE LED BILUCE POSTERIORE LED INDICATORS + TAIL LIGHT AND STOP COUPLE

Adatte solo per posteriore - *Just for rear use*
Luci di posizione posteriori e stop incorporate
With rear light and stop light
Luce led - *Led light*
Corpo nero - *Black colour*

E-MARK

LUCE LED



24 648 0488



NEW

COPPIA FRECCHE LED LED INDICATORS COUPLE

Luce led - *Led light*
Corpo nero - *Black colour*

E-MARK

LUCE LED



24 648 0492



NEW

COPPIA FRECCHE LED BILUCE POSTERIORE LED INDICATORS + TAIL LIGHT AND STOP COUPLE

Adatte solo per posteriore - *Just for rear use*
Luci di posizione posteriori e stop incorporate
With rear light and stop light
Luce led - *Led light*
Corpo nero - *Black colour*

E-MARK

LUCE LED



24 648 0493



NEW

COPPIA FRECCHE LED LED INDICATORS COUPLE

Luce led - *Led light*
Corpo nero - *Black colour*

E-MARK

LUCE LED



24 648 0491



NEW

COPPIA FRECCHE LED BILUCE ANTERIORE LED INDICATORS + DAYLIGHT COUPLE

Adatte solo per anteriore - *Just for front use*
Luci di posizione anteriori incorporate
With daylight
Luce led - *Led light*
Corpo nero - *Black colour*

E-MARK

LUCE LED



24 648 0489



NEW

COPPIA FRECCHE LED LED INDICATORS COUPLE

Luce led - *Led light*
Corpo nero - *Black colour*

E-MARK

LUCE LED



24 648 0275



COPPIA FANALINI FRECCIA LED LED INDICATOR COUPLE

• Luce Led - *Led light*
• Corpo Nero - *Black colour*
• Coppia resistenze: 3W-27 Ω
Resistor couple: 3W-27 Ω

TRASPARENTE

E-MARK

LUCE LED



24 648 0280



COPPIA FANALINI FRECCIA INDICATOR COUPLE

• Corpo Nero - *Black colour*
• Lampada 12 V.-21 W.
Bulb 12 V.-21 W.

ARANCIO

E-MARK





24 648 0211 

COPPIA FANALINI FRECCIA LED
LED INDICATOR COUPLE

- Luce Led - *Led light*
- Corpo Nero - *Black colour*
- Coppia resistenze: 5W-31 Ω
Resistor couple: 5W-31 Ω



TRASPARENTE

E-MARK

LUCE LED

24 648 0218 

COPPIA FANALINI FRECCIA LED
LED INDICATOR COUPLE

- Luce Led - *Led light*
- Corpo Carbon - *Carbon colour*
- Coppia resistenze: 5W-31 Ω
Resistor couple: 5W-31 Ω



TRASPARENTE

E-MARK

LUCE LED

CARBON LOOK

24 648 0228 

COPPIA FANALINI FRECCIA LED
LED INDICATOR COUPLE

- Luce Led - *Led light*
- Corpo Carbon - *Carbon colour*
- Coppia resistenze: 5W-31 Ω
Resistor couple: 5W-31 Ω



TRASPARENTE

E-MARK

LUCE LED

CARBON LOOK

24 648 0208 

COPPIA FANALINI FRECCIA LED
LED INDICATOR COUPLE

- Luce Led - *Led light*
- Corpo Carbon - *Carbon colour*
- Coppia resistenze: 5W-31 Ω
Resistor couple: 5W-31 Ω



TRASPARENTE

E-MARK

LUCE LED

CARBON LOOK

24 648 0155 

COPPIA FANALINI FRECCIA LED
LED INDICATOR COUPLE

- Luce Led - *Led light*
- Corpo Nero - *Black colour*
- Coppia resistenze: 5W-31 Ω
Resistor couple: 5W-31 Ω



TRASPARENTE

E-MARK

LUCE LED

24 648 0160 

COPPIA FANALINI FRECCIA SLIM
LED INDICATOR COUPLE

- Luce Led - *Led light*
- Lente trasparente ovale ad incasso
Recessed oval clear lens
- Corpo Carbon - *Carbon colour*
- Packaging in blister
Blister packaging
- Coppia resistenze: 5W-31 Ω
Resistor couple: 5W-31 Ω



TRASPARENTE

E-MARK

LUCE LED

CARBON LOOK

24 648 0170 

COPPIA FANALINI FRECCIA TRIANGOLARI
TRIANGULAR INDICATOR COUPLE

- Luce Led - *Led light*
- Braccio lungo ammortizzato
Long arm suspension
- Lente esterna trasparente ad incasso
Recessed clear outer lens
- Corpo Carbon - *Carbon colour*
- Packaging in blister
Blister packaging
- Coppia resistenze: 5W-31 Ω
Resistor couple: 5W-31 Ω



TRASPARENTE

E-MARK

LUCE LED

CARBON LOOK

24 648 0140 

COPPIA FANALINI FRECCIA TRIANGOLARI
TRIANGULAR INDICATOR COUPLE

- Braccio lungo ammortizzato
Long arm suspension
- Corpo Carbon - *Carbon colour*
- Lente esterna trasparente
Recessed clear lens
- Lente interna arancio
Orange internal lens
- Lampada 12 V. - 21W.
Bulb 12 V. - 21W.
- Packaging in blister
Blister packaging



TRASPARENTE

E-MARK

CARBON LOOK

24 648 0020 

COPPIA FANALINI FRECCIA
INDICATOR COUPLE

- Lente triangolare ad incasso
Recessed triangular lens
- Braccio corto ammortizzato
Short arm suspension
- Corpo Carbon - *Carbon colour*
- Lente esterna trasparente
Recessed clear lens
- Lente interna arancio
Orange internal lens
- Lampada 12 V. - 21W.
Bulb 12 V. - 21W.
- Packaging in blister
Blister packaging



TRASPARENTE

E-MARK

CARBON LOOK



FRECCHE MOTO INDICATORS

24 648 0010 

COPPIA FANALINI FRECCIA INDICATOR COUPLE

- Braccio corto ammortizzato
Short arm suspension
- Corpo Carbon - *Carbon colour*
- Lente esterna arancio
Orange outer lens
- Lente triangolare ad incasso
Recessed triangular internal lens
- Lampada 12 V. - 21W.
Bulb 12 V. - 21W.
- Packaging in blister
Blister packaging



ARANCIO

E-MARK

CARBON LOOK

24 648 0060 

COPPIA FANALINI FRECCIA INDICATOR COUPLE

- Lente ovale fissaggio a vite
Screw fixing oval lens
- Braccio corto - *Short arm*
- Corpo Carbon - *Carbon colour*
- Lente esterna trasparente
Recessed clear lens
- Lente interna arancio
Orange internal lens
- Lampada 12 V. - 21W.
Bulb 12 V. - 21W.
- Packaging in blister
Blister packaging



TRASPARENTE

CARBON LOOK

E-MARK

24 648 0070 

COPPIA FANALINI FRECCIA SLIM INDICATOR COUPLE

- Lente arancio ovale ad incasso
Recessed orange oval lens
- Corpo Carbon - *Carbon colour*
- Packaging in blister
Blister packaging



ARANCIO

CARBON LOOK

Non omologate
per uso stradale

24 648 0080 

COPPIA FANALINI FRECCIA SLIM INDICATOR COUPLE

- Lente trasparente ovale ad incasso
Recessed clear oval lens
- Corpo Carbon - *Carbon colour*



TRASPARENTE

CARBON LOOK

Non omologate
per uso stradale

24 648 0130 

COPPIA FANALINI FRECCIA TRIANGOLARI TRIANGULAR INDICATOR COUPLE

- Braccio lungo ammortizzato
Long arm suspension
- Corpo nero - *Black colour*
- Lente esterna trasparente
Clear outer lens
- Lente interna arancio
Orange internal lens
- Lampada 12 V. - 21W.
Bulb 12 V. - 21W.
- Packaging in blister
Blister packaging



E-MARK

24 648 0090 

COPPIA FANALINI FRECCIA TRIANGOLARI TRIANGULAR INDICATOR COUPLE

- Braccio corto ammortizzato
Short arm suspension
- Corpo nero - *Black colour*
- Lente esterna trasparente
Clear outer lens
- Lente interna arancio
Orange internal lens
- Lampada 12 V. - 21W.
Bulb 12 V. - 21W.
- Packaging in blister
Blister packaging



E-MARK

24 648 0100 

COPPIA FANALINI FRECCIA TRIANGOLARI TRIANGULAR INDICATOR COUPLE

- Braccio corto ammortizzato
Short arm suspension
- Corpo cromato - *Chrome colour*
- Lente esterna trasparente
Clear outer lens
- Lente interna arancio
Orange internal lens
- Lampada 12 V. - 21W.
Bulb 12 V. - 21W.
- Packaging in blister
Blister packaging



E-MARK

24 648 0110 

COPPIA FANALINI FRECCIA OVALI OVAL INDICATOR COUPLE

- Braccio corto ammortizzato
Short arm suspension
- Corpo nero - *Black colour*
- Lente esterna trasparente
Clear outer lens
- Lente interna arancio
Orange internal lens
- Lampada 12 V. - 21W.
Bulb 12 V. - 21W.
- Packaging in blister
Blister packaging



E-MARK

24 648 0120 

COPPIA FANALINI FRECCIA OVALI OVAL INDICATOR COUPLE

- Braccio corto ammortizzato
Short arm suspension
- Corpo cromato - *Chrome colour*
- Lente esterna trasparente
Clear outer lens
- Lente interna arancio
Orange internal lens
- Lampada 12 V. - 21W.
Bulb 12 V. - 21W.
- Packaging in blister
Blister packaging



E-MARK



24 648 0255



FANALE FRECCIA ANTERIORE DESTRO
(Lente trasparente)
FRONT INDICATOR RIGHT (Clear lens)
YAMAHA: T Max 500 01/07



24 648 0265



FANALE FRECCIA ANTERIORE SINISTRO
(Lente trasparente)
FRONT INDICATOR LEFT (Clear lens)
YAMAHA: T Max 500 01/07



24 648 0400



FRECCIA ANTERIORE DESTRA
(Lente arancione)
FRONT INDICATOR RIGHT
(Orange lens)
PIAGGIO: Vespa Px 125-150-200 • Px 125 T5
Px 125-150-200 Arcobaleno
(R.O. 163256)



24 648 0410



FRECCIA ANTERIORE SINISTRA
(Lente arancione)
FRONT INDICATOR LEFT
(Orange lens)

PIAGGIO: Vespa Px 125-150-200 • Px 125 T5
Px 125-150-200 Arcobaleno
(R.O. 162817)

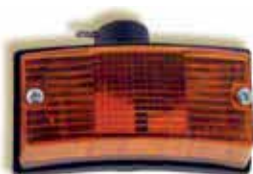

24 648 0420



FRECCIA POSTERIORE DESTRA
(Lente arancione)
REAR INDICATOR RIGHT
(Orange lens)

PIAGGIO: Vespa Px 125-150-200 • Px 125 T5
Px 125-150-200 Arcobaleno
(R.O. 230339)



24 648 0430



FRECCIA POSTERIORE SINISTRA
(Lente arancione)
REAR INDICATOR LEFT
(Orange lens)

PIAGGIO: Vespa Px 125-150-200 • Px 125 T5
Px 125-150-200 Arcobaleno
(R.O. 230338)



24 648 0415



FRECCIA ANTERIORE SINISTRA
(Lente bianca)
FRONT INDICATOR LEFT
(White lens)

PIAGGIO: Vespa PX 125-150-200
PXE 125-150-200 - T5
VNX-VLX1-VSX-VNX5T
VNX2-VLX2-VSX2
(R.O. 583082)



24 648 0405



FRECCIA POSTERIORE DESTRA
(Lente bianca)
REAR INDICATOR RIGHT
(White lens)

PIAGGIO: Vespa PX 125-150-200
PXE 125-150-200 - T5
VNX-VLX1-VSX-VNX5T
VNX2-VLX2-VSX2
(R.O. 583083)



24 648 0435



FRECCIA ANTERIORE SINISTRA
(Lente bianca)
FRONT INDICATOR LEFT
(White lens)

PIAGGIO: Vespa PX 125-150-200
PXE 125-150-200 - T5
VNX-VLX1-VSX-VNX5T
VNX2-VLX2-VSX2
(R.O. 583084)





FANALI FRECCE COMPLETI

COMPLETE INDICATORS

24 648 0425



FRECCIA POSTERIORE DESTRA

(Lente bianca)

REAR INDICATOR RIGHT

(White lens)

PIAGGIO: Vespa PX 125-150-200

PXE 125-150-200 - T5

VNX-VLX1-VSX-VNX5T

VNX2-VLX2-VSX2

(R.O. 583085)



24 648 0460



FRECCIA ANTERIORE DESTRA

(Lente arancione)

(Cromata)

FRONT INDICATOR RIGHT

(Orange lens)

(Chromed)

PIAGGIO: Vespa Px 125-150-200 • Pxe 125-

150-200 • T5 • Vnx-VLX1-Vsx-Vnx5t

Vnx2-VLX2-Vsx2



24 648 0450



FRECCIA ANTERIORE SINISTRA

(Lente arancione)

(Cromata)

FRONT INDICATOR LEFT

(Orange lens)

(Chromed)

PIAGGIO: Vespa Px 125-150-200 • Pxe 125-

150-200 • T5 • Vnx-VLX1-Vsx-Vnx5t-Vnx2-

VLX2-Vsx2



24 648 0480



FRECCIA POSTERIORE DESTRA

(Lente arancione)

REAR INDICATOR RIGHT

(Orange lens)

PIAGGIO: Vespa Px 125-150-200 • Pxe 125-

150-200 • T5 • Vnx-VLX1-Vsx-Vnx5t-Vnx2-

VLX2-Vsx2



24 648 0470



FRECCIA POSTERIORE SINISTRA

(Lente arancione)

(Cromata)

REAR INDICATOR LEFT

(Orange lens)

(Chromed)

PIAGGIO: Vespa Px 125-150-200 • Pxe 125-

150-200 • T5 • Vnx-VLX1-Vsx-Vnx5t-Vnx2-

VLX2-Vsx2



24 648 0465



FRECCIA ANTERIORE DESTRA

(Lente Bianca)

(Cromata)

FRONT INDICATOR RIGHT

(White lens)

(Chromed)

PIAGGIO: Vespa Px 125-150-200 • Pxe 125-

150-200 • T5 • Vnx-VLX1-Vsx-Vnx5t-Vnx2-VLX2-

Vsx2

(R.O. 638762)



24 648 0455



FRECCIA ANTERIORE SINISTRA

(Lente Bianca)

(Cromata)

FRONT INDICATOR LEFT

(White lens)

(Chromed)

PIAGGIO: Vespa Px 125-150-200 • Pxe 125-

150-200 • T5 • Vnx-VLX1-Vsx-Vnx5t-Vnx2-VLX2-

Vsx2

(R.O. 638761)



24 648 0485



FRECCIA POSTERIORE DESTRA

(Lente Bianca)

(Cromata)

REAR INDICATOR RIGHT

(White lens)

(Chromed)

PIAGGIO: Vespa Px 125-150-200 • Pxe 125-

150-200 • T5 • Vnx-VLX1-Vsx-Vnx5t-Vnx2-

VLX2-Vsx2

(R.O. 638764)



24 648 0475



FRECCIA POSTERIORE SINISTRA

(Lente Bianca)

(Cromata)

REAR INDICATOR LEFT

(White lens)

(Chromed)

PIAGGIO: Vespa Px 125-150-200 • Pxe 125-

150-200 • T5 • Vnx-VLX1-Vsx-Vnx5t-Vnx2-VLX2-

Vsx2

(R.O. 638763)





24 648 0494 

NEW

FRECCIA ANTERIORE SINISTRA
FRONT INDICATOR LEFT
PIAGGIO 125-150-200: Cosa
(R.O. 251818)



24 648 0495 

NEW

FRECCIA ANTERIORE DESTRA
FRONT INDICATOR RIGHT
PIAGGIO 125-150-200: Cosa
(R.O. 251858)



24 648 0496 

NEW

FRECCIA POSTERIORE SINISTRA
REAR INDICATOR LEFT
PIAGGIO 125-150-200: Cosa
(R.O. 251898)



24 648 0497 

NEW

FRECCIA POSTERIORE DESTRA
REAR INDICATOR RIGHT
PIAGGIO 125-150-200: Cosa
(R.O. 251905)



12 183 0880 

NEW

CAPPUCCIO FRECCIA ANTERIORE
FRONT BLINKER CAP
PIAGGIO 50-90: Vespa Px 125-150-200 • Pxe
125-150-200 • T5 • Vnx-VLX1-Vsx-Vnx5t
Vnx2-VLX2-Vsx2
(R.O. 182599)



12 183 0890 

NEW

CAPPUCCIO FRECCIA POSTERIORE
REAR BLINKER CAP
PIAGGIO 50-90: Vespa Px 125-150-200 • Pxe
125-150-200 • T5 • Vnx-VLX1-Vsx-Vnx5t
Vnx2-VLX2-Vsx2
(R.O. 230320)





LENTI FRECCIA
INDICATOR LENSES

24 647 0010

E-MARK

ARANCIO

24 647 0020

E-MARK

ARANCIO

24 647 0015

TRASPARENTE

24 647 0025

TRASPARENTE

ANTERIORE SINISTRA - LEFT FRONT

APRILIA: Sr 50 Stealth-Racing 97-99-Sr 125-150 99-01-Leonardo 125-150 96-98
(R.O. AP8124544)



ANTERIORE DESTRA - RIGHT FRONT

APRILIA: Sr 50 Stealth Racing 97-99
Sr 125-150 99-01
Leonardo 125-150 96-98
(R.O. AP8124543)



24 647 0145

TRASPARENTE

24 647 0155

TRASPARENTE

ANTERIORE SINISTRA - LEFT FRONT

APRILIA: Leonardo 125-150
(R.O. AP8224210)



ANTERIORE DESTRA - RIGHT FRONT

APRILIA: Leonardo 125-150
(R.O. AP8224213)



24 647 0030

E-MARK

ARANCIO

24 647 0180

E-MARK

ARANCIO

24 647 0035

TRASPARENTE

24 647 0181

ARANCIO

APRILIA:			Ant.Front	Post.Rear
Rally acqua	96	50	•	•
Rally aria	95-03	50	•	•
Scarabeo 2T	93-03	50	•	•
Scarabeo 2T		100	•	•
Sr acqua	97-00	50	•	•
Sr aria	97-01	50	•	•
Sr	97-01	125-150	•	•
Classic		125	•	•
Rs moto	99-03	50	•	•
Rs	98-03	250	•	•
Rsv	98-00	1000	•	•

(R.O. AP8212680)



MBK 50:			Ant.Front	Post.Rear
Booster	90-94		•	
Booster Road	94-95		•	
Booster	01-03		•	
Booster Spirit	96-03		•	
Booster Spirit Eu 2	02-03		•	
Stunt	00-02		•	•

YAMAHA 50:			Ant.Front	Post.Rear
Bw's Original	97-02		•	
Bw's Original Eu 2	02-03		•	
Bw's R	01		•	
CWL Bw's	03		•	
Slider	00-02		•	•

(R.O. 3VLH33120000)



24 647 0190

E-MARK

ARANCIO

24 647 0200

E-MARK

ARANCIO

24 647 0191

ARANCIO

24 647 0201

ARANCIO

24 647 0195

TRASPARENTE

24 647 0205

TRASPARENTE

POSTERIORE SINISTRA - LEFT REAR

MBK 50: Booster 01-03 - Spirit 99-03
Spirit Eu2 02-03 - Naked 03
YAMAHA 50: Bw's 03 - R 01-Original 99-02
Orig. Eu2 0203-Naked 03
(R.O. 4VUH33320000)



POSTERIORE DESTRA - RIGHT REAR

MBK 50: Booster 01-03 - Spirit 99-03
Spirit Eu2 02-03 - Naked 03
YAMAHA 50: Bw's 03 - R 01-Original 99-02
Orig. Eu2 02-03-Naked 03
(R.O. 4VUH33320000)



24 647 0210

E-MARK

ARANCIO

24 647 0220

E-MARK

ARANCIO

24 647 0215

TRASPARENTE

24 647 0225

TRASPARENTE

ANTERIORE SINISTRA - LEFT FRONT

MBK 50: Booster Ng 99-03
Booster Ng Eu1 99-00
YAMAHA 50 : Bw's Ng 99-03
Bw's Cat 99-00
(R.O. 5FXH33120000)



ANTERIORE DESTRA - RIGHT FRONT

MBK 50: Booster Ng 99-03
Booster Ng Eu1 99-00
YAMAHA 50 : Bw's Ng 99-03
Bw's Cat 99-00
(R.O. 5FXH33220000)





24 647 0040 

E-MARK ARANCIO

24 647 0045 

TRASPARENTE

ANTERIORE DESTRA - SINISTRA
RIGHT/LEFT FRONT
MALAGUTI: F12 50 Phantom-Lc-win Disks 94-00
F12 50 Restyling-Lc-restyling Eu2 01-02
F12 100 Phantom 99-00
(R.O. 01903900)



24 647 0050 

E-MARK ARANCIO

24 647 0055 

TRASPARENTE

POSTERIORE DESTRA - SINISTRA
RIGHT/LEFT REAR
MALAGUTI: F12 50-100-Phantom-Lc
Twin Disks Cat. 94-00-Crosser Cr1 50 95-98
Fifty Top Up 50 94-97
(R.O. 01903200)



24 647 0230 

E-MARK ARANCIO

24 647 0231 

ARANCIO

24 647 0235 

TRASPARENTE

POSTERIORE SINISTRA - LEFT REAR
MBK 50: Booster Ng 95-03
Booster Ng Eu1 99-00
Booster Track 96-98 - Rocket 97-98
YAMAHA 50 : Bw's Ng 97-05-Ng Cat 99-00
Bw's Bump 97-98 - Spy 95-98
(R.O. 4SBH33320000)



24 647 0240 

E-MARK ARANCIO

24 647 0241 

ARANCIO

24 647 0245 

TRASPARENTE

POSTERIORE DESTRA - RIGHT REAR
MBK 50: Booster Ng 95-03
Booster Ng Eu1 99-00
Booster Track 96-98 - Rocket 97-98
YAMAHA 50 : Bw's Ng 97-05-Ng Cat 99-00
Bw's Bump 97-98 - Spy 95-98
(R.O. 4SBH33420000)



24 647 0250 

E-MARK ARANCIO

24 647 0255 

TRASPARENTE

ANTERIORE SINISTRA - LEFT FRONT
MBK 50: Nitro 99-04 - Nitro Eu2 03
Nitro Jaguar 04 - Nitro 100 00-02
YAMAHA 50 : Aerox R 99-00-Aerox 01-05
aerox Eu2 03-Aerox 100 00-02
(R.O. 5BRH33121000)



24 647 0260 

E-MARK ARANCIO

24 647 0265 

TRASPARENTE

ANTERIORE DESTRA - RIGHT FRONT
MBK 50: Nitro 99-04 - Nitro Eu2 03
Nitro Jaguar 04 - Nitro 100 00-02
YAMAHA 50 : Aerox R 99-00
Aerox 01-05-Aerox Eu2 03
Aerox 100 00-02
(R.O. 5BRH33221000)

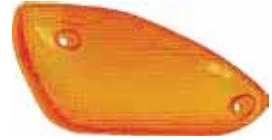

24 647 0270 

E-MARK ARANCIO

24 647 0275 

TRASPARENTE

POSTERIORE SINISTRA - LEFT REAR
MBK 50: Nitro 99-04 - Nitro Eu2 03
Nitro Jaguar 04 - Nitro 100 00-02
YAMAHA 50 : Aerox R 99-00 - Aerox 01-05
Aerox Eu2 03 - Aerox 100 00-02
(R.O. 5HEH33320000)



24 647 0280 

E-MARK ARANCIO

24 647 0281 

ARANCIO

24 647 0285 

TRASPARENTE

POSTERIORE DESTRA - RIGHT REAR
MBK 50: Nitro 99-04 - Nitro Eu2 03
Nitro Jaguar 04 - Nitro 100 00-02
YAMAHA 50 : Aerox R 99-00 - Aerox 01-05
Aerox Eu2 03 - Aerox 100 00-02
(R.O. 5HEH33420000)



24 647 0060 

E-MARK ARANCIO

24 647 0065 

TRASPARENTE

ANTERIORE SINISTRA - LEFT FRONT
GILERA 50: Typhoon-X-Xr 50-125 94-00
Storm 50 94-95
PIAGGIO 50: Ntt 95-96-Nrg 94-96
Nrg Rst Mc2 96-98-Typhoon 01
Zip Fast Raider Rst 96-97-Zip Sp 96-00
(R.O. 498435)



24 647 0070 

E-MARK ARANCIO

24 647 0075 

TRASPARENTE

ANTERIORE DESTRA - RIGHT FRONT
GILERA 50: Typhoon-X-Xr 50-125 94-00
Storm 50 94-95
PIAGGIO 50: Ntt 95-96-Nrg 94-96
Nrg Rst Mc2 96-98-Typhoon 01
Zip fast raider Rst 96-97
Zip Sp 96-00
(R.O. 498436)





LENTI FRECCIA
INDICATOR LENSES

24 647 0080



E-MARK

ARANCIO

24 647 0090



E-MARK

ARANCIO

24 647 0085



TRASPARENTE

24 647 0095



TRASPARENTE

POSTERIORE SINISTRA - LEFT REAR
GILERA 50: Typhoon-Xxr 50-125 94-00
Storm 50 94-95
PIAGGIO 50: Ntt 95-96-Nrg 94-96
Typhoon 01
(R.O. 498437)



POSTERIORE DESTRA - RIGHT REAR
GILERA 50: Typhoon-Xxr 50-125 94-00
Storm 50 94-95
PIAGGIO 50: Ntt 95-96-Nrg 94-96
Typhoon 01
(R.O. 498438)



24 647 0100



E-MARK

ARANCIO

24 647 0110



E-MARK

ARANCIO

24 647 0101



ARANCIO

24 647 0115



TRASPARENTE

24 647 0105



TRASPARENTE

ANTERIORE SINISTRA - LEFT FRONT
PIAGGIO 50 cc:
Liberty 97-02-Liberty 4T 00-02
125 cc: Liberty 98-00
125-150 cc: Liberty 00-02
(R.O. 580100)



ANTERIORE DESTRA - RIGHT FRONT
PIAGGIO 50 cc:
Liberty 97-02-Liberty 4T 00-02
125 cc: Liberty 98-00
125-150 cc: Liberty 00-02
(R.O. 580101)



24 647 0120



E-MARK

ARANCIO

24 647 0130



E-MARK

ARANCIO

24 647 0125



TRASPARENTE

24 647 0135



TRASPARENTE

POSTERIORE SINISTRA - LEFT REAR
PIAGGIO 50 cc:
Liberty 97-02-Liberty 4T 00-02
125 cc: Liberty 98-00
125-150 cc: Liberty 00-02
(R.O. 580102)



POSTERIORE DESTRA - RIGHT REAR
PIAGGIO 50 cc: Liberty 97-02
Liberty 4T 00-02
125 cc: Liberty 98-00-L
125-150 cc: Liberty 00-02
(R.O. 580103)



24 647 0290



E-MARK

ARANCIO

24 647 0300



E-MARK

ARANCIO

24 647 0291



ARANCIO

24 647 0301



ARANCIO

24 647 0295



TRASPARENTE

24 647 0305



TRASPARENTE

ANTERIORE SINISTRA - LEFT FRONT
PIAGGIO 50: Nrg Extreme 99-00
Nrg Mc3 01-02 - Nrg Purejet 02-04
(R.O. 581290)



ANTERIORE DESTRA - RIGHT FRONT
PIAGGIO 50: Nrg Extreme 99-00
Nrg Mc3 01-02 - Nrg Purejet 02-04
(R.O. 581289)





24 647 0310 

E-MARK

ARANCIO

24 647 0320 

E-MARK

ARANCIO

24 647 0311 

ARANCIO

24 647 0321 

ARANCIO

24 647 0315 

TRASPARENTE

24 647 0325 

TRASPARENTE

POSTERIORE SINISTRA - LEFT REAR

PIAGGIO 50: Nrg Extreme 99-00
Nrg Mc3 01-02 - Nrg Purejet 02-04
(R.O. 294689)



POSTERIORE DESTRA - RIGHT REAR

PIAGGIO 50: Nrg Extreme 99-00
Nrg Mc3 01-02 - Nrg Purejet 02-04
(R.O. 294690)



24 647 0335 

LENTE FRECCIA POSTERIORE SINISTRA
(Trasparente)

LEFT REAR INDICATOR LENS (Clear)
YAMAHA: T Max 500 01-07



24 647 0345 

LENTE FRECCIA POSTERIORE DESTRA
(Trasparente)

RIGHT REAR INDICATOR LENS (Clear)
YAMAHA: T Max 500 01-07



24 647 0355 

LENTE FANALE POSTERIORE
(Trasparente)

REAR INDICATOR LENS (Clear)
YAMAHA: T Max 500 01-07



24 647 0375 

LENTE FRECCIA ANTERIORE DESTRA
(Arancione)

RIGHT FRONT INDICATOR LENS (Orange)
PIAGGIO: Vespa Px-T5-VNX-VLX-VSe-VNX2T
(R.O. 185977)



24 647 0365 

LENTE FRECCIA ANTERIORE SINISTRA
(Arancione)

LEFT FRONT INDICATOR LENS (Orange)
PIAGGIO: Vespa Px-T5-VNX-VLX-VSe-VNX2T
(R.O. 185976)



24 647 0395 

LENTE FRECCIA POSTERIORE DESTRA
(Arancione)

LEFT REAR INDICATOR LENS (Orange)
PIAGGIO: Vespa Px-T5-VNX-VLX-VSe-VNX2T
(R.O. 185979)



24 647 0385 

LENTE FRECCIA POSTERIORE SINISTRA
(Arancione)

LEFT REAR INDICATOR LENS (Orange)
PIAGGIO: Vespa Px-T5-VNX-VLX-VSe-VNX2T
(R.O. 185978)



24 647 0360 

LENTE FRECCIA ANTERIORE SINISTRA
(Bianca)

LEFT FRONT INDICATOR LENS (White)
PIAGGIO: Vespa PX -T5
VNX-VLX-VSE-VNX2T
(R.O. 196896)



24 647 0370 

LENTE FRECCIA ANTERIORE DESTRA
(Bianca)

RIGHT FRONT INDICATOR LENS (White)
PIAGGIO: Vespa PX -T5
VNX-VLX-VSE-VNX2T
(R.O. 196897)





LENTI FRECCIA
INDICATOR LENSES

24 647 0380



LENTE FRECCIA POSTERIORE SINISTRA

(Bianca)

LEFT REAR INDICATOR LENS (White)

PIAGGIO: VNX-VLX-VSE-VNX2T
(R.O. 196898)

24 647 0390



LENTE FRECCIA POSTERIORE DESTRA

(Bianca)

LEFT REAR INDICATOR LENS (White)

PIAGGIO: Vespa PX - T5 - VNX-VLX-VSE
VNX2T
(R.O. 196899)



FANALI ANTERIORI PIAGGIO VESPA
PIAGGIO VESPA HEADLAMPS



24 641 0030



In vetro mm 95 - *mm 95 glass*
Vespa 98 cc 125 • 125 51-53 Farobasso



24 641 0040



In vetro mm 105 completo di portalamпада
mm 105 glass with holder
Vespa 50 N • S • R • L
(R.O. 101231)



24 641 0050



In vetro mm 115 comp. di portalamпада e ghiera
mm 115 glass complete with holder and rim
Vespa GL 150 • Gs 150 • 160 Gs
(R.O. 92326)



24 641 0060



In vetro mm 115 con portalamпада
mm 115 glass with holder
Vespa 125 Primavera • 150 Super • 90
(R.O. 144773)



24 641 0070



In vetro mm 130 con portalamпада e ghiera
mm 130 glass complete with holder with rim
Vespa Rally 180- 200-150 Sprint Veloce
125 Gtr • Ts
(R.O. 144772)



24 641 0080



In vetro con portalamпада e ghiera
Front headlamp glass complete with holder with rim
Vespa GL 150 • 150 Sprint • 180 Ss
(R.O. 138508)



24 641 0090



In vetro mm 140 con portalamпада
mm 140 glass with holder
Vespa Px 125-150-200 • Px 125-150-200
Arcobaleno
(R.O. 163685)



24 641 0100



Con portalamпада
With holder
Vespa 50 Special • Elestart • V5A3T • VCB2T •
V5B4T
(R.O. 126695)



24 641 0110



In vetro mm 105 con portalamпада
(Mercato Italiano - *Italian market*)
Front headlamp mm 105 glass with holder
Vespa 50 N-S-R-L V5A1
(R.O. 101321)





FANALI ANTERIORI PIAGGIO VESPA

PIAGGIO VESPA HEADLAMPS

24 641 0170



In vetro mm 105 con portalampada
mm 105 glass with holder
Vespa 150 VL2 - VL3
(R.O. 25483)



24 641 0180



In vetro mm 105 con portalampada
mm 105 glass with holder
Vespa 150 VL2 - VL3
(R.O. 2373)



24 641 0190



In vetro mm 105 con portalampada
mm 105 glass with holder
Vespa 125
VNA-VNA1-VNB1
(R.O. 87310)



24 641 0200



In vetro mm 105 con portalampada
mm 105 glass with holder
Vespa 125
VM1T-VM2T-VN1T-VN2T
(R.O. 18087)



24 641 0210



In vetro mm 115 con portalampada
mm 115 glass with holder
Vespa 150 Gs-150
VS1-VS2-VS3-VS4-VB1
(R.O. 25793)



24 641 0220



In vetro mm 115 con portalampada
mm 115 glass with holder
Vespa 150 Gs-150
VS1-VS2-VS3-VS4-VB1



24 641 0230



In vetro mm 105 con portalampada
mm 105 glass with holder
Vespa 125
VN1-VN2
(R.O. 26008)



24 641 0240



In vetro mm 105 con portalampada
mm 105 glass with holder
Vespa 150 VL1 Struzzo
(R.O. 23447)





24 641 0120 

H4 12V 60-55W - BA15S 12V 5W
PIAGGIO 125: Vespa Granturismo Eu3 03-07 • Vespa Gts Eu3 07-12 - **200:** Vespa Granturismo 06-07
250: Vespa Gts 05-13 • Vespa Gts Abs 05-12
300: Vespa Gts ie Touring 11-12 • Vespa Gts ie 12-13
 (R.O. 58267R-584977)



24 641 0130 

BA 12V 35-35W - BA15S 12V 5W
PIAGGIO 50: Vespa Lx 2T Touring & 30 Km 10-13 • Vespa Lx 2T 05-13 • Vespa Lx 4T-4V Touring 10-13 • Vespa Lx 4T-4V 09-13 • Lx 4T 05-08
125: Vespa Lx 4T FL 09
 (R.O. 58259R)



24 641 0140 

H4 12V 60-55W - BA15S 12V 5W
PIAGGIO 125: Vespa Lx 4T 3V ie - Touring 12-13 • Vespa Lx 4T Eu3 Touring 10-11 • Vespa Lx 4T FL 09 • Vespa Lx Eu3 ie 09-11 • Vespa Lx Eu3 06-08 • Vespa Lx 05-06 - **150:** Vespa Lx 4T 3V ie - Touring 12-13 • Vespa Lx 4T FL 09 • Vespa Lx Eu3 ie 09-11 • Vespa Lx Eu3 06-08 • Vespa Lx Touring 10-12 • Lx 05-06
 (R.O. 58260R)



24 641 0150 

H4 12V 60-55W - BA15S 12V 5W
PIAGGIO 125: Fly 05-07 • Liberty 4T Eu3 07-08 • Liberty Rst 04-05 • Liberty 4T 2V Eu3 09-12 • Liberty 4T Eu3 Delivery - Single 07-12 • Liberty 4T 06-07 - **150:** Liberty 4T Eu3 08 • Fly 05-07 • Fly 05-07 • Liberty Moc 4T Eu3 09-13 - **200:** Liberty Rst 04 • Liberty 06 • Liberty 4T Eu3 06-08
 (R.O. 58258R • 584787)



24 641 0160 

H4 12V 60-55W - BA15S 12V 5W
PIAGGIO 125: Vespa Gts 4T ie Super 09-13
300: Vespa Gts Super 08-13
 (R.O. 58265R)





FANALI ANTERIORI PIAGGIO

PIAGGIO HEADLAMPS

14 271 0010 

CORNICE FARO - HEAD LAMP RIM

Vespa 50 Special Elestart
(R.O. 124200)



14 271 0020 

CORNICE FARO - HEAD LAMP RIM

Vespa Primavera 125 • Et3 • Super
(R.O. 151742)



14 271 0030 

CORNICE FARO - HEAD LAMP RIM

Vespa 50 V5A1T
(R.O. 151713)



14 271 0040 

CORNICE FARO - HEAD LAMP RIM

Vespa 125-150 GL Sprint • Ss 180
VNL2T-VLB1T-VLA1T-VSC1T
(R.O. 070543)



14 271 0050 

CORNICE FARO - HEAD LAMP RIM

Vespa 125-150-180-200 Rally
VL2/3-VLB1T-VSD1-VSE
(R.O. 113981)



14 271 0060 

CORNICE FARO - HEAD LAMP RIM

Vespa Px 125-150-200
VNX2-VLX2-VSX2



14 271 0070 

CORNICE FARO - HEAD LAMP RIM

Vespa 125- Vit - V15
(R.O. 011902)



14 271 0080 

CORNICE FARO - HEAD LAMP RIM

Vespa 125-150-150 Gs -160 Gs
VNB3/4/5/6T-VBA-VBB-VGLA/B-VS5-VSB
(R.O. 084489)



14 271 0090 

CORNICE FARO - HEAD LAMP RIM

Vespa 150- 150 Gs VB1-VS1/2/3/4
(R.O. 025576)



14 271 0100 

CORNICE FARO - HEAD LAMP RIM

Vespa 125 VM1T/2-VN1T/2T
(R.O. 018088)



14 271 0110 

CORNICE FARO - HEAD LAMP RIM

Vespa 150 VL2T-VL3
(R.O. 025092)



14 271 0120 

CORNICE FARO - HEAD LAMP RIM

Vespa 125 VNA-VNB
(R.O. 082079)



14 271 0130 

CORNICE FARO - HEAD LAMP RIM

Vespa 125 VN2
(R.O.026009)



14 271 0140 

CORNICE FARO - HEAD LAMP RIM

Vespa 125 Struzzo
(R.O. 23444)



FANALI POSTERIORI PIAGGIO VESPA

PIAGGIO VESPA REAR LIGHTS



24 642 0010



PIAGGIO: Vespa 50 63-67 • Vespa 90 63-68
Vespa Nuova 125 65-67
Con guarnizione - *With gasket*
(R.O. 78641)



24 642 0020



PIAGGIO: Vespa 50 63-67
Con guarnizione - *With gasket*
(R.O. 78872)



24 642 0030



PIAGGIO: Vespa 125 60-64 • Vespa Gs 150 59-61
Vespa GL 150 63-64
Con guarnizione - *With gasket*
(R.O. 93186)



24 642 0040



PIAGGIO: Vespa 125 65-66 • Vespa Sprint 150
65-74 • Vespa Super 150 65-79
Con guarnizione - *With gasket*
(R.O. 70700)



24 642 0050



PIAGGIO: Vespa Sprint 150 65-74 • Vespa Ss
180 65-68
Con guarnizione - *With gasket*
(R.O. 91419)



24 642 0060



PIAGGIO: Vespa 50 Special 72-75 • Vespa 50
Special Elestart 72-75
Con guarnizione - *With gasket*
(R.O. 143687)



24 642 0070



PIAGGIO: Vespa 125 58-59 • Vespa 150 55-58
Vespa Gs 150 55-59
Con guarnizione - *With gasket*
(R.O. 021098)



24 642 0080



PIAGGIO: Vespa 125 53 • Vespa 125 U 53
Con guarnizione - *With gasket*
(R.O. 0184280001)



24 642 0090



PIAGGIO: Vespa 125 51-53 • Vespa 125 58-59
Con guarnizione - *With gasket*
(R.O. 014936)





FANALI POSTERIORI PIAGGIO VESPA

PIAGGIO VESPA REAR LIGHTS

24 642 0140



PIAGGIO: Vespa 50 L-N-R
Con guarnizione - *With gasket*
(R.O. 102459)



24 642 0150



PIAGGIO: Vespa P 125 X 77-82 • Vespa P 150 X 78-81 • Vespa Px 150 E 81 • Vespa P 200 X 77 • Vespa Px 200 E 77-82
Con guarnizione - *With gasket*
(R.O. 162740)



24 642 0160



PIAGGIO: Vespa Px 125 E Freno a disco 98-01
Vespa Px 150 E Freno a disco 98-01
Vespa Px 200 E 98-01
Con guarnizione - *With gasket*
(R.O. 583081)



24 642 0170



PIAGGIO: Vespa Gtr 125 69-78 • Vespa Sprint Veloce 150 69-79 • Vespa Rally 180 68-73 • Vespa Rally 200 72-79
Con guarnizione - *With gasket*
(R.O. 121017)



24 642 0180



PIAGGIO: Vespa Et3 125 76-83 • Vespa Primavera 125 67-83
Con guarnizione - *With gasket*
(R.O. 159430)



24 642 0200



PIAGGIO: Vespa Gs 150 58
Senza guarnizione - *Without gasket*



24 642 0210



PIAGGIO: Vespa Px 125 T5 85 • Vespa Px 125 T5 Elestart 86
Con guarnizione - *With gasket*
(R.O. 232774)



24 642 0100



**GUARNIZIONE FANALE POSTERIORE
REAR LIGHT GASKET**
PIAGGIO: Vespa 50 63-67 • Vespa 90 63-68
Vespa Nuova 125 65-67
(R.O. 71193)



24 642 0110



**GUARNIZIONE FANALE POSTERIORE
REAR LIGHT GASKET**
PIAGGIO: Vespa 50 63-67
(R.O. 4588)



24 642 0120



**GUARNIZIONE FANALE POSTERIORE
REAR LIGHT GASKET**
PIAGGIO: Vespa 125 60-64 • Vespa Gs 150 59-61
Vespa GL 150 63-64
(R.O. 89222)



24 642 0130



**GUARNIZIONE FANALE POSTERIORE
REAR LIGHT GASKET**
PIAGGIO: Vespa 125 65-66 • Vespa Sprint 150 65-74 • Vespa Super 150 65-79 • Vespa Sprint 150 65-74 • Vespa Ss 180 65-68
(R.O. 70767)



LENTI FANALI POSTERIORI PIAGGIO VESPA

PIAGGIO VESPA REAR LENS



24 647 0406



PIAGGIO: Vespa 50 63-67 • Vespa 90 63-68
Vespa Nuova 125 65-67
(R.O. 78627)



24 647 0416



PIAGGIO: Vespa 50 63-67
(R.O. 78715)



24 647 0426



PIAGGIO: Vespa 125 60-64 • Vespa Gs 150 59-61
Vespa GL 150 63-64
(R.O. 89441)



24 647 0436



PIAGGIO: Vespa 125 65-66 • Vespa Sprint 150
65-74 • Vespa Super 150 65-79
(R.O. 97440)



24 647 0446



PIAGGIO: Vespa Sprint 150 65-74 • Vespa Ss
180 65-68
(R.O. 150369)



24 647 0456



PIAGGIO: Vespa 50 Special 72-75 • Vespa 50
Special Elestart 72-75
(R.O. 125681)



24 647 0466



PIAGGIO: Vespa 125 58-59 • Vespa 150 55-58
Vespa Gs 150 55-59 • Vespa 125 51-53 • Vespa
125 58-59
(R.O. 020914)



24 647 0476



PIAGGIO: Vespa 125 53 • Vespa 125 U 53



24 647 0486



PIAGGIO: Vespa 50 L-N-R
(R.O. 104259)



24 647 0496



PIAGGIO: Vespa Gs 150 58



24 647 0506



PIAGGIO: Vespa P 125 X 77-82 • Vespa P 150 X
78-81 • Vespa Px 150 E 81 • Vespa P 200 X 77 •
Vespa Px 200 E 77-82
(R.O. 162741)



24 647 0516



PIAGGIO: Vespa Px 125 E Freno a disco 98-01
Vespa Px 150 E Freno a disco 98-01
Vespa Px 200 E 98-01





RMS
YOUR BEST PARTNER

▶ LAMPADINE

BULBS



LAMPADINE
BULBS

24 651 0315

12V 35/35W BA20D White

24 651 0319

12V 35/35W S2 BA20D White

E-MARK

24 651 0325

12V 45/40W BA20D White

24 651 0305

12V 25/25W BA20D White

24 651 0345

6V 25/25W BA20D White

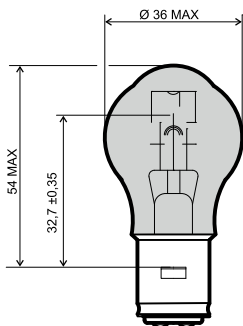

24 651 0495

6V 5W T8,5 x 31

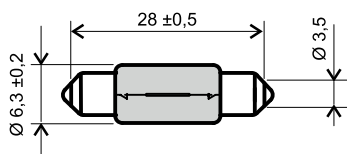

24 651 0635

12V 10W T11x35 s 8,5

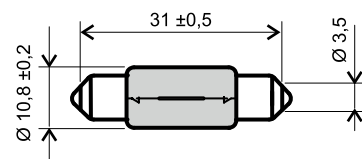

24 651 0175

12V 5W Siluro T11 x 39
12V 5W Festoon bulb T11 x 39

24 651 0165

12V 10W Siluro T11 x 39
12V 10W Festoon bulb T11 x 39

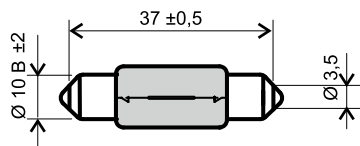

24 651 0125

6V 15W Siluro T15 x 44
6V 15W Festoon bulb T15 x 44

24 651 0135

6V 18W Siluro T15 x 44
6V 18W Festoon bulb T15 x 44

24 651 0145

12V 15W Siluro T15 x 44
12V 15W Festoon bulb T15 x 44

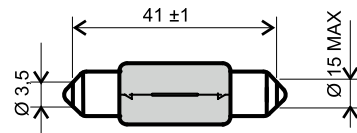

24 651 0405

12V 21/5W T20 White

24 651 0445

12V 21/5W T20 Orange

24 651 0385

12V 21W T20 White

24 651 0395

12V 21W T20 Orange

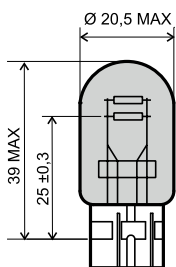

24 651 0265

12V 3W T10

24 651 0285

12V 5W T10

24 651 0280

12V-5W W2,1x9,5D

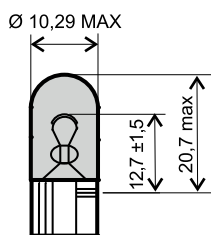

24 651 0245

12V 1,2W T5

24 651 0255

12V 2W T5

24 651 0275

12V 2,3W T5

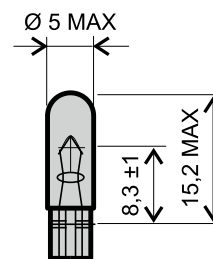

24 651 0015

LAMPADA TUBOLARE - TUBULAR BULB 90°

- 12V - 21W
- Poli innesto 90°

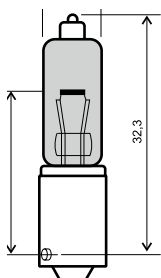

24 651 0025

LAMPADA TUBOLARE - TUBULAR BULB 180°

- 12V - 23W
- Poli innesto 180°

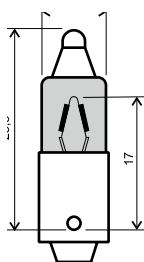



24 651 0335



6V 4W **BA9S** White



24 651 0195



12V 21W BULB **BA15S S25** White



24 651 0225



12V 5W BULB **BA15S G18** White



24 651 0415



12V 4W **BA9S** White



24 651 0205



12V 21W **BA15S S25** Orange



24 651 0235



12V 10W BULB **BA15S G18** White



24 651 0215



12V 10W BULB **BA15S G18** Orange



24 651 0645



6V 5W BULB **BA15S G18** White

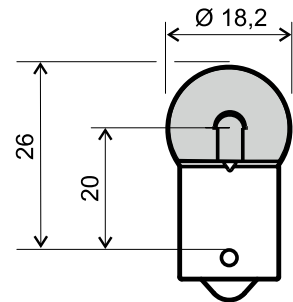
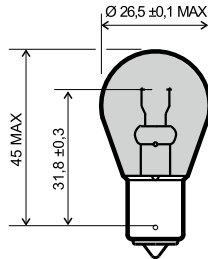
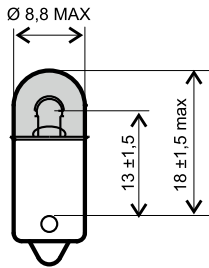

24 651 0365



12V 21/5W **BAY15D** White



24 651 0295



12V 15W **P26S** White



24 651 0105



12V 45/40W **P45T**



Asimmetrica White - *Asymmetric white bulb*

24 651 0375



12V 21/5W **BAY15D** Red

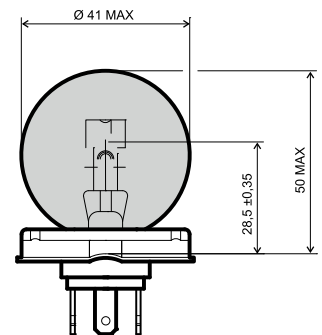
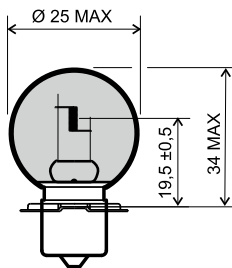
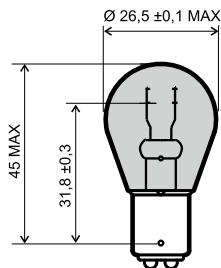

24 651 0465



12V-21W **S25 BAU15S** Orange

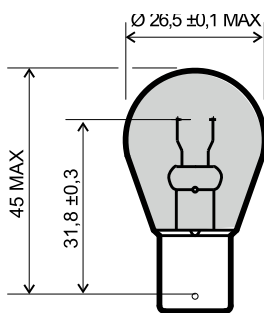



LAMPADINE
BULBS

24 651 0035



H1 12V 55W White

24 651 0045



H3 12V 55W White

24 651 0055



H4 12V 60/55W White

24 651 0030



H1 12V 55W Blue

24 651 0040



H3 12V 55W Blue

24 651 0050



H4 12V 60/55W Blue

24 651 0065



H4 12V-35/35W White

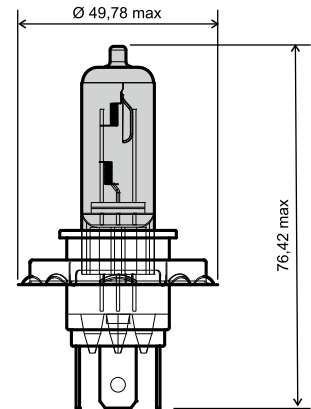
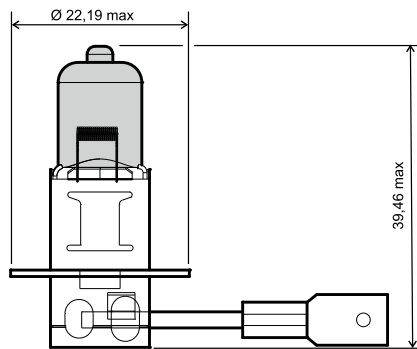
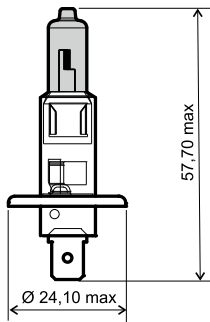

24 651 0075



H8 12V 35W White

24 651 0085



H11 12V 55W

24 651 0095



HB3 12V 65W

24 651 0070



H8 12V 35W Blue

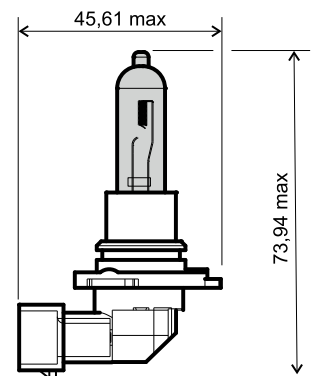
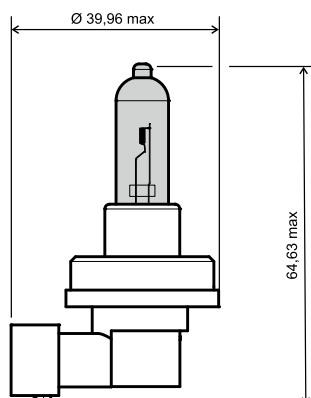
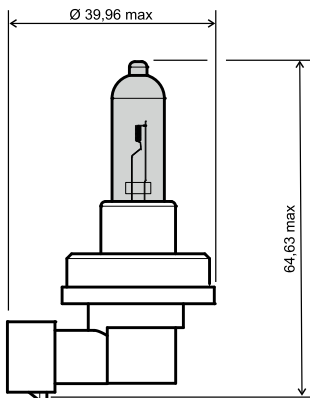



24 651 0115 

H7 12V 55W White



24 651 0355 

12V 35/35W BA20D White



24 651 0425 

12V-15W P26S White



24 651 0110 

H7 12V 55W Blue



24 651 0350 

12V 35/35W BA20D Blue



24 651 0420 

12V-15W P26S Blue

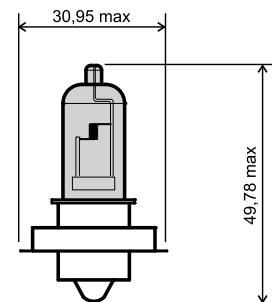
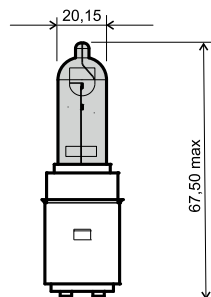
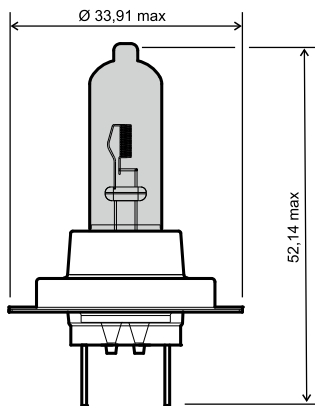

24 651 0435 

12V-20W P26S White



24 651 0185 

HS1 12V 35/35W White



24 651 0745 

LAMPADA BILUCE 12V 35/30 HS5
LOW/HIGH BEAN BULB 12V 35/30 HS5



24 651 0430 

12V-20W P26S Blue



24 651 0180 

HS1 12V 35/35W Blu

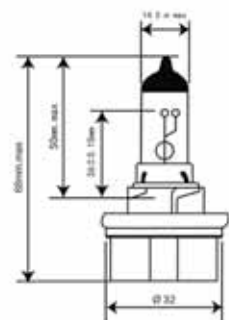
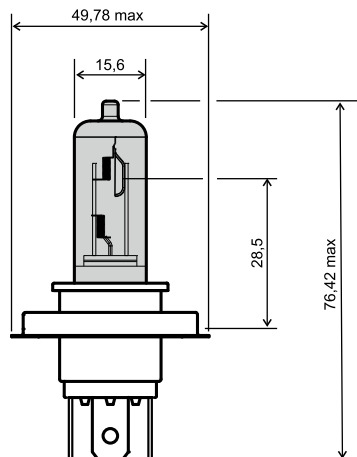
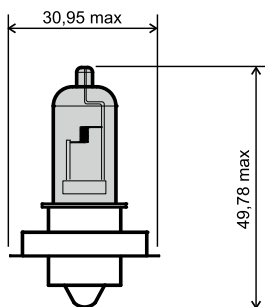



LAMPADINE
BULBS

24 651 0500



Lampadine (2 pz) 12V 5 Led **G18 BA15S** Blue
*Bulbs (2 pcs) 12V 5 Led **G18 BA15S** Blue*

24 651 0530



Lampadine (2 pz) 12V 6 Led **T20**
Doppia Intensità Blue
*Bulbs (2 pcs) 12V 6 Led **T20**
Double intensity Blue*

24 651 0540



Lampadine (2 pz) 12V A 12 Led **BAY15D**
Doppia Intensità Blue
*Bulbs (2 pcs) 12V 12 Led **BAY15D**
Double intensity Blue*

24 651 0505



Lampadine (2 pz) 12V 5 Led **G18 BA15S** White
*Bulbs (2 pcs) 12V 5 Led **G18 BA15S** White*

24 651 0535



Lampadine (2 pz) 12V 6 Led **T20**
Doppia Intensità White
*Bulbs (2 pcs) 12V 6 Led **T20**
Double intensity White*

24 651 0545



Lampadine (2 pz) 12V A 12 Led **BAY15D**
Doppia Intensità White
*Bulbs (2 pcs) 12V 12 Led **BAY15D**
Double intensity White*

24 651 0501



Lampadine (2 pz) 12V 5 Led **G18 BA15S** Orange
*Bulbs (2 pcs) 12V 5 Led **G18 BA15S** Orange*

24 651 0531



Lampadine (2 pz) 12V 6 Led **T20**
Doppia Intensità Orange
*Bulbs (2 pcs) 12V 6 Led **T20**
Double intensity Orange*

24 651 0542



Lampadine (2 pz) 12V A 12 Led **BAY15D**
Doppia Intensità Red
*Bulbs (2 pcs) 12V 12 Led **BAY15D**
Double intensity Red*

Principali Applicazioni:

Frecce-Posizione

Main Applications:

Indicators-Low beam headlight

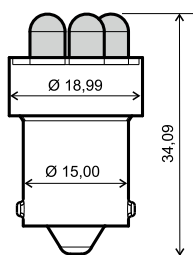

Principali Applicazioni:

Frecce

Main Applications:

Indicators

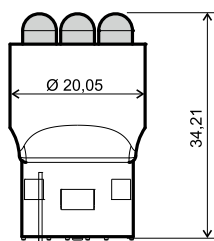

Principali Applicazioni:

Stop-Posizione

Main Applications:

Stop-Low beam headlight

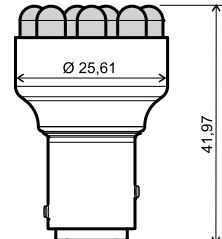

24 651 0510



Lampadine (2 pz) 12V 12 Led S25 **BA15S** Blue
*Bulbs (2 pcs) 12V 12 Led S25 **BA15S** Blue*

24 651 0610



Lampadine (2 pz) 12V 14 Led **H7** Blue
*Bulbs (2 pcs) 12V 14 Led **H7** Blue*

24 651 0515



Lampadine (2 pz) 12V 12 Led S25 **BA15S** White
*Bulbs (2 pcs) 12V 12 Led S25 **BA15S** White*

24 651 0615



Lampadine (2 pz) 12V 14 Led **H7** White
*Bulbs (2 pcs) 12V 14 Led **H7** White*

24 651 0511



Lampadine (2 pz) 12V 12 Led S25 **BA15S** Orange
*Bulbs (2 pcs) 12V 12 Led S25 **BA15S** Orange*

Principali Applicazioni:

Posizione

Main Applications:

Low beam headlight

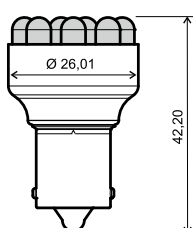

Principali Applicazioni:

Posizione

Main Applications:

Low beam headlight

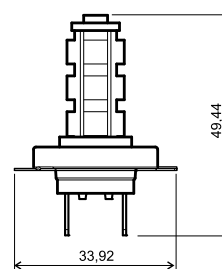



24 651 0555

Led (2 pz) 12V **BA9S** White
Leds (2 pcs) 12V **BA9S** White

24 651 0550

Led (2 pz) 12V **BA9S** Blu
Leds (2 pcs) 12V **BA9S** Blu

24 651 0565

Led (2 pz) 12V T10 **W2,1X9,5D** White
Leds (2 pcs) 12V T10 **W2,1X9,5D** White

24 651 0560

Led (2 pz) 12V T10 **W2,1X9,5D** Blu
Leds (2 pcs) 12V T10 **W2,1X9,5D** Blu

24 651 0561

Led (2 pz) 12V T10 **W2,1X9,5D** Orange
Leds (2 pcs) 12V T10 **W2,1X9,5D** Orange

24 651 0575

Led (2 pz) 12V T10 **W2,1X9,5** White 4 Led
Leds (2 pcs) 12V T10 **W2,1X9,5** White 4 Led

24 651 0570

Led (2 pz) 12V T10 **W2,1X9,5** Blu 4 Led
Leds (2 pcs) 12V T10 **W2,1X9,5** Blu 4 Led

24 651 0571

Led (2 pz) 12V T10 **W2,1X9,5** Orange 4 Led
Leds (2 pcs) 12V T10 **W2,1X9,5** Orange 4 Led

Principali Applicazioni:

Posizione-Cruscotto

Main Applications:

Low beam headlight-dashboard

Principali Applicazioni:

Frecce-Posizione-Targa

Main Applications:

Indicators-Low beam headlight-number plate light

Principali Applicazioni:

Frecce-Posizione-Targa

Main Applications:

Indicators-Low beam headlight-number plate light

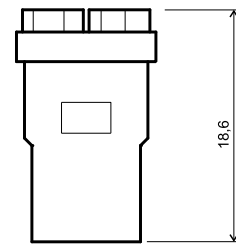
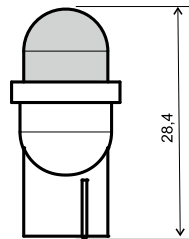
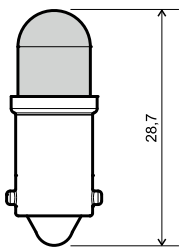

24 651 0595

Led (2 pz) **SV8,5** 6 Led White
Leds (2 pcs) **SV8,5** 6 Led White

Principali Applicazioni: Luci Targa

Main Applications: Number plate light

24 651 0605

Led (2 pz) **SV8,5** 4 Led White
Leds (2 pcs) **SV8,5** 4 Led White

Principali Applicazioni: Luci Targa

Main Applications: Number plate light

24 651 0585

Led (2 pz) **SV8,5** 4 Led White
Leds (2 pcs) **SV8,5** 4 Led White

Principali Applicazioni: Luci Targa

Main Applications: Number plate light

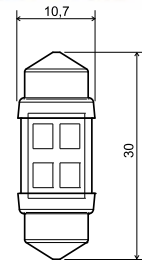
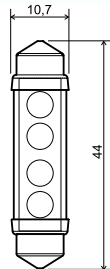
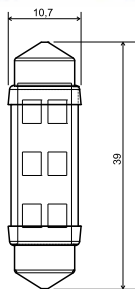

24 652 0012

LED POSTERIORE ROSSO - REAR LED RED
People S 125-200



24 652 0010

LED POSTERIORE BLU - REAR LED BLUE
People S 125-200

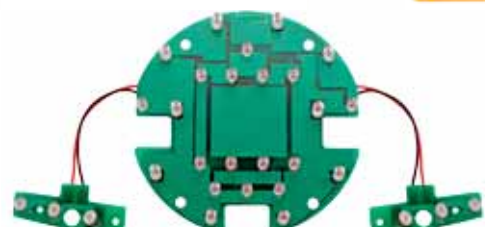
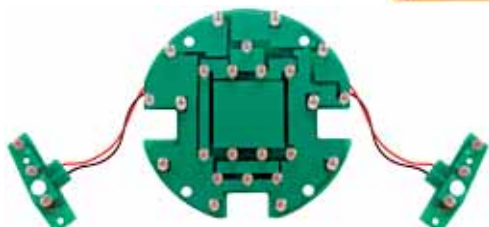



LED CONVERSION KIT
LED CONVERSION KIT

LED CONVERSION KIT

- Led super brillante con microchip integrato
- Sistema di ventilazione forzata con ventola
- Adattatori temperatura colore 5000K-6000K-8000K
- Corpo interamente in alluminio

- Super bright leds with integrated microchip
- Fan air cooling system
- 5000K-6000k-8000k color lampshade
- Billet aluminium body

Prima di installare:
Controllare gli ingombri della base della lampadina nel portalampada

Before installing:
Check if dimensions of the bulb base are correct for your head lamp

24 651 0685



LAMPADA LED H4 ANABBAGLIANTI-ABBAGLIANTI
H4 LED BULB HIGH AND LOW BEAM



24 651 0695



LAMPADA LED H7- H7 LED BULB



24 651 0705



LAMPADA LED H8-H9-H11 - H8-H9-H11 LED BULB



24 651 0715



LAMPADA LED H1 - H1 LED BULB





24 651 0725 

LAMPADA LED H3 - H3 LED BULB

24 651 0735 

LAMPADA LED HB3- HB3 LED BULB



24 651 0755 

FANALE SUPPLEMENTARE A LED 10W-720

LM - 6500K - IMPERMEABILE

(completo di accessori per l'installazione)

ADDITIONAL LED HIGHLIGHT 10W-720 LM

- 6500K - WATERPROOF

(with dedicated brackets)





LAMPADINE A LED

LED BULBS

24 651 0765



HB3
580 Lumen
27 Led



24 651 0775



H7
580 Lumen
27 Led



24 651 0785



H4
600 Lumen
24 Led



24 651 0795



H8 H9 H11
580 Lumen
26 Led



24 651 0805



9006
580 Lumen
26 Led



24 651 0945



BA20D
480 Lumen
Hi Power Led



24 651 0895



BA15D
410 Lumen
24 Led



24 651 0905



BA15S
450 Lumen
27 Led



24 651 0925



BA15S
150 Lumen
8 Led



24 651 0885



BA15D
410 Lumen
24 Led

24 651 0915



BA15S
450 Lumen
27 Led

24 651 0935



BA15S
150 Lumen
8 Led

24 651 0965  ○

BA9S
90 Lumen
5 Led



24 651 0985  ○

BA9S (Canbus)
140 Lumen
9 Led



24 651 0955  ○

BA15S
280 Lumen
24 Led

NEW



24 651 0975  ○

BA9S
90 Lumen
5 Led

24 651 0995  ○

BA9S (Canbus)
140 Lumen
9 Led

24 651 1005  ○

BAY15S
450 Lumen
24 Led



24 651 1015  ○

BAY15S
450 Lumen
24 Led



24 651 1025  ○

BAY15D
410 Lumen
24 Led

24 651 1035  ○

BAY15D
410 Lumen
24 Led



24 651 1055  ○

C10W 31 mm (Canbus)
100 Lumen
4 Led

NEW



24 651 1045  ○

C10W 31 mm (Canbus)
150 Lumen
6 Led



24 651 1065  ○

C10W 39 mm (Canbus)
150 Lumen
9 Led





LAMPADINE A LED

LED BULBS

24 651 1075



C10W 41 mm (Canbus)
150 Lumen
6 Led



24 651 0815



T10 (Canbus)
465 Lumen
13 Led



24 651 0825



T10 (Canbus)
90 Lumen
6 Led



24 651 0855



T10 (Canbus)
90 Lumen
6 Led

24 651 0835



T10 (Canbus)
30 Lumen
2 Led



24 651 0865



T20
280 Lumen
24 Led



24 651 1095



T20 Biluce
280 Lumen
24 Led



24 651 0845



T10 (Canbus)
30 Lumen
2 Led

24 651 0875



T20
280 Lumen
24 Led

24 651 1085



T20 Biluce
280 Lumen
24 Led

NEW



24 611 0010 

DEVIO FRECCHE - INDICATORS SWITCH

GILERA: Easy Moving 50 95-96 • Storm 50 94-95 • Typhoon 50 94-97 • Typhoon X 50 98-99 • Typhoon Xr 00 • Typhoon 125 95-98 • Typhoon X-Xr 125 99-00

PIAGGIO: Ape FL • FL2 50 89-95 • Ape Rst Mix 50 99-01 • Ape FL3 Europa 50 96-99 • Free 50 92-00 • Free Delivery 50 00-01 • Nrg 50 94-96 • Nrg Rst Mc2 50 96-98 • Ntt 50 95-96 • Quartz 50 92-96 • Sfera Maquillage 2 50 94 • Sfera Base 50 91-93 • Skipper 125-150 94-97 • Skr City 80 99 • Velofax 50 96-99 • Zip Rst 50 96-99 • Zip-Fast R. 50 93-97 • Zip Sp 50 96-97 • Zip Base 50 95-96 • Zip & Zip Bim. 50 94-97 (R.O.294917)



24 611 0020 

**DEVIO FRECCHE (SX)
 INDICATORS SWITCH (LH)**

MBK 50: Spirit • Spirit Eu 2 99-02 • Ng 01-02 • Booster • L Booster 01-02 • Stunt 00-02 • Mach G 02

YAMAHA 50: Bw's Next G. Cat. • Next G. 99-02 • Bw's original 99-02 • Bw's R 01 • Slider 00-02 • Jog R 02 (R.O. 5JHH39760000)



24 611 0030 

**DEVIO FRECCHE (SX)
 INDICATORS SWITCH (LH)**

MBK 50: Booster Ng • Ng Eu1 99-00 • Booster Spirit 99-00

YAMAHA 50: Bw's original 99-00 • Bw's Next • Generation 99-00 (R.O. 5FXH39760000)



24 611 0040 

DEVIO FRECCHE - INDICATORS SWITCH

PIAGGIO: Vespa Px • Pe (R.O. 215669)



24 611 0060 

DEVIO FRECCHE - INDICATORS SWITCH

PIAGGIO: Vespa S • Vespa Lx • Vespa Et4 • Vespa Gts • Sfera • Liberty (R.O. 294723)



24 611 0070 

DEVIO FRECCHE - INDICATORS SWITCH

PIAGGIO VESPA: 50: Pk 82-84 • N 89-90 • Pk Automatica 84-89 • Pk XL Plurimatic 85-90 • Pk XL Rush 85-90 • Pk XL 85-88 • **125:** Pk XL 86-89 • Px Eu2 01-07 • Px 30 anni 07-08 • Px T5 85-89 • Px 98-13 • Pxe Arcobaleno 81-97 (R.O. 580395 Ex 231849)



24 611 0080 

DEVIO FRECCHE - INDICATORS SWITCH

APRILIA 250: Scarabeo Light 06-08 • Scarabeo Light 09-10 • **300:** Scarabeo Light 09-10 • **400:** Scarabeo Light 06-08 • (A.O. AP8127892) **PIAGGIO 125:** X9 Evolution 03 • X9 Evolution Eu3 07 • X9 Evolution 05-06 • X9 01-02 • **250:** X9 Evolution 04-06 • X9 00-01 • **500:** X9 Evolution Abs 06-07 • X9 Evolution 03-07 (R.O. 638708)



24 611 0090 

DEVIO FRECCHE - INDICATORS SWITCH

APRILIA 50: Sport City One 2T/4T 08-11 • Sr Motard 12-13 • **125:** Sport City One 4T Eu3 08-11 • Sr Motard 12-13 **GILERA 50:** Runner Purejet 2T 05-07 • Runner Sp 97-09 • Stalker 97-11 • Storm Eu2 07 **125-180:** Runner Fx/Fxr 97-02 • **125:** Runner 4T/Vx/Race Eu3 02-13 • **200:** Runner Vxr 02-11 **PIAGGIO 50:** Fly 4T 2V 13 • Liberty 4T Ptt (Deu) 07-12 • Liberty Moc 4T & Elle 09-13 • Nrg Power DD 07-13 • Nrg Power Purejet 10-11 **125:** Fly 4T 3V ie Eu3 Lem 12-13 • Liberty 4T 2V Eu3 09-12 • Liberty 4T Sport Eu3 06-08 • Liberty 4T 06-07 • Liberty Sport 06 • Mp3 Yourban ERL 11-12 • X7 Eu3 08 • **150:** Liberty 4T Eu3 08 • Liberty 4T Sport Eu3 08 • **200:** Liberty 4T Eu3 06-08 • Liberty 4T Sport Eu3 06-07 • **250:** X7 Eu3 08 • **300:** Mp3 ie Mic 11 • X7 Evo Ie Eu3 09-10 • **400:** Mp3 ie Lt Touring 11 • Mp3 RL Touring 11 • Mp3 RL Touring 11 • X Evo 07-11 • X8 Eu3 06-08 • **500:** Mp3 Lt Sport - Business 11-13 (R.O. 58056R)



24 611 0100 

DEVIO FRECCHE (SX) - INDICATORS SWITCH (LH)

PIAGGIO 50: Vespa Lxv 2T Navy 08 • Vespa Lxv 2T 06-09 (R.O. 640927)





PULSANTI - DEVIO LUCI - AVVIAMENTO
BUTTONS - LIGHT SWITCHES - START BUTTONS

24 611 0110



NEW
domino

DEVIO FRECCHE (SX) - INDICATORS SWITCH (LH)
PIAGGIO 125: Vespa Gtv 4T navy Eu3 08 •
 Vespa Lxv 4T Navy Eu3 07-08 • 250: Vespa Gtv
 4T Navy Eu3 07
 (R.O. 640930)



24 609 0030



DEVIO LUCI (DX) - LIGHT SWITCH (RH)
MBK 50: Booster Spirit • Spirit Eu2 99-02 • Ng
 01-02 • Booster • L Booster 01-02 • Stunt 00-02
YAMAHA 50: Bw's Next G 01-02 • Next G. Cat.
 99-01 • Bw's original 99-02 • Bw's R 01 • Bw's
 Orig. Eu2 02 • Slider 00-02
 (R.O. 5JHH39750000)



24 609 0040



DEVIO LUCI (DX) - LIGHT SWITCH (RH)
MBK 50: Booster Ng • Ng Eu1 99-00 • Booster
 Spirit 99-00
YAMAHA 50: Bw's original 99-00 • Bw's Next •
 Generation 99-00
 (R.O. 5FXH39750000)



24 609 0050



DEVIO LUCI - LIGHT SWITCH
PIAGGIO: Vespa 150 64 Gi - Sprint
 (R.O. 087558)



24 609 0060



DEVIO LUCI - LIGHT SWITCH
PIAGGIO: Vespa 50-90 Primavera • Sprint
 Super - (R.O. 092041)



24 609 0070



DEVIO LUCI - LIGHT SWITCH
PIAGGIO: Vespa 50 R • Super Sprint
 (R.O. 092654)



24 609 0080



DEVIO LUCI - LIGHT SWITCH
PIAGGIO: Vespa Rally 200 Senza Batteria
No battery
 (R.O. 143324)



24 609 0090



DEVIO LUCI - LIGHT SWITCH
PIAGGIO: Vespa Px • Pe
 (R.O. 215668)



24 609 0100



DEVIO LUCI - LIGHT SWITCH
PIAGGIO: Vespa Pk 125
 (Senza batteria • senza avviam. elettrico)
 (Without battery and electric starter)
 (R.O. 232240)





24 609 0110 

DEVIO LUCI - LIGHT SWITCH
PIAGGIO: Vespa 50 Special
 (R.O. 123152)



24 609 0180 

DEVIO LUCI (DX) - LIGHT SWITCH (RH)
KYMCO 50: Agility (Tutti - All) • Super 8 2T 09
125: Agility Carry 11 • Agility R16 12 • Agility Rs 09
200: Agility I R16 10 • Agility R16 12
 (R.O. 00135055)



24 609 0190 

DEVIO LUCI - LIGHT SWITCH
PIAGGIO: Mp3 • X7 • X8 • X9 • X Evo
 (R.O. 294877)



24 609 0200 

DEVIO LUCI CON SPRAZZO
LIGHT SWITCH WITH FLASH
PIAGGIO: Mp3 • X7 • X8 • X9 • X Evo
 (R.O. 642967)



24 609 0210 

DEVIO LUCI - LIGHT SWITCH
PIAGGIO: Liberty 97-05 • Sfera Rst 95-97
 • Vespa Et2 97-05 • Vespa Et4 96-05
 (R.O. 293571)



24 609 0220 

DEVIO LUCI - LIGHT SWITCH
PIAGGIO 50: Typhoon 01- 04
125: Hexagon Gtx 98-99 • Hexagon Lx-Lxt 98-99
 Hexagon Lx4 98-99 • Skipper 4T 00-02 • Skip-
 per Lx 98-99 • Super Hexagon Gtx 12 01-02 •
 X9 01-02 • Zip 00-02 • **180:** X9 Amalfi 00-03 •
200: X9 02-03 • **250:** Hexagon Gt-Gtx 98-00 •
 X9 00-01
500: Beverly 02-04 • X9 01-02
 (R.O. 294340)



24 609 0230 

DEVIO LUCI - LIGHT SWITCH
PIAGGIO 50: Zip • Liberty • Fly • Nrg Power
125: Zip • Liberty • Fly
 (R.O. 642968)



24 609 0240 

DEVIO LUCI - LIGHT SWITCH
PIAGGIO: Vespa 50-S-Ss-V5SA1T-V5SS1T
 (R.O. 73169)



24 609 0250 

DEVIO LUCI 2 posizioni
LIGHT SWITCH 2 positions
GILERA 50: Runner 97-00
PIAGGIO 50: Nrg Extreme 99-00 • Nrg Mc3
 01-04 • Zip 4T 00-05 • Zip Sp 01-04 • Zip 00-04
 (R.O. 294714)





PULSANTI - DEVIO LUCI - AVVIAMENTO
BUTTONS - LIGHT SWITCHES - START BUTTONS

24 609 0260



DEVIO LUCI - LIGHT SWITCH

PIAGGIO 125: Vespa Px 30 Anni 07-08 • Vespa Px Eu2 01-07 • Vespa Px 11-13

150: Vespa Px 11-13
 (R.O. 583090)



24 609 0270



DEVIO LUCI - LIGHT SWITCH

GILERA 125: Typhoon 95-98 • Typhoon X-Xr 99-00

PIAGGIO 50: Zip Rst 96-99 • **80:** Skr City 99 • **125:** Hexagon 94-97 • Skipper 94-97
 (R.O. 291954)



24 609 0280



DEVIO LUCI - LIGHT SWITCH

PIAGGIO 50: Ape FL-FL2 89-95 • Ape FL3 Europa 96-99 • Ape Mix 2T 98-08 • Ape Rst Mix 99-03 • Ape 09 • Sfera 91-93
 (R.O. 294370)



24 609 0290



NEW

DEVIO LUCI (DX) - LIGHTS SWITCHES (RH)

PIAGGIO 50: Vespa Lxv 2T Navy 08 • Vespa Lxv 2T 06-09
 (R.O. 640926)



24 609 0300



NEW

DEVIO LUCI (DX) - LIGHTS SWITCHES (RH)

PIAGGIO 125: Vespa Lxv 4T Navy Eu3 07-08 • Vespa Gtv 4T Navy Eu3 07
 (R.O. 640929)



24 609 0310



NEW

DEVIO LUCI (DX) - LIGHTS SWITCHES (RH)

PIAGGIO 125: Vespa Gtv 4T Navy Eu3 08
 (R.O. 640928)



24 611 0050



DEVIO LUCI (SX) - LIGHT SWITCH (LH)

KYMCO 50: Agility (Tutti) • Super 8 2T 07 • People S 05-08 • People S 4T 06-08 • People Eu 2 11
125: Agility Carry 11 • Agility R16 08-12 • People S 05 • People S Dd Eu 3 07-08 • People Eu 3 11 • Super 8 08-09

150: Agility R16 08-09

200: Agility I R16 10 • Agility R16 12

• People S 05 • People S I 07

(R.O. 00152643)



24 613 0010



PULSANTE CLACSON - HORN SWITCH

PIAGGIO 50: Ape FL - FL2 89-95 • Ape FL3 Europa 96-99 • Ape Mix 2T 98-08 • Ape Rst Mix 99-03 • Ape 09 • Free Delivery 00-01 • Free FL 95-02 • Nrg Rst Mc2 96-98 • Nrg 94-96 • Ntt 95-96 • Quartz 92-96 • Sfera Maquillage 2 94 • Sfera 91-93 • Velofax 96-99 • Zip Bimodale 94-97 • Zip Fast Raider Rst 96-97 • Zip Fast Raider 93-94 • Zip Rst 96-99 • Zip Sp 96-00 • Zip 92-96 • Skr City 99 • **100:** Free 02-03 • **125:** Hexagon 94-97 • Skipper 94-97
 (R.O. 290679 - Ex 292364)



24 613 0020



PULSANTE CLACSON - HORN BUTTON

PIAGGIO: Versione Nera - Black Version





24 613 0060 

PULSANTE CLACSON - HORN BUTTON
PIAGGIO: Zip • Fly • Nrg • Vespa Et4 • Vespa Gts
 Liberty • Carnaby • Beverly • X8 • X9 • X Evo
 (R.O. 58058R)



24 613 0070 

PULSANTE CLACSON - HORN BUTTON
PIAGGIO: Vespa Lx • Vespa Gts • Mp3
 (R.O. 641358)



24 609 0160 

PULSANTE AVVIAMENTO - START BUTTON
 Dispositivo elettrico avviamento motore
 Funzioni: avviamento motore,
 con connettore
Functions: engine start, with connector



24 613 5030 

PULSANTE AVVIAMENTO - STARTING BUTTON
PIAGGIO: Zip • Fly • Nrg • Vespa Et4 • Vespa Gts
 Liberty • Carnaby • Beverly • X8 • X9 • X Evo
 (R.O. 58057R)



24 613 5040 

PULSANTE AVVIAMENTO - STARTING BUTTON
PIAGGIO: Vespa Lx • Vespa Gts • Mp3
 (R.O. 641359)



24 613 5050 

PULSANTE AVVIAMENTO - START BUTTON
GILERA 50: Typhoon X 98-99 • Typhoon Xr 00
 • Typhoon 94-97 • **125:** Typhoon X-Xr 99-00 •
 Typhoon 95-98
PIAGGIO 50: Ape FL3 Europa 96-99 • Ape Mix
 2T 98-08 • Ape Rst Mix 99-03 • Ape 09 • Free
 Delivery 00-01 • Free FL 95-02 • Free 92-94 •
 Nrg Rst Mc2 96-98 • Nrg 94-96 • Ntt 95-96 •
 Quartz 92-96 • Sfera Maquillage 2 94 • Sfera
 91-93 • Zip Fast Raider Rst 96-97 • Zip Fast
 Raider 93-94 • Zip Rst 96-99 • Zip Sp 96-00 •
 Zip 92-93 • **80:** Skr City 99 • **100:** Free 02-03 •
125: Hexagon 94-97 • Skipper 94-97
 (R.O. 294398)



24 613 5060 

PULSANTE AVVIAMENTO - START BUTTON
PIAGGIO VESPA: 50: N 89-90 • Pk XL PLuri-
 matic 85-90 • Pk XL Rush 88-89 • Pk XL 85-88 •
 Pk 82-84 • **125:** Pk XL 86-89 • Px 30 anni 07-08
 • Px Eu2 01-07 • Px T5 85-89 • Px 98-13 • Pxe
 Arcobaleno 81-97 • **150:** Px 11-13
 (R.O. 580937)



24 614 0500 

PULSANTE CONSENSO AVVIAM.-SWITCH START
PIAGGIO VESPA: 50: N 89-90 • Pk XL Rush 88-
 89 • Pk XL 85-88 • **125:** Pk XL 86-89 • Pk 30 anni
 07-08 • Px Eu2 01-07 • Px T5 85-89 • Px 98-13 •
 Pxe Arcobaleno 81-97 • **150:** Px 11-13
 (R.O. 583330)



24 609 0150 

PULSANTE ARRESTO - STOP BUTTON
 Dispositivo elettrico arresto motore
 Funzioni: arresto motore, con connettore
Functions: engine stop, with connector





PULSANTI - DEVIO LUCI - AVVIAMENTO
BUTTONS - LIGHT SWITCHES - START BUTTONS

24 613 0050



PULSANTE SPEGNIMENTO - STOP BUTTON
PIAGGIO: Vespa Rally 200
 (R.O. 073185)



24 609 0170



PULSANTE MODE - MODE SWITCH
 Dispositivo elettrico mode computer
 Funzioni: mode computer, con connettore
 Functions: mode computer, with connector



24 613 0200



PULSANTE MODE - MODE SWITCH
PIAGGIO 125: Liberty Elettrico Ppt Aut 11 • Beverly Rst 4T 4V ie Eu3 10-13 • Mp3 ie Touring 11-12 • Mp3 ie 08-09 • Mp3 Yourban ERL 11-12 • Mp3 06-08 • X Evo 07-12 • **250:** Mp3 Lt 08-09 • Mp3 Mic 08-09 • Mp3 06-08 • X Evo 07-13 • **300:** Beverly Rst 4T 4V ie Eu3 10-13 • Mp3 ie Mic 11 • Mp3 ie Lt Touring 11-12 • Mp3 ie Lt ie Lt Sport 11-13 • Mp3 ie Touring 11-12 • Mp3 ie Lt 10-11 • Mp3 Le Mic 10 • Mp3 Yourban ERL 11 • Mp3 Yourban Lt ERL 11-12 • **350:** Beverly 4T 4V ie Eu3 Sport Touring 11-13 • **400:** Mp3 ie Lt - Mp3 ie Lt Sport 08-10 • Mp3 ie Lt Touring 11 • Mp3 Mic 08-10 • Mp3 RL Touring 11 • Mp3 07-08 • X Evo 07-11 • **500:** Mp3 Lt Sport - Business 11-13 • Mp3 RL Sport - Business 11-12
 (R.O. 58255R - Ex 639140)



24 611 0500



INTERUTTORE TERGICRISTALLO
WINDSCREEN WIPER SWITCH
PIAGGIO 50: Ape 09 • Mix 2T 98-08 • Rst Mix 99-03 • FL3 Europa 96-99 • FL-FL2 89-95
 (R.O. 584097)



24 613 0210



PULSANTE TRIP - TRIP SWITCH
PIAGGIO 125: Mp3 Ibrido 09-10 • **300:** Mp3 4T 4V ie ERL Ibrido 10-13 • Mp3 4T 4V ie Lt Ibrido 10-11
 (R.O. 641837)



24 613 0220



PULSANTE EMERGENZA - EMERGENCY BUTTON
APRILIA 250: Scarabeo Light 06-08 • **300:** Scarabeo Light 09-10 • **400:** Scarabeo Light 06-08
 (R.O. AP8127894)
GILERA 500: Fuoco Eu3 07-13
PIAGGIO 125: Mp3 Ibrido 09-10 • Mp3 ie 08-09 • Mp3 Yourban ERL 11-12 • Mp3 06-08 • Mp3 ie Touring 11-12 • X Evo 07-12 • X9 Evolution Eu3 07 • X9 Evolution 03-06 • X 9 01-02 **180:** X9 Amalfi 00-03 • **200:** X9 Evolution 03 • X9 02-03 • **250:** Mp3 Lt 08-09 • Mp3 Mic 08-09 • Mp3 06-08 • X Evo 07-13 • X9 Evolution 04-06 • X9 00-01 • **300:** Mp3 ie Mic 11 • Mp3 ie Lt 10-11 • Mp3 ie Mic 10 • Mp3 Yourban ERL 11 • Mp3 Yourban Lt ERL 11-12 • Mp3 ie Lt Touring 11-12 • Mp3 ie Lt-ie Lt Sport 11-13 • Mp3 ie Touring 11-12 • **400:** Mp3 ie Lt - Mp3 ie Lt Sport 08-10 • Mp3 ie Lt Touring 11 • Mp3 Mic 08-10 • Mp3 RL Touring 11 • Mp3 07-08 • X Evo 07-11 • **500:** X9 Evolution Abs 06-07 • X9 Evolution 03-07 • X9 01-02
 (R.O. 58284R - 511411)





24 613 0230



PULSANTE APERTURA SELLA - SADDLE OPENING BUTTON

APRILIA 850: Srv - Srv Abs Atc 12-13

GILERA 800: Gp 09-11 • **PIAGGIO 125:** Beverly Eu3 Mic 07 • Beverly Eu3 Sport 07-08 • Beverly Eu3 07-08 • Beverly Rst 4T 4V ie Eu3 10-13 • Beverly Rst 04-07 • Beverly Tourer Eu3 07-10 • Beverly 01-03 • Mp3 Ibrido 09-10 • Mp3 ie Touring 11-12 • Mp3 ie 08-09 • Vespa Gt Eu3 06-07 • Vespa Gt 04-07 • Vespa Gts 4T ie Super 09-13 • Vespa Gts Eu3 07-12 • Vespa Gts Eu3 07-12 • Vespa Gtv 4T Navy Eu3 08 • Vespa Gtv 06-08 • Vespa Lx Primavera 4T 3V ie 13 • Vespa Sprint 4T 3V ie 14 • X10 4T 4V ie Eu3 12-13 • X8 Premium Eu2 06 • X8 Premium Eu3 06-07 • X8 Street Eu2 06-07 • X8 04-06 • X9 Evolution Eu3 07 • X9 Evolution 05-06 • **150:** Vespa Primavera 4T-3V 13 • X8 Street Eu2 06-08 • **200:** Vespa Gt 06-07 • X8 05-07 • **250:** Beverly Eu3 Mic 07 • Beverly ie Eu3 06-08 • Beverly Rst 04-05 • Beverly Sport 06-08 • Beverly Tourer Eu3 08-09 • Beverly 06-07 • Mp3 Mic 08-09 • Vespa Gt 60 Eu3 06-07 • Vespa Gts Abs 05-12 • Vesta Gts 05-13 • Vespa Gtv 4T Navy Eu3 07 • Vespa Gtv 06-09 • X8 Eu3 05-08 • X9 Evolution 04-06 • **300:** Beverly Rst 4T 4V ie Eu3 10-13 • Beverly Tourer Eu3 09-10 • Mp3 ie Lt 10-11 • Mp3 ie Mic 10-11 • Mp3 4T 4V ie ERL Ibrido 10-13 • Mp3 4T 4V ie Lt Ibrido 10-11 • Mp3 ie Lt Touring 11-12 • Mp3 ie Lt - ie Lt Sport 11-13 • Mp3 ie Touring 11-12 • Vespa Gts ie Touring 11-12 • Vespa Gts ie 12-13 • Vespa Gts Super Sport 10-13 • Vespa Gts Super 08-13 • Vespa Gtv 4T 4V ie 10-13 • Vespa Gtv Via Montenapoleone 10 • **350:** Beverly 4T 4V ie Eu3 Sport Touring 11-13 • X10 4T 4V ie Eu3 12-13 • **400:** Beverly Eu3 06-07 • Beverly Tourer Eu3 08-10 • Mp3 ie Lt - Mp3 ie Lt Sport 08-10 • Mp3 ie Lt Touring 11 • Mp3 Mic 08-10 • Mp3 RL Touring 11 • X Evo 07-11 • X8 Eu3 06-08 • **500:** Beverly Eu3 06-08 • Beverly 02-06 • Mp3 Lt Sport - Business 11-13 • Mp3 RL Sport - Business 11-12 • X10 4T 4V ie Eu3 12-13 • X9 Evolution Abs 06-07 • X9 Evolution 06-07 • (R.O. 582988)



24 613 0240



PULSANTE REGOLAZIONE AMMORTIZZATORE SHOCK ABSORBER REGULATION BUTTON

PIAGGIO 500: X10 4T 4V ie Eu3 12-13

(R.O. 643231)



24 613 0280



PULSANTE ANTI SLIP - ASR BUTTON

PIAGGIO 125: X10 4T 4V ie Eu3 12-13 • **350:** Beverly 4T 4V ie Eu3 Sport Touring 11-13 • X10 4T 4V ie Eu3 12-13 • **500:** X10 4T 4V ie Eu3 12-13 (R.O. 643130)





CLACSON
HORN

24 607 0010



APRILIA 50 - CAGIVA 50 - HONDA 50 - LEM 50
MALAGUTI 50: - (R.O.01801600)
MBK 50 - PEUGEOT 50-125 - SUZUKI 50
YAMAHA 50-125

24 607 0020



12 V C.C.
APRILIA 50: (R.O. AP 8212587)

24 607 0030



12 V C.C. - Ø 71/65
(Staffa foro filettato Ø 6 mm
Threaded bracket hole Ø 6 mm)
GILERA 50-125-200-250-300-500
PIAGGIO 50-125-150-180-200-250-500
(R.O. CM071801 > 58034R)



24 607 0040



6 V C.A. 18-24 W
PIAGGIO 50-125: (R.O. 070300)



24 607 0050



12 V C.A. 18-24 W
PIAGGIO 125-150-200: Vespa Px
(R.O. 2189379)



24 607 0060



12 V C.C. - Ø 71/65
(Staffa foro Ø 6 mm - *Bracket hole Ø 6 mm*)
GILERA 50-125-180-200-500
PIAGGIO 50-125-150-200-250-400
(R.O. 294828 > 58033R > CM071803)



24 607 0070



12 V C.C. - Ø 71/65
(Staffa foro filettato Ø 6 mm
Threaded bracket hole Ø 6 mm)
GILERA 50 - PIAGGIO 50-125-250-400
(R.O. CM071804)



24 607 0080



12 V C.C. - Ø 71/65
(Staffa foro Ø 6mm - *Bracket hole Ø 6 mm*)
GILERA 50 - PIAGGIO 50-100-125-150-250-300
(R.O. CM071805 > 58093R)



24 607 0090



12 V C.C. - Ø 71/65
(Staffa foro Ø 6 mm - *Bracket hole Ø 6 mm*)
PIAGGIO 125-150-200-250-400
(R.O. CM071806 > 58092R)





24 607 0100



12 V C.C. - Ø 71/65

(Staffa foro Ø 4 mm - Bracket hole Ø 4 mm)

PIAGGIO 50-125-150-200:

Pk 125 (avviamento elettrico-electric starter)

Ape 50 (Tutti - All)

(R.O. CM071807 > 58144R)



24 607 0110



12 V C.C. - Ø 71/65

(Staffa foro filettato Ø 6mm

Threaded bracket hole Ø 6 mm)

GILERA 50

PIAGGIO 50-100-125-150-250-400-500

(R.O. 58094R > 58131R > CM071802 -

CM071814)



24 607 0121



TROMBA - HORN - 12 V C.C. - Ø 81

(Staffa foro Ø 8 mm - Bracket hole Ø 8 mm)

PIAGGIO 125-180-200-250-500

(R.O. 581441 > 640474)



24 607 0130



12 V C.C.

PIAGGIO: Ape Tm 703

(R.O. 292695)



24 607 0140



6 V C.C.

PIAGGIO 125: Vespa V1T-V15T-V30T-V33T

(R.O. 011635)



24 607 0150



6 V C.C.

PIAGGIO 125-150: Vespa VM1/2-VUU1-VM1/2

(R.O. 020250)



24 607 0160



6 V C.C.

PIAGGIO 150: Vespa VL3-VB1

(R.O. 025714)



24 607 0170



6 V C.C.

PIAGGIO 150: Vespa VL3-VB1

(R.O. 025714B)



24 607 0180



6 V C.A.

PIAGGIO: Vespa 50-90 SS-Nuova 125 V5A1-V55S-V9A1-V9SS-VNB3/4

(R.O. 093753)





CLACSON
HORN

24 607 0190



6 V C.A.

PIAGGIO: Vespa 50N-R-90 SS-Nuova
125-V5A1T-V9SS1T-VMA1T
(R.O. 097828)



24 607 0210



6 V C.C.

PIAGGIO: Vespa 150-GL 150-160 GS-180 SS-
VBA1T-VBB1T-VS2/3/4/5
(R.O. 089840)



24 607 0220



6 V C.C.

PIAGGIO: Vespa 150-GL - 150-160 GS-180 SS-
VBA1T-VBB1T-VS2/3/4/5
(R.O. 089840)



24 607 0230



6 V C.A.

PIAGGIO 50: Ciao • Si • Bravo • Boxer
(R.O. 122232)



24 607 0240



NEW

COPPIA CLACSON SUONO POTENTE 12 V
POWERFULL BLAST 12 V HORN
MOTOCICLI E SCOOTER
MOTORCYCLE AND SCOOTER

- Dimensioni - *Dimensions:* Ø 91 mm

- Omologazione - *Homologations:* CEE/ECE



12 183 0430



GUARNIZIONE CLACSON COLORE NERA
HORN GASKET BLACK COLOUR

PIAGGIO 125: Vespa Primavera VMA2
(R.O. 120798)



12 183 0431



GUARNIZIONE CLACSON
HORN GREY GASKET

PIAGGIO 50: Vespa N-L-R V5A1T
(R.O. 92468)





MODELLO MODEL	CC	ANNI YEARS	RIF. ORIGINALE OEM NUMBER	CODICE RMS RMS CODE	MODELLO MODEL	CC	ANNI YEARS	RIF. ORIGINALE OEM NUMBER	CODICE RMS RMS CODE
APRILIA					Ciak Master	150	04	01801600	24 607 0010
Scarabeo	50	93-97	AP8212587	24 607 0020	Ciak Restyling Eu2	150	03	01801600	24 607 0010
Rs	50	91-98	AP8224179	24 607 0010	Ciak	150	00-02	01801600	24 607 0010
CAGIVA					F18 Warrior	150	00-02	01801600	24 607 0010
City	50	-	-	24 607 0010	Madison T	150	99-01	01801600	24 607 0010
Supercity	50	-	-	24 607 0010	Madison R	180	01-02	01801600	24 607 0010
GILERA					Ciak Master Eu2	200	06	01801600	24 607 0010
Runner	50	97-00	58033R	24 607 0060	Madison S Restyling Eu2	200	03	01801600	24 607 0010
Runner Poggiali	50	02	294828	24 607 0060	Madison S Restyling	200	02	01801600	24 607 0010
Runner Purejet	50	02-04	CM071805	24 607 0080	Phantom Max	200	03	01801600	24 607 0010
Runner Purejet	50	05-06	CM071802-CM071814	24 607 0110	Madison Rs Restyling	250	04	01801600	24 607 0010
Runner Sp	50	02-04	294828	24 607 0060	Madison S	250	99-01	01801600	24 607 0010
Stalker	50	97-04	CM071804	24 607 0070	Phantom Max	250	04	01801600	24 607 0010
Storm Eu2	50	07	CM071803	24 607 0060	Madison K Restyling	400	02-04	01801600	24 607 0010
Typhoon	50	94-97	58033R	24 607 0060	Madison K	400	02	01801600	24 607 0010
Typhoon X	50	98-99	58033R	24 607 0060	Spidermax Gt	500	04-05	01801600	24 607 0010
Typhoon Xr	50	00	58033R	24 607 0060	MBK				
Nexus Eu3	125	07-08	58034R	24 607 0030	Evolis	50	-	-	24 607 0010
Nexus Eu3 le	125	08-09	58034R	24 607 0030	Sorriso	50	-	-	24 607 0010
Runner Fx-Fxr	125	97-02	CM071803	24 607 0060	Booster	50	-	-	24 607 0010
Runner Vx Vxr	125	02-04	CM071803	24 607 0060	Target	50	-	-	24 607 0010
Runner Vx Vxr	125	00-01	CM071803	24 607 0060	PEUGEOT				
Runner Fx-Fxr	180	97-02	CM071803	24 607 0060	Rapido	50	-	-	24 607 0010
Runner Vxr 4T St Eu3	200	08	58034R	24 607 0030	Sv	50	-	-	24 607 0010
Nexus Eu3	250	06-09	58034R	24 607 0030	Sv	125	-	-	24 607 0010
Nexus Sp Eu3	250	06-07	58034R	24 607 0030	PIAGGIO				
Fuoco	500	07-09	CM071803	24 607 0060	Ape FL - FL2	50	89-95	CM071807	24 607 0100
Nexus Eu3	500	06-09	58034R	24 607 0030	Ape FL3 Europa	50	96-99	CM071807	24 607 0100
Nexus Sp Eu3	500	06-07	58034R	24 607 0030	Ape Tm P	50	85-89	CM071807	24 607 0100
Gp	800	08-09	5814401-640474	24 607 0121	Ciao - Si	50	-	122232	24 607 0230
HONDA					Bravo - Boxer	50	-	122232	24 607 0230
Vision	50	-	-	24 607 0010	FLy 2T	50	05-07	CM071805	24 607 0080
MALAGUTI					FLy 4T	50	05-08	CM071805	24 607 0080
Ciak Master 4T	50	05-06	01801600	24 607 0010	FLy 4T Mot Chn	50	06-07	CM071805	24 607 0080
Ciak Master Eu2	50	06	01801600	24 607 0010	Free	50	92-94	CM071803	24 607 0060
Ciak Master	50	04	01801600	24 607 0010	Free Delivery	50	00-01	CM071806	24 607 0090
Ciak Mono Eu2 2.3	50	03	01801600	24 607 0010	Free FL	50	95-02	CM071803	24 607 0060
Ciak Mono Eu2	50	03	01801600	24 607 0010	Liberty	50	97-05	CM071803	24 607 0060
FL 0 Ac Eco	50	09-10	01801600	24 607 0010	Liberty 2T	50	06-08	CM071803	24 607 0060
F10 Ac	50	08	01801600	24 607 0010	Liberty 2T Rst	50	04	CM071803	24 607 0060
F10 Restyling Eu1	50	01-02	01801600	24 607 0010	Liberty 2T Sport	50	06-08	CM071803	24 607 0060
F10 Restyling Eu2-2.3	50	03-04	01801600	24 607 0010	Liberty 2T Sport	50	06	CM071805	24 607 0080
F10 Restyling Eu2	50	02-03	01801600	24 607 0010	Liberty 4T	50	00-02	CM071805	24 607 0080
F10 Restyling Eu2	50	06	01801600	24 607 0010	Liberty 4T	50	05-08	CM071805	24 607 0080
F12 Aria Restyling Eu 2	50	06	01801600	24 607 0010	Liberty 4T Rst	50	04	CM071803	24 607 0060
F12 Lc Restyling Eu 2	50	06	01801600	24 607 0010	Liberty Moc 2T	50	09	CM071803	24 607 0060
F12 Phantom Lc Restyl. Eu1	50	01-02	01801600	24 607 0010	Liberty Moc 4T	50	09	CM071805	24 607 0080
F12 Phantom Lc Restyl. Eu2-2.3	50	03-04	01801600	24 607 0010	Liberty Ptt Eu2	50	04-05	CM071806	24 607 0090
F12 Phantom Lc Restyl. Eu2	50	02	01801600	24 607 0010	Nrg Power Dd	50	06-09	CM071803	24 607 0060
F12 Phantom Restyl. Eu1	50	01-02	01801600	24 607 0010	Nrg Power Dd Serie Spece	50	07-08	CM071803	24 607 0060
F12 Phantom Restyl. Eu2-2.3	50	03-04	01801600	24 607 0010	Nrg Power Dt	50	07-08	CM071803	24 607 0060
F12 Phantom Restyling Eu2	50	02	01801600	24 607 0010	Nrg Power Dt Serie Spece	50	07-08	CM071803	24 607 0060
F15 Fire Fox Air Cooled	50	05-06	01801600	24 607 0010	Nrg Power Purejet	50	06-08	CM071805	24 607 0080
F15 Fire Fox Euro2	50	02-03	01801600	24 607 0010	Sfera	50	91-93	CM071801	24 607 0030
F15 Fire Fox Restyl. Eu2-2.3	50	03-04	01801600	24 607 0010	Sfera Maquillage 2	50	94	CM071801	24 607 0030
F15 Lc Restyling Eu 2	50	04-05	01801600	24 607 0010	Typhoon	50	01-09	CM071803	24 607 0060
Fly Lc-Tds Restyling Eu1	50	01	01801600	24 607 0010	Vespa 50 Spec	50	00	070300	24 607 0040
Ciak Master Euro 3	125	06	01801600	24 607 0010	Vespa Et2	50	97-05	CM071801	24 607 0030
Ciak Master	125	04	01801600	24 607 0010	Vespa Et2 Iniezione	50	97-00	CM071801	24 607 0030
Ciak Restyling Eu2	125	03	01801600	24 607 0010	Vespa Et4	50	00-05	CM071802-CM071814	24 607 0110
Ciak	125	00-01	01801600	24 607 0010	Vespa Lx 2T	50	05-08	CM071802-CM071814	24 607 0110
F18 Warrior	125	00-02	01801600	24 607 0010	Vespa Lx 2T FL	50	09-10	CM071802-CM071814	24 607 0110
Madison R Restyling u2	125	03-04	01801600	24 607 0010	Vespa Lx 4T	50	05-08	CM071802-CM071814	24 607 0110
Madison R Restyling	125	02	01801600	24 607 0010	Vespa Lxv 2T	50	06-08	CM071802-CM071814	24 607 0110
Madison	125	99-01	01801600	24 607 0010	Vespa S 2T	50	07-08	CM071802-CM071814	24 607 0110
Phantom Max	125	03	01801600	24 607 0010	Vespa S 4T-4V	50	08-09	CM071802-CM071814	24 607 0110



CLACSON

HORN

MODELLO MODEL	CC	ANNI YEARS	RIF. ORIGINALE OEM NUMBER	CODICE RMS RMS CODE	MODELLO MODEL	CC	ANNI YEARS	RIF. ORIGINALE OEM NUMBER	CODICE RMS RMS CODE
Zip	50	92-93	CM071801	24 607 0030	Liberty 4T Sport Eu3	150	08	CM071803	24 607 0060
Zip	50	00-04	CM071801	24 607 0030	Vespa Lx	150	05-06	CM071801	24 607 0030
Zip 2T	50	08-09	CM071801	24 607 0030	Vespa Lx 4T FL	150	09	CM071801	24 607 0030
Zip 4T	50	00-08	CM071802-CM071814	24 607 0110	Vespa Lx Eu3	150	06-08	CM071801	24 607 0030
Zip Rst	50	96-99	CM071801	24 607 0030	Vespa Px (s/avv. Elettrico)	150	-	189379	24 607 0050
Zip Sp	50	96-00	CM071801	24 607 0030	Vespa S 4T	150	08-09	CM071802-CM071814	24 607 0110
Zip Sp	50	01-04	CM071804	24 607 0070	X8 Street Eu2	150	06-08	CM071806	24 607 0090
Zip Sp Eu2	50	06-09	CM071801	24 607 0030	X9 Amalfi	180	00-03	5814401-640474	24 607 0121
Fly 4T	100	06-08	CM071805	24 607 0080	Liberty	200	06	CM071803	24 607 0060
Zip 4T	100	06-08	CM071802-CM071814	24 607 0110	Liberty 4T Eu3	200	07-08	CM071803	24 607 0060
Beverly	125	01-03	CM071801	24 607 0030	Liberty 4T Sport Eu3	200	06-07	CM071803	24 607 0060
Beverly Eu3	125	07-08	CM071804	24 607 0070	Liberty Rst	200	04	CM071803	24 607 0060
Beverly Eu3 Mic	125	07	CM071804	24 607 0070	Liberty Sport	200	06	CM071803	24 607 0060
Beverly Eu3 Sport	125	07-08	CM071804	24 607 0070	Vespa Granturismo	200	06-07	CM071806	24 607 0090
Beverly Rst	125	06-07	CM071804	24 607 0070	Vespa Px (s/avv. Elettrico)	200	-	189379	24 607 0050
Beverly Tourer Eu3	125	08-09	CM071804	24 607 0070	X8	200	05-07	CM071806	24 607 0090
FLy	125	05-07	CM071805	24 607 0080	X9	200	02-03	5814401-640474	24 607 0121
FLy Eu3	125	07-08	CM071805	24 607 0080	X9 Evolution	200	03	5814401-640474	24 607 0121
Hexagon	125	94-97	CM071801	24 607 0030	Ape Car P2-P3	220	78-85	292695	24 607 0130
Hexagon Gtx	125	00	CM071801	24 607 0030	Ape Mp P501-P601	220	78-96	292695	24 607 0130
Hexagon Lx-Lxt	125	98-99	CM071801	24 607 0030	Ape Tm P602	220	82-83	292695	24 607 0130
Hexagon Lx4	125	98-99	CM071801	24 607 0030	ApeTmP703-P703V,FL2	220	84-05	292695	24 607 0130
Liberty	125	01-02	CM071803	24 607 0060	Beverly	250	06-07	CM071804	24 607 0070
Liberty 4T	125	06-07	CM071803	24 607 0060	Beverly Cruiser	250	07-09	CM071802-CM071814	24 607 0110
Liberty 4T Eu3	125	07-08	CM071803	24 607 0060	Beverly Eu3 Mic	250	07	CM071802-CM071814	24 607 0110
Liberty 4T Eu3 Delivery	125	08	CM071806	24 607 0090	Beverly le Eu3	250	06-08	CM071802-CM071814	24 607 0110
Liberty 4T Sport Eu3	125	06-08	CM071803	24 607 0060	Beverly Rst	250	04-05	CM071804	24 607 0070
Liberty Rst	125	04-05	CM071803	24 607 0060	Beverly Tourer Eu3	250	08-09	CM071802-CM071814	24 607 0110
Liberty Rst Ptt	125	05-06	CM071806	24 607 0090	Hexagon Gt-Gtx	250	98-00	CM071801	24 607 0030
Liberty Sport	125	06	CM071803	24 607 0060	Mp3	250	06-08	CM071803	24 607 0060
Mp3	125	07-08	CM071803	24 607 0060	Mp3 Lt	250	09	CM071803	24 607 0060
Mp3 le	125	08-09	CM071803	24 607 0060	Mp3 Mic	250	08-09	CM071803	24 607 0060
Skipper	125	94-97	CM071803	24 607 0060	Vespa Gt 60 Eu3	250	06-07	CM071805	24 607 0080
Skipper 4T	125	00-02	CM071803	24 607 0060	Vespa Gts, Gts Abs	250	05-09	CM071806	24 607 0090
Super Hexagon Gtx 12	125	01-02	CM071801	24 607 0030	Vespa Gtv	250	06-09	CM071805	24 607 0080
Vespa Et4	125	96-98	CM071801	24 607 0030	Vespa Gtv 4T Navy Eu3	250	08	CM071805	24 607 0080
Vespa Et4	125	99-02	CM071801	24 607 0030	X7 Eu3	250	08	CM071806	24 607 0090
Vespa Granturismo	125	03-05	CM071806	24 607 0090	X8 Eu3	250	05-08	CM071806	24 607 0090
Vespa Granturismo Eu3	125	06-07	CM071806	24 607 0090	X9 Evolution	250	04	5814401-640474	24 607 0121
Vespa Gts Eu3	125	07-09	CM071806	24 607 0090	X9 Evolution	250	06	5814401-640474	24 607 0121
Vespa Gtv	125	07-08	CM071806	24 607 0090	Xevo	250	07	CM071806	24 607 0090
Vespa Gtv 4T Navy Eu3	125	08	CM071806	24 607 0090	Beverly 300 le Tourer	300	09	CM071802-CM071814	24 607 0110
Vespa Lx	125	05-06	CM071801	24 607 0030	Vespa Gts Super	300	08	CM071805	24 607 0080
Vespa Lx 4T FL	125	09	CM071801	24 607 0030	Beverly Eu3	400	06-07	CM071804	24 607 0070
Vespa Lx Eu3	125	06-08	CM071801	24 607 0030	Beverly Tourer Eu3	400	08-09	CM071802-CM071814	24 607 0110
Vespa Lxv 4T Eu3	125	06-09	CM071801	24 607 0030	Mp3	400	07-08	CM071803	24 607 0060
Vespa Lxv 4T Navy Eu3	125	08	CM071801	24 607 0030	Mp3 Lt	400	09	CM071803	24 607 0060
Vespa Primavera Et3	125	00	070300	24 607 0040	Mp3 Mic	400	08-09	CM071803	24 607 0060
Vespa Px (s/avv. Elettrico)	125	-	189379	24 607 0050	X Evo	400	07-09	CM071806	24 607 0090
Vespa Px 30 Anni	125	07-08	CM071807	24 607 0100	X8 Eu3	400	06-08	CM071806	24 607 0090
Vespa Pxe Arcobaleno	125	81-97	CM071807	24 607 0100	Ape Car- Max Diesel	420	86-96	292695	24 607 0130
Vespa S 4T Eu3	125	07-08	CM071802-CM071814	24 607 0110	Ape Tm P703-P703V Diesel	420	87-04	292695	24 607 0130
X Evo	125	07	CM071806	24 607 0090	Beverly	500	02-04	CM071801	24 607 0030
X7 Eu3	125	08	CM071806	24 607 0090	Beverly	500	05-06	CM071802-CM071814	24 607 0110
X8	125	04-06	CM071806	24 607 0090	Beverly Cruiser	500	07-09	CM071802-CM071814	24 607 0110
X8 Premium Eu2	125	06	CM071806	24 607 0090	Beverly Eu3	500	06-08	CM071802-CM071814	24 607 0110
X8 Premium Eu3	125	06-07	CM071806	24 607 0090	X9	500	01-02	5814401-640474	24 607 0121
X8 Street Eu2	125	06-07	CM071806	24 607 0090	X9 Evolution	500	03-07	5814401-640474	24 607 0121
X9	125	01-02	5814401-640474	24 607 0121	X9 Evolution Abs	500	06-07	5814401-640474	24 607 0121
X9 Evolution	125	03	5814401-640474	24 607 0121	YAMAHA				
X9 Evolution	125	05-06	5814401-640474	24 607 0121	Ct	50	-	-	24 607 0010
X9 Evolution Eu3	125	07	5814401-640474	24 607 0121	Cr Z	50	-	-	24 607 0010
Zip	125	00-02	CM071801	24 607 0030	Beluga	125	-	-	24 607 0010
FLy	150	05-07	CM071805	24 607 0080					
FLy Eu3	150	08	CM071805	24 607 0080					
Liberty 4T Eu3	150	08	CM071803	24 607 0060					

INTERRUTTORI FRIZIONE
CLUTCH SWITCHES



24 614 0540



NEW

INTERRUTTORE FRIZIONE
CLUTCH SWITCH
HONDA
(R.O. 35330-413-003)



24 614 0600



NEW

INTERRUTTORE FRIZIONE IDRAULICA
HYDRAULIC CLUTCH SWITCH
KAWASAKI
(R.O. 270101406)



24 614 0660



NEW

INTERRUTTORE FRIZIONE
CLUTCH SWITCH
SUZUKI
(R.O. 37560-38A00-000)



24 614 0670



NEW

INTERRUTTORE FRIZIONE IDRAULICA
HYDRAULIC CLUTCH SWITCH
SUZUKI
(R.O. 37560-02FA0-000)



24 614 0710



NEW

INTERRUTTORE FRIZIONE
CLUTCH SWITCH
YAMAHA
(R.O. 3YX82917100)



24 614 0720



NEW

**INTERRUTTORE FRIZIONE IDRAULICA/
FRENO POSTERIORE**
**HYDRAULIC CLUTCH SWITCH REAR BRAKE
SWITCH**
YAMAHA
(R.O. 36Y829170000)





INTERRUTTORI FRIZIONE

CLUTCH SWITCHES

Modello - Model	Cc	Anno Year	Codice RMS RMS Code	Rifer. Originale Oem Number	Modello - Model	Cc	Anno Year	Codice RMS RMS Code	Rifer. Originale Oem Number
HONDA					Vt 125 C Shadow 80 Km/H	125	04-05	24 614 0540	35330-413-003
Ca 125 Rebel	125	95	24 614 0540	35330-413-003	Vt 125 C2 Shadow	125	00	24 614 0540	35330-413-003
Ca 125 Rebel	125	96	24 614 0540	35330-413-003	Vt 125 C2 Shadow	125	01-02	24 614 0540	35330-413-003
Ca 125 Rebel	125	97	24 614 0540	35330-413-003	Vt 125 C2 Shadow 80 Km/H	125	00	24 614 0540	35330-413-003
Ca 125 Rebel	125	98	24 614 0540	35330-413-003	Vt 125 C2 Shadow 80 Km/H	125	01-02	24 614 0540	35330-413-003
Ca 125 Rebel	125	99-00	24 614 0540	35330-413-003	Cb 250 N Eu	250	80	24 614 0540	35330-413-003
Ca 125 Rebel 80 Km/H	125	95	24 614 0540	35330-413-003	Cb 250 N Eu	250	81	24 614 0540	35330-413-003
Ca 125 Rebel 80 Km/H	125	96	24 614 0540	35330-413-003	Cb 250 N Eu	250	78-79	24 614 0540	35330-413-003
Ca 125 Rebel 80 Km/H	125	97	24 614 0540	35330-413-003	Cb 250 Nd Eu	250	82	24 614 0540	35330-413-003
Ca 125 Rebel 80 Km/H	125	98	24 614 0540	35330-413-003	Cb 250 Nd Eu	250	83	24 614 0540	35330-413-003
Ca 125 Rebel 80 Km/H	125	99-00	24 614 0540	35330-413-003	Cb 250 Nd Eu	250	82-83	24 614 0540	35330-413-003
Cbf 125 M	125	09	24 614 0540	35330-413-003	Cb 250 Rsz	250	82-84	24 614 0540	35330-413-003
Cbf 125 M	125	10	24 614 0540	35330-413-003	Cb 250 T Twin	250	77	24 614 0540	35330-413-003
Cbf 125 M	125	11-12	24 614 0540	35330-413-003	Cb 250 T Twin	250	77-78	24 614 0540	35330-413-003
Cbf 125 M	125	13-16	24 614 0540	35330-413-003	Cb 250 Two-Fifty	250	96-98	24 614 0540	35330-413-003
Cbr 125 R	125	04	24 614 0540	35330-413-003	Cbf 250	250	06	24 614 0540	35330-413-003
Cbr 125 R	125	05	24 614 0540	35330-413-003	Cbf 250	250	04-05	24 614 0540	35330-413-003
Cbr 125 R	125	12	24 614 0540	35330-413-003	Cl 250 S Scrambler	250	82-83	24 614 0540	35330-413-003
Cbr 125 R	125	13-14	24 614 0540	35330-413-003	Cm 250 C Custom	250	82-83	24 614 0540	35330-413-003
Cbr 125 R 80 Km/H	125	12	24 614 0540	35330-413-003	Cmx 250 C Rebel	250	96	24 614 0540	35330-413-003
Cbr 125 R 80 Km/H	125	13-14	24 614 0540	35330-413-003	Cmx 250 C Rebel	250	97	24 614 0540	35330-413-003
Cbr 125 Rs Repsol	125	05	24 614 0540	35330-413-003	Cmx 250 C Rebel	250	98	24 614 0540	35330-413-003
Cbr 125 Rs Repsol	125	12	24 614 0540	35330-413-003	Cmx 250 C Rebel	250	99	24 614 0540	35330-413-003
Cbr 125 Rs Repsol	125	06-07	24 614 0540	35330-413-003	Nx 250	250	88	24 614 0540	35330-413-003
Cbr 125 Rs Repsol	125	13-14	24 614 0540	35330-413-003	Nx 250	250	89	24 614 0540	35330-413-003
Cbr 125 Rs Repsol 80 Km/H	125	12	24 614 0540	35330-413-003	Nx 250	250	90-92	24 614 0540	35330-413-003
Cbr 125 Rs Repsol 80 Km/H	125	13-14	24 614 0540	35330-413-003	Nx 250	250	93-95	24 614 0540	35330-413-003
Cbr 125 Rt	125	12	24 614 0540	35330-413-003	Cb 400 N Eu	400	80	24 614 0540	35330-413-003
Cbr 125 Rt	125	13-14	24 614 0540	35330-413-003	Cb 400 N Eu	400	81	24 614 0540	35330-413-003
Cbr 125 Rt 80 Km/H	125	12	24 614 0540	35330-413-003	Cb 400 N Eu	400	82	24 614 0540	35330-413-003
Cbr 125 Rt 80 Km/H	125	13-14	24 614 0540	35330-413-003	Cb 400 N Eu	400	78-79	24 614 0540	35330-413-003
Cbr 125 Rw	125	05	24 614 0540	35330-413-003	Cb 400 N Eu	400	83-85	24 614 0540	35330-413-003
Cbr 125 Rw	125	06	24 614 0540	35330-413-003	Cb 400 T	400	77-78	24 614 0540	35330-413-003
Cbr 125 Rw	125	09	24 614 0540	35330-413-003	Cb-1 400 F	400	89-90	24 614 0540	35330-413-003
Cbr 125 Rw	125	10	24 614 0540	35330-413-003	Cm 400 T	400	80	24 614 0540	35330-413-003
Cbr 125 Rw	125	11	24 614 0540	35330-413-003	Cm 400 T	400	81	24 614 0540	35330-413-003
Cbr 125 Rw	125	07-08	24 614 0540	35330-413-003	Cm 400 T Custom	400	82-83	24 614 0540	35330-413-003
Cbr 125 Rw 80 Km/H	125	09	24 614 0540	35330-413-003	Rvf 400 R	400	96	24 614 0540	35330-413-003
Cbr 125 Rw 80 Km/H	125	10	24 614 0540	35330-413-003	Rvf 400 R	400	94-95	24 614 0540	35330-413-003
Cbr 125 Rw 80 Km/H	125	11	24 614 0540	35330-413-003	Vfr 400 Riii	400	90	24 614 0540	35330-413-003
Cbr 125 Rw 80 Km/H	125	07-08	24 614 0540	35330-413-003	Vfr 400 Riii	400	91	24 614 0540	35330-413-003
Cg 125 Es	125	04-06	24 614 0540	35330-413-003	Cb 450 N	450	85	24 614 0540	35330-413-003
Cg 125 Es	125	07-08	24 614 0540	35330-413-003	Cb 450 S	450	86-87	24 614 0540	35330-413-003
Cg 125 M	125	01	24 614 0540	35330-413-003	Cb 450 S	450	88-89	24 614 0540	35330-413-003
Clr 125 Cityfly	125	98-00	24 614 0540	35330-413-003	Cmx 450 C Rebel	450	86	24 614 0540	35330-413-003
Clr 125 Cityfly 80 Km/H	125	98-00	24 614 0540	35330-413-003	Cmx 450 C Rebel	450	87	24 614 0540	35330-413-003
Cm 125 C Custom	125	82-83	24 614 0540	35330-413-003	Cb 500	500	96	24 614 0540	35330-413-003
Nsr 125 R	125	00	24 614 0540	35330-413-003	Cb 500	500	97	24 614 0540	35330-413-003
Nsr 125 R	125	98	24 614 0540	35330-413-003	Cb 500	500	98	24 614 0540	35330-413-003
Nsr 125 R	125	99	24 614 0540	35330-413-003	Cb 500	500	99	24 614 0540	35330-413-003
Nsr 125 R	125	01-03	24 614 0540	35330-413-003	Cb 500	500	02-03	24 614 0540	35330-413-003
Nsr 125 R 80 Km/H	125	00	24 614 0540	35330-413-003	Cb 500	500	00-01	24 614 0540	35330-413-003
Nsr 125 R 80 Km/H	125	97	24 614 0540	35330-413-003	Cb 500	500	94-95	24 614 0540	35330-413-003
Nsr 125 R 80 Km/H	125	98	24 614 0540	35330-413-003	Cb 500 S Sport	500	98	24 614 0540	35330-413-003
Nsr 125 R 80 Km/H	125	99	24 614 0540	35330-413-003	Cb 500 S Sport	500	99	24 614 0540	35330-413-003
Nsr 125 R 80 Km/H	125	01-03	24 614 0540	35330-413-003	Cb 500 S Sport	500	02-03	24 614 0540	35330-413-003
Nx 125 Transcity	125	89-94	24 614 0540	35330-413-003	Cb 500 S Sport	500	00-01	24 614 0540	35330-413-003
Nx 125 Transcity	125	95-96	24 614 0540	35330-413-003	Cbf 500	500	04-05	24 614 0540	35330-413-003
Nx 125 Transcity	125	97-98	24 614 0540	35330-413-003	Cbf 500	500	06-08	24 614 0540	35330-413-003
Vt 125 C Shadow	125	00	24 614 0540	35330-413-003	Cbf 500 A Abs	500	04-05	24 614 0540	35330-413-003
Vt 125 C Shadow	125	03	24 614 0540	35330-413-003	Cbf 500 A Abs	500	06-08	24 614 0540	35330-413-003
Vt 125 C Shadow	125	99	24 614 0540	35330-413-003	Cx 500	500	80	24 614 0540	35330-413-003
Vt 125 C Shadow	125	01-02	24 614 0540	35330-413-003	Cx 500	500	81	24 614 0540	35330-413-003
Vt 125 C Shadow	125	04-05	24 614 0540	35330-413-003	Cx 500	500	77-79	24 614 0540	35330-413-003
Vt 125 C Shadow	125	06-08	24 614 0540	35330-413-003	Cx 500	500	82-83	24 614 0540	35330-413-003
Vt 125 C Shadow 80 Km/H	125	00	24 614 0540	35330-413-003	Cx 500 C	500	80	24 614 0540	35330-413-003
Vt 125 C Shadow 80 Km/H	125	03	24 614 0540	35330-413-003	Cx 500 C	500	81	24 614 0540	35330-413-003
Vt 125 C Shadow 80 Km/H	125	99	24 614 0540	35330-413-003	Cx 500 C Custom	500	82-84	24 614 0540	35330-413-003
Vt 125 C Shadow 80 Km/H	125	01-02	24 614 0540	35330-413-003	Cx 500 E Eu Sports	500	82-86	24 614 0540	35330-413-003

INTERRUTTORI FRIZIONE

CLUTCH SWITCHES



Modello - Model	Cc	Anno Year	Codice RMS RMS Code	Rifer. Originale Oem Number	Modello - Model	Cc	Anno Year	Codice RMS RMS Code	Rifer. Originale Oem Number
Cx 500 Tc Turbo	500	82	24 614 0540	35330-413-003	Vt 600 C Shadow	600	97	24 614 0540	35330-413-003
Ft 500	500	82-83	24 614 0540	35330-413-003	Vt 600 C Shadow	600	98	24 614 0540	35330-413-003
Gb 500 Clubman	500	89	24 614 0540	35330-413-003	Vt 600 C Shadow	600	90-91	24 614 0540	35330-413-003
Gb 500 Clubman	500	90	24 614 0540	35330-413-003	Vt 600 C Shadow	600	99-00	24 614 0540	35330-413-003
Gl 500 D Silverwing	500	82-83	24 614 0540	35330-413-003	Vt C Shadow Sprocket Large Spline	600	88	24 614 0540	35330-413-003
Vt 500 C Shadow	500	83-84	24 614 0540	35330-413-003	Vt C Shadow Sprocket Narrow Spline	600	88	24 614 0540	35330-413-003
Vt 500 E	500	85	24 614 0540	35330-413-003	Cb 650	650	79-82	24 614 0540	35330-413-003
Vt 500 E	500	83-84	24 614 0540	35330-413-003	Cb 650	650	81-82	24 614 0540	35330-413-003
Xbr 500 Cast Wheel	500	85	24 614 0540	35330-413-003	Cb 650 C Custom	650	80	24 614 0540	35330-413-003
Xbr 500 Cast Wheel	500	86	24 614 0540	35330-413-003	Cb 650 C Custom	650	81	24 614 0540	35330-413-003
Xbr 500 Cast Wheel	500	87	24 614 0540	35330-413-003	Cb 650 Sc Custom	650	82-83	24 614 0540	35330-413-003
Xbr 500 S Spoked Wheel	500	87	24 614 0540	35330-413-003	Cx 650 C Custom	650	83	24 614 0540	35330-413-003
Xbr 500 S Spoked Wheel	500	88-89	24 614 0540	35330-413-003	Cx 650 E Euro	650	83	24 614 0540	35330-413-003
Cbx 550 F Supersport	550	82-84	24 614 0540	35330-413-003	Cx 650 T Turbo	650	83-85	24 614 0540	35330-413-003
Cbx 550 F2 Supersport	550	82-84	24 614 0540	35330-413-003	Gl 650 D Silverwing	650	83	24 614 0540	35330-413-003
Cb 600 F Hornet	600	00	24 614 0540	35330-413-003	Nt 650 Gt Hawk/Bros	650	88	24 614 0540	35330-413-003
Cb 600 F Hornet	600	01	24 614 0540	35330-413-003	Nt 650 Gt Hawk/Bros	650	89	24 614 0540	35330-413-003
Cb 600 F Hornet	600	02	24 614 0540	35330-413-003	Nt 650 Gt Hawk/Bros	650	90	24 614 0540	35330-413-003
Cb 600 F Hornet	600	03	24 614 0540	35330-413-003	Nt 650 V Deauville	650	00	24 614 0540	35330-413-003
Cb 600 F Hornet	600	04	24 614 0540	35330-413-003	Nt 650 V Deauville	650	01	24 614 0540	35330-413-003
Cb 600 F Hornet	600	05	24 614 0540	35330-413-003	Nt 650 V Deauville	650	98	24 614 0540	35330-413-003
Cb 600 F Hornet	600	06	24 614 0540	35330-413-003	Nt 650 V Deauville	650	99	24 614 0540	35330-413-003
Cb 600 F Hornet	600	98	24 614 0540	35330-413-003	Nt 650 V Deauville Cbs	650	02	24 614 0540	35330-413-003
Cb 600 F Hornet	600	99	24 614 0540	35330-413-003	Nt 650 V Deauville Cbs	650	03	24 614 0540	35330-413-003
Cb 600 S F2 Hornet S	600	00	24 614 0540	35330-413-003	Nt 650 V Deauville Cbs	650	04	24 614 0540	35330-413-003
Cb 600 S F2 Hornet S	600	01	24 614 0540	35330-413-003	Nt 650 V Deauville Cbs	650	05	24 614 0540	35330-413-003
Cb 600 S F2 Hornet S	600	02-03	24 614 0540	35330-413-003	Ntv 650 Revere	650	88	24 614 0540	35330-413-003
Cbf 600 N	600	04	24 614 0540	35330-413-003	Ntv 650 Revere	650	95	24 614 0540	35330-413-003
Cbf 600 N	600	05	24 614 0540	35330-413-003	Ntv 650 Revere	650	96	24 614 0540	35330-413-003
Cbf 600 N	600	06-07	24 614 0540	35330-413-003	Ntv 650 Revere	650	97	24 614 0540	35330-413-003
Cbf 600 Na Abs	600	04	24 614 0540	35330-413-003	Ntv 650 Revere	650	89-90	24 614 0540	35330-413-003
Cbf 600 Na Abs	600	05	24 614 0540	35330-413-003	Ntv 650 Revere	650	91-92	24 614 0540	35330-413-003
Cbf 600 Na Abs	600	06-07	24 614 0540	35330-413-003	Ntv 650 Revere	650	93-94	24 614 0540	35330-413-003
Cbf 600 S	600	04	24 614 0540	35330-413-003	Nt 700 V Deauville	700	06	24 614 0540	35330-413-003
Cbf 600 S	600	05	24 614 0540	35330-413-003	Nt 700 V Deauville	700	07	24 614 0540	35330-413-003
Cbf 600 S	600	06-07	24 614 0540	35330-413-003	Nt 700 V Deauville	700	10	24 614 0540	35330-413-003
Cbf 600 Sa Abs	600	04	24 614 0540	35330-413-003	Nt 700 V Deauville	700	11-13	24 614 0540	35330-413-003
Cbf 600 Sa Abs	600	05	24 614 0540	35330-413-003	Nt 700 V Deauville	700	08-09	24 614 0540	35330-413-003
Cbf 600 Sa Abs	600	06-07	24 614 0540	35330-413-003	Nt 700 Va Deauville Abs	700	06	24 614 0540	35330-413-003
Cbr 600 F	600	00	24 614 0540	35330-413-003	Nt 700 Va Deauville Abs	700	07	24 614 0540	35330-413-003
Cbr 600 F	600	01	24 614 0540	35330-413-003	Nt 700 Va Deauville Abs	700	10	24 614 0540	35330-413-003
Cbr 600 F	600	02	24 614 0540	35330-413-003	Nt 700 Va Deauville Abs	700	11-16	24 614 0540	35330-413-003
Cbr 600 F	600	03	24 614 0540	35330-413-003	Nt 700 Va Deauville Abs	700	08-09	24 614 0540	35330-413-003
Cbr 600 F	600	04	24 614 0540	35330-413-003	Cb 750 C Custom	750	81-83	24 614 0540	35330-413-003
Cbr 600 F	600	05	24 614 0540	35330-413-003	Cb 750 F	750	80	24 614 0540	35330-413-003
Cbr 600 F	600	07	24 614 0540	35330-413-003	Cb 750 F	750	81	24 614 0540	35330-413-003
Cbr 600 F	600	08	24 614 0540	35330-413-003	Cb 750 F	750	82	24 614 0540	35330-413-003
Cbr 600 F	600	09	24 614 0540	35330-413-003	Cb 750 F2	750	82	24 614 0540	35330-413-003
Cbr 600 F	600	90	24 614 0540	35330-413-003	Cb 750 F2 Seven Fifty	750	94	24 614 0540	35330-413-003
Cbr 600 F	600	91	24 614 0540	35330-413-003	Cb 750 F2 Seven Fifty	750	95	24 614 0540	35330-413-003
Cbr 600 F	600	92	24 614 0540	35330-413-003	Cb 750 F2 Seven Fifty	750	96	24 614 0540	35330-413-003
Cbr 600 F	600	93	24 614 0540	35330-413-003	Cb 750 F2 Seven Fifty	750	97	24 614 0540	35330-413-003
Cbr 600 F	600	94	24 614 0540	35330-413-003	Cb 750 F2 Seven Fifty	750	98	24 614 0540	35330-413-003
Cbr 600 F	600	95	24 614 0540	35330-413-003	Cb 750 F2 Seven Fifty	750	01-03	24 614 0540	35330-413-003
Cbr 600 F	600	96	24 614 0540	35330-413-003	Cb 750 F2 Seven Fifty	750	92-93	24 614 0540	35330-413-003
Cbr 600 F	600	97	24 614 0540	35330-413-003	Cb 750 F2 Seven Fifty	750	99-00	24 614 0540	35330-413-003
Cbr 600 F	600	98	24 614 0540	35330-413-003	Cb 750 K	750	80	24 614 0540	35330-413-003
Cbr 600 F	600	99	24 614 0540	35330-413-003	Cb 750 K	750	78-79	24 614 0540	35330-413-003
Cbr 600 F	600	06-07	24 614 0540	35330-413-003	Cb 750 K	750	81-82	24 614 0540	35330-413-003
Cbr 600 Fr Rossi	600	01	24 614 0540	35330-413-003	Cb 750 Nighthawk	750	91	24 614 0540	35330-413-003
Cbr 600 Fr Rossi	600	02	24 614 0540	35330-413-003	Cb 750 Nighthawk	750	92	24 614 0540	35330-413-003
Cbr 600 Fs Sport	600	01	24 614 0540	35330-413-003	Vf 750 C Magna	750	93	24 614 0540	35330-413-003
Cbr 600 Fs Sport	600	02	24 614 0540	35330-413-003	Vf 750 C Magna	750	94	24 614 0540	35330-413-003
Vt 600 C Shadow	600	89	24 614 0540	35330-413-003	Vf 750 C Magna	750	95	24 614 0540	35330-413-003
Vt 600 C Shadow	600	92	24 614 0540	35330-413-003	Vf 750 C Magna	750	96	24 614 0540	35330-413-003
Vt 600 C Shadow	600	93	24 614 0540	35330-413-003	Vf 750 C Magna	750	97-98	24 614 0540	35330-413-003
Vt 600 C Shadow	600	94	24 614 0540	35330-413-003	Vf 750 C Magna	750	99-00	24 614 0540	35330-413-003
Vt 600 C Shadow	600	95	24 614 0540	35330-413-003	Vt 750 C Shadow	750	00	24 614 0540	35330-413-003
Vt 600 C Shadow	600	96	24 614 0540	35330-413-003	Vt 750 C Shadow	750	04	24 614 0540	35330-413-003



INTERRUTTORI FRIZIONE

CLUTCH SWITCHES

Modello - Model	Cc	Anno Year	Codice RMS RMS Code	Rifer. Originale Oem Number
Vt 750 C Shadow	750	05	24 614 0540	35330-413-003
Vt 750 C Shadow	750	06	24 614 0540	35330-413-003
Vt 750 C Shadow	750	07	24 614 0540	35330-413-003
Vt 750 C Shadow	750	08	24 614 0540	35330-413-003
Vt 750 C Shadow	750	09	24 614 0540	35330-413-003
Vt 750 C Shadow	750	97	24 614 0540	35330-413-003
Vt 750 C Shadow	750	98	24 614 0540	35330-413-003
Vt 750 C Shadow	750	99	24 614 0540	35330-413-003
Vt 750 C2 Shadow Aero	750	00	24 614 0540	35330-413-003
Vt 750 C2 Shadow Aero	750	97	24 614 0540	35330-413-003
Vt 750 C2 Shadow Aero	750	98	24 614 0540	35330-413-003
Vt 750 C2 Shadow Aero	750	99	24 614 0540	35330-413-003
Vt 750 C2 Shadow Aero	750	01-02	24 614 0540	35330-413-003
Vt 750 C2 Shadow Spirit	750	07	24 614 0540	35330-413-003
Vt 750 C2 Shadow Spirit	750	08-09	24 614 0540	35330-413-003
Vt 750 C2b Shadow Black Spirit	750	10	24 614 0540	35330-413-003
Vt 750 C2b Shadow Black Spirit	750	11	24 614 0540	35330-413-003
Vt 750 C2b Shadow Black Spirit	750	12-13	24 614 0540	35330-413-003
Vt 750 C2b Shadow Black Spirit	750	14-16	24 614 0540	35330-413-003
Vt 750 C2s Shadow Abs	750	10	24 614 0540	35330-413-003
Vt 750 C2s Shadow Abs	750	13	24 614 0540	35330-413-003
Vt 750 C2s Shadow Abs	750	11-12	24 614 0540	35330-413-003
Vt 750 C2s Shadow Abs	750	14-15	24 614 0540	35330-413-003
Vt 750 Ca Shadow	750	06	24 614 0540	35330-413-003
Vt 750 Ca Shadow	750	07	24 614 0540	35330-413-003
Vt 750 Ca Shadow	750	08	24 614 0540	35330-413-003
Vt 750 Ca Shadow	750	09	24 614 0540	35330-413-003
Vt 750 Dc Black Widow	750	02-03	24 614 0540	35330-413-003
Vt 750 Dc Black Widow	750	00-01	24 614 0540	35330-413-003
Vt 750 S	750	10	24 614 0540	35330-413-003
Vt 750 S	750	14	24 614 0540	35330-413-003
Vt 750 S	750	11-13	24 614 0540	35330-413-003
Xlv 750 R	750	83-85	24 614 0540	35330-413-003
Cb 900 F Bol D'or	900	79	24 614 0540	35330-413-003
Cb 900 F Bol D'or	900	80	24 614 0540	35330-413-003
Cb 900 F Bol D'or	900	81	24 614 0540	35330-413-003
Cb 900 F Bol D'or	900	82	24 614 0540	35330-413-003
Cb 900 F Bol D'or	900	83	24 614 0540	35330-413-003
Cb 900 F Hornet	900	02	24 614 0540	35330-413-003
Cb 900 F Hornet	900	03	24 614 0540	35330-413-003
Cb 900 F Hornet	900	04	24 614 0540	35330-413-003
Cb 900 F Hornet	900	05-06	24 614 0540	35330-413-003
Cb 900 F2 Bol D'or	900	81	24 614 0540	35330-413-003
Cb 900 F2 Bol D'or	900	82	24 614 0540	35330-413-003
Cb 900 F2 Bol D'or	900	83	24 614 0540	35330-413-003
Cbr 900 Rr Fireblade	900	00	24 614 0540	35330-413-003
Cbr 900 Rr Fireblade	900	01	24 614 0540	35330-413-003
Cbr 900 Rr Fireblade	900	92	24 614 0540	35330-413-003
Cbr 900 Rr Fireblade	900	93	24 614 0540	35330-413-003
Cbr 900 Rr Fireblade	900	94	24 614 0540	35330-413-003
Cbr 900 Rr Fireblade	900	95	24 614 0540	35330-413-003
Cbr 900 Rr Fireblade	900	96	24 614 0540	35330-413-003
Cbr 900 Rr Fireblade	900	97	24 614 0540	35330-413-003
Cbr 900 Rr Fireblade	900	98	24 614 0540	35330-413-003
Cbr 900 Rr Fireblade	900	99	24 614 0540	35330-413-003
Cbx 1000	1000	79	24 614 0540	35330-413-003
Cbx 1000	1000	80	24 614 0540	35330-413-003
Cbx 1000 Pro Link	1000	81	24 614 0540	35330-413-003
Cbx 1000 Pro Link	1000	82-83	24 614 0540	35330-413-003
Gl 1000 K Goldwing	1000	78	24 614 0540	35330-413-003
Gl 1000 Z Goldwing	1000	79	24 614 0540	35330-413-003
Cb 1100 F Bol D'or	1100	83-84	24 614 0540	35330-413-003
Cb 1100 R	1100	81	24 614 0540	35330-413-003
Cb 1100 R	1100	82	24 614 0540	35330-413-003
Cb 1100 R	1100	83	24 614 0540	35330-413-003
Cb 1100 Sf X-11	1100	00	24 614 0540	35330-413-003
Cb 1100 Sf X-11	1100	01-03	24 614 0540	35330-413-003
Gl 1100 D Goldwing Fairing	1100	80	24 614 0540	35330-413-003
Gl 1100 D Goldwing Fairing	1100	81	24 614 0540	35330-413-003

Modello - Model	Cc	Anno Year	Codice RMS RMS Code	Rifer. Originale Oem Number
Gl 1100 D Goldwing Fairing	1100	82-83	24 614 0540	35330-413-003
Gl 1100 Goldwing	1100	80	24 614 0540	35330-413-003
Gl 1100 Goldwing	1100	81	24 614 0540	35330-413-003
Gl 1100 Goldwing	1100	82-83	24 614 0540	35330-413-003
Vt 1100 C2 Shadow Ace	1100	95	24 614 0540	35330-413-003
Vt 1100 C2 Shadow Ace	1100	96	24 614 0540	35330-413-003
Vt 1100 C2 Shadow Ace	1100	97	24 614 0540	35330-413-003
Vt 1100 C2 Shadow Ace	1100	98	24 614 0540	35330-413-003
Vt 1100 C2 Shadow Ace	1100	99-00	24 614 0540	35330-413-003
Vt 1100 C3 Shadow Aero	1100	98	24 614 0540	35330-413-003
Vt 1100 C3 Shadow Aero	1100	99-00	24 614 0540	35330-413-003
Vt 1300 Cx	1300	10-16	24 614 0540	35330-413-003
Vt 1300 Cxa Abs	1300	10-12	24 614 0540	35330-413-003
Vt 1300 Cxa Abs	1300	13-15	24 614 0540	35330-413-003
Vtx 1300 S	1300	03	24 614 0540	35330-413-003
Vtx 1300 S	1300	04	24 614 0540	35330-413-003
Vtx 1300 S	1300	05	24 614 0540	35330-413-003
Vtx 1300 S	1300	06	24 614 0540	35330-413-003
Vtx 1300 S	1300	07	24 614 0540	35330-413-003

KAWASAKI

Gpx R F1-F3	750	87-89	24 614 0600	270101171
Ninja Zx-7R P1-P4	750	96-99	24 614 0600	270101171
Ninja Zx-7R P5-P7	750	00-02	24 614 0600	270101406
Ninja Zx-7Rr N1	750	96-98	24 614 0600	270101171
Zxr H1 Stinger	750	89	24 614 0600	270101171
Zxr H2 Stinger	750	90	24 614 0600	270101171
Zxr J1-J2	750	91-92	24 614 0600	270101171
Zxr L1-L3	750	93-95	24 614 0600	270101171
Zxr R K1	750	91	24 614 0600	270101171
Zxr R M1-M2	750	93-94	24 614 0600	270101171
Ninja Zx-9R B1-B3	900	94-96	24 614 0600	270101171
Ninja Zx-9R B4	900	97	24 614 0600	270101171
Gpz Rx A1-A3	1000	86-88	24 614 0600	270101171
Gtr A11	1000	96-97	24 614 0600	270101171
Gtr A18	1000	03	24 614 0600	270101406
Zx 10 B1-B3	1000	88-90	24 614 0600	270101171
Gpz E1-E2	1100	95-97	24 614 0600	270101171
Zr Zephyr A1-A4	1100	92-95	24 614 0600	270101171
Zrx D1-D3	1100	97-99	24 614 0600	270101171
Zzr C1-C2	1100	90-91	24 614 0600	270101171
Zzr C3	1100	92	24 614 0600	270101171
Zzr D1-D2	1100	93-94	24 614 0600	270101171
Zzr D3-D4	1100	95-96	24 614 0600	270101171
Zzr D5-D6	1100	97-98	24 614 0600	270101171
Zzr D7	1100	99	24 614 0600	270101171
Zrx C1p-C2p	1200	01-03	24 614 0600	270101406
Zrx C3h	1200	04	24 614 0600	270101406
Zrx R A1p-A3p	1200	01-03	24 614 0600	270101406
Zrx R A4h-A5h	1200	04-05	24 614 0600	270101406
Zrx R A6f	1200	06	24 614 0600	270101406
Zrx S B1p-B3p	1200	01-03	24 614 0600	270101406
Zrx S B4h	1200	04	24 614 0600	270101406
Zzr C1h-C2h	1200	02-03	24 614 0600	270101406
Zzr C4h	1200	05	24 614 0600	270101406
Vn Classic D1-D2	1500	96-97	24 614 0600	270101171
Vn Classic E1	1500	98	24 614 0600	270101171
Vn Classic E2	1500	99	24 614 0600	270101171
Vn Classic Fi N1h-N3h	1500	00-02	24 614 0600	270101406
Vn Classic Tourer Fi L2h-L4h	1500	01-03	24 614 0600	270101406
Vn Classic Tourer G1-G2	1500	98-99	24 614 0600	270101171
Vn Classic Tourer L1h	1500	00	24 614 0600	270101406
Vn Drifter J1	1500	99-00	24 614 0600	270101406
Vn Main Streak P1h-P2h	1500	02-03	24 614 0600	270101406
Vn Classic A1h-A3h	1600	03-05	24 614 0600	270101406
Vn Classic A6f	1600	06	24 614 0600	270101406
Vn Classic Tourer D1h	1600	05	24 614 0600	270101406
Vn Classic Tourer D6f	1600	06	24 614 0600	270101406
Vn Mean Streak B1h-B2h	1600	04-05	24 614 0600	270101406
Vn Mean Streak B6f-B7f	1600	06-07	24 614 0600	270101406

INTERRUTTORI FRIZIONE

CLUTCH SWITCHES



Modello - Model	Cc	Anno Year	Codice RMS RMS Code	Rifer. Originale Oem Number	Modello - Model	Cc	Anno Year	Codice RMS RMS Code	Rifer. Originale Oem Number
SUZUKI					Yzf R 125 A	125	15-17	24 614 0710	3YX82917100
Gs500 K1-K2	500	01-02	24 614 0660	37560-38A00-000	Mws150-A Tricity	150	16	24 614 0720	36Y829170000
Gs500 K3-K6	500	03-06	24 614 0660	37560-38A00-000	Yp400 Majesty	400	06	24 614 0720	36Y829170000
Gsf600 Bandit S-W	600	95-98	24 614 0660	37560-38A00-000	Yp400 Majesty	400	04-05	24 614 0720	36Y829170000
Gsx600f K4-K6	600	04-06	24 614 0660	37560-38A00-000	Yp400 Majesty	400	07-08	24 614 0720	36Y829170000
Gsx600f W-K3	600	98-03	24 614 0660	37560-38A00-000	Yp400 Majesty	400	09-11	24 614 0720	36Y829170000
Vs600gl Intruder S-V	600	95-97	24 614 0660	37560-38A00-000	Yp400 Majesty Abs	400	07	24 614 0720	36Y829170000
Gsf Bandit K7-K8	650	07-08	24 614 0670	57560-02FA0-000	Yp400 Majesty Abs	400	08	24 614 0720	36Y829170000
Gsf Bandit K9-L0	650	09-10	24 614 0670	57560-02FA0-000	Yp400 Majesty Abs	400	09-11	24 614 0720	36Y829170000
Gsf Bandit L1	650	11	24 614 0670	57560-02FA0-000	Xp T-Max	500	06	24 614 0720	36Y829170000
Gsf Bandit L2	650	12	24 614 0670	57560-02FA0-000	Xp T-Max	500	07	24 614 0720	36Y829170000
Gsx F K8-L0	650	08-10	24 614 0670	57560-02FA0-000	Xp T-Max	500	08	24 614 0720	36Y829170000
Gsx F L1	650	11	24 614 0670	57560-02FA0-000	Xp T-Max	500	01-03	24 614 0720	36Y829170000
Gsx F L2	650	12	24 614 0670	57560-02FA0-000	Xp T-Max	500	04-05	24 614 0720	36Y829170000
Sv650 X-K2	650	99-02	24 614 0660	37560-38A00-000	Xp T-Max	500	09-11	24 614 0720	36Y829170000
Gsx750 W-K1	750	98-01	24 614 0660	37560-38A00-000	Xp T-Max Abs	500	05	24 614 0720	36Y829170000
Gsx750f K4-K6	750	04-06	24 614 0660	37560-38A00-000	Xp T-Max Abs	500	06	24 614 0720	36Y829170000
Gsx750f W-K3	750	98-03	24 614 0660	37560-38A00-000	Xp T-Max Abs	500	07	24 614 0720	36Y829170000
Dl1000 V-Strom	1000	14	24 614 0670	57560-02FA0-000	Xp T-Max Abs	500	08-11	24 614 0720	36Y829170000
Dl1000 V-Strom K2-K6	1000	02-06	24 614 0670	57560-02FA0-000	Xp T-Max Abs Sv	500	10-11	24 614 0720	36Y829170000
Dl1000 V-Strom K7-L0	1000	07-10	24 614 0670	57560-02FA0-000	Xp T-Max Black Max	500	06	24 614 0720	36Y829170000
Dl1000 V-Strom L5	1000	15	24 614 0670	57560-02FA0-000	Xp T-Max Black Max-Night Max	500	07	24 614 0720	36Y829170000
Dl1000 V-Strom L6	1000	16	24 614 0670	57560-02FA0-000	Xp T-Max White Max	500	10	24 614 0720	36Y829170000
Dl1000(X)A V-Strom L8	1000	18	24 614 0670	57560-02FA0-000	Xp T-Max	530	12	24 614 0720	36Y829170000
Gsx-R1000 K7-K8	1000	07-08	24 614 0670	57560-02FA0-000	Xp T-Max	530	13-14	24 614 0720	36Y829170000
Sv1000 K6-K7	1000	06-07	24 614 0670	57560-02FA0-000	Xp T-Max	530	15-16	24 614 0720	36Y829170000
Sv1000k3-K5	1000	03-05	24 614 0670	57560-02FA0-000	Xp T-Max Abs	530	12	24 614 0720	36Y829170000
Tl1000r W-Y	1000	98-00	24 614 0670	57560-02FA0-000	Xp T-Max Abs	530	13-14	24 614 0720	36Y829170000
Gsf Bandit K1-K5	1200	01-05	24 614 0670	57560-02FA0-000	Xp T-Max Abs	530	15-16	24 614 0720	36Y829170000
Gsf Bandit K6	1200	06	24 614 0670	57560-02FA0-000	Xp T-Max Sp	530	15	24 614 0720	36Y829170000
Gsf Bandit T-Y	1200	96-00	24 614 0660	37560-38A00-000	Xp T-Max Sp Abs	530	15-16	24 614 0720	36Y829170000
Gsx1200 X-K1	1200	99-01	24 614 0660	37560-38A00-000	Xp530-A T-Max Sx	530	17	24 614 0720	36Y829170000
Gsf1250 Bandit K7-L0	1250	07-10	24 614 0670	57560-02FA0-000	Xp530e-A T-Max	530	17	24 614 0720	36Y829170000
Gsf1250 Bandit L0	1250	10	24 614 0670	57560-02FA0-000	Fz6 Fazer	600	04-08	24 614 0710	3YX82917100
Gsf1250 Bandit L1	1250	11	24 614 0670	57560-02FA0-000	Fz6	600	04-08	24 614 0710	3YX82917100
Gsf1250s Bandit L1	1250	11	24 614 0670	57560-02FA0-000	Fzs Fazer	600	98-03	24 614 0710	3YX82917100
Gsf1250s Bandit L2	1250	12	24 614 0670	57560-02FA0-000	Xj N	600	95-01	24 614 0710	3YX82917100
Gsf1250sa Bandit L5-L6	1250	15-16	24 614 0670	57560-02FA0-000	Xj S Diversion	600	92-02	24 614 0710	3YX82917100
Gsx1250fa L0	1250	10	24 614 0670	57560-02FA0-000	Xj6 F / Fa / N / S	600	09-15	24 614 0710	3YX82917100
Gsx1250fa L1	1250	11	24 614 0670	57560-02FA0-000	Xbs Drag Star / Classic	650	97-06	24 614 0710	3YX82917100
Gsx1250fa L2	1250	12	24 614 0670	57560-02FA0-000	Mt-03	660	06-12	24 614 0710	3YX82917100
Gsx1250fa L6	1250	16	24 614 0670	57560-02FA0-000	Xt660 Z Tenerè	660	10-15	24 614 0710	3YX82917100
Gsx1300ra Hayabusa L6	1300	16	24 614 0670	57560-02FA0-000	Mt-07	700	14-16	24 614 0710	3YX82917100
Gsx1300ra Hayabusa L7	1300	17	24 614 0670	57560-02FA0-000	Fz	750	86	24 614 0720	36Y829170000
Gsx1300raz Hayabusa L4	1300	14	24 614 0670	57560-02FA0-000	Fz	750	87	24 614 0720	36Y829170000
Gsz1300r Hayabusa K4-K7	1300	04-07	24 614 0670	57560-02FA0-000	Fz	750	90	24 614 0720	36Y829170000
Gsz1300r Hayabusa K8-L0	1300	08-10	24 614 0670	57560-02FA0-000	Fzx	750	88	24 614 0720	36Y829170000
Gsz1300r Hayabusa L1	1300	11	24 614 0670	57560-02FA0-000	Fz8 N / S	800	11-15	24 614 0710	3YX82917100
Gsz1300r Hayabusa L2	1300	12	24 614 0670	57560-02FA0-000	Mt-09 Abs / Tracer	850	14-17	24 614 0710	3YX82917100
Gsz1300r Hayabusa X-K3	1300	99-03	24 614 0670	57560-02FA0-000	Tdm	850	91-99	24 614 0710	3YX82917100
Gsz1300ra Hayabusa L3	1300	13	24 614 0670	57560-02FA0-000	Tdm	900	02-10	24 614 0710	3YX82917100
Gsx K2-K5	1400	02-05	24 614 0670	57560-02FA0-000	Xv950	950	14	24 614 0720	36Y829170000
Gsx K6-K7	1400	06-07	24 614 0670	57560-02FA0-000	Xv950cu	950	14-16	24 614 0720	36Y829170000
Vs1400gl Intruder H-S	1400	87-95	24 614 0660	37560-38A00-000	Xv950r	950	17	24 614 0720	36Y829170000
Vs1400glp Intruder T-W	1400	96-98	24 614 0660	37560-38A00-000	Xv950r	950	14-16	24 614 0720	36Y829170000
YAMAHA					Fzr	1000	87-88	24 614 0720	36Y829170000
Tzr	50	03-12	24 614 0710	3YX82917100	Fj	1200	86	24 614 0720	36Y829170000
Tzr RR	50	05	24 614 0710	3YX82917100	Fj	1200	87	24 614 0720	36Y829170000
Yn F Neo's 4	50	12-15	24 614 0720	36Y829170000	Fj	1200	90	24 614 0720	36Y829170000
Yn F Neo's 4	50	11-12	24 614 0720	36Y829170000	Fj	1200	91	24 614 0720	36Y829170000
Yn Neo's Easy	50	13	24 614 0720	36Y829170000	Fj	1200	88-89	24 614 0720	36Y829170000
Mt 125	125	15-16	24 614 0710	3YX82917100	V-Max	1200	01	24 614 0720	36Y829170000
Mt 125 A	125	15-17	24 614 0710	3YX82917100	V-Max	1200	86-89	24 614 0720	36Y829170000
Mw125 Tricity	125	14	24 614 0720	36Y829170000	V-Max	1200	90-91	24 614 0720	36Y829170000
Mws125-A Tricity	125	17	24 614 0720	36Y829170000	V-Max	1200	92-93	24 614 0720	36Y829170000
Mws125-C Tricity	125	17	24 614 0720	36Y829170000	V-Max	1200	96-97	24 614 0720	36Y829170000
Wr 125 R	125	09-11	24 614 0710	3YX82917100	V-Max	1200	99-00	24 614 0720	36Y829170000
Wr 125 X	125	09-14	24 614 0710	3YX82917100	Xvs1300a Midnight Star	1300	11-16	24 614 0720	36Y829170000
Yzf R 125	125	08-16	24 614 0710	3YX82917100					



INTERRUTTORI STOP
BRAKE LIGHT SWITCHES

24 614 0030



INTERRUTTORE LUCE STOP
BRAKE LIGHT SWITCH

MBK - YAMAHA

(R.O. 5SEH253N0100 - NM5839801000)



24 614 0040



INTERRUTTORE LUCE STOP (senza cavi)
BRAKE LIGHT SWITCH (no cables)

MBK - YAMAHA

(R.O. 5ADH39800100 - 5XLH39800000)



24 614 0050



INTERRUTTORE LUCE STOP
BRAKE LIGHT SWITCH

MALAGUTI

(R.O. 01714000)



24 614 0070



INTERRUTTORE LUCE STOP
BRAKE LIGHT SWITCH

PIAGGIO

(R.O. 055316)



24 614 0080



INTERRUTTORE LUCE STOP (pulsante nero)
BRAKE LIGHT SWITCH (black button)

PIAGGIO

(R.O. 181878)



24 614 0090



INTERRUTTORE LUCE STOP (pulsante rosso)
BRAKE LIGHT SWITCH (red button)

PIAGGIO

(R.O. 181881)



24 614 0100



INTERRUTTORE STOP - STOP SWITCH

Interuttore Stop contatto a pulsante aperto

Normally open stop switch

(Applicazione Varie-Variou applications)

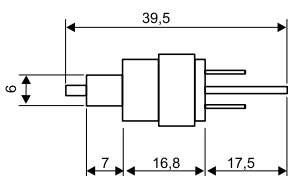

24 614 0110



INTERRUTTORE LUCE STOP
BRAKE LIGHT SWITCH

PIAGGIO

(R.O. 181637)



24 614 0130



INTERRUTTORE LUCE STOP (13 mm)
BRAKE LIGHT SWITCH (13 mm)

APRILIA

(R.O. 642032 - 580953)

DERBI

(R.O. 580723 - AP8127305)

GILERA

(R.O. 580645 - 580953 - 642032)

PIAGGIO

(R.O. 580953)



INTERRUTTORI STOP BRAKE LIGHT SWITCHES



24 614 0140 

INTERRUTTORE LUCE STOP UNIVERSALE
(a tirare)
STOP SWITCH (pull)
Modelli Vespa fino al 1957
Vespa Models untill 1957
(R.O. 610200M)



24 614 0150 

INTERRUTTORE LUCE STOP UNIVERSALE
(a lasciare)
STOP SWITCH (release)
Modelli Vespa fino al 1957
Vespa Models untill 1957
(R.O. 610201M)



24 614 0161  **NEW**

PIAGGIO - GILERA
50-100-125-150-200-250-300-400-500
(R.O. 583575)



24 614 0520  **NEW**

INTERRUTTORE POSTERIORE LUCE STOP
BRAKE LIGHT REAR SWITCH
HONDA
(R.O. 35350-292-003)



24 614 0530  **NEW**

INTERRUTTORE ANTERIORE LUCE STOP
BRAKE LIGHT FRONT SWITCH
HONDA
(R.O. 35340-MM5-600)



24 614 0550  **NEW**

INTERRUTTORE POSTERIORE LUCE STOP
BRAKE LIGHT REAR SWITCH
HONDA
(R.O. 35340-GS7-023)



24 614 0560  **NEW**

INTERRUTTORE ANTERIORE LUCE STOP
BRAKE LIGHT FRONT SWITCH
HONDA
(R.O. 35340-329-003)



24 614 0570  **NEW**

INTERRUTTORE ANTERIORE LUCE STOP
BRAKE LIGHT FRONT SWITCH
KAWASAKI
(R.O. 270101056)



24 614 0580  **NEW**

INTERRUTTORE POSTERIORE LUCE STOP
BRAKE LIGHT REAR SWITCH
KAWASAKI
(R.O. 270101019)





INTERRUTTORI STOP BRAKE LIGHT SWITCHES

24 614 0610



NEW

INTERRUTTORE ANTERIORE LUCE STOP
BRAKE LIGHT FRONT SWITCH
KAWASAKI (R.O. 270101170 - 270100025)
SUZUKI (R.O. 57460-14J01-000)
TRIUMPH: Modelli con Pompa freno non radiale • *Not radial master cylinder models*



24 614 0620



NEW

INTERRUTTORE POSTERIORE LUCE STOP
"LUCAS"
BRAKE LIGHT REAR SWITCH "LUCAS"
TRIUMPH - BSA (LUCAS TYPE)



24 614 0630



NEW

INTERRUTTORE POSTERIORE LUCE STOP
IN METALLO
BRAKE LIGHT METAL REAR SWITCH
PEUGEOT
(R.O. 743154)



24 614 0640



NEW

INTERRUTTORE POSTERIORE LUCE STOP
IN PLASTICA
BRAKE LIGHT PLASTIC REAR SWITCH
PEUGEOT
(R.O. 743154)



24 614 0650



NEW

INTERRUTTORE ANTERIORE LUCE STOP
BRAKE LIGHT FRONT SWITCH
SUZUKI (R.O. 57460-17J01-000)



24 614 0680



NEW

INTERRUTTORE POSTERIORE LUCE STOP
BRAKE LIGHT REAR SWITCH
YAMAHA
(R.O. J5825030100)



24 614 0690



NEW

INTERRUTTORE ANTERIORE LUCE STOP
BRAKE LIGHT FRONT SWITCH
YAMAHA
(R.O. 3YF839800000 - 34X839800100 - 2U2839803000)



24 614 0700



NEW

INTERRUTTORE ANTERIORE LUCE STOP
BRAKE LIGHT FRONT SWITCH
YAMAHA
(R.O. 26H839800000 - 1A0839803000)



INTERRUTTORI STOP

BRAKE LIGHT SWITCHES



Modello - Model	Cc	Anno Year	Codice RMS RMS Code	Rifer. Originale Oem Number	Modello - Model	Cc	Anno Year	Codice RMS RMS Code	Rifer. Originale Oem Number
APRILIA					Stalker	50	09-11	24 614 0130	580953
Rs4	50	11-13	24 614 0130	642032	Stalker	50	97-04	24 614 0130	580953
Scarabeo 2T	50	14	24 614 0130	642032	Stalker Special Edition	50	07-08	24 614 0130	580953
Scarabeo 4T 4V	50	14	24 614 0130	642032	Storm	50	94-95	24 614 0130	580953
Sr Iniezione E Carburatore	50	14	24 614 0130	642032	Storm Eu2	50	07	24 614 0130	580953
Scarabeo 4T	100	14	24 614 0130	642032	Typhoon	50	94-97	24 614 0130	580953
Scarabeo 4T Net	100	09	24 614 0130	580953	Typhoon X	50	98-99	24 614 0130	580953
Atlantic Eu3	125	10-12	24 614 0130	580953	Typhoon Xr	50	00	24 614 0130	580953
Rs Abs	125	17	24 614 0130	642032	Zulu	50	01	24 614 0130	580953
Rs Replica Abs	125	17	24 614 0130	642032	Dna 125-180	125	01	24 614 0130	580953
Rs4	125	11-13	24 614 0130	642032	Nexus Eu3	125	07-08	24 614 0130	642032
Rs4 Replica	125	14-16	24 614 0130	642032	Nexus Eu3	125	07-08	24 614 0161	583575
Scarabeo le Light 125-200	125	11-12	24 614 0130	642032	Nexus Eu3 le	125	08	24 614 0130	642032
Sport City Cube	125	08-10	24 614 0130	580953	Nexus Eu3 le	125	09-10	24 614 0130	642032
Sport City Street	125	12	24 614 0130	642032	Runner 4T St Eu3	125	08-16	24 614 0161	583575
Tuono Abs	125	17	24 614 0130	642032	Runner Fx-Fxr 125	125	97-02	24 614 0130	580953
Sport City Cube	250	08-12	24 614 0130	580953	Runner Vx	125	05-06	24 614 0161	583575
Atlantic	300	10-11	24 614 0130	580953	Runner Vx 4T Eu3	125	06-07	24 614 0161	583575
Sport City Street	300	12	24 614 0130	642032	Runner Vx Race	125	06	24 614 0161	583575
Sr Max	300	11-14	24 614 0130	642032	Runner Vx Sc	125	06-07	24 614 0161	583575
Shiver	750	10-13	24 614 0130	642032	Runner Vx-Vxr 125	125	02-04	24 614 0130	580953
Shiver	750	14-16	24 614 0130	642032	Runner Vx-Vxr 125	125	00-01	24 614 0130	580953
Srv - Srv Abs Atc	850	12-14	24 614 0130	642032	Typhoon	125	95-98	24 614 0130	580953
Dorsoduro	900	17	24 614 0130	642032	Typhoon X-Xr	125	99-00	24 614 0130	580953
Shiver	900	17	24 614 0130	642032	Runner Fx-Fxr 180	180	97-02	24 614 0130	580953
DERBI					Runner Vx-Vxr 180	180	00-01	24 614 0130	580953
Boulevard 2T	50	09-14	24 614 0161	583575	Runner Vxr	200	05-06	24 614 0161	583575
Boulevard 4T Eu2 25 Km/H	50	09	24 614 0161	583575	Runner Vxr 4T St Eu3	200	08-11	24 614 0161	583575
Sonar 2T	50	09	24 614 0161	583575	Runner Vxr Eu3	200	07	24 614 0161	583575
Variant Sport 2T	50	12	24 614 0130	580723	Runner Vxr Race	200	05-06	24 614 0161	583575
Boulevard 4T	100	10-11	24 614 0161	583575	Runner Vx-Vxr 200	200	02-04	24 614 0130	580953
Boulevard 4T Eu3	125	08-12	24 614 0161	583575	Nexus Eu3	250	06	24 614 0161	583575
Gp1 Low Seat 125 Eu3	125	07-08	24 614 0130	AP8127305	Nexus Eu3	250	07	24 614 0161	583575
Rambla 125	125	08-09	24 614 0130	AP8127305	Nexus Sp Eu3	250	06-07	24 614 0161	583575
Rambla 125 E3 2Ver	125	08	24 614 0130	AP8127305	Nexus Eu3	300	08	24 614 0161	583575
Sonar 4T	125	09-11	24 614 0161	583575	Nexus Eu3	300	09-11	24 614 0130	642032
Variant Sport 4T E3	125	12	24 614 0130	580723	Fuoco 4T-4V le E3 Lt	500	13-14	24 614 0161	583575
Boulevard 4T E3	150	10	24 614 0161	583575	Fuoco Eu3	500	07-13	24 614 0161	583575
Sonar 4T	150	09	24 614 0161	583575	Nexus	500	03-05	24 614 0161	583575
Gp1 Low Seat 250 Eu3	250	07-08	24 614 0130	AP8127305	Nexus Eu3	500	06-08	24 614 0161	583575
Rambla 250	250	08-09	24 614 0130	AP8127305	Nexus Eu3	500	09-11	24 614 0130	642032
Rambla 250 E3 2Ver	250	08	24 614 0130	AP8127305	Nexus Sp Eu3	500	06-07	24 614 0161	583575
Rambla	300	10-11	24 614 0130	AP8127305	R	600	91-92	24 614 0130	580953
GILERA					Rc	600	89-90	24 614 0130	580953
Dna	50	05-07	24 614 0130	580645	Rc Cobra	600	91-93	24 614 0130	580953
Dna	50	00-02	24 614 0130	580953	Gp	800	09-11	24 614 0130	642032
Dna Gp Experience	50	03-04	24 614 0130	580953	HONDA				
Eaglet	50	96	24 614 0130	580953	Cb 50 J	50	80	24 614 0520	35350-292-003
Eaglet Automatico	50	96-97	24 614 0130	580953	Cb 50 J	50	81-83	24 614 0520	35350-292-003
Easy Moving	50	95-96	24 614 0130	580953	Nsr 50 S	50	92	24 614 0530	35340-MMS-600
Gsm	50	01	24 614 0130	580953	Nsr 50 S	50	93	24 614 0530	35340-MMS-600
Gsm	50	99-00	24 614 0130	580953	Nsr 50 S	50	94	24 614 0530	35340-MMS-600
Ice	50	01-05	24 614 0130	580953	Nsr 50 S	50	89-91	24 614 0530	35340-MMS-600
Rk Cannibal	50	96-98	24 614 0130	580953	Nsr 50 S	50	95-96	24 614 0530	35340-MMS-600
Runner	50	97-00	24 614 0130	580953	Sfx 50	50	00	24 614 0530	35340-MMS-600
Runner Poggiali	50	02	24 614 0130	580953	Sfx 50	50	96	24 614 0530	35340-MMS-600
Runner Purejet	50	07	24 614 0161	583575	Sfx 50	50	97	24 614 0530	35340-MMS-600
Runner Purejet	50	02-04	24 614 0130	580953	Sfx 50	50	98	24 614 0530	35340-MMS-600
Runner Purejet	50	05-06	24 614 0161	583575	Sfx 50	50	99	24 614 0530	35340-MMS-600
Runner Purejet	50	10-11	24 614 0161	583575	Sgx 50 Sky	50	97	24 614 0530	35340-MMS-600
Runner Purejet St	50	08	24 614 0161	583575	Sgx 50 Sky	50	98	24 614 0530	35340-MMS-600
Runner Sp	50	07	24 614 0161	583575	Sgx 50 Sky	50	99-00	24 614 0530	35340-MMS-600
Runner Sp	50	02-04	24 614 0130	580953	Sh 50 Scoopy	50	98	24 614 0530	35340-MMS-600
Runner Sp	50	05-06	24 614 0161	583575	Sh 50 Scoopy	50	96-97	24 614 0530	35340-MMS-600
Runner Sp	50	10-12	24 614 0161	583575	Sj 50 Bali	50	95	24 614 0530	35340-MMS-600
Runner Sp Special Edition	50	07	24 614 0161	583575	Sj 50 Bali	50	96	24 614 0530	35340-MMS-600
Runner Sp St & Simoncelli	50	08-09	24 614 0161	583575	Sj 50 Bali	50	97	24 614 0530	35340-MMS-600
Stalker	50	05-06	24 614 0130	580953	Sj 50 Bali	50	98	24 614 0530	35340-MMS-600
Stalker	50	07-08	24 614 0130	580953	Sj 50 Bali	50	99-01	24 614 0530	35340-MMS-600



INTERRUTTORI STOP BRAKE LIGHT SWITCHES

Modello - Model	Cc	Anno Year	Codice RMS RMS Code	Rifer. Originale Oem Number
Srx 50 Shadow	50	98	24 614 0530	35340-MM5-600
Srx 50 Shadow	50	99	24 614 0530	35340-MM5-600
XL 50 S	50	82-83	24 614 0520	35350-292-003
Srx 90 It Shadow	90	98	24 614 0530	35340-MM5-600
Srx 90 It Shadow	90	99-00	24 614 0530	35340-MM5-600
Sj 100 Bali Ex	100	96	24 614 0530	35340-MM5-600
Sj 100 Bali Ex	100	97	24 614 0530	35340-MM5-600
Sj 100 Bali Ex	100	98	24 614 0530	35340-MM5-600
Sj 100 Bali Ex	100	99-00	24 614 0530	35340-MM5-600
Nsc 110 Mpd Vision Cbs	110	12-13	24 614 0530	35340-MM5-600
Anf 125 Innova	125	07-09	24 614 0530	35340-MM5-600
Anf 125 Innova	125	10-12	24 614 0530	35340-MM5-600
Cb 125 J	125	75-79	24 614 0520	35350-292-003
Cb 125 T Twin	125	80	24 614 0520	35350-292-003
Cb 125 T Twin	125	81-86	24 614 0520	35350-292-003
Cbf 125 M	125	09	24 614 0530	35340-MM5-600
Cbf 125 M	125	10	24 614 0530	35340-MM5-600
Cbf 125 M	125	11-12	24 614 0530	35340-MM5-600
Cbr 125 R	125	04	24 614 0530	35340-MM5-600
Cbr 125 R	125	05	24 614 0530	35340-MM5-600
Cbr 125 R	125	12	24 614 0530	35340-MM5-600
Cbr 125 R 80 Km/H	125	12	24 614 0530	35340-MM5-600
Cbr 125 Rs Repsol	125	05	24 614 0530	35340-MM5-600
Cbr 125 Rs Repsol	125	12	24 614 0530	35340-MM5-600
Cbr 125 Rs Repsol	125	06-07	24 614 0530	35340-MM5-600
Cbr 125 Rs Repsol 80 Km/H	125	12	24 614 0530	35340-MM5-600
Cbr 125 Rt	125	12	24 614 0530	35340-MM5-600
Cbr 125 Rt 80 Km/H	125	12	24 614 0530	35340-MM5-600
Cbr 125 Rw	125	05	24 614 0530	35340-MM5-600
Cbr 125 Rw	125	06	24 614 0530	35340-MM5-600
Cbr 125 Rw	125	09	24 614 0530	35340-MM5-600
Cbr 125 Rw	125	10	24 614 0530	35340-MM5-600
Cbr 125 Rw	125	11	24 614 0530	35340-MM5-600
Cbr 125 Rw	125	07-08	24 614 0530	35340-MM5-600
Cbr 125 Rw 80 Km/H	125	09	24 614 0530	35340-MM5-600
Cbr 125 Rw 80 Km/H	125	10	24 614 0530	35340-MM5-600
Cbr 125 Rw 80 Km/H	125	11	24 614 0530	35340-MM5-600
Cbr 125 Rw 80 Km/H	125	07-08	24 614 0530	35340-MM5-600
Cg 125 Es	125	04-06	24 614 0530	35340-MM5-600
Cg 125 Es	125	07-08	24 614 0530	35340-MM5-600
Clr 125 Cityfly	125	98-00	24 614 0530	35340-MM5-600
Clr 125 Cityfly 80 Km/H	125	98-00	24 614 0530	35340-MM5-600
Nsr 125 R	125	00	24 614 0530	35340-MM5-600
Nsr 125 R	125	98	24 614 0530	35340-MM5-600
Nsr 125 R	125	99	24 614 0530	35340-MM5-600
Nsr 125 R	125	01-03	24 614 0530	35340-MM5-600
Nsr 125 R 80 Km/H	125	00	24 614 0530	35340-MM5-600
Nsr 125 R 80 Km/H	125	97	24 614 0530	35340-MM5-600
Nsr 125 R 80 Km/H	125	98	24 614 0530	35340-MM5-600
Nsr 125 R 80 Km/H	125	99	24 614 0530	35340-MM5-600
Nsr 125 R 80 Km/H	125	01-03	24 614 0530	35340-MM5-600
Vt 125 C Shadow	125	00	24 614 0530	35340-MM5-600
Vt 125 C Shadow	125	99	24 614 0530	35340-MM5-600
Vt 125 C Shadow	125	01-02	24 614 0530	35340-MM5-600
Vt 125 C Shadow	125	04-05	24 614 0530	35340-MM5-600
Vt 125 C Shadow	125	06-08	24 614 0530	35340-MM5-600
Vt 125 C Shadow 80 Km/H	125	00	24 614 0530	35340-MM5-600
Vt 125 C Shadow 80 Km/H	125	99	24 614 0530	35340-MM5-600
Vt 125 C Shadow 80 Km/H	125	01-02	24 614 0530	35340-MM5-600
Vt 125 C Shadow 80 Km/H	125	04-05	24 614 0530	35340-MM5-600
Vt 125 C2 Shadow	125	00	24 614 0530	35340-MM5-600
Vt 125 C2 Shadow	125	01-02	24 614 0530	35340-MM5-600
Vt 125 C2 Shadow 80 Km/H	125	00	24 614 0530	35340-MM5-600
Vt 125 C2 Shadow 80 Km/H	125	01-02	24 614 0530	35340-MM5-600
XL 125 K	125	76	24 614 0520	35350-292-003
XL 125 K	125	77-78	24 614 0520	35350-292-003
XL 125 V Varadero	125	01	24 614 0530	35340-MM5-600
XL 125 V Varadero	125	02	24 614 0530	35340-MM5-600
XL 125 V Varadero	125	04	24 614 0530	35340-MM5-600

Modello - Model	Cc	Anno Year	Codice RMS RMS Code	Rifer. Originale Oem Number
XL 125 V Varadero	125	05	24 614 0530	35340-MM5-600
XL 125 V Varadero	125	06	24 614 0530	35340-MM5-600
XL 125 V Varadero	125	07	24 614 0530	35340-MM5-600
XL 125 V Varadero	125	08	24 614 0530	35340-MM5-600
XL 125 V Varadero	125	09	24 614 0530	35340-MM5-600
XL 125 V Varadero	125	10	24 614 0530	35340-MM5-600
XL 125 V Varadero	125	11-13	24 614 0530	35340-MM5-600
XL 125 V Varadero 80 Km/H	125	01	24 614 0530	35340-MM5-600
XL 125 V Varadero 80 Km/H	125	02	24 614 0530	35340-MM5-600
XL 125 V Varadero 80 Km/H	125	04	24 614 0530	35340-MM5-600
XL 125 V Varadero 80 Km/H	125	05	24 614 0530	35340-MM5-600
XL 125 V Varadero 80 Km/H	125	06	24 614 0530	35340-MM5-600
XL 125 V Varadero 80 Km/H	125	07	24 614 0530	35340-MM5-600
XL 125 V Varadero 80 Km/H	125	08	24 614 0530	35340-MM5-600
XLR 125 R	125	98-99	24 614 0530	35340-MM5-600
XLR 125 R 80 Km/H	125	98-99	24 614 0530	35340-MM5-600
Xr 125 L	125	03	24 614 0530	35340-MM5-600
Xr 125 L	125	04	24 614 0530	35340-MM5-600
Xr 125 L	125	05	24 614 0530	35340-MM5-600
Xr 125 L	125	06-08	24 614 0530	35340-MM5-600
Sh 150	150	03	24 614 0530	35340-MM5-600
Sh 150	150	04	24 614 0530	35340-MM5-600
Sh 150	150	01-02	24 614 0530	35340-MM5-600
Sh 150 D I	150	09-11	24 614 0530	35340-MM5-600
Sh 150 I	150	05	24 614 0530	35340-MM5-600
Sh 150 I	150	06	24 614 0530	35340-MM5-600
Sh 150 I	150	07	24 614 0530	35340-MM5-600
Sh 150 I	150	08	24 614 0530	35340-MM5-600
Cm 185 T	185	78-80	24 614 0520	35350-292-003
Cm 200 T	200	80	24 614 0520	35350-292-003
Cm 200 T	200	81-84	24 614 0520	35350-292-003
Cb 250 N Eu	250	80	24 614 0520	35350-292-003
Cb 250 N Eu	250	81	24 614 0520	35350-292-003
Cb 250 N Eu	250	78-79	24 614 0520	35350-292-003
Cb 250 Nd Eu	250	82	24 614 0520	35350-292-003
Cb 250 Nd Eu	250	83	24 614 0520	35350-292-003
Cb 250 Nd Eu	250	82-83	24 614 0520	35350-292-003
Cb 250 Rs	250	80-81	24 614 0520	35350-292-003
Cb 250 T Twin	250	77	24 614 0520	35350-292-003
Cb 250 T Twin	250	77-78	24 614 0520	35350-292-003
Cbf 250	250	06	24 614 0530	35340-MM5-600
Cbf 250	250	04-05	24 614 0530	35340-MM5-600
Cbr 250 Ra Abs	250	11-12	24 614 0530	35340-MM5-600
Cj 250 T	250	76-79	24 614 0520	35350-292-003
Cm 250 C Custom	250	82-83	24 614 0520	35350-292-003
Cmx 250 C Rebel	250	96	24 614 0530	35340-MM5-600
Cmx 250 C Rebel	250	97	24 614 0530	35340-MM5-600
Cmx 250 C Rebel	250	98	24 614 0530	35340-MM5-600
Cmx 250 C Rebel	250	99	24 614 0530	35340-MM5-600
XL 250 R	250	82	24 614 0520	35350-292-003
XL 250 R	250	83	24 614 0520	35350-292-003
XL 250 S	250	80	24 614 0520	35350-292-003
XL 250 S	250	78-79	24 614 0520	35350-292-003
XL 250 S	250	81-82	24 614 0520	35350-292-003
Sh 300 A I Abs	300	07	24 614 0530	35340-MM5-600
Sh 300 A I Abs	300	08	24 614 0530	35340-MM5-600
Sh 300 A I Abs	300	09	24 614 0530	35340-MM5-600
Sh 300 A I Abs	300	10	24 614 0530	35340-MM5-600
Sh 300 A I Abs	300	11	24 614 0530	35340-MM5-600
Sh 300 A I Abs	300	12	24 614 0530	35340-MM5-600
Sh 300 I	300	10	24 614 0530	35340-MM5-600
Sh 300 I	300	08-09	24 614 0530	35340-MM5-600
Cb 350 F Four	350	73-75	24 614 0520	35350-292-003
Cb 400 A Twin Automatk	400	79	24 614 0520	35350-292-003
Cb 400 N Eu	400	80	24 614 0520	35350-292-003
Cb 400 N Eu	400	81	24 614 0520	35350-292-003
Cb 400 N Eu	400	82	24 614 0520	35350-292-003
Cb 400 N Eu	400	78-79	24 614 0520	35350-292-003
Cb 400 N Eu	400	83-85	24 614 0520	35350-292-003

INTERRUTTORI STOP

BRAKE LIGHT SWITCHES



Modello - Model	Cc	Anno Year	Codice RMS RMS Code	Rifer. Originale Oem Number	Modello - Model	Cc	Anno Year	Codice RMS RMS Code	Rifer. Originale Oem Number
Cm 400 T	400	80	24 614 0520	35350-292-003	Cbr 600 F	600	02	24 614 0530	35340-MM5-600
Cm 400 T	400	81	24 614 0520	35350-292-003	Cbr 600 F	600	03	24 614 0530	35340-MM5-600
Cm 400 T Custom	400	82-83	24 614 0520	35350-292-003	Cbr 600 F	600	04	24 614 0530	35340-MM5-600
Ns 400 R	400	85-86	24 614 0520	35350-292-003	Cbr 600 F	600	05	24 614 0530	35340-MM5-600
Cb 500	500	96	24 614 0530	35340-MM5-600	Cbr 600 F	600	11	24 614 0530	35340-MM5-600
Cb 500	500	97	24 614 0530	35340-MM5-600	Cbr 600 F	600	87	24 614 0530	35340-MM5-600
Cb 500	500	98	24 614 0530	35340-MM5-600	Cbr 600 F	600	88	24 614 0530	35340-MM5-600
Cb 500	500	99	24 614 0530	35340-MM5-600	Cbr 600 F	600	89	24 614 0530	35340-MM5-600
Cb 500	500	02-03	24 614 0530	35340-MM5-600	Cbr 600 F	600	90	24 614 0530	35340-MM5-600
Cb 500	500	00-01	24 614 0530	35340-MM5-600	Cbr 600 F	600	91	24 614 0530	35340-MM5-600
Cb 500	500	94-95	24 614 0530	35340-MM5-600	Cbr 600 F	600	92	24 614 0530	35340-MM5-600
Cb 500 S Sport	500	98	24 614 0530	35340-MM5-600	Cbr 600 F	600	93	24 614 0530	35340-MM5-600
Cb 500 S Sport	500	99	24 614 0530	35340-MM5-600	Cbr 600 F	600	94	24 614 0530	35340-MM5-600
Cb 500 S Sport	500	02-03	24 614 0530	35340-MM5-600	Cbr 600 F	600	95	24 614 0530	35340-MM5-600
Cb 500 S Sport	500	00-01	24 614 0530	35340-MM5-600	Cbr 600 F	600	96	24 614 0530	35340-MM5-600
Cbf 500	500	04-05	24 614 0530	35340-MM5-600	Cbr 600 F	600	97	24 614 0530	35340-MM5-600
Cbf 500	500	06-08	24 614 0530	35340-MM5-600	Cbr 600 F	600	98	24 614 0530	35340-MM5-600
Cbf 500 A Abs	500	04-05	24 614 0530	35340-MM5-600	Cbr 600 F	600	99	24 614 0530	35340-MM5-600
Cbf 500 A Abs	500	06-08	24 614 0530	35340-MM5-600	Cbr 600 F	600	12-13	24 614 0530	35340-MM5-600
Cx 500	500	81	24 614 0530	35340-MM5-600	Cbr 600 F	600	06-07	24 614 0530	35340-MM5-600
Cx 500	500	82-83	24 614 0530	35340-MM5-600	Cbr 600 Fa Abs	600	11	24 614 0530	35340-MM5-600
Cb 600 F Hornet	600	00	24 614 0530	35340-MM5-600	Cbr 600 Fa Abs	600	12-13	24 614 0530	35340-MM5-600
Cb 600 F Hornet	600	01	24 614 0530	35340-MM5-600	Cbr 600 Fs Sport	600	01	24 614 0530	35340-MM5-600
Cb 600 F Hornet	600	02	24 614 0530	35340-MM5-600	Cbr 600 Fs Sport	600	02	24 614 0530	35340-MM5-600
Cb 600 F Hornet	600	03	24 614 0530	35340-MM5-600	Cbr 600 Rr	600	03	24 614 0530	35340-MM5-600
Cb 600 F Hornet	600	04	24 614 0530	35340-MM5-600	Cbr 600 Rr	600	04	24 614 0530	35340-MM5-600
Cb 600 F Hornet	600	05	24 614 0530	35340-MM5-600	Cbr 600 Rr	600	05	24 614 0530	35340-MM5-600
Cb 600 F Hornet	600	06	24 614 0530	35340-MM5-600	Cbr 600 Rr	600	06	24 614 0530	35340-MM5-600
Cb 600 F Hornet	600	07	24 614 0530	35340-MM5-600	Fjs 600 A Silver Wing Abs	600	03	24 614 0530	35340-MM5-600
Cb 600 F Hornet	600	08	24 614 0530	35340-MM5-600	Fjs 600 A Silver Wing Abs	600	04	24 614 0530	35340-MM5-600
Cb 600 F Hornet	600	09	24 614 0530	35340-MM5-600	Fjs 600 A Silver Wing Abs	600	05	24 614 0530	35340-MM5-600
Cb 600 F Hornet	600	10	24 614 0530	35340-MM5-600	Fjs 600 A Silver Wing Abs	600	06	24 614 0530	35340-MM5-600
Cb 600 F Hornet	600	98	24 614 0530	35340-MM5-600	Fjs 600 D Silver Wing	600	03	24 614 0530	35340-MM5-600
Cb 600 F Hornet	600	99	24 614 0530	35340-MM5-600	Fjs 600 D Silver Wing	600	04	24 614 0530	35340-MM5-600
Cb 600 Fa Hornet Abs	600	07	24 614 0530	35340-MM5-600	Fjs 600 D Silver Wing	600	05	24 614 0530	35340-MM5-600
Cb 600 Fa Hornet Abs	600	08	24 614 0530	35340-MM5-600	Fjs 600 D Silver Wing	600	06	24 614 0530	35340-MM5-600
Cb 600 Fa Hornet Abs	600	09	24 614 0530	35340-MM5-600	Fjs 600 Silver Wing	600	01	24 614 0530	35340-MM5-600
Cb 600 Fa Hornet Abs	600	10	24 614 0530	35340-MM5-600	Fjs 600 Silver Wing	600	02	24 614 0530	35340-MM5-600
Cb 600 Fa Hornet Abs	600	11	24 614 0530	35340-MM5-600	Vt 600 C Shadow	600	89	24 614 0530	35340-MM5-600
Cb 600 Fa Hornet Abs	600	12	24 614 0530	35340-MM5-600	Vt 600 C Shadow	600	92	24 614 0530	35340-MM5-600
Cb 600 S F2 Hornet S	600	00	24 614 0530	35340-MM5-600	Vt 600 C Shadow	600	93	24 614 0530	35340-MM5-600
Cb 600 S F2 Hornet S	600	01	24 614 0530	35340-MM5-600	Vt 600 C Shadow	600	94	24 614 0530	35340-MM5-600
Cb 600 S F2 Hornet S	600	02-03	24 614 0530	35340-MM5-600	Vt 600 C Shadow	600	95	24 614 0530	35340-MM5-600
Cbf 600 N	600	04	24 614 0530	35340-MM5-600	Vt 600 C Shadow	600	96	24 614 0530	35340-MM5-600
Cbf 600 N	600	05	24 614 0530	35340-MM5-600	Vt 600 C Shadow	600	97	24 614 0530	35340-MM5-600
Cbf 600 N	600	08	24 614 0530	35340-MM5-600	Vt 600 C Shadow	600	98	24 614 0530	35340-MM5-600
Cbf 600 N	600	09	24 614 0530	35340-MM5-600	Vt 600 C Shadow	600	90-91	24 614 0530	35340-MM5-600
Cbf 600 N	600	10	24 614 0530	35340-MM5-600	Vt 600 C Shadow	600	99-00	24 614 0530	35340-MM5-600
Cbf 600 N	600	06-07	24 614 0530	35340-MM5-600	Vt 600 C Shadow Sprocket Large Spline	600	88	24 614 0530	35340-MM5-600
Cbf 600 Na Abs	600	04	24 614 0530	35340-MM5-600	Vt C Shadow Spr. Narrow Spline	600	88	24 614 0530	35340-MM5-600
Cbf 600 Na Abs	600	05	24 614 0530	35340-MM5-600	XL 600 Lm Paris Dakar	600	87	24 614 0530	35340-MM5-600
Cbf 600 Na Abs	600	08	24 614 0530	35340-MM5-600	XL 600 Lm Paris Dakar	600	85-86	24 614 0530	35340-MM5-600
Cbf 600 Na Abs	600	09	24 614 0530	35340-MM5-600	Fmx 650	650	05	24 614 0530	35340-MM5-600
Cbf 600 Na Abs	600	10-13	24 614 0530	35340-MM5-600	Fmx 650	650	06-07	24 614 0530	35340-MM5-600
Cbf 600 Na Abs	600	10-12	24 614 0530	35340-MM5-600	Fx 650 Vigor	650	99-00	24 614 0530	35340-MM5-600
Cbf 600 S	600	04	24 614 0530	35340-MM5-600	Nt 650 V Deauville	650	00	24 614 0530	35340-MM5-600
Cbf 600 S	600	05	24 614 0530	35340-MM5-600	Nt 650 V Deauville	650	01	24 614 0530	35340-MM5-600
Cbf 600 S	600	08	24 614 0530	35340-MM5-600	Nt 650 V Deauville	650	98	24 614 0530	35340-MM5-600
Cbf 600 S	600	09	24 614 0530	35340-MM5-600	Nt 650 V Deauville	650	99	24 614 0530	35340-MM5-600
Cbf 600 S	600	10	24 614 0530	35340-MM5-600	Nt 650 V Deauville Cbs	650	02	24 614 0530	35340-MM5-600
Cbf 600 S	600	06-07	24 614 0530	35340-MM5-600	Nt 650 V Deauville Cbs	650	03	24 614 0530	35340-MM5-600
Cbf 600 Sa Abs	600	04	24 614 0530	35340-MM5-600	Nt 650 V Deauville Cbs	650	04	24 614 0530	35340-MM5-600
Cbf 600 Sa Abs	600	05	24 614 0530	35340-MM5-600	Nt 650 V Deauville Cbs	650	05	24 614 0530	35340-MM5-600
Cbf 600 Sa Abs	600	08	24 614 0530	35340-MM5-600	Nt 650 V Deauville Cbs	650	04	24 614 0530	35340-MM5-600
Cbf 600 Sa Abs	600	09	24 614 0530	35340-MM5-600	Nx 650 Dominator	650	95	24 614 0530	35340-MM5-600
Cbf 600 Sa Abs	600	10-13	24 614 0530	35340-MM5-600	Nx 650 Dominator	650	96	24 614 0530	35340-MM5-600
Cbf 600 Sa Abs	600	06-07	24 614 0530	35340-MM5-600	Nx 650 Dominator	650	97	24 614 0530	35340-MM5-600
Cbr 600 F	600	00	24 614 0530	35340-MM5-600	Nx 650 Dominator	650	98	24 614 0530	35340-MM5-600
Cbr 600 F	600	01	24 614 0530	35340-MM5-600	Nx 650 Dominator	650	99-00	24 614 0530	35340-MM5-600



INTERRUTTORI STOP BRAKE LIGHT SWITCHES

Modello - Model	Cc	Anno Year	Codice RMS RMS Code	Rifer. Originale Oem Number	Modello - Model	Cc	Anno Year	Codice RMS RMS Code	Rifer. Originale Oem Number
Slr 650	650	97	24 614 0530	35340-MM5-600	Vt 750 C2 Shadow Aero	750	01-02	24 614 0530	35340-MM5-600
Slr 650	650	98	24 614 0530	35340-MM5-600	Vt 750 C2 Shadow Spirit	750	07	24 614 0530	35340-MM5-600
XL 650 V Transalp	650	00	24 614 0530	35340-MM5-600	Vt 750 C2 Shadow Spirit	750	08-09	24 614 0530	35340-MM5-600
XL 650 V Transalp	650	01	24 614 0530	35340-MM5-600	Vt C2b Shadow Black Spirit	750	10	24 614 0530	35340-MM5-600
XL 650 V Transalp	650	02	24 614 0530	35340-MM5-600	Vt C2b Shadow Black Spirit	750	11	24 614 0530	35340-MM5-600
XL 650 V Transalp	650	03	24 614 0530	35340-MM5-600	Vt C2b Shadow Black Spirit	750	12-13	24 614 0530	35340-MM5-600
XL 650 V Transalp	650	04	24 614 0530	35340-MM5-600	Vt C2b Shadow Black Spirit	750	14-16	24 614 0530	35340-MM5-600
XL 650 V Transalp	650	05	24 614 0530	35340-MM5-600	Vt 750 C2s Shadow Abs	750	10	24 614 0530	35340-MM5-600
XL 650 V Transalp	650	06-07	24 614 0530	35340-MM5-600	Vt 750 C2s Shadow Abs	750	11-12	24 614 0530	35340-MM5-600
Xrv 650 Africa Twin	650	88	24 614 0530	35340-MM5-600	Vt 750 Cs Shadow Abs	750	12	24 614 0530	35340-MM5-600
Xrv 650 Africa Twin	650	89-90	24 614 0530	35340-MM5-600	Vt 750 Cs Shadow Abs	750	10-11	24 614 0530	35340-MM5-600
Nsa 700 A Dn-01 Abs	700	08	24 614 0530	35340-MM5-600	Vt 750 Dc Black Widow	750	02-03	24 614 0530	35340-MM5-600
Nsa 700 A Dn-01 Abs	700	09-11	24 614 0530	35340-MM5-600	Vt 750 Dc Black Widow	750	00-01	24 614 0530	35340-MM5-600
Nt 700 V Deauville	700	06	24 614 0530	35340-MM5-600	Vt 750 S	750	10	24 614 0530	35340-MM5-600
Nt 700 V Deauville	700	07	24 614 0530	35340-MM5-600	Xrv 750 Africa Twin	750	90	24 614 0530	35340-MM5-600
Nt 700 V Deauville	700	10	24 614 0530	35340-MM5-600	Xrv 750 Africa Twin	750	91	24 614 0530	35340-MM5-600
Nt 700 V Deauville	700	11-13	24 614 0530	35340-MM5-600	Xrv 750 Africa Twin	750	92	24 614 0530	35340-MM5-600
Nt 700 V Deauville	700	08-09	24 614 0530	35340-MM5-600	Xrv 750 Africa Twin	750	93	24 614 0530	35340-MM5-600
Nt 700 Va Deauville Abs	700	06	24 614 0530	35340-MM5-600	Xrv 750 Africa Twin	750	94	24 614 0530	35340-MM5-600
Nt 700 Va Deauville Abs	700	07	24 614 0530	35340-MM5-600	Xrv 750 Africa Twin	750	95	24 614 0530	35340-MM5-600
Nt 700 Va Deauville Abs	700	10	24 614 0530	35340-MM5-600	Xrv 750 Africa Twin	750	96	24 614 0530	35340-MM5-600
Nt 700 Va Deauville Abs	700	11-16	24 614 0530	35340-MM5-600	Xrv 750 Africa Twin	750	97	24 614 0530	35340-MM5-600
Nt 700 Va Deauville Abs	700	08-09	24 614 0530	35340-MM5-600	Xrv 750 Africa Twin	750	98	24 614 0530	35340-MM5-600
XL 700 V Transalp	700	08	24 614 0530	35340-MM5-600	Xrv 750 Africa Twin	750	99	24 614 0530	35340-MM5-600
XL 700 V Transalp	700	09	24 614 0530	35340-MM5-600	Xrv 750 Africa Twin	750	00-03	24 614 0530	35340-MM5-600
XL 700 V Transalp	700	10	24 614 0530	35340-MM5-600	Pc 800 Pacific Coast	800	89	24 614 0530	35340-MM5-600
XL 700 Va Transalp Abs	700	08	24 614 0530	35340-MM5-600	Pc 800 Pacific Coast	800	90	24 614 0530	35340-MM5-600
XL 700 Va Transalp Abs	700	09	24 614 0530	35340-MM5-600	Vfr 800	800	02	24 614 0530	35340-MM5-600
XL 700 Va Transalp Abs	700	10	24 614 0530	35340-MM5-600	Vfr 800	800	03	24 614 0530	35340-MM5-600
XL 700 Va Transalp Abs	700	11-13	24 614 0530	35340-MM5-600	Vfr 800	800	04	24 614 0530	35340-MM5-600
Cb 750 F2 Seven Fifty	750	94	24 614 0530	35340-MM5-600	Vfr 800	800	05	24 614 0530	35340-MM5-600
Cb 750 F2 Seven Fifty	750	95	24 614 0530	35340-MM5-600	Vfr 800	800	08	24 614 0530	35340-MM5-600
Cb 750 F2 Seven Fifty	750	96	24 614 0530	35340-MM5-600	Vfr 800	800	06-07	24 614 0530	35340-MM5-600
Cb 750 F2 Seven Fifty	750	97	24 614 0530	35340-MM5-600	Vfr 800	800	09-10	24 614 0530	35340-MM5-600
Cb 750 F2 Seven Fifty	750	98	24 614 0530	35340-MM5-600	Vfr 800 A Abs	800	02	24 614 0530	35340-MM5-600
Cb 750 F2 Seven Fifty	750	01-03	24 614 0530	35340-MM5-600	Vfr 800 A Abs	800	03	24 614 0530	35340-MM5-600
Cb 750 F2 Seven Fifty	750	92-93	24 614 0530	35340-MM5-600	Vfr 800 A Abs	800	04	24 614 0530	35340-MM5-600
Cb 750 F2 Seven Fifty	750	99-00	24 614 0530	35340-MM5-600	Vfr 800 A Abs	800	05	24 614 0530	35340-MM5-600
Rvf 750 R	750	94	24 614 0530	35340-MM5-600	Vfr 800 A Abs	800	08	24 614 0530	35340-MM5-600
Rvf 750 R	750	95-97	24 614 0530	35340-MM5-600	Vfr 800 A Abs	800	09-13	24 614 0530	35340-MM5-600
Vf 750 C Magna	750	82	24 614 0530	35340-MM5-600	Vfr 800 A Abs	800	06-07	24 614 0530	35340-MM5-600
Vf 750 C Magna	750	83	24 614 0530	35340-MM5-600	Vfr 800 Fi	800	00	24 614 0530	35340-MM5-600
Vf 750 C Magna	750	84	24 614 0530	35340-MM5-600	Vfr 800 Fi	800	01	24 614 0530	35340-MM5-600
Vf 750 C Magna	750	93	24 614 0530	35340-MM5-600	Vfr 800 Fi	800	98	24 614 0530	35340-MM5-600
Vf 750 C Magna	750	94	24 614 0530	35340-MM5-600	Vfr 800 Fi	800	99	24 614 0530	35340-MM5-600
Vf 750 C Magna	750	95	24 614 0530	35340-MM5-600	Vfr 800 Fi Jubi Modell	800	99	24 614 0530	35340-MM5-600
Vf 750 C Magna	750	96	24 614 0530	35340-MM5-600	Vfr 800 X Crossrunner Abs	800	11	24 614 0530	35340-MM5-600
Vf 750 C Magna	750	97-98	24 614 0530	35340-MM5-600	Vfr 800 X Crossrunner Abs	800	12	24 614 0530	35340-MM5-600
Vf 750 C Magna	750	99-00	24 614 0530	35340-MM5-600	Cb 900 F Hornet	900	02	24 614 0530	35340-MM5-600
Vfr 750 F	750	90	24 614 0530	35340-MM5-600	Cb 900 F Hornet	900	03	24 614 0530	35340-MM5-600
Vfr 750 F	750	91	24 614 0530	35340-MM5-600	Cb 900 F Hornet	900	04	24 614 0530	35340-MM5-600
Vfr 750 F	750	92	24 614 0530	35340-MM5-600	Cb 900 F Hornet	900	05-06	24 614 0530	35340-MM5-600
Vfr 750 F	750	93	24 614 0530	35340-MM5-600	Cbr 900 Rr Fireblade	900	00	24 614 0530	35340-MM5-600
Vfr 750 F	750	94	24 614 0530	35340-MM5-600	Cbr 900 Rr Fireblade	900	01	24 614 0530	35340-MM5-600
Vfr 750 F	750	95	24 614 0530	35340-MM5-600	Cbr 900 Rr Fireblade	900	02	24 614 0530	35340-MM5-600
Vfr 750 F	750	96	24 614 0530	35340-MM5-600	Cbr 900 Rr Fireblade	900	03	24 614 0530	35340-MM5-600
Vfr 750 F	750	97	24 614 0530	35340-MM5-600	Cbr 900 Rr Fireblade	900	02	24 614 0530	35340-MM5-600
Vfr 750 R	750	88	24 614 0530	35340-MM5-600	Cbr 900 Rr Fireblade	900	03	24 614 0530	35340-MM5-600
Vfr 750 R	750	89-93	24 614 0530	35340-MM5-600	Cbr 900 Rr Fireblade	900	04	24 614 0530	35340-MM5-600
Vt 750 C Shadow	750	04	24 614 0530	35340-MM5-600	Cbr 900 Rr Fireblade	900	05	24 614 0530	35340-MM5-600
Vt 750 C Shadow	750	05	24 614 0530	35340-MM5-600	Cbr 900 Rr Fireblade	900	06	24 614 0530	35340-MM5-600
Vt 750 C Shadow	750	06	24 614 0530	35340-MM5-600	Cbr 900 Rr Fireblade	900	07	24 614 0530	35340-MM5-600
Vt 750 C Shadow	750	07	24 614 0530	35340-MM5-600	Cbr 900 Rr Fireblade	900	08	24 614 0530	35340-MM5-600
Vt 750 C Shadow	750	08	24 614 0530	35340-MM5-600	Cbr 900 Rr Fireblade	900	09	24 614 0530	35340-MM5-600
Vt 750 C Shadow	750	09	24 614 0530	35340-MM5-600	Cb 1000 F Super Four	1000	93	24 614 0530	35340-MM5-600
Vt 750 C Shadow	750	98	24 614 0530	35340-MM5-600	Cb 1000 F Super Four	1000	94	24 614 0530	35340-MM5-600
Vt 750 C Shadow	750	99	24 614 0530	35340-MM5-600	Cb 1000 F Super Four	1000	95	24 614 0530	35340-MM5-600
Vt 750 C2 Shadow Aero	750	97	24 614 0530	35340-MM5-600	Cb 1000 F Super Four	1000	96	24 614 0530	35340-MM5-600
Vt 750 C2 Shadow Aero	750	99	24 614 0530	35340-MM5-600	Cbf 1000	1000	06	24 614 0530	35340-MM5-600

INTERRUTTORI STOP

BRAKE LIGHT SWITCHES



Modello - Model	Cc	Anno Year	Codice RMS RMS Code	Rifer. Originale Oem Number	Modello - Model	Cc	Anno Year	Codice RMS RMS Code	Rifer. Originale Oem Number
Cbf 1000	1000	07	24 614 0530	35340-MM5-600	Cbr 1100 Xx Super Blackbird	1100	04	24 614 0530	35340-MM5-600
Cbf 1000	1000	08	24 614 0530	35340-MM5-600	Cbr 1100 Xx Super Blackbird	1100	05	24 614 0530	35340-MM5-600
Cbf 1000	1000	09	24 614 0530	35340-MM5-600	Cbr 1100 Xx Super Blackbird	1100	97	24 614 0530	35340-MM5-600
Cbf 1000	1000	10	24 614 0530	35340-MM5-600	Cbr 1100 Xx Super Blackbird	1100	98	24 614 0530	35340-MM5-600
Cbf 1000 A Abs	1000	06	24 614 0530	35340-MM5-600	Cbr 1100 Xx Super Blackbird	1100	99	24 614 0530	35340-MM5-600
Cbf 1000 A Abs	1000	07	24 614 0530	35340-MM5-600	Cbr 1100 Xx Super Blackbird	1100	06-08	24 614 0530	35340-MM5-600
Cbf 1000 A Abs	1000	08	24 614 0530	35340-MM5-600	Vt 1100 C Shadow	1100	94	24 614 0530	35340-MM5-600
Cbf 1000 A Abs	1000	09	24 614 0530	35340-MM5-600	Vt 1100 C Shadow	1100	95	24 614 0530	35340-MM5-600
Cbf 1000 A Abs	1000	10-12	24 614 0530	35340-MM5-600	Vt 1100 C Shadow	1100	88-89	24 614 0530	35340-MM5-600
Cbf 1000 F	1000	10	24 614 0530	35340-MM5-600	Vt 1100 C2 Shadow Ace	1100	95	24 614 0530	35340-MM5-600
Cbf 1000 Fa Abs	1000	10	24 614 0530	35340-MM5-600	Vt 1100 C2 Shadow Ace	1100	96	24 614 0530	35340-MM5-600
Cbf 1000 Fa Abs	1000	11	24 614 0530	35340-MM5-600	Vt 1100 C2 Shadow Ace	1100	97	24 614 0530	35340-MM5-600
Cbf 1000 Fa Abs	1000	12-16	24 614 0530	35340-MM5-600	Vt 1100 C2 Shadow Ace	1100	98	24 614 0530	35340-MM5-600
Cbr 1000 F	1000	87	24 614 0530	35340-MM5-600	Vt 1100 C2 Shadow Ace	1100	99-00	24 614 0530	35340-MM5-600
Cbr 1000 F	1000	88	24 614 0530	35340-MM5-600	Vt 1100 C3 Shadow Aero	1100	98	24 614 0530	35340-MM5-600
Cbr 1000 F	1000	89	24 614 0530	35340-MM5-600	Vt 1100 C3 Shadow Aero	1100	99-00	24 614 0530	35340-MM5-600
Cbr 1000 F	1000	90	24 614 0530	35340-MM5-600	Vfr 1200 F Abs	1200	10	24 614 0530	35340-MM5-600
Cbr 1000 F	1000	91	24 614 0530	35340-MM5-600	Vfr 1200 F Abs	1200	11	24 614 0530	35340-MM5-600
Cbr 1000 F	1000	92	24 614 0530	35340-MM5-600	Vfr 1200 F Abs	1200	12	24 614 0530	35340-MM5-600
Cbr 1000 F Dual Cbs	1000	93	24 614 0530	35340-MM5-600	Cb 1300 A Super Four	1300	07	24 614 0530	35340-MM5-600
Cbr 1000 F Dual Cbs	1000	94	24 614 0530	35340-MM5-600	Cb 1300 A Super Four	1300	08	24 614 0530	35340-MM5-600
Cbr 1000 F Dual Cbs	1000	95	24 614 0530	35340-MM5-600	Cb 1300 A Super Four	1300	09	24 614 0530	35340-MM5-600
Cbr 1000 F Dual Cbs	1000	96	24 614 0530	35340-MM5-600	Cb 1300 A Super Four	1300	05-06	24 614 0530	35340-MM5-600
Cbr 1000 F Dual Cbs	1000	97-98	24 614 0530	35340-MM5-600	Cb 1300 F Super Four	1300	03-04	24 614 0530	35340-MM5-600
Cbr 1000 F Dual Cbs	1000	99-00	24 614 0530	35340-MM5-600	Cb 1300 Sa Super Four Abs	1300	07	24 614 0530	35340-MM5-600
Cbx 1000 Pro Link	1000	81	24 614 0530	35340-MM5-600	Cb 1300 Sa Super Four Abs	1300	08	24 614 0530	35340-MM5-600
Cbx 1000 Pro Link	1000	82-83	24 614 0530	35340-MM5-600	Cb 1300 Sa Super Four Abs	1300	09	24 614 0530	35340-MM5-600
GL 1000 K Goldwing	1000	78	24 614 0520	35350-292-003	Cb 1300 Sa Super Four Abs	1300	10-13	24 614 0530	35340-MM5-600
GL 1000 Z Goldwing	1000	79	24 614 0520	35350-292-003	Cb 1300 Sa Super Four Abs	1300	05-06	24 614 0530	35340-MM5-600
Vtr 1000 F Fire Storm	1000	00	24 614 0530	35340-MM5-600	Cb 1300 Super Four	1300	05	24 614 0530	35340-MM5-600
Vtr 1000 F Fire Storm	1000	01	24 614 0530	35340-MM5-600	Cb-X4 1300 Dc	1300	97	24 614 0530	35340-MM5-600
Vtr 1000 F Fire Storm	1000	02	24 614 0530	35340-MM5-600	Cb-X4 1300 Dc	1300	98	24 614 0530	35340-MM5-600
Vtr 1000 F Fire Storm	1000	05	24 614 0530	35340-MM5-600	Cb-X4 1300 Dc	1300	99	24 614 0530	35340-MM5-600
Vtr 1000 F Fire Storm	1000	06	24 614 0530	35340-MM5-600	St 1300 A Pan European Abs	1300	08	24 614 0530	35340-MM5-600
Vtr 1000 F Fire Storm	1000	97	24 614 0530	35340-MM5-600	St 1300 A Pan European Abs	1300	09-13	24 614 0530	35340-MM5-600
Vtr 1000 F Fire Storm	1000	98	24 614 0530	35340-MM5-600	St 1300 A Pan European Abs	1300	02-03	24 614 0530	35340-MM5-600
Vtr 1000 F Fire Storm	1000	99	24 614 0530	35340-MM5-600	St 1300 A Pan European Abs	1300	04-05	24 614 0530	35340-MM5-600
Vtr 1000 F Fire Storm	1000	03-04	24 614 0530	35340-MM5-600	St 1300 A Pan European Abs	1300	06-07	24 614 0530	35340-MM5-600
Vtr 1000 Sp1	1000	00	24 614 0530	35340-MM5-600	St 1300 Pan European	1300	08	24 614 0530	35340-MM5-600
Vtr 1000 Sp1	1000	01	24 614 0530	35340-MM5-600	St 1300 Pan European	1300	02-03	24 614 0530	35340-MM5-600
Vtr 1000 Sp2	1000	02	24 614 0530	35340-MM5-600	St 1300 Pan European	1300	04-05	24 614 0530	35340-MM5-600
Vtr 1000 Sp2	1000	03	24 614 0530	35340-MM5-600	St 1300 Pan European	1300	06-07	24 614 0530	35340-MM5-600
Vtr 1000 Sp2	1000	04	24 614 0530	35340-MM5-600	Vt 1300 Cx	1300	10-16	24 614 0530	35340-MM5-600
Vtr 1000 Sp2	1000	05	24 614 0530	35340-MM5-600	Vt 1300 Cxa Abs	1300	10-12	24 614 0530	35340-MM5-600
Vtr 1000 Sp2	1000	06	24 614 0530	35340-MM5-600	Vt 1300 Cxa Abs	1300	13-15	24 614 0530	35340-MM5-600
XL 1000 V Varadero	1000	00	24 614 0530	35340-MM5-600	Vtx 1300 S	1300	03	24 614 0530	35340-MM5-600
XL 1000 V Varadero	1000	01	24 614 0530	35340-MM5-600	Vtx 1300 S	1300	04	24 614 0530	35340-MM5-600
XL 1000 V Varadero	1000	02	24 614 0530	35340-MM5-600	Vtx 1300 S	1300	05	24 614 0530	35340-MM5-600
XL 1000 V Varadero	1000	04	24 614 0530	35340-MM5-600	Vtx 1300 S	1300	06	24 614 0530	35340-MM5-600
XL 1000 V Varadero	1000	05	24 614 0530	35340-MM5-600	Vtx 1300 S	1300	07	24 614 0530	35340-MM5-600
XL 1000 V Varadero	1000	06	24 614 0530	35340-MM5-600	GL 1500 C Valkyrie F6c	1500	00	24 614 0530	35340-MM5-600
XL 1000 V Varadero	1000	07	24 614 0530	35340-MM5-600	GL 1500 C Valkyrie F6c	1500	01	24 614 0530	35340-MM5-600
XL 1000 V Varadero	1000	08	24 614 0530	35340-MM5-600	GL 1500 C Valkyrie F6c	1500	97	24 614 0530	35340-MM5-600
XL 1000 V Varadero	1000	09	24 614 0530	35340-MM5-600	GL 1500 C Valkyrie F6c	1500	98	24 614 0530	35340-MM5-600
XL 1000 V Varadero	1000	10	24 614 0530	35340-MM5-600	GL 1500 C Valkyrie F6c	1500	99	24 614 0530	35340-MM5-600
XL 1000 V Varadero	1000	99	24 614 0530	35340-MM5-600	GL 1500 C Valkyrie F6c	1500	02-03	24 614 0530	35340-MM5-600
XL 1000 V Varadero	1000	11-13	24 614 0530	35340-MM5-600	KAWASAKI				
XL 1000 Va Varadero Abs	1000	04	24 614 0530	35340-MM5-600	Bn Eliminator A3-A5	125	00-02	24 614 0610	270101170
XL 1000 Va Varadero Abs	1000	05	24 614 0530	35340-MM5-600	Bn Eliminator A6-A8	125	03-05	24 614 0610	270100025
XL 1000 Va Varadero Abs	1000	06	24 614 0530	35340-MM5-600	Bn Eliminator A6f-A7f	125	06-07	24 614 0610	270100025
XL 1000 Va Varadero Abs	1000	07	24 614 0530	35340-MM5-600	Klx Caf-Cbf-Ccf-Ccs-Cdf	125	10-13	24 614 0610	270100025
XL 1000 Va Varadero Abs	1000	08	24 614 0530	35340-MM5-600	Klx Cds-Cef-Cff-Cgf	125	13-16	24 614 0610	270100025
XL 1000 Va Varadero Abs	1000	09	24 614 0530	35340-MM5-600	Klx D-Tracker Daf-Dbf-Dcf-Ddf-Def	125	10-14	24 614 0610	270100025
XL 1000 Va Varadero Abs	1000	10	24 614 0530	35340-MM5-600	Klx150l Eef	150	14	24 614 0610	270100025
XL 1000 Va Varadero Abs	1000	11-13	24 614 0530	35340-MM5-600	El F2	250	96-98	24 614 0610	270101170
Cbr 1100 Xx Super Blackbird	1100	00	24 614 0530	35340-MM5-600	El F5	250	01	24 614 0610	270101170
Cbr 1100 Xx Super Blackbird	1100	01	24 614 0530	35340-MM5-600	El F6	250	03	24 614 0610	270101170
Cbr 1100 Xx Super Blackbird	1100	02	24 614 0530	35340-MM5-600	Klr D4-D5-D6	250	87-89	24 614 0570	270101056
Cbr 1100 Xx Super Blackbird	1100	03	24 614 0530	35340-MM5-600	Klr D4-D5-D6	250	87-89	24 614 0580	270101019



INTERRUTTORI STOP BRAKE LIGHT SWITCHES

Modello - Model	Cc	Anno Year	Codice RMS RMS Code	Rifer. Originale Oem Number	Modello - Model	Cc	Anno Year	Codice RMS RMS Code	Rifer. Originale Oem Number
Klx E1-E3	250	93-95	24 614 0610	270101170	Ninja Zx-6Rr M1h	600	04	24 614 0610	270101170
Klx S9f-Saf-Sbf-Scf-Sdf	250	09-13	24 614 0610	270100025	Ninja Zx-6Rr N1h	600	05	24 614 0610	270100025
Klx Sef-Sff-Sgf	250	14-16	24 614 0610	270100025	Zl Eliminator B1	600	95-97	24 614 0610	270101170
Klx Shf	250	17	24 614 0610	270100025	Zzr D1	600	90	24 614 0610	270101170
Ksf A10-A11-A12-A13-A14	250	96-00	24 614 0610	270101170	Zzr D2-D2a-D3	600	91-92	24 614 0610	270101170
Ninja 250R K8f-K9f-K9fa-Kaf	250	08-10	24 614 0610	270101170	Zzr E10	600	02	24 614 0610	270101170
Ninja 250R KbF-Kbfa-Kcf	250	11-12	24 614 0610	270101170	Zzr E11	600	03	24 614 0610	270101170
Ninja SL Abs Bff-Bfs-Bfsa-Bgf-Bgfa	250	15-16	24 614 0610	270101170	Zzr E12h-E13h	600	04-05	24 614 0610	270100025
Ninja SL Aff-Afs-Afsa-Agf-Agfa	250	15-16	24 614 0610	270101170	Zzr E1-E3	600	93-95	24 614 0610	270101170
Z250sl Abs Fff-Ffs-Fgf	250	15-16	24 614 0610	270101170	Zzr E4-E6	600	96-98	24 614 0610	270101170
Z250sl Abs Fhf	250	17	24 614 0610	270101170	Zzr E6f	600	06	24 614 0610	270100025
Z250sl Eff-Efs-Egf	250	15-16	24 614 0610	270101170	Zzr E7-E9	600	99-01	24 614 0610	270101170
Zzr H10	250	99	24 614 0610	270101170	Ninja Zx-6R A1p	636	02	24 614 0610	270101170
Zzr H12-H13	250	01-02	24 614 0610	270101170	Ninja Zx-6R Abs Fdf-Fef-Fff-Fffa	636	13-15	24 614 0610	270100025
Zzr H14	250	03	24 614 0610	270101170	Ninja Zx-6R Abs Fgf-Fgfa	636	16	24 614 0610	270100025
Zzr H7-H8	250	96-98	24 614 0610	270101170	Ninja Zx-6R Abs Fhf	636	17	24 614 0610	270100025
Klf 4X4 C10-C11-C12-C13-C14	300	98-02	24 614 0610	270101170	Ninja Zx-6R B1h-B2h	636	03-04	24 614 0610	270101170
Klf B10-B11-B12-B13-B14	300	97-01	24 614 0610	270101170	Ninja Zx-6R C1h	636	05	24 614 0610	270100025
Ninja Abs Bdf-Bef-Befa-Bff-Bffa	300	13-15	24 614 0610	270101170	Ninja Zx-6R C6f	636	06	24 614 0610	270100025
Ninja 300 Abs Bgf-Bgfa	300	16	24 614 0610	270101170	Ninja Zx-6R Edf-Eef-Eff-Effa	636	13-15	24 614 0610	270100025
Ninja Adf-Aef-Aefa-Aff-Affa	300	13-15	24 614 0610	270101170	Ninja Zx-6R Egf-Egfa	636	16	24 614 0610	270100025
Ninja 300 Agf-Agfa	300	16	24 614 0610	270101170	Ej 650 (W650) A1	650	99-00	24 614 0610	270101170
Z300 Aff-Agf	300	15-16	24 614 0610	270101170	Ej 650 (W650) C3-C4	650	01-02	24 614 0610	270101170
Z300 Bff-Bgf Abs	300	15-16	24 614 0610	270101170	Ej 650 (W650) C5	650	03	24 614 0610	270101170
Kvf 2X4 B6f-B9f	360	06-09	24 614 0610	270100025	Ej 650 (W650) C6f	650	06	24 614 0610	270100025
Kvf 4X4 A6f-Aaf	360	06-10	24 614 0610	270100025	Ej 650 (W650) C6p-C7p	650	04-05	24 614 0610	270101170
Kvf 4X4 Abf-Acf-Adf	360	11-13	24 614 0610	270100025	Er-6F A6f-A8f	650	06-08	24 614 0610	270100025
Zxr H2	400	90	24 614 0610	270101170	Er-6F Abs B6f-B8f	650	06-08	24 614 0610	270100025
Zxr L1-L3	400	91-93	24 614 0610	270101170	Er-6F Abs D9f-Daf-Dbf	650	09-11	24 614 0610	270100025
Zxr L4-L8	400	94-98	24 614 0610	270101170	Er-6F Abs Fcf-Fds-Fef-Fff-Fgf	650	12-16	24 614 0610	270100025
Zxr L9	400	99	24 614 0610	270101170	Er-6F C9f-Caf-Cbf	650	09-11	24 614 0610	270100025
Kfx R B8f-B9f-B9fa-Baf-Bbf	450	08-11	24 614 0610	270100025	Er-6F Ecf-Eds-Eef-Eff-Egf	650	12-16	24 614 0610	270100025
Kfx R Bcs-Bdf-Bef	450	12-14	24 614 0610	270100025	Er-6N A6s-A8f	650	06-08	24 614 0610	270100025
En A3-A4	500	92-93	24 614 0610	270101170	Er-6N Abs B6f-B8f	650	06-08	24 614 0610	270100025
En B1-B2	500	94-95	24 614 0610	270101170	Er-6N Abs D9f-Daf-Dbf	650	09-11	24 614 0610	270100025
En C1-C5	500	96-00	24 614 0610	270101170	Er-6N Abs Fcf-Fds-Fef-Fff-Fgf	650	12-16	24 614 0610	270100025
En C6-C7	500	01-02	24 614 0610	270101170	Er-6N C9f-Caf-Cbf	650	09-11	24 614 0610	270100025
En C8	500	03	24 614 0610	270101170	Er-6N Ecf-Eds-Eef-Eff-Egf	650	12-16	24 614 0610	270100025
Er-5 A1-A4	500	97-00	24 614 0610	270101170	Kl A1-A3	650	87-89	24 614 0580	270101019
Er-5 C1-C3	500	01-03	24 614 0610	270101170	Kl A1-A3	650	87-89	24 614 0610	270101170
Er-5 C4p-C5p	500	04-05	24 614 0610	270101170	Kl Tengai B1-B3	650	89-91	24 614 0580	270101019
Gpz S B1-B4	500	88-91	24 614 0580	270101019	Kle Versys A7f-A8f-A9f	650	07-09	24 614 0610	270100025
Gpz S B1-B4	500	88-91	24 614 0610	270101170	Kle Versys Abs B7f-B8f-B9f	650	07-09	24 614 0610	270100025
Gpz S B5	500	92-93	24 614 0580	270101019	Kle Versys Abs Daf	650	10	24 614 0610	270100025
Gpz S B5	500	92-93	24 614 0610	270101170	Kle Versys Abs Dbf-Dcf-Ddf-Def	650	11-14	24 614 0610	270100025
Gpz S E10	500	03	24 614 0610	270101170	Kle Versys Caf	650	10	24 614 0610	270100025
Gpz S E1-E4	500	94-97	24 614 0610	270101170	Kle Versys Cbf-Ccf-Cdf-Cef	650	11-14	24 614 0610	270100025
Gpz S E5-E7	500	98-00	24 614 0610	270101170	Klr C10	650	04	24 614 0610	270101170
Gpz S E9	500	02	24 614 0610	270101170	Klr C1-C5	650	95-99	24 614 0580	270101019
Gpz_s A1-A3	500	87-89	24 614 0580	270101019	Klr C1-C5	650	95-99	24 614 0610	270101170
Gpz_s A1-A3	500	87-89	24 614 0610	270101170	Klr C7-C8	650	01-02	24 614 0580	270101019
Kle A11-A12	500	01-02	24 614 0610	270101170	Klr C7-C8	650	01-02	24 614 0610	270101170
Kle A13	500	03-04	24 614 0610	270101170	Klr C9	650	03	24 614 0610	270101170
Kle A1-A4	500	91-94	24 614 0610	270101170	Klx C1-C3	650	93-95	24 614 0610	270101170
Kle A5-A9	500	95-99	24 614 0610	270101170	Kvf 4X4 Brute Force D6f-Daf	650	06-10	24 614 0610	270100025
Kle B1p	500	05	24 614 0610	270100025	Kvf 4X4 Dbf	650	11	24 614 0610	270100025
Kle B6f-B7f	500	06-07	24 614 0610	270100025	Kvf 4X4 Fcf-Fcs-Fdf	650	12-13	24 614 0610	270100025
Gpz A1-A2	550	84-85	24 614 0570	270101056	Kvf Brute Force 4X4i Fef	650	14	24 614 0610	270100025
Gpx R C1-C3	600	88-90	24 614 0610	270101170	Kfx A6f-A9f-Abf	700	06-11	24 614 0610	270100025
Gpz R A3-A4	600	87-88	24 614 0610	270101170	Gpx R F1-F3	750	87-89	24 614 0610	270101170
Klr B6-B9	600	91-94	24 614 0580	270101019	Kvf 4X4 Eps Gcf-Gcs-Gdf	750	12-13	24 614 0610	270100025
Klr B6-B9	600	91-94	24 614 0610	270101170	Kvf 4X4 Eps Hcs-Hdf Camouflage	750	12-13	24 614 0610	270100025
Ninja Zx-6R F1-F3	600	95-97	24 614 0610	270101170	Kvf 4X4 Lcf-Lcs	750	12	24 614 0610	270100025
Ninja Zx-6R G1-G2	600	98-99	24 614 0610	270101170	Kvf 4X4i Brute Force D8f-Dbf	750	08-11	24 614 0610	270100025
Ninja Zx-6R J1p-J2p	600	00-01	24 614 0610	270101170	Kvf Brute Force 4X4i Eps Camo Hff-Hjf	750	15-18	24 614 0610	270100025
Ninja Zx-6R P7f-P8f	600	07-08	24 614 0610	270100025	Kvf Brute Force 4X4i Eps Gef	750	14	24 614 0610	270100025
Ninja Zx-6R R9f-Raf-Rbf-Rcf-Rdf	600	09-13	24 614 0610	270100025	Kvf Brute Force 4X4i Eps Gff-Ggf-Ghf-Gjf	750	15-18	24 614 0610	270100025
Ninja Zx-6R Ref-Rff-Rgf	600	14-16	24 614 0610	270100025	Kvf Brute Force 4X4i Eps Hef	750	14	24 614 0610	270100025
Ninja Zx-6Rr K1h	600	03	24 614 0610	270101170	Ninja Zx-7R P1-P4	750	96-99	24 614 0610	270101170

INTERRUTTORI STOP

BRAKE LIGHT SWITCHES



Modello - Model	Cc	Anno Year	Codice RMS RMS Code	Rifer. Originale Oem Number	Modello - Model	Cc	Anno Year	Codice RMS RMS Code	Rifer. Originale Oem Number
Ninja Zx-7R P5-P7	750	00-02	24 614 0610	270101170	Ninja Zx-10R Jff-Jffa	1000	15	24 614 0610	270100025
Ninja Zx-7Rr N1	750	96-98	24 614 0610	270101170	Z1000 A1h-A3h	1000	03-05	24 614 0610	270100025
Z750 Abs M7f-Maf-Mas	750	07-10	24 614 0610	270100025	Z1000 A6f	1000	06	24 614 0610	270100025
Z750 Abs MbF-Mcf	750	11-12	24 614 0610	270100025	Z1000 Abs C7f-C9f	1000	07-09	24 614 0610	270100025
Z750 J1h-J2h	750	04-05	24 614 0610	270101170	Z1000 Abs Eaf-Ebf-Ecf-Ecfa	1000	10-12	24 614 0610	270100025
Z750 J6f	750	06	24 614 0610	270100025	Z1000 Abs Edf-Edfa	1000	13	24 614 0610	270100025
Z750 L7f-Laf-Las	750	07-10	24 614 0610	270100025	Z1000 Abs Gef-Gefa-Gff-Ggf	1000	14-16	24 614 0610	270100025
Z750 Lbf-Lcf	750	11-12	24 614 0610	270100025	Z1000 B7f-B9f	1000	07-09	24 614 0610	270100025
Z750r Abs Pbf-Pcf	750	11-12	24 614 0610	270100025	Z1000 Daf-Das-Dbf-Dcf-Dcfa	1000	10-12	24 614 0610	270100025
Z750r Nbf-Ncf	750	11-12	24 614 0610	270100025	Z1000 Ddf-Ddfa	1000	13	24 614 0610	270100025
Z750s K1h	750	05	24 614 0610	270100025	Z1000 Fef-Fefa-Fff-Fgf	1000	14-16	24 614 0610	270100025
Z750s K6f	750	06	24 614 0610	270100025	Z1000sx Abs Hbf-Hcf-Hdf	1000	11-13	24 614 0610	270100025
Zr Zephyr C1-C4	750	91-94	24 614 0610	270101170	Z1000sx Abs Mef-Mff-Mgf	1000	14-16	24 614 0610	270100025
Zr-7 F1	750	99	24 614 0610	270101170	Z1000sx Abs Whf	1000	17	24 614 0610	270100025
Zr-7 F3	750	01	24 614 0610	270101170	Z1000sx Gbf-Gcf-Gdf	1000	11-13	24 614 0610	270100025
Zr-7 F5	750	03	24 614 0610	270101170	Z1000sx Lef-Lf-Lgf	1000	14-16	24 614 0610	270100025
Zr-7S H1-H3	750	01-03	24 614 0610	270101170	Zx 10 B1-B3	1000	88-90	24 614 0610	270101170
Zxr H1 Stinger	750	89	24 614 0610	270101170	Gpz E1-E2	1100	95-97	24 614 0610	270101170
Zxr H2 Stinger	750	90	24 614 0610	270101170	Zr Zephyr A1-A4	1100	92-95	24 614 0610	270101170
Zxr J1-J2	750	91-92	24 614 0610	270101170	Zrx D1-D3	1100	97-99	24 614 0610	270101170
Zxr L1-L3	750	93-95	24 614 0610	270101170	Zzr C1-C2	1100	90-91	24 614 0610	270101170
Zxr R K1	750	91	24 614 0610	270101170	Zzr C3	1100	92	24 614 0610	270101170
Zxr R M1-M2	750	93-94	24 614 0610	270101170	Zzr D1-D2	1100	93-94	24 614 0610	270101170
Ej (W800) Abf-Abs-Acf-Acfa	800	11-12	24 614 0610	270100025	Zzr D3-D4	1100	95-96	24 614 0610	270101170
Ej (W800) Aff-Affa-Agf-Agfa-Ags	800	15-16	24 614 0610	270100025	Zzr D5-D6	1100	97-98	24 614 0610	270101170
Vn A1-A4	800	95-98	24 614 0610	270101170	Zzr D7	1100	99	24 614 0610	270101170
Vn Classic B10p	800	05	24 614 0610	270101170	Ninja Zx-12R A1h	1200	00	24 614 0610	270101170
Vn Classic B1-B4	800	96-99	24 614 0610	270101170	Ninja Zx-12R A2h	1200	01	24 614 0610	270101170
Vn Classic B5-B7	800	00-02	24 614 0610	270101170	Ninja Zx-12R B1h-B4h	1200	02-05	24 614 0610	270100025
Vn Classic B6f	800	06	24 614 0610	270100025	Ninja Zx-12R B1h-B4h	1200	02-05	24 614 0610	270101170
Vn Classic B8	800	03	24 614 0610	270101170	Ninja Zx-12R B6f	1200	06	24 614 0610	270100025
Vn Classic B9p	800	04	24 614 0610	270101170	Zrx C1p-C2p	1200	01-03	24 614 0610	270101170
Vn Drifter C1-C2	800	99-01	24 614 0610	270101170	Zrx C3h	1200	04	24 614 0610	270101170
Z800 Abs Bds-Bef-Bff-Bgf	800	13-16	24 614 0610	270100025	Zrx R A1p-A3p	1200	01-03	24 614 0610	270101170
Z800 Ads-Aef-Aff-Agf	800	13-16	24 614 0610	270100025	Zrx R A4h-A5h	1200	04-05	24 614 0610	270100025
Z E Abs Dds-Def-Dff-Dgf-Dgfa	800	13-16	24 614 0610	270100025	Zrx R A6f	1200	06	24 614 0610	270100025
Z E Abs Special Edition Fgf	800	16	24 614 0610	270100025	Zrx S B1p-B3p	1200	01-03	24 614 0610	270101170
Z800 E Cds-Cef-Cff-Cgf-Cgfa	800	13-16	24 614 0610	270100025	Zrx S B4h	1200	04	24 614 0610	270101170
Z800 E Special Edition Egf	800	16	24 614 0610	270100025	Zzr C1h-C2h	1200	02-03	24 614 0610	270101170
Ninja Zx-9R B1-B3	900	94-96	24 614 0610	270101170	Zzr C4h	1200	05	24 614 0610	270100025
Ninja Zx-9R B4	900	97	24 614 0610	270101170	Gtr A8f-A9f	1400	08-09	24 614 0610	270100025
Ninja Zx-9R C1-C2	900	98-99	24 614 0610	270101170	Gtr Caf-Cbf-Ccf-Cdf-Cef	1400	10-14	24 614 0610	270100025
Ninja Zx-9R E1p-E2p	900	00-01	24 614 0610	270101170	Zzr A6f-A7f	1400	06-07	24 614 0610	270100025
Ninja Zx-9R Euro2 F1p-F2p	900	02-03	24 614 0610	270101170	Zzr Abs B6f-B7f	1400	06-07	24 614 0610	270100025
Ninja Zx-9R F1h-F2h	900	02-03	24 614 0610	270101170	Zzr Abs D8f-Dbf	1400	08-11	24 614 0610	270100025
Vn Classic B6f-Baf	900	06-10	24 614 0610	270100025	Zzr Abs Fcf-Fdf-Fdfa-Fef-Fefb	1400	12-14	24 614 0610	270100025
Vn Classic Bbf-Bbfa-Bcf-Bcfa	900	11-12	24 614 0610	270100025	Zzr Abs Fff-Fffa	1400	15	24 614 0610	270100025
Vn Classic Bdf-Bef-Bdfa-Befa	900	13-14	24 614 0610	270100025	Vn Classic D1-D2	1500	96-97	24 614 0610	270101170
Vn Custom C7f-C8f-C9fa-Caf-Cbf	900	07-11	24 614 0610	270100025	Vn Classic E1	1500	98	24 614 0610	270101170
Vn Vulcan Classic Bff-Bffa-Bgf-Bgfa	900	15-16	24 614 0610	270100025	Vn Classic E2	1500	99	24 614 0610	270101170
Vn Vulcan Custom Ccfa-Cdf-Cefa-Cffa	900	12-15	24 614 0610	270100025	Vn Classic Fi N1h-N3h	1500	00-02	24 614 0610	270101170
Vn Vulcan Custom Cgf	900	16	24 614 0610	270100025	Vn Classic Tourer Fi L2h-L4h	1500	01-03	24 614 0610	270101170
Z900 Abs Bhf	900	17	24 614 0610	270100025	Vn Classic Tourer G1-G2	1500	98-99	24 614 0610	270101170
Gpz Rx A1-A3	1000	86-88	24 614 0580	270101019	Vn Classic Tourer L1h	1500	00	24 614 0610	270101170
Gpz Rx A1-A3	1000	86-88	24 614 0610	270101170	Vn Drifter J1	1500	99-00	24 614 0610	270101170
Gtr A11	1000	96-97	24 614 0580	270101019	Vn Main Streak P1h-P2h	1500	02-03	24 614 0610	270101170
Gtr A11	1000	96-97	24 614 0610	270101170	Vn Classic A1h-A3h	1600	03-05	24 614 0610	270100025
Gtr A18	1000	03	24 614 0610	270101170	Vn Classic A1h-A3h	1600	03-05	24 614 0610	270101170
Klz Versys Acf-Adf-Aef	1000	12-14	24 614 0610	270100025	Vn Classic A6f	1600	06	24 614 0610	270100025
Klz Versys Bff-Bgf	1000	15-16	24 614 0610	270100025	Vn Classic Tourer D1h	1600	05	24 614 0610	270100025
Klz Versys Bhf	1000	17	24 614 0610	270100025	Vn Classic Tourer D6f	1600	06	24 614 0610	270100025
Ninja Zx-10R Abs Kbf-Kcf-Kdf-Kef	1000	11-14	24 614 0610	270100025	Vn Mean Streak B1h-B2h	1600	04-05	24 614 0610	270100025
Ninja Zx-10R Abs Kff-Kffa	1000	15	24 614 0610	270100025	Vn Mean Streak B6f-B7f	1600	06-07	24 614 0610	270100025
Ninja Zx-10R C1h	1000	04	24 614 0610	270101170	Vn Classic Abs Faf-Fbf-Fcf-Fdf-Fef	1700	10-14	24 614 0610	270100025
Ninja Zx-10R C2h	1000	05	24 614 0610	270100025	Vn Classic E9f	1700	09	24 614 0610	270100025
Ninja Zx-10R D6f-D7f	1000	06-07	24 614 0610	270100025	Vn A1h-A2h	2000	04-05	24 614 0610	270100025
Ninja Zx-10R E8f-E9f	1000	08-09	24 614 0610	270100025	Vn A1h-A2h	2000	04-05	24 614 0610	270101170
Ninja Zx-10R Faf	1000	10	24 614 0610	270100025	Vn A6f	2000	06	24 614 0610	270100025
Ninja Zx-10R Jbf-Jcf-Jdf-Jef	1000	11-14	24 614 0610	270100025	Vn Classic H8f-H9f-Haf	2000	08-10	24 614 0610	270100025



INTERRUTTORI STOP BRAKE LIGHT SWITCHES

Modello - Model	Cc	Anno Year	Codice RMS RMS Code	Rifer. Originale Oem Number
MALAGUTI				
Centro Base	50	93-94	24 614 0050	01714000
Centro SL	50	94-98	24 614 0050	01714000
Centro SL Kat	50	99-00	24 614 0050	01714000
Ciak	50	99-00	24 614 0050	01714000
Ciak Master	50	04	24 614 0050	01714000
Ciak Master 4T	50	05-06	24 614 0050	01714000
Ciak Master Eu2	50	06	24 614 0050	01714000
Ciak Mono Eu2	50	03	24 614 0050	01714000
Ciak Mono Eu2-2.3	50	03	24 614 0050	01714000
Ciak Td	50	00-01	24 614 0050	01714000
Crosser Cr1	50	95-98	24 614 0050	01714000
F10 Jet Line	50	92-98	24 614 0050	01714000
F10 Kat	50	99-00	24 614 0050	01714000
F10 Restyling Eu1	50	01-02	24 614 0050	01714000
F10 Restyling Eu2-2.3	50	03-04	24 614 0050	01714000
F10 Restyling Eu2	50	02-03	24 614 0050	01714000
F10 Restyling Eu2	50	06	24 614 0050	01714000
F12 Aria Restyling Eu2	50	06	24 614 0050	01714000
F12 Lc Restyling Eu2	50	06	24 614 0050	01714000
F12 Phantom	50	94-98	24 614 0050	01714000
F12 Phantom Eu1	50	99-00	24 614 0050	01714000
F12 Phantom Lc	50	94-98	24 614 0050	01714000
F12 Phantom Lc Eu1	50	99-00	24 614 0050	01714000
F12 Phantom Lc Restyling Eu1	50	01-02	24 614 0050	01714000
F12 Phantom Lc Restyling Eu2	50	02	24 614 0050	01714000
F12 Phantom Lc Restyling Eu2-2.3	50	03-04	24 614 0050	01714000
F12 Phantom Lc Twin Disks	50	98	24 614 0050	01714000
F12 Phantom Restyling Eu1	50	01-02	24 614 0050	01714000
F12 Phantom Restyling Eu2	50	02	24 614 0050	01714000
F12 Phantom Restyling Eu2-2.3	50	03-04	24 614 0050	01714000
F12r Phantom Ac	50	07-08	24 614 0050	01714000
F12r Phantom Lc	50	07-10	24 614 0050	01714000
F15 Fire Fox	50	96-98	24 614 0050	01714000
F15 Fire Fox Air Cooled	50	05-06	24 614 0050	01714000
F15 Fire Fox Eu2	50	02-03	24 614 0050	01714000
F15 Fire Fox Restyling Eu2-2.3	50	03-04	24 614 0050	01714000
F15 Fire Fox Twin Disks & Special	50	98-99	24 614 0050	01714000
F15 Fire Fox Twin Disks Digit Kat	50	98-00	24 614 0050	01714000
F15 Lc Restyling Eu2	50	04-05	24 614 0050	01714000
F15 Lc-Tds Restyling Eu1	50	01	24 614 0050	01714000
Yesterday - Yesterday Eu	50	97-00	24 614 0050	01714000
Ciak	100	99-00	24 614 0050	01714000
F12 Phantom	100	99-00	24 614 0050	01714000
Ciak	125	00-01	24 614 0050	01714000
Ciak Master	125	04	24 614 0050	01714000
Ciak Master Eu3	125	06	24 614 0050	01714000
Ciak Restyling Eu2	125	03	24 614 0050	01714000
Ciak	150	00-02	24 614 0050	01714000
Ciak Master	150	04	24 614 0050	01714000
Ciak Restyling Eu2	150	03	24 614 0050	01714000
Ciak Master Eu2	200	06	24 614 0050	01714000
MBK				
Cw Booster	50	01-02	24 614 0030	5SEH253N0100
Cw Booster	50	01-02	24 614 0030	NM5839801000
Cw Booster	50	90-91	24 614 0040	5ADH39800100
Cw Booster (Ita)	50	92-94	24 614 0040	5ADH39800100
Cw Booster Spirit	50	96-98	24 614 0040	5ADH39800100
Cw Booster Spirit (Ita)	50	00	24 614 0040	5XLH39800000
Cw Booster Spirit (Ita)	50	00	24 614 0030	5SEH253N0100
Cw Booster Spirit (Ita)	50	99	24 614 0040	5ADH39800100
Cw Booster Spirit Eu2	50	02	24 614 0030	NM5839801000
Cw Booster Spirit Eu2	50	03	24 614 0030	NM5839801000
Cw L Booster	50	01-03	24 614 0030	5SEH253N0100
Cw L Booster Spirit	50	03	24 614 0030	NM5839801000
Cw R Booster Road (Ita)	50	94-95	24 614 0040	5ADH39800100
Cw Rs Booster Ng	50	01-02	24 614 0030	5SEH253N0100
Cw Rs Booster Ng (Ita)	50	99	24 614 0040	5ADH39800100
Cw Rs Booster Ng (Ita)	50	95-98	24 614 0040	5ADH39800100

Modello - Model	Cc	Anno Year	Codice RMS RMS Code	Rifer. Originale Oem Number
Cw Rs Booster Ng Eu1	50	99-00	24 614 0030	5SEH253N0100
Cw Rsp Booster Rocket (Ita)	50	97-98	24 614 0040	5XLH39800000
Cw Rsp Booster Track (Ita)	50	96-98	24 614 0040	5XLH39800000
Cw Sp Booster Spirit Eu2	50	02	24 614 0030	5SEH253N0100
Ew Stunt	50	00-02	24 614 0030	5SEH253N0100
Ya R Forte (Che-Ita)	50	94-96	24 614 0040	5XLH39800000
Ye Evolis (Ita)	50	92-93	24 614 0040	5ADH39800100
Ye Evolis (Ita)	50	94-95	24 614 0040	5ADH39800100
Yh Flipper	50	98	24 614 0040	5ADH39800100
Yh Flipper	50	01-02	24 614 0030	NM5839801000
Yh Flipper Catalitico	50	99-00	24 614 0030	5SEH253N0100
Yh Flipper Eu2	50	03-04	24 614 0030	5SEH253N0100
Ym Fizz (Ita)	50	94-95	24 614 0040	5ADH39800100
Yn R Ovetto (Che-Ita)	50	97-01	24 614 0040	5XLH39800000
Yn R Ovetto (Che-Ita)	50	97-01	24 614 0030	5SEH253N0100
Yn R Ovetto Eu1	50	02-04	24 614 0040	5XLH39800000
Yn R Ovetto Eu2	50	02-03	24 614 0040	5XLH39800000
Yq Nitro	50	01-02	24 614 0030	5SEH253N0100
Yq Nitro (Ita)	50	97-98	24 614 0040	5ADH39800100
Yq Nitro (Ita)	50	99-00	24 614 0040	5ADH39800100
Yq Nitro Eu2	50	03	24 614 0030	NM5839801000
Yn Ovetto	100	00-02	24 614 0040	5XLH39800000
Yn Ovetto	100	00-02	24 614 0030	5SEH253N0100
Yq Nitro	100	00-02	24 614 0030	NM5839801000
Xn Doodo	125	00-01	24 614 0030	NM5839801000
Xq Thunder	125	01-02	24 614 0030	NM5839801000
Yp E Skyliner	125	03	24 614 0040	5XLH39800000
Yp Skyliner	125	01-02	24 614 0040	5ADH39800100
Yp Skyliner	125	98-00	24 614 0040	5XLH39800000
Xn Doodo	150	01-02	24 614 0030	NM5839801000
Xq Thunder	150	01-02	24 614 0030	NM5839801000
Yp Skyliner	150	00	24 614 0040	5ADH39800100
Yp Skyliner	150	01-02	24 614 0040	5ADH39800100
Yp E Skyliner	180	03	24 614 0040	5XLH39800000
PEUGEOT				
Peugeot Buxy	50	95-97	24 614 0630	743154
Peugeot Buxy	50	95-97	24 614 0640	743154
Peugeot Elyseo 45 Km/H	50	02-03	24 614 0630	743154
Peugeot Elyseo 45 Km/H	50	02-03	24 614 0640	743154
Peugeot Elyseo Km/H	50	98-01	24 614 0630	743154
Peugeot Elyseo Km/H	50	98-01	24 614 0640	743154
Peugeot Elystar Advantage	50	06-09	24 614 0630	743154
Peugeot Elystar Advantage	50	06-09	24 614 0640	743154
Peugeot Fox L	50	95-97	24 614 0630	743154
Peugeot Fox L	50	95-97	24 614 0640	743154
Peugeot Jet Force	50	05-15	24 614 0630	743154
Peugeot Jet Force	50	05-15	24 614 0640	743154
Peugeot Looxor	50	02-06	24 614 0630	743154
Peugeot Looxor	50	02-06	24 614 0640	743154
Peugeot Ludix	50	04-12	24 614 0630	743154
Peugeot Ludix	50	04-12	24 614 0640	743154
Peugeot Rapido St	50	85-93	24 614 0630	743154
Peugeot Rapido St	50	85-93	24 614 0640	743154
Peugeot Speedake	50	95-97	24 614 0630	743154
Peugeot Speedake	50	95-97	24 614 0640	743154
Peugeot Speedfight 1 Ac Dt	50	97-00	24 614 0630	743154
Peugeot Speedfight 1 Ac Dt	50	97-00	24 614 0640	743154
Peugeot Speedfight 1 Lc Dd	50	99-00	24 614 0630	743154
Peugeot Speedfight 1 Lc Dd	50	99-00	24 614 0640	743154
Peugeot Speedfight 1 Lc Dt	50	97-98	24 614 0630	743154
Peugeot Speedfight 1 Lc Dt	50	97-98	24 614 0640	743154
Peugeot Speedfight 2 Ac Dt	50	01-09	24 614 0630	743154
Peugeot Speedfight 2 Ac Dt	50	01-09	24 614 0640	743154
Peugeot Speedfight 2 Lc Dd	50	01-09	24 614 0630	743154
Peugeot Speedfight 2 Lc Dd	50	01-09	24 614 0640	743154
Peugeot Squab	50	96-97	24 614 0630	743154
Peugeot Squab	50	96-97	24 614 0640	743154
Peugeot Sv Lm Dt	50	97-98	24 614 0630	743154
Peugeot Sv Lm Dt	50	97-98	24 614 0640	743154

INTERRUITORI STOP

BRAKE LIGHT SWITCHES



Modello - Model	Cc	Anno Year	Codice RMS RMS Code	Rifer. Originale Oem Number	Modello - Model	Cc	Anno Year	Codice RMS RMS Code	Rifer. Originale Oem Number
Peugeot Sv Tt	50	93-97	24 614 0630	743154	Liberty 4T Ptt (Deu)	50	07-12	24 614 0161	583575
Peugeot Sv Tt	50	93-97	24 614 0640	743154	Liberty 4T Rst	50	04	24 614 0161	583575
Peugeot Sv Tt Junior	50	93-96	24 614 0630	743154	Liberty 4T Rst	50	04	24 614 0161	583575
Peugeot Sv Tt Junior	50	93-96	24 614 0640	743154	Liberty 4T Sport	50	06	24 614 0161	583575
Peugeot Tkr	50	08-11	24 614 0630	743154	Liberty 4T Sport	50	06	24 614 0161	583575
Peugeot Tkr	50	08-11	24 614 0640	743154	Liberty 4T Sport	50	07-08	24 614 0161	583575
Peugeot Vivacity	50	99-09	24 614 0630	743154	Liberty Ptt Eu2	50	04-05	24 614 0130	580953
Peugeot Vivacity	50	99-09	24 614 0640	743154	Nrg	50	94-96	24 614 0130	580953
Peugeot Zenith M	50	95-00	24 614 0630	743154	Nrg Extreme	50	99-00	24 614 0130	580953
Peugeot Zenith M	50	95-00	24 614 0640	743154	Nrg Mc3	50	01-04	24 614 0130	580953
Peugeot Sv	80	93-96	24 614 0630	743154	Nrg Power Dd	50	05	24 614 0161	583575
Peugeot Sv	80	93-96	24 614 0640	743154	Nrg Power Dd	50	06	24 614 0161	583575
Peugeot Elyseo	100	98-01	24 614 0630	743154	Nrg Power Dd	50	07-17	24 614 0161	583575
Peugeot Elyseo	100	98-01	24 614 0640	743154	Nrg Power Dd Serie Speciale	50	07-12	24 614 0161	583575
Peugeot Speedfight 1	100	98-00	24 614 0630	743154	Nrg Power Dt	50	06	24 614 0161	583575
Peugeot Speedfight 1	100	98-00	24 614 0640	743154	Nrg Power Dt	50	07-15	24 614 0161	583575
Peugeot Speedfight 2	100	01-07	24 614 0630	743154	Nrg Power Dt Serie Speciale	50	07-08	24 614 0161	583575
Peugeot Speedfight 2	100	01-07	24 614 0640	743154	Nrg Power Purejet	50	06	24 614 0161	583575
Peugeot Sv	100	98	24 614 0630	743154	Nrg Power Purejet	50	04-05	24 614 0161	583575
Peugeot Sv	100	98	24 614 0640	743154	Nrg Power Purejet	50	07-09	24 614 0161	583575
Peugeot Vivacity	100	99-07	24 614 0630	743154	Nrg Power Purejet	50	10-11	24 614 0161	583575
Peugeot Vivacity	100	99-07	24 614 0640	743154	Nrg Purejet	50	10	24 614 0161	583575
Peugeot Citystar le	125	10-17	24 614 0630	743154	Nrg Rst Mc2	50	96-98	24 614 0130	580953
Peugeot Citystar le	125	10-17	24 614 0640	743154	Ntt	50	95-96	24 614 0130	580953
Peugeot Elyseo Dd	125	01-03	24 614 0630	743154	Quartz	50	92-96	24 614 0130	580953
Peugeot Elyseo Dd	125	01-03	24 614 0640	743154	Sfera	50	91-93	24 614 0130	580953
Peugeot Elyseo Dt	125	98-00	24 614 0630	743154	Sfera Maquillage 2	50	94	24 614 0130	580953
Peugeot Elyseo Dt	125	98-00	24 614 0640	743154	Sfera Rst	50	95-97	24 614 0130	580953
Peugeot Geopolis le	125	07-12	24 614 0630	743154	Si Mix	50	96-99	24 614 0130	580953
Peugeot Geopolis le	125	07-12	24 614 0640	743154	Typhoon	50	01-04	24 614 0130	580953
Peugeot Jet Force le	125	03-07	24 614 0630	743154	Typhoon	50	05-08	24 614 0130	580953
Peugeot Jet Force le	125	03-07	24 614 0640	743154	Typhoon 2T Eu2	50	10-16	24 614 0161	583575
Peugeot Looxor	125	03-06	24 614 0630	743154	Velofax	50	96-99	24 614 0130	580953
Peugeot Looxor	125	03-06	24 614 0640	743154	Vespa 50 R	50	69-71	24 614 0080	181878
Peugeot Satelis 1 le	125	08-17	24 614 0630	743154	Vespa 50 S	50	63-68	24 614 0080	181878
Peugeot Satelis 1 le	125	08-17	24 614 0640	743154	Vespa 50 Special	50	75-83	24 614 0080	181878
Peugeot Sv	125	93-95	24 614 0630	743154	Vespa Et2	50	97-05	24 614 0130	580953
Peugeot Sv	125	93-95	24 614 0640	743154	Vespa Et2 Iniezione	50	97-00	24 614 0130	580953
Peugeot Sv L	125	96-97	24 614 0630	743154	Vespa Et4	50	00-05	24 614 0130	580953
Peugeot Sv L	125	96-97	24 614 0640	743154	Vespa FL	50	90	24 614 0090	181881
Peugeot Elyseo 1	150	01-03	24 614 0630	743154	Vespa FL2 Hp	50	91-97	24 614 0090	181881
Peugeot Elyseo 1	150	01-03	24 614 0640	743154	Vespa Lx 2T	50	05-08	24 614 0161	583575
PIAGGIO					Vespa Lx 4T	50	05-09	24 614 0161	583575
Ape	50	09-17	24 614 0130	580953	Vespa Lxv 2T	50	06-09	24 614 0130	580953
Ape FL3 Europa	50	96-99	24 614 0130	580953	Vespa N	50	89-90	24 614 0090	181881
Ape Mix 2T	50	98-08	24 614 0130	580953	Vespa Pk	50	82-84	24 614 0090	181881
Ape Rst Mix	50	99-03	24 614 0130	580953	Vespa Pk 50	50	82-84	24 614 0080	181878
Ciao Eu1	50	99-01	24 614 0130	580953	Vespa Pk XL	50	85-88	24 614 0090	181881
Ciao Eu2	50	02-04	24 614 0130	580953	Vespa Pk XL Rush	50	88-89	24 614 0090	181881
Ciao Mix Teen	50	96-01	24 614 0130	580953	Vespa S 2T & College	50	07-12	24 614 0161	583575
Fly 2T	50	05-07	24 614 0161	583575	Vespa S 4T-4V & College	50	08-12	24 614 0161	583575
Fly 2T	50	10-11	24 614 0161	583575	Zip	50	00-04	24 614 0130	580953
Fly 4T	50	05-07	24 614 0161	583575	Zip	50	92-93	24 614 0130	580953
Fly 4T & 25-30 Km/H	50	08-11	24 614 0161	583575	Zip	50	95-96	24 614 0130	580953
Fly 4T Motore Chn	50	06-07	24 614 0161	583575	Zip 2T	50	08-13	24 614 0130	580953
Free	50	92-94	24 614 0130	580953	Zip 4T	50	06-13	24 614 0130	580953
Free Delivery	50	00-01	24 614 0130	580953	Zip 4T	50	00-05	24 614 0130	580953
Free FL	50	95-02	24 614 0130	580953	Zip 4T 25Km-H	50	06-16	24 614 0130	580953
Liberty	50	97-05	24 614 0130	580953	Zip Bimodale	50	94-97	24 614 0130	580953
Liberty 2T	50	06	24 614 0161	583575	Zip Fast Raider	50	93-94	24 614 0130	580953
Liberty 2T	50	07-08	24 614 0161	583575	Zip Fast Raider Rst	50	96-97	24 614 0130	580953
Liberty 2T Rst	50	04	24 614 0161	583575	Zip Rst	50	96-99	24 614 0130	580953
Liberty 2T Sport	50	06	24 614 0161	583575	Zip Sp	50	01-04	24 614 0130	580953
Liberty 2T Sport	50	07-08	24 614 0161	583575	Zip Sp	50	96-00	24 614 0130	580953
Liberty 4T	50	05-08	24 614 0161	583575	Zip Sp Eu2	50	06-13	24 614 0130	580953
Liberty 4T	50	00-02	24 614 0130	580953	Skr City	80	99	24 614 0130	580953
Liberty 4T Delivery - Single	50	10-14	24 614 0161	583575	Vespa Pk 80 S	80	82	24 614 0080	181878
Liberty 4T Delivery Tnt	50	09	24 614 0161	583575	Fly 4T	100	08-14	24 614 0161	583575
Liberty 4T Ptt - Double - Nexive	50	09-17	24 614 0161	583575	Fly 4T	100	06-07	24 614 0161	583575



INTERRUTTORI STOP BRAKE LIGHT SWITCHES

Modello - Model	Cc	Anno Year	Codice RMS RMS Code	Rifer. Originale Oem Number	Modello - Model	Cc	Anno Year	Codice RMS RMS Code	Rifer. Originale Oem Number
Free	100	02-03	24 614 0130	580953	Vespa Px	125	11-17	24 614 0090	181881
Vespa 100	100	78-83	24 614 0080	181878	Vespa Px	125	98-01	24 614 0090	181881
Vespa Pk 100 S Elestart	100	83	24 614 0080	181878	Vespa Px	125	98-01	24 614 0130	580953
Zip 4T	100	06-10	24 614 0130	580953	Vespa Px 30 Anni	125	07-08	24 614 0090	181881
Beverly	125	01-03	24 614 0130	580953	Vespa Px Eu2	125	01-07	24 614 0090	181881
Beverly Eu3 Mic	125	07	24 614 0161	583575	Vespa Px Eu2	125	01-07	24 614 0130	580953
Beverly Eu3 Sport	125	07-08	24 614 0161	583575	Vespa Px T5	125	85-89	24 614 0090	181881
Beverly Rst	125	04-05	24 614 0161	583575	Vespa Pxe Arcobaleno	125	81-97	24 614 0090	181881
Beverly Rst	125	05-07	24 614 0161	583575	Vespa S 4T Eu3	125	07-08	24 614 0161	583575
Beverly Tourer Eu3	125	07-10	24 614 0161	583575	Vespa S 4T le & College	125	09-11	24 614 0161	583575
Carnaby	125	07-10	24 614 0161	583575	Vespa Super 125	125	66-68	24 614 0070	055316
Fly	125	05-07	24 614 0161	583575	Vespa Super 125	125	66-68	24 614 0110	181637
Fly Eu3	125	07	24 614 0161	583575	Vespa Ts 125	125	75-78	24 614 0070	055316
Fly Eu3	125	08-11	24 614 0161	583575	Vespa Ts 125	125	75-78	24 614 0110	181637
Hexagon	125	94-97	24 614 0130	580953	X8	125	04	24 614 0161	583575
Hexagon Gtx	125	00	24 614 0130	580953	X8	125	05-06	24 614 0161	583575
Hexagon Lx4	125	98-99	24 614 0130	580953	X8 Premium Eu2	125	06	24 614 0161	583575
Hexagon Lx-Lxt	125	98-99	24 614 0130	580953	X8 Street Eu2	125	06-07	24 614 0161	583575
Liberty	125	01-02	24 614 0130	580953	X9	125	01-02	24 614 0130	580953
Liberty	125	98-00	24 614 0130	580953	X9 Evolution	125	03	24 614 0161	583575
Liberty 4T	125	06-07	24 614 0161	583575	X9 Evolution	125	05-06	24 614 0161	583575
Liberty 4T 2V le Ptt - Ita	125	12-13	24 614 0161	583575	X9 Evolution Eu3	125	07	24 614 0161	583575
Liberty 4T Eu3	125	06-08	24 614 0161	583575	Zip	125	00-02	24 614 0130	580953
Liberty 4T Eu3 Delivery - Single	125	07-15	24 614 0161	583575	Fly	150	05-07	24 614 0161	583575
Liberty 4T Eu3 Delivery - Tnt - Nexive	125	08-15	24 614 0161	583575	Fly Eu3	150	08-11	24 614 0161	583575
Liberty 4T Sport Eu3	125	06-08	24 614 0161	583575	Liberty 4T Eu3	150	08	24 614 0161	583575
Liberty Rst	125	04-05	24 614 0161	583575	Liberty 4T Sport Eu3	150	08	24 614 0161	583575
Liberty Rst Ptt	125	05-11	24 614 0161	583575	Vespa 150	150	63-66	24 614 0070	055316
Liberty Sport	125	06	24 614 0161	583575	Vespa GL 150	150	63-64	24 614 0070	055316
Mp3	125	06-08	24 614 0161	583575	Vespa Lx	150	05-06	24 614 0161	583575
Mp3 Ibrido	125	09-10	24 614 0161	583575	Vespa Lx 4T FL	150	09	24 614 0161	583575
Mp3 le	125	08-09	24 614 0161	583575	Vespa Lx Eu3	150	06-08	24 614 0161	583575
Mp3 le Touring	125	11-12	24 614 0161	583575	Vespa P 150 S	150	78-84	24 614 0080	181878
Mp3 Yourban Erl	125	11-13	24 614 0161	583575	Vespa P 150 X	150	78-81	24 614 0080	181878
Sfera	125	95-97	24 614 0130	580953	Vespa Px	150	11-17	24 614 0090	181881
Skipper	125	94-97	24 614 0130	580953	Vespa S 4T	150	08-09	24 614 0161	583575
Skipper 4T	125	00-02	24 614 0130	580953	Vespa Sprint 150	150	65-74	24 614 0070	055316
Skipper Lx	125	98-99	24 614 0130	580953	Vespa Sprint 150	150	65-74	24 614 0110	181637
Super Hexagon Gtx 12	125	01-02	24 614 0130	580953	Vespa Super 150	150	65-79	24 614 0070	055316
Typhoon 4T 2V Eu3	125	10-11	24 614 0130	580953	Vespa Super 150	150	65-79	24 614 0110	181637
Typhoon 4T 2V Eu3	125	10-11	24 614 0161	583575	X8 Street Eu2	150	06-08	24 614 0161	583575
Vespa 125	125	60	24 614 0110	181637	Vespa Gs 160	160	62-64	24 614 0070	055316
Vespa 125	125	61	24 614 0070	055316	Vespa Rally 180	180	68-73	24 614 0070	055316
Vespa 125	125	61	24 614 0110	181637	Vespa Rally 180	180	68-73	24 614 0110	181637
Vespa 125	125	63	24 614 0110	181637	X9 Amalfi	180	00-03	24 614 0130	580953
Vespa 125	125	64	24 614 0110	181637	Carnaby	200	07-08	24 614 0161	583575
Vespa 125	125	61-62	24 614 0110	181637	Liberty	200	06	24 614 0161	583575
Vespa 125	125	65-66	24 614 0110	181637	Liberty 4T Eu3	200	06-08	24 614 0161	583575
Vespa Et3 125	125	76-83	24 614 0080	181878	Liberty 4T Sport Eu3	200	06-07	24 614 0161	583575
Vespa Et4	125	96-98	24 614 0130	580953	Liberty Rst	200	04	24 614 0161	583575
Vespa Et4	125	99-02	24 614 0130	580953	Liberty Sport	200	06	24 614 0161	583575
Vespa Fl	125	89-90	24 614 0090	181881	Vespa Granturismo	200	06-07	24 614 0161	583575
Vespa Granturismo	125	03-05	24 614 0161	583575	Vespa Px 200 E	200	77-82	24 614 0080	181878
Vespa Granturismo	125	06-07	24 614 0161	583575	Vespa Rally 200	200	72-79	24 614 0070	055316
Vespa Granturismo Eu3	125	06-07	24 614 0161	583575	Vespa Rally 200	200	72-79	24 614 0110	181637
Vespa Gt 125	125	66-73	24 614 0070	055316	X8	200	05-07	24 614 0161	583575
Vespa Gt 125	125	66-73	24 614 0110	181637	X9	200	02-03	24 614 0161	583575
Vespa Gts Eu3	125	07-12	24 614 0161	583575	X9 Evolution	200	03	24 614 0161	583575
Vespa Gtv	125	06-08	24 614 0130	580953	Beverly	250	06-07	24 614 0161	583575
Vespa Gtv 4T Navy Eu3	125	08	24 614 0130	580953	Beverly Euro 3 Mic	250	07	24 614 0161	583575
Vespa Lx	125	05-06	24 614 0161	583575	Beverly le Eu3	250	06-08	24 614 0161	583575
Vespa Lx 4T FL	125	09	24 614 0161	583575	Beverly Rst	250	04-05	24 614 0161	583575
Vespa Lx Eu3	125	06-08	24 614 0161	583575	Beverly Sport	250	06-08	24 614 0161	583575
Vespa Lxv 4T Eu3	125	06-09	24 614 0130	580953	Beverly Tourer Eu3	250	07-09	24 614 0161	583575
Vespa P 125 E	125	81	24 614 0080	181878	Carnaby	250	08	24 614 0161	583575
Vespa P 125 X	125	77-82	24 614 0080	181878	Hexagon Gt-Gtx	250	98-00	24 614 0130	580953
Vespa Pk 125	125	82	24 614 0080	181878	Mp3	250	06-08	24 614 0161	583575
Vespa Pk XL	125	86-89	24 614 0090	181881	Mp3 Lt	250	08-09	24 614 0161	583575
Vespa Primavera 125	125	67-83	24 614 0080	181878	Mp3 Mic	250	08-09	24 614 0161	583575

INTERRUTTORI STOP

BRAKE LIGHT SWITCHES



Modello - Model	Cc	Anno Year	Codice RMS RMS Code	Rifer. Originale Oem Number	Modello - Model	Cc	Anno Year	Codice RMS RMS Code	Rifer. Originale Oem Number
Vespa Gt 60 Euro 3	250	06-07	24 614 0130	580953	Gsx-R600 L5	600	15	24 614 0610	57460-14J01-000
Vespa Gts	250	05-16	24 614 0161	583575	Gsx-R600 L6	600	16	24 614 0610	57460-14J01-000
Vespa Gts Abs	250	05-12	24 614 0161	583575	Gsx-R600 L7	600	17	24 614 0610	57460-14J01-000
Vespa Gtv	250	06-09	24 614 0130	580953	An650 Burgman L3	650	13	24 614 0610	57460-14J01-000
Vespa Gtv 4T Navy Eu3	250	07	24 614 0130	580953	An650 Burgman L4	650	14	24 614 0610	57460-14J01-000
X7 Eu3	250	08	24 614 0130	580953	An650 Burgman L5	650	15	24 614 0610	57460-14J01-000
X8 Eu3	250	05-08	24 614 0161	583575	An650 Burgman L6	650	16	24 614 0610	57460-14J01-000
X9	250	00-01	24 614 0130	580953	An650z Burgman	650	18	24 614 0610	57460-14J01-000
X9 Evolution	250	04	24 614 0161	583575	DI650a V-Strom Abs L3	650	13	24 614 0610	57460-14J01-000
X9 Evolution	250	06	24 614 0161	583575	DI650a V-Strom Abs L4	650	14	24 614 0610	57460-14J01-000
Beverly Tourer Eu3	300	09-10	24 614 0161	583575	DI650a V-Strom Abs L5	650	15	24 614 0610	57460-14J01-000
Mp3 300 le Lt	300	10-11	24 614 0161	583575	DI650a(Ue)/Xa(Ue) V-Strom	650	17	24 614 0610	57460-14J01-000
Mp3 300 le Mic	300	10	24 614 0161	583575	DI650a(Ue)/Xa(Ue)L6 V-Strom	650	16	24 614 0610	57460-14J01-000
Mp3 300 le Mic	300	11	24 614 0161	583575	DI650xt V-Strom	650	15	24 614 0610	57460-14J01-000
Mp3 Lt Business - Sport Abs - Enjoy	300	14-16	24 614 0161	583575	Sfv Gladius L3	650	13	24 614 0610	57460-14J01-000
Mp3 4T 4V le Erl Ibrido	300	10-13	24 614 0161	583575	Sfv Gladius L4	650	14	24 614 0610	57460-14J01-000
Mp3 4T 4V le Lt Ibrido	300	10-11	24 614 0161	583575	Sfv650(U/A/Ua)Gladius L5	650	15	24 614 0610	57460-14J01-000
Mp3 le E4 Lt Business - Sport Abs	300	16-17	24 614 0161	583575	Sv650a L7	650	17	24 614 0610	57460-14J01-000
Mp3 le Lt- le Lt Sport	300	11-14	24 614 0161	583575	Sv650sl5	650	15	24 614 0610	57460-14J01-000
Mp3 le Lt Touring	300	11-13	24 614 0161	583575	Gsr750(A)L6	750	16	24 614 0610	57460-14J01-000
Mp3 le Touring	300	11-12	24 614 0161	583575	Gsr750I3	750	13	24 614 0610	57460-14J01-000
Mp3 Yourban ERL	300	11-15	24 614 0161	583575	Gsr750z(A)L4	750	14	24 614 0610	57460-14J01-000
Mp3 Yourban Lt ERL	300	11-16	24 614 0161	583575	Gsr750z(A)L5	750	15	24 614 0610	57460-14J01-000
Mp3 Yourban Lt RL E4	300	17	24 614 0161	583575	Gsx-R750 L3	750	13	24 614 0610	57460-14J01-000
Beverly Eu3	400	06-07	24 614 0161	583575	Gsx-R750 L4	750	14	24 614 0610	57460-14J01-000
Beverly Tourer Eu3	400	08-10	24 614 0161	583575	Gsx-R750 L5	750	15	24 614 0610	57460-14J01-000
Mp3	400	07-08	24 614 0161	583575	Gsx-R750 L6	750	16	24 614 0610	57460-14J01-000
Mp3 le Lt - Mp3 le Lt Sport	400	08-10	24 614 0161	583575	Gsx-R750 L7	750	17	24 614 0610	57460-14J01-000
Mp3 le Lt Touring	400	11	24 614 0161	583575	Gsx-R750z(Uf) L4	750	14	24 614 0610	57460-14J01-000
Mp3 Mic	400	08-10	24 614 0161	583575	Gsx-S750a(Z) L7	750	17	24 614 0610	57460-14J01-000
Mp3 RL Touring	400	11	24 614 0161	583575	VI800 Intruder C800 L3	800	13	24 614 0610	57460-14J01-000
X8 Eu3	400	06-08	24 614 0161	583575	VI800(C/Ue/Cue) L4	800	14	24 614 0610	57460-14J01-000
Beverly	500	02-04	24 614 0161	583575	VI800b Intruder C800 L4	800	14	24 614 0610	57460-14J01-000
Beverly	500	05-06	24 614 0161	583575	Vz800 Intruder M800 L3	800	13	24 614 0610	57460-14J01-000
Beverly Eu3	500	06-08	24 614 0161	583575	Vz800 Intruder M800 L4	800	14	24 614 0610	57460-14J01-000
Mp3 Lt Business Abs	500	14-16	24 614 0161	583575	Vz800 Intruder M800 L6	800	16	24 614 0610	57460-14J01-000
Mp3 Lt E4 Sport - Business	500	16-17	24 614 0161	583575	DI1000 V-Strom	1000	14	24 614 0610	57460-14J01-000
Mp3 Lt Sport - Business	500	11-13	24 614 0161	583575	DI1000 V-Strom L5	1000	15	24 614 0610	57460-14J01-000
Mp3 RI Sport - Business	500	11-12	24 614 0161	583575	DI1000 V-Strom L6	1000	16	24 614 0610	57460-14J01-000
Mp3 Sport Abs	500	14-16	24 614 0161	583575	DI1000(X)A V-Strom L8	1000	18	24 614 0610	57460-14J01-000
X9	500	01-02	24 614 0130	580953	Gsx-R1000 L3	1000	13	24 614 0610	57460-14J01-000
X9 Evolution	500	06-07	24 614 0161	583575	Gsx-R1000 L4	1000	14	24 614 0610	57460-14J01-000
SUZUKI					Gsx-R1000 L5	1000	15	24 614 0610	57460-14J01-000
Uk110ne Address L5	110	15	24 614 0610	57460-14J01-000	Gsx-R1000(A) L6	1000	16	24 614 0610	57460-14J01-000
Uk110ne Address L6	110	16	24 614 0610	57460-14J01-000	Gsx-R1000a Abs L5	1000	15	24 614 0610	57460-14J01-000
Uk110nx Address L5	110	15	24 614 0610	57460-14J01-000	Gsx-R1000r(Z)L7	1000	17	24 614 0610	57460-14J01-000
Rv125 Van Van L3	125	13	24 614 0610	57460-14J01-000	Gsx-R1000z L4	1000	14	24 614 0610	57460-14J01-000
Rv125 Van Van L5	125	15	24 614 0610	57460-14J01-000	Gsx-S1000 L6	1000	16	24 614 0610	57460-14J01-000
Uh125 Burgman L4	125	14	24 614 0610	57460-14J01-000	Gsx-S1000a L8	1000	18	24 614 0610	57460-14J01-000
Uh125 Burgman L6	125	16	24 614 0610	57460-14J01-000	Gsx-S1000f L6	1000	16	24 614 0610	57460-14J01-000
Uh125a Burgman L7	125	17	24 614 0610	57460-14J01-000	Gsx-S1000fa L8	1000	18	24 614 0610	57460-14J01-000
Rv200 Van-Van	200	16	24 614 0610	57460-14J01-000	Gsf1250sa Bandit L5-L6	1250	15-16	24 614 0610	57460-14J01-000
Uh200 Burgman L4	200	14	24 614 0610	57460-14J01-000	Gsx1250fa L6	1250	16	24 614 0610	57460-14J01-000
Uh200 Burgman L6	200	16	24 614 0610	57460-14J01-000	Gsx1300ra Hayabusa L6	1300	16	24 614 0610	57460-14J01-000
Uh200(A) Burgman L5	200	15	24 614 0610	57460-14J01-000	Gsx1300ra Hayabusa L7	1300	17	24 614 0610	57460-14J01-000
Uh200a Burgman L7	200	17	24 614 0610	57460-14J01-000	Gsx1300raz Hayabusa L4	1300	14	24 614 0610	57460-14J01-000
DL250a V-Strom	250	18	24 614 0610	57460-14J01-000	Gsz1300ra Hayabusa L3	1300	13	24 614 0610	57460-14J01-000
Gsx250ra(Z)L8	250	17	24 614 0610	57460-14J01-000	VI Intruder C1500t L3	1500	13	24 614 0610	57460-14J01-000
Gw250 Inazuma L3	250	13	24 614 0610	57460-14J01-000	VI Intruder C1500t L5	1500	15	24 614 0610	57460-14J01-000
Gw250 Inazuma L7	250	17	24 614 0610	57460-14J01-000	VI1500btI6 Intruder C1500t	1500	16	24 614 0610	57460-14J01-000
Gw250f Inazuma L5	250	15	24 614 0610	57460-14J01-000	Vzr1800 (Bz/Uf) Intruder M1800r L6	1800	16	24 614 0610	57460-14J01-000
Gw250f Inazuma L7	250	17	24 614 0610	57460-14J01-000	Vzr1800bz Intruder M1800r L4	1800	14	24 614 0610	57460-14J01-000
An400 Burgman L3	400	13	24 614 0610	57460-14J01-000	YAMAHA				
An400 Burgman L4	400	14	24 614 0610	57460-14J01-000	Bw's Bump	50	97-98	24 614 0040	5XLH39800000
An400 Burgman L5	400	15	24 614 0610	57460-14J01-000	Bw's Next Generation	50	99	24 614 0040	5XLH39800000
An400 Burgman L6	400	16	24 614 0610	57460-14J01-000	Bw's Next Generation	50	01-02	24 614 0030	5SEH253N0100
An400 Burgman L8	400	18	24 614 0610	57460-14J01-000	Bw's Next Generation	50	97-98	24 614 0040	5XLH39800000
Gsx-R600 L3	600	13	24 614 0610	57460-14J01-000	Bw's Next Generation	50	99-00	24 614 0030	5SEH253N0100
Gsx-R600 L4	600	14	24 614 0610	57460-14J01-000	Bw's Original	50	99	24 614 0040	5XLH39800000



INTERRUTTORI STOP BRAKE LIGHT SWITCHES

Modello - Model	Cc	Anno Year	Codice RMS RMS Code	Rifer. Originale Oem Number	Modello - Model	Cc	Anno Year	Codice RMS RMS Code	Rifer. Originale Oem Number
Bw's Original	50	01-02	24 614 0030	5SEH253N0100	Xt E	600	91	24 614 0690	3YF839800000
Bw's Original	50	97-98	24 614 0040	5XLH39800000	Xt E	600	92	24 614 0690	3YF839800000
Bw's Original	50	99-00	24 614 0040	5XLH39800000	Xt E	600	93	24 614 0690	3YF839800000
Bw's Original	50	99-00	24 614 0030	5SEH253N0100	Xt E	600	94	24 614 0690	3YF839800000
Bw's Original Eu2	50	03	24 614 0030	NM5839801000	Xt E	600	95-02	24 614 0690	3YF839800000
Bw's R	50	01	24 614 0030	NM5839801000	Xt K	600	91	24 614 0690	34X839800100
Cw Bw's Original Eu2	50	02	24 614 0030	NM5839801000	Xt K	600	92	24 614 0690	34X839800100
Cw L Bw's	50	03	24 614 0030	NM5839801000	Xt K	600	93	24 614 0690	34X839800100
Cw Rs Spy	50	95-98	24 614 0040	5XLH39800000	Xt Z Tenere	600	88	24 614 0690	2U2839803000
Cw Sp Bw's Original Eu2	50	02	24 614 0040	NM5839801000	Xt Z Tenere	600	89	24 614 0690	2U2839803000
Ew Slider	50	00-02	24 614 0030	5SEH253N0100	Xt Z Tenere	600	90	24 614 0690	2U2839803000
Ya R Axis	50	95-96	24 614 0040	5XLH39800000	Xt Z Tenere	600	83-85	24 614 0700	26H839800000
Yh Why	50	98	24 614 0040	5ADH39800100	Xt Z Tenere	600	86-87	24 614 0690	34X839800100
Yh Why	50	01-02	24 614 0030	5SEH253N0100	Xt660z Tenere	660	91	24 614 0690	3YF839800000
Yh Why Eu1	50	99-00	24 614 0040	5XLH39800000	Xt660z Tenere	660	92	24 614 0690	3YF839800000
Yh Why Eu1	50	99-00	24 614 0030	5SEH253N0100	Xt660z Tenere	660	93	24 614 0690	3YF839800000
Yh Why Eu2	50	03-05	24 614 0040	5XLH39800000	Xv Virago	750	92	24 614 0700	26H839800000
Ym Breeze	50	94-95	24 614 0040	5XLH39800000	Xv Virago	750	94	24 614 0700	1A0839803000
Yn F Neo's 4	50	09-10	24 614 0040	5XLH39800000	Xv Virago	750	95	24 614 0700	26H839800000
Yn Neo's	50	04-06	24 614 0040	5XLH39800000	Xv Virago	750	96	24 614 0700	1A0839803000
Yn Neo's	50	07-12	24 614 0040	5XLH39800000	Xs850	850	80	24 614 0700	1A0839803000
Yn Neo's Eu2	50	02-03	24 614 0040	5XLH39800000	Fzr	1000	89	24 614 0700	26H839800000
Yn R Neo's	50	02	24 614 0040	5ADH39800100	Fzr	1000	90	24 614 0700	26H839800000
Yn R Neo's	50	97-01	24 614 0040	5XLH39800000	Xv Se Virago	1000	88	24 614 0700	26H839800000
Yq Aerox	50	01-02	24 614 0030	5SEH253N0100	Xv Virago	1100	91	24 614 0700	26H839800000
Yq Aerox	50	97-98	24 614 0040	5ADH39800100	Xv Virago	1100	94	24 614 0700	26H839800000
Yq Aerox R	50	99	24 614 0030	5SEH253N0100	Xv Virago	1100	95	24 614 0700	26H839800000
Yq Aerox R	50	99-00	24 614 0040	5XLH39800000	Xv Virago	1100	89-90	24 614 0700	26H839800000
Yq L Aerox Eu2	50	03	24 614 0030	5SEH253N0100	Xv Virago	1100	96-97	24 614 0700	26H839800000
Yn Neo's	100	99-02	24 614 0040	5XLH39800000	Xvz 12Td	1200	88	24 614 0700	26H839800000
Yn Neo's	100	99-02	24 614 0030	5SEH253N0100	Xvz 13Td	1300	89-90	24 614 0700	26H839800000
Yq Aerox	100	00-02	24 614 0030	5SEH253N0100					
Dt125r	125	89-92	24 614 0690	3YF839800000					
Xn Teo's	125	00	24 614 0030	NM5839801000					
Xq Maxster	125	01-02	24 614 0030	NM5839801000					
Yp125 Majesty	125	01-02	24 614 0040	5XLH39800000					
Yp125 Majesty	125	98-00	24 614 0040	5ADH39800100					
Yp125e Majesty	125	06	24 614 0040	5XLH39800000					
Yp125e Majesty	125	07	24 614 0040	5XLH39800000					
Yp125e Majesty	125	08	24 614 0040	5XLH39800000					
Yp125e Majesty	125	09	24 614 0040	5XLH39800000					
Yp125e Majesty	125	03-05	24 614 0040	5XLH39800000					
Xn Teo's	150	01-02	24 614 0030	NM5839801000					
Xq Maxster	150	01-02	24 614 0030	NM5839801000					
Yp150 Majesty	150	00	24 614 0040	5ADH39800100					
Yp150 Majesty	150	01-02	24 614 0040	5XLH39800000					
Yp180e Majesty	180	03-06	24 614 0040	5XLH39800000					
Sr Classic	250	96	24 614 0700	26H839800000					
Tt A	350	90-95	24 614 0690	34X839800100					
Tt350	350	85-89	24 614 0690	3YF839800000					
Xv Dx Virago	535	99	24 614 0700	26H839800000					
Xv Dx Virago	535	00-01	24 614 0700	26H839800000					
Xv Se Virago	535	88	24 614 0700	26H839800000					
Xv Virago	535	89	24 614 0700	26H839800000					
Xv Virago	535	90	24 614 0700	26H839800000					
Xv Virago	535	91	24 614 0700	26H839800000					
Xv Virago	535	92	24 614 0700	26H839800000					
Xv Virago	535	93	24 614 0700	26H839800000					
Xv Virago	535	94	24 614 0700	26H839800000					
Xv Virago	535	95	24 614 0700	26H839800000					
Xv Virago	535	96	24 614 0700	26H839800000					
Xv Virago	535	97-98	24 614 0700	26H839800000					
Xz550	550	82-85	24 614 0700	1A0839803000					
Tt N	600	85-88	24 614 0690	3YF839800000					
Tt W	600	89-92	24 614 0690	3YF839800000					
Xt	600	84-86	24 614 0690	3YF839800000					
Xt	600	87-88	24 614 0690	3YF839800000					
Xt	600	89-90	24 614 0690	34X839800100					
Xt E	600	90	24 614 0690	3YF839800000					



24 612 0010

INTERMITTENZA FRECCE
INDICATOR LAMP INTERMITTENCE

12V 21W

PIAGGIO Vespa: Pxe Arcobaleno
125-150-200 81-97 • 50 Pk XL 85-88 • Pk XL
Rush 88-89 • 50 N 89-90 • FL 125 89-00 • Pk 50-
125 82-84 • Px T5 125 85-00 • Pk S Automatica
84-89 • 50 FL 90 • Pxe 125-150-200 88-91
• Ape 50 Tm P 85-89 • Cosa 2 125-200 91-97
• Si 50 FL2 91-97 • Si 50 Mix 96-99
• Cosa CL CLX 125-150-200 88-91
• Ape 50 P 80-85
(R.O. 163968-195703)



24 612 0020

INTERMITTENZA FRECCE
CON AVVISATORE ACUSTICO
INDICATOR LAMP ACOUSTIC INTERMITTENCE

MBK 50: Booster 01-03 • Ng 99-03
• Ng Eu 99-00 • Spirit 99-00 • Spirit Eu2 02
• Nitro 97-02 • Stunt 00-02 • Nitro 100 00/02
YAMAHA 50: Aerox 97-02 • Aerox R 99-00
• Bw's Original 99-02 • Bw's Original Eu 2 02
• Bw's N.g. 01-03 • Slider 00-02 • Aerox 100 00-02



24 612 0030

INTERMITTENZA FRECCE
INDICATOR LAMP INTERMITTENCE

MBK 50: Booster Spirit 03 • Booster Spirit Eu2 03
• Booster Naked 03
YAMAHA 50: Aerox Eu2 03 • Bw's Original Eu2
03 • Bw's Original 03 • Bw's Naked 03



24 612 0060

INTERMITTENZA FRECCE
CON AVVISATORE ACUSTICO
INDICATOR LAMP ACOUSTIC
INTERMITTENCE

MBK 50: Booster Spirit 03 • Booster Spirit Eu2
03 • Booster Naked 03
YAMAHA 50: Aerox Eu2 03 • Bw's Original
Eu2 03 • Bw's Original 03 • Bw's Naked 03



24 612 0072

INTERMITTENZA FRECCE
CON AVVISATORE ACUSTICO
INDICATOR LAMP ACOUSTIC
INTERMITTENCE

10 W x 2+3,4 W
KYMC0 50: Agility 4t R10 • R12 05-08 • R16 08-12
• Filly 98-02 • Heroism 95-97 • People - Eu2 99-08
• Super 8 07-09 • Yup 02-03 • Super 9 00-04
• Top Boy 97-00
125: Agility 4t 06-08 • Agility R16 09-12 • Grand
Dink 01-04 • Movie 99-07 • People Eu2 99-03 •
Vivio 00
150: Movie Eu2 -Eu 3 04-07 • Agility R16 08-09
200: Agility R16 10-12
250: Grand Dink 01-04 • People Lc 03-04 • Yup 03
(R.O. 00151708 • 00151016 • 00151515)



24 612 0082

INTERMITTENZA FRECCE
CON AVVISATORE ACUSTICO
INDICATOR LAMP ACOUSTIC
INTERMITTENCE

SYM 50: Dd Eu2 03-07 • Mask 00-01
125: Attila 99-00 • Hd Eu2-3 03-08 • Joyride Eu2 01-04
• Shark 99-02
150: Attila 00-01 • Joyride 01-02 • Shark 00-01
200: Hd Eu 03-04 • Hd Evo Eu2-3 05-07
• Joyride Eu2 03-06 • Joyride 03
(R.O. 38301A31000)
KYMC0 50: Sniper 93 • Sniper Dd 94-96 • Dink Lc
98-02 • Dink Classic Eu2 03
125: Zinc 97-98
200: Dink Classic 04
250: Venox 02-07



24 612 0092

INTERMITTENZA FRECCE
CON AVVISATORE ACUSTICO
INDICATOR LAMP ACOUSTIC
INTERMITTENCE

KYMC0 50: People S/4T 05-08
125-200-300: People GTI 10
300: X Citing IR 09
500: X Citing R 09
Di primo equipaggiamento - *OEM Quality*
(R.O. 00151701)



24 612 0102

INTERRUTTORE FRECCE
INDICATOR LAMP INTERMITTENCE

KYMC0 125: Dink Eu3 06-07
250: X Citing I 06-07 • X Citing 05
300: X Citing I R 08 • X Citing I 08
400: Mxu 08
500: Mxu Irs 10 • Mxu 05-06 • Uxv I 10 • Uxv 08
• X Citing R 07-08 • X Citing I 06-08 • X Citing 05
(R.O. 00169143-38300-LBC6-90A)



24 612 0112

INTERMITTENZA FRECCE
INDICATOR LAMP INTERMITTENCE

MBK 50: Cr Z Target 91-95 • Ct S Sorriso 91-92
• Ct SS Sorriso 93-95 • Ya Ta New Sorriso 95-96
100: Yw Booster 99-01
YAMAHA 50: Cr Z 91-95 • Ct S 90-95 • Ct SS
92-95 • Ya Za Jog Z 95
100: Bw's 91-01
(R.O. 1MHH3350V000)





INTERMITTENZE - RESISTENZE

INDICATOR INTERMITTENCE - RESISTORS

24 612 0122 

INTERMITTENZA FRECCE

INDICATOR LAMP INTERMITTENCE

KYMCO 125: Downtown i 09 • Gran Dink 12
200: Downtown i 10
300: Downtown i 09-11 • Abs 10 • Abs i 11
 • Grand Dink 12
 (R.O. 00138013)



24 612 0132 

INTERMITTENZA FRECCE

INDICATOR LAMP INTERMITTENCE

KYMCO 125: People S 05 • People Sd Eu3 07-08
200: People S 05 • People Si 07
250: People S 06 • People Si 07
300: People Si 08
 (R.O. 00151709)



24 612 0142 

INTERRUTTORE FRECCE

INDICATOR LAMP INTERMITTENCE

21 Wx2+3.4W
SYM 125: Joyride Evo 09-13
200: Joyride Evo i 09-13
300: Citycom Efi 10-11 • Citycomi Cbs 12
 Citycom 08-09 • Quad Lander S 07-08
 • Quad Lander 08
 (R.O. 38301RFA000)



24 612 0152 

INTERRUTTORE FRECCE

INDICATOR LAMP INTERMITTENCE

10 Wx2+3.4W
KYMCO 50: Dink 4T 07 • Sento 08
125: Quannon 08
200: Dink Eu3 i 06-07
450: Maxxer i 10
 (R.O. 00172193)



24 612 0162 

INTERRUTTORE FRECCE

INDICATOR LAMP INTERMITTENCE

KYMCO 125: Quannon Naked 10
400: X Citing i 13
700: Mxu i 13 • Myroad i 11
 (R.O. 00138023)



24 612 0173 

BUZZER

BUZZER

12V 21W
PIAGGIO: Vespa 125 T5 • Cosa 1-2
 Vnx5t-Vnr1-VLR1-Vsr1
 (R.O. 231284)



NEW

24 640 0100 

TELERUTTORE - INDICATOR RELAY

PIAGGIO 50: Ape FL-FL2 89-95 • Sfera Rst 95-97 • Velofax 96-99 • Zip Bimodale 94-97 • Zip Fast Raider 93-94 • Zip 95-96
 (R.O. 640289)



24 640 0072 

TELERUTTORE - HIGH BEAM RELAY

PIAGGIO 125: Beverly Eu3 Mic 07 • Beverly Rst 04-05 • Beverly 01-03 • Fly 05-07 • Hexagon Gtx 00 • Hexagon Lx-Lxt 98-99 • Hexagon Lx4 98-99 • Hrxagon 94-97 • Liberty 4T Eu3 07-08 • Liberty Rst 04-05 • Liberty 98-02 • Skipper 4T 00-02 • Skipper Lx 98-99 • Super Hexagon Gtx 12 01-02 • Vespa Et4 96-02 • Vespa S 4T Eu3 07-08 • X8 Premium Eu2 06 • X8 Premium Eu3 06-07 • X8 Street Eu2 06-07 • X8 05-06 • X9 Evolution Eu3 07 • X9 Evolution 03-06 • X9 01-02
150: Fly 05-07 • X8 Street Eu2 06-08
180: X9 Amalfi 00-03
200: Liberty Rst 04 • Liberty Sport 06 • X8 05-07 • X9 Evolution 03 • X9 02-03
250: Beverly Eu3 Mic 07 • Beverly Ie Eu3 06-08 • Beverly Rst 04-05 • Beverly Sport 06-08 • Beverly Tourer Eu3 08-09 • Beverly 06-07 • Hexagon Gt-Gtx 98-00 • X8 Eu3 05-08 • X9 Evolution 04-06 • X9 00-01

400: Beverly Eu3 06-07 • Beverly Tourer Eu3 08-10 • **420:** Ape Car Max Diesel 86-96 • Ape Poker Diesel 93-97 • Ape Tm Diesel Lcs 05-12
500: Beverly Eu3 06-08 • Beverly 02-04 • X9 Evolution 03-05 • X9 Evolution 03-07 • X9 01-02
 (R.O. 58002R)





24 640 0062

RELÈ FRECCHE - INDICATOR LAMP RELAY

KYMCO 125: Dink Eu3 06-07 • Dntown i 09 • G-Dink 12 • People Gt1 10 • Quannon 08
125-150: B&w Eu2 03-04 • B&w 00 • Grand Dink 01-02 • Grand Dink 01-02
200: Agility R16 10-12 • Dink Classic 04 • Dink Eu3 i 06-07 • Dntown i 10 • Like 01 09 • Like LX 12 • People Gti 10 • People S 01 07
250: B&w Eu2 03 • B&w 00 • Grand Dink Eu2 03-04 • Grand Dink 01-02 • People Lc 03-04 • People S i 07 • Venox Eu3 07 • X Citing i 06-07 • X Citing 05 • Yup 03
300: Dntown i 09 • Dntown Abs i 11 • Dntown Abs 10 • Dntown i 11 • G-Dink 12 • Mxu R 10 • People Gti 10-11 • People S i 08 • X Citing i R 08-09 • X Citing i 08
450: Maxxer i 10
500: Mxu lrs 10 • Mxu 05-06 • Uxv i 10 • Uxv 08 • X Citing R 09 • X Citing i R 07-08 • X Citing i 06-08 • X Citing 05
700: Myroad I 11 (R.O. 00168930)



12 183 0853

**SUPPORTO ELASTICO RELAIS FRECCHE
RELAIS ELASTIC BRACKET**

PIAGGIO 125-150-200: Vespa Px T5 VNX5T • Cosa VNR-VLR-VSR (R.O. 291017 • 290222)



24 612 9000

**RESISTENZA ELETTRICA 5 W
RESISTOR 5 W**

KYMCO
Di primo equipaggiamento - OEM Quality (R.O. 00169731)



24 612 9010

RESISTENZA - RESISTOR

KIMCO 50: Agility 4T R10 04-08 • R12 05-08 • Filly LX 01-02 • Vitality 4T 04 • Dink 4T 07
Di primo equipaggiamento - OEM Quality (R.O. 00168591)



24 612 9040

RESISTENZA - RESISTOR

KYMCO 50: Agility 4T R16 08-12 • Agility Rs 09 • Like 4T 09 • Super 8 4T 09 • Super 8 07 (R.O. 00135001 • 35400 • LEJ2-E10)



24 612 9050

RESISTENZA - RESISTOR

KYMCO 125: Agility R16 08-12 • Like 09 • Super 8 08-09
150: Agility R16 08-09 (R.O. 0135006 • 35400-LEJ3-E10)



RELÈ TEMPORIZZATO PER FARI XENON - TIMER RELAY FOR XENON LIGHTS

Dispositivo che ritarda l'accensione dei fari nella fase all'avvio del motociclo, riducendo al minimo l'assorbimento di energia della batteria, per garantire una maggiore affidabilità nella messa in moto del veicolo.

Il timer chiude il circuito verso le luci 15 o 25 secondi dopo l'accensione del veicolo con interruttore luci in posizione di OFF.

Il dispositivo non è compatibile con motocicli dotati di una singola lampada utilizzata come luce anabbagliante/ abbagliante.

Starting a Motorcycle when the Lights are switched on, will drain power from the Battery very quickly. For optimal power consumption Motorcycles should be started with the Lights switched off.

This timer close the circuit to the Lights 15 or 25 seconds after the ignition is activated by setting the "lights switch" to OFF.

Device not compatible with motorbikes using single bulb serving as low beam/ high beam light.

24 640 0120

Ritardo 15 secondi
Delay 15 seconds

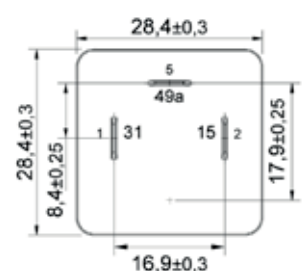
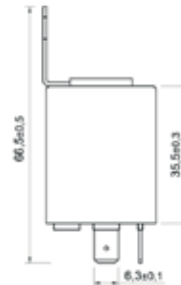
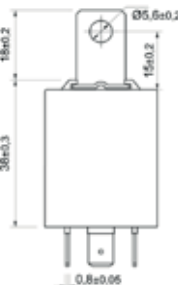

Schede tecniche consultabili sul sito www.rms.it - Data sheet available at www.rms.it



SENSORI SENSORS

10 012 0030



INTERRUTTORE TERMICO TEMPERATURE SWITCH

KYMCO 125: Downtown i 09
125-150: B&w 00 • Dink Classic Eu2 03
200: Downtown i 10 • People Gti 10 • B&w Eu2 03
250: Grand Dink 01-02 • People S i 07
 • X Citing i 06-07 • X Citing 05
300: Downtown i 09 • Downtown Abs i 11 •
 Downtown Abs 10 • Downtown i 11 • People
 Gti 10-11 • People S i 08 • X Citing i R 08-09
500: X Citing R 09 • X Citing i R 07-08 • X Citing
 i 06-08 • X Citing 05 • Myroad i 11
 (R.O. 0170950-37760-KD8-900)



10 012 0020



INTERRUTTORE TERMICO TEMPERATURE SWITCH

KYMCO 50: B&w Eu2 02-03 • Dink Lc 98-02 •
 Super 9/Sport Eu2 00-04
125: Dink Eu3 06-07 • Downtown i 09 • People
 Gti 10
125-150: B&w Eu2 00-04 • Dink Classic Eu2
 02-03 • Dink Lx 98-00 • Gran Dink Eu2 01-04
200: Dink Classic 04 • Dink Eu3 i 06-07 • Down-
 town i 10 • People Gti 10
250: B&w Eu2 00-03 • Grand Dink Eu2 01-04
 • Kxr 03-04 • Mxu 05 • People Lc/S/S i 03-07 •
 Venox Eu2/3 02-07 • X Citing i 05-07 • Yup 03
300: Downtown i Abs 09-10 • Maxxer 05-06 •
 Mxu/R 05-10 • People S i/Gti 08-10
 • X Citing i/i R 08-09
500: Mxu 05-06 • Uxv 08 • X Citing 05 • R 09
 • i R 06-09
SYM 125: Hd Eu2 / Eu3 03-08 • Hd Evo Eu3 •
 Tamburo Eu3 07-10 • Joy Ride Eu2 / Eu2/3 03-
 07 • Joy Ride Evo 09-10
150: Joy Ride 01-02
200: Hd Evo i Eu3 • Tamburo Eu3 08-10 • Joy
 Ride Eu2 05-06 • Joy Ride i Eu3 07-09
250: Gts 07-08 • Joy Max Eu3 i 05-08 • Quad
 Lander 06-07
300: Citycom / Ef1 08-10 • Joy Max Evo / Evo i
 09-10 • Quad Lander / Lander S 07-08
400: Max Sym i 11
 Di primo equipaggiamento - *OEM Quality*
 (R.O. 00129966)



10 012 0050



SENSORE PRESSIONE OLIO OIL PRESSURE SENSOR

SYM 400: Maxsym 11-12
 (R.O. 37240L4A000)



10 012 0060



SENSORE TEMPERATURA ACQUA - WATER TEMPERATURE SENSOR

APRILIA 125: Rs 06-10 • Sport City One 4T Eu3 08-11 • Sr Motard 12-13 • **850:** Srv - Srv Abs Atc
 12-13 • **DERBI 125:** Boulevard 4T Eu3 08-12 • Sonar 4T 09-11 • Variant Sport 4T E3 12 • **150:**
 Boulevard 4T E3 10 • Sonar 4T 09
GILERA 500: Fuoco 4T 4V ie E3 Lt 13 • Fuoco Eu3 07-13 • **800:** Gp Centenario 09 • Gp 07-11
PIAGGIO 50: Fly 4T 4V 12-13 • **125:** Beverly Rst 4T 4V ie Eu3 10-13 • Beverly 01-03 • Fly Eu3
 07-11 • Hexagon Gtx 00 • Liberty 4T 2V ie Ptt - Ita 12 • Liberty 4T Eu3 Delivery - Single 07-12 •
 Liberty 4T Eu3 Delivery Tnt 08-09 • Liberty 4T Eu3 07-08 • Liberty 4T Sport Eu3 06-08 • Mp3 ie
 Touring 11-12 • Mp3 ie 08-09 • Mp3 06-08 • Skipper 4T 00-02 • Super Hexagon Gtx 12 01-02
 • Typhoon 4T 2V Eu3 10-11 • Vespa Lx 4T FL 09 • Vespa Lx Eu3 06-08 • Vespa Lxv 4T Navy Eu3
 07-08 • Vespa S 4T Eu3 07-08 • X Evo 07-12 • X10 4T 4V ie Eu3 12-13 • X9 Evolution Eu3 07 • X9
 Evolution 03-06 • X9 01-02 • 150: Fly Eu3 08-11 • Liberty 4T Eu3 08 • Liberty 4T Sport Eu3 08
 • Liberty Moc 4T Eu3 09-13 • Vespa Lx 4T FL 09 • Vespa Lx Eu3 06-08 • Vespa S 4T 08-09 • **180:**
 X9 Amalfi 00-03 • **200:** Liberty 4T Eu3 06-08 • Liberty 4T Sport Eu3 06-07 • X9 Evolution 03 • X9
 02-03 • **250:** Hexagon Gt-Gtx 98-00 • Mp3 Lt 08-09 • Mp3 Mic 08-09 • Mp3 06-08 • Vespa Gts
 Abs 05-12 • Vespa Gts 05-13 • X Evo 07-13 • X9 Evolution 04-06 • X9 00-01 • **300:** Beverly Rst 4T
 4V ie Eu3 10-13 • Mp3 ie Lt 10-11 • Mp3 ie Mic 10-11 • Mp3 ie Lt Touring 11-12 • Mp3 ie Lt-
 ie Lt Sport 11-13 • Mp3 ie Touring 11-12 • Mp3 Yourban Lt ERL 11-12 • **350:** Beverly 4T 4V ie Eu3
 Sport Touring 11-13 • X10 4T 4V ie Eu3 12-13 • **400:** Mp3 ie Lt-Mp3 ie Lt Sport 08-10 • Mp3 ie Lt
 Touring 11 • Mp3 Mic 08-10 • Mp3 RL Touring 11 • Mp3 07-08 • X Evo 07-11 • **500:** Mp3 Lt Sport -
 Business 11 • Mp3 RL Sport - Business 11-12 • X10 4T 4V ie Eu3 12-13 • X9 Evolution Abs 06-07 •
 X9 Evolution 03-07 (R.O. 581142)





10 012 0070



SONDA LAMBDA - OXYGEN SENSOR

KYMCO 125: Downtown I 09 • G-Dink 12 • K-Xct I 12-14 • People Gti 10 • People One I Dd 15 • People One I 13 **200:** Agility R16 10 • Agility I Plus 14 • Agility R16 12 • Dink Eu3 I 06-07 • Like I 09 • Like Lx 12 • People S I 07 • Downtown I 10 • People Gti 10-14 • **250:** People S I 07 • X Citing I 06-07 • **300:** Downtown I 09 • Downtown Abs I 11 • Downtown Abs 10 • Downtown I 11 • G-Dink 12 • People Gti Abs 12-14 • People Gti 10-14 • People S I 08 • X Citing I R 08-09 • X Citing I 08 • K-Xct I Abs 14 • K-Xct I 12 • **350:** Downtown I Abs 15 • **400:** X Citing I Abs 14 -15 • X Citing I 13-15 • **500:** X Citing R 09 • X Citing I R 07-08 • X Citing I 06-08
(R.O. 00168213 • 00168148)

10 012 0080



SONDA LAMBDA - OXYGEN SENSOR

APRILIA 125: Sr Max 11-14 • **250:** Sport City Cube 08-12 • **300:** Atlantic 10-11 • Scarabeo Light 09-10 • Sport City Street 12 • Sr Max 11-14 • **400:** Atlantic Sprint 05-08 • Scarabeo Light 06-08 • **850:** Srv - Srv Abs Atc 12-14
GILERA 125: Nexus Eu3 ie 08-10 • **300:** Nexus Eu3 08-11 • **500:** Fuoco 4T 4V ie Eu3 Lt 13-14 • Fuoco Eu3 07-13-11 • Nexus Eu3 06-11 • Nexus Sp Eu3 06-07
PIAGGIO 125: Beverly Rst 4T 4V ie Eu3 10-15 • Mp3 Ibrido 09-10 • Mp3 ie Touring 11-12 • Mp3 ie 08-09 •
• Vespa Gts 4T ie Super 09-16 • X10 4T 4V ie Eu3 12-13 • X7 Evo ie Eu3 09-10 • **300:** Beverly Rst 4T 4V ie Eu3 10-15 • Beverly Tourer Eu3 09-10 • Carnaby Cruiser 09-12 • Mp3 ie Lt 10-11 • Mp3 ie Mic 10-11 • Mp3 Lt Business - Sport Abs -Enjoy 14-15 • Mp3 4T 4V ie ERL Ibrido 10-13 • Mp3 4T 4V ie Lt Ibrido 10-11 • Mp3 ie Lt Touring 11-13 • Mp3 ie Lt - ie Lt Sport 11-13 • Mp3 ie Touring 11-12 • Mp3 Yourban Lt ERL 11-12 • X7 Evo ie Eu3 09-10 • **350:** Beverly 4T 4V ie Eu3 Sport Touring 11-14 • X10 4T 4V ie Eu3 12-13 • **400:** Beverly Eu3 06-07 • Beverly Tourer Eu3 08-10 • Mp3 ie Lt - Mp3 ie Lt Sport 08-10 • Mp3 ie Lt Touring 11 • Mp3 Mic 08-10 • Mp3 RL Touring 11 • Mp3 07-08 • X Evo 07-11 • X8 Eu3 06-08 • **500:** Beverly Cruiser 07-12 • Beverly Eu3 06-08 • Mp3 Lt Business Abs 14-16 • Mp3 Lt Sport - Business 11-13 • Mp3 RL Sport - Business 11-12 • Mp3 Sport Abs 14-15 • X10 4T 4V ie Eu3 12-14
(R.O. 6411235 • 639806)

10 012 0090



SONDA LAMBDA - OXYGEN SENSOR

APRILIA 250: Sport City Cube 08-12 • **850:** Mana Gt 09-15 • Mana 07-11 • **1000:** Rsv4 Aprc R Abs 13-14 • Rsv4 Aprc R 11-12 • Rsv4 Factory - Sbk Racing 09-10 • Rsv4 Factory Aprc Abs 13-14 • Rsv4 Factory Aprc Std Se 11-12 • Rsv4 R 09-10 • Tuono V4 R Aprc Abs 14 • Tuono V4 R Std - Aprc 11-13 • Tuono V4 Factory 15 • Tuono V4 Rr 15
GILERA 250: Nexus Eu3 06-07 • Nexus Sp Eu3 06-07 • **800:** Gp Centenario 09 • Gp 07-11
PIAGGIO 125: Liberty 4T 2V ie Ptt - Ita 12 • Vespa Lx 4T Eu3 Touring 10-11 • Vespa Lx Eu3 ie 09-11 • Vespa Lxv ie 4T 10-13 • Vespa S 4T ie & College 09-11 • **150:** Vespa Lx Eu3 ie 09-11 • Vespa Lx Touring 10-12 • Vespa S 4T ie & College 09-12 • **250:** Beverly Cruiser 07-09 • Beverly Eu3 Mic 07 • Beverly ie Eu3 06-08 • Beverly Sport 06-08 • Beverly Tourer Eu3 07-09 • Carnaby 08 • Mp3 Lt 08-09 • Mp3 Mic 08-09 • Mp3 06-08 • Vespa Gt 60 Eu3 06-07 • Vespa Gts Abs 05-12 • Vespa Gts 05-14 • Vespa Gtv 4T Navy Eu3 07 • Vespa Gtv 06-09 • X Evo 07-13 • X7 Eu3 08 • X8 Eu3 05-08
(R.O. 584344)





FUSIBILI FUSES

24 615 1000



Kit 10 fusibili lamellari standard
10 Pcs standard fuses kit



24 615 1010



Kit 10 fusibili lamellari mini
10 Pcs mini fuses kit



24 615 1020



Kit 10 fusibili siluro
10 Pcs Stc fuses kit



24 615 1030



Kit 100 fusibili lamellari standard
100 Pcs standard fuses kit



24 615 1040



Kit 100 fusibili lamellari mini
100 Pcs mini fuses kit



▶ CENTRALINE

CDI UNITS

▶ REGOLATORI

REGULATORS

▶ MOTORINI
AVVIAMENTO

STARTER MOTORS

▶ BOBINE

COILS

▶ STATORI E VOLANI

STATORS AND MAGNETOS

▶ **RMS**
YOUR BEST PARTNER

▶ **BERU**



CENTRALINE ELETTRONICHE
ELECTRONIC IGNITION - CDI

APRILIA

24 604 0122

125: Scarabeo Light 07-08
(R.O. JC32900X92000)
Di primo Equipaggiamento – *OEM Quality*



BETA

24 604 0102

125-150: Elkon 00-02
(R.O. 1241850000)



HONDA

24 604 0112

5 Pin
50: Sh >95



KYMCO

24 604 0022

50: Mxu 06-07 • Mxu Sr 06 • People 04 • People 99-00 • People Eu2 08 • People Eu2 03 • People S 05-08
(R.O. 00169303)
Di primo Equipaggiamento – *OEM Quality*



24 604 0032

125-150: People 99-00 • People Eu2 03
(R.O. 00169397)
Di primo Equipaggiamento – *OEM Quality*



24 604 0042

125: Movie 99-00 • Vivio 00
150: Vivio 00
(R.O. 00168187)
Di primo Equipaggiamento – *OEM Quality*



24 604 0072

50: Agility 4T R10 06 • Agility R12 05 • Vitality 4T 04
(R.O. 00169082)
Di primo Equipaggiamento – *OEM Quality*



24 604 0082

8 Pin
50: Agility 4T R16 08-09 • Agility Rs 09 • Like 4T 09 • Super 8 07 • Super 8 4T 09
(R.O. 00130005)
Di primo Equipaggiamento – *OEM Quality*



24 604 0092

8 Pin
125: Agility R16 08-09 • Agility Rs 09 • Like 09 • Super 8 08-09
150: Agility R16 08-09
(R.O. 00130008)
Di primo Equipaggiamento – *OEM Quality*





KYMCO

24 604 0102



125: B&w 00 • B&w Eu2 03-04 • Dink 125-150 97-98 • Dink Classic 02 • Dink Classic Eu2 03 • Dink Lx 125-150 98-00 • Grand Dink 01-02 • Grand Dink Eu2 03-04
150: B&w 00 • B&w Eu2 03-04 • Dink 97-98 • Dink Classic 02 • Dink Classic Eu2 03 • Dink Lx 98-00 • Grand Dink 01-02 • Grand Dink Eu2 03-04 (R.O. 00168923)
Di primo Equipaggiamento – *OEM Quality*



24 604 0112



5 Pin
50: Djx – Djy (R.O. 00160001)
Di primo Equipaggiamento – *OEM Quality*



24 604 0142



50: People S 4T 06-08 (R.O. 00101093)
Di primo Equipaggiamento – *OEM Quality*



24 604 0152



125: Agility 4T Eu3 06-08 (R.O. 00168168)
Di primo Equipaggiamento – *OEM Quality*



24 604 0162



50: Dink Classic Eu2 98-02 • Super 9 00 • Super 9 Sport Eu2 03-04 (R.O. 001168900)
Di primo Equipaggiamento – *OEM Quality*



24 604 0172



50: Cx Super 94-97 • Cx 93 • Dj W 94-00 (R.O. 00160401 • 30400-KLE-000)
Di primo Equipaggiamento – *OEM Quality*



24 604 0182



50: Agility 2T R16 10 • Agility Rs Naked 2T 09 • Like 2T 09 • Super 8 2T 09-13 (R.O. 00130025 • 30410-LB3-E10)
Di primo Equipaggiamento – *OEM Quality*



24 604 0192



125: People S DD Eu 3 07-08 (R.O. 00169185 • 30400-LCD3-E10)
Di primo Equipaggiamento – *OEM Quality*



24 604 0202



200: Dink Classic 04 (R.O. 00168060 • 30400-LBF6-E00)
Di primo Equipaggiamento – *OEM Quality*





CENTRALINE ELETTRONICHE

ELECTRONIC IGNITION - CDI

KYMCO

24 604 0212 

125-200: People S 05
(R.O. 00169220 • 30400-LCD4-E10)
Di primo Equipaggiamento – *OEM Quality*



MALAGUTI

24 604 0032 

125-150: Ciak 00-01 • Ciak Master 04
• Ciak Rst Eu2 03
(R.O. 02406500)
Di primo Equipaggiamento – *OEM Quality*



24 604 0102 

125-150: F18 Warrior 00-02
(R.O. 02407500)
Di primo Equipaggiamento – *OEM Quality*



PEUGEOT

24 604 0112 

5 Pin
50: SC LI Metropolis • ST Rapido • SV • Geo
• Buxy • Zenith • Squab • Speedake • Ludix
• Trekker • Vivacity (s/antif.eletr.) • Looxor
• Speedfight • LC/Cat. (s/antif.eletr.) • X-Fight
Air (s/antif. eletr.) • Metal-X
100 Speedfight (s/antif. eletr.) • Trekker • SV
(R.O.740220 • 737615 • 709205)
Di primo Equipaggiamento – *OEM Quality*



24 604 0132 

6 Pin
50: V-Clic 4T (QM50QT-6-07-09)
Scooter Cinesi - Chinese Scooter
Buffalo QM50QT-6A(A)
Qingqi QM Qt-2 4T (LAEABZ400-07-09)-
QM50QT-6A 4T (LAEABZ400-07-09) QM50QT-
6A 4T (LAEAGZ400-07-09)-QM50T-6A(A)
4T (LAEAKA10-07-09) Rex Tribal Scooter
4T (07-09)-Off Limit 4T (07-09)-QM50QT-2
Capriolo 4T (07-09) QM50QT-6A RS 450 \$T
(06-09)- QM50QT



PGO

24 604 0112 

5 Pin
50-100: Scooter 2T Bigmax G • Max T w
• Rex PMX



SYM

24 604 0012 

100: Cinderella 99-01
125: Attila 99-00 • Euro Mx 02 • Euro Mx E2 03-
04 • Fiddle li 08-10 • Jet4 09 • New Duke 00-01
• Shark 99-02 • Super Duke 99-02 • Symphony
09 • Symphony D.D. 09 • Symphony S 10 •
Symphony Sr 10 • Symply 07-08
150: Attila 00-01 • Euro Mx 02 • Euro Mx Eu2
03-04 • Fiddle li 10 • Shark 00-01 • Symphony
09 • Symphony S 10 • Symphony Sr 10
(R.O. 30410M92000)
Di primo Equipaggiamento – *OEM Quality*



24 604 0062 

125: Joyride Eu2 03-06 • Joyride Eu3 07 •
Joyride Evo 09
200: Joyride 03 • Joyride Eu2 03-04 • Joyride
Eu2 05-06
(R.O. 30400H9A000)
Di primo Equipaggiamento – *OEM Quality*



24 604 0222 

50: Mio 06-09
(R.O. 30410A1A910)
Di primo Equipaggiamento – *OEM Quality*





RELE' AVVIAMENTO - STARTER RELAY

24 640 0022 

RELE' AVVIAMENTO - STARTER RELAY

KIMCO 50: B&w Eu2 02-03 • CX-CX Super 93-97 • DJW-X-Y 91-00 • Dink Lc 98-02 • Dink Classic Reuro 2 02 • Fever ZX Eu2 99-04 • Filly 98-00 • Hero ISM 95-97 • K12-KB 95-00 • People S 05-08 • Sniper-DD 93-94 • Super 9-Sport Eu2 00-04 • Top Boy 97-00 • Yup 02

(R.O. 00168795 • 00169208)

Di primo Equipaggiamento – OEM Quality



24 640 0012 

RELE' AVVIAMENTO - STARTER RELAY

12V/100A

KIMCO 125: Agility Plus E4 16 • Agility Plus 14 Eu2 03-04 • B&w 125-150 00 • Dink Eu3 06-07 • Grand Dink 125-150 Eu2 03-04 • Grand Dink 125-150 01-02 • Like Lx 12 • Like 09 • Super 8 08-09 • **150:** Agility R16 08-09 • **200:** Agility 2001 R16 10 • Agility I Plus 14 • Agility R16 12 • Dink Eu3 i 06-07 • Like 2001 09 • Like Lx 12 • **250:** Grand Dink Eu2 03-04 • Grand Dink 01-02 • People Lc 03-04

(R.O. 00168997)

MALAGUTI 125: Ciak Master Euro 3 05

Ciak/Restyling Euro 2 Master

125-150 00/04-F18 Warror

125/150 00/02

(R.O. 02503700)

Di primo Equipaggiamento – OEM Quality



24 640 0082 

RELE' AVVIAMENTO - STARTER RELAY

SUZUKI 250: Burgman W-K2.K3-K6 98-06

400: Burgman X-K2-K3-K6-K7 Lo-L1-L2-L3 99-13

600: Gsx W-K3-K4-K6 99-06

650: Sv X-K2 99-02

750: Gsx W -K1-K3-K4-K6 99-06

800: VL Intruder - Volusia K1-K5-C-K6-Lo-L1-L3

01-13 • Vz Intruder M 800 K5-K9 -L0-L1-L3 05-13 •

Vz Marauder V-K2 97-02

900: Rf-Rr-T 94-96

1000: TL S-Su-K1 97-01 • TLR W-Y 98-00

1200: Gsx - X- K1 99-01

1500: VL Intruder Lcw-K3 98-03 • Lc-K5-K8 05-08

(R.O. 31800-21E20-000)



24 640 0052 

RELÈ AVVIAMENTO - STARTER RELAY

KYMCO 50: Filly 01-02 • Vitality 4T 04

(R.O. 00169999 • 38500-KDK-900)



24 640 0093 

TELERUTTORE - STARTER RELAY

PIAGGIO 125-150-200: Vespa PX • PXE

Arcobaleno-T5 VNX2-VLX1-VSX1-VNX5T

(R.O. 218824)



24 640 0143 

RELÈ AVVIAMENTO - STARTER RELAY

PIAGGIO 125: Vespa Px 30 anni 07-08 • Vespa Px Eu2 01-07 • Vespa Px 98-16

150: Vespa Px 11-16

VNX-VLX-VSX

(R.O. 233707)





RELÈ AVVIAMENTO

STARTER RELAY

24 640 0110



TELERUTTORE - STARTER RELAY

PIAGGIO 50: Ape Mix 2T 98-08 • Ape Rst Mix 99-03 • Ape 09 • Diesis 01 • Fly 2T 05-11 • Fly 4T & 25-30 Km/h 08-11 • Fly 4T 2V 25-30 Km/h 12 • Fly 4T 2V 13 • Fly 4T 2V 12-13 • Fly 4T Motore Chn 06-07 • Fly 4T 05-07 • Free Delivery 00-01 • Free FL 95-02 • Free 92-94 • Liberty 2T Rst 04 • Liberty 2T Sport 06-08 • Liberty 2T 06-08 • Liberty 4t Delivery - Single 10-12 • Liberty 4t Delivery Tnt 09 • Liberty 4T Ptt /Deu) 07-12 • Liberty 4T Ptt - Double 09-12 • Liberty 4T Rst 04 • Liberty 4T Sport 06-08 • Liberty 4T 00-08 • Liberty Moc 2T & Elle 09-13 • Liberty Moc 4T & Elle 09-13 • Liberty Ptt Eu2 04-05 • Liberty 97-05 • Nrg Extreme 99-00 • Nrg Mc3 01-04 • Nrg Power Dd Serie Speciale 07-12 • Nrg Power Dd 0513 • Nrg Power Dt Serie Speciale 07-08 • Nrg Power Dt 06-11 • Nrg Purejet 04-11 • Nrg Purejet 02-10 • Nrg Rst Mc2 96-98 • Nrg 94-96 • Ntt 95-96 • Puch P1-Tre 93-98 • Quartz 92-96 • Sfera Maquillage 2 94 • Sfera Rst 95-97 • Sfera 91-93 • Typhoon 2T Eu2 10-12 • Typhoon 01-11 • Velofax 96-99 • Vespa Et2 iniezione 97-00 • Vespa Et2 97-05 • Vespa Et4 00-05 • Vespa Lx 2T Touring & 30 Km10-13 • Vespa Lx 2T 05-13 • Vespa Lx 4T-4V Touring 10-13 • Vespa Lx 4T-4V 09-13 • Vespa Lx 4T 05-08 • Vespa Lxv 2T Navy 08 • Vespa Lxv 2T 06-09 • Vespa Primavera 2T 13-14 • Vespa Primavera 4T-4V 13-14 • Vespa S 2T & College 07-12 • Vespa S 4T-4V & College 08-12 • Vespa Sprint 2T 2V 14-14 • Vespa Sprint 4T 4V 14-14 • Zip 2T 08-13 • Zip 4T 00-13 • Zip Bimodale 94-97 • Zip Fast Raider Rst 96-97 • Zip Fast Raider 93-94 • Zip Rst 96-99 • Zip Sp Eu2 50 2006-2013 • Zip Sp 96-04 • Zip 92-04 • **80:** Skr City 99-99 • **100:** Fly 4T 06-07 • Fly 4T 08-08 • Free 02-03 • Zip 4T 06-10 • **125:** Beverly Euro 3 Mic 07-07 • Beverly Eu3 Sport 07-08 • Beverly Eu3 07-08 • Beverly Rst 4T 4V ie Eu3 10-13 • Beverly Rst 04-07 • Beverly Tourer Eu3 07-10 • Be-

verly 01-03 • Carnaby 07-10 • Fly 4T 3V ie E3 Dt 13-13 • Fly 4T 3V ie Eu3 Lem 12-13 • Fly Eu3 07-11 • Fly 05-07 • Hexagon Gtx 00-00 • Hexagon Lx-Lxt 98-99 • Hexagon Lx4 98-99 • Liberty 4T 2V Eu3 09-12 • Liberty 4T 2V ie Ptt - Ita 12-12 • Liberty 4T 3V ie E3 13-14 • Liberty 4T Eu3 Delivery - Single 07-12 • Liberty 4T Eu3 Delivery - Tnt 08-09 • Liberty 4T Eu3 07-08 • Liberty 4T Sport Eu3 06-08 • Liberty 4T 06-07 • Liberty Rst Ptt 05-11 • Liberty Rst 04-05 • Liberty Sport 06-06 • Liberty 98-02 • Mp3 Ibrido 09-10 • Mp3 ie Touring 11-12 • Mp3 ie 08-09 • Mp3 Yourban ERL 11-12 • Mp3 06-08 • Skipper 4T 00-02 • Skipper Lx 98-99 • Super Hexagon Gtx 12 01-02 • Typhoon 4T 2V Eu3 10-11 • Vespa Et4 96-02 • Vespa Granturismo Eu3 06-07 • Vespa Granturismo 03-07 • Vespa Gts 4T ie Super 09-13 • Vespa Gts Eu3 07-12 • Vespa Gtv 4T Navy Eu3 08-08 • Vespa Gtv 06-08 • Vespa Lx 4T 3V ie Touring 12-13 • Vespa Lx 4T Eu3 Touring 10-11 • Vespa Lx 4T FL 09-09 • Vespa Lx Eu3 ie 09-11 • Vespa Lx Eu3 06-08 • Vespa Lx Primavera 4T 3V ie 13-13 • Vespa Lx 05-06 • Vespa Lxv 4T Eu3 06-09 • Vespa Lxv 4T Navy Eu3 07-08 • Vespa Lxv ie 4T 10-13 • Vespa Px 30 Anni 07-08 • Vespa Px Eu2 01-07 • Vespa Px 98-13 • Vespa S 4T 3V ie 12-12 • Vespa S 4T Eu3 07-08 • Vespa S 4T ie & College 09-11 • Vespa Sprint 4T 3V ie 14-14 • X Evo 07-12 • X7 Eu3 08-08 • X7 Evo ie Eu3 09-10 • X8 Premium Eu2 06-06 • X8 Premium Eu3 06-07 • X8 Street Eu2 06-07 • X8 04-06 • X9 Evolution Eu3 07-07 • X9 Evolution 03-06 • X9 01-02 • Zip 00-02 • **150:** Fly Eu3 08-11 • Fly 05-07 • Liberty 4T Eu3 08-08 • Liberty 4T Sport Eu3 08-08 • Liberty Moc 4T Eu3 09-13 • Vespa Lx 4T 3V ie - Touring 12-13 • Vespa Lx 4T FL 09-09 • Vespa Lx Eu3 ie 09-11 • Vespa Lx Eu3-4 06-08 • Vespa Lx Touring 10-12 • Vespa Lx 05-06 • Vespa Primavera 4T-3V 13-13 • Vespa 11-13 • Vespa S 4T ie & College 09-12 •

Vespa S 4T 08-09 • X8 Street Eu2 06-08 • **180:** X9 Amalfi 00-03 • **200:** Carnaby 07-08 • Liberty 4T Eu3 06-08 • Liberty 4T Sport Eu3 06-07 • Liberty Rst 04-04 • Liberty Sport 06-06 • Liberty 06-06 • Vespa Granturismo 06-07 • X8 05-07 • X9 Evolution 03-03 • X9 02-03 • **250:** Beverly Cruiser 07-09 • Beverly Eu3 Mic 07-07 • Beverly ie Eu3 06-08 • Beverly Rst 04-05 • Beverly Sport 06-08 • Beverly Tourer Eu3 08-09 • Beverly 06-07 • Carnaby 08-08 • Mp3 Lt 08-09 • Mp3 Mic 08-09 • Mp3 06-08 • Vespa Gt 60 Eu3 06-07 • Vespa Gts Abs 05-12 • Vespa Gts 05-13 • Vespa Gtv 4T Navy Eu3 07-07 • Vespa Gtv 06-09 • X Evo 07-13 • X7 Eu3 08-08 • X8 Eu3 05-08 • X9 Evolution 04-04 • X9 Evolution 06-06 • **300:** Beverly Rst 4T 4V ie Eu3 10-14 • Beverly Tourer Eu3 09-10 • Carnaby Cruiser 09-12 • Mp3 ie Lt 10-11 • Mp3 ie Mic 10-10 • Mp3 ie Mic 11-11 • Mp3 4T 4V ie ERL Ibrido 10-13 • Mp3 4T 4V ie Lt Ibrido 10-11 • Mp3 ie Lt Touring 11-12 • Mp3 ie Lt - ie Lt Sport 11-13 • Mp3 ie Touring 11-12 • Mp3 Yourban ERL 11-11 • Mp3 Yourban Lt ERL 11-12 • Vespa Gts ie Touring 11-12 • Vespa Gts ie 12-13 • Vespa Gts Super Sport 10-13 • Vespa Gts Super 08-13 • Vespa Gtv 4T 4V ie 10-13 • Vespa Gtv Via Montenapoleone 10-10 • X7 Evo ie Eu3 09-10 • **420:** Ape Tm Diesel Lcs 05-12 • **500:** Quargo 05-12 • X9 Evolution Abs 06-07 • X9 Evolution 06-07 • X9 01-02 • **1200:** Porter D120 E5 11-13 • **1300:** Porter Multitech Eu4 - Eu5 10-13 • Porter Up-Date 09-09 • **1400:** Porter Pick Diesel 98-05 (R.O. 58115R)





APRILIA

24 601 0040

50: Amico GL-GLE • Amico Lx- Sport-Cat 92-93 • Amico 94-98 • Gulliver 95-98 • Gulliver Lc 96-98 • Rally Liquid Cooled 96-99 • Rally 95-03 • Scarabeo 93-05 • Sonic Gp 98-08 • Sonic 98-07 • Sr Liquid Cooled 94-96 • Sr Stealth, Racing 97-99 • Sr Www 97-01 • Sr 93-96
(R.O. AP8206125)

24 601 0092

125-150: Leonardo 96-01
(R.O. AP0265417)
Di primo Equipaggiamento – *OEM Quality*

24 601 0102

50: Mojito 04-08 • Scarabeo Street 2T Rst 06-09 • Scarabeo 2T Net 09-10 • Sport City One 2T 08-10 • Sr R Factory ie e Carburatore 10-11 • Sr R R Factory 04-09 • Sr Street 03-08 • Scarabeo Street 05-06
(R.O. 58095R)
Di primo Equipaggiamento – *OEM Quality*

24 601 0122

50: Mojito 99-03 • Mojito Custom 93-03 • Mojito Retro 93-03 • Sr H2O Ditech e Carburatore 00-03
(R.O. AP2RD4000034)
Di primo Equipaggiamento – *OEM Quality*

24 601 0132

50: Scarabeo 4T 4V Net 09-10 • Scarabeo 4T 4V 10-12 • Scarabeo Quattro 09
125: Atlantic Eu3 06-08 • Sport City Eu3 06-08 • Sr Max 11
250: Sport City Cube 08-10 • Scarabeo Light 06-08
300: Atlantic 10-11 • Scarabeo Light 09-10 • Sport City Street 12 • Sr Max 11-13
400: Atlantic Sprint 05-08 • Scarabeo Light 400-500 06-08
500: Atlantic 01-04 • Scarabeo 03-06
(R.O. 828817)
Di primo Equipaggiamento – *OEM Quality*

24 601 0490

Non limitata - *No power limitation*

24 601 0491

Limitata - *Power limitation 8000RPM*
50: Scarabeo 4T Restyling Eu3 06-09 • Scarabeo 4T 02-06
(R.O. AP8224487)



BENELLI

24 601 0501

Limitata - *Power limitation 11000RPM*
100: Scarabeo 4T 01-05
(R.O. AP8127310)

24 601 0040

50: 491 Gt 98-99 • 491 Rr 98-01 • 491 Sp 99 • 491 Sport 98-99 • 491 St • K2 Liquid Cooled 99-01 • K2 98-01 • Naked 02 • Pepe Lx 03-04 • Pepe 99-01
(R.O. R51240011A0)

24 601 0082

125-150: Adiva 01-02
(R.O. R51240131A0)
Lunghezza cavo 40 cm - *Cable lenght 40 cm*





CENTRALINE - BOBINE
COILS

BETA

24 601 0030



50: Ark Air 96-07 • Ark Lc Serie K 04-07 • Ark Lc 96-03 • Quadra Chrono 502 95-99 • Tempo 96-99
(R.O. 1120670000)



DERBI

24 601 0102



50: Boulevard 2T 09 • Variant Sport 2T 12
(R.O. 58095R)
Di primo Equipaggiamento – *OEM Quality*



24 601 0132



125: Rambla Eu3 2Ver 08 • Rambla 08-09
250: GP1 Low Seat Eu3 07-08
250: Rambla Eu3 2Ver 08 • Rambla 08-09
300: Rambla 10-11
(R.O. 828817)
Di primo Equipaggiamento – *OEM Quality*



24 601 0490



Non limitata - *No power limitation*

24 601 0491



Limitata - *Power limitation 8000RPM*
50: Atlantis 4T 04-06
(R.O. 969383)



24 601 0501



Limitata - *Power limitation 11000RPM*
100: Atlantis 4T 04-06
(R.O. 969896)



GILERA

24 601 0010



50: Easy Moving 95-96 • Storm 94-95
• Typhoon 94-97
(R.O. 826115)



24 601 0072



24 601 0070



50: Stalker 97-04
(R.O. 638678)



24 601 0102



50: Dna 05-07 • Runner Sp 05-07 • Runner Sp Spec Edition 07 • Runner Sp St & Simoncelli 08-09 • Stalker 97-11 • Stalker Naked 08 • Stalker Spec Edition 07-08 • Storm Eu2 07 • Runner Sp 10 v Dna 00-02 • Dna Gp Experience 03-04 • Ice 01-05 • Runner Poggiali 02 • Runner Sp 02-04
(R.O. 58095R)
Di primo Equipaggiamento – *OEM Quality*





GILERA

24 601 0082 

125-200: Runner Vx-Vxr 02-04
(R.O. 829337)

Lunghezza cavo 40 cm - *Cable lenght 40 cm*

24 601 0132 

125: Nexus Eu3 ie 08-10

250: Nexus 03 07 • Nexus Eu3 06 • Nexus Sp
Eu3 06-07

300: Nexus Eu3 08-11

500: Nexus Eu3 06-11 • Nexus Sp Eu3 06-07
Nexus 03-05

(R.O. 828817)

Di primo Equipaggiamento - *OEM Quality*



HONDA

24 601 0082 

50: Sj Bali 93-> • Gp Dio 91-> • Sh 91-96 • Sfx
V 95->

100: Sj Bali 96-99 • Sh 96-99

125: Chiocciola 00-06 • Dylan 01-06 • Sh 125 01-08

150: Chiocciola 00-06 • Dylan 01-06 • Sh 150 01-08
(R.O. 30510-GW2-000)

Lunghezza cavo 40 cm - *Cable lenght 40 cm*



KYMCO

24 601 0092 

250: Grand Dink Eu2 03-04 • Grand Dink 01-02
(R.O. 00168940)

Di primo Equipaggiamento - *OEM Quality*

24 601 0152 

200: Dink Eu 3 I 06-07

(R.O. 00169238•3051A-LEA6-900)

Di primo Equipaggiamento - *OEM Quality*

24 601 0172 

200: Agility R16 10 • Agility R16 12

• Like I 09 Like Lx 12

(R.O. 00130026)

Di primo Equipaggiamento - *OEM Quality*



MALAGUTI

24 601 0030 

50: Centro Base 93-94 • Centro SL Kat 99-00 •
Centro SL 94-98 • Ciak Mono Eu2 03 • Ciak Td
00-01 • Ciak 99-00 • F10 Jet Line 92-98 • F10 Kat
99-00 • F10 Rst Eu1 01-02 • F10 Rst Eu2 02-03
• F12 Phantom Eu1 99-00 • F12 Phantom Lc
Eu1 99-00 • F12 Phantom Lc Rst Eu1 01-02 •
F12 Phantom Lc Twin Disks 98 • F12 Phantom
Lc 94-98 • F12 Phantom Rst Eu1 01-02 • F12
Phantom Rst Eu2 02 • F12 Phantom 94-98 • F15
Fire Fox Twin Disks & Spec 98-99 • F15 Fire Fox
Twin Disks Digit Kat 98-00 • F15 Fire Fox 96-98
• F15 Lc-Tds Rst Eu1 01 • Yesterday • Yesterday
Eu 97-00
(R.O. 02403300)

24 601 0040 

50: Centro SL 94-98 • F10 Jet Line 92-98
(R.O. 02403000)

24 601 0082 

125: Madison 3 06-09

180: Madison R 01-02

200: Madison S Rst Eu2 03 • Madison S Rst 02 •
Phantom Max 03

250: Madison Rs Rst 04 • Phantom Max 04
(R.O. 02410400)

Lunghezza cavo 40 cm - *Cable lenght 40 cm*





CENTRALINE - BOBINE

COILS

MALAGUTI

24 601 0092



250: Madison S 99-01

(R.O. 02404800)

Di primo Equipaggiamento – *OEM Quality*



24 601 0132



250: Madison 3 06-09

500: Spidermax Gt 04-05 • Spidermax Gt Eu3 06

(R.O. 02412300)

Di primo Equipaggiamento – *OEM Quality*



MBK

24 601 0040



50: Cw Booster Naked 03 • Cw Booster Spirit Eu2 02-03 • Cw Booster Spirit [I] 99-00 • Cw Booster Spirit 96-98 • Cw Booster 90-91 • Cw Booster 01-02 • Cw L Booster Spirit 03 • Cw L Booster 01-03 • Cw R Booster Road (Ita) 94-95 • Cw Rs Booster Ng Eu1 99-00 • Cw Rs Booster Ng [I] 95-99 • Cw Rs Booster Ng 01-03 • Cw Rsp Booster Rocket [I] 97-98 • Cw Rsx Booster Track [I] 96-98 • Ew Stunt 00-02 • Ya R Forte (Che-Ita) 94-96 • Ye Evolis [I] 92-95 • Yh Flipper Catalitico 99-00 • Yh Flipper Eu2 03-04 • Yh Flipper 98 • Yh Flipper 01-02 • Ym Fizz [I] 94-95 • Yn R Ovetto (Che-Ita) 97-01 • Yn R Ovetto Eu1 02-04 • Yn R Ovetto Eu2 02-03 • Yq L Nitro Jaguar 04 • Yq Nitro Eu2 03 • Yq Nitro [I] 99-00 • Yq Nitro 04 • Yq Nitro 01-02
(R.O. 3KJ823101000)



24 601 0092



250: Yp Skyliner Abs 03

250: Yp Skyliner Abs 03 • Yp Skyliner 00-03
(R.O. 4HC823100000)

Di primo Equipaggiamento – *OEM Quality*



PEUGEOT

24 601 0132



300: Geopolis

400 Satelis • Geopolis

Di primo Equipaggiamento – *OEM Quality*



24 601 0142



50: Elyseo 04 • Looxor Carb. 04 • Ludix 10 One 04 • Ludix 10 Sp Blaster 04 • Ludix 10 Trend • Snake 04 • Ludix 14 Classic 04 • Ludix 14 Elegant 04 • Metal-X 97-> • Squab 97-> • Trekker 04 • Trk2 Wrc 97-> • X-Fight 04 • Zenith L 97->

100: Elyseo • Looxor Carb. • Speedfight • Trekker
(R.O. 738724)

Di primo Equipaggiamento – *OEM Quality*

Lunghezza cavo 30 cm - *Cable lenght 30 cm*





PIAGGIO

24 601 0010

50: Sfera Rst 95-97 • Zip 92-96
125: Hexagon 94-97 • Hexagon Lx-Lxt 98-99 • Hexagon Lx4 98-99 • Liberty 98-00 • Sfera 95-97 • Skipper 94-97 • Skipper Lx 98-99 • Vespa Et4 96-98
150: Hexagon 94-97 • Skipper 94-97 • Skipper Lx 98-99
180: Hexagon Lx-Lxt 98-99
 (R.O. 826115)

24 601 0050 **NEW**

24 601 0051

50: Ape Eu2 03-10 • Ape FL • FL2 89-95 • Ape FL3 Eupa 96-99 • Ape Rst Mix 99-05 • Ape Tm P 85-89 • Vespa 67-82 • Vespa FL 90 • Vespa FL2 Autom 90-91 • Vespa FL2 Hp 91-97 • Vespa N 89-90 • Vespa Pk 82-84 • Vespa Pk S Automatica 84-89 • Vespa Pk XL Plurimatic 85-90 • Vespa Pk XL Rush 88-89 • Vespa Pk XL 85-88
125: Cosa 2 91-97 • Cosa CL-CLX 88-91 • Vespa FL 89-90 • Vespa Px 98-01 • Vespa Px 30 Anni 07-08 • Vespa Px Eu2 01-07 • Vespa Px T5 85-89 • Vespa Pxe Arcobaleno 81-97 • Vespa Pk 82-84 • Vespa 67-82 • Vespa Pk S Autom 84-89
150: Cosa CL-CLX 88-91 • Cosa 2 91-97 • Vespa Px 98-01 • Vespa Pxe Arcobaleno 81-87
200: Cosa 2 91-97 • Cosa CL-CLX 88-91 • Vespa Px 98-01 • Vespa Pxe Arcobaleno 81-97
 (R.O. 2441285)

24 601 0062

24 601 0060

50: Ciao Eu1 99-01 • Ciao Eu2 02-04 • Ciao Mix Teen 96-01 • Ciao Tre 71-99 • Si FL2 91-97 • Si Mix 96-99 • Si 79-88 • Vespa Pk XL Rush 88-89 • Vespa Pk XL 85-88
 (R.O. 2441275)

24 601 0072
24 601 0070

50: Free FL 95-02 • Nrg Mc3 01-04 • Nrg Rst Mc2 96-98 • Sfera Maquillage 2 94 • Sfera Rst 95-97 • Vespa Et2 97-05 • Zip Rst 96-99 • Zip Sp 96-00 • Liberty Ptt Eu2 04-05
 (R.O. 638678)

24 601 0082

125: Beverly 01-03 • Beverly Eu3 Mic 07 • Beverly Eu3 Sport 07-08 • Beverly Rst 04-07 • Beverly Tourer Eu3 08-09 • Carnaby 07-09 • Hexagon Gtx 00 • Liberty 01-02 • Liberty 4T Eu3 07-08 • Liberty 4T Sport Eu3 06-08 • Liberty Rst Ptt 05-06 • Liberty Rst 04-05 • Liberty Sport 06 • Super Hexagon Gtx 12 01-02 • Vespa Et4 99-02 • Vespa Granturismo 03-05 • Vespa Granturismo Eu3 06-07 • Vespa Gts Eu3 07-09 • Vespa Gtv 4T Navy Eu3 08 • Vespa Gtv 07-08 • Beverly Eu3 07-08 • Liberty 4T Eu3 Delivery 08 • Liberty 4T 06-07
150: Liberty 01-02 • Vespa Et4 99-02 • Liberty 4T Eu3 08 • Liberty 4T Sport Eu3 08 • Liberty Moc 4T 09
180: Hexagon Gtx 00 • S. Hexagon Gtx 12 01-02
200: Beverly 01-03 • Carnaby 07-08 • Liberty 4T Eu3 07-08 • Liberty 4T Sport Eu3 06-07 • Liberty Rst 04 • Liberty Sport 06 • Vespa Granturismo 06-07 • Liberty 06
250: Beverly Rst 04-05 • Beverly 06-07
 (R.O. 829337)

Lunghezza cavo 40 cm - Cable lenght 40 cm

24 601 0102

50: Fly 2T 10 • Liberty Moc 2T & Elle 09-11 • Liberty 2T 06-08 • Liberty 2T Sport 07-08 • Nrg Mc3 01-04 • Nrg Power Dd 06-10 • Nrg Power Dd Serie Spec 07-10 • Nrg Power Dt 06-08 • Nrg Power Dt Serie Spec 07-08 • Typhoon 05-09 • Typhoon 2T Eu2 10-11 • Vespa Lx 2T 05-08 • Vespa Lx 2T FL 09-10 • Vespa Lxv 2T 06-08 • Vespa Lxv 2T Navy 08 • Vespa S 2T & College 07-11 • Zip 00-04 • Zip Sp Eu2 06-09 • Zip 2T 08-10 • Diesis 01 • Fly 2T 05-07 • Liberty 2T Rst 04 • Nrg Power Dd 05 • Typhoon 01-04 • Zip Sp 01-04
 (R.O. 58095R)

Di primo Equipaggiamento - OEM Quality





CENTRALINE - BOBINE

COILS

PIAGGIO

24 601 0132

50: Fly 4T 4V 12 • Vespa Lx 4T 4V Touring 10-13 • Vespa Lx 4T 4V 09-13 • Vespa S 4T 4V & College 08-12
125: Beverly Rst 4T 4V ie Eu3 10-13 • Liberty 4T 2V ie Ptt-Ita 12 • Liberty 4T 3V ie E3 13 • Vespa Gts 4T ie Super 09-13 • Vespa Lx 4T Eu3 Touring 10-11 • Vespa Lx Eu3 ie 09-10 • Vespa Lxv ie 4T 10-12 • Vespa S 4T ie & College 09-11 • X7 Evo ie Eu3 09-10
150: Vespa Lx Eu3 ie 09-11 • Vespa Lx touring 10-12 • Vespa S 4T ie & College 09-12
250: Beverly Cruiser 07-09 • Beverly Eu3 Mic 07 • Beverly ie Eu3 06-08 • Beverly Sport 06-08 • Beverly Tourer Eu3 08-09 • Carnaby 08 • Mp3 Lt 09 • Mp3 Mic 08-09 • Mp3 06-08 • Vespa Gt 60 Eu3 06-07 • Vespa Gts Abs 05-12 • Vespa Gts 05-13 • Vespa Gtv 4T Navy Eu3 08 • Vespa Gtv 06-09 • XEvo 07-13 • X7 Eu3 08 • X8 Eu3 05-08
300: Beverly Rst 4T 4V ie Eu3 10-13 • Beverly Tourer Eu3 09-10 • Carnaby Cruiser 09-12 • Vespa Gts ie Touring 11-12 • Vespa Gts ie 12-13 • Vespa Gts Super Sport 12-13 • Vespa Gts Super 08-13 • Vespa Gtv 4T 4V ie 10-13 • Vespa Gtv Via Montena-poleone 10 • X7 Evo ie Eu3 09-10
400: Beverly Eu3 06-07 • Beverly Tourer Eu3 08-10 • Mp3 ie Lt - Sport 08-10 • Mp3 ie Lt Touring 11 • Mp3 Mic 08-11 • Mp3 RL Touring 11 • Mp3 07-08 • X Evo 07-11 • X8 Eu3 06-08
500: Beverly Eu3 06-08 • Beverly 02-06 • X9 Evolution Abs 06-07 • X9 Evolution 03-07 • X9 01-02 • (R.O. 828817)
 Di primo Equipaggiamento – *OEM Quality*



24 601 0201

220: Ape Car P2-P3 78-85 • Ape Mp P501-P601 78-96 • Ape Tm P602 82-83 • Ape Tm P703 FL2 84-05 • Ape Tm 09-12
 (R.O. 2441295)



24 601 0211

125: Skipper 94-97 • Skipper Lx 98-99
 (R.O. 2920345)



24 601 0192

125: Hexagon Lx4 98-99 • Liberty 98-00 • Sfera 95-97 • Vespa Et4 96-98
 (R.O. 294150)



24 601 0582

50: Ape FL - FL2 89-95 • Ape FL3 Europa 96-99 • Ape Rst Mix 99-03 • Ape Tm P 85-89 • Ape 09-16 • Vespa 50-125 67-82 • Vespa FL 90 • Vespa FL2 Automatica 90-91 • Vespa FL2 Hp 91-97 • Vespa N 89-90 • Vespa Pk Automatica 84-89 • Vespa Pk XL Plurimatic 85-90 • Vespa Pk XL Rush 88-89 • Vespa Pk XL 85-88 • Vespa Pk 82-84 • **125:** Cosa 2 91-97 • Cosa CL-CLX 88-91 • Vespa FL 89-90 • Vespa Px Eu2 01-07 • Vespa Px T5 85-89 • Vespa Px 98-01 • Vespa Pxe Arcobaleno 81-97
 (R.O. 2441285)



24 601 0482

50: Ape 09-15
 (R.O. 642219)



24 601 0472

125-150: Vespa Px
 (R.O. 642443)



24 601 0490

Non limitata - *No power limitation*

24 601 0491

Limitata - *Power limitation 8000RPM*
50: Fly 4T 25-30 Km/h 08-11 • Fly 4T 2V 13-15 • Fly 4T 05-07 • Liberty 4T Delivery Single 10-14 • Liberty 4T Delivery Tnt 09 • Liberty 4T Ptt (Deu) 07-12 • Liberty 4T Ptt - Double - Nexive 09-15 • Liberty 4T Sport 06-08 • Liberty 4T 05-08 • Liberty Moc 4T & Elle 09-13 • Vespa Lx 4T 05-08 • Liberty 4T Rst 04 • Liberty 4T 00-02 • Vespa Et4 00-05 • Zip 4T 00-05
 (R.O. 639978)



24 601 0501

Limitata - *Power limitation 11000RPM*
100: Free 02-03 • Zip 4T 06-10
 (R.O. 969896)





YAMAHA

24 601 0040 

50: Bw'S Bump 97-98 • Bw'S Naked 03 • Bw'S Next Gen Cat. 99-00 • Bw'S Next Gen 97-06 • Bw'S Original Eu2 03 • Bw'S Original 97-02 • Cw Sp Bw'S Original Eu2 02 • Cw L Bw'S 03 • Cw Rs Spy 95-98 • Dtr-Dtx 08 • Ew Slider 00-02 • Pw 04-08 • Ya R Axis 95-96 • Yh Why Eu1 99-00 • Yh Why Eu2 03-05 • Yh Why 98-02 • Ym Breeze 94-95 • Yn Neo'S Eu2 02-03 • Yn Neo'S 04-06 • Yn R Neo'S 97-01 • Yq Aerox R 99-00 • Yq Aerox 97-10 • Yq L Aerox Eu2 03

80: Yz Lc-Lw 97 • Yz N-Lw 01

100: Yn Neo'S 99-02 • Yq Aerox 00-02

125: Dt R 99-00 • Sr 99-00 • Tw 99-03 • Xn Teo'S 00 • Yp Majesty 98-00

150: Yp Majesty 01-02

(R.O. 3KJ823101000)

24 601 0092 

250: Yp Majesty Abs 03 • Yp Majesty Dx 98-99 •

Yp Majesty 96-03

(R.O. 4HC823100000)

Di primo Equipaggiamento – *OEM Quality*



SYM

24 601 0162 

125: Hd Eu 2 03-04 • Hd Eu 3 07-08 • Hd Evo Eu 3 07-10 • Hd Evo Tamburo Eu 3 08-09 • Hd Evo 05-06 • Joyride Eu 2 03-04 • Joyride 01-02

200: Hd Eu 2 03-04 • Hd Evo Eu 2 05 • Joyride Eu 2 03-04 • Joyride 03

(R.O. 3051AH9A000)

Di primo Equipaggiamento – *OEM Quality*

SUZUKI

24 601 0112 

50: Tr S Street Magic

110: Ug Hokuto

125: An S-Y • Uc Epicuro X-K1 99-01 • Ue Ct K1

150: Uc Epicuro X-K1 99-01 • Ue Ct K1

(R.O. 33410-43E00-000)

(R.O. 33410-20E001-000)

Di primo Equipaggiamento – *OEM Quality*



24 601 0222

BOBINA ZS030
ZS030 COIL



24 601 0232

BOBINA ZS054
ZS054 COIL



24 601 0242

BOBINA ZS056
ZS056 COIL



24 601 0252

BOBINA ZS085
ZS085 COIL



24 601 0262

BOBINA ZS105
ZS105 COIL



24 601 0272

BOBINA ZS224
ZS224 COIL



24 601 0282

BOBINA ZS284
ZS284 COIL



24 601 0292

BOBINA ZS377
ZS377 COIL



24 601 0302

BOBINA ZS378
ZS378 COIL



24 601 0312

BOBINA ZS383
ZS383 COIL



24 601 0322

BOBINA ZS384
ZS384 COIL



24 601 0332

BOBINA ZS385
ZS385 COIL



24 601 0342

BOBINA ZS386
ZS386 COIL



24 601 0352

BOBINA ZS439
ZS439 COIL



24 601 0362

BOBINA ZS440
ZS440 COIL



24 601 0372

BOBINA ZS441
ZS441 COIL



24 601 0382

BOBINA ZS443
ZS443 COIL



24 601 0392

BOBINA ZS057
ZS057 COIL



24 601 0402

BOBINA ZSE130
ZSE130 COIL



24 601 0412

BOBINA ZS078
ZS078 COIL



24 601 0422

BOBINA ZS106
ZS106 COIL



24 601 0442

BOBINA ZS444
ZS444 COIL



24 601 0452

BOBINA ZS523
ZS523 COIL



24 601 0462

BOBINA ZS524
ZS524 COIL



24 601 0590

CENTRALINA ACCENSIONE ZM001
IGNITION MODULE ZM001



24 601 0600

CENTRALINA ACCENSIONE ZM002
IGNITION MODULE ZM002



24 601 0610

CENTRALINA ACCENSIONE ZM026
IGNITION MODULE ZM026



24 601 0622

BOBINA ZS109 12V
ZS109 COIL



24 601 0632

BOBINA ZS117 12V
ZS117 COIL



24 601 0642

BOBINA ZS118 12V
ZS118 COIL



24 601 0652

BOBINA ZS210 AT ESTERNA 3V
ZS210 COIL AT 3V
Per/For Ducati Racing • MV Agusta Racing
• Moto D'Epoca Racing



24 601 0662

BOBINA ZS215 AT ESTERNA
ZS215 COIL AT
Per/For Impianti Marelli • Cagiva • Ducati •
Laverda • Moto Guzzi



24 601 0672

BOBINA ZS220
ZS220 COIL



24 601 0682

BOBINA ZS283
ZS283 COIL



24 601 0692

BOBINA ZS400 12V
ZS400 COIL



BOBINE - CENTRALINE ACCENSIONE

COIL - IGNITION MODULE



Modello - Model	Cc	Anno Year	Codice RMS RMS Code	Descrizione Description	Modello - Model	Cc	Anno Year	Codice RMS RMS Code	Descrizione Description
APRILIA					R 850 R	850	99 07	24 601 0272	Bobina
SI 750 Shiver	750	07 16	24 601 0402	Bobina	R 850 Rt	850	96 06	24 601 0272	Bobina
SI 750 Shiver Gt	750	09 09	24 601 0402	Bobina	R 90 S	900	73 77	24 601 0662	Bobina
Smv 750 Dorsoduro	750	08 16	24 601 0402	Bobina	R 90/6	900	73 76	24 601 0662	Bobina
Smv 750 Dorsoduro Factory	750	10 13	24 601 0402	Bobina	R 900 Rt (05Sf, 10Sf)	900	05 13	24 601 0312	Bobina Sx
Smv 750 Dorsoduro Factory Abs	750	10 13	24 601 0402	Bobina	R 900 Rt (05Sf, 10Sf)	900	05 13	24 601 0322	Bobina Dx
BENELLI					R 100 GS Dakar	980	87 95	24 601 0600	Centralina accensione
Tornado 1St Series	650	71	24 601 0672	Bobina	R 100 GS Dakar Classic	980	95 96	24 601 0600	Centralina accensione
Tornado S 2Nd Series	650	72 76	24 601 0672	Bobina	R 100 GS, PD	980	92 96	24 601 0600	Centralina accensione
Cafe' Racer 899	899	10 10	24 601 0292	Bobina	R 100 R, R Mystic	980	91 96	24 601 0600	Centralina accensione
Century Racer 899	899	10 12	24 601 0292	Bobina	R 100 Rs	980	76 80	24 601 0262	Bobina
Tnt 899	899	07 12	24 601 0292	Bobina	R 100 RS	980	80 84	24 601 0600	Centralina accensione
Tnt 899 S	899	08 09	24 601 0292	Bobina	R 100 Rt	980	78 80	24 601 0262	Bobina
Tre 899 K	899	07 12	24 601 0292	Bobina	R 100 RT	980	80 84	24 601 0600	Centralina accensione
Tnt	1130	04 06	24 601 0292	Bobina	R 100 S	980	76 80	24 601 0262	Bobina
Tnt Cafe' Racer	1130	05 11	24 601 0292	Bobina	R 100 T	980	78 80	24 601 0262	Bobina
Tnt R 160	1130	10 14	24 601 0292	Bobina	R 100, CS	980	80 84	24 601 0600	Centralina accensione
Tnt Sport	1130	05 09	24 601 0292	Bobina	R 100/7	980	76 80	24 601 0262	Bobina
Tnt Titanium	1130	05 09	24 601 0292	Bobina	K 1	1000	88 93	24 601 0610	Centralina accensione
Tornado Tre	1130	07 10	24 601 0292	Bobina	K 100 RS	1000	89 92	24 601 0610	Centralina accensione
Tre K	1130	06 12	24 601 0292	Bobina	R 100	1000	76 77	24 601 0662	Bobina
Tre K Amazonas	1130	07 11	24 601 0292	Bobina	R 100 Cs	1000	80 85	24 601 0662	Bobina
BMW					R 100 Rs	1000	76 85	24 601 0662	Bobina
C1 125 Scooter	125	00 03	24 601 0222	Bobina	R 100 S	1000	76 81	24 601 0662	Bobina
C1 200 Scooter	200	99 03	24 601 0222	Bobina	R 100 Tic Touring	1000	81 85	24 601 0662	Bobina
R 27	250	60 66	24 601 0662	Bobina	R 100/T	1000	78 85	24 601 0662	Bobina
R 45	450	78 80	24 601 0262	Bobina	K 1100 LT	1100	92 99	24 601 0610	Centralina accensione
R 45	450	80 85	24 601 0600	Centralina accensione	K 1100 LT High Line	1100	97 99	24 601 0610	Centralina accensione
R 45/N	450	78 80	24 601 0262	Bobina	K 1100 LT Special Edition	1100	94 99	24 601 0610	Centralina accensione
R 45/N	450	78 80	24 601 0662	Bobina	K 1100 RS	1100	93 96	24 601 0610	Centralina accensione
R 45/N	450	80 85	24 601 0600	Centralina accensione	R 1100 Gs	1100	94 00	24 601 0272	Bobina
R 50/5	500	69 75	24 601 0662	Bobina	R 1100 Gs	1100	94 06	24 601 0272	Bobina
R 60/5	600	69 75	24 601 0662	Bobina	R 1100 R	1100	93 06	24 601 0272	Bobina
R 60/6	600	73 77	24 601 0662	Bobina	R 1100 Rs	1100	92 01	24 601 0272	Bobina
R 60/7	600	76 81	24 601 0662	Bobina	R 1100 Rt	1100	93 01	24 601 0272	Bobina
R 60/7	600	78 80	24 601 0262	Bobina	R 1100 S	1100	03 06	24 601 0332	Bobina Sx-Dx
R 60/7 Tic	600	78 81	24 601 0662	Bobina	R 1100 S	1100	96 02	24 601 0272	Bobina
F 650 Gs	650	99 03	24 601 0222	Bobina	R 1100 S Abs	1100	01 06	24 601 0332	Bobina Sx-Dx
F 650 Gs	650	06 12	24 601 0342	Bobina	R 1100 S Abs	1100	03 06	24 601 0272	Bobina
F 650 Gs Dakar	650	99 03	24 601 0222	Bobina	R 1150 Gs	1150	02 03	24 601 0332	Bobina Sx-Dx
R 65	650	78 80	24 601 0262	Bobina	R 1150 Gs	1150	98 03	24 601 0272	Bobina
R 65	650	78 80	24 601 0662	Bobina	R 1150 Gs Adv	1150	02 05	24 601 0332	Bobina Sx-Dx
R 65 GS	650	87 92	24 601 0600	Centralina accensione	R 1150 Gs Adv	1150	01 05	24 601 0272	Bobina
F 700 Gs	700	11 14	24 601 0342	Bobina	R 1150 R	1150	02 06	24 601 0332	Bobina Sx-Dx
R 75/5	750	69 75	24 601 0662	Bobina	R 1150 R	1150	99 06	24 601 0272	Bobina
R 75/6	750	73 77	24 601 0662	Bobina	R 1150 R	1150	01 02	24 601 0272	Bobina
R 75/7	750	76 79	24 601 0262	Bobina	R 1150 R Rockster	1150	02 05	24 601 0332	Bobina Sx-Dx
R 75/7	750	76 79	24 601 0662	Bobina	R 1150 Rs	1150	02 05	24 601 0332	Bobina Sx-Dx
F800 Gs	800	06 14	24 601 0342	Bobina	R 1150 Rs	1150	00 04	24 601 0272	Bobina
F800 Gs Adv	800	12 14	24 601 0342	Bobina	R 1150 Rt	1150	02 06	24 601 0332	Bobina Sx-Dx
F800 Gt	800	11 14	24 601 0342	Bobina	R 1150 Rt	1150	00 06	24 601 0272	Bobina
F800 R	800	05 14	24 601 0342	Bobina	Hp 2 Enduro	1200	04 06	24 601 0312	Bobina Sx
F800 S	800	04 10	24 601 0342	Bobina	Hp 2 Enduro	1200	04 06	24 601 0322	Bobina Dx
F800 St	800	04 12	24 601 0342	Bobina	Hp 2 Megamoto	1200	06 08	24 601 0312	Bobina Sx
R 80	800	77 85	24 601 0662	Bobina	Hp 2 Megamoto	1200	06 08	24 601 0322	Bobina Dx
R 80 GS	800	80 87	24 601 0600	Centralina accensione	K 1200 Gt	1200	04 08	24 601 0342	Bobina
R 80 GS	800	90 95	24 601 0600	Centralina accensione	K 1200 R	1200	04 08	24 601 0342	Bobina
R 80 GS Basic	800	96 96	24 601 0600	Centralina accensione	K 1200 R Sport	1200	05 07	24 601 0342	Bobina
R 80 GS, BD	800	87 95	24 601 0600	Centralina accensione	K 1200 S	1200	03 08	24 601 0342	Bobina
R 80 Rt	800	82 85	24 601 0662	Bobina	R 1200 C	1200	96 03	24 601 0272	Bobina
R 80 Rt	800	84 85	24 601 0662	Bobina	R 1200 C Cruiser	1200	93 03	24 601 0272	Bobina
R 80 RT	800	84 85	24 601 0600	Centralina accensione	R 1200 C Independent	1200	00 03	24 601 0272	Bobina
R 80 RT	800	85 95	24 601 0600	Centralina accensione	R 1200 Gs	1200	02 09	24 601 0312	Bobina Sx
R 80 ST	800	82 84	24 601 0600	Centralina accensione	R 1200 Gs	1200	02 09	24 601 0322	Bobina Dx
R 80 Tic	800	78 85	24 601 0662	Bobina	R 1200 Gs Adv	1200	05 09	24 601 0312	Bobina Sx
R 80/7	800	75 84	24 601 0662	Bobina	R 1200 Gs Adv	1200	05 09	24 601 0322	Bobina Dx
R 80/7 N	800	77 80	24 601 0262	Bobina	R 1200 R	1200	05 14	24 601 0312	Bobina Sx
R 80/7 S	800	77 80	24 601 0262	Bobina	R 1200 R	1200	05 14	24 601 0322	Bobina Dx
R 850 C	850	97 00	24 601 0272	Bobina	R 1200 Rt	1200	03 14	24 601 0312	Bobina Sx
R 850 Gs	850	96 00	24 601 0272	Bobina	R 1200 Rt	1200	03 14	24 601 0322	Bobina Dx
R 850 R	850	94 97	24 601 0272	Bobina	R 1200 S	1200	06 08	24 601 0312	Bobina Sx

Modello - Model	Cc	Anno Year	Codice RMS RMS Code	Descrizione Description	Modello - Model	Cc	Anno Year	Codice RMS RMS Code	Descrizione Description
R 1200 S	1200	06 08	24 601 0322	Bobina Dx	Superbike 748	748	95 01	24 601 0282	Bobina
R 1200 St	1200	03 07	24 601 0312	Bobina Sx	Superbike 748 E	748	01 02	24 601 0282	Bobina
R 1200 St	1200	03 07	24 601 0322	Bobina Dx	Superbike 748 R	748	99 99	24 601 0282	Bobina
K 1300 Gt	1300	07 10	24 601 0342	Bobina	Superbike 748 R Single-Seat	748	01 02	24 601 0282	Bobina
K 1300 R	1300	07 14	24 601 0342	Bobina	Superbike 748 R Single-Seat	748	98 98	24 601 0282	Bobina
K 1300 S	1300	07 14	24 601 0342	Bobina	Superbike 748 Rs	748	00 01	24 601 0282	Bobina
CAGIVA					Superbike 748 S	748	00 02	24 601 0282	Bobina
Sst	125	80 82	24 601 0672	Bobina	Superbike 748 Sps	748	98 99	24 601 0282	Bobina
Sst Hd Turismo	125	79	24 601 0672	Bobina	Superbike 748 Usa	748	99 99	24 601 0282	Bobina
Sxt Hd	125	80 81	24 601 0672	Bobina	Superbike 749	748	03 03	24 601 0252	Bobina
Hd 4T	250		24 601 0672	Bobina	Superbike 749 Dark	748	04 06	24 601 0252	Bobina
DAELIM					Superbike 749 Dark Usa	748	04 06	24 601 0252	Bobina
Sq 125	125		24 601 0462	Bobina	Superbike 749 R	748	04 06	24 601 0252	Bobina
Vj 125	125	12	24 601 0452	Bobina	Superbike 749 R Usa	748	05 06	24 601 0252	Bobina
DUCATI					Superbike 749 S	748	03 06	24 601 0232	Bobina
S	125		24 601 0662	Bobina	Superbike 749 S	748	03 06	24 601 0252	Bobina
Scrambler	125		24 601 0662	Bobina	Superbike 749 S Usa	748	05 06	24 601 0252	Bobina
Sport	125		24 601 0662	Bobina	Gt/Sport/S/Ss	750	71 74	24 601 0672	Bobina
Turismo	125		24 601 0662	Bobina	Supersport 750 S	750	01 02	24 601 0282	Bobina
Monza Junior	160	67	24 601 0662	Bobina	Supersport 750 Ss	750	99 02	24 601 0282	Bobina
Ts Turismo	160		24 601 0662	Bobina	Monster 795	795	12 14	24 601 0392	Bobina
T Turismo	175	59	24 601 0662	Bobina	Monster 795 - Thai	795	12 14	24 601 0392	Bobina
Turismo	175		24 601 0662	Bobina	Monster 795 Abs	795	13 14	24 601 0392	Bobina
Elite	200		24 601 0662	Bobina	Monster 795 Abs Thai	795	13 14	24 601 0392	Bobina
Ts Turismo	200		24 601 0662	Bobina	Monster 796	796	11 12	24 601 0392	Bobina
Turismo	200		24 601 0662	Bobina	Monster 796 - Dmt	796	14 14	24 601 0392	Bobina
24 Hours	250		24 601 0662	Bobina	Monster 796 Abs	796	11 14	24 601 0392	Bobina
De Luxe	250		24 601 0662	Bobina	Monster 796 Abs - Dmt	796	14 14	24 601 0392	Bobina
Diana	250		24 601 0662	Bobina	Monster 796 Abs Anniversary	796	13 13	24 601 0392	Bobina
Gt	250		24 601 0662	Bobina	Monster 796 Abs Usa	796	11 14	24 601 0392	Bobina
Mach 1	250		24 601 0662	Bobina	Monster 796 Abs Usa Anniversary	796	13 13	24 601 0392	Bobina
Mark 3	250	68 72	24 601 0662	Bobina	Monster 796 Anniversary	796	13 13	24 601 0392	Bobina
Monza	250		24 601 0662	Bobina	Monster 796 Anniversary Usa	796	13 13	24 601 0392	Bobina
Monza Junior	250	67	24 601 0662	Bobina	Monster 796 Usa	796	11 13	24 601 0392	Bobina
Road	250	75	24 601 0672	Bobina	Hypermotard 796	800	10 12	24 601 0392	Bobina
Road	250		24 601 0662	Bobina	Hypermotard 796 Usa	800	10 12	24 601 0392	Bobina
Scrambler	250	68 72	24 601 0662	Bobina	Monster S2r 800	800	05 07	24 601 0392	Bobina
Scrambler	250	75	24 601 0672	Bobina	Monster S2r 800 Dark	800	05 06	24 601 0392	Bobina
Strada	250	78 83	24 601 0672	Bobina	Monster S2r 800 Dark Usa	800	05 06	24 601 0392	Bobina
F3	350	85	24 601 0672	Bobina	Monster S2r 800 Usa	800	05 07	24 601 0392	Bobina
Glt/Gtv/Sport/Desmo	350	75	24 601 0672	Bobina	Hypermotard - Bra	821	14 14	24 601 0252	Bobina
Indiana	350	85 85	24 601 0672	Bobina	Hypermotard Hyperstrada	821	13 14	24 601 0252	Bobina
Mark 3	350		24 601 0662	Bobina	Hypermotard Hyperstrada Usa	821	13 14	24 601 0252	Bobina
Road	350	75	24 601 0672	Bobina	Hypermotard Hyperstrada-Bra	821	14 14	24 601 0252	Bobina
Scrambler	350	67 72	24 601 0662	Bobina	Hypermotard Sp	821	13 14	24 601 0252	Bobina
Scrambler	350	75	24 601 0672	Bobina	Hypermotard Sp 821	821	13 14	24 601 0252	Bobina
Sebring	350	67	24 601 0662	Bobina	Hypermotard Sp Usa	821	13 14	24 601 0252	Bobina
Twin/Bilicilindriche/Desmo	350		24 601 0672	Bobina	Hypermotard Usa	821	13 14	24 601 0252	Bobina
Vento	350	76 83	24 601 0672	Bobina	Streetfighter 848	848	13 14	24 601 0372	Bobina
F3	400	85	24 601 0672	Bobina	Streetfighter 848 Usa	848	13 14	24 601 0372	Bobina
Desmo	450		24 601 0662	Bobina	Superbike 848 Evo	848	13 13	24 601 0372	Bobina
Mark 3	450		24 601 0662	Bobina	Superbike 848 Evo Corse Se	848	13 13	24 601 0372	Bobina
Scrambler	450	67 72	24 601 0662	Bobina	Superbike 848 Evo Corse Se Usa	848	13 13	24 601 0372	Bobina
Glt/Gtv/Sport/Desmo	500	75	24 601 0672	Bobina	Superbike 848 Evo Usa	848	13 13	24 601 0372	Bobina
Twin/Bilicilindriche/Desmo	500		24 601 0672	Bobina	Streetfighter 848	850	12 12	24 601 0372	Bobina
Multistrada 620	620	06 06	24 601 0392	Bobina	Streetfighter 848 Usa	850	12 12	24 601 0372	Bobina
Multistrada 620 Dark	620	06 06	24 601 0392	Bobina	Superbike 848	850	08 10	24 601 0372	Bobina
Multistrada 620 Dark Usa	620	06 06	24 601 0392	Bobina	Superbike 848 Evo	850	11 12	24 601 0372	Bobina
Multistrada 620 Usa	620	06 06	24 601 0392	Bobina	Superbike 848 Evo Corse Se	850	12 12	24 601 0372	Bobina
Monster 659 Abs Australia	659	12 14	24 601 0392	Bobina	Superbike 848 Evo Corse Se Usa	850	12 12	24 601 0372	Bobina
Monster 659 Australia	659	12 13	24 601 0392	Bobina	Superbike 848 Evo Usa	850	11 12	24 601 0372	Bobina
Monster 695	695	07 08	24 601 0392	Bobina	Superbike 848 Hayden	850	10 10	24 601 0372	Bobina
Monster 695 Usa	695	07 08	24 601 0392	Bobina	Superbike 848 Usa	850	08 10	24 601 0372	Bobina
Monster 696	696	08 13	24 601 0392	Bobina	Superbike 851	851	91 92	24 601 0282	Bobina
Monster 696 Abs	696	10 14	24 601 0392	Bobina	Superbike 888	888	94 95	24 601 0282	Bobina
Monster 696 Abs Anniversary	696	13 13	24 601 0392	Bobina	Superbike 888 Sp5	888	93 93	24 601 0282	Bobina
Monster 696 Abs Usa	696	10 14	24 601 0392	Bobina	Superbike 888 Us	888	94 95	24 601 0282	Bobina
Monster 696 Abs Usa Anniversary	696	13 13	24 601 0392	Bobina	Superbike 899 Panigale Abs	899	14 14	24 601 0352	Bobina
Monster 696 Anniversary	696	13 13	24 601 0392	Bobina	Superbike 899 Panigale Abs Usa	899	14 14	24 601 0352	Bobina
Monster 696 Usa	696	08 13	24 601 0392	Bobina	Superbike 907 I.e.	900	90 93	24 601 0282	Bobina
Monster 696 Usa Anniversary	696	13 13	24 601 0392	Bobina	Superbike 907 I.e. Usa	900	91 92	24 601 0282	Bobina

BOBINE - CENTRALINE ACCENSIONE

COIL - IGNITION MODULE



Modello - Model	Cc	Anno Year	Codice RMS RMS Code	Descrizione Description	Modello - Model	Cc	Anno Year	Codice RMS RMS Code	Descrizione Description
Supersport 750 Ss Usa	900	99 99	24 601 0282	Bobina	Sportclassic Sport 1000 Usa	1000	07 08	24 601 0242	Bobina
Supersport 900 S	900	02 02	24 601 0282	Bobina	Streetfighter S	1098	13 13	24 601 0252	Bobina
Supersport 900 Ss	900	98 02	24 601 0282	Bobina	Streetfighter S Usa	1098	13 13	24 601 0252	Bobina
Supersport 900 Ss Usa	900	99 99	24 601 0282	Bobina	Hypermotard 1100 Evo	1100	10 12	24 601 0392	Bobina
Superbike 916	916	94 97	24 601 0282	Bobina	Hypermotard 1100 Evo Sp	1100	10 12	24 601 0392	Bobina
Superbike 916 R	916	97 98	24 601 0282	Bobina	Hypermotard 1100 Evo Sp Usa	1100	10 12	24 601 0392	Bobina
Superbike 916 Senna	916	94 98	24 601 0282	Bobina	Hypermotard 1100 Evo Usa	1100	10 12	24 601 0392	Bobina
Superbike 916 Sp	916	94 96	24 601 0282	Bobina	Monster 1100	1100	09 10	24 601 0242	Bobina
Sport Touring St2	944	97 03	24 601 0282	Bobina	Monster 1100 Abs	1100	10 10	24 601 0242	Bobina
Desmosedici 1000 Rr	989	08 08	24 601 0442	Bobina	Monster 1100 Abs Usa	1100	10 10	24 601 0242	Bobina
Sport Touring St4 S	996	01 05	24 601 0282	Bobina	Monster 1100 Diesel Eur	1100	13 13	24 601 0392	Bobina
Sport Touring St4 S Abs	996	03 05	24 601 0282	Bobina	Monster 1100 Diesel Usa	1100	13 13	24 601 0392	Bobina
Sport Touring St4 S Abs Usa	996	05 05	24 601 0282	Bobina	Monster 1100 Evo Abs	1100	12 13	24 601 0392	Bobina
Sport Touring St4 S Usa	996	05 05	24 601 0282	Bobina	Monster 1100 Evo Abs Usa	1100	12 13	24 601 0392	Bobina
Superbike 916 Sps	996	97 98	24 601 0282	Bobina	Monster 1100 Evo Anniversary	1100	13 13	24 601 0392	Bobina
Superbike 996 R	996	99 01	24 601 0282	Bobina	Monster 1100 S	1100	09 10	24 601 0242	Bobina
Superbike 996 R li	996	01 01	24 601 0282	Bobina	Monster 1100 S Abs	1100	10 10	24 601 0242	Bobina
Superbike 996 Rs	996	00 01	24 601 0282	Bobina	Monster 1100 S Abs Usa	1100	10 10	24 601 0242	Bobina
Superbike 996 S	996	01 01	24 601 0282	Bobina	Monster 1100 S Usa	1100	09 10	24 601 0242	Bobina
Superbike 996 S Usa	996	99 99	24 601 0282	Bobina	Monster 1100 Usa	1100	09 10	24 601 0242	Bobina
Superbike 996 Sps	996	99 00	24 601 0282	Bobina	Multistrada 1100	1100	07 09	24 601 0242	Bobina
Superbike 996 Sps li	996	99 99	24 601 0282	Bobina	Multistrada 1100 S	1100	07 09	24 601 0242	Bobina
Superbike 996 Sps lii	996	00 00	24 601 0282	Bobina	Multistrada 1100 S Usa	1100	07 09	24 601 0242	Bobina
Superbike 996 Usa	996	99 99	24 601 0282	Bobina	Multistrada 1100 Usa	1100	07 09	24 601 0242	Bobina
Superbike 998	998	02 03	24 601 0282	Bobina	Streetfighter	1100	10 11	24 601 0252	Bobina
Superbike 998 Final Ed.	998	04 04	24 601 0282	Bobina	Streetfighter S	1100	10 12	24 601 0252	Bobina
Superbike 998 Matrix	998	04 04	24 601 0282	Bobina	Streetfighter S Usa	1100	10 12	24 601 0252	Bobina
Superbike 998 Matrix Single-Se	998	04 04	24 601 0282	Bobina	Streetfighter Usa	1100	10 11	24 601 0252	Bobina
Superbike 998 R	998	02 02	24 601 0282	Bobina	Superbike 1098	1100	07 08	24 601 0252	Bobina
Superbike 998 Rs	998	02 03	24 601 0282	Bobina	Superbike 1098 S	1100	07 08	24 601 0252	Bobina
Superbike 998 S Bayliss	998	02 02	24 601 0282	Bobina	Superbike 1098 S Tricolore	1100	07 08	24 601 0252	Bobina
Superbike 998 S Bostrom	998	02 02	24 601 0282	Bobina	Superbike 1098 S Tricolore Usa	1100	07 08	24 601 0252	Bobina
Superbike 999	998	03 06	24 601 0232	Bobina	Superbike 1098 S Usa	1100	07 08	24 601 0252	Bobina
Superbike 999	998	03 06	24 601 0252	Bobina	Superbike 1098 Usa	1100	07 08	24 601 0252	Bobina
Superbike 999 R	998	03 06	24 601 0232	Bobina	Superbike 1199 Panigale Abs Br	1198	14 14	24 601 0352	Bobina
Superbike 999 R	998	03 06	24 601 0252	Bobina	Superbike 1199 Panigale S Abs	1198	14 14	24 601 0352	Bobina
Superbike 999 R Usa	998	05 06	24 601 0252	Bobina	Superbike 1199 Panigale R	1199	13 13	24 601 0352	Bobina
Superbike 999 R Xerox	998	06 06	24 601 0252	Bobina	Superbike 1199 Panigale R Usa	1199	13 13	24 601 0352	Bobina
Superbike 999 R Xerox Usa	998	06 06	24 601 0252	Bobina	Superbike 1199 Panigale Superl	1199	14 14	24 601 0352	Bobina
Superbike 999 Rs	998	04 05	24 601 0282	Bobina	Diavel	1200	11 13	24 601 0252	Bobina
Superbike 999 S	998	03 06	24 601 0252	Bobina	Diavel Amg Europe	1200	13 13	24 601 0252	Bobina
Superbike 999 S Ama Replica	998	07 07	24 601 0252	Bobina	Diavel Amg Usa	1200	13 13	24 601 0252	Bobina
Superbike 999 S Usa	998	05 06	24 601 0252	Bobina	Diavel Bra	1200	12 14	24 601 0252	Bobina
Superbike 999 Usa	998	05 06	24 601 0252	Bobina	Diavel Carbon	1200	11 13	24 601 0252	Bobina
Hypermotard 1100	1000	08 09	24 601 0242	Bobina	Diavel Carbon Bra	1200	12 14	24 601 0252	Bobina
Hypermotard 1100 S	1000	08 09	24 601 0242	Bobina	Diavel Carbon Fl	1200	15 15	24 601 0242	Bobina
Hypermotard 1100 S Usa	1000	08 08	24 601 0242	Bobina	Diavel Carbon Fl Usa	1200	15 15	24 601 0242	Bobina
Hypermotard 1100 Usa	1000	08 09	24 601 0242	Bobina	Diavel Carbon Thai	1200	14 14	24 601 0252	Bobina
Monster S2r 1000	1000	06 08	24 601 0242	Bobina	Diavel Carbon Usa	1200	11 13	24 601 0252	Bobina
Monster S2r 1000 Usa	1000	06 08	24 601 0242	Bobina	Diavel Cromo Europe	1200	13 13	24 601 0252	Bobina
Monster S4r	1000	07 08	24 601 0252	Bobina	Diavel Cromo Usa	1200	13 13	24 601 0252	Bobina
Monster S4r Usa	1000	07 08	24 601 0252	Bobina	Diavel Fl	1200	15 15	24 601 0242	Bobina
Monster S4rs	1000	06 08	24 601 0252	Bobina	Diavel Fl Usa	1200	15 15	24 601 0242	Bobina
Monster S4rs Tricolore	1000	08 08	24 601 0252	Bobina	Diavel Strada	1200	13 14	24 601 0252	Bobina
Monster S4rs Tricolore Usa	1000	08 08	24 601 0252	Bobina	Diavel Thai	1200	14 14	24 601 0252	Bobina
Monster S4rs Usa	1000	06 08	24 601 0252	Bobina	Diavel Usa	1200	11 13	24 601 0252	Bobina
Multistrada 1000	1000	03 03	24 601 0242	Bobina	Diavel White Stripe	1200	13 14	24 601 0252	Bobina
Sport Touring St3	1000	04 07	24 601 0242	Bobina	Monster 1200	1200	14 14	24 601 0242	Bobina
Sport Touring St3 S Abs	1000	06 07	24 601 0242	Bobina	Monster 1200 S	1200	14 14	24 601 0242	Bobina
Sport Touring St3 S Abs Usa	1000	06 07	24 601 0242	Bobina	Monster 1200 S Usa	1200	14 14	24 601 0242	Bobina
Sport Touring St3 Usa	1000	05 07	24 601 0242	Bobina	Monster 1200 Usa	1200	14 14	24 601 0242	Bobina
Sportclassic Gt1000	1000	07 10	24 601 0242	Bobina	Multistrada 1200	1200	10 12	24 601 0252	Bobina
Sportclassic Gt1000 Touring	1000	09 09	24 601 0242	Bobina	Multistrada 1200 Abs	1200	10 12	24 601 0252	Bobina
Sportclassic Gt1000 Touring Usa	1000	09 09	24 601 0242	Bobina	Multistrada 1200 Abs	1200	13 14	24 601 0242	Bobina
Sportclassic Gt1000 Usa	1000	07 10	24 601 0242	Bobina	Multistrada 1200 Abs - Dmb	1200	14 14	24 601 0242	Bobina
Sportclassic Paul Smart	1000	06 06	24 601 0242	Bobina	Multistrada 1200 Abs - Dmt	1200	14 14	24 601 0242	Bobina
Sportclassic Paul Smart Usa	1000	06 06	24 601 0242	Bobina	Multistrada 1200 Abs Usa	1200	10 12	24 601 0252	Bobina
Sportclassic Sport 1000	1000	07 08	24 601 0242	Bobina	Multistrada 1200 Abs Usa	1200	13 14	24 601 0242	Bobina
Sportclassic Sport 1000 S	1000	07 09	24 601 0242	Bobina	Multistrada 1200 S Abs	1200	10 10	24 601 0252	Bobina
Sportclassic Sport 1000 S Usa	1000	07 09	24 601 0242	Bobina	Multistrada 1200 S Abs Usa	1200	10 10	24 601 0252	Bobina
Sportclassic Sport 1000 Single-Se	1000	06 07	24 601 0242	Bobina	Multistrada 1200 S Gt	1200	13 14	24 601 0242	Bobina

Modello - Model	Cc	Anno Year	Codice RMS RMS Code	Descrizione Description	Modello - Model	Cc	Anno Year	Codice RMS RMS Code	Descrizione Description
Multistrada 1200 S Gt Usa	1200	13 14	24 601 0242	Bobina	V 7/Carabinieri/Polizia/Pa	700	67	24 601 0672	Bobina
Multistrada 1200 S Pikes Peak	1200	12 12	24 601 0252	Bobina	S	750	74	24 601 0672	Bobina
Multistrada 1200 S Pikes Peak	1200	13 14	24 601 0242	Bobina	S 3	750	75	24 601 0672	Bobina
Multistrada 1200 S Pikes Peak Us	1200	12 12	24 601 0252	Bobina	V 7 Special	750	70	24 601 0672	Bobina
Multistrada 1200 S Pikes Peak Us	1200	13 14	24 601 0242	Bobina	V 7 Sport	750	71 73	24 601 0672	Bobina
Multistrada 1200 S Sport	1200	11 12	24 601 0252	Bobina	Le Mans I/II/III	850	76 84	24 601 0672	Bobina
Multistrada 1200 S Sport Usa	1200	11 12	24 601 0252	Bobina	T	850	75 77	24 601 0672	Bobina
Multistrada 1200 S Touring	1200	10 12	24 601 0252	Bobina	T3/Base/California/T4	850	79 85	24 601 0672	Bobina
Multistrada 1200 S Touring	1200	13 14	24 601 0242	Bobina	T5 I/II/III Series	850	83 88	24 601 0672	Bobina
Multistrada 1200 S Touring - Dmb	1200	14 14	24 601 0242	Bobina	T5 Polizia/Carabinieri/Pa	850	85 89	24 601 0672	Bobina
Multistrada 1200 S Touring - Dmt	1200	14 14	24 601 0242	Bobina	V 7 Eldorado/California Police	850	72	24 601 0672	Bobina
Multistrada 1200 S Touring D-Air	1200	14 14	24 601 0242	Bobina	V 7 Gt/Gt California	850	72	24 601 0672	Bobina
Multistrada 1200 S Touring Usa	1200	10 12	24 601 0252	Bobina	California Ii (Fino A Mot.Vt18785)	1000	81 87	24 601 0672	Bobina
Multistrada 1200 S Touring Usa	1200	13 14	24 601 0242	Bobina	California Iii Carb./Carb. Carenato	1000	88 90	24 601 0672	Bobina
Multistrada 1200 Usa	1200	10 12	24 601 0252	Bobina	G5	1000	78 85	24 601 0672	Bobina
Superbike 1098 R	1200	08 10	24 601 0252	Bobina	G5 V Civile/Pa	1000	78 85	24 601 0672	Bobina
Superbike 1098 R Bayliss	1200	09 09	24 601 0252	Bobina	Gt	1000	87 93	24 601 0672	Bobina
Superbike 1098 R Bayliss Usa	1200	09 09	24 601 0252	Bobina	Le Mans Iv/V	1000	84 93	24 601 0672	Bobina
Superbike 1098 R Usa	1200	08 10	24 601 0252	Bobina	S	1000	89 90	24 601 0672	Bobina
Superbike 1198	1200	09 11	24 601 0372	Bobina	V I-Confort Civile/Pa	1000	75 84	24 601 0672	Bobina
Superbike 1198 S	1200	09 10	24 601 0372	Bobina	MUNCH				
Superbike 1198 S Corse	1200	10 10	24 601 0372	Bobina	1200 TTS-E	1200	75 82	24 601 0590	Centralina accensione
Superbike 1198 S Corse Usa	1200	10 10	24 601 0372	Bobina	MV AGUSTA				
Superbike 1198 S Usa	1200	09 10	24 601 0372	Bobina	GT/Sport	600	67 71	24 601 0672	Bobina
Superbike 1198 Sp	1200	11 11	24 601 0372	Bobina	Gt/Sport	750	71 74	24 601 0672	Bobina
Superbike 1198 Sp Usa	1200	11 11	24 601 0372	Bobina	S Sport America	750	75 78	24 601 0672	Bobina
Superbike 1198 Usa	1200	09 11	24 601 0372	Bobina	Brutale 910	910	05 08	24 601 0302	Bobina
Superbike 1199 Panigale	1200	12 13	24 601 0352	Bobina	Brutale 920	920	10 11	24 601 0302	Bobina
Superbike 1199 Panigale Abs	1200	12 14	24 601 0352	Bobina	Brutale 989 R	989	08	24 601 0302	Bobina
Superbike 1199 Panigale Abs Us	1200	12 14	24 601 0352	Bobina	Brutale 990 R	990	10 11	24 601 0302	Bobina
Superbike 1199 Panigale R	1200	14 14	24 601 0352	Bobina	F4 1000 312R	1000	07 08	24 601 0302	Bobina
Superbike 1199 Panigale R Usa	1200	14 14	24 601 0352	Bobina	F4 R	1000	06 07	24 601 0302	Bobina
Superbike 1199 Panigale S	1200	12 13	24 601 0352	Bobina	F4 S - R - Rr - Freccie Tricolore	1000	10 12	24 601 0302	Bobina
Superbike 1199 Panigale S Abs	1200	12 14	24 601 0352	Bobina	F4 Veltro	1000	08 08	24 601 0302	Bobina
Superbike 1199 Panigale S Tric	1200	12 13	24 601 0352	Bobina	Brutale 1078Rr	1078	08 08	24 601 0302	Bobina
Superbike 1199 Panigale S Usa	1200	12 13	24 601 0352	Bobina	F4 100Cc	1078	07 07	24 601 0302	Bobina
Superbike 1199 Panigale Usa	1200	12 13	24 601 0352	Bobina	F4 1078 312Rr	1078	07 08	24 601 0302	Bobina
GILERA					Brutale 1090-1090R-1090Rr- Corsa	1090	13 13	24 601 0302	Bobina
Giubileo normale/Extra	98	59 70	24 601 0662	Bobina	Brutale 1090Rr	1090	10 11	24 601 0302	Bobina
Giubileo/Florida	98		24 601 0662	Bobina	Brutale R - Rr	1090	12 12	24 601 0302	Bobina
4V/5V Strada/FL Florida Speciale	124		24 601 0662	Bobina	PIAGGIO				
B Giubileo Sei giorni/Special	124	59 70	24 601 0662	Bobina	Vespa Lx 4T-4V	50	09 13	24 601 0412	Bobina
Giubileo normale/Extra	124	59 70	24 601 0662	Bobina	Vespa Lx 4T-4V Touring	50	10 13	24 601 0412	Bobina
G Rossa Sport	125		24 601 0662	Bobina	Vespa Primavera 4T-4V	50	13 14	24 601 0412	Bobina
Giubileo /Extra	175	60 66	24 601 0662	Bobina	Vespa S 4T-4V & College	50	08 12	24 601 0412	Bobina
B/Extra	200	53 69	24 601 0662	Bobina	Vespa Sprint 4T 4V	50	14 14	24 601 0412	Bobina
B/Extra	300	53 69	24 601 0662	Bobina	Beverly Rst 4T 4V ie Eu3	125	10 13	24 601 0412	Bobina
HARLEY DAVIDSON					Liberty 4T 2V ie Ptt - Ita	125	12 12	24 601 0412	Bobina
Amf	250		24 601 0672	Bobina	Liberty 4T 3V ie Eu3	125	13 14	24 601 0412	Bobina
INNOCENTI					Mp3 Ibrido	125	09 10	24 601 0362	Bobina
Lambretta Ld Ii/III Ser. Avv. Elettrico	125	56 57	24 601 0672	Bobina	Mp3 ie	125	08 09	24 601 0362	Bobina
Lambretta Ld Ii/III Ser. Avv. Elettrico	150	56 57	24 601 0672	Bobina	Mp3 ie Touring	125	11 12	24 601 0362	Bobina
Motofurgone Fli	175	66	24 601 0672	Bobina	Vespa Gts 4T ie Super	125	09 14	24 601 0412	Bobina
Motofurgone Li	175	66	24 601 0672	Bobina	Vespa Lx 4T Eu3 Touring	125	10 11	24 601 0412	Bobina
Motofurgone Fli	200	66	24 601 0672	Bobina	Vespa Lx Eur3 ie	125	09 11	24 601 0412	Bobina
KTM					Vespa Lxv ie 4T	125	10 13	24 601 0412	Bobina
990 Superduke R	990	08 13	24 601 0382	Bobina	Vespa S 4T ie & College	125	09 11	24 601 0412	Bobina
LAVERDA					X7 Evo Ie Eu3	125	09 10	24 601 0412	Bobina
Or Atlas	600	85	24 601 0672	Bobina	Liberty 4T 3V Lem	150	13 14	24 601 0412	Bobina
Gt/Gts/S/Sf/Sf1/Sf2/Sf3/Sfc	650	68 77	24 601 0672	Bobina	Vespa Lx Eu3 ie	150	09 11	24 601 0412	Bobina
750 Gtl	750	74 79	24 601 0422	Bobina	Vespa Lx Touring	150	10 12	24 601 0412	Bobina
Gt/Gts/S/Sf/Sf1/Sf2/Sf3/Sfc	750	68 77	24 601 0672	Bobina	Vespa S 4T ie & College	150	09 12	24 601 0412	Bobina
MAICO					Beverly Cruiser	250	07 09	24 601 0412	Bobina
125 Gs/6	125	70 83	24 601 0262	Bobina	Beverly Eu3 Mic	250	07 07	24 601 0412	Bobina
MOTO GUZZI					Beverly ie Eu3	250	06 08	24 601 0412	Bobina
Galletto Avviamento Elettrico	160		24 601 0662	Bobina	Beverly Sport	250	06 08	24 601 0412	Bobina
Ercolino Avviamento Elettrico	192		24 601 0672	Bobina	Beverly Tourer Eu3	250	08 09	24 601 0412	Bobina
Galletto Avviamento Elettrico	192		24 601 0662	Bobina	Carnaby	250	08 08	24 601 0412	Bobina
Galletto Avviamento Elettrico	192		24 601 0672	Bobina	Mp3	250	06 08	24 601 0362	Bobina
Lodola Gran Turismo	235		24 601 0662	Bobina	Mp3 Lt	250	08 09	24 601 0412	Bobina
Nuovo Falcone/C/Civile/Militare	500	69 76	24 601 0672	Bobina	Mp3 Mic	250	08 09	24 601 0412	Bobina

Modello - Model	Cc	Anno Year	Codice RMS RMS Code	Descrizione Description
Vespa Gt 60 Eu3	250	06 07	24 601 0412	Bobina
Vespa Gts	250	05 14	24 601 0412	Bobina
Vespa Gts Abs	250	05 12	24 601 0412	Bobina
Vespa Gtv	250	06 09	24 601 0412	Bobina
Vespa Gtv 4T Navy Eu3	250	07 07	24 601 0412	Bobina
X Evo	250	07 13	24 601 0412	Bobina
X7 Eu3	250	08 08	24 601 0412	Bobina
X8 Eu3	250	05 08	24 601 0412	Bobina
Beverly Rst 4T 4V ie Eu3	300	10 14	24 601 0412	Bobina
Beverly Tourer Eu3	300	09 10	24 601 0412	Bobina
Carnaby Cruiser	300	09 12	24 601 0412	Bobina
Mp3 300 ie Lt	300	10 11	24 601 0362	Bobina
Mp3 300 ie Mic	300	10 11	24 601 0362	Bobina
Mp3 4T 4V ie Erl Ibrido	300	10 13	24 601 0362	Bobina
Mp3 4T 4V ie Lt Ibrido	300	10 11	24 601 0362	Bobina
Mp3 ie Lt-ie Lt Sport	300	11 13	24 601 0362	Bobina
Mp3 Touring 300 ie	300	11 12	24 601 0362	Bobina
Mp3 Touring Lt 300 ie	300	11 12	24 601 0362	Bobina
Vaspa Gts ie Touring	300	11 12	24 601 0412	Bobina
Vespa Gts ie	300	12 14	24 601 0412	Bobina
Vespa Gts Super	300	08 14	24 601 0412	Bobina
Vespa Gts Super Sport	300	10 13	24 601 0412	Bobina
Vespa Gtv 4T 4V ie	300	10 13	24 601 0412	Bobina
Vespa Gtv Via Montenapoleone	300	10 10	24 601 0412	Bobina
X7 Evo ie E3	300	09 10	24 601 0412	Bobina
Beverly Eu3	400	06 07	24 601 0412	Bobina
Beverly Tourer Eu3	400	08 10	24 601 0412	Bobina
Mp3	400	07 08	24 601 0362	Bobina
Mp3 ie Lt - Mp3 ie Lt Sport	400	08 10	24 601 0412	Bobina
Mp3 ie Lt Touring	400	11 11	24 601 0412	Bobina
Mp3 Mic	400	08 10	24 601 0412	Bobina
Mp3 RI Touring	400	11 11	24 601 0412	Bobina
X Evo	400	07 11	24 601 0412	Bobina
X8 Eu3	400	06 08	24 601 0412	Bobina
Ape Mp 190	500		24 601 0672	Bobina
Beverly Eu3	500	06 08	24 601 0412	Bobina
X9 Evolution	500	06 07	24 601 0412	Bobina
X9 Evolution Abs	500	06 07	24 601 0412	Bobina
Ape Mp 190	550		24 601 0672	Bobina
Ape Mp 190	600		24 601 0672	Bobina
TRIUMPH				
T 100 C Trophy Trail	500		24 601 0672	Bobina
T 100 R Daytona	500		24 601 0672	Bobina
T 140 V Bonneville	750		24 601 0672	Bobina
Tr7v Tiger	750		24 601 0672	Bobina
Twins	750		24 601 0672	Bobina



REGOLATORI
REGULATORS

24 603 0011 

BENELLI: (R.O.R51540101A0)
ITALJET: (R.O.4870706560)
MALAGUTI: (R.O.02601400)
MBK: (R.O: 5MFV1960000)
YAMAHA: (R.O.5RNW1960000)



24 603 0012 

BENELLI: (R.O.R51540101A0)
ITALJET: (R.O.4870706560)
MALAGUTI: (R.O.02601400)
YAMAHA: (R.O.5DSH1960000)



24 603 0020 

PIAGGIO: (R.O.2308245)



24 603 0030 

24 603 0031 

PIAGGIO: (R.O.1616395)



24 603 0040 

24 603 0042 

GILERA: (R.O.185824-291931-294016-2940165)
PIAGGIO: (R.O. 2940165)
Di primo equipaggiamento – *O.E.M. Quality*



24 603 0050 

24 603 0051 

APRILIA: (R.O. AP8212540)
BETA:
MALAGUTI: (R.O. 02601100)
MBK: (R.O. 4VVH196001)
SUZUKI: (R.O. 32800-40D10-000)
YAMAHA: (R.O.4VVH19600100)



24 603 0060 

APRILIA: (R.O.AP8224102)
HONDA: (R.O.31600GBL871)



24 603 0070 

24 603 0072 

KYMCO: (R.O.00169004)
MALAGUTI: (R.O.02601500)
MBK: (R.O.5RNH19600000)
YAMAHA: (R.O.5RNH19600000)



24 603 0081 

KYMCO: (R.O.00168780)

24 603 0082 

KYMCO: (R.O.00168780)
MALAGUTI: (R.O.02601800)
Di primo equipaggiamento – *O.E.M. Quality*





24 603 0090 

24 603 0092 

MBK: (R.O. 4HMH1960000)
YAMAHA: (R.O. 4HMH1960000)



24 603 0100 

HONDA: (R.O. 31600-KFG-860)
MALAGUTI: (R.O. 02601900)



24 603 0102 

HONDA: (R.O. 31600-KFG-860)
MALAGUTI: (R.O. 02601900)
PIAGGIO: (R.O. 496454)



24 603 0112 

KYMCO: (R.O.00168139)
Di primo equipaggiamento – *O.E.M. Quality*



24 603 0122 

KYMCO: (R.O.00169587)
MALAGUTI: (R.O.02603000)
Di primo equipaggiamento – *O.E.M. Quality*



24 603 0132 

KYMCO: (R.O.00131033)
Di primo equipaggiamento – *O.E.M. Quality*



24 603 0142 

KYMCO: (R.O.00177005)
Di primo equipaggiamento – *O.E.M. Quality*



24 603 0152 

APRILIA: (R.O. AP8124648)
DERBI: (R.O. 58096R-82587R)
GILERA: (R.O. 58096R - R.O. 82587R)
PIAGGIO: (R.O. 58096R - R.O. 82587R)
Di primo equipaggiamento – *O.E.M. Quality*



24 603 0162 

APRILIA: (R.O. AP8127418)
BENELLI: (R.O. R5154008IA0)
DERBI: (R.O. 58090R)
GILERA: (R.O. 58090R)
ITALJET:
MALAGUTI: (R.O. 02601600)
PIAGGIO: (R.O. 58090R)
Di primo equipaggiamento – *O.E.M. Quality*





REGOLATORI
REGULATORS

24 603 0172 

KYMCO: (R.O. 00168783)
Di primo equipaggiamento – *O.E.M. Quality*



24 603 0182 

APRILIA: (R.O. 639751-641788)
DERBI: (R.O. 639751-641788)
ITALJET:
MALAGUTI: PIAGGIO: (R.O. 639751-641788)
Di primo equipaggiamento – *O.E.M. Quality*



24 603 0192 

APRILIA: (R.O. 58086R-639110)
DERBI: (R.O. 58086R)
PIAGGIO: (R.O. 58086R)
Di primo equipaggiamento – *O.E.M. Quality*



24 603 0212 

HONDA: (R.O. 31600KR1761)
KYMCO: (R.O. 00172385)
SYM: (R.O. 3160-N28-000)
Di primo equipaggiamento – *O.E.M. Quality*



24 603 0222 

YAMAHA: (R.O. 5BN819600000)



24 603 0232 

YAMAHA: (R.O. 4JH8196001000)



24 603 0241 

24 603 0242 

HONDA: (R.O. 31600-KTF-841)



24 603 0260 

PIAGGIO: (R.O. 231877)



24 603 0270 

PIAGGIO: (R.O. 157714)





24 603 0281 

PIAGGIO:
(R.O. 641709 Ex 58203R/641533/58208R)



24 603 0292 

PIAGGIO: (R.O. 58204R)



24 603 0302 

KYMCO: (R.O. 00131148)
Di primo equipaggiamento – *O.E.M. Quality*



24 603 0312 

KAWASAKI: (R.O. 21066Y003)



24 603 0321 

PIAGGIO: (R.O. 2180605)



NEW

24 603 0330 

REGOLATORE GER-024
GER-024 REGULATOR



NEW



24 603 0342 

NEW

KYMCO: (R.O. 00131128)
Di primo equipaggiamento – *O.E.M. Quality*





REGOLATORI

REGULATORS

Modello - Model	Cc	Anni Years	Codice RMS RMS Code	Rif. Originale Oem Number	Modello - Model	Cc	Anni Years	Codice RMS RMS Code	Rif. Originale Oem Number
APRILIA					BENELLI				
Amico	50	94	24 603 0050	AP8212540	Sport City Eu3	125	06-08	24 603 0192	AP8127809
Amico	50	94	24 603 0051	AP8212540	Atlantic Eu3	250	06-08	24 603 0162	AP8127418
Amico	50	96-98	24 603 0050	AP8212540	Atlantic Eu3	250	06-08	24 603 0192	AP8127809
Amico	50	96-98	24 603 0051	AP8212540	Scarabeo Light	250	06-08	24 603 0192	AP8127809
Amico GL-GLE	50	93-95	24 603 0050	AP8212540	Atlantic Sprint	400	05-08	24 603 0192	AP8127205
Amico GL-GLE	50	93-95	24 603 0051	AP8212540	Atlantic	500	01-04	24 603 0192	AP8127205
Amico Lx- Sport-Cat	50	92-93	24 603 0050	AP8212540	Atlantic Sprint	500	05-08	24 603 0192	AP8127205
Amico Lx- Sport-Cat	50	92-93	24 603 0051	AP8212540	Scarabeo	500	03-06	24 603 0192	AP8127205
Area 51	50	98-00	24 603 0050	AP8212540	BETA				
Area 51	50	98-00	24 603 0051	AP8212540	Ark Air-Lc	50	96-08	24 603 0050	-
Gulliver	50	95-98	24 603 0050	AP8212540	Ark Air-Lc	50	96-08	24 603 0051	-
Gulliver	50	95-98	24 603 0051	AP8212540	Quadra Chrono 502	50	95-96	24 603 0050	-
Gulliver Lc	50	96-98	24 603 0050	AP8212540	Ark Air-Lc	50	95-96	24 603 0051	-
Gulliver Lc	50	96-98	24 603 0051	AP8212540	DERBI				
Mojito Custom	50	99-03	24 603 0060	AP8224102	Atlantis 2T	50	10	24 603 0152	58096R
Mojito Retro	50	99-03	24 603 0060	AP8224102	Atlantis 2T Eu2	50	07-09	24 603 0152	58096R
Rally	50	95-03	24 603 0050	AP8212540	Atlantis 4T Eu2	50	07	24 603 0182	639751
Rally	50	95-03	24 603 0051	AP8212540	Atlantis O2	50	02	24 603 0152	58096R
Rally Liquid Cooled	50	96-99	24 603 0050	AP8212540	Atlantis O2 Bullet	50	03-05	24 603 0152	58096R
Rally Liquid Cooled	50	96-99	24 603 0051	AP8212540	Atlantis O2 City	50	03-06	24 603 0152	58096R
Scarabeo	50	98	24 603 0050	AP8212540	Atlantis O2 Red Bullet	50	03	24 603 0152	58096R
Scarabeo	50	98	24 603 0051	AP8212540	Atlantis O2 Two Chic	50	05	24 603 0152	58096R
Scarabeo	50	99	24 603 0050	AP8212540	Boulevard 2T	50	09-14	24 603 0162	58096R
Scarabeo	50	99	24 603 0051	AP8212540	Boulevard 4T Eu2 25 Km/H	50	09	24 603 0182	639751
Scarabeo	50	00-05	24 603 0050	AP8212799	Gp1	50	01-02	24 603 0152	58096R
Scarabeo	50	00-05	24 603 0051	AP8212799	Gp1	50	03	24 603 0152	58096R
Scarabeo	50	93-97	24 603 0050	AP8212540	Gp1 E2	50	03	24 603 0152	58096R
Scarabeo	50	93-97	24 603 0051	AP8212540	Gp1 Eu2	50	05	24 603 0152	58096R
Scarabeo 4T 4V	50	14	24 603 0182	641788	Gp1 Open Eu2	50	06-09	24 603 0152	58096R
Scarabeo 4T 4V	50	10-12	24 603 0182	641788	Gp1 Race Eu2	50	05-07	24 603 0152	58096R
Scarabeo 4T 4V Net	50	09	24 603 0182	641788	Sonar 2T	50	09	24 603 0162	58096R
Scarabeo 4T 4V Net	50	10	24 603 0182	641788	Variant Sport 2T	50	12	24 603 0162	58096R
Scarabeo Quattro	50	09	24 603 0182	641788	Boulevard 4T	100	10-11	24 603 0182	641788
Scarabeo Street	50	05-06	24 603 0152	AP8127154	Boulevard	125	02	24 603 0162	82501R
Sonic	50	98-07	24 603 0050	AP8212799	Boulevard	125	03-04	24 603 0162	82501R
Sonic	50	98-07	24 603 0051	AP8212799	Boulevard Eu2	125	04-07	24 603 0162	486062
Sonic Gp	50	98-08	24 603 0050	AP8212799	Gp1 Eu2	125	06	24 603 0162	486062
Sonic Gp	50	98-08	24 603 0051	AP8212799	Gp1 Low Seat 125 Eu3	125	07-08	24 603 0162	486062
Sport City One 4T	50	08-10	24 603 0182	639751	Gpr 4T	125	09-10	24 603 0162	486062
Sr	50	93	24 603 0050	AP8212540	Mulhacen 4T Eu3	125	07-09	24 603 0162	486062
Sr	50	93	24 603 0051	AP8212540	Mulhacen 4T Eu3	125	10	24 603 0162	486062
Sr	50	94-96	24 603 0050	AP8212540	Rambla	125	08-09	24 603 0192	58086R
Sr	50	94-96	24 603 0051	AP8212540	Rambla E3 2Ver	125	08	24 603 0192	58086R
Sr H2o Ditech E Carburatore	50	00-04	24 603 0060	AP8224102	Senda R-Sm Drd Racing 4T	125	09	24 603 0162	486062
Sr Liquid Cooled	50	94-96	24 603 0050	AP8212540	Terra 4T Eu3 - 4T Adventure	125	07-09	24 603 0162	486062
Sr Liquid Cooled	50	94-96	24 603 0051	AP8212540	Boulevard	150	03-04	24 603 0162	486062
Sr Motard 4T 4V	50	13-14	24 603 0182	641788	Boulevard Eu2	150	04-07	24 603 0162	486062
Sr Stealth	50	97-00	24 603 0050	AP8212540	Boulevard Eu2	200	05-06	24 603 0162	486062
Sr Stealth	50	97-00	24 603 0051	AP8212540	Gp1	250	06-07	24 603 0162	486062
Sr Street	50	03-12	24 603 0152	AP8124648	Gp1 Low Seat 250 Eu3	250	07-08	24 603 0192	584533
Sr Street	50	03-12	24 603 0162	AP8127418	Rambla	300	10-11	24 603 0192	58086R
Sr Www	50	97-01	24 603 0050	AP8212540	GILERA				
Sr Www	50	97-01	24 603 0051	AP8212540	Easy Moving	50	95-96	24 603 0040	2940165
Scarabeo Motore Minarelli	100	00	24 603 0050	AP8224297	Easy Moving	50	95-96	24 603 0042	2940165
Scarabeo Motore Minarelli	100	00	24 603 0051	AP8224297	Runner Purejet	50	05-06	24 603 0162	58090R
Scarabeo Motore Yamaha	100	00	24 603 0050	AP8224297	Runner Purejet	50	07	24 603 0162	58090R
Scarabeo Motore Yamaha	100	00	24 603 0051	AP8224297	Runner Purejet	50	10-11	24 603 0162	58090R
Atlantic	125	03-05	24 603 0162	AP8127418					
Atlantic Eu3	125	06-08	24 603 0162	AP8127418					
Atlantic Eu3	125	06-08	24 603 0192	AP8127809					
Mojito	125	08	24 603 0162	AP8127418					
Mojito	125	03-07	24 603 0162	AP8127418					
Mojito Retro' - Custom	125	99-01	24 603 0152	AP8124648					
Scarabeo	125	03	24 603 0162	AP8127418					
Scarabeo	125	04-06	24 603 0162	AP8127418					
Scarabeo Motore Piaggio Eu3	125	06	24 603 0162	AP8127418					
Sport City	125	04-06	24 603 0162	AP8127418					
Sport City Eu3	125	06-08	24 603 0162	AP8127418					



Modello - Model	Cc	Anni Years	Codice RMS RMS Code	Rif. Originale Oem Number	Modello - Model	Cc	Anni Years	Codice RMS RMS Code	Rif. Originale Oem Number
Runner Purejet St	50	08	24 603 0162	58090R	Nes 125 @/ Arobase	125	01	24 603 0102	31600-KGF-860
Runner Sp	50	05-06	24 603 0152	58096R	Nes 125 @/ Arobase	125	02	24 603 0100	31600-KGF-860
Runner Sp	50	07	24 603 0152	58096R	Nes 125 @/ Arobase	125	02	24 603 0102	31600-KGF-860
Runner Sp	50	10-12	24 603 0152	58096R	Pes 125 Ps I	125	06	24 603 0241	31600-KTF-841
Runner Sp Special Edition	50	07	24 603 0152	58096R	Pes 125 Ps I	125	06	24 603 0242	31600-KTF-841
Runner Sp St & Simoncelli	50	08-09	24 603 0152	58096R	Pes 125 Ps I	125	07	24 603 0241	31600-KTF-841
Stalker	50	97-04	24 603 0040	2940165	Pes 125 Ps I	125	07	24 603 0242	31600-KTF-841
Stalker	50	97-04	24 603 0042	2940165	Pes 125 Ps I	125	08	24 603 0241	31600-KTF-841
Stalker	50	05-06	24 603 0152	58096R	Pes 125 Ps I	125	08	24 603 0242	31600-KTF-841
Stalker	50	07-08	24 603 0152	58096R	Pes 125 Ps I	125	09	24 603 0241	31600-KTF-841
Stalker	50	09-11	24 603 0152	58096R	Pes 125 Ps I	125	09	24 603 0242	31600-KTF-841
Stalker Naked	50	08	24 603 0152	58096R	Pes 125 Ps I	125	10-13	24 603 0241	31600-KTF-841
Stalker Special Edition	50	07-08	24 603 0152	58096R	Pes 125 Ps I	125	10-13	24 603 0242	31600-KTF-841
Storm	50	94-95	24 603 0040	2940165	Ses 125 Dylan	125	02	24 603 0100	31600-KGF-860
Storm	50	94-95	24 603 0042	2940165	Ses 125 Dylan	125	02	24 603 0102	31600-KGF-860
Storm Eu2	50	07	24 603 0152	58096R	Ses 125 Dylan	125	03	24 603 0100	31600-KGF-860
Typhoon	50	94-97	24 603 0040	2940165	Ses 125 Dylan	125	03	24 603 0102	31600-KGF-860
Typhoon	50	94-97	24 603 0042	2940165	Ses 125 Dylan	125	04-06	24 603 0100	31600-KGF-860
Nexus Eu3	125	07-08	24 603 0162	58090R	Ses 125 Dylan	125	04-06	24 603 0102	31600-KGF-860
Runner 4T St Eu3	125	08-16	24 603 0162	58090R	Sh 125	125	01-02	24 603 0100	31600-KGF-860
Runner Vx	125	05-06	24 603 0162	58090R	Sh 125	125	01-02	24 603 0102	31600-KGF-860
Runner Vx 4T Eu3	125	06-07	24 603 0162	58090R	Sh 125	125	03	24 603 0100	31600-KGF-860
Runner Vx Race	125	06	24 603 0162	58090R	Sh 125	125	03	24 603 0102	31600-KGF-860
Runner Vx Sc	125	06-07	24 603 0162	58090R	Sh 125	125	04	24 603 0100	31600-KGF-860
Runner Vxr	200	05-06	24 603 0162	58090R	Sh 125	125	04	24 603 0102	31600-KGF-860
Runner Vxr 4T St Eu3	200	08-11	24 603 0162	58090R	Sh 125 D I	125	09	24 603 0241	31600-KTF-841
Runner Vxr Eu3	200	07	24 603 0162	58090R	Sh 125 D I	125	09	24 603 0242	31600-KTF-841
Runner Vxr Race	200	05-06	24 603 0162	58090R	Sh 125 I	125	05	24 603 0241	31600-KTF-841
Oregon	250	06-10	24 603 0162	58090R	Sh 125 I	125	05	24 603 0242	31600-KTF-841
GUZZI					Sh 125 I	125	06	24 603 0241	31600-KTF-841
Ntx	350	86-90	24 603 0330	GU29703800	Sh 125 I	125	06	24 603 0242	31600-KTF-841
V35 Carabinieri-Pa Pd30077>	350	92-01	24 603 0330	GU29703800	Sh 125 I	125	07	24 603 0241	31600-KTF-841
V35 Florida	350	86-90	24 603 0330	GU29703800	Sh 125 I	125	07	24 603 0242	31600-KTF-841
V35 II	350	80-85	24 603 0330	GU29703800	Sh 125 I	125	08	24 603 0241	31600-KTF-841
V35 III	350	85-87	24 603 0330	GU29703800	Sh 125 I	125	08	24 603 0242	31600-KTF-841
V35c-V50c	350	82-86	24 603 0330	GU29703800	Sh 125 I	125	09	24 603 0241	31600-KTF-841
V35-V50 Accensione Elettronica	350	77-79	24 603 0330	GU29703800	Sh 125 I	125	09	24 603 0242	31600-KTF-841
V50 III	500	80-84	24 603 0330	GU29703800	Sh 125 I	125	10	24 603 0241	31600-KTF-841
V50 III Polizia-Pa Vecchio Tipo	500	82-90	24 603 0330	GU29703800	Sh 125 I	125	10	24 603 0242	31600-KTF-841
V50 Pa	500	92-01	24 603 0330	GU29703800	Sh 125 I	125	11	24 603 0241	31600-KTF-841
Ntx	650	86-90	24 603 0330	GU29703800	Sh 125 I	125	11	24 603 0242	31600-KTF-841
V65 Custom	650	83-86	24 603 0330	GU29703800	Sh 125 I	125	12	24 603 0241	31600-KTF-841
V65 Florida	650	85-92	24 603 0330	GU29703800	Sh 125 I	125	12	24 603 0242	31600-KTF-841
V65 Polizia-Pa Nuovo Tipo	650	88-95	24 603 0330	GU29703800	Sh 125 I	125	13	24 603 0241	31600-KTF-841
750 X Polizia-Pa 1A Serie <Lx15449	750	92-94	24 603 0330	GU29703800	Sh 125 I	125	13	24 603 0242	31600-KTF-841
750 X Polizia-Pa 2A Serie Lx15450>	750	95-02	24 603 0330	GU29703800	XL 125 V Varadero	125	01	24 603 0100	31600-KGF-860
V75 Pa Vecchio Tipo	750	92-96	24 603 0330	GU29703800	XL 125 V Varadero	125	01	24 603 0102	31600-KGF-860
850 Le Mans III	850	81-84	24 603 0330	GU29703800	XL 125 V Varadero	125	02	24 603 0100	31600-KGF-860
850 T3 E Derivati	850	79-85	24 603 0330	GU29703800	XL 125 V Varadero	125	02	24 603 0102	31600-KGF-860
850 T5 Civile III Serie	850	84-87	24 603 0330	GU29703800	XL 125 V Varadero	125	03	24 603 0100	31600-KGF-860
850 T5 Polizia-Cc-Pa (Nc) <Vr36415	850	88-93	24 603 0330	GU29703800	XL 125 V Varadero	125	03	24 603 0102	31600-KGF-860
850 T5 Polizia-Cc-Pa Vecchio Tipo	850	85-89	24 603 0330	GU29703800	XL 125 V Varadero	125	04	24 603 0100	31600-KGF-860
1000 Gt	1000	87-91	24 603 0330	GU29703800	XL 125 V Varadero	125	04	24 603 0102	31600-KGF-860
1000 Sp	1000	79-83	24 603 0330	GU29703800	XL 125 V Varadero	125	05	24 603 0100	31600-KGF-860
1000 Sp II	1000	84-87	24 603 0330	GU29703800	XL 125 V Varadero	125	05	24 603 0102	31600-KGF-860
California II	1000	81-87	24 603 0330	GU29703800	XL 125 V Varadero	125	06	24 603 0100	31600-KGF-860
Le Mans	1000	84-93	24 603 0330	GU29703800	XL 125 V Varadero	125	06	24 603 0102	31600-KGF-860
HONDA					XL 125 V Varadero 80 Km/H	125	01	24 603 0100	31600-KGF-860
Fes 125 Pantheon	125	98-99	24 603 0100	31600-KGF-860	XL 125 V Varadero 80 Km/H	125	01	24 603 0102	31600-KGF-860
Fes 125 Pantheon	125	98-99	24 603 0102	31600-KGF-860	XL 125 V Varadero 80 Km/H	125	02	24 603 0100	31600-KGF-860
Fes 125 Pantheon	125	00	24 603 0100	31600-KGF-860	XL 125 V Varadero 80 Km/H	125	02	24 603 0102	31600-KGF-860
Fes 125 Pantheon	125	00	24 603 0102	31600-KGF-860	XL 125 V Varadero 80 Km/H	125	03	24 603 0100	31600-KGF-860
Fes 125 Pantheon	125	01	24 603 0100	31600-KGF-860	XL 125 V Varadero 80 Km/H	125	03	24 603 0102	31600-KGF-860
Fes 125 Pantheon	125	01	24 603 0102	31600-KGF-860	XL 125 V Varadero 80 Km/H	125	04	24 603 0100	31600-KGF-860
Fes 125 Pantheon	125	02	24 603 0100	31600-KGF-860	XL 125 V Varadero 80 Km/H	125	04	24 603 0102	31600-KGF-860
Fes 125 Pantheon	125	02	24 603 0102	31600-KGF-860	XL 125 V Varadero 80 Km/H	125	05	24 603 0100	31600-KGF-860
Nes 125 @/ Arobase	125	00	24 603 0100	31600-KGF-860	XL 125 V Varadero 80 Km/H	125	05	24 603 0102	31600-KGF-860
Nes 125 @/ Arobase	125	00	24 603 0102	31600-KGF-860	XL 125 V Varadero 80 Km/H	125	06	24 603 0100	31600-KGF-860
Nes 125 @/ Arobase	125	01	24 603 0100	31600-KGF-860	XL 125 V Varadero 80 Km/H	125	06	24 603 0102	31600-KGF-860



REGOLATORI

REGULATORS

Modello - Model	Cc	Anni Years	Codice RMS RMS Code	Rif. Originale Oem Number	Modello - Model	Cc	Anni Years	Codice RMS RMS Code	Rif. Originale Oem Number
Fes 150 Pantheon	150	98-99	24 603 0100	31600-KGF-860	Cb 600 F Hornet	600	06	24 603 0102	31600-KGF-860
Fes 150 Pantheon	150	98-99	24 603 0102	31600-KGF-860	Cb 600 S F2 Hornet S	600	02-03	24 603 0100	31600-KGF-860
Fes 150 Pantheon	150	00	24 603 0100	31600-KGF-860	Cb 600 S F2 Hornet S	600	02-03	24 603 0102	31600-KGF-860
Fes 150 Pantheon	150	00	24 603 0102	31600-KGF-860	Cbf 600 N	600	04	24 603 0100	31600-KGF-860
Fes 150 Pantheon	150	01	24 603 0100	31600-KGF-860	Cbf 600 N	600	04	24 603 0102	31600-KGF-860
Fes 150 Pantheon	150	01	24 603 0102	31600-KGF-860	Cbf 600 N	600	05	24 603 0100	31600-KGF-860
Fes 150 Pantheon	150	02	24 603 0100	31600-KGF-860	Cbf 600 N	600	05	24 603 0102	31600-KGF-860
Fes 150 Pantheon	150	02	24 603 0102	31600-KGF-860	Cbf 600 N	600	06-07	24 603 0100	31600-KGF-860
Nes 150 @/ Arobase	150	00	24 603 0100	31600-KGF-860	Cbf 600 N	600	06-07	24 603 0102	31600-KGF-860
Nes 150 @/ Arobase	150	00	24 603 0102	31600-KGF-860	Cbf 600 Na Abs	600	04	24 603 0100	31600-KGF-860
Nes 150 @/ Arobase	150	01	24 603 0100	31600-KGF-860	Cbf 600 Na Abs	600	04	24 603 0102	31600-KGF-860
Nes 150 @/ Arobase	150	01	24 603 0102	31600-KGF-860	Cbf 600 Na Abs	600	05	24 603 0100	31600-KGF-860
Nes 150 @/ Arobase	150	02	24 603 0100	31600-KGF-860	Cbf 600 Na Abs	600	05	24 603 0102	31600-KGF-860
Nes 150 @/ Arobase	150	02	24 603 0102	31600-KGF-860	Cbf 600 Na Abs	600	06-07	24 603 0100	31600-KGF-860
Nes 150 @/ Arobase	150	03	24 603 0100	31600-KGF-860	Cbf 600 Na Abs	600	06-07	24 603 0102	31600-KGF-860
Nes 150 @/ Arobase	150	03	24 603 0102	31600-KGF-860	Cbf 600 S	600	04	24 603 0100	31600-KGF-860
Nes 150 @/ Arobase	150	04	24 603 0100	31600-KGF-860	Cbf 600 S	600	04	24 603 0102	31600-KGF-860
Nes 150 @/ Arobase	150	04	24 603 0102	31600-KGF-860	Cbf 600 S	600	05	24 603 0100	31600-KGF-860
Nes 150 @/ Arobase	150	05	24 603 0100	31600-KGF-860	Cbf 600 S	600	05	24 603 0102	31600-KGF-860
Nes 150 @/ Arobase	150	05	24 603 0102	31600-KGF-860	Cbf 600 S	600	06-07	24 603 0100	31600-KGF-860
Nes 150 @/ Arobase	150	06	24 603 0100	31600-KGF-860	Cbf 600 S	600	06-07	24 603 0102	31600-KGF-860
Nes 150 @/ Arobase	150	06	24 603 0102	31600-KGF-860	Cbf 600 Sa Abs	600	04	24 603 0100	31600-KGF-860
Pes 150 Ps I	150	06	24 603 0241	31600-KTF-841	Cbf 600 Sa Abs	600	04	24 603 0102	31600-KGF-860
Pes 150 Ps I	150	06	24 603 0242	31600-KTF-841	Cbf 600 Sa Abs	600	05	24 603 0100	31600-KGF-860
Pes 150 Ps I	150	07	24 603 0241	31600-KTF-841	Cbf 600 Sa Abs	600	05	24 603 0102	31600-KGF-860
Pes 150 Ps I	150	07	24 603 0242	31600-KTF-841	Cbf 600 Sa Abs	600	06-07	24 603 0100	31600-KGF-860
Pes 150 Ps I	150	08	24 603 0241	31600-KTF-841	Cbf 600 Sa Abs	600	06-07	24 603 0102	31600-KGF-860
Pes 150 Ps I	150	08	24 603 0242	31600-KTF-841	Vt 750 C2 Shadow Aero	750	01-02	24 603 0100	31600-KGF-860
Pes 150 Ps I	150	09	24 603 0241	31600-KTF-841	Vt 750 C2 Shadow Aero	750	01-02	24 603 0102	31600-KGF-860
Pes 150 Ps I	150	09	24 603 0242	31600-KTF-841	Sh 50 Scoopy	50	96-00	24 603 0060	31600-GBL-871
Pes 150 Ps I	150	10	24 603 0241	31600-KTF-841	Sj 50 Bali	50	95	24 603 0060	31600-GBL-871
Pes 150 Ps I	150	10	24 603 0242	31600-KTF-841	Sh 100 Scoopy	100	96-01	24 603 0060	31600-GBL-871
Sh 150	150	01-02	24 603 0100	31600-KGF-860	Sj 100 Bali Ex	100	96-00	24 603 0060	31600-GBL-871
Sh 150	150	01-02	24 603 0102	31600-KGF-860	Nsr 125 F	125	88-92	24 603 0212	31600-KR1-761
Sh 150	150	03	24 603 0100	31600-KGF-860	Nsr 125 R	125	85-87	24 603 0212	31600-KR1-761
Sh 150	150	03	24 603 0102	31600-KGF-860	J125 Abs Bgf-Bgfa	125	16	24 603 0312	21066Y003
Sh 150	150	04	24 603 0100	31600-KGF-860	J125 Abs Chf-Chfa	125	17	24 603 0312	21066Y003
Sh 150	150	04	24 603 0102	31600-KGF-860	J125 Agf-Agfa	125	16	24 603 0312	21066Y003
Sh 150 D I	150	09-11	24 603 0241	31600-KTF-841	J300 Abs Bef-Befa-Bff-Bffa	300	14-15	24 603 0312	21066Y003
Sh 150 D I	150	09-11	24 603 0242	31600-KTF-841	J300 Abs Bgf-Bgfa	300	16	24 603 0312	21066Y003
Sh 150 I	150	05	24 603 0241	31600-KTF-841	J300 Abs Chf-Chfa	300	17	24 603 0312	21066Y003
Sh 150 I	150	05	24 603 0242	31600-KTF-841	J300 Aef-Aefa-Aff-Affa	300	14-15	24 603 0312	21066Y003
Sh 150 I	150	06	24 603 0241	31600-KTF-841	J300 Agf-Agfa	300	16	24 603 0312	21066Y003
Sh 150 I	150	06	24 603 0242	31600-KTF-841	ITALJET				
Sh 150 I	150	07	24 603 0241	31600-KTF-841	Torpedo 4T	50	-	24 603 0182	-
Sh 150 I	150	07	24 603 0242	31600-KTF-841	Millennium	125	00	24 603 0011	4870706560
Sh 150 I	150	08	24 603 0241	31600-KTF-841	Millennium	125	00	24 603 0012	4870706560
Sh 150 I	150	08	24 603 0242	31600-KTF-841	Torpedo (Leader)	125	-	24 603 0162	-
Nss 250 A Jazz Abs	250	01-02	24 603 0100	31600-KGF-860	Millennium	150	00	24 603 0011	4870706560
Nss 250 A Jazz Abs	250	01-02	24 603 0102	31600-KGF-860	Millennium	150	00	24 603 0012	4870706560
Nss 250 Jazz	250	01	24 603 0100	31600-KGF-860	Torpedo (Leader)	150	-	24 603 0162	-
Nss 250 Jazz	250	01	24 603 0102	31600-KGF-860	KYMC0				
Cbf 500	500	04-05	24 603 0100	31600-KGF-860	Agility 4T R16	50	08	24 603 0132	00131033
Cbf 500	500	04-05	24 603 0102	31600-KGF-860	Agility 4T R16	50	09	24 603 0132	00131033
Cbf 500	500	06-08	24 603 0100	31600-KGF-860	Agility Rs	50	09	24 603 0132	00131033
Cbf 500	500	06-08	24 603 0102	31600-KGF-860	Super 8	50	07	24 603 0132	00131026
Cbf 500 A Abs	500	04-05	24 603 0100	31600-KGF-860	Super 8 2T	50	13	24 603 0172	00168783
Cbf 500 A Abs	500	04-05	24 603 0102	31600-KGF-860	Super 8 4T	50	09	24 603 0132	00131026
Cbf 500 A Abs	500	06-08	24 603 0100	31600-KGF-860	Super 8 4T	50	13	24 603 0172	00168783
Cbf 500 A Abs	500	06-08	24 603 0102	31600-KGF-860	Agility Plus E4	125	16	24 603 0172	00168783
Cb 600 F Hornet	600	02	24 603 0100	31600-KGF-860	Agility R16	125	08	24 603 0132	00131033
Cb 600 F Hornet	600	02	24 603 0102	31600-KGF-860	Agility R16	125	09	24 603 0132	00131033
Cb 600 F Hornet	600	03	24 603 0100	31600-KGF-860	Agility Rs	125	09	24 603 0132	00131033
Cb 600 F Hornet	600	03	24 603 0102	31600-KGF-860	Dink 125 Eu3	125	06-07	24 603 0172	00168783
Cb 600 F Hornet	600	04	24 603 0100	31600-KGF-860	Downtown 125I	125	09-16	24 603 0142	00177005
Cb 600 F Hornet	600	04	24 603 0102	31600-KGF-860	K-Xct I	125	12-14	24 603 0302	00131148
Cb 600 F Hornet	600	05	24 603 0100	31600-KGF-860	People Gti	125	10	24 603 0142	00177005
Cb 600 F Hornet	600	05	24 603 0102	31600-KGF-860	People Gti	125	14	24 603 0142	00177005
Cb 600 F Hornet	600	06	24 603 0100	31600-KGF-860	People One E4	125	16	24 603 0172	00168783



Modello - Model	Cc	Anni Years	Codice RMS RMS Code	Rif. Originale Oem Number	Modello - Model	Cc	Anni Years	Codice RMS RMS Code	Rif. Originale Oem Number
People One I	125	13	24 603 0172	00168783	Dj X	50	91-92	24 603 0072	00169004
People One I Dd	125	15	24 603 0172	00168783	Dj Y	50	93	24 603 0070	00169004
People S	125	05	24 603 0132	00169587	Dj Y	50	93	24 603 0072	00169004
Quannon	125	08	24 603 0172	00168783	Fever Zx	50	99-00	24 603 0070	00169004
Quannon Naked	125	10	24 603 0172	00168783	Fever Zx	50	99-00	24 603 0072	00169004
Agility R16	150	08	24 603 0132	00131033	Fever Zx Eu2	50	03-04	24 603 0070	00169004
Agility 200I R16	200	10	24 603 0172	00168783	Fever Zx Eu2	50	03-04	24 603 0072	00169004
Agility I Plus	200	14	24 603 0172	00168783	Filly	50	98-00	24 603 0070	00169004
Agility R16	200	12	24 603 0172	00168783	Filly	50	98-00	24 603 0072	00169004
Dink Eu3i	200	06-07	24 603 0142	00177005	Filly Lx	50	01-02	24 603 0070	00169004
Downtown I	200	10	24 603 0142	00177005	Filly Lx	50	01-02	24 603 0072	00169004
Like 200I	200	09	24 603 0172	00168783	Heroism	50	95-97	24 603 0070	00169004
Like Lx	200	12	24 603 0172	00168783	Heroism	50	95-97	24 603 0072	00169004
People Gti	200	10	24 603 0142	00177005	K 12	50	95-00	24 603 0070	00169004
People Gti	200	14	24 603 0142	00177005	K 12	50	95-00	24 603 0072	00169004
People S	200	05	24 603 0132	00169587	Kb	50	95-00	24 603 0070	00169004
People S	250	06	24 603 0112	00168139	Kb	50	95-00	24 603 0072	00169004
People S 250I	250	07	24 603 0142	00177005	Mxer	50	02-03	24 603 0070	00169004
Venox	250	02-03	24 603 0142	00177005	Mxer	50	02-03	24 603 0072	00169004
Venox Eu2	250	04	24 603 0142	00177005	Mxer Eu2	50	04	24 603 0070	00169004
Venox Eu3	250	07	24 603 0142	00177005	Mxer Eu2	50	04	24 603 0072	00169004
X Citing I	250	06-07	24 603 0142	00177005	People	50	99-00	24 603 0070	00169004
Downtown 300I	300	09	24 603 0142	00177005	People	50	99-00	24 603 0072	00169004
Downtown Abs	300	10	24 603 0142	00177005	People	50	04	24 603 0070	00169004
Downtown Abs I	300	11-16	24 603 0142	00177005	People	50	04	24 603 0072	00169004
Downtown I	300	11	24 603 0142	00177005	People Eu2	50	03	24 603 0070	00169004
K-Xct I	300	12	24 603 0302	00131148	People Eu2	50	03	24 603 0072	00169004
K-Xct I Abs	300	14	24 603 0302	00131148	People Eu2	50	08	24 603 0070	00169004
People Gti	300	10	24 603 0142	00177005	People Eu2	50	08	24 603 0072	00169004
People Gti	300	11	24 603 0142	00177005	People S 4T	50	06-08	24 603 0070	00169119
People Gti	300	14	24 603 0142	00177005	People S 4T	50	06-08	24 603 0072	00169119
People Gti Abs	300	12	24 603 0142	00177005	Sniper	50	93	24 603 0070	00169004
People Gti Abs	300	14	24 603 0142	00177005	Sniper	50	93	24 603 0072	00169004
People Gti Abs E4	300	16	24 603 0142	00177005	Sniper Dd	50	94-96	24 603 0070	00169004
People S 300I	300	08	24 603 0142	00177005	Sniper Dd	50	94-96	24 603 0072	00169004
X Citing 300I	300	08	24 603 0142	00177005	Super 8	50	07	24 603 0122	00131026
X Citing 300I R	300	08	24 603 0142	00177005	Super 8 4T	50	09	24 603 0122	00131026
X Citing 300I R	300	09	24 603 0142	00177005	Super 9	50	00	24 603 0070	00169004
X Citing I	400	13	24 603 0302	00131148	Super 9	50	00	24 603 0072	00169004
X Citing I	400	15	24 603 0302	00131148	Super 9 Sport Eu2	50	03	24 603 0070	00169004
X Citing I Abs	400	14	24 603 0302	00131148	Super 9 Sport Eu2	50	03	24 603 0072	00169004
X Citing I Abs	400	15	24 603 0302	00131148	Super 9 Sport Eu2	50	04	24 603 0070	00169004
X Citing I Abs E4	400	16	24 603 0302	00131148	Super 9 Sport Eu2	50	04	24 603 0072	00169004
X Citing	500	05	24 603 0142	00177005	Top Boy	50	97-00	24 603 0070	00169004
Agility 4T R10	50	06	24 603 0070	00169119	Top Boy	50	97-00	24 603 0072	00169004
Agility 4T R10	50	06	24 603 0072	00169119	Vitality 2T	50	04	24 603 0070	00169004
Agility 4T R10	50	07-08	24 603 0070	00169004	Vitality 2T	50	04	24 603 0072	00169004
Agility 4T R10	50	07-08	24 603 0072	00169004	Vitality 4T	50	04	24 603 0070	00169004
Agility 4T R12	50	07-08	24 603 0070	00169237	Vitality 4T	50	04	24 603 0072	00169004
Agility 4T R12	50	07-08	24 603 0072	00169237	Yup	50	02	24 603 0070	00169004
Agility R12	50	05	24 603 0070	00169119	Yup	50	02	24 603 0072	00169004
Agility R12	50	05	24 603 0072	00169119	Yup Eu2	50	03	24 603 0070	00169004
B&W	50	02	24 603 0070	00169004	Yup Eu2	50	03	24 603 0072	00169004
B&W	50	02	24 603 0072	00169004	Agility 4T	125	06	24 603 0070	00169119
B&W Eu2	50	03	24 603 0070	00169004	Agility 4T	125	06	24 603 0072	00169119
B&W Eu2	50	03	24 603 0072	00169004	Agility 4T Eu3	125	06-08	24 603 0070	00169119
Cx	50	93	24 603 0070	00169004	Agility 4T Eu3	125	06-08	24 603 0072	00169119
Cx	50	93	24 603 0072	00169004	B&W	125	00	24 603 0081	00168780
Cx Super	50	94-97	24 603 0070	00169004	B&W	125	00	24 603 0082	00168780
Cx Super	50	94-97	24 603 0072	00169004	B&W Eu2	125	03-04	24 603 0081	00168780
Dink 50 4T	50	07	24 603 0070	00169004	B&W Eu2	125	03-04	24 603 0082	00168780
Dink 50 4T	50	07	24 603 0072	00169004	Dink	125	97-98	24 603 0081	00168780
Dink Classic Eu2	50	03	24 603 0070	00169004	Dink	125	97-98	24 603 0082	00168780
Dink Classic Eu2	50	03	24 603 0072	00169004	Dink Classic	125	02	24 603 0081	00168780
Dink Lc	50	98-02	24 603 0070	00169004	Dink Classic	125	02	24 603 0082	00168780
Dink Lc	50	98-02	24 603 0072	00169004	Dink Classic Eu2	125	03	24 603 0081	00168780
Dj W	50	94-00	24 603 0070	00169004	Dink Classic Eu2	125	03	24 603 0082	00168780
Dj W	50	94-00	24 603 0072	00169004	Dink Lx	125	98-00	24 603 0081	00168780
Dj X	50	91-92	24 603 0070	00169004	Dink Lx	125	98-00	24 603 0082	00168780



REGOLATORI

REGULATORS

Modello - Model	Cc	Anni Years	Codice RMS RMS Code	Rif. Originale Oem Number	Modello - Model	Cc	Anni Years	Codice RMS RMS Code	Rif. Originale Oem Number
G-Dink	125	12	24 603 0342	00131128	Grand Dink Eu2	250	03-04	24 603 0081	00168780
Grand Dink	125	01-02	24 603 0081	00168780	Grand Dink Eu2	250	03-04	24 603 0082	00168780
Grand Dink	125	01-02	24 603 0082	00168780	People Lc	250	03-04	24 603 0081	00168780
Grand Dink Eu2	125	03-04	24 603 0081	00168780	People Lc	250	03-04	24 603 0082	00168780
Grand Dink Eu2	125	03-04	24 603 0082	00168780	X Citing	250	05	24 603 0081	00168780
Heroism	125	95-97	24 603 0081	00168780	X Citing	250	05	24 603 0082	00168780
Heroism	125	95-97	24 603 0082	00168780	Yup	250	03	24 603 0081	00168780
Movie	125	99-00	24 603 0070	00169004	Yup	250	03	24 603 0082	00168780
Movie	125	99-00	24 603 0072	00169004	G-Dink	300	12	24 603 0342	00131128
Movie 125 Eu3	125	06-07	24 603 0070	00169004	MALAGUTI				
Movie 125 Eu3	125	06-07	24 603 0072	00169004	Centro Base	50	93-94	24 603 0050	02601100
Movie XL	125	01	24 603 0070	00169004	Centro Base	50	93-94	24 603 0051	02601100
Movie XL	125	01	24 603 0072	00169004	Centro SL	50	94-98	24 603 0050	02601100
Movie XL Eu2	125	03-04	24 603 0070	00169004	Centro SL	50	94-98	24 603 0051	02601100
Movie XL Eu2	125	03-04	24 603 0072	00169004	Centro SL Kat	50	99-00	24 603 0050	02601100
People	125	99-00	24 603 0070	00169004	Centro SL Kat	50	99-00	24 603 0051	02601100
People	125	99-00	24 603 0072	00169004	Ciak	50	99-00	24 603 0050	02601100
People Eu2	125	03	24 603 0070	00169004	Ciak	50	99-00	24 603 0051	02601100
People Eu2	125	03	24 603 0072	00169004	Ciak Mono Eu2	50	03	24 603 0050	02601100
People Eu3	125	07	24 603 0070	00169004	Ciak Mono Eu2	50	03	24 603 0051	02601100
People Eu3	125	07	24 603 0072	00169004	Ciak Td	50	00-01	24 603 0050	02601100
People Eu3	125	08	24 603 0070	00169004	Ciak Td	50	00-01	24 603 0051	02601100
People Eu3	125	08	24 603 0072	00169004	Crosser Cr1	50	95-98	24 603 0050	02601100
People S	125	05	24 603 0122	00169587	Crosser Cr1	50	95-98	24 603 0051	02601100
Vivio	125	00	24 603 0070	00169004	F10 Ac	50	08	24 603 0050	02601100
Vivio	125	00	24 603 0072	00169004	F10 Ac	50	08	24 603 0051	02601100
Zing	125	97-98	24 603 0212	00172385	F10 Ac Eco	50	09-10	24 603 0050	02601100
B&W	150	00	24 603 0081	00168780	F10 Ac Eco	50	09-10	24 603 0051	02601100
B&W	150	00	24 603 0082	00168780	F10 Jet Line	50	92-98	24 603 0050	02601100
B&W Eu2	150	03-04	24 603 0081	00168780	F10 Jet Line	50	92-98	24 603 0051	02601100
B&W Eu2	150	03-04	24 603 0082	00168780	F10 Kat	50	99-00	24 603 0050	02601100
Dink	150	97-98	24 603 0081	00168780	F10 Kat	50	99-00	24 603 0051	02601100
Dink	150	97-98	24 603 0082	00168780	F10 Restyling Eu1	50	01-02	24 603 0050	02601100
Dink Classic	150	02	24 603 0081	00168780	F10 Restyling Eu1	50	01-02	24 603 0051	02601100
Dink Classic	150	02	24 603 0082	00168780	F10 Restyling Eu2	50	02-03	24 603 0050	02601100
Dink Classic Eu2	150	03	24 603 0081	00168780	F10 Restyling Eu2	50	02-03	24 603 0051	02601100
Dink Classic Eu2	150	03	24 603 0082	00168780	F12 Phantom	50	94-98	24 603 0050	02601100
Dink Lx	150	98-00	24 603 0081	00168780	F12 Phantom	50	94-98	24 603 0051	02601100
Dink Lx	150	98-00	24 603 0082	00168780	F12 Phantom Eu1	50	99-00	24 603 0050	02601100
Grand Dink	150	01-02	24 603 0081	00168780	F12 Phantom Eu1	50	99-00	24 603 0051	02601100
Grand Dink	150	01-02	24 603 0082	00168780	F12 Phantom Lc	50	94-98	24 603 0050	02601100
Grand Dink Eu2	150	03-04	24 603 0081	00168780	F12 Phantom Lc	50	94-98	24 603 0051	02601100
Grand Dink Eu2	150	03-04	24 603 0082	00168780	F12 Phantom Lc Eu1	50	99-00	24 603 0050	02601100
Heroism	150	95-97	24 603 0081	00168780	F12 Phantom Lc Eu1	50	99-00	24 603 0051	02601100
Heroism	150	95-97	24 603 0082	00168780	F12 Phantom Lc Restyling Eu1	50	01-02	24 603 0050	02601100
Movie 150 Eu3	150	06-07	24 603 0070	00169119	F12 Phantom Lc Restyling Eu1	50	01-02	24 603 0051	02601100
Movie 150 Eu3	150	06-07	24 603 0072	00169119	F12 Phantom Lc Twin Disks	50	98	24 603 0050	02601100
Movie XI	150	01	24 603 0070	00169004	F12 Phantom Lc Twin Disks	50	98	24 603 0051	02601100
Movie XI	150	01	24 603 0072	00169004	F12 Phantom Restyling Eu1	50	01-02	24 603 0050	02601100
Movie XI Eu2	150	03-04	24 603 0070	00169004	F12 Phantom Restyling Eu1	50	01-02	24 603 0051	02601100
Movie XI Eu2	150	03-04	24 603 0072	00169004	F12 Phantom Restyling Eu2	50	02	24 603 0050	02601100
People	150	99-00	24 603 0070	00169004	F12 Phantom Restyling Eu2	50	02	24 603 0051	02601100
People	150	99-00	24 603 0072	00169004	F12r Phantom Ac	50	07-08	24 603 0050	02601100
People Eu2	150	03	24 603 0070	00169004	F12r Phantom Ac	50	07-08	24 603 0051	02601100
People Eu2	150	03	24 603 0072	00169004	F12r Phantom Ac	50	09-10	24 603 0050	02601100
Vivio	150	00	24 603 0070	00169004	F12r Phantom Ac	50	09-10	24 603 0051	02601100
Vivio	150	00	24 603 0072	00169004	F15 Fire Fox	50	96-98	24 603 0050	02601100
Zing	150	97-98	24 603 0212	00172385	F15 Fire Fox	50	96-98	24 603 0051	02601100
Dink Classic	200	04	24 603 0081	00168780	F15 Fire Fox Twin Disks & Special	50	98-99	24 603 0050	02601100
Dink Classic	200	04	24 603 0082	00168780	F15 Fire Fox Twin Disks & Special	50	98-99	24 603 0051	02601100
People S	200	05	24 603 0122	00169587	F15 Fire Fox Twin Disks Digit Kat	50	98-00	24 603 0050	02601100
People S 200l	200	07	24 603 0081	00168780	F15 Fire Fox Twin Disks Digit Kat	50	98-00	24 603 0051	02601100
People S 200l	200	07	24 603 0082	00168780	F15 Lc-Tds Restyling Eu1	50	01	24 603 0050	02601100
B&W	250	00	24 603 0081	00168780	F15 Lc-Tds Restyling Eu1	50	01	24 603 0051	02601100
B&W	250	00	24 603 0082	00168780	Yesterday - Yesterday Euro	50	97-00	24 603 0050	02601100
B&W Eu2	250	03	24 603 0081	00168780	Yesterday - Yesterday Euro	50	97-00	24 603 0051	02601100
B&W Eu2	250	03	24 603 0082	00168780	Ciak	100	99-00	24 603 0050	02601100
Grand Dink	250	01-02	24 603 0081	00168780	Ciak	100	99-00	24 603 0051	02601100
Grand Dink	250	01-02	24 603 0082	00168780	F12 Phantom	100	99-00	24 603 0050	02601100



REGOLATORI

REGULATORS

Modello - Model	Cc	Anni Years	Codice RMS RMS Code	Rif. Originale Oem Number	Modello - Model	Cc	Anni Years	Codice RMS RMS Code	Rif. Originale Oem Number
Ape FL3 Europa	50	96-99	24 603 0042	2940165	Vespa Et2	50	98-05	24 603 0152	58096R
Ape FL3 Europa	50	96-99	24 603 0321	2180605	Vespa FL	50	90	24 603 0020	2308245
Ape Mix 2T	50	98-08	24 603 0152	58096R	Vespa FL2 Automatica	50	90-91	24 603 0040	2940165
Ape Mix 2T	50	98-08	24 603 0321	2180605	Vespa FL2 Automatica	50	90-91	24 603 0042	2940165
Ape Rst Mix	50	99-03	24 603 0152	82587R	Vespa FL2 Hp	50	91-97	24 603 0040	2940165
Ape Rst Mix	50	99-03	24 603 0321	2180605	Vespa FL2 Hp	50	91-97	24 603 0042	2940165
Ape Tm P	50	85-89	24 603 0020	2308245	Vespa Lx 2T	50	09-13	24 603 0152	58096R
Diesis	50	01	24 603 0152	82587R	Vespa Lx 2T	50	05-08	24 603 0152	58096R
Fly 2T	50	05-07	24 603 0152	58096R	Vespa Lx 2T Touring & 30Km	50	10-13	24 603 0152	58096R
Fly 2T	50	10-11	24 603 0152	58096R	Vespa Lx 4T-4V	50	09-13	24 603 0182	641788
Fly 4T & 25-30 Km/H	50	08-11	24 603 0182	639751	Vespa Lx 4T-4V Touring	50	10-13	24 603 0182	641788
Fly 4T 2V	50	13-15	24 603 0182	641788	Vespa Lxv 2T	50	06-09	24 603 0152	58096R
Fly 4T 2V 25-30Km-H	50	12-14	24 603 0182	641788	Vespa Lxv 2T Navy	50	08	24 603 0152	58096R
Fly 4T 4V	50	12-13	24 603 0182	641788	Vespa N	50	89-90	24 603 0020	2308245
Fly 4T Motore Chn	50	06-07	24 603 0182	639751	Vespa Pk	50	82-84	24 603 0030	1616395
Free	50	92-94	24 603 0040	2940165	Vespa Pk	50	82-84	24 603 0031	1616395
Free	50	92-94	24 603 0042	2940165	Vespa Pk (Avv.elettrico)	50	82-84	24 603 0042	2940165
Free Delivery	50	00-01	24 603 0152	82587R	Vespa Pk (Avv.elettrico)	50	82-84	24 603 0040	2940165
Free FL	50	95-02	24 603 0040	2940165	Vespa Pk Automatica	50	84-89	24 603 0030	1616395
Free FL	50	95-02	24 603 0042	2940165	Vespa Pk Automatica	50	84-89	24 603 0031	1616395
Free FL	50	95-02	24 603 0152	82587R	Vespa Pk Automatica (Avv.elettrico)	50	84-89	24 603 0040	2940165
Liberty	50	97-05	24 603 0152	82587R	Vespa Pk Automatica (Avv.elettrico)	50	84-89	24 603 0042	2940165
Liberty 2T	50	06	24 603 0152	58096R	Vespa Pk XL	50	85-88	24 603 0020	2308245
Liberty 2T	50	07-08	24 603 0152	58096R	Vespa Pk XL Plurimatic	50	85-90	24 603 0030	1616395
Liberty 2T Rst	50	04	24 603 0152	82587R	Vespa Pk XL Plurimatic	50	85-90	24 603 0031	1616395
Liberty 2T Sport	50	06	24 603 0152	82587R	Vespa Pk XL Rush	50	88-89	24 603 0020	2308245
Liberty 2T Sport	50	07-08	24 603 0152	58096R	Vespa Primavera 2T	50	13-17	24 603 0152	58096R
Liberty Iget 4T 3V 25Km/H	50	16	24 603 0162	58090R5	Vespa Primavera 4T-4V	50	13-17	24 603 0182	641788
Liberty Iget 4T 3V le	50	15-17	24 603 0162	58090R	Vespa S 2T & College	50	07-12	24 603 0152	58096R
Liberty Moc 2T & Elle	50	09-13	24 603 0152	58096R	Vespa S 4T-4V & College	50	08-12	24 603 0182	641788
Liberty Ptt Eu2	50	04-05	24 603 0152	82587R	Vespa Sprint 2T 2V	50	14-16	24 603 0152	58096R
Nrg	50	94-96	24 603 0040	2940165	Vespa Sprint 4T 4V	50	14-17	24 603 0182	641788
Nrg	50	94-96	24 603 0042	2940165	Zip	50	00-04	24 603 0152	82587R
Nrg Extreme	50	99-00	24 603 0152	82587R	Zip	50	92-93	24 603 0040	2940165
Nrg Mc3	50	01-04	24 603 0152	82587R	Zip	50	92-93	24 603 0042	2940165
Nrg Power Dd	50	05	24 603 0152	58096R	Zip	50	95-96	24 603 0040	2940165
Nrg Power Dd	50	06	24 603 0152	58096R	Zip	50	95-96	24 603 0042	2940165
Nrg Power Dd	50	07-15	24 603 0152	58096R	Zip 2T	50	08-13	24 603 0152	58096R
Nrg Power Dd Serie Speciale	50	07-12	24 603 0152	58096R	Zip 4T	50	06-13	24 603 0182	641788
Nrg Power Dt	50	06	24 603 0152	58096R	Zip 4T 25Km-H	50	06-16	24 603 0182	641788
Nrg Power Dt	50	07-15	24 603 0152	58096R	Zip Fast Raider	50	93-94	24 603 0040	2940165
Nrg Power Dt Serie Speciale	50	07-08	24 603 0152	58096R	Zip Fast Raider	50	93-94	24 603 0042	2940165
Nrg Power Purejet	50	06	24 603 0162	58090R	Zip Fast Raider Rst	50	96-97	24 603 0040	2940165
Nrg Power Purejet	50	04-05	24 603 0162	58090R	Zip Fast Raider Rst	50	96-97	24 603 0042	2940165
Nrg Power Purejet	50	07-09	24 603 0162	58090R	Zip Rst	50	96-99	24 603 0040	291931
Nrg Power Purejet	50	10-11	24 603 0162	58090R	Zip Rst	50	96-99	24 603 0042	291931
Nrg Purejet	50	10	24 603 0162	58090R	Zip Rst	50	96-99	24 603 0152	82587R
Nrg Rst Mc2	50	96-98	24 603 0040	2940165	Zip Sp	50	01-04	24 603 0152	82587R
Nrg Rst Mc2	50	96-98	24 603 0042	2940165	Zip Sp	50	96-00	24 603 0040	2940165
Nrg Rst Mc2	50	96-98	24 603 0152	82587R	Zip Sp	50	96-00	24 603 0042	2940165
Ntt	50	95-96	24 603 0040	2940165	Zip Sp Eu2	50	06-13	24 603 0152	58096R
Ntt	50	95-96	24 603 0042	2940165	Skr City	80	99	24 603 0040	291931
Quartz	50	92-96	24 603 0040	2940165	Skr City	80	99	24 603 0042	291931
Quartz	50	92-96	24 603 0042	2940165	Fly 4T	100	08-14	24 603 0182	641788
Sfera	50	91-93	24 603 0040	2940165	Fly 4T	100	06-07	24 603 0182	639751
Sfera	50	91-93	24 603 0042	2940165	Zip 4T	100	06-10	24 603 0182	641788
Sfera Maquillage 2	50	94	24 603 0040	2940165	Beverly Eu3	125	07-08	24 603 0162	58090R
Sfera Maquillage 2	50	94	24 603 0042	2940165	Beverly Eu3 Mic	125	07	24 603 0162	58090R
Sfera Rst	50	95-97	24 603 0040	2940165	Beverly Eu3 Sport	125	07-08	24 603 0162	58090R
Sfera Rst	50	95-97	24 603 0042	2940165	Beverly Rst	125	05-07	24 603 0162	58090R
Typhoon	50	01-04	24 603 0152	82587R	Beverly Rst 4T 4V le Eu3	125	10-15	24 603 0281	641709
Typhoon	50	05-08	24 603 0152	58096R	Carnaby	125	07-10	24 603 0162	58090R
Typhoon	50	09-11	24 603 0152	58096R	Cosa 2	125	91-97	24 603 0020	2308245
Typhoon 2T Eu2	50	10-16	24 603 0152	58096R	Cosa CL-CLX	125	88-91	24 603 0020	2308245
Typhoon 2T Eu3 Ch	50	11	24 603 0152	58096R	Fly	125	05-07	24 603 0162	58090R
Velofax	50	96-99	24 603 0040	2940165	Fly 4T 3V le E3 Dt	125	13-15	24 603 0292	58204R
Velofax	50	96-99	24 603 0042	2940165	Fly 4T 3V le Eu3 Lem	125	12-13	24 603 0292	58204R
Vespa Et2	50	97	24 603 0040	2940165	Fly Eu3	125	07	24 603 0162	58090R
Vespa Et2	50	97	24 603 0042	2940165	Fly Eu3	125	08-11	24 603 0162	58090R



Modello - Model	Cc	Anni Years	Codice RMS RMS Code	Rif. Originale Oem Number	Modello - Model	Cc	Anni Years	Codice RMS RMS Code	Rif. Originale Oem Number
Hexagon Gtx	125	00	24 603 0162	58090R	Vespa Sprint 4T 3V Ie	125	14-15	24 603 0162	58090R
Hexagon Lx4	125	98-99	24 603 0152	82587R	Vespa Sprint Iget 4T 3V Abs	125	16-17	24 603 0162	58090R
Liberty	125	01-02	24 603 0162	58090R	X Evo	125	07-16	24 603 0162	58090R
Liberty	125	98-00	24 603 0152	82587R	X7 Euro 3	125	08	24 603 0162	58090R
Liberty 4T	125	06-07	24 603 0162	58090R	X8	125	05-06	24 603 0162	58090R
Liberty 4T 2V Eu3	125	09-12	24 603 0162	58090R	X8	125	05-06	24 603 0162	58090R
Liberty 4T 2V Ie Ptt - Ita	125	12-13	24 603 0292	58204R	X8 Premium Eu2	125	06	24 603 0162	58090R
Liberty 4T 3V Ie E3	125	13-14	24 603 0292	58204R	X8 Premium Eu3	125	06-07	24 603 0162	58090R
Liberty 4T Eu3	125	06-08	24 603 0162	58090R	X8 Street Eu2	125	06-07	24 603 0162	58090R
Liberty 4T Eu3 Delivery - Single	125	07-15	24 603 0162	58090R	X9 Evolution	125	05-06	24 603 0162	58090R
Liberty 4T Eu3 Delivery - Tnt - Nexive	125	08-15	24 603 0162	58090R	X9 Evolution Eu3	125	07	24 603 0162	58090R
Liberty 4T Sport Eu3	125	06-08	24 603 0162	58090R	Zip	125	00-02	24 603 0162	58090R
Liberty Iget 4T 3V Ie	125	15-17	24 603 0162	58090R	Fly	150	05-07	24 603 0162	58090R
Liberty Rst Ptt	125	05-11	24 603 0162	58090R	Fly Eu3	150	08-11	24 603 0162	58090R
Liberty Sport	125	06	24 603 0162	58090R	Liberty 4T 3V Lem	150	13-14	24 603 0292	58204R
Mp3	125	06-08	24 603 0162	58090R	Liberty 4T Eu3	150	08	24 603 0162	58090R
Mp3 Ibrido	125	09-10	24 603 0192	639110	Liberty 4T Sport Eu3	150	08	24 603 0162	58090R
Mp3 Ie	125	08-09	24 603 0281	641709	Liberty Iget 4T 3V Ie	150	15-17	24 603 0162	58090R5
Mp3 Ie Touring	125	11-12	24 603 0281	641709	Liberty Moc 4T Eu3	150	09-13	24 603 0162	58090R
Mp3 Yourban Erl	125	11-13	24 603 0281	641533	Vespa Gts Super Ie 4T 3V Au,Ex,Ip,Ri,T,V	150	14-15	24 603 0292	58204R
Sfera	125	95-97	24 603 0040	2940165	Vespa Lt 4T 3V Ie	150	14	24 603 0292	58204R
Sfera	125	95-97	24 603 0042	2940165	Vespa Lx	150	05-06	24 603 0162	58090R
Skipper 4T	125	00-02	24 603 0162	58090R	Vespa Lx 4T 3V Ie - Touring	150	12-13	24 603 0162	58090R
Super Hexagon Gtx 12	125	01-02	24 603 0162	58090R	Vespa Lx 4T 3V Ie - Touring	150	12-13	24 603 0292	58204R
Typhoon 4T 2V Eu3	125	10-11	24 603 0162	58090R	Vespa Lx 4T Fl	150	09	24 603 0162	58090R
Vespa 946 4T 3V Abs - 946 Red Emea, Apac	125	13-17	24 603 0292	58204R	Vespa Lx Eu3	150	06-08	24 603 0162	58090R
Vespa 946 4T 3V Abs Armani	125	15	24 603 0292	58204R	Vespa Lx Eu3 Ie	150	09-11	24 603 0292	58204R
Vespa Et4	125	96-98	24 603 0040	2940165	Vespa Lx Touring	150	10-12	24 603 0292	58204R
Vespa Et4	125	96-98	24 603 0042	2940165	Vespa Primavera 4T 3V Iget Abs	150	16-17	24 603 0162	58090R
Vespa Et4	125	96-98	24 603 0152	58096R	Vespa Primavera 4T-3V	150	13-16	24 603 0162	58090R
Vespa Et4	125	99-02	24 603 0162	58090R	Vespa Px	150	11-17	24 603 0020	2308245
Vespa Fl	125	89-90	24 603 0020	2308245	Vespa S 4T	150	08-09	24 603 0162	58090R
Vespa Granturismo	125	03-05	24 603 0162	58090R	Vespa S 4T Ie & College	150	09-12	24 603 0292	58204R
Vespa Granturismo	125	06-07	24 603 0162	58090R	Vespa Sprint 4T 3V Ie	150	15	24 603 0162	58090R
Vespa Granturismo Eu3	125	06-07	24 603 0162	58090R	Vespa Sprint Sport 4T 3V Iget Abs	150	16-17	24 603 0162	58090R5
Vespa Gts 4T Ie Super	125	09-16	24 603 0281	641709	X8 Street Eu2	150	06-08	24 603 0162	58090R
Vespa Gts 4T Ie Super	125	09-16	24 603 0192	584533	Carnaby	200	07-08	24 603 0162	58090R
Vespa Gts 4T Ie Super	125	09-16	24 603 0192	58086R	Liberty	200	06	24 603 0162	58090R
Vespa Gts Eu3	125	07-12	24 603 0162	58090R	Liberty 4T Eu3	200	06-08	24 603 0162	58090R
Vespa Gtv	125	06-08	24 603 0162	58090R	Liberty 4T Sport Eu3	200	06-07	24 603 0162	58090R
Vespa Gtv 4T Navy Eu3	125	08	24 603 0162	58090R	Liberty Sport	200	06	24 603 0162	58090R
Vespa Lx	125	05-06	24 603 0162	58090R	Vespa Granturismo	200	06-07	24 603 0162	58090R
Vespa Lx 4T 3V Ie - Touring	125	12-13	24 603 0292	58204R	X8	200	05-07	24 603 0162	58090R
Vespa Lx 4T Eu3 Touring	125	10-11	24 603 0292	58204R	Ape Car P2-P3	220	78-85	24 603 0270	157714
Vespa Lx 4T Fl	125	09	24 603 0162	58090R	Ape Mp P501-P601	220	78-96	24 603 0270	157714
Vespa Lx Eu3	125	06-08	24 603 0162	58090R	Ape Tm	220	09-16	24 603 0270	157714
Vespa Lx Eu3 Ie	125	09-11	24 603 0292	58204R	Ape Tm P602	220	82-83	24 603 0270	157714
Vespa Lx Primavera 4T 3V Ie	125	13-17	24 603 0162	58090R5	Ape Tm P703 Fl2	220	99-07	24 603 0270	256023
Vespa Lxv 4T Eu3	125	06-09	24 603 0162	58090R	Ape Tm P703-P703v Fl2	220	99-07	24 603 0270	256023
Vespa Lxv 4T Navy Eu3	125	07-08	24 603 0162	58090R	Beverly	250	06-07	24 603 0162	58090R
Vespa Lxv Ie 4T	125	10-13	24 603 0292	58204R	Beverly Cruiser	250	07-09	24 603 0192	58086R
Vespa Pk XL	125	86-89	24 603 0030	1616395	Beverly Eu3 Mic	250	07	24 603 0192	58086R
Vespa Pk XL	125	86-89	24 603 0031	1616395	Beverly Ie Eu3	250	06-08	24 603 0192	58086R
Vespa Pk XL (Avv.elettrico)	125	86-89	24 603 0020	2308245	Beverly Sport	250	06-08	24 603 0192	58086R
Vespa Primavera 4T 3V E4 Iget Abs	125	16-17	24 603 0162	58090R5	Beverly Tourer Eu3	250	07-09	24 603 0192	58086R
Vespa Px	125	11-16	24 603 0020	58074R	Carnaby	250	08	24 603 0192	639110
Vespa Px	125	98-01	24 603 0020	2308245	Mp3	250	06-08	24 603 0192	639110
Vespa Px 30 Anni	125	07-08	24 603 0020	2308245	Mp3 Lt	250	08-09	24 603 0192	639110
Vespa Px Eu2	125	01-07	24 603 0020	2308245	Mp3 Mic	250	08-09	24 603 0192	58086R
Vespa Px T5	125	85-89	24 603 0030	1616395	Mp3 Mic	250	08-09	24 603 0192	639110
Vespa Px T5	125	85-89	24 603 0031	1616395	Vespa Gt 60 Eu3	250	06-07	24 603 0192	639110
Vespa Px T5 (Avv.elettrico)	125	85-89	24 603 0020	2308245	Vespa Gts	250	05-16	24 603 0281	641709
Vespa Pxe Arcobaleno	125	81-97	24 603 0030	1616395	Vespa Gts	250	05-16	24 603 0192	639110
Vespa Pxe Arcobaleno	125	81-97	24 603 0031	1616395	Vespa Gts Abs	250	05-12	24 603 0192	58086R
Vespa Pxe Arcobaleno (Avv.elettrico)	125	81-97	24 603 0040	2940165	Vespa Gtv	250	06-09	24 603 0192	639110
Vespa Pxe Arcobaleno (Avv.elettrico)	125	81-97	24 603 0042	2940165	Vespa Gtv 4T Navy Eu3	250	07	24 603 0192	639110
Vespa S 4T 3V Ie	125	12	24 603 0292	58204R	X Evo	250	07-16	24 603 0192	639110
Vespa S 4T Eu3	125	07-08	24 603 0162	58090R	X7 Eu3	250	08	24 603 0192	639110
Vespa S 4T Ie & College	125	09-11	24 603 0292	58204R	X8 Eu3	250	05-08	24 603 0192	58086R



REGOLATORI

REGULATORS

Modello - Model	Cc	Anni Years	Codice RMS RMS Code	Rif. Originale Oem Number	Modello - Model	Cc	Anni Years	Codice RMS RMS Code	Rif. Originale Oem Number
X9	250	00-01	24 603 0102	496454	Bw's	50	06-07	24 603 0072	5RNH19600000
X9 Evolution	250	06	24 603 0162	58090R	Bw's	50	08-12	24 603 0070	5RNH19600000
Beverly Rst 4T 4V Ie Eu3	300	10-15	24 603 0281	641709	Bw's	50	08-12	24 603 0072	5RNH19600000
Beverly Tourer Eu3	300	09-10	24 603 0192	58086R	Bw's	50	13-16	24 603 0070	5RNH19600000
Beverly Tourer Eu3	300	09-10	24 603 0192	639110	Bw's	50	13-16	24 603 0072	5RNH19600000
Carnaby Cruiser	300	09-12	24 603 0192	58086R	Bw's Naked	50	03	24 603 0070	5RNH19600000
Mp3 300 Ie Lt	300	10-11	24 603 0281	58208R	Bw's Naked	50	03	24 603 0072	5RNH19600000
Mp3 300 Ie Mic	300	10	24 603 0281	58208R	Bw's Naked	50	04	24 603 0070	5RNH19600000
Mp3 300 Ie Mic	300	10	24 603 0192	58086R	Bw's Naked	50	04	24 603 0072	5RNH19600000
Mp3 300 Ie Mic	300	11	24 603 0281	641709	Bw's Naked	50	09-12	24 603 0070	5RNH19600000
Mp3 300 Ie Mic	300	11	24 603 0192	639110	Bw's Naked	50	09-12	24 603 0072	5RNH19600000
Mp3 4T 4V Ie Lt Ibrido	300	10-11	24 603 0192	639110	Bw's Naked	50	13-16	24 603 0070	5RNH19600000
Mp3 Ie E4 Lt Business - Sport Abs	300	16-17	24 603 0281	641709	Bw's Naked	50	13-16	24 603 0072	5RNH19600000
Mp3 Ie Lt- Ie Lt Sport	300	11-14	24 603 0281	641709	Bw's Next Generation	50	03	24 603 0070	5RNH19600000
Mp3 Ie Lt Touring	300	11-13	24 603 0281	641709	Bw's Next Generation	50	03	24 603 0072	5RNH19600000
Mp3 Ie Touring	300	11-12	24 603 0281	641709	Bw's Next Generation	50	04-06	24 603 0070	5RNH19600000
Mp3 Yourban Erl	300	11-15	24 603 0281	641709	Bw's Next Generation	50	04-06	24 603 0072	5RNH19600000
Mp3 Yourban Lt Erl	300	11-12	24 603 0281	641709	Bw's Original Eu2	50	03	24 603 0070	5RNH19600000
Vespa Gts Ie & Touring	300	12-16	24 603 0281	641709	Bw's Original Eu2	50	03	24 603 0072	5RNH19600000
Vespa Gts Ie Abs E4	300	16-17	24 603 0281	641709	Bw's R	50	01	24 603 0050	5FXH19600000
Vespa Gts Ie Touring	300	11-12	24 603 0281	641709	Bw's R	50	01	24 603 0051	5FXH19600000
Vespa Gts Super	300	08-16	24 603 0281	641709	Cs Jog R	50	02	24 603 0070	5RNH19600000
Vespa Gts Super	300	08-16	24 603 0192	58086R	Cs Jog R	50	02	24 603 0072	5RNH19600000
Vespa Gts Super Sport	300	10-13	24 603 0281	58208R	Cs Jog R	50	06-12	24 603 0070	5RNH19600000
Vespa Gtv 4T 4V Ie	300	10-13	24 603 0281	641709	Cs Jog R	50	06-12	24 603 0072	5RNH19600000
Vespa Gtv Via Montenapoleone	300	10	24 603 0281	58208R	Cs Jog R	50	13-15	24 603 0070	5RNH19600000
Beverly Eu3	400	06-07	24 603 0192	58086R	Cs Jog R	50	13-15	24 603 0072	5RNH19600000
Beverly Eu3	400	06-07	24 603 0192	639110	Cs Jog R Eu2	50	02-05	24 603 0070	5RNH19600000
Beverly Tourer Eu3	400	08-10	24 603 0192	639110	Cs Jog R Eu2	50	02-05	24 603 0072	5RNH19600000
Mp3	400	07-08	24 603 0192	639110	Cw L Bw's	50	03	24 603 0070	5RNH19600000
Mp3 Ie Lt - Mp3 Ie Lt Sport	400	08-10	24 603 0192	639110	Cw L Bw's	50	03	24 603 0072	5RNH19600000
Mp3 Ie Lt Touring	400	11	24 603 0192	639110	Cw L Bw's	50	04	24 603 0070	5RNH19600000
Mp3 Mic	400	08-10	24 603 0192	639110	Cw L Bw's	50	04	24 603 0072	5RNH19600000
Mp3 RI Touring	400	11	24 603 0192	639110	Dt R - Dt X	50	07	24 603 0070	5RNH19600000
X Evo	400	07-11	24 603 0192	639110	Dt R - Dt X	50	07	24 603 0072	5RNH19600000
X8 Eu3	400	06-08	24 603 0192	639110	Dt R - Dt X	50	08-11	24 603 0070	5RNH19600000
Ape Car - Max Diesel	420	86-96	24 603 0260	2318775	Dt R - Dt X	50	08-11	24 603 0072	5RNH19600000
Ape Tm P703-P703v Diesel	420	87-04	24 603 0260	231877	Tzr	50	03-05	24 603 0070	5RNH19600000
Beverly	500	02-04	24 603 0192	584533	Tzr	50	03-05	24 603 0072	5RNH19600000
Beverly	500	05-06	24 603 0192	58086R	Tzr	50	06	24 603 0070	5RNH19600000
Beverly Cruiser	500	07-12	24 603 0192	58086R	Tzr	50	06	24 603 0072	5RNH19600000
Beverly Eu3	500	06-08	24 603 0192	58086R	Tzr	50	07	24 603 0070	5RNH19600000
Mp3 Lt E4 Sport - Business	500	16	24 603 0281	641709	Tzr	50	07	24 603 0072	5RNH19600000
Mp3 Lt Sport - Business	500	11-13	24 603 0192	639110	Tzr	50	08	24 603 0070	5RNH19600000
Mp3 RI Sport - Business	500	11-12	24 603 0192	639110	Tzr	50	08	24 603 0072	5RNH19600000
X9	500	01-02	24 603 0192	584533	Tzr	50	10	24 603 0070	5RNH19600000
X9 Evolution	500	03-05	24 603 0192	584533	Tzr	50	10	24 603 0072	5RNH19600000
X9 Evolution	500	06-07	24 603 0192	58086R	Tzr	50	11	24 603 0070	5RNH19600000
X9 Evolution Abs	500	06-07	24 603 0192	58086R	Tzr	50	11	24 603 0072	5RNH19600000
SUZUKI					Tzr	50	12	24 603 0070	5RNH19600000
Ah50 Address	50	92-95	24 603 0050	32800-40D10-000	Tzr	50	12	24 603 0072	5RNH19600000
Ah50 Address	50	92-95	24 603 0051	32800-40D10-000	Tzr Rr	50	05	24 603 0070	5RNH19600000
Aj Zz Sepia S	50	95-97	24 603 0050	32800-40D10-000	Tzr Rr	50	05	24 603 0072	5RNH19600000
Aj Zz Sepia S	50	95-97	24 603 0051	32800-40D10-000	Yh Why	50	06	24 603 0070	5RNH19600000
SYM					Yh Why	50	06	24 603 0072	5RNH19600000
Jet Euro X Eu2	50	03-07	24 603 0212	31600M9Q000	Yh Why Eu2	50	03-05	24 603 0070	5RNH19600000
Jet Sport X	50	07-11	24 603 0212	31600M9Q000	Yh Why Eu2	50	03-05	24 603 0072	5RNH19600000
Euro Mx	125	02	24 603 0212	31600M9Q000	Yn Neo's	50	04-06	24 603 0070	5RNH19600000
Euro Mx E2	125	03-04	24 603 0212	31600M9Q000	Yn Neo's	50	04-06	24 603 0072	5RNH19600000
Husky	125	99-00	24 603 0212	31600M9Q000	Yn Neo's	50	07-12	24 603 0070	5RNH19600000
Jet V	125	11	24 603 0212	31600M9Q000	Yn Neo's	50	07-12	24 603 0072	5RNH19600000
Shark	125	99-02	24 603 0212	31600M9Q000	Yn Neo's	50	12-16	24 603 0070	5RNH19600000
Euro Mx	150	02	24 603 0212	31600M9Q000	Yn Neo's	50	12-16	24 603 0072	5RNH19600000
Euro Mx Eu2	150	03-04	24 603 0212	31600M9Q000	Yn Neo's Eu2	50	02-03	24 603 0070	5RNH19600000
Shark	150	00-01	24 603 0212	31600M9Q000	Yn Neo's Eu2	50	02-03	24 603 0072	5RNH19600000
YAMAHA					Yn R Neo's	50	02	24 603 0070	5RNH19600000
Bw's	50	04-05	24 603 0070	5RNH19600000	Yn R Neo's	50	02	24 603 0072	5RNH19600000
Bw's	50	04-05	24 603 0072	5RNH19600000	Yq Aerox	50	04	24 603 0070	5RNH19600000
Bw's	50	06-07	24 603 0070	5RNH19600000	Yq Aerox	50	04	24 603 0072	5RNH19600000



Modello - Model	Cc	Anni Years	Codice RMS RMS Code	Rif. Originale Oem Number	Modello - Model	Cc	Anni Years	Codice RMS RMS Code	Rif. Originale Oem Number
Yq Aerox	50	05	24 603 0070	5RNH19600000	Xn Teo's	150	01-02	24 603 0011	5NRW19600000
Yq Aerox	50	05	24 603 0072	5RNH19600000	Xn Teo's	150	01-02	24 603 0072	5NRW19600000
Yq Aerox	50	06	24 603 0070	5RNH19600000	Yp150 Majesty	150	00	24 603 0011	5NRW19600000
Yq Aerox	50	06	24 603 0072	5RNH19600000	Yp150 Majesty	150	00	24 603 0072	5NRW19600000
Yq Aerox	50	07	24 603 0070	5RNH19600000	Yp150 Majesty	150	01-02	24 603 0011	5NRW19600000
Yq Aerox	50	07	24 603 0072	5RNH19600000	Yp150 Majesty	150	01-02	24 603 0072	5NRW19600000
Yq Aerox	50	08	24 603 0070	5RNH19600000	Yp150 Majesty	150	01-02	24 603 0090	4HMH19600000
Yq Aerox	50	08	24 603 0072	5RNH19600000	Yp150 Majesty	150	01-02	24 603 0092	4HMH19600000
Yq Aerox	50	09	24 603 0070	5RNH19600000	Yp180e Majesty	180	03-06	24 603 0090	4HMH19600000
Yq Aerox	50	09	24 603 0072	5RNH19600000	Yp180e Majesty	180	03-06	24 603 0092	4HMH19600000
Yq Aerox	50	10-12	24 603 0070	5RNH19600000	Vp X-City	250	07	24 603 0222	5BN819600000
Yq Aerox	50	10-12	24 603 0072	5RNH19600000	Vp X-City	250	08	24 603 0222	5BN819600000
Yq L Aerox Eu2	50	03	24 603 0070	5RNH19600000	Vp X-City	250	09-12	24 603 0222	5BN819600000
Yq L Aerox Eu2	50	03	24 603 0072	5RNH19600000	Vp X-City	250	13-15	24 603 0222	5BN819600000
Yn Neo's	100	99-02	24 603 0070	5RNH19600000	Xvs Drag Star	250	01-04	24 603 0222	5BN819600000
Yn Neo's	100	99-02	24 603 0072	5RNH19600000	Ybr	250	07-11	24 603 0222	5BN819600000
Vp X-City	125	08-11	24 603 0222	5BN819600000	Yp250 Majesty	250	00-01	24 603 0232	4JH819600100
Xt125r	125	05	24 603 0070	5RNH19600000	Yp250r Black X-Max	250	09	24 603 0222	5BN819600000
Xt125r	125	05	24 603 0072	5RNH19600000	Yp250r X-Max	250	07-09	24 603 0222	5BN819600000
Xt125r	125	06	24 603 0070	5RNH19600000	Yp250r X-Max	250	10-12	24 603 0090	4HMH19600000
Xt125r	125	06	24 603 0072	5RNH19600000	Yp250r X-Max	250	10-12	24 603 0092	4HMH19600000
Xt125r	125	07	24 603 0070	5RNH19600000	Yp250r X-Max	250	12-13	24 603 0090	4HMH19600000
Xt125r	125	07	24 603 0072	5RNH19600000	Yp250r X-Max	250	12-13	24 603 0092	4HMH19600000
Xt125x	125	05	24 603 0070	5RNH19600000	Yp250r X-Max	250	14-16	24 603 0222	5BN819600000
Xt125x	125	05	24 603 0072	5RNH19600000	Yp250r X-Max Sport	250	11-12	24 603 0090	4HMH19600000
Xt125x	125	06	24 603 0070	5RNH19600000	Yp250r X-Max Sport	250	11-12	24 603 0092	4HMH19600000
Xt125x	125	06	24 603 0072	5RNH19600000	Yp250ra X-Max Abs	250	11-12	24 603 0090	4HMH19600000
Xt125x	125	07	24 603 0070	5RNH19600000	Yp250ra X-Max Abs	250	11-12	24 603 0092	4HMH19600000
Xt125x	125	07	24 603 0072	5RNH19600000	Yp250ra X-Max Abs	250	12-13	24 603 0090	4HMH19600000
Xvs Drag Star	125	00-04	24 603 0222	5BN819600000	Yp250ra X-Max Abs	250	12-13	24 603 0092	4HMH19600000
Yp125 Majesty	125	98-00	24 603 0011	5NRW19600000	Yp250ra X-Max Abs	250	14-15	24 603 0222	5BN819600000
Yp125 Majesty	125	98-00	24 603 0072	5NRW19600000	Yp250ra X-Max Abs	250	16	24 603 0222	5BN819600000
Yp125 Majesty	125	01-02	24 603 0011	5NRW19600000	Xp T-Max	500	01-03	24 603 0232	4JH819600100
Yp125 Majesty	125	01-02	24 603 0072	5NRW19600000	Fzr R	600	94	24 603 0232	4JH819600100
Yp125 Majesty	125	01-02	24 603 0090	4HMH19600000	Fzr R	600	95	24 603 0232	4JH819600100
Yp125 Majesty	125	01-02	24 603 0092	4HMH19600000	Yzf R Thunder Cat	600	96-99	24 603 0232	4JH819600100
Yp125e Majesty	125	03-05	24 603 0090	4HMH19600000	Yzf R Thunder Cat	600	00-02	24 603 0232	4JH819600100
Yp125e Majesty	125	03-05	24 603 0092	4HMH19600000	Yzf-R6	600	99-00	24 603 0232	4JH819600100
Yp125e Majesty	125	06	24 603 0090	4HMH19600000	Yzf-R6	600	01-02	24 603 0232	4JH819600100
Yp125e Majesty	125	06	24 603 0092	4HMH19600000	Xvs A Drag Star Classic	650	98-01	24 603 0222	5BN819600000
Yp125e Majesty	125	07	24 603 0090	4HMH19600000	Xvs Drag Star	650	97-99	24 603 0222	5BN819600000
Yp125e Majesty	125	07	24 603 0092	4HMH19600000	Xvs Drag Star	650	97-99	24 603 0232	4JH819600100
Yp125e Majesty	125	08	24 603 0090	4HMH19600000	Xvs Drag Star	650	00-02	24 603 0222	5BN819600000
Yp125e Majesty	125	08	24 603 0092	4HMH19600000	Szr	660	95-97	24 603 0232	4JH819600100
Yp125e Majesty	125	09	24 603 0090	4HMH19600000	Xt660z Tenere	660	94-96	24 603 0232	4JH819600100
Yp125e Majesty	125	09	24 603 0092	4HMH19600000	Tdm	850	96-98	24 603 0232	4JH819600100
Yp125r X-Max	125	06-07	24 603 0222	5BN819600000	Tdm	850	99	24 603 0232	4JH819600100
Yp125r X-Max	125	08-09	24 603 0222	5BN819600000	Tdm	850	00-01	24 603 0232	4JH819600100
Yp125r X-Max	125	10-12	24 603 0090	4HMH19600000	Yzf-R1	1000	98-99	24 603 0232	4JH819600100
Yp125r X-Max	125	10-12	24 603 0092	4HMH19600000	Yzf-R1	1000	00-01	24 603 0232	4JH819600100
Yp125r X-Max	125	10-12	24 603 0232	4JH819600100	Bt Bulldog	1100	02-04	24 603 0222	5BN819600000
Yp125r X-Max	125	12-13	24 603 0090	4HMH19600000	Bt Bulldog	1100	05-06	24 603 0222	5BN819600000
Yp125r X-Max	125	12-13	24 603 0092	4HMH19600000	Xvs A Drag Star Classic	1100	00-03	24 603 0222	5BN819600000
Yp125r X-Max	125	14	24 603 0222	5BN819600000	Xvs Drag Star	1100	99-00	24 603 0222	5BN819600000
Yp125r X-Max	125	15-16	24 603 0222	5BN819600000	Xvs Drag Star	1100	01-02	24 603 0222	5BN819600000
Yp125r X-Max Abs	125	11	24 603 0090	4HMH19600000	Xv A Wild Star	1600	99-02	24 603 0222	5BN819600000
Yp125r X-Max Abs	125	11	24 603 0092	4HMH19600000					
Yp125ra X-Max Abs	125	13	24 603 0090	4HMH19600000					
Yp125ra X-Max Abs	125	13	24 603 0092	4HMH19600000					
Yp125ra X-Max Abs	125	14-15	24 603 0222	5BN819600000					
Yp125ra X-Max Abs	125	16	24 603 0222	5BN819600000					
Yp125ra X-Max Abs	125	17	24 603 0222	5BN819600000					
Yzf-R125	125	08-11	24 603 0090	4HMH19600000					
Yzf-R125	125	08-11	24 603 0092	4HMH19600000					
Yzf-R125	125	08-11	24 603 0232	4JH819600100					
Yzf-R125	125	12	24 603 0090	4HMH19600000					
Yzf-R125	125	12	24 603 0092	4HMH19600000					
Yzf-R125	125	13	24 603 0090	4HMH19600000					
Yzf-R125	125	13	24 603 0092	4HMH19600000					



MOTORINI AVVIAMENTO

STARTER MOTORS

24 639 0010



APRILIA - DERBI - GILERA - PIAGGIO
(R.O. 82530R)
KYMCO: (R.O. 00104002)



24 639 0020



APRILIA - (R.O. AP8206459)
BENELLI - (R.O. R19240011A0)
MALAGUTI - (R.O. 02404400)
MBK - YAMAHA - (R.O. 4CUH18001000)



24 639 0040



PEUGEOT - (R.O. 735112)



24 639 0071



PIAGGIO - (R.O. 1791165)



24 639 0080



APRILIA - DERBI - GILERA - PIAGGIO
(R.O. 96921R)



24 639 0090



APRILIA - GILERA - PIAGGIO (R.O. 82611R)



24 639 0100



APRILIA - (R.O. AP8550442)
PIAGGIO - (R.O. 2947365)



24 639 0110



APRILIA - DERBI - (R.O. AP8551026 - AP8550078)
GILERA - PIAGGIO - (R.O. 289094)



24 639 0120



KYMCO - (R.O. 00104202)
SYM - (R.O. 31200GAK900)



24 639 0130



KYMCO - (R.O. 00107242)



24 639 0140



KYMCO - (R.O. 00128741 31200-KUDU-9000)



24 639 0150



BENELLI - (R.O. R1901011170)
ITALJET - (R.O. 4874800179)
MALAGUTI - (R.O. 74800300)
MBK - YAMAHA - (R.O. 5DSH18000000)





24 639 0160 

APRILIA - (R.O. AP2QCA000041)
BENELLI - (R.O. R013434100000)
DERBI - (R.O. 00G03901891)-(R.O. 00G03904891)
ITALJET - (R.O. 337200050)
MALAGUTI - (R.O. 62211800)
SUZUKI - (R.O. 31100-36C02-000)



24 639 0170 

APRILIA - (R.O. AP8510653)



24 639 0180 

SYM - (R.O. 31200M92100)



24 639 0190 

APRILIA - (R.O. AP8122628)
BENELLI - (R.O. R13040191A0)
ITALJET
MALAGUTI - (R.O. 74800500)
MBK - (R.O. 4HC81890000)
YAMAHA-(R.O. 1SDH18000000 • 1COH18000000)



24 639 0200 

HONDA - (R.O. 31200-KAB-018)



24 639 0210 

APRILIA - (R.O. AP0295625)



24 639 0220 

APRILIA - DERBI - GILERA - PIAGGIO (R.O. 58142R)



24 639 0230 

APRILIA - PIAGGIO - (R.O. 82699R)



24 639 0240 

HONDA
PIAGGIO - (R.O. 495180)



24 639 0250 

KYMCO - (R.O. 00128751 31210-KKC3-90C)



24 639 0252 

KYMCO - (R.O. 00128751 • 31210-KKC3-90C)
Di primo equipaggiamento - *Oem quality*



24 639 0261 

PIAGGIO - (R.O. 249235)





MOTORINI AVVIAMENTO

STARTER MOTORS

24 639 0272



KYMCO - (R.O. 00128750)
Di primo equipaggiamento - *Oem quality*



24 639 0280



SUZUKI - (R.O. 31100-14F01-000)



24 639 0292



KYMCO - (R.O. 00131063 31210-LEB1-90A)
Di primo equipaggiamento - *Oem quality*



24 639 0300



HONDA - (R.O. 31200-KGF-901)



24 639 0322



KYMCO - (R.O. 00131056)



24 639 0340



YAMAHA - (R.O. 1B9H180001)



24 639 0350



SYM - (R.O. 31200H9A000)



24 639 0360



SYM - (R.O. 31200HLA000)



24 639 0382



KYMCO - (R.O. 00131156)



24 639 0370



PEUGEOT - (R.O. 723726)



24 639 0390



YAMAHA - (R.O. 52SH18000000)



24 639 0400



PIAGGIO - (R.O. 58294R)



24 639 0430



NEW

HONDA - (R.O. 31200-KTW-901)





24 635 0030



ANELLO PORTASPAZZOLE
BRUSH HOLDER

Vespa Pk 50 • Ape 50
(R.O. 179755-291383)



24 635 0130



ANELLO PORTA SPAZZOLE - BRUSH

125-150: Sh • @ • Dylan • Phanteon 4T • Psi



24 635 0270



ANELLO PORTASPAZZOLE - BRUSH HOLDER

500: T-Max 01-07
(R.O. 3HE818400000)



24 635 0341



NEW

ANELLO PORTASPAZZOLE
BRUSH HOLDER

YAMAHA 250: Majesty 96-03 • X-Max 05-09 •
X/City 07-12
300: Xc Versity 03-06
400: Majesty 04-11
(R.O. 3KS818400000)



24 639 0410



SPAZZOLE - BRUSH

150: Sh i 07>



24 639 0420



SPAZZOLE - BRUSH

300: Sh i 08>



24 639 0440



NEW

SPAZZOLE - BRUSH

PIAGGIO 220: Ape Car P2-P3 78-85 • Ape Mp
P501-P601 78-96 • Ape Tm P602 82-83 • Ape
Tm P703 FL2 99-07 • Ape Tm P703-P703V - FL2
84-05
(R.O. 159922)



12 187 0500



KIT MINUTERIA REVISIONE

PIGNONE AVVIAMENTO
STARTER PINION SERVICING KIT

Vespa 50 Pk • FL • FL2 Automatica • FL2 Hp • N
Pk Automatica • Pk XL Plurimatic • Rush • Pk XL
Vespa 125 FL • Pk XL - (R.O. 249482)

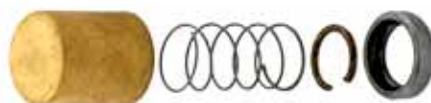



MOTORINI AVVIAMENTO

STARTER MOTORS

Modello - Model	Cc	Anno Year	Codice RMS RMS Code	Riferimento Originale Oem Number	Modello - Model	Cc	Anno Year	Codice RMS RMS Code	Riferimento Originale Oem Number
APRILIA									
Amico	50	94	24 639 0020	AP8206459	Sport City Cube	125	08-10	24 639 0090	82611R
Amico GL-GLE	50	93-95	24 639 0020	AP8206459	Sport City Euro3	125	06-08	24 639 0220	AP8577046
Amico Lx- Sport-Cat	50	92-93	24 639 0020	AP8224103	Sport City One 4T Eu3	125	08-11	24 639 0090	82611R
Area 51	50	98-00	24 639 0020	AP8206459	Sport City Street	125	12	24 639 0090	82611R
Gulliver	50	95-98	24 639 0020	AP8206459	Sr Max	125	11-14	24 639 0220	58142R
Gulliver Lc	50	96-98	24 639 0020	AP8206459	Sr Motard	125	12-14	24 639 0090	82611R
Mojito Custom	50	99-03	24 639 0160	AP2QCA000041	Atlantic Eu3 125-250	250	06-08	24 639 0220	AP8577046
Mojito Custom 2T Mot. Piaggio	50	04-10	24 639 0010	82530R	Leonardo	250	02-04	24 639 0190	AP8552123
Mojito Retro	50	99-03	24 639 0160	AP2QCA000041	Leonardo	250	99-01	24 639 0190	AP8122628
Rally	50	95-03	24 639 0020	AP8206459	Leonardo St	250	01	24 639 0190	AP8122628
Rally Liquid Cooled	50	96-99	24 639 0020	AP8206459	Scarabeo Light	250	06-08	24 639 0220	AP8577046
Rs	50	06-10	24 639 0080	96921R	Sport City Cube	250	08-12	24 639 0220	58142R
Scarabeo	50	98	24 639 0020	AP8224103	Atlantic	300	10-11	24 639 0220	58142R
Scarabeo	50	99	24 639 0020	AP8224103	Scarabeo Light	300	09-10	24 639 0220	58142R
Scarabeo	50	00-05	24 639 0020	AP8224103	Sport City Street	300	12	24 639 0220	58142R
Scarabeo	50	93-97	24 639 0020	AP8206459	Sr Max	300	11-14	24 639 0220	58142R
Scarabeo 2T	50	14	24 639 0010	82530R	Atlantic Sprint 400-500	400	05-08	24 639 0230	AP8560025
Scarabeo 2T Eu2 Mot. Piaggio	50	10-12	24 639 0010	82530R	Scarabeo Light 400-500	400	06-08	24 639 0230	82699R
Scarabeo 2T Net	50	09	24 639 0010	82530R	Atlantic	500	01-04	24 639 0230	AP8560025
Scarabeo 2T Net	50	10	24 639 0010	82530R	Atlantic Sprint 400-500	500	05-08	24 639 0230	AP8560025
Scarabeo 4T	50	02-06	24 639 0080	AP8570105	Scarabeo	500	03-06	24 639 0230	AP8560025
Scarabeo 4T 4V	50	14	24 639 0080	96921R	Scarabeo Light 400-500	500	06-08	24 639 0230	82699R
Scarabeo 4T 4V	50	10-12	24 639 0080	96921R	ATU				
Scarabeo 4T 4V Net	50	09	24 639 0080	96921R	Cx 50 2T Curio	50	95-97	24 639 0040	-
Scarabeo 4T 4V Net	50	10	24 639 0080	96921R	Meteorit Kb 50 2T Edition	50	98	24 639 0040	-
Scarabeo 4T Restyling Eu3	50	06-09	24 639 0080	96921R	BENELLI				
Scarabeo Ditech	50	01-04	24 639 0160	AP2QCA000041	491 Gt	50	98-99	24 639 0020	R19240011A0
Scarabeo Quattro	50	09	24 639 0080	96921R	491 Racing	50	98-99	24 639 0020	R19240011A0
Scarabeo Street	50	05-06	24 639 0010	AP8515107	491 Rr	50	99-01	24 639 0020	R19240011A0
Scarabeo Street 2T Restyling	50	06-09	24 639 0010	82530R	491 Rr Morini	50	03-04	24 639 0160	R013434100000
Sonic	50	98-07	24 639 0020	AP8224103	491 Sp	50	99	24 639 0020	R19240011A0
Sonic Gp	50	98-08	24 639 0020	AP8224103	491 Sport	50	98-99	24 639 0020	R19240011A0
Sport City One 2T	50	08-11	24 639 0010	82530R	491 St	50	99-01	24 639 0020	R19240011A0
Sport City One 4T	50	08-10	24 639 0080	96921R	491 St Morini	50	03	24 639 0160	R013434100000
Sr	50	93	24 639 0020	AP8206102	K2	50	98-01	24 639 0020	R19240011A0
Sr	50	94-96	24 639 0020	AP8206459	K2 Liquid Cooled	50	98-01	24 639 0020	R19240011A0
Sr Ditech Eu2	50	02-04	24 639 0160	AP2QCA000041	Naked	50	02	24 639 0020	R19240011A0
Sr H2o Ditech e Carburatore	50	00-04	24 639 0160	AP2QCA000041	Naked Morini	50	03-04	24 639 0160	R013434100000
Sr Iniezione e Carburatore	50	14	24 639 0010	82530R	Pepe	50	99-01	24 639 0020	R19240011A0
Sr Iniezione e Carburatore	50	14	24 639 0080	96921R	Pepe Lx	50	03-04	24 639 0020	R19240011A0
Sr Liquid Cooled	50	94-96	24 639 0020	AP8224103	Velvet 125-150	125	99-01	24 639 0150	R19010111A0
Sr Motard 2T	50	12-14	24 639 0010	82530R	Velvet Touring 125-150	125	02-03	24 639 0150	R19010111A0
Sr Motard 4T 4V	50	13-14	24 639 0080	96921R	Velvet 125-150	150	99-01	24 639 0150	R19010111A0
Sr R Factory le e Carburatore	50	10-14	24 639 0010	82530R	Velvet Touring 125-150	150	02-03	24 639 0150	R19010111A0
Sr R Factory le e Carburatore	50	10-14	24 639 0080	96921R	Velvet	250	99-01	24 639 0190	R13040191A0
Sr R Factory Motore Aprilia	50	05	24 639 0160	AP2QCA000041	Velvet Touring	250	02-03	24 639 0190	R13040191A0
Sr R, R Factory	50	04-09	24 639 0010	82530R	DERBI				
Sr R, R Factory	50	04-09	24 639 0080	96921R	Atlantis	50	01	24 639 0160	00G03901891
Sr Stealth Racing	50	97-00	24 639 0020	AP8206459	Atlantis	50	01	24 639 0160	00G03904891
Sr Street	50	03-12	24 639 0010	AP8515107	Atlantis	50	99-00	24 639 0160	00G03901891
Sr Street	50	03-12	24 639 0080	AP8570105	Atlantis 2T	50	10	24 639 0010	82530R
Sr Www	50	97-01	24 639 0020	AP8206459	Atlantis 2T Eu2	50	07-09	24 639 0010	82530R
Scarabeo 4T	100	14	24 639 0110	96928R	Atlantis 4T Eu2	50	07	24 639 0080	96921R
Scarabeo 4T	100	01-05	24 639 0110	AP8551026	Atlantis 50-100 4T	50	04-06	24 639 0080	96921R
Scarabeo 4T	100	10-12	24 639 0110	96928R	Atlantis 50-100 4T	50	04-06	24 639 0110	96928R
Scarabeo 4T Net	100	09	24 639 0110	96928R	Atlantis Lc	50	99-01	24 639 0160	00G03901891
Scarabeo 4T Net Eu3	100	10	24 639 0110	96928R	Atlantis Lc	50	99-01	24 639 0160	00G03904891
Scarabeo 4T Restyling	100	06-09	24 639 0110	96928R	Atlantis O2	50	02	24 639 0010	82530R
Scarabeo Motore Yamaha	100	00	24 639 0170	AP8510653	Atlantis O2 Bullet	50	03-05	24 639 0010	82530R
Atlantic	125	03-05	24 639 0220	AP8577046	Atlantis O2 City	50	03-06	24 639 0010	82530R
Atlantic Eu3	125	10-12	24 639 0090	82611R	Atlantis O2 Red Bullet	50	03	24 639 0010	82530R
Atlantic Eu3 125-250	125	06-08	24 639 0220	AP8577046	Atlantis O2 Two Chic	50	05	24 639 0010	82530R
Leonardo	125	99-02	24 639 0210	AP0295625	Boulevard 2T	50	09-14	24 639 0010	82530R
Leonardo St	125	01-04	24 639 0210	AP0295625	Boulevard 4T Eu2 25 Km/H	50	09	24 639 0080	96921R
Mojito	125	08	24 639 0090	82611R	Gp1	50	03	24 639 0010	82530R
Mojito Retro' - Custom	125	99-01	24 639 0100	AP8550442	Gp1	50	01-02	24 639 0010	82530R
Scarabeo	125	04-06	24 639 0220	AP8577046	Gp1 E2	50	03	24 639 0010	82530R
Scarabeo Motore Rotax	125	99-04	24 639 0210	AP0296390	Gp1 Euro2	50	05	24 639 0010	82530R
					Gp1 Open Eu2	50	06-09	24 639 0010	82530R

MOTORINI AVVIAMENTO

STARTER MOTORS



Modello - Model	Cc	Anno Year	Codice RMS RMS Code	Riferimento Originale Oem Number	Modello - Model	Cc	Anno Year	Codice RMS RMS Code	Riferimento Originale Oem Number
Gp1 Race Eu2	50	05-07	24 639 0010	82530R	Runner Vx-Vxr 125-180	125	00-01	24 639 0090	82611R
Gpr Nude & Gpr Nude Tuning	50	06-08	24 639 0080	96921R	Runner Vx-Vxr 125-200	125	02-04	24 639 0090	82611R
Gpr Nude Sport	50	06	24 639 0080	96921R	Typhoon	125	95-98	24 639 0110	289094
Gpr Racing Eu2	50	06	24 639 0080	96921R	Typhoon X-Xr	125	99-00	24 639 0110	289094
Gpr Replica & Gpr R Eu2	50	06	24 639 0080	96921R	Dna 125-180	180	01	24 639 0090	82611R
Gpr Replica 2T Malossi	50	07	24 639 0080	96921R	Runner Fx-Fxr 125-180	180	97-02	24 639 0110	289094
Gpr Replica Pesek Eu2	50	07	24 639 0080	96921R	Runner Vx-Vxr 125-180	180	00-01	24 639 0090	82611R
Hunter	50	96-97	24 639 0160	00G03901891	Runner Vxr	200	05-06	24 639 0090	82611R
Paddock	50	98-99	24 639 0160	00G03901891	Runner Vxr 4T St Eu3	200	08-11	24 639 0090	82611R
Predator Lc	50	98-01	24 639 0160	00G03901891	Runner Vxr Eu3	200	07	24 639 0090	82611R
Predator Lc	50	98-01	24 639 0160	00G03904891	Runner Vxr Race	200	05-06	24 639 0090	82611R
Predator O2	50	98-01	24 639 0160	00G03901891	Runner Vx-Vxr 125-200	200	02-04	24 639 0090	82611R
Predator O2	50	98-01	24 639 0160	00G03904891	Nexus Eu3	250	06	24 639 0220	58142R
Senda Sm Drd Pro Eu2	50	05-11	24 639 0080	96921R	Nexus Eu3	250	07	24 639 0220	58142R
Senda Sm Drd Pro Eu2 2Ver	50	05-08	24 639 0080	96921R	Nexus Sp Eu3	250	06-07	24 639 0220	58142R
Sonar 2T	50	09	24 639 0010	82530R	Oregon	250	06-10	24 639 0220	58142R
Variant Sport 2T	50	12	24 639 0010	82530R	Nexus Eu3	300	08	24 639 0220	58142R
Atlantis	100	00-01	24 639 0080	00G03905891	Nexus Eu3	300	09-11	24 639 0220	58142R
Atlantis 50-100 4T	100	04-06	24 639 0080	96921R	Fuoco 4T-4V Ie E3 Lt	500	13-14	24 639 0230	82699R
Atlantis 50-100 4T	100	04-06	24 639 0110	96928R	Fuoco Eu3	500	07-13	24 639 0230	82699R
Boulevard 4T	100	10-11	24 639 0110	96928R	Nexus	500	03-05	24 639 0230	82699R
Rambla 125-250	125	08-09	24 639 0220	58142R	Nexus Eu3	500	06-08	24 639 0230	82699R
Rambla 125-250 E3 2Ver	125	08	24 639 0220	58142R	Nexus Eu3	500	09-11	24 639 0230	82699R
Gp1	250	06-07	24 639 0220	58064R	Nexus Sp Eu3	500	06-07	24 639 0230	82699R
Gp1 Low Seat 250 Eu3	250	07-08	24 639 0220	58142R	HONDA				
Gp1 Low Seat 250 Eu3	250	07-08	24 639 0220	58142R	Srx 90 lt Shadow	90	98	24 639 0370	-
Rambla 125-250	250	08-09	24 639 0220	58142R	Srx 90 lt Shadow	90	99-00	24 639 0370	-
Rambla 125-250 E3 2Ver	250	08	24 639 0220	58142R	Scv 100 Lead	100	03-04	24 639 0370	-
Rambla	300	10-11	24 639 0220	58142R	Scv 100 Lead	100	05-07	24 639 0370	-
GILERA					Sh 100 Scoopy	100	96-97	24 639 0370	-
Dna	50	05-07	24 639 0010	82530R	Sj 100 Bali Ex	100	96	24 639 0370	-
Dna	50	00-02	24 639 0010	82530R	Sj 100 Bali Ex	100	97	24 639 0370	-
Dna Gp Experience	50	03-04	24 639 0010	82530R	Sj 100 Bali Ex	100	98	24 639 0370	-
Easy Moving	50	95-96	24 639 0010	82530R	Sj 100 Bali Ex	100	99-00	24 639 0370	-
Ice	50	01-05	24 639 0010	82530R	Fes 125 Pantheon	125	04	24 639 0300	31200KGF901
Runner	50	97-00	24 639 0010	82530R	Fes 125 Pantheon	125	05-06	24 639 0300	31200KGF901
Runner Poggiali	50	02	24 639 0010	82530R	Nes 125 @/ Arobase	125	00	24 639 0300	31200KGF901
Runner Purejet	50	07	24 639 0080	96921R	Nes 125 @/ Arobase	125	01	24 639 0300	31200KGF901
Runner Purejet	50	02-04	24 639 0080	96921R	Nes 125 @/ Arobase	125	02	24 639 0300	31200KGF901
Runner Purejet	50	05-06	24 639 0080	96921R	Pes 125 Ps I	125	06	24 639 0300	31200KGF901
Runner Purejet	50	10-11	24 639 0080	96921R	Pes 125 Ps I	125	07	24 639 0300	31200KGF901
Runner Purejet St	50	08	24 639 0080	96921R	Pes 125 Ps I	125	08	24 639 0300	31200KGF901
Runner Sp	50	07	24 639 0010	82530R	Pes 125 Ps I	125	09	24 639 0300	31200KGF901
Runner Sp	50	02-04	24 639 0010	82530R	Pes 125 Ps I	125	10-13	24 639 0300	31200KGF901
Runner Sp	50	05-06	24 639 0010	82530R	Ses 125 Dylan	125	02	24 639 0300	31200KGF901
Runner Sp	50	10-12	24 639 0010	82530R	Ses 125 Dylan	125	03	24 639 0300	31200KGF901
Runner Sp Special Edition	50	07	24 639 0010	82530R	Ses 125 Dylan	125	04-06	24 639 0300	31200KGF901
Runner Sp St & Simoncelli	50	08-09	24 639 0010	82530R	Sh 125	125	03	24 639 0300	31200KGF901
Stalker	50	05-06	24 639 0010	82530R	Sh 125	125	04	24 639 0300	31200KGF901
Stalker	50	07-08	24 639 0010	82530R	Sh 125	125	01-02	24 639 0300	31200KGF901
Stalker	50	09-11	24 639 0010	82530R	Sh 125 I	125	05	24 639 0300	31200KGF901
Stalker	50	97-04	24 639 0010	82530R	Sh 125 I	125	06	24 639 0300	31200KGF901
Stalker Naked	50	08	24 639 0010	82530R	Sh 125 I	125	07	24 639 0300	31200KGF901
Stalker Special Edition	50	07-08	24 639 0010	82530R	Sh 125 I	125	08	24 639 0300	31200KGF901
Storm	50	94-95	24 639 0010	82530R	Nes 150 @/ Arobase	150	00	24 639 0300	31200KGF901
Storm Eu2	50	07	24 639 0010	82530R	Nes 150 @/ Arobase	150	01	24 639 0300	31200KGF901
Typhoon	50	94-97	24 639 0010	82530R	Nes 150 @/ Arobase	150	02	24 639 0300	31200KGF901
Typhoon X	50	98-99	24 639 0010	82530R	Nes 150 @/ Arobase	150	03	24 639 0300	31200KGF901
Typhoon Xr	50	00	24 639 0010	82530R	Nes 150 @/ Arobase	150	04	24 639 0300	31200KGF901
Dna 125-180	125	01	24 639 0090	82611R	Nes 150 @/ Arobase	150	05	24 639 0300	31200KGF901
Nexus Eu3	125	07-08	24 639 0090	82611R	Nes 150 @/ Arobase	150	06	24 639 0300	31200KGF901
Nexus Eu3 Ie	125	08	24 639 0220	58142R	Pes 150 Ps I	150	06	24 639 0300	31200KGF901
Nexus Eu3 Ie	125	09-10	24 639 0220	58142R	Pes 150 Ps I	150	07	24 639 0300	31200KGF901
Runner 4T St Eu3	125	08-16	24 639 0090	82611R	Pes 150 Ps I	150	08	24 639 0300	31200KGF901
Runner Fx-Fxr 125-180	125	97-02	24 639 0110	289094	Pes 150 Ps I	150	09	24 639 0300	31200KGF901
Runner Vx	125	05-06	24 639 0090	82611R	Pes 150 Ps I	150	10	24 639 0300	31200KGF901
Runner Vx 4T Eu3	125	06-07	24 639 0090	82611R	Sh 150	150	03	24 639 0300	31200KGF901
Runner Vx Race	125	06	24 639 0090	82611R	Sh 150	150	04	24 639 0300	31200KGF901
Runner Vx Sc	125	06-07	24 639 0090	82611R	Sh 150	150	01-02	24 639 0300	31200KGF901



MOTORINI AVVIAMENTO

STARTER MOTORS

Modello - Model	Cc	Anno Year	Codice RMS RMS Code	Riferimento Originale Oem Number	Modello - Model	Cc	Anno Year	Codice RMS RMS Code	Riferimento Originale Oem Number
Sh 150 I	150	05	24 639 0300	31200KGF901	Dink Classic Eu2	50	03	24 639 0120	00104202
Sh 150 I	150	06	24 639 0300	31200KGF901	Dink Lc	50	98-02	24 639 0120	00104202
Sh 150 I	150	07	24 639 0300	31200KGF901	Dj W	50	94-00	24 639 0010	00104002
Sh 150 I	150	08	24 639 0300	31200KGF901	Dj X	50	91-92	24 639 0010	00104002
Cn 250 Helix Spazio	250	94	24 639 0240	-	Dj Y	50	93	24 639 0010	00104002
Cn 250 Helix Spazio	250	95	24 639 0240	-	Fever Zx	50	99-00	24 639 0010	00104002
Cn 250 Helix Spazio	250	96	24 639 0240	-	Fever Zx Eu2	50	03-04	24 639 0010	00104002
Cn 250 Helix Spazio	250	99	24 639 0240	-	Filly	50	98-00	24 639 0130	00107242
Cn 250 Helix Spazio	250	91-93	24 639 0240	-	Heroism	50	95-97	24 639 0120	00104202
Cn 250 Helix Spazio	250	97-98	24 639 0240	-	K 12	50	95-00	24 639 0010	00104002
Fes 250 Foresight	250	00	24 639 0200	31200KAB018	Kb	50	95-00	24 639 0010	00104002
Fes 250 Foresight	250	98	24 639 0200	31200KAB018	Kxr	50	04	24 639 0120	00104202
Fes 250 Foresight	250	99	24 639 0200	31200KAB018	Like 2T	50	09	24 639 0120	00131068
Nss 250 A Jazz Abs	250	03	24 639 0200	31200KAB018	Like 4T	50	09	24 639 0130	00131025
Nss 250 A Jazz Abs	250	04	24 639 0200	31200KAB018	Maxxer	50	05	24 639 0120	00104202
Nss 250 A Jazz Abs	250	01-02	24 639 0200	31200KAB018	Mxer	50	02-03	24 639 0120	00104202
Nss 250 Jazz	250	01	24 639 0200	31200KAB018	Mxer Eu2	50	04	24 639 0120	00104202
Nss 300 A Forza Abs	300	13-17	24 639 0430	31200KTW901	Mxu	50	06-07	24 639 0120	00104202
Nss 300 Forza	300	13-17	24 639 0430	31200KTW901	Mxu Sr	50	06	24 639 0120	00104202
Sh 300 A I Abs	300	11	24 639 0430	31200KTW901	People	50	04	24 639 0120	00104202
Sh 300 A I Abs	300	12	24 639 0430	31200KTW901	People	50	99-00	24 639 0120	00104202
Sh 300 A I Abs	300	13	24 639 0430	31200KTW901	People Eu2	50	03	24 639 0120	00104202
Sh 300 A I Abs	300	16	24 639 0430	31200KTW901	People Eu2	50	08	24 639 0120	00104202
Sh 300 A I Abs	300	17	24 639 0430	31200KTW901	People Eu2	50	11	24 639 0120	00104202
Sh 300 A I Abs	300	14-15	24 639 0430	31200KTW901	People S	50	05-08	24 639 0120	00104202
ITALJET					People S 4T	50	06-08	24 639 0130	00107242
Formula 50 Ac Dd	50	95-97	24 639 0160	337200050	Sento	50	08	24 639 0130	00107242
Formula 50 Ac Dd Race	50	96	24 639 0160	337200050	Sniper	50	93	24 639 0120	00104202
Formula 50 Ac Dd Sport	50	98	24 639 0160	337200050	Sniper Dd	50	94-96	24 639 0120	00104202
Formula 50 Ac Dt	50	00-01	24 639 0160	337200050	Super 8	50	07	24 639 0130	00131025
Formula 50 Ac Dt	50	97-98	24 639 0160	337200050	Super 8 2T	50	09	24 639 0120	00131068
Formula 50 Ac Dt	50	99	24 639 0160	337200050	Super 8 2T	50	13	24 639 0120	00104202
Formula 50 Lc Dd	50	00	24 639 0160	337200050	Super 8 4T	50	09	24 639 0130	00131025
Formula 50 Lc Dd	50	97-98	24 639 0160	337200050	Super 8 4T	50	13	24 639 0130	00131025
Formula 50 Lc Dd	50	99	24 639 0160	337200050	Super 9	50	00	24 639 0120	00104202
Torpedo 50 2T	50	98	24 639 0160	337200050	Super 9 Sport Eu2	50	03	24 639 0120	00104202
Torpedo 50 2T	50	99	24 639 0160	337200050	Super 9 Sport Eu2	50	04	24 639 0120	00104202
Formula 125	125	00	24 639 0160	337200050	Top Boy	50	97-00	24 639 0120	00104202
Formula 125	125	01	24 639 0160	337200050	Vitality 2T	50	04	24 639 0120	00104202
Formula 125	125	97	24 639 0160	337200050	Vitality 4T	50	04	24 639 0130	00104025
Formula 125	125	98	24 639 0160	337200050	Yup	50	02	24 639 0120	00104202
Formula 125	125	99	24 639 0160	337200050	Yup Eu2	50	03	24 639 0120	00104202
Jupiter 125	125	02	24 639 0150	4874800179	Downtown 125I	125	09-16	24 639 0292	00131063
Jupiter 125	125	03	24 639 0150	4874800179	Downtown 125I	125	09-16	24 639 0292	00131065
Millennium 125	125	00-01	24 639 0150	4874800179	Downtown E4	125	16	24 639 0292	00131063
Millennium 125	125	02	24 639 0150	4874800179	G-Dink	125	12	24 639 0250	00128751
Millennium 125	125	03	24 639 0150	4874800179	G-Dink	125	12	24 639 0252	00128751
Jupiter 250	250	01-03	24 639 0190	-	K-Xct I	125	12-14	24 639 0292	00131063
KYMCO					K-Xct I	125	12-14	24 639 0292	00131065
Agility 2T R16	50	10	24 639 0120	00104202	Movie XL 125-150	125	01	24 639 0140	00128741
Agility 2T R16	50	12	24 639 0120	00104202	Movie XL 125-150	125	01	24 639 0142	00128741
Agility 4T Carry	50	11	24 639 0130	00107242	People Gti	125	10	24 639 0292	00131063
Agility 4T R10	50	06	24 639 0130	00107242	People Gti	125	10	24 639 0292	00131065
Agility 4T R10	50	07-08	24 639 0130	00107242	People Gti	125	14	24 639 0292	00131063
Agility 4T R12	50	07-08	24 639 0130	00107242	X-Town Cbs	125	16	24 639 0292	00131063
Agility 4T R16	50	08	24 639 0130	00131025	Movie XL 125-150	150	01	24 639 0140	00128741
Agility 4T R16	50	09	24 639 0130	00131025	Movie XL 125-150	150	01	24 639 0142	00128741
Agility 4T R16	50	12	24 639 0130	00131025	Agility 200I R16	200	10	24 639 0140	00126011
Agility Plus 2T	50	14	24 639 0120	00104202	Agility 200I R16	200	10	24 639 0142	00126011
Agility Plus 4T	50	14	24 639 0130	00107242	Downtown I	200	10	24 639 0322	00131056
Agility R12	50	05	24 639 0130	00107242	People Gti	200	10	24 639 0322	00131056
Agility R12 Ecs	50	16	24 639 0130	00107242	People Gti	200	14	24 639 0322	00131056
Agility Rs	50	09	24 639 0130	00131025	B&W	250	00	24 639 0272	00128750
Agility Rs Naked 2T	50	10	24 639 0120	00104202	B&W Eu2	250	03	24 639 0272	00128750
B&W	50	02	24 639 0120	00104202	Grand Dink	250	01-02	24 639 0272	00128750
B&W Eu2	50	03	24 639 0120	00104202	Grand Dink Eu2	250	03-04	24 639 0272	00128750
Cx	50	93	24 639 0010	00104002	People Lc	250	03-04	24 639 0272	00128750
Cx Super	50	94-97	24 639 0010	00104002	People S	250	06	24 639 0272	00128750
Dink 50 4T	50	07	24 639 0130	00107242	People S 250I	250	07	24 639 0272	00128750

MOTORINI AVVIAMENTO

STARTER MOTORS



Modello - Model	Cc	Anno Year	Codice RMS RMS Code	Riferimento Originale Oem Number	Modello - Model	Cc	Anno Year	Codice RMS RMS Code	Riferimento Originale Oem Number
X Citing	250	05	24 639 0272	00128750	Madison R Restyling	125	02	24 639 0150	74800300
X Citing I	250	06-07	24 639 0272	00128750	Madison R Restyling Eu2	125	03-04	24 639 0150	74800400
Yup	250	03	24 639 0272	00128750	Phantom Max	125	03	24 639 0150	74800400
Downtown 300I	300	09	24 639 0322	00131056	Madison T	150	99-01	24 639 0150	74800300
Downtown Abs	300	10	24 639 0322	00131056	Password	250	05-06	24 639 0190	74800500
Downtown Abs I	300	11-16	24 639 0322	00131056	Password Eu3	250	07-08	24 639 0190	74800500
Downtown I	300	11	24 639 0322	00131056	MBK				
G-Dink	300	12	24 639 0272	00128750	Yh Flipper	50	01-02	24 639 0020	4CUH18000000
K-Xct I	300	12	24 639 0322	00131056	Yh Flipper Catalitico	50	99-00	24 639 0020	4CUH18001000
K-Xct I Abs	300	14	24 639 0322	00131056	Xq Thunder	125	01-02	24 639 0150	5DSH18000000
People Gti	300	10	24 639 0322	00131056	Yp E Skyliner	125	03	24 639 0150	5NRH18000000
People Gti	300	11	24 639 0322	00131056	Yp Skyliner	125	01-02	24 639 0150	5DSH18000000
People Gti	300	14	24 639 0322	00131056	Xn Doodo	150	01-02	24 639 0150	5DSH18000000
People Gti Abs	300	12	24 639 0322	00131056	Xq Thunder	150	01-02	24 639 0150	5DSH18000000
People Gti Abs	300	14	24 639 0322	00131056	Yp Skyliner	150	01-02	24 639 0150	5DSH18000000
People Gti Abs E4	300	16	24 639 0322	00131056	Yp E Skyliner	180	03	24 639 0150	5DSH18000000
People S 300I	300	08	24 639 0272	00128750	Yp Skyliner	250	02-03	24 639 0190	4HC818900000
X Citing 300I	300	08	24 639 0272	00128750	Yp Skyliner	250	00-01	24 639 0190	4HC818900000
X Citing 300I R	300	08	24 639 0272	00128750	Yp Skyliner Abs	250	03	24 639 0190	4HC818900000
X Citing 300I R	300	09	24 639 0272	00128750	Xc Kilibre	300	03	24 639 0190	4HC818900000
Downtown Abs E4	350	16	24 639 0322	00131056	PEUGEOT				
Downtown I Abs	350	15	24 639 0322	00131056	Elyseo 50 45 Km/H	50	02-03	24 639 0040	735112
X Citing I	400	13	24 639 0382	00131156	Elyseo 50 50 Km/H	50	01	24 639 0040	735112
X Citing I	400	15	24 639 0382	00131156	Elyseo 50 50 Km/H	50	98-00	24 639 0040	735112
X Citing I Abs	400	14	24 639 0382	00131156	Elystar 50 Advantage	50	06-07	24 639 0040	735112
X Citing I Abs	400	15	24 639 0382	00131156	Elystar 50 Advantage	50	08-09	24 639 0040	735112
X Citing I Abs E4	400	16	24 639 0382	00131156	Jet Force 50 C-Tech	50	07	24 639 0040	735112
MALAGUTI					Jet Force 50 C-Tech	50	05-06	24 639 0040	735112
Centro Base	50	93-94	24 639 0020	02404400	Jet Force 50 C-Tech	50	08-09	24 639 0040	735112
Centro SL	50	94-98	24 639 0020	02404400	Jet Force C-Tech Rally Victories	50	06-07	24 639 0040	735112
Centro SL Kat	50	99-00	24 639 0020	02404400	Jet Force 50 C-Tech Rcup	50	07-09	24 639 0040	735112
Ciak	50	99-00	24 639 0020	74800200	Jet Force 50 Darkside	50	08-12	24 639 0040	735112
Ciak Master	50	04	24 639 0020	02404400	Jet Force 50 Darkside	50	13-15	24 639 0040	735112
Ciak Master Eu2	50	06	24 639 0020	02404400	Jet Force 50 Ice Blade	50	10	24 639 0040	735112
Ciak Mono Eu2	50	03	24 639 0020	02404400	Jet Force 50 Ice Blade	50	11	24 639 0040	735112
Ciak Mono Eu2 2.3	50	03	24 639 0020	02404400	Jet Force 50 Ice Blade	50	12	24 639 0040	735112
Ciak Td	50	00-01	24 639 0020	74800200	Looxor 50	50	02	24 639 0040	735112
Crosser Cr1	50	95-98	24 639 0160	62211800	Looxor 50	50	03	24 639 0040	735112
F10 Jet Line	50	92-98	24 639 0020	02404400	Looxor 50	50	04	24 639 0040	735112
F10 Kat	50	99-00	24 639 0020	02404400	Looxor 50	50	05	24 639 0040	735112
F10 Restyling Eu1	50	01-02	24 639 0020	02404400	Looxor 50	50	06	24 639 0040	735112
F10 Restyling Eu2-2.3	50	03-04	24 639 0020	02404400	Ludix 50 Elegance	50	04	24 639 0040	735112
F10 Restyling Eu2	50	02-03	24 639 0020	02404400	Ludix 50 Elegance	50	05	24 639 0040	735112
F10 Restyling Eu2	50	06	24 639 0020	02404400	Ludix 50 Elegance	50	06	24 639 0040	735112
F12 Aria Restyling Eu2	50	06	24 639 0020	02404400	Ludix 50 Elegance	50	07	24 639 0040	735112
F12 Lc Restyling Eu2	50	06	24 639 0020	02404400	Ludix 50 Ep	50	08	24 639 0040	735112
F12 Phantom	50	94-98	24 639 0020	02404400	Ludix 50 Ep	50	09	24 639 0040	735112
F12 Phantom Eu1	50	99-00	24 639 0020	02404400	Ludix 50 Ep	50	10-11	24 639 0040	735112
F12 Phantom Lc	50	94-98	24 639 0020	02404400	Ludix 50 li Dt One Luxe 2 Sitzer	50	08-11	24 639 0040	735112
F12 Phantom Lc Eu1	50	99-00	24 639 0020	02404400	Ludix 50 li Elegance	50	08-11	24 639 0040	735112
F12 Phantom Lc Restyling Eu1	50	01-02	24 639 0020	02404400	Ludix 50 li Lc Blaster Ice Blade	50	10-11	24 639 0040	735112
F12 Phantom Lc Restyling Eu2	50	02	24 639 0020	02404400	Ludix 50 li Lc Blaster Rcup	50	08-09	24 639 0040	735112
F12 Phantom Lc Rest. Eu2-2.3	50	03-04	24 639 0020	02404400	Ludix 50 li Lc Blaster Rs12	50	08-11	24 639 0040	735112
F12 Phantom Lc Twin Disks	50	98	24 639 0020	02404400	Ludix 50 li One 1 Sitzer	50	08-11	24 639 0040	735112
F12 Phantom Restyling Eu1	50	01-02	24 639 0020	02404400	Ludix 50 li Snake Furious	50	08-11	24 639 0040	735112
F12 Phantom Restyling Eu2	50	02	24 639 0020	02404400	Ludix 50 li Snake Naked 10 Inch	50	08-11	24 639 0040	735112
F12 Phantom Rest. Eu2-2.3	50	03-04	24 639 0020	02404400	Ludix 50 li Trend 12 Inch	50	08-11	24 639 0040	735112
F12r Phantom Lc	50	07-10	24 639 0020	02404400	Ludix 50 li Tt One 2 Sitzer	50	08-12	24 639 0040	735112
F15 Fire Fox	50	96-98	24 639 0020	74800200	Ludix 50 Lc Blaster 10 Zoll	50	05-07	24 639 0040	735112
F15 Fire Fox Air Cooled	50	05-06	24 639 0020	02404400	Ludix 50 Lc Rs Blaster 12 Zoll	50	07	24 639 0040	735112
F15 Fire Fox Eu2	50	02-03	24 639 0020	02404400	Ludix 50 Pro 2T	50	08-11	24 639 0040	735112
F15 Fire Fox Restyling Eu2-2.3	50	03-04	24 639 0020	02404400	Ludix 50 Snake	50	04	24 639 0040	735112
F15 Fire Fox T. Disks & Special	50	98-99	24 639 0020	02404400	Ludix 50 Snake	50	05	24 639 0040	735112
F15 Fire Fox T. Disks Digit Kat	50	98-00	24 639 0020	02404400	Ludix 50 Snake	50	06	24 639 0040	735112
F15 Lc Restyling Eu2	50	04-05	24 639 0020	02404400	Ludix 50 Snake	50	07	24 639 0040	735112
F15 Lc-Tds Restyling Eu1	50	01	24 639 0020	02404400	Ludix 50 Trend 10 Inch	50	04-07	24 639 0040	735112
Grizzly 4 Wheels	50	04-09	24 639 0020	02404400	Speedfight 1 50 Ac Dt	50	97-98	24 639 0040	735112
Yesterday - Yesterday Eu	50	97-00	24 639 0020	02404400	Speedfight 1 50 Ac Dt	50	99-00	24 639 0040	735112
Madison	125	99-01	24 639 0150	74800300	Speedfight 1 50 Lc Dd	50	99	24 639 0040	735112



MOTORINI AVVIAMENTO

STARTER MOTORS

Modello - Model	Cc	Anno Year	Codice RMS RMS Code	Riferimento Originale Oem Number	Modello - Model	Cc	Anno Year	Codice RMS RMS Code	Riferimento Originale Oem Number
Speedfight 1 50 Lc Dd	50	99-00	24 639 0040	735112	Vivacity 50 2 Compact	50	05	24 639 0040	735112
Speedfight 1 50 Lc Dt	50	97-98	24 639 0040	735112	Vivacity 50 2 Compact	50	06	24 639 0040	735112
Speedf. 2 50 Ac Dd Ultim. Edit.	50	08-09	24 639 0040	735112	Vivacity 50 2 Compact	50	07	24 639 0040	735112
Speedfight 2 50 Ac Dt	50	01	24 639 0040	735112	Vivacity 50 2 Motorsport	50	07-09	24 639 0040	735112
Speedfight 2 50 Ac Dt	50	02	24 639 0040	735112	Vivacity 50 2 Rs	50	08	24 639 0040	735112
Speedfight 2 50 Ac Dt	50	03-04	24 639 0040	735112	Vivacity 50 2 Silver Sport	50	05	24 639 0040	735112
Speedfight 2 50 Ac Dt	50	05-06	24 639 0040	735112	Vivacity 50 2 Silver Sport	50	06	24 639 0040	735112
Speedfight 2 50 Ac Dt	50	07-09	24 639 0040	735112	Vivacity 50 2 Silver Sport	50	07	24 639 0040	735112
Speedfight 2 50 Ac Dt Iron-X	50	07	24 639 0040	735112	Vivacity 50 2 Sportline 4	50	06	24 639 0040	735112
Speedf. 2 50 Ac Dt Mot. Sport	50	07	24 639 0040	735112	Vivacity 50 2 Sportline 4	50	07	24 639 0040	735112
Speedf. 2 50 Ac Dt Rally Victories	50	06-07	24 639 0040	735112	Vivacity 50 2 Sportline 4	50	08	24 639 0040	735112
Speedfight 2 50 Ac Dt Rcup	50	07-09	24 639 0040	735112	Vivacity 50 2 Sportline 4	50	09	24 639 0040	735112
Speedfight 2 50 Ac Dt Silver Sport	50	04	24 639 0040	735112	Vivacity 50 3 2T New	50	08-17	24 639 0040	735112
Speedfight 2 50 Ac Dt Silver Sport	50	05-07	24 639 0040	735112	Vivacity 50 Blueline	50	04	24 639 0040	735112
Speedfight 2 50 Ac Dt Wrc 307	50	05	24 639 0040	735112	Vivacity 50 Compact	50	03-04	24 639 0040	735112
Speedfight 2 50 Lc Dd	50	01	24 639 0040	735112	Vivacity 50 Silver Sport	50	04	24 639 0040	735112
Speedfight 2 50 Lc Dd	50	02	24 639 0040	735112	Vivacity 50 Sportline	50	01	24 639 0040	735112
Speedfight 2 50 Lc Dd	50	03	24 639 0040	735112	Vivacity 50 Sportline 2	50	02	24 639 0040	735112
Speedfight 2 50 Lc Dd	50	04	24 639 0040	735112	Vivacity 50 Sportline 3	50	03	24 639 0040	735112
Speedfight 2 50 Lc Dd	50	05-07	24 639 0040	735112	Elyseo 100	100	01	24 639 0370	723726
Speedfight 2 50 Lc Dd	50	08-09	24 639 0040	735112	Elyseo 100	100	98-00	24 639 0370	723726
Speedfight 2 50 Lc Dd Furious	50	03	24 639 0040	735112	Speedfight 1 100	100	98-00	24 639 0370	723726
Speedfight 2 50 Lc Dd Iron-X	50	07	24 639 0040	735112	Speedfight 2 100	100	01-02	24 639 0370	723726
Speedf. 2 50 Lc Dd Mot. Sport	50	07	24 639 0040	735112	Speedfight 2 100	100	03-04	24 639 0370	723726
Speedf. 2 50 Lc Dd Rally Victories	50	06-07	24 639 0040	735112	Speedfight 2 100	100	05-07	24 639 0370	723726
Speedfight 2 50 Lc Dd Rcup	50	07-09	24 639 0040	735112	Speedfight 2 100 Rally Victories	100	06-07	24 639 0370	723726
Speedf. 2 50 Lc Dd Silver Sport	50	04	24 639 0040	735112	Speedfight 2 100 Silver Sport	100	04	24 639 0370	723726
Speedf. 2 50 Lc Dd Silver Sport	50	05-07	24 639 0040	735112	Speedfight 2 100 Silver Sport	100	05-06	24 639 0370	723726
Speedf. 2 50 Lc Dd Ultim. Edition	50	08-09	24 639 0040	735112	Speedfight 2 100 Wrc 206	100	04	24 639 0370	723726
Speedfight 2 50 Lc Dd Wrc 206	50	03-04	24 639 0040	735112	Speedfight 2 100 Wrc 307	100	05	24 639 0370	723726
Speedfight 2 50 Lc Dd Wrc 307	50	05	24 639 0040	735112	Speedfight 2 100 X-Race	100	02	24 639 0370	723726
Speedfight 2 50 Lc Dd X-Race	50	01	24 639 0040	735112	Speedfight 2 100 X-Race	100	03	24 639 0370	723726
Speedfight 2 50 Lc Dd X-Race	50	02	24 639 0040	735112	Sv 100	100	98	24 639 0370	723726
Speedfight 2 50 Lc Dd X-Race	50	03	24 639 0040	735112	Trekker 100 Road	100	98-00	24 639 0040	735112
Speedfight 3 50 Ac Dt	50	09	24 639 0040	735112	Vivacity 100	100	03-04	24 639 0370	723726
Speedfight 3 50 Ac Dt	50	10-11	24 639 0040	735112	Vivacity 100	100	05-07	24 639 0370	723726
Speedfight 3 50 Ac Dt Rs	50	10-11	24 639 0040	735112	Vivacity 100	100	99-02	24 639 0370	723726
Speedfight 3 50 Lc Dd	50	10-11	24 639 0040	735112	PIAGGIO				
Speedfight 3 50 Lc Dd Rs	50	10-11	24 639 0040	735112	Ape	50	09-17	24 639 0071	179116
Tkr 50	50	01	24 639 0040	735112	Ape FL - FL2	50	89-95	24 639 0071	1791165
Tkr 50	50	02	24 639 0040	735112	Ape FL3 Europa	50	96-99	24 639 0071	1791165
Tkr 50	50	05	24 639 0040	735112	Ape Mix 2T	50	98-08	24 639 0071	179116
Tkr 50	50	06	24 639 0040	735112	Ape Rst Mix	50	99-03	24 639 0071	1791165
Tkr 50	50	07	24 639 0040	735112	Ape Tm P	50	85-89	24 639 0071	1791165
Tkr 50	50	08	24 639 0040	735112	Diesis	50	01	24 639 0010	82530R
Tkr 50	50	09	24 639 0040	735112	Fly 2T	50	05-07	24 639 0010	82530R
Tkr 50	50	03-04	24 639 0040	735112	Fly 2T	50	10-11	24 639 0010	82530R
Tkr 50 Furious	50	03-04	24 639 0040	735112	Fly 4T	50	05-07	24 639 0080	96921R
Tkr 50 Furious	50	05-08	24 639 0040	735112	Fly 4T & 25-30 Km/H	50	08-11	24 639 0080	96921R
Tkr 50 Furious	50	09-11	24 639 0040	735112	Fly 4T 2V	50	13-15	24 639 0080	96921R
Tkr 50 Metal-X	50	02	24 639 0040	735112	Fly 4T 2V 25-30Km-H	50	12-14	24 639 0080	96921R
Tkr 50 Metal-X	50	03	24 639 0040	735112	Fly 4T 4V	50	12-13	24 639 0080	96921R
Tkr 50 Rally Victories	50	06-07	24 639 0040	735112	Fly 4T Motore Chn	50	06-07	24 639 0080	96921R
Tkr 50 Rcup	50	08-09	24 639 0040	735112	Free	50	92-94	24 639 0010	82530R
Tkr 50 Streetboard	50	01	24 639 0040	735112	Free Delivery	50	00-01	24 639 0010	82530R
Tkr 50 Streetzone	50	03	24 639 0040	735112	Free FL	50	95-02	24 639 0010	82530R
Tkr 50 Wrc 307	50	05	24 639 0040	735112	Liberty	50	97-05	24 639 0010	82530R
Trekker 50 Off Road	50	98-00	24 639 0040	735112	Liberty 2T	50	06	24 639 0010	82530R
Trekker 50 Road	50	98-00	24 639 0040	735112	Liberty 2T	50	07-08	24 639 0010	82530R
Trekker 50 Streetboard	50	99-00	24 639 0040	735112	Liberty 2T Rst	50	04	24 639 0010	82530R
Vivacity 50	50	02	24 639 0040	735112	Liberty 2T Sport	50	06	24 639 0010	82530R
Vivacity 50	50	03-04	24 639 0040	735112	Liberty 2T Sport	50	07-08	24 639 0010	82530R
Vivacity 50	50	99-01	24 639 0040	735112	Liberty 2T Sport	50	05-08	24 639 0080	96921R
Vivacity 50 2	50	07	24 639 0040	735112	Liberty 4T	50	00-02	24 639 0080	96921R
Vivacity 50 2	50	08	24 639 0040	735112	Liberty 4T Delivery - Single	50	10-14	24 639 0080	96921R
Vivacity 50 2	50	09	24 639 0040	735112	Liberty 4T Delivery Tnt	50	09	24 639 0080	96921R
Vivacity 50 2	50	05-06	24 639 0040	735112	Liberty 4T Ptt - Double - Nexive	50	09-15	24 639 0080	96921R
Vivacity 50 2 Blueline	50	05	24 639 0040	735112	Liberty 4T Ptt (Deu)	50	07-12	24 639 0080	96921R
					Liberty 4T Rst	50	04	24 639 0080	96921R

MOTORINI AVVIAMENTO

STARTER MOTORS



Modello - Model	Cc	Anno Year	Codice RMS RMS Code	Riferimento Originale Oem Number	Modello - Model	Cc	Anno Year	Codice RMS RMS Code	Riferimento Originale Oem Number
Liberty 4T Sport	50	06	24 639 0080	96921R	Zip Fast Raider	50	93-94	24 639 0010	82530R
Liberty 4T Sport	50	07-08	24 639 0080	96921R	Zip Fast Raider Rst	50	96-97	24 639 0010	82530R
Liberty Moc 2T & Elle	50	09-13	24 639 0010	82530R	Zip Rst	50	96-99	24 639 0010	82530R
Liberty Moc 4T & Elle	50	09-16	24 639 0080	96921R	Zip Rst	50	96-99	24 639 0080	96921R
Liberty Ptt Eu2	50	04-05	24 639 0010	82530R	Zip Sp	50	01-04	24 639 0010	82530R
Nrg	50	94-96	24 639 0010	82530R	Zip Sp	50	96-00	24 639 0010	82530R
Nrg Extreme	50	99-00	24 639 0010	82530R	Zip Sp Eu2	50	06-13	24 639 0010	82530R
Nrg Mc3	50	01-04	24 639 0010	82530R	Skr City	80	99	24 639 0080	96921R
Nrg Power Dd	50	05	24 639 0010	82530R	Diesis	100	01	24 639 0080	ODN00G03905891
Nrg Power Dd	50	06	24 639 0010	82530R	Beverly	125	01-03	24 639 0090	82611R
Nrg Power Dd	50	07-15	24 639 0010	82530R	Beverly Eu3	125	07-08	24 639 0090	82611R
Nrg Power Dd Serie Speciale	50	07-12	24 639 0010	82530R	Beverly Eu3 Mic	125	07	24 639 0090	82611R
Nrg Power Dt	50	06	24 639 0010	82530R	Beverly Eu3 Sport	125	07-08	24 639 0090	82611R
Nrg Power Dt	50	07-15	24 639 0010	82530R	Beverly Rst	125	04-05	24 639 0090	82611R
Nrg Power Dt Serie Speciale	50	07-08	24 639 0010	82530R	Beverly Rst	125	05-07	24 639 0090	82611R
Nrg Power Purejet	50	06	24 639 0080	96921R	Beverly Tourer Eu3	125	07-10	24 639 0090	82611R
Nrg Power Purejet	50	04-05	24 639 0080	96921R	Carnaby	125	07-10	24 639 0090	82611R
Nrg Power Purejet	50	07-09	24 639 0080	96921R	Cosa CL-CLX	125	88-91	24 639 0261	249235
Nrg Power Purejet	50	10-11	24 639 0080	96921R	Fly	125	05-07	24 639 0090	82611R
Nrg Purejet	50	10	24 639 0080	96921R	Fly 4T 3V le E3 Dt	125	13-15	24 639 0400	58294R
Nrg Purejet	50	02-04	24 639 0080	96921R	Fly 4T 3V le Eu3 Lem	125	12-13	24 639 0400	58294R
Nrg Rst Mc2	50	96-98	24 639 0010	82530R	Fly Eu3	125	07	24 639 0090	82611R
Ntt	50	95-96	24 639 0010	82530R	Fly Eu3	125	08-11	24 639 0090	82611R
Puch P1-Tre	50	93-98	24 639 0080	96921R	Hexagon	125	94-97	24 639 0110	289094
Quartz	50	92-96	24 639 0010	82530R	Hexagon Gtx	125	00	24 639 0090	82611R
Sfera	50	91-93	24 639 0010	82530R	Hexagon Lx4	125	98-99	24 639 0100	2947365
Sfera Maquillage 2	50	94	24 639 0010	82530R	Hexagon Lx-Lxt	125	98-99	24 639 0110	289094
Sfera Rst	50	95-97	24 639 0010	82530R	Liberty	125	01-02	24 639 0090	82611R
Typhoon	50	01-04	24 639 0010	82530R	Liberty	125	98-00	24 639 0100	2947365
Typhoon	50	05-08	24 639 0010	82530R	Liberty 4T	125	06-07	24 639 0090	82611R
Typhoon	50	09-11	24 639 0010	82530R	Liberty 4T 2V Eu3	125	09-12	24 639 0090	82611R
Typhoon 2T Eu2	50	10-16	24 639 0010	82530R	Liberty 4T 2V le Ptt - Ita	125	12-13	24 639 0090	82611R
Typhoon 2T Eu3 Ch	50	11	24 639 0010	82530R	Liberty 4T 3V le E3	125	13-14	24 639 0400	58294R
Vespa Et2	50	97-05	24 639 0010	82530R	Liberty 4T Eu3	125	06-08	24 639 0090	82611R
Vespa Et2 Iniezione	50	97-00	24 639 0010	82530R	Liberty 4T Eu3 Delivery - Single	125	07-15	24 639 0090	82611R
Vespa Et4	50	00-05	24 639 0080	96921R	Liberty 4T Eu3 Deliv.-Tnt- Nexive	125	08-15	24 639 0090	82611R
Vespa FL	50	90	24 639 0071	1791165	Liberty 4T Sport Eu3	125	06-08	24 639 0090	82611R
Vespa FL2 Automatica	50	90-91	24 639 0071	1791165	Liberty Rst	125	04-05	24 639 0090	82611R
Vespa FL2 Hp	50	91-97	24 639 0071	1791165	Liberty Rst Ptt	125	05-11	24 639 0090	82611R
Vespa Lx 2T	50	09-13	24 639 0010	82530R	Liberty Sport	125	06	24 639 0090	82611R
Vespa Lx 2T	50	05-08	24 639 0010	82530R	Mp3	125	06-08	24 639 0090	82611R
Vespa Lx 2T Touring & 30Km	50	10-13	24 639 0010	82530R	Mp3 Ibrido	125	09-10	24 639 0400	58294R
Vespa Lx 4T	50	05-09	24 639 0080	96921R	Mp3 le	125	08-09	24 639 0400	58294R
Vespa Lx 4T-4V	50	09-13	24 639 0080	96921R	Mp3 le Touring	125	11-12	24 639 0400	58173R
Vespa Lx 4T-4V Touring	50	10-13	24 639 0080	96921R	Sfera	125	95-97	24 639 0100	2947365
Vespa Lxv 2T	50	06-09	24 639 0010	82530R	Skipper	125	94-97	24 639 0110	2931924
Vespa Lxv 2T Navy	50	08	24 639 0010	82530R	Skipper 4T	125	00-02	24 639 0090	82611R
Vespa N	50	89-90	24 639 0071	1791165	Skipper Lx	125	98-99	24 639 0110	289094
Vespa Pk	50	82-84	24 639 0071	1791165	Super Hexagon Gtx 12	125	01-02	24 639 0090	82611R
Vespa Pk Automatica	50	84-89	24 639 0071	1791165	Typhoon 4T 2V Eu3	125	10-11	24 639 0090	82611R
Vespa Pk XL	50	85-88	24 639 0071	1791165	Vespa 946 4T 3V Abs	125	13-15	24 639 0400	58294R
Vespa Pk XL Plurimatic	50	85-90	24 639 0071	1791165	Vespa 946 4T 3V Abs Armani	125	15	24 639 0400	58294R
Vespa Pk XL Rush	50	88-89	24 639 0071	1791165	Vespa Et4	125	96-98	24 639 0100	430554
Vespa Primavera 2T	50	13-17	24 639 0010	82530R	Vespa Et4	125	99-02	24 639 0090	82611R
Vespa Primavera 4T 2V 25 Km/H	50	14-16	24 639 0080	96921R	Vespa FL	125	89-90	24 639 0071	1791165
Vespa Primavera 4T-4V	50	13-16	24 639 0080	96921R	Vespa Granturismo	125	03-05	24 639 0090	82611R
Vespa S 2T & College	50	07-12	24 639 0010	82530R	Vespa Granturismo	125	06-07	24 639 0090	82611R
Vespa S 4T-4V & College	50	08-12	24 639 0080	96921R	Vespa Granturismo Eu3	125	06-07	24 639 0090	82611R
Vespa Sprint 2T 2V	50	14-16	24 639 0010	82530R	Vespa Gts 4T le Super	125	09-16	24 639 0220	58142R
Vespa Sprint 4T 2V 25 Km/H	50	14-16	24 639 0080	96921R	Vespa Gts Eu3	125	07-12	24 639 0090	82611R
Vespa Sprint 4T 4V	50	14-16	24 639 0080	96921R	Vespa Gtv	125	06-08	24 639 0090	82611R
Zip	50	00-04	24 639 0010	82530R	Vespa Gtv 4T Navy Euro3	125	08	24 639 0090	82611R
Zip	50	92-93	24 639 0010	82530R	Vespa Lx	125	05-06	24 639 0090	82611R
Zip	50	95-96	24 639 0010	82530R	Vespa Lx 4T 3V le - Touring	125	12-13	24 639 0400	58173R
Zip 2T	50	08-13	24 639 0010	82530R	Vespa Lx 4T 3V le - Touring	125	12-13	24 639 0400	58294R
Zip 4T	50	06-13	24 639 0080	96921R	Vespa Lx 4T Eu3 Touring	125	10-11	24 639 0090	82611R
Zip 4T	50	00-05	24 639 0080	96921R	Vespa Lx 4T FL	125	09	24 639 0090	82611R
Zip 4T 25Km-H	50	06-16	24 639 0080	96921R	Vespa Lx Eu3	125	06-08	24 639 0090	82611R
Zip Bimodale	50	94-97	24 639 0010	82530R	Vespa Lx Eu3 le	125	09-11	24 639 0090	82611R



MOTORINI AVVIAMENTO

STARTER MOTORS

Modello - Model	Cc	Anno Year	Codice RMS RMS Code	Riferimento Originale Oem Number	Modello - Model	Cc	Anno Year	Codice RMS RMS Code	Riferimento Originale Oem Number
Vespa Lx Primavera 4T 3V le	125	13-16	24 639 0400	58294R	Mp3	250	06-08	24 639 0220	58142R
Vespa Lxv 4T Eu3	125	06-09	24 639 0090	82611R	Mp3 Lt	250	08-09	24 639 0220	58142R
Vespa Lxv 4T Navy Eu3	125	07-08	24 639 0090	82611R	Mp3 Mic	250	08-09	24 639 0220	58142R
Vespa Lxv le 4T	125	10-13	24 639 0090	82611R	Vespa Gt 60 Eu3	250	06-07	24 639 0220	58142R
Vespa Px	125	11-16	24 639 0261	249235	Vespa Gts	250	05-16	24 639 0220	58142R
Vespa Px	125	98-01	24 639 0261	249235	Vespa Gts Abs	250	05-12	24 639 0220	58142R
Vespa Px 30 Anni	125	07-08	24 639 0261	249235	Vespa Gtv	250	06-09	24 639 0220	58142R
Vespa Px Eu2	125	01-07	24 639 0261	249235	Vespa Gtv 4T Navy Eu3	250	07	24 639 0220	58142R
Vespa Pxe Arcobaleno	125	81-97	24 639 0261	249235	X Evo	250	07-16	24 639 0220	58088R
Vespa S 4T 3V le	125	12	24 639 0400	58294R	X Evo	250	07-16	24 639 0220	58142R
Vespa S 4T Eu3	125	07-08	24 639 0090	82611R	X7 Eu3	250	08	24 639 0220	58142R
Vespa S 4T le & College	125	09-11	24 639 0090	82611R	X8 Eu3	250	05-08	24 639 0220	58142R
Vespa Sprint 4T 3V le	125	14-15	24 639 0400	58294R	X9 Evolution	250	04	24 639 0220	840235
Vespa Sprint Iget 4T 3V Abs	125	16-17	24 639 0400	58294R	X9 Evolution	250	06	24 639 0220	58142R
X Evo	125	07-16	24 639 0090	82611R	Beverly le Abs E4	300	16	24 639 0220	58142R
X7 Eu3	125	08	24 639 0090	82611R	Beverly Rst 4T 4V le Eu3	300	10-15	24 639 0220	58142R
X7 Evo le Eu3	125	09-10	24 639 0220	58142R	Beverly Tourer Eu3	300	09-10	24 639 0220	58142R
X8	125	04	24 639 0090	82611R	Carnaby Cruiser	300	09-12	24 639 0220	58142R
X8	125	05-06	24 639 0090	82611R	Mp3 300 le Lt	300	10-11	24 639 0400	58173R
X8 Premium Eu2	125	06	24 639 0090	82611R	Mp3 300 le Mic	300	10	24 639 0400	58173R
X8 Premium Eu3	125	06-07	24 639 0090	82611R	Mp3 300 le Mic	300	11	24 639 0400	58294R
X8 Street Eu2	125	06-07	24 639 0090	82611R	Mp3 4T 4V le ERL Ibrido	300	10-13	24 639 0400	58173R
X9	125	01-02	24 639 0090	82611R	Mp3 4T 4V le Lt Ibrido	300	10-11	24 639 0400	58173R
X9 Evolution	125	03	24 639 0090	82611R	Mp3 le Lt- le Lt Sport	300	11-14	24 639 0400	58173R
X9 Evolution	125	05-06	24 639 0090	82611R	Mp3 le Lt Touring	300	11-13	24 639 0400	58173R
X9 Evolution Eu3	125	07	24 639 0090	82611R	Mp3 le Touring	300	11-12	24 639 0400	58173R
Zip	125	00-02	24 639 0090	82611R	Vespa Gts le & Touring	300	12-16	24 639 0220	58142R
Fly	150	05-07	24 639 0090	82611R	Vespa Gts le Abs E4	300	16-17	24 639 0220	58142R5
Fly Eu3	150	08-11	24 639 0090	82611R	Vespa Gts le Touring	300	11-12	24 639 0220	58142R
Liberty 4T 3V Lem	150	13-14	24 639 0400	58294R	Vespa Gts Super	300	08-16	24 639 0220	58142R
Liberty 4T Eu3	150	08	24 639 0090	82611R	Vespa Gts Super Sport	300	10-13	24 639 0220	58142R
Liberty 4T Sport Eu3	150	08	24 639 0090	82611R	Vespa Gtv 4T 4V le	300	10-13	24 639 0220	58142R
Liberty Moc 4T Eu3	150	09-13	24 639 0090	82611R	Vespa Gtv Via Montenapoleone	300	10	24 639 0220	58142R
Vespa Lt 4T 3V le	150	14	24 639 0400	58294R	X7 Evo le Eu3	300	09-10	24 639 0220	58142R
Vespa Lx	150	05-06	24 639 0090	82611R	Beverly Eu3	400	06-07	24 639 0230	82699R
Vespa Lx 4T 3V le - Touring	150	12-13	24 639 0400	58294R	Beverly Tourer Eu3	400	08-10	24 639 0230	82699R
Vespa Lx 4T Fl	150	09	24 639 0090	82611R	Mp3	400	07-08	24 639 0230	82699R
Vespa Lx Eu3	150	06-08	24 639 0090	82611R	Mp3 le Lt - Mp3 le Lt Sport	400	08-10	24 639 0230	82699R
Vespa Lx Eu3 le	150	09-11	24 639 0090	82611R	Mp3 le Lt Touring	400	11	24 639 0230	82699R
Vespa Lx Touring	150	10-12	24 639 0090	82611R	Mp3 Mic	400	08-10	24 639 0230	82699R
Vespa Primavera 4T-3V	150	13-16	24 639 0400	58294R	Mp3 Rl Touring	400	11	24 639 0230	82699R
Vespa Px	150	11-17	24 639 0261	249235	X Evo	400	07-11	24 639 0230	82699R
Vespa S 4T	150	08-09	24 639 0090	82611R	X8 Eu3	400	06-08	24 639 0230	82699R
Vespa S 4T le & College	150	09-12	24 639 0090	82611R	Beverly	500	02-04	24 639 0230	82699R
Vespa Sprint 4T 3V le	150	15	24 639 0400	58294R	Beverly	500	05-06	24 639 0230	82699R
X8 Street Eu2	150	06-08	24 639 0090	82611R	Beverly Cruiser	500	07-12	24 639 0230	82699R
X9 Amalfi	180	00-03	24 639 0090	82611R	Beverly Eu3	500	06-08	24 639 0230	82699R
Carnaby	200	07-08	24 639 0090	82611R	Mp3 Lt Business Abs	500	14-16	24 639 0230	82699R
Liberty	200	06	24 639 0090	82611R	Mp3 Lt E4 Sport - Business	500	16	24 639 0230	82699R
Liberty 4T Eu3	200	06-08	24 639 0090	82611R	Mp3 Lt Sport - Business	500	11-13	24 639 0230	82699R
Liberty 4T Sport Eu3	200	06-07	24 639 0090	82611R	Mp3 Rl Sport - Business	500	11-12	24 639 0230	82699R
Liberty Rst	200	04	24 639 0090	82611R	Mp3 Sport Abs	500	14-16	24 639 0230	82699R
Liberty Sport	200	06	24 639 0090	82611R	X10 4T 4V le Eu3	500	12-14	24 639 0230	82699R
Vespa Granturismo	200	06-07	24 639 0090	82611R	X9	500	01-02	24 639 0080	96921R
X8	200	05-07	24 639 0090	82611R	X9	500	01-02	24 639 0230	82699R
X9	200	02-03	24 639 0090	82611R	X9 Evolution	500	03-05	24 639 0080	96921R
X9 Evolution	200	03	24 639 0090	82611R	X9 Evolution	500	03-05	24 639 0230	82699R
Beverly	250	06-07	24 639 0220	58142R	X9 Evolution	500	06-07	24 639 0080	96921R
Beverly Cruiser	250	07-09	24 639 0220	58088R	X9 Evolution	500	06-07	24 639 0230	82699R
Beverly Cruiser	250	07-09	24 639 0220	58142R	X9 Evolution Abs	500	06-07	24 639 0080	286808
Beverly Eu3 Mic	250	07	24 639 0220	58142R	X9 Evolution Abs	500	06-07	24 639 0230	82699R
Beverly le Eu3	250	06-08	24 639 0220	58088R	SUZUKI				
Beverly le Eu3	250	06-08	24 639 0220	58142R	Aj Zz Sepia S	50	95-97	24 639 0160	31100-36C02-000
Beverly Rst	250	04-05	24 639 0220	840235	Ay50ayw Katana V-Y	50	97-00	24 639 0160	31100-36C02-00N
Beverly Sport	250	06-08	24 639 0220	58088R	Tr S Street Magic	50	98	24 639 0160	31100-36C02-000
Beverly Sport	250	06-08	24 639 0220	58142R	Ux Zillion	50	99	24 639 0160	31100-36C02-00N
Beverly Tourer Eu3	250	07-09	24 639 0220	58142R	Uc Epicuro X-K1	125	99-01	24 639 0280	31100-14F01-000
Carnaby	250	08	24 639 0220	58142R	Uh125 Burgman K2-K6	125	02-06	24 639 0280	31100-14F01-000
Hexagon Gt-Gtx	250	98-00	24 639 0240	495180	Uc Epicuro X-K1	150	99-01	24 639 0280	31100-14F01-000

MOTORINI AVVIAMENTO

STARTER MOTORS



Modello - Model	Cc	Anno Year	Codice RMS RMS Code	Riferimento Originale Oem Number	Modello - Model	Cc	Anno Year	Codice RMS RMS Code	Riferimento Originale Oem Number
Uh200 Burgman K2-K6	150	02-06	24 639 0280	31100-14F01-000	Yp125r X-Max	125	15-16	24 639 0340	1B9H18000100
An250 Burgman K3-K6	250	03-06	24 639 0280	31100-14F01-000	Yp125r X-Max Abs	125	11	24 639 0340	1B9H18000100
An250 Burgman W-K2	250	98-02	24 639 0280	31100-14F01-000	Yp125ra X-Max Abs	125	13	24 639 0340	1B9H18000100
An400 Burgman K3-K6	400	03-06	24 639 0280	31100-14F01-000	Yp125ra X-Max Abs	125	16	24 639 0340	1B9H18000100
An400 Burgman X-K2	400	99-02	24 639 0280	31100-14F01-000	Yp125ra X-Max Abs	125	17	24 639 0340	1B9H18000100
SYM					Yp125ra X-Max Abs	125	14-15	24 639 0340	1B9H18000100
Jet	50	99	24 639 0120	31200GAK900	Hw Xenter	150	12-16	24 639 0390	52SH18000000
Jungle	50	99	24 639 0120	31200GAK900	Xn Teo's	150	01-02	24 639 0150	5DSH18000000
Mask	50	00-01	24 639 0120	31200GAK900	Xq Maxster	150	01-02	24 639 0150	5DSH18000000
Mask Eu2	50	03-04	24 639 0120	31200GAK900	Yp150 Majesty	150	01-02	24 639 0150	5DSH18000000
Red Devil	50	99	24 639 0120	31200GAK900	Yp180e Majesty	180	03-06	24 639 0150	5DSH18000000
Super Fancy	50	98-00	24 639 0120	31200GAK900	Yp250 Majesty	250	98-03	24 639 0190	1SDH18000000
Eu Mx	125	02	24 639 0180	31200M92100	Xc Varsity	300	03	24 639 0190	1SDH18000000
Eu Mx E2	125	03-04	24 639 0180	31200M92100	Yp400 Majesty	400	04-11	24 639 0190	1SDH18000000
Gts Joymax	125	06-07	24 639 0350	31200H9A000	Yp400r X-Max	400	13-14	24 639 0190	1SDH18000000
Hd Eu2	125	03-04	24 639 0360	31200HLA000	Yp400r X-Max	400	15-16	24 639 0190	1SDH18000000
Hd Eu3	125	07-08	24 639 0350	31200H9A000	Yp400r X-Max Momodesign	400	14	24 639 0190	1SDH18000000
Hd Evo	125	05-06	24 639 0350	31200H9A000	Yp400ra X-Max Abs	400	14	24 639 0190	1SDH18000000
Hd Evo Eu3	125	07-08	24 639 0350	31200H9A000	Yp400ra X-Max Abs	400	15-17	24 639 0190	1SDH18000000
Hd Evo Eu3	125	10-11	24 639 0350	31200H9A000	Yp400ra X-Max Ironmax Abs	400	16	24 639 0190	1SDH18000000
Hd Evo Tamburo Eu3	125	08-09	24 639 0350	31200H9A000	Yp400ra X-Max Momodesign Abs	400	14	24 639 0190	1SDH18000000
Hd2	125	11	24 639 0350	31200H9A000					
Hd2	125	14	24 639 0350	31200H9A000					
Joyride	125	01-02	24 639 0350	31200H9A000					
Joyride Eu2	125	05-06	24 639 0350	31200H9A000					
Joyride Eu3	125	07	24 639 0350	31200H9A000					
Joyride Evo	125	10	24 639 0350	31200H9A000					
Joyride Evo	125	13	24 639 0350	31200H9A000					
Joyride Evo	125	14	24 639 0350	31200H9A000					
Joyride Evo	125	09-10	24 639 0350	31200H9A000					
Shark	125	99-02	24 639 0180	31200M92100					
Euro Mx	150	02	24 639 0180	31200M92100					
Euro Mx Eu2	150	03-04	24 639 0180	31200M92100					
Joyride	150	01-02	24 639 0350	31200H9A000					
Shark	150	00-01	24 639 0180	31200M92100					
Track Runner	180	06-07	24 639 0360	31200HLA000					
Hd Eu2	200	03-04	24 639 0360	31200HLA000					
Hd Eu3 I	200	07	24 639 0360	31200HLA000					
Hd Evo Eu2	200	05-06	24 639 0360	31200HLA000					
Hd Evo Eu3 I	200	07	24 639 0360	31200HLA000					
Hd Evo I Eu3	200	10-12	24 639 0360	31200HLA000					
Hd Evo I Tamburo Eu3	200	08-09	24 639 0360	31200HLA000					
Hd2 I	200	11	24 639 0360	31200HLA000					
Hd2 I	200	14	24 639 0360	31200HLA000					
Joyride	200	03	24 639 0360	31200HLA000					
Joyride Eu2	200	03-04	24 639 0360	31200HLA000					
Joyride Eu2	200	05-06	24 639 0360	31200HLA000					
Joyride Evo I	200	09	24 639 0360	31200HLA000					
Joyride Evo I	200	13-14	24 639 0360	31200HLA000					
Joyride I Eu3	200	07-09	24 639 0360	31200HLA000					
Joyride I Evo	200	10	24 639 0360	31200HLA000					
YAMAHA									
Yh Why	50	01-02	24 639 0020	4CUH18001000					
Yq Aerox	50	07	24 639 0020	4CUH18001000					
Yq Aerox	50	08	24 639 0020	4CUH18001000					
Yq Aerox	50	09	24 639 0020	4CUH18001000					
Yq Aerox	50	10-12	24 639 0020	4CUH18001000					
Hw Xenter	125	12-16	24 639 0390	52SH18000000					
Vp X-City	125	08-11	24 639 0340	1B9H18000100					
Xc125r Majesty S	125	14	24 639 0390	52SH18000000					
Xq Maxster	125	01-02	24 639 0150	5DSH18000000					
Yp125 Majesty	125	01-02	24 639 0150	5DSH18000000					
Yp125e Majesty	125	06	24 639 0150	5DSH18000000					
Yp125e Majesty	125	03-05	24 639 0150	5DSH18000000					
Yp125r X-Max	125	14	24 639 0340	1B9H18000100					
Yp125r X-Max	125	12-13	24 639 0340	1B9H18000100					
Yp125r X-Max	125	06-07	24 639 0340	1B9H18000000					
Yp125r X-Max	125	08-09	24 639 0340	1B9H18000100					
Yp125r X-Max	125	10-12	24 639 0340	1B9H18000100					



STATORI - VOLANI

STATORS - MAGNETOS

24 635 0011



NEW

24 635 0013



PIAGGIO - (R.O. 199500)

6 POLI - 6 POLES
PIAGGIO - (R.O. 199500)

24 635 0042



6 POLI Ø 96 MM - 6 POLES Ø 96 MM
GILERA - PIAGGIO (R.O. 830294)
Di primo equipaggiamento - *O.E.M. Quality*



24 635 0052



6 POLI CON PIASTRA Ø 94 MM
6 POLES WITH PLATE Ø 94 MM
APRILIA - (R.O. 82852R)
DERBI - (R.O. 47065/82852R)
Di primo equipaggiamento - *O.E.M. Quality*

24 635 0062



12 POLI Ø 84 MM CON PICK-UP
12 POLES Ø 84 MM WITH PICK-UP
APRILIA - (R.O. AP8551076)
DERBI - PIAGGIO (R.O. 969228)
ITALJET
MALAGUTI - (R.O. 48201400)
Di primo equipaggiamento - *O.E.M. Quality*

24 635 0063



6 POLI - 6 POLES
PIAGGIO - (R.O. 199495)



24 635 0072



6 POLI Ø 96 MM
6 POLES Ø 96 MM
APRILIA - DERBI (R.O. 830296)
ITALJET
GILERA - (R.O. 584525/639865/830296)
PIAGGIO - (R.O. 584525 • 639865 • 830296)
Di primo equipaggiamento - *O.E.M. Quality*

24 635 0073



5 POLI - 5 POLES
PIAGGIO - (R.O. 217866)

24 635 0082



12 POLI Ø 84 MM CON PICK-UP
CON CONNETTORE A 3 PIN
12 POLES Ø 84 MM WITH PICK-UP
WITH CONNECTOR 3 PINS
APRILIA - PIAGGIO - (R.O. 833632)
Di primo equipaggiamento - *O.E.M. Quality*





24 635 0092 

18 POLI Ø 95 MM CON PICK UP
18 POLES Ø 95 MM WITH PICK UP
APRILIA - (R.O. AP 8577045)
DERBI - (R.O. 58048R)
GILERA - PIAGGIO - (R.O.58048R • 584849)
MALAGUTI - (R.O. 48200800)
 Di primo equipaggiamento – *O.E.M. Quality*



24 635 0102 

18 POLI Ø 94,7 MM CON PICK UP A 2 CAVI
18 POLES Ø 94,7 MM WITH PICK UP 2 CABLES
APRILIA - DERBI - (R.O. 638848)
GILERA - PIAGGIO - (R.O. 58070R • 58112R • 638848)
MALAGUTI - (R.O. 48202000)
 Di primo equipaggiamento – *O.E.M. Quality*



24 635 0112 

18 POLI Ø 96 MM - 18 POLES Ø 96 MM
APRILIA - (R.O. AP8560100)
GILERA - PIAGGIO - (R.O. 58080R)
MALAGUTI - (R.O. 40201900)
 Di primo equipaggiamento – *O.E.M. Quality*



24 635 0122 

18 POLI Ø 96 MM CON PICK UP 2 CAVI
18 POLES Ø 96 MM WITH PICK UP 2 CABLES
APRILIA - (R.O. 58108R)
GILERA - PIAGGIO - (R.O. 58108R)
MALAGUTI - (R.O. 48202400)
PEUGEOT - (R.O. 759735)
 Di primo equipaggiamento – *O.E.M. Quality*



24 635 0142 

12 POLI TRIFASE 150 W Ø 84 MM
12 POLES THREEPHASES 150 W Ø 84 MM
APRILIA - DERBI - GILERA - PIAGGIO
 (R.O: 584690)
 Di primo equipaggiamento – *O.E.M. Quality*



24 635 0152 

8 POLI 12 V CON PICK UP Ø 88 MM
8 POLES 12 V WITH PICK UP Ø 88 MM
KYMCO - (R.O. 00103025 • 31120-LBD6-E0A)
 Di primo equipaggiamento – *O.E.M. Quality*



24 635 0162 

8 POLI 12 V CON PICK UP Ø 88 MM
8 POLES 12 V WITH PICK UP Ø 88 MM
KYMCO - (R.O. 00128172 • 31120-KUDU-90A)
 Di primo equipaggiamento – *O.E.M. Quality*



24 635 0172 

8 POLI 12 V CON PICK UP Ø 88 MM
8 POLES 12 V WITH PICK UP Ø 88 MM
KYMCO - (R.O. 00103300 • 31120-KFA6-900)
 Di primo equipaggiamento – *O.E.M. Quality*



24 635 0182 

8 POLI 12 V CON PICK UP Ø 88 MM
8 POLES 12 V WITH PICK UP Ø 88 MM
KYMCO - (R.O. 00123300 • 31120-KHB4-90A)
 Di primo equipaggiamento – *O.E.M. Quality*





STATORI - VOLANI

STATORS - MAGNETOS

24 635 0192



12 POLI 12 V Ø 88,4 MM
12 POLES 12 V Ø 88,4 MM

KYMCO - (R.O. 00128184 • 31120-LCD3-E0B)
Di primo equipaggiamento - *O.E.M. Quality*



24 635 0202



10 POLI 12 V Ø 93 MM
10 POLES 12 V Ø 93 MM

KYMCO - (R.O. 00128947 • 31120-KBE-9000)
Di primo equipaggiamento - *O.E.M. Quality*



24 635 0210



MBK - YAMAHA - (R.O. 3KJ855600000)



24 635 0220



5 POLI - 5 POLES

PIAGGIO - (R.O. 186974)



24 635 0230



16 POLI - 16 POLES

MALAGUTI - (R.O. 78201900)
MBK - YAMAHA - (R.O. 5DS8511000)



24 635 0240



11 POLI 12V CON PICK UP
11 POLES 12V WITH PICK UP

KYMCO - (R.O. 00128039 • 31120-KKC2-81A)



24 635 0250



18 POLI 12V CON PICK UP Ø 91,8MM
18 POLES 12V WITH PICK UP Ø 91,8MM

KYMCO - (R.O. 00128937 • 00128944 • 00169320
• 00169140 • 31120-KKC4-90A)



24 635 0260



11 POLI - 11 POLES

SYM - (R.O. 31120H9A001)



24 635 0292



12 POLI - 12 POLES

PIAGGIO - (R.O. 642427)





24 635 0321 

12 POLI - 12 POLES
PIAGGIO - (R.O. 639727)



24 635 0330 

16 POLI - 16 POLES
YAMAHA - (R.O. 5VU814100100)



24 635 0351 

PEUGEOT



24 635 0362 

12 POLI - 12 POLES
PIAGGIO - (R.O. 642205)



24 635 0372 

PIAGGIO - (R.O. B016543)



NEW

24 635 0392 

12 POLI - 12 POLES
PIAGGIO - (R.O. 643166)



24 635 0400 

18 POLI - 18 POLES
YAMAHA - (R.O. 5GJ814100100)



24 635 0410 

18 POLI - 18 POLES
YAMAHA - (R.O. 5RU814100000)



24 635 0420 

18 POLI - 18 POLES
YAMAHA - (R.O. 34B814100000)



24 635 0433 

PIAGGIO - (R.O. 150776)



NEW

24 635 0442 

KYMCO - (R.O. 00169230)



NEW



STATORI - VOLANI

STATORS - MAGNETOS

Modello - Model	Cc	Anno Year	Codice RMS RMS Code	Riferimento Originale Oem Number	Modello - Model	Cc	Anno Year	Codice RMS RMS Code	Riferimento Originale Oem Number
APRILIA									
Mojito Custom 2T Mot. Piaggio	50	04-10	24 635 0072	584525	Sonar 2T	50	09	24 635 0072	639865
Rs	50	06-10	24 635 0052	847065	Variant Sport 2T	50	12	24 635 0072	639865
Rs4	50	11-13	24 635 0052	82852R	Atlantis 50-100 4T	100	04-06	24 635 0062	969228
Rs4 Replica	50	14-16	24 635 0052	82852R	Boulevard 4T	100	10-11	24 635 0062	969228
Scarabeo 4T	50	02-06	24 635 0062	AP8551076	Boulevard	125	02	24 635 0142	828135
Scarabeo 4T 4V	50	14	24 635 0082	833632	Boulevard	125	03-04	24 635 0142	828135
Scarabeo 4T 4V	50	10-12	24 635 0082	833632	Boulevard Eu2	125	04-07	24 635 0142	584690
Scarabeo 4T 4V Net	50	09	24 635 0082	833632	Boulevard 4T Eu3	125	08-12	24 635 0142	584690
Scarabeo 4T 4V Net	50	10	24 635 0082	833632	Gp1 Eu2	125	06	24 635 0142	584690
Scarabeo 4T Restyling Eu3	50	06-09	24 635 0062	969228	Rambla	125	08-09	24 635 0102	58070R
Scarabeo Quattro	50	09	24 635 0082	833632	Rambla E3 2Ver	125	08	24 635 0102	58070R
Sport City One 4T	50	08-10	24 635 0062	969228	Sonar 4T	125	09-11	24 635 0142	584690
Sr Iniezione e Carburatore	50	14	24 635 0072	584525	Variant Sport 4T E3	125	12	24 635 0142	584690
Sr Motard 4T 4V	50	13-14	24 635 0082	833632	Boulevard	150	02	24 635 0142	828135
Sr R Factory le e Carburatore	50	10-14	24 635 0072	584525	Boulevard	150	03-04	24 635 0142	828135
Sr R, R Factory	50	04-09	24 635 0072	584525	Boulevard Eu2	150	04-07	24 635 0142	584690
Scarabeo 4T	100	14	24 635 0062	969228	Boulevard 4T E3	150	10	24 635 0142	584690
Scarabeo 4T	100	01-05	24 635 0062	AP8551076	Sonar 4T	150	09	24 635 0142	584690
Scarabeo 4T	100	10-12	24 635 0062	969228	Boulevard Eu2	200	05-06	24 635 0142	584690
Scarabeo 4T Net	100	09	24 635 0062	969228	Gp1	250	06-07	24 635 0092	58048R
Scarabeo 4T Net Eu3	100	10	24 635 0062	969228	Gp1 Low Seat 250 Eu3	250	07-08	24 635 0102	58070R
Scarabeo 4T Restyling	100	06-09	24 635 0062	969228	Rambla	250	08-09	24 635 0102	58070R
Atlantic	125	03-05	24 635 0092	AP8577045	Rambla E3 2Ver	250	08	24 635 0102	58070R
Atlantic Eu3	125	06-08	24 635 0102	AP8176335	Rambla	300	10-11	24 635 0102	58070R
Mojito	125	08	24 635 0142	584690	GILERA				
Scarabeo	125	04-06	24 635 0092	AP8577045	Atlantis O2	50	02	24 635 0072	827849
Sport City Eu3	125	06-08	24 635 0102	AP8176335	Easy Moving	50	95-96	24 635 0042	830294
Sport City One 4T Eu3	125	08-11	24 635 0142	584690	Runner	50	97-00	24 635 0042	830294
Sr Max	125	11-14	24 635 0102	638848	Stalker	50	97-04	24 635 0042	830294
Sr Motard	125	12-14	24 635 0142	584690	Storm	50	94-95	24 635 0042	830294
Atlantic Eu3	250	06-08	24 635 0102	AP8176335	Typhoon	50	94-97	24 635 0042	830294
Scarabeo Light	250	06-08	24 635 0102	AP8176335	Typhoon X	50	98-99	24 635 0042	830294
Sport City Cube	250	08-12	24 635 0102	638848	Typhoon Xr	50	00	24 635 0042	830294
Scarabeo Light	300	09-10	24 635 0102	638848	Nexus Eu3 le	125	08	24 635 0102	58070R
Atlantic Sprint	400	05-08	24 635 0112	AP8560100	Nexus Eu3 le	125	09-10	24 635 0102	58070R
Atlantic	500	01-04	24 635 0112	AP8560100	Runner Vx	125	05-06	24 635 0142	584690
Atlantic Sprint	500	05-08	24 635 0112	AP8560100	Runner Vx Race	125	06	24 635 0142	584690
Scarabeo	500	03-06	24 635 0112	AP8560100	Runner Vx Sc	125	06-07	24 635 0142	584690
Scarabeo Light	500	06-08	24 635 0122	58108R	Runner Vxr	200	05-06	24 635 0142	584690
DERBI									
Atlantis 2T	50	10	24 635 0072	639865	Runner Vxr 4T St Eu3	200	08-11	24 635 0142	584690
Atlantis 2T Eu2	50	07-09	24 635 0072	639865	Runner Vxr Race	200	05-06	24 635 0142	584690
Atlantis 4T Eu2	50	07	24 635 0062	969228	Nexus Eu3	250	06	24 635 0102	58070R
Atlantis 50-100 4T	50	04-06	24 635 0062	969228	Nexus Eu3	250	07	24 635 0102	58070R
Atlantis O2	50	02	24 635 0072	827849	Nexus Sp Eu3	250	06-07	24 635 0102	58070R
Atlantis O2 Bullet	50	03-05	24 635 0072	830296	Oregon	250	06-10	24 635 0092	58048R
Atlantis O2 City	50	03-06	24 635 0072	830296	Nexus Eu3	300	08	24 635 0102	58070R
Atlantis O2 Red Bullet	50	03	24 635 0072	830296	Nexus Eu3	300	09-11	24 635 0102	58070R
Atlantis O2 Two Chic	50	05	24 635 0072	830296	Fuoco 4T-4V le E3 Lt	500	13-14	24 635 0122	58108R
Boulevard 2T	50	09-14	24 635 0072	639865	Fuoco Eu3	500	07-13	24 635 0122	58108R
Boulevard 4T Eu2 25 Km/H	50	09	24 635 0062	969228	Nexus	500	03-05	24 635 0112	82736R
Gp1	50	03	24 635 0072	830296	Nexus Eu3	500	06-08	24 635 0112	58080R
Gp1	50	01-02	24 635 0072	830296	Nexus Eu3	500	09-11	24 635 0112	58080R
Gp1 E2	50	03	24 635 0072	830296	Nexus Sp Eu3	500	06-07	24 635 0112	58080R
Gp1 Eu2	50	05	24 635 0072	830296	ITALJET				
Gp1 Open Eu2	50	06-09	24 635 0072	639865	Jet-Set 50	50	02-03	24 635 0072	-
Gp1 Race Eu2	50	05-07	24 635 0072	830296	Torpedo 50 2T	50	00-03	24 635 0072	-
Gpr 2T	50	13	24 635 0052	82852R	Torpedo 50 4T	50	01	24 635 0062	-
Gpr 2T Eu2	50	09-10	24 635 0052	82852R	Torpedo 50 4T	50	02	24 635 0062	-
Gpr Nude & Gpr Nude Tuning	50	06-08	24 635 0052	82852R	Torpedo 50 4T	50	03	24 635 0062	-
Gpr Nude Sport	50	06	24 635 0052	847065	KYMCO				
Gpr R Eu2 - Gpr Replica Eu2	50	08	24 635 0052	82852R	Agility 4T R10	50	06	24 635 0152	00103025
Gpr Racing Eu2	50	06	24 635 0052	847065	Agility 4T R10	50	07-08	24 635 0152	00103025
Gpr Replica & Gpr R Eu2	50	06	24 635 0052	847065	Agility 4T R12	50	07-08	24 635 0152	00103025
Gpr Replica 2T Malossi	50	07	24 635 0052	82852R	Agility R12	50	05	24 635 0152	00108158
Gpr Replica Pesek Eu2	50	07	24 635 0052	82852R	Agility R12	50	05	24 635 0152	00108693
Senda Hyp Drd Evo Lim. Edit. Eu2	50	08	24 635 0052	82852R	Dink 50 4T	50	07	24 635 0152	00103025
Senda R Drd Pro Eu2	50	05-11	24 635 0052	82852R	Filly	50	98-00	24 635 0152	00108662
Senda Sm Drd Pro Eu2	50	05-11	24 635 0052	82852R	Filly Lx	50	01-02	24 635 0152	00108692
Senda Sm Drd Pro Eu2 2Ver	50	05-08	24 635 0052	82852R	People	50	04	24 635 0172	00103300
					People	50	99-00	24 635 0172	00103300
					People Eu2	50	03	24 635 0172	00103300



Modello - Model	Cc	Anno Year	Codice RMS RMS Code	Riferimento Originale Oem Number	Modello - Model	Cc	Anno Year	Codice RMS RMS Code	Riferimento Originale Oem Number
People Eu2	50	08	24 635 0172	00103300	Yp Skyliner	125	01-02	24 635 0230	5DS855100000
People Eu2	50	11	24 635 0172	00103300	Yp Skyliner	125	98-00	24 635 0230	5DS855100000
People S	50	05-08	24 635 0172	00103300	Xn Doodo	150	01-02	24 635 0230	5DS855100000
People S 4T	50	06-08	24 635 0152	00103025	Xq Thunder	150	01-02	24 635 0230	5DS855100000
Sento	50	08	24 635 0152	00103025	Yp Skyliner	150	00	24 635 0230	5DS855100000
Vitality 4T	50	04	24 635 0152	00103025	Yp Skyliner	150	01-02	24 635 0230	5DS855100000
Agility 4T Eu3	125	06-08	24 635 0162	00128172	Yp E Skyliner	180	03	24 635 0230	5DS855100000
Agility Carry	125	11	24 635 0162	00128214	PEUGEOT				
B&W	125	00	24 635 0202	00128947	Ludix 50 Classic 1 Seater	50	04	24 635 0351	-
B&W Eu2	125	03-04	24 635 0202	00128947	Ludix 50 Classic 1 Seater	50	05	24 635 0351	-
Dink 125 Eu3	125	06-07	24 635 0202	00128947	Ludix 50 Classic 1 Seater	50	06	24 635 0351	-
Dink	125	97-98	24 635 0202	00128947	Ludix 50 Classic 1 Seater	50	07	24 635 0351	-
Dink Classic	125	02	24 635 0202	00128947	Ludix 50 Classic 2 Seater	50	06-07	24 635 0351	-
Dink Classic Eu2	125	03	24 635 0202	00128947	Ludix 50 Elegance	50	04	24 635 0351	-
Dink Lx	125	98-00	24 635 0202	00128947	Ludix 50 Elegance	50	05	24 635 0351	-
Grand Dink	125	01-02	24 635 0202	00128947	Ludix 50 Elegance	50	06	24 635 0351	-
Grand Dink Eu2	125	03-04	24 635 0202	00128947	Ludix 50 Elegance	50	07	24 635 0351	-
People	125	99-00	24 635 0182	00123300	Ludix 50 Ep	50	08	24 635 0351	-
People Eu2	125	03	24 635 0182	00123300	Ludix 50 Ep	50	09	24 635 0351	-
People S	125	05	24 635 0192	00128184	Ludix 50 Ep	50	12	24 635 0351	-
People S Dd Eu3	125	07-08	24 635 0192	00128184	Ludix 50 Ep	50	10-11	24 635 0351	-
B&W	150	00	24 635 0202	00128947	Ludix 50 Lc Blaster 10 Zoll	50	05-07	24 635 0351	-
B&W Eu2	150	03-04	24 635 0202	00128947	Ludix 50 Lc Rs Blaster 12 Zoll	50	07	24 635 0351	-
Dink	150	97-98	24 635 0202	00128947	Ludix 50 One 1 Sitzler	50	04	24 635 0351	-
Dink Classic	150	02	24 635 0202	00128947	Ludix 50 One 1 Sitzler	50	05	24 635 0351	-
Dink Classic Eu2	150	03	24 635 0202	00128947	Ludix 50 One 1 Sitzler	50	06	24 635 0351	-
Dink Lx	150	98-00	24 635 0202	00128947	Ludix 50 One 1 Sitzler	50	07	24 635 0351	-
Grand Dink	150	01-02	24 635 0202	00128947	Ludix 50 One 2 Sitzler	50	06-07	24 635 0351	-
Grand Dink Eu2	150	03-04	24 635 0202	00128947	Ludix 50 Pro 2T	50	08-11	24 635 0351	-
People	150	99-00	24 635 0182	00123300	Ludix 50 Snake	50	04	24 635 0351	-
People Euro2	150	03	24 635 0182	00123300	Ludix 50 Snake	50	05	24 635 0351	-
Dink Classic	200	04	24 635 0240	00128039	Ludix 50 Snake	50	06	24 635 0351	-
People S	200	05	24 635 0192	00128184	Ludix 50 Snake	50	07	24 635 0351	-
Grand Dink	250	01-02	24 635 0250	00128937	Ludix 50 Trend 10 Inch	50	04-07	24 635 0351	-
Grand Dink Eu2	250	03-04	24 635 0250	00128937	Geopolis 400 le Evol. Urban Abs	400	10-12	24 635 0122	759735
People S 250I	250	07	24 635 0442	00169230	Geopolis 400 le Executive Abs	400	07-09	24 635 0122	759735
X Citing I	250	06-07	24 635 0442	00169230	Geopolis 400 le Premium	400	07-12	24 635 0122	759735
People S 300I	300	08	24 635 0442	00169230	Geopolis 400 le Rs Premium	400	08-12	24 635 0122	759735
X Citing 300I	300	08	24 635 0442	00169230	Satelis 1 400 le Evol. Urban Abs	400	10-11	24 635 0122	759735
X Citing 300I R	300	08	24 635 0442	00169230	Satelis 1 400 le Executive Abs	400	07-09	24 635 0122	759735
X Citing 300I R	300	09	24 635 0442	00169230	Satelis 1 400 le Premium	400	07-12	24 635 0122	759735
MALAGUTI					Satelis 1 400 le Rs Premium	400	08-12	24 635 0122	759735
Centro 4T	50	08	24 635 0062	48201400	Geopolis 500 Premium	500	08-12	24 635 0122	759735
Centro SL 4T	50	10	24 635 0062	48201400	Satelis 500 Executive Abs	500	07-11	24 635 0122	759735
Ciak Master 4T	50	05-06	24 635 0062	48201400	Satelis 500 Premium	500	06-12	24 635 0122	759735
Madison	125	99-01	24 635 0230	78201900	Satelis 500 Rs Premium	500	08-12	24 635 0122	759735
Madison 3	125	06-09	24 635 0102	48202000	PIAGGIO				
Madison R Restyling	125	02	24 635 0230	78201900	Ape	50	09-17	24 635 0011	199500
Madison R Restyling Eu2	125	03-04	24 635 0230	78201900	Ape	50	09-17	24 635 0013	199500
Phantom Max	125	03	24 635 0230	78201900	Ape	50	09-17	24 635 0312	642204
Madison T	150	99-01	24 635 0230	78201900	Ape	50	09-17	24 635 0362	642205
Madison Rs Restyling	250	04	24 635 0092	48200800	Ape FL - FL2	50	89-95	24 635 0011	199500
Phantom Max	250	04	24 635 0092	48200800	Ape FL - FL2	50	89-95	24 635 0013	199500
Spidermax Gt	500	04-05	24 635 0112	48201100	Ape FL3 Europa	50	96-99	24 635 0011	199500
Spidermax Gt Eu3	500	06	24 635 0112	48201900	Ape FL3 Europa	50	96-99	24 635 0013	199500
Spidermax Rs	500	08	24 635 0122	48202400	Ape Mix 2T	50	98-08	24 635 0011	497651
MBK					Ape Mix 2T	50	98-08	24 635 0013	497651
Ya R Forte (Che-Ita)	50	94-96	24 635 0210	3KJ855600000	Ape Rst Mix	50	99-03	24 635 0011	199500
Ye Evolis (Ita)	50	92-93	24 635 0210	3KJ855600000	Ape Rst Mix	50	99-03	24 635 0013	199500
Ye Evolis (Ita)	50	94-95	24 635 0210	3KJ855600000	Ape Tm P	50	85-89	24 635 0063	199495
Yh Flipper	50	01-02	24 635 0210	3KJ855600000	Diesis	50	01	24 635 0072	830296
Yh Flipper	50	98	24 635 0210	3KJ855600000	Fly 2T	50	05-07	24 635 0072	584525
Yh Flipper Catalitico	50	99-00	24 635 0210	3KJ855600000	Fly 2T	50	05-07	24 635 0072	639865
Ym Fizz (Ita)	50	94-95	24 635 0210	3KJ855600000	Fly 2T	50	05-07	24 635 0072	830296
Yn R Ovetto (Che-Ita)	50	97-01	24 635 0210	3KJ855600000	Fly 2T	50	10-11	24 635 0072	639865
Yq Nitro	50	01-02	24 635 0210	3KJ855600000	Fly 4T	50	05-07	24 635 0062	969228
Yq Nitro (Ita)	50	97-98	24 635 0210	3KJ855600000	Fly 4T & 25-30 Km/H	50	08-11	24 635 0062	969228
Yq Nitro (Ita)	50	99-00	24 635 0210	3KJ855600000	Fly 4T 2V	50	13-15	24 635 0062	969228
Xn Doodo	125	00-01	24 635 0230	5DS855100000	Fly 4T 2V 25-30Km-H	50	12-14	24 635 0062	969228
Xq Thunder	125	01-02	24 635 0230	5DS855100000	Fly 4T 4V	50	12-13	24 635 0082	833632
Yp E Skyliner	125	03	24 635 0230	5DS855100000	Fly 4T Motore Chn	50	06-07	24 635 0062	969228



STATORI - VOLANI

STATORS - MAGNETOS

Modello - Model	Cc	Anno Year	Codice RMS RMS Code	Riferimento Originale Oem Number	Modello - Model	Cc	Anno Year	Codice RMS RMS Code	Riferimento Originale Oem Number
Free Delivery	50	00-01	24 635 0042	830294	Vespa Sprint 4T 4V	50	14-17	24 635 0082	833632
Free FL	50	95-02	24 635 0042	830294	Zip	50	00-04	24 635 0072	584525
Liberty	50	97-05	24 635 0042	830294	Zip	50	92-93	24 635 0042	830294
Liberty 2T	50	06	24 635 0072	639865	Zip	50	95-96	24 635 0042	830294
Liberty 2T	50	07-08	24 635 0072	639865	Zip 2T	50	08-13	24 635 0072	639865
Liberty 2T Rst	50	04	24 635 0072	830296	Zip 4T	50	06-13	24 635 0062	969228
Liberty 2T Sport	50	06	24 635 0072	584525	Zip 4T	50	00-05	24 635 0062	969228
Liberty 2T Sport	50	06	24 635 0072	639865	Zip 4T 25Km-H	50	06-16	24 635 0062	969228
Liberty 2T Sport	50	06	24 635 0072	830296	Zip Fast Raider Rst	50	96-97	24 635 0042	830294
Liberty 2T Sport	50	07-08	24 635 0072	639865	Zip Rst	50	96-99	24 635 0042	830294
Liberty 4T	50	05-08	24 635 0062	969228	Zip Sp	50	01-04	24 635 0072	830296
Liberty 4T	50	00-02	24 635 0062	969228	Zip Sp	50	96-00	24 635 0042	830294
Liberty 4T Delivery - Single	50	10-14	24 635 0062	969228	Zip Sp Eu2	50	06-13	24 635 0072	639865
Liberty 4T Delivery Tnt	50	09	24 635 0062	969228	Skr City	80	99	24 635 0042	830294
Liberty 4T Ptt - Double - Nexive	50	09-15	24 635 0062	969228	Fly 4T	100	08-14	24 635 0062	969228
Liberty 4T Ptt (Deu)	50	07-12	24 635 0062	969228	Fly 4T	100	06-07	24 635 0062	969228
Liberty 4T Rst	50	04	24 635 0062	969228	Free	100	02-03	24 635 0062	969228
Liberty 4T Sport	50	06	24 635 0062	969228	Zip 4T	100	06-10	24 635 0062	969228
Liberty 4T Sport	50	07-08	24 635 0062	969228	Beverly	125	01-03	24 635 0142	828135
Liberty Moc 2T & Elle	50	09-13	24 635 0072	639865	Beverly Eu3	125	07-08	24 635 0321	639727
Liberty Moc 4T & Elle	50	09-16	24 635 0062	969228	Beverly Eu3 Mic	125	07	24 635 0321	639727
Liberty Ptt Eu2	50	04-05	24 635 0072	830296	Beverly Eu3 Sport	125	07-08	24 635 0321	639727
Nrg	50	94-96	24 635 0042	830294	Beverly Rst	125	04-05	24 635 0142	828135
Nrg Extreme	50	99-00	24 635 0042	830294	Beverly Rst	125	05-07	24 635 0321	639727
Nrg Mc3	50	01-04	24 635 0042	830294	Beverly Tourer Eu3	125	07-10	24 635 0321	639727
Nrg Mc3	50	01-04	24 635 0072	584525	Carnaby	125	07-10	24 635 0321	639727
Nrg Power Dd	50	05	24 635 0072	584525	Fly 4T 3V le E3 Dt	125	13-15	24 635 0372	B016543
Nrg Power Dd	50	05	24 635 0072	639865	Fly 4T 3V le Eu3 Lem	125	12-13	24 635 0372	B016543
Nrg Power Dd	50	05	24 635 0072	830296	Hexagon Gtx	125	00	24 635 0142	833697
Nrg Power Dd	50	06	24 635 0072	584525	Liberty	125	01-02	24 635 0142	833697
Nrg Power Dd	50	07-15	24 635 0072	639865	Liberty 4T 2V le Ptt - Ita	125	12-13	24 635 0392	643166
Nrg Power Dd Serie Speciale	50	07-12	24 635 0072	639865	Liberty 4T 3V le E3	125	13-14	24 635 0372	B016543
Nrg Power Dt	50	06	24 635 0072	584525	Liberty Rst	125	04-05	24 635 0142	828135
Nrg Power Dt	50	07-15	24 635 0072	639865	Mp3	125	06-08	24 635 0321	639727
Nrg Power Dt Serie Speciale	50	07-08	24 635 0072	639865	Mp3 Ibrido	125	09-10	24 635 0102	58070R
Nrg Rst Mc2	50	96-98	24 635 0042	830294	Mp3 le	125	08-09	24 635 0102	58070R
Ntt	50	95-96	24 635 0042	830294	Skipper 4T	125	00-02	24 635 0142	833697
Quartz	50	92-96	24 635 0042	830294	Super Hexagon Gtx 12	125	01-02	24 635 0142	833697
Sfera	50	91-93	24 635 0042	830294	Vespa Et4	125	99-02	24 635 0142	833697
Sfera Rst	50	95-97	24 635 0042	830294	Vespa FL	125	89-90	24 635 0063	199495
Typhoon	50	01-04	24 635 0072	830296	Vespa Granturismo	125	03-05	24 635 0142	833697
Typhoon	50	05-08	24 635 0072	584525	Vespa Granturismo Eu3	125	06-07	24 635 0321	639727
Typhoon	50	05-08	24 635 0072	639865	Vespa Gts Eu3	125	07-12	24 635 0321	639727
Typhoon	50	09-11	24 635 0072	639865	Vespa Gtv	125	06-08	24 635 0321	639727
Typhoon 2T Eu2	50	10-16	24 635 0072	639865	Vespa Gtv 4T Navy Eu3	125	08	24 635 0321	639727
Typhoon 2T Eu3 Ch	50	11	24 635 0072	639865	Vespa Lx 4T 3V le - Touring	125	12-13	24 635 0372	B016543
Vespa Et2	50	97-05	24 635 0042	830294	Vespa Pk XL	125	86-89	24 635 0063	199495
Vespa Et2	50	97-05	24 635 0072	639865	Vespa Px	125	11-16	24 635 0292	642427
Vespa Et4	50	00-05	24 635 0062	969228	Vespa S 4T 3V le	125	12	24 635 0372	B016543
Vespa FL	50	90	24 635 0063	199495	X Evo	125	07-16	24 635 0321	639727
Vespa Lx 2T	50	09-13	24 635 0072	639865	X7 Eu3	125	08	24 635 0321	639727
Vespa Lx 2T	50	05-08	24 635 0072	639865	X8	125	04	24 635 0142	828135
Vespa Lx 2T Touring & 30Km	50	10-13	24 635 0072	639865	X8 Premium Eu2	125	06	24 635 0321	639727
Vespa Lx 4T	50	05-09	24 635 0062	969228	X8 Premium Eu3	125	06-07	24 635 0321	639727
Vespa Lx 4T-4V	50	09-13	24 635 0082	833632	X9	125	01-02	24 635 0142	833697
Vespa Lx 4T-4V Touring	50	10-13	24 635 0082	833632	X9 Evolution	125	03	24 635 0142	827902
Vespa Lxv 2T	50	06-09	24 635 0072	639865	X9 Evolution	125	03	24 635 0142	828135
Vespa Lxv 2T Navy	50	08	24 635 0072	639865	X9 Evolution Eu3	125	07	24 635 0321	639727
Vespa N	50	89-90	24 635 0063	199495	Zip	125	00-02	24 635 0142	833697
Vespa Pk	50	82-84	24 635 0011	199500	Liberty 4T 3V Lem	150	13-14	24 635 0372	B016543
Vespa Pk	50	82-84	24 635 0013	199500	Vespa Lt 4T 3V le	150	14	24 635 0372	B016543
Vespa Pk	50	82-84	24 635 0063	199495	Vespa Lx 4T 3V le - Touring	150	12-13	24 635 0372	B016543
Vespa Pk XI	50	85-88	24 635 0063	199495	Vespa Px	150	11-17	24 635 0292	642427
Vespa Pk XI Rush	50	88-89	24 635 0063	199495	X9 Amalfi	180	00-03	24 635 0142	828135
Vespa Primavera 2T	50	13-17	24 635 0072	639865	Carnaby	200	07-08	24 635 0321	639727
Vespa Primavera 4T 2V 25 Km/H	50	14-16	24 635 0062	969228	Liberty Rst	200	04	24 635 0142	828135
Vespa Primavera 4T-4V	50	13-17	24 635 0082	833632	X9	200	02-03	24 635 0142	827902
Vespa S 2T & College	50	07-12	24 635 0072	639865	X9	200	02-03	24 635 0142	828135
Vespa S 4T-4V & College	50	08-12	24 635 0082	833632	X9 Evolution	200	03	24 635 0142	827902
Vespa Sprint 2T 2V	50	14-16	24 635 0072	639865	X9 Evolution	200	03	24 635 0142	828135
Vespa Sprint 4T 2V 25 Km/H	50	14-16	24 635 0062	969228	Beverly	250	06-07	24 635 0092	58048R



Modello - Model	Cc	Anno Year	Codice RMS RMS Code	Riferimento Originale Oem Number	Modello - Model	Cc	Anno Year	Codice RMS RMS Code	Riferimento Originale Oem Number
Beverly Cruiser	250	07-09	24 635 0102	58070R	SYM				
Beverly Eu3 Mic	250	07	24 635 0102	58070R	Hd Eu2	125	03-04	24 635 0260	31120H9A001
Beverly Ie Eu3	250	06-08	24 635 0102	58070R	Hd Euro3	125	07-08	24 635 0260	31120H9A001
Beverly Rst	250	04-05	24 635 0092	58048R	Hd Evo	125	05-06	24 635 0260	31120H9A001
Beverly Sport	250	06-08	24 635 0102	58070R	Hd Evo Eu3	125	07-08	24 635 0260	31120H9A001
Beverly Tourer Eu3	250	07-09	24 635 0102	58070R	Hd Evo Eu3	125	10-11	24 635 0260	31120H9A001
Carnaby	250	08	24 635 0102	58070R	Hd Evo Tamburo Eu3	125	08-09	24 635 0260	31120H9A001
Mp3	250	06-08	24 635 0102	58070R	Hd2	125	11	24 635 0260	31120H9A000
Mp3 Lt	250	08-09	24 635 0102	58070R	Hd2	125	14	24 635 0260	31120H9A000
Mp3 Mic	250	08-09	24 635 0102	58070R	Joyride	125	01-02	24 635 0260	31120H9A000
Vespa Gt 60 Eu3	250	06-07	24 635 0102	58070R	Joyride Eu2	125	03-04	24 635 0260	31120H9A001
Vespa Gts	250	05-16	24 635 0102	58070R	Joyride Eu2	125	05-06	24 635 0260	31120H9A001
Vespa Gts Abs	250	05-12	24 635 0102	58070R	Joyride Eu3	125	07	24 635 0260	31120H9A001
Vespa Gtv	250	06-09	24 635 0102	58070R	Joyride Evo	125	10	24 635 0260	31120H9A001
Vespa Gtv 4T Navy Eu3	250	07	24 635 0102	58070R	Joyride Evo	125	13	24 635 0260	31120H9A001
X Evo	250	07-16	24 635 0102	58070R	Joyride Evo	125	14	24 635 0260	31120H9A001
X7 Eu3	250	08	24 635 0102	58070R	Joyride Evo	125	09-10	24 635 0260	31120H9A001
X8 Eu3	250	05-08	24 635 0102	58112R	Joyride	150	01-02	24 635 0260	31120H9A000
X9 Evolution	250	04	24 635 0092	58449S	Hd Eu2	200	03-04	24 635 0260	31120H9A001
X9 Evolution	250	06	24 635 0092	58048R	Hd Evo Eu2	200	05-06	24 635 0260	31120H9A001
Beverly Tourer Eu3	300	09-10	24 635 0102	638848	Joyride	200	03	24 635 0260	31120H9A001
Carnaby Cruiser	300	09-12	24 635 0102	58070R	Joyride Eu2	200	03-04	24 635 0260	31120H9A001
Vespa Gtv Via Montenapoleone	300	10	24 635 0102	58070R	Joyride Eu2	200	05-06	24 635 0260	31120H9A001
Beverly Eu3	400	06-07	24 635 0112	58080R	YAMAHA				
Beverly Tourer Eu3	400	08-10	24 635 0122	58108R	Ya R Axis	50	95-96	24 635 0210	3KJ855600000
Mp3	400	07-08	24 635 0122	58108R	Yh Why	50	01-02	24 635 0210	3KJ855600000
Mp3 Ie Lt - Mp3 Ie Lt Sport	400	08-10	24 635 0122	58108R	Yh Why	50	98	24 635 0210	3KJ855600000
Mp3 Ie Lt Touring	400	11	24 635 0122	58108R	Yh Why Eu1	50	99-00	24 635 0210	3KJ855600000
Mp3 Mic	400	08-10	24 635 0122	58108R	Ym Breeze	50	94-95	24 635 0210	3KJ855600000
Mp3 RL Touring	400	11	24 635 0122	58108R	Yn R Neo's	50	97-01	24 635 0210	3KJ855600000
X Evo	400	07-11	24 635 0112	58080R	Yq Aerox	50	01-02	24 635 0210	3KJ855600000
X8 Eu3	400	06-08	24 635 0112	58080R	Yq Aerox	50	97-98	24 635 0210	3KJ855600000
Beverly	500	02-04	24 635 0112	82736R	Yq Aerox R	50	99	24 635 0210	3KJ855600000
Beverly	500	05-06	24 635 0112	58080R	Yq Aerox R	50	99-00	24 635 0210	3KJ855600000
Beverly Cruiser	500	07-12	24 635 0122	58108R	Xn Teo's	125	00	24 635 0230	5DS855100000
Beverly Eu3	500	06-08	24 635 0112	58080R	Xq Maxster	125	01-02	24 635 0230	5DS855100000
Mp3 Lt Sport - Business	500	11-13	24 635 0122	58108R	Yp125 Majesty	125	01-02	24 635 0230	5DS855100000
Mp3 RL Sport - Business	500	11-12	24 635 0122	58108R	Yp125 Majesty	125	98-00	24 635 0230	5DS855100000
X9	500	01-02	24 635 0112	58039R	Yp125e Majesty	125	03-05	24 635 0230	5DS855100000
X9 Evolution	500	03-05	24 635 0112	82736R	Yp125e Majesty	125	06	24 635 0230	5DSH55100000
X9 Evolution	500	06-07	24 635 0112	58080R	Yp125e Majesty	125	07	24 635 0230	5DSH55100000
X9 Evolution Abs	500	06-07	24 635 0112	58080R	Yp125e Majesty	125	08	24 635 0230	5DSH55100000
PIAGGIO VINTAGE					Yp125e Majesty	125	09	24 635 0230	5DSH55100000
Vespa 50 FL	50	90	24 635 0071	1791665	Xn Teo's	150	01-02	24 635 0230	5DS855100000
Vespa Pk 50	50	82-84	24 635 0071	1791665	Xq Maxster	150	01-02	24 635 0230	5DS855100000
Vespa Pk 50 Automatica	50	84-89	24 635 0071	1791665	Yp150 Majesty	150	00	24 635 0230	5DS855100000
Vespa Pk 50 Hp	50	91-99	24 635 0071	1791665	Yp150 Majesty	150	01-02	24 635 0230	5DS855100000
Vespa Pk 50 Rush	50	88	24 635 0071	1791665	Yp180e Majesty	180	03-06	24 635 0230	5DS855100000
Vespa Pk 50 Rush Elestart	50	89	24 635 0071	1791665	Yp400 Majesty	400	04-05	24 635 0410	5RU814100000
Vespa Pk 50 XL Rush	50	88-89	24 635 0071	1791665	Yp400 Majesty	400	06	24 635 0410	5RU814100000
Vespa 125	125	58	24 635 0433	150776	Yp400 Majesty	400	07-08	24 635 0410	5RU814100000
Vespa 125	125	60	24 635 0433	150776	Yp400 Majesty	400	09-11	24 635 0420	34B814100000
Vespa Et3 125	125	76-83	24 635 0220	186974	Yp400 Majesty Abs	400	07	24 635 0410	5RU814100000
Vespa Gt 125	125	66-73	24 635 0433	150776	Yp400 Majesty Abs	400	08	24 635 0410	5RU814100000
Vespa Gtr 125	125	69-78	24 635 0433	150776	Yp400 Majesty Abs	400	09-11	24 635 0420	34B814100000
Vespa P 125 E	125	81	24 635 0073	217866	Xp T-Max	500	01-03	24 635 0400	5GJ814100100
Vespa Px 125	125	11-16	24 635 0292	642427	Xp T-Max	500	04-05	24 635 0330	5VU814100200
Vespa Px 125	125	11-16	24 635 0302	642426	Xp T-Max	500	06	24 635 0330	5VU814100000
Vespa Px 125 E Arcobaleno	125	83	24 635 0073	217866	Xp T-Max	500	07	24 635 0330	5VU814100100
Vespa Super 125	125	66-68	24 635 0433	150776	Xp T-Max Abs	500	05	24 635 0330	5VU814100000
Vespa Ts 125	125	75-78	24 635 0433	150776	Xp T-Max Abs	500	06	24 635 0330	5VU814100000
Vespa 150	150	59-60	24 635 0433	150776	Xp T-Max Abs	500	07	24 635 0330	5VU814100100
Vespa 150	150	61-62	24 635 0433	150776	Xp T-Max Black Max	500	06	24 635 0330	5VU814100000
Vespa Px 150	150	11-16	24 635 0292	642427	Xp T-Max Black Max-Night Max	500	07	24 635 0330	5VU814100100
Vespa Px 150	150	11-16	24 635 0302	642426					
Vespa Px 150 E	150	81	24 635 0073	217866					
Vespa Px 150 E Arcobaleno	150	83	24 635 0073	217866					
Vespa Sprint 150	150	65-74	24 635 0433	150776					
Vespa Super 150	150	65-79	24 635 0433	150776					
Vespa Px 200 E	200	82	24 635 0073	217866					
Vespa Px 200 E Arcobaleno	200	83-84	24 635 0073	217866					



STATORI - VOLANI

STATORS - MAGNETOS

24 636 0042



GILERA - PIAGGIO
(R.O. 830294+584526)



24 636 0052



APRILIA - DERBI
(R.O. 82852R)



24 636 0062



APRILIA - DERBI - PIAGGIO
(R.O. 969228+969243)



24 636 0072



APRILIA - DERBI - GILERA - PIAGGIO
(R.O. 830296+584526)



24 636 0092



DERBI - GILERA - PIAGGIO
(R.O. 58048R+58049R)



24 636 0112



APRILIA - GILERA - PIAGGIO
(R.O. 58080R+58040R)



24 636 0122



APRILIA - GILERA - PIAGGIO
(R.O. 58108R+58109R)



24 635 0302



PIAGGIO
(R.O. 642426)



24 635 0312



PIAGGIO
(R.O. 642204)



24 636 0902



PEUGEOT
(R.O. 768349)



24 636 0912



PIAGGIO
(R.O. B018107)



24 636 0922



KYMCO
(R.O. 00131155+00131154-31100LKF5E00)



24 636 0932



KYMCO
(R.O. 00131071+131070-31100LEA7E00)



24 636 0942



PIAGGIO
(R.O. 643166+643167)





24 617 0010 

GILERA - PIAGGIO
(R.O. 498865)



24 617 0030 

MBK - YAMAHA



24 617 0023 

PIAGGIO
(R.O. 196549)



24 617 0031  **NEW**

YAMAHA - MBK
(R.O. 2JA85580M000)



12 183 0310 

TAPPO GOMMA FERITOIA VOLANO
FLYWHEEL SLOT RUBBER PLUG
PIAGGIO 200: Vespa Pe VSX
(R.O. 133652)



12 183 0320 

TAPPO GOMMA FERITOIA VOLANO
FLYWHEEL SLOT RUBBER PLUG
PIAGGIO 50-90: Vespa Primavera Et3
V5A1-V5B1-V5B2-V5SA1-V9A1-VMA2-VMB1
(R.O. 110162)



12 165 0073 

TAPPO VOLANO - *FLYWHEEL CAP*
PIAGGIO 125-150-200: Vespa Px
VNX-VLX-VSX
• Cosa VNR-VLR-VSR
(R.O. 226990)





STATORI - VOLANI

STATORS - MAGNETOS

Modello - Model	Cc	Anno Year	Codice RMS RMS Code	Riferimento Originale Oem Number	Modello - Model	Cc	Anno Year	Codice RMS RMS Code	Riferimento Originale Oem Number
APRILIA					Runner Sp	50	02-04	24 636 0072	830296
Mojito Custom 2T Mot. Piaggio	50	04-10	24 636 0072	584526	Runner Sp	50	05-06	24 636 0072	639865
Rs	50	06-10	24 636 0052	847065	Runner Sp	50	07	24 636 0072	639865
Rs4	50	11-13	24 636 0052	82852R	Runner Sp	50	10-12	24 636 0072	639865
Rs4 Replica	50	14-16	24 636 0052	82852R	Runner Sp Special Edition	50	07	24 636 0072	639865
Scarabeo 4T	50	02-06	24 636 0062	AP8551076	Runner Sp St & Simoncelli	50	08-09	24 636 0072	639865
Scarabeo 4T Restyling Eu3	50	06-09	24 636 0062	969228	Stalker	50	05-06	24 636 0072	639865
Sport City One 2T	50	08-11	24 636 0072	584526	Stalker	50	07-08	24 636 0072	639865
Sport City One 4T	50	08-10	24 636 0062	969228	Stalker	50	09-11	24 636 0072	639865
Sr Iniezione e Carburatore	50	14	24 636 0072	584526	Stalker	50	97-04	24 636 0042	830294
Sr Motard 2T	50	12-14	24 636 0072	584526	Stalker	50	97-04	24 636 0072	584525
Sr R Factory le e Carburatore	50	10-14	24 636 0072	584526	Stalker Naked	50	08	24 636 0072	639865
Sr R, R Factory	50	04-09	24 636 0072	584526	Stalker Special Edition	50	07-08	24 636 0072	639865
Scarabeo 4T	100	14	24 636 0062	969228	Storm	50	94-95	24 636 0042	830294
Scarabeo 4T	100	01-05	24 636 0062	AP8551076	Storm Eu2	50	07	24 636 0072	639865
Scarabeo 4T	100	10-12	24 636 0062	969228	Typhoon	50	94-97	24 636 0042	830294
Scarabeo 4T Net	100	09	24 636 0062	969228	Typhoon X	50	98-99	24 636 0042	830294
Scarabeo 4T Net Eu3	100	10	24 636 0062	969228	Typhoon Xr	50	00	24 636 0042	830294
Scarabeo 4T Restyling	100	06-09	24 636 0062	969228	Oregon	250	06-10	24 636 0092	58049R
Atlantic Sprint	400	05-08	24 636 0112	AP8560100	Fuoco 4T-4V le E3 Lt	500	13-14	24 636 0122	58108R
Scarabeo Light	400	06-08	24 636 0112	58080R	Fuoco Eu3	500	07-13	24 636 0122	58108R
Scarabeo Light	400	06-08	24 636 0122	58108R	Nexus	500	03-05	24 636 0112	82736R
Atlantic	500	01-04	24 636 0112	AP8560100	Nexus Eu3	500	06-08	24 636 0112	58080R
Atlantic Sprint	500	05-08	24 636 0112	AP8560100	Nexus Eu3	500	09-11	24 636 0112	58080R
Scarabeo	500	03-06	24 636 0112	AP8560100	Nexus Sp Eu3	500	06-07	24 636 0112	58080R
Scarabeo Light	500	06-08	24 636 0112	58080R	KYMCO				
Scarabeo Light	500	06-08	24 636 0122	58108R	Downtown I	200	10	24 636 0932	00131071
DERBI					People Gti	200	10	24 636 0932	00131071
Atlantis 2T	50	10	24 636 0072	639865	People Gti	200	14	24 636 0932	00131071
Atlantis 2T Eu2	50	07-09	24 636 0072	639865	Downtown 300l	300	09	24 636 0932	00131071
Atlantis 4T Eu2	50	07	24 636 0062	969243	Downtown Abs	300	10	24 636 0932	00131071
Atlantis 50-100 4T	50	04-06	24 636 0062	969243	Downtown Abs I	300	11-16	24 636 0932	00131071
Atlantis O2	50	02	24 636 0072	827849	Downtown I	300	11	24 636 0932	00131071
Atlantis O2 Bullet	50	03-05	24 636 0072	830296	People Gti	300	10	24 636 0932	00131071
Atlantis O2 City	50	03-06	24 636 0072	830296	People Gti	300	11	24 636 0932	00131071
Atlantis O2 Red Bullet	50	03	24 636 0072	830296	People Gti	300	14	24 636 0932	00131071
Atlantis O2 Two Chic	50	05	24 636 0072	830296	People Gti Abs	300	12	24 636 0932	00131071
Boulevard 2T	50	09-14	24 636 0072	639865	People Gti Abs	300	14	24 636 0932	00131071
Boulevard 4T Eu2 25 Km/H	50	09	24 636 0062	969243	People Gti Abs E4	300	16	24 636 0932	00131071
Gp1	50	03	24 636 0072	830296	X Citing I	400	13	24 636 0922	00131154
Gp1	50	01-02	24 636 0072	830296	X Citing I	400	15	24 636 0922	00131154
Gp1 E2	50	03	24 636 0072	830296	X Citing I Abs	400	14	24 636 0922	00131154
Gp1 Eu2	50	05	24 636 0072	830296	X Citing I Abs	400	15	24 636 0922	00131154
Gp1 Open Eu2	50	06-09	24 636 0072	639865	X Citing I Abs E4	400	16	24 636 0922	00131154
Gp1 Race Eu2	50	05-07	24 636 0072	830296	PEUGEOT				
Gpr 2T	50	13	24 636 0052	82852R	Ludix 50 Classic 1 Seater	50	04	24 636 0902	768349
Gpr 2T Eu2	50	09-10	24 636 0052	82852R	Ludix 50 Classic 1 Seater	50	05	24 636 0902	768349
Gpr Nude & Gpr Nude Tuning	50	06-08	24 636 0052	82852R	Ludix 50 Classic 1 Seater	50	06	24 636 0902	768349
Gpr Nude Sport	50	06	24 636 0052	847065	Ludix 50 Classic 1 Seater	50	07	24 636 0902	768349
Gpr R Eu2 - Gpr Replica Eu2	50	08	24 636 0052	82852R	Ludix 50 Classic 2 Seater	50	06-07	24 636 0902	768349
Gpr Racing Eu2	50	06	24 636 0052	847065	Ludix 50 Elegance	50	04	24 636 0902	768349
Gpr Replica & Gpr R Eu2	50	06	24 636 0052	847065	Ludix 50 Elegance	50	05	24 636 0902	768349
Gpr Replica 2T Malossi	50	07	24 636 0052	82852R	Ludix 50 Elegance	50	06	24 636 0902	768349
Gpr Replica Pesek Eu2	50	07	24 636 0052	82852R	Ludix 50 Elegance	50	07	24 636 0902	768349
Senda Hyp Drd Evo Lim. Edit. Eu2	50	08	24 636 0052	82852R	Ludix 50 Ep	50	08	24 636 0902	768349
Senda R Drd Pro Eu2	50	05-11	24 636 0052	82852R	Ludix 50 Ep	50	09	24 636 0902	768349
Senda Sm Drd Pro Eu2	50	05-11	24 636 0052	82852R	Ludix 50 Ep	50	12	24 636 0902	768349
Senda Sm Drd Pro Eu2 2Ver	50	05-08	24 636 0052	82852R	Ludix 50 Ep	50	10-11	24 636 0902	768349
Sonar 2T	50	09	24 636 0072	639865	Ludix 50 Lc Blaster 10 Zoll	50	05-07	24 636 0902	768349
Variant Sport 2T	50	12	24 636 0072	639865	Ludix 50 Lc Rs Blaster 12 Zoll	50	07	24 636 0902	768349
Atlantis 4T	100	04-06	24 636 0062	969243	Ludix 50 One 1 Sitzer	50	04	24 636 0902	768349
Boulevard 4T	100	10-11	24 636 0062	969243	Ludix 50 One 1 Sitzer	50	05	24 636 0902	768349
Gp1	250	06-07	24 636 0092	58048R	Ludix 50 One 1 Sitzer	50	06	24 636 0902	768349
GILERA					Ludix 50 One 1 Sitzer	50	07	24 636 0902	768349
Dna	50	00-02	24 636 0072	830296	Ludix 50 One 2 Sitzer	50	06-07	24 636 0902	768349
Dna	50	05-07	24 636 0072	639865	Ludix 50 Pro 2T	50	08-11	24 636 0902	768349
Dna Gp Experience	50	03-04	24 636 0072	830296	Ludix 50 Snake	50	04	24 636 0902	768349
Easy Moving	50	95-96	24 636 0042	830294	Ludix 50 Snake	50	05	24 636 0902	768349
Ice	50	01-05	24 636 0072	830296	Ludix 50 Snake	50	06	24 636 0902	768349
Runner	50	97-00	24 636 0042	830294	Ludix 50 Snake	50	07	24 636 0902	768349
Runner Poggiali	50	02	24 636 0072	830296	Ludix 50 Trend 10 Inch	50	04-07	24 636 0902	768349



Modello - Model	Cc	Anno Year	Codice RMS RMS Code	Riferimento Originale Oem Number	Modello - Model	Cc	Anno Year	Codice RMS RMS Code	Riferimento Originale Oem Number
PIAGGIO					Zip Rst	50	96-99	24 636 0042	830294
Diesis	50	01	24 636 0072	830296	Zip Sp	50	01-04	24 636 0072	830296
Fly 2T	50	05-07	24 636 0072	639865	Zip Sp	50	96-00	24 636 0042	830294
Fly 2T	50	05-07	24 636 0072	830296	Zip Sp Eu2	50	06-13	24 636 0072	639865
Fly 2T	50	10-11	24 636 0072	639865	Skr City	80	99	24 636 0042	830294
Fly 4T	50	05-07	24 636 0062	969228	Fly 4T	100	06-07	24 636 0062	969228
Fly 4T & 25-30 Km/H	50	08-11	24 636 0062	969228	Fly 4T	100	08-14	24 636 0062	969228
Fly 4T 2V	50	13-15	24 636 0062	969228	Free	100	02-03	24 636 0062	969228
Fly 4T 2V 25-30Km-H	50	12-17	24 636 0062	969228	Zip 4T	100	06-10	24 636 0062	969228
Fly 4T Motore Chn	50	06-07	24 636 0062	969228	Fly 4T 3V le E3 Dt	125	13-15	24 636 0912	B018107
Free Delivery	50	00-01	24 636 0042	830294	Fly 4T 3V le Eu3 Lem	125	12-13	24 636 0912	B018107
Free FL	50	95-02	24 636 0042	830294	Liberty 4T 2V le Ptt - Ita	125	12-13	24 636 0942	643167
Liberty	50	97-05	24 636 0042	830294	Liberty 4T 3V le E3	125	13-14	24 636 0912	B018107
Liberty 2T	50	06	24 636 0072	639865	Vespa Lx 4T 3V le - Touring	125	12-13	24 636 0912	B018107
Liberty 2T	50	07-08	24 636 0072	639865	Vespa S 4T 3V le	125	12	24 636 0912	B018107
Liberty 2T Rst	50	04	24 636 0072	830296	Liberty 4T 3V Lem	150	13-14	24 636 0912	B018107
Liberty 2T Sport	50	06	24 636 0072	639865	Vespa Lt 4T 3V le	150	14	24 636 0912	B018107
Liberty 2T Sport	50	06	24 636 0072	830296	Vespa Lx 4T 3V le - Touring	150	12-13	24 636 0912	B018107
Liberty 2T Sport	50	07-08	24 636 0072	639865	Beverly	250	06-07	24 636 0092	58049R
Liberty 4T	50	00-02	24 636 0062	969228	Beverly Rst	250	04-05	24 636 0092	58049R
Liberty 4T	50	05-08	24 636 0062	969228	X9 Evolution	250	04	24 636 0092	58049R
Liberty 4T Delivery - Single	50	10-14	24 636 0062	969228	X9 Evolution	250	06	24 636 0092	58049R
Liberty 4T Delivery Tnt	50	09	24 636 0062	969228	Beverly Eu3	400	06-07	24 636 0112	58040R
Liberty 4T Ptt - Double - Nexive	50	09-17	24 636 0062	969228	Beverly Tourer Eu3	400	08-10	24 636 0122	58108R
Liberty 4T Ptt (Deu)	50	07-12	24 636 0062	969228	Mp3	400	07-08	24 636 0122	58108R
Liberty 4T Rst	50	04	24 636 0062	969228	Mp3 le Lt - Mp3 le Lt Sport	400	08-10	24 636 0122	58108R
Liberty 4T Sport	50	06	24 636 0062	969228	Mp3 le Lt Touring	400	11	24 636 0122	58108R
Liberty 4T Sport	50	07-08	24 636 0062	969228	Mp3 Mic	400	08-10	24 636 0122	58108R
Liberty Moc 2T & Elle	50	09-13	24 636 0072	639865	Mp3 RL Touring	400	11	24 636 0122	58108R
Liberty Moc 4T & Elle	50	09-16	24 636 0062	969228	Beverly	500	02-04	24 636 0112	58040R
Liberty Ptt Eu2	50	04-05	24 636 0072	830296	Beverly	500	05-06	24 636 0112	58040R
Nrg	50	94-96	24 636 0042	830294	Beverly Cruiser	500	07-12	24 636 0122	58108R
Nrg Extreme	50	99-00	24 636 0042	830294	Beverly Eu3	500	06-08	24 636 0112	58040R
Nrg Mc3	50	01-04	24 636 0042	830294	Mp3 Lt Sport - Business	500	11-13	24 636 0122	58108R
Nrg Power Dd	50	05	24 636 0072	639865	Mp3 Rl Sport - Business	500	11-12	24 636 0122	58108R
Nrg Power Dd	50	05	24 636 0072	830296	X9	500	01-02	24 636 0112	58040R
Nrg Power Dd	50	07-17	24 636 0072	639865	X9 Evolution	500	03-05	24 636 0112	58040R
Nrg Power Dd Serie Speciale	50	07-12	24 636 0072	639865	X9 Evolution	500	06-07	24 636 0112	58040R
Nrg Power Dt	50	07-15	24 636 0072	639865	X9 Evolution Abs	500	06-07	24 636 0112	58040R
Nrg Power Dt Serie Speciale	50	07-08	24 636 0072	639865					
Nrg Rst Mc2	50	96-98	24 636 0042	830294					
Ntt	50	95-96	24 636 0042	830294					
Quartz	50	92-96	24 636 0042	830294					
Sfera	50	91-93	24 636 0042	830294					
Sfera Rst	50	95-97	24 636 0042	830294					
Typhoon	50	01-04	24 636 0072	830296					
Typhoon	50	05-08	24 636 0072	639865					
Typhoon	50	09-11	24 636 0072	639865					
Typhoon 2T Eu2	50	10-16	24 636 0072	639865					
Typhoon 2T Eu3 Ch	50	11	24 636 0072	639865					
Vespa Et2	50	97-05	24 636 0042	830294					
Vespa Et2	50	97-05	24 636 0072	639865					
Vespa Et4	50	00-05	24 636 0062	969228					
Vespa Lx 2T	50	05-08	24 636 0072	639865					
Vespa Lx 2T	50	09-13	24 636 0072	639865					
Vespa Lx 2T Touring & 30Km	50	10-13	24 636 0072	639865					
Vespa Lx 4T	50	05-09	24 636 0062	969228					
Vespa Lxv 2T	50	06-09	24 636 0072	639865					
Vespa Lxv 2T Navy	50	08	24 636 0072	639865					
Vespa Primavera 2T	50	13-17	24 636 0072	639865					
Vespa Primavera 4T 2V 25 Km/H	50	14-17	24 636 0062	969228					
Vespa S 2T & College	50	07-12	24 636 0072	639865					
Vespa Sprint 2T 2V	50	14-17	24 636 0072	639865					
Vespa Sprint 4T 2V 25 Km/H	50	14-17	24 636 0062	969228					
Zip	50	92-93	24 636 0042	830294					
Zip	50	95-96	24 636 0042	830294					
Zip 2T	50	08-13	24 636 0072	639865					
Zip 4T	50	00-05	24 636 0062	969228					
Zip 4T	50	06-13	24 636 0062	969228					
Zip 4T 25Km-H	50	06-16	24 636 0062	969228					
Zip Fast Raider Rst	50	96-97	24 636 0042	830294					



RMS
YOUR BEST PARTNER

▶ **QUADRETTI
AVVIAMENTO**

IGNITION SWITCHES KIT

▶ **SERRATURE**

CYLINDER LOCKS





QUADRETTI AVVIAMENTO
IGNITION SWITCHES KIT

APRILIA

24 605 0010 

50: Amico 94-98 • Amico GL-GLE 93-95
• Amico Lx- Sport-Cat 92-93
(R.O.8212336)



24 605 0020 

50: Rally 95-03 • Rally Liquid Cooled 96-99
• Sr 93-96 • Sr Liquid Cooled 94-96 • Sr Stealth,
Racing 97-99 • Sr Www 97-01
(kit 3 pezzi - *key set 3 pcs*)
(R.O.8201845)



24 605 0030 

50: Scarabeo 93-05 • Scarabeo Street 05-06 •
Scarabeo Street 2T Rst 06-09
(kit 3 pezzi - *key set 3 pcs*)
(R.O.8201846)



24 605 0420 

50: Scarabeo 93-05
125: Classic 95-99
(R.O.8201793)



24 605 0440 

50: Scarabeo Ditech Iniezione • Sr Street 03-12
Sr Ditech Eu2 02-04
(kit 4 pezzi - *key set 4 pcs*)
(R.O.AP8224343)



24 605 0450 

50: Scarabeo Ditech Iniezione 02-06
• Sr Street 03-12 • Sr Ditech Eu2 02-04
(R.O.AP8224343)



24 605 0200 

50: Sonic 98-07 • Sonic GP 98-08
(kit 3 pezzi - *key set 3 pcs*)
(R.O.8202014)



24 605 0601 

50: Scarabeo 2T Net 09 • Scarabeo 2T Eu2 Mot.
Piaggio 10-12
(R.O. AP8202452)



NEW

24 605 0621 

50: Scarabeo 4T Restyling Eu3 06-09
• Scarabeo 4T-4V 09-12
100: Scarabeo 4T Restyling 06-09
• Scarabeo 4T 10-12
(R.O. 85180R)



NEW



APRILIA

24 605 0611 

NEW

50: Scarabeo 2T Net 09 • Scarabeo 2T Eu2
Motore Piaggio 10-12
(R.O. 860579)



24 605 0350 

24 605 0351 

125: Leonardo 99-01 • Leonardo St 01-04
(kit 3 pezzi - *key set 3 pcs*)
(R.O.8102923)



24 605 0370 

125: Scarabeo Motore Rotax 99-03 • Scarabeo 03
(kit 2 pezzi - *key set 2 pcs*)
(R.O.8102841)



24 605 0521 

NEW

24 605 0522 



125: Sport City 04-06 • Sport City Eu3 06-08
• Sport City Cube 08-10
125-200: Sport City 04-06
250: Sport City Cube 08-10
(R.O. AP8104726)



24 605 0530 

24 605 0531 

250: Leonardo 99-01 • Leonardo 02-04
• Leonardo St 01 • Leonardo 99-01
(R.O. AP8102877)



24 605 0552 



50: Sr Ditech Eu2 02-03 • Sr H2O Ditech E
Carburatore 00-03 • Sr Street 03-08
(R.O. AP8224343)



24 605 0641 

NEW

50: Sr R Factory Carburatore 10-12
• Sr R, R Factory 04-09
(R.O. AP8202419)



24 605 0650 

50: Sr Ditech Eu2 02-04 • Sr H2o Ditech e
Carburatore 00-04
• Sr Street Iniezione 03-12
(R.O. AP8202218-AP8202386)





QUADRETTI AVVIAMENTO
IGNITION SWITCHES KIT

HONDA

24 605 0070 

50: Sky 97
(kit 2 pezzi - *key set 2 pcs*)
(R.O.35010 GCG 930)



24 605 0081 

50: Sh 96
100: Sh 96-99
(kit 3 pezzi - *key set 3 pcs*)
(R.O.35010 GBY 910)



24 605 0340 

50: Sh 91-95
(kit 2 pezzi - *key set 2 pcs*)
(R.O.35010GJ3930)



24 605 0380 

125-150: Pantheon 2T 98-02
250: Foresight
(kit 4 pezzi - *key set 4 pcs*)
(R.O.35010KEY900)-(R.O.35010KFG860)



24 605 0390 

24 605 0392 

125-150: Chiocciola 00-06 • Nes 00-07
(kit 3 pezzi - *key set 3 pcs*)
(R.O.35010KGF900)



24 605 0401 

125-150: Sh 125 01-08
(kit 3 pezzi - *key set 3 pcs*)
(R.O.35010KPR900)



24 605 0471 

125-150: Sh I 01-08
(R.O. 35010-KTF-640)



NEW

24 605 0541 

125-150: Sh 125 01-08
Kit 3 pz/pcs – Bauletto Ant - Post

NEW





KYMCO

24 605 0210 

50: Dj W 94-00 • Dj X 91-92 • Djy 93
(kit 3 pezzi - *key set 3 pcs*)
(R.O.00169007)



24 605 0720 

50: Dink Classic Eu2 03 • Dink Lc 98-02
125: Dink 97-98 • Dink Classic 02
• Dink Classic Eu2 03 • Dink Lx 98-00
200: Dink Classic 04
(kit 2 pezzi - *key set 2 pcs*)
(R.O.00168927)



24 605 0630 

50: Agility R16 10-12 • Agility R16 4T 09-12
125: Agility R16 09-12
150: Agility R16 09
200: Agility R16 10-12
(R.O.00135071)



MALAGUTI

24 605 0490 

50: People 04 • People 99-00 • People Eu2 03
125: People 99-00 • People Eu2 03
(R.O. 169307)



24 605 0090 

50: Centro Base 93-94 • Centro SL 94-98 •
Centro SL Kat 99-00 • F10 Ac 08 • F10 Ac Eco
09 • F10 Jet Line 92-98 • F10 Kat 99-00 • F10
Rst Eu1 01-02 • F10 Rst Eu2 06 • F10 Rst Eu2
02-03 • F10 Rst Eu2-2.3 03-04
(R.O.09002500)



24 605 0100 

50: Crosser Cr1 95-98 • F12 Aria Rst Eu2 06 • F12
Lc Rst Eu2 06 • F12 Phantom 94-98 • F12 Phantom
Eu1 99-00 • F12 Phantom Lc 94-98 • F12 Phantom
Lc Eu1 99-00 • F12 Phantom Lc Rst Eu1 01-02 • F12
Phantom Lc Rst Eu2 02 • F12 Phantom Lc Rst Eu2-
2.3 03-04 • F12 Phantom Lc Twin Disks 98 • F12
Phantom Rst Eu1 01-02 • F12 Phantom Rst Eu2 02
• F12 Phantom Rst Eu2-2.3 03-04 • F15 Fire Fox Air
Cooled 05-06
100: F12 Phantom 99-00
(R.O.09003100)



24 605 0430 

50: Ciak 99-00 • Ciak Master 04 • Ciak Master
4T 05-06 • Ciak Master Eu2 06 • Ciak Mono Eu 2
03 • Ciak Mono Eu2 2.3 03 • Ciak Td 00-01
100: Ciak 99-00
125: Ciak 00-01 • Ciak Master 04 • Ciak Master
Eu 3 06 • Ciak Rst Eu2 03
150: Ciak 00-02 • Ciak Master 04 • Ciak Rst Eu2 03
200: Ciak Master Eu 2 06
(kit 3 pezzi - *key set 3 pcs*)
(R.O.09005100)



24 605 0310 

50: Centro Base 93-94 • Centro SL 94-98 • Cen-
tro SL Kat 99-00 • F10 Ac 08 • F10 Ac Eco 09
• F10 Jet Line 92-98 • F10 Kat 99-00 • F10 Rst
Eu1 01-02 • F10 Rst Eu2 06 • F10 Rst Eu2 02-03
• F10 Rst Eu2-2.3 03-04
(kit 3 pezzi - *key set 3 pcs*)
(R.O.09002600)



24 605 0321 

50: F12 Aria Rst Eu2 06 • F12 Lc Rst Eu2 06
• F12 Phantom 94-98 • F12 Phantom Eu1 99-00
• F12 Phantom Lc 94-98 • F12 Phantom Lc Eu1
99-00 • F12 Phantom Lc Rst Eu1 01-02 • F12
Phantom Lc Rst Eu2 02 • F12 Phantom Lc Rst
Eu2-2.3 03-04 • F12 Phantom Lc Twin Disks 98
• F12 Phantom Rst Eu1 01-02 • F12 Phantom
Rst Eu2 02 • F12 Phantom Rst Eu2-2.3 03-04
100: F12 Phantom 99-00
(kit 3 pezzi - *key set 3 pcs*)
(R.O.09002800)





QUADRETTI AVVIAMENTO
IGNITION SWITCHES KIT

MALAGUTI

24 605 0330 

50: F15 Fire Fox 96-98 • F15 Fire Fox Air Cooled 05-06 • F15 Fire Fox Eu2 02-03 • F15 Fire Fox Rst Eu2-2.3 03-04 • F15 Fire Fox Twin Disks & Special 98-99 • F15 Fire Fox Twin Disks Digit Kat 98-00 • F15 Lc Rst Eu2 04-05 • F15 Lc-Tds Rst Eu1 01

125: F18 Warrior 00-02

150: F18 Warrior 00-02
(kit 3 pezzi - key set 3 pcs)
(R.O.09003500)



24 605 0571  **NEW**

50: Centro 4T 08 • Centro SL 4T 10
125: Centro ie 08-09 • Centro SL Le 09
160: Centro ie 08-09 • Centro SL Le 09
(R.O.09008400)



MBK

24 605 0130 

50: Cw Rs Booster Ng 95-99 • Cw Rs Booster Ng 01-02 • Cw Rs Booster Ng Eu1 99-00 • Cw Rsp Booster Rocket [I] 97-98 • Cw Rxs Booster Track 96-98
(kit 2 pezzi - key set 2 pcs)
(R.O.4SBH20210200)



24 605 0141 

50: Cw Booster 90-94 • Cw Booster 01-02 • Cw R Booster Road (Ita) 94-95 • Cw Booster Spirit 96-00 • Cw Booster Spirit Eu2 02 • Ew Stunt 00-02 • Ew Slider 00/02
(kit 2 pezzi -key set 2 pcs)
(R.O.3VLH250100 - 5JHH20210000)



24 605 0150 

50: Yn R Ovetto (Che-Ita) 97-01
(R.O.5ADH25010100)



24 605 0161 

50: Yq Nitro 97-02
(kit 2 pezzi - key set 2 pcs)
(R.O.5BR-H2021-0000)



24 605 0271 

50: Yn R Ovetto (Che-Ita) 97-01
(kit 2 pezzi - key set 2 pcs)
(R.O.5AD-H2501-00)



24 605 0280 

24 605 0282 
50: Yq Nitro 97-02
(kit 4 pezzi - key set 4 pcs)
(R.O.5BR-H2021-0100)





MBK

24 605 0290 

50: Yh Flipper 98 • Yh Flipper 01-02
• Yh Flipper Catalitico 99-00
(kit 3 pezzi - *key set 3 pcs*)
(R.O.5EU-H2021-00)



24 605 0360 

125: Yp Skyliner 98-00
150: Yp Skyliner 00
(kit 2 pezzi - *key set 2 pcs*)
(R.O. 5DSS25010100)



24 605 0460 

50: Cs Mach G Eu1 02-03 • Cs Mach G Eu2 02-04
• Yn R Ovetto Eu1 02-04 • Yn R Ovetto Eu2 02-03
100: Yn Ovetto 00-02
(R.O. 5KKH25010000)



PEUGEOT

24 605 0581 

NEW

50: CW Booster 04
(R.O. 5WWH25010000)



24 605 0591 

50: Yq L Nitro Jaguar 04 • Yq Nitro Eu 2 03
• Yq Nitro 04
(kit 4 pezzi - *key set 4 pcs*)
(R.O. 5WJH20211000)



24 605 0170 

24 605 0171 

50: Buxy 94-97 • Fox 94-98 • Speedake 95-97 •
Zenith L 94-96 • Zenith Ln-Ls 97-98
• Zenith N 97-98
(kit 2 pezzi - *key set 2 pcs*)
(R.O.752727)



24 605 0180 

50: Speedfight Acqua 97-98
• Speedfight Aria 97-98
100: Trekker 98
(kit 2 pezzi - *key set 2 pcs*)
(R.O.752849)



24 605 0500 

50: Ludix 10 One 04 • Ludix 14 Classic 04
• Metal-X 02 • Speedfight 2 Aria 05-06
• Trk2 Wrc 04-06 • Xrace 03
(R.O. 755930)



24 605 0510 

24 605 0511 

50: Speedfight li Serie Ac-Lc
(Senza immobilizer - *Without immobilizer*)





QUADRETTI AVVIAMENTO IGNITION SWITCHES KIT

PIAGGIO

24 605 0730



NEW

24 605 0680



1 Pz - 1 Pcs

24 605 0700



3 Pz - 3 Pcs

PIAGGIO 220: Ape Car P2-P3 78-85 • Ape Mp P501-P601 78-96 • Ape Tm P602 82-83 • Ape Tm P703-P703V-FL2 84-05

420: Ape Car - Max Diesel 86-96 • Ape Tm P703-P703V Diesel 87-04
(R.O. 140732)



COMMUTATORE ACCENSIONE - MAIN SWITCH

PIAGGIO: Liberty Elettrico Ppt Aut 11 • **50:** Fly 2T 05-11 • Fly 4T & 25-30 Km/h 08-11 • Fly 4T Motore Chn 06-07 • Fly 4T 05-07 • Liberty 2T Rst 04 • Liberty 2T Sport 06-08 • Liberty 2T 06-08 • Liberty 4T Delivery Single 10-14 • Liberty 4T Delivery Tnt 09 • Liberty 4T Ptt Deu 07-12 • Liberty 4T Ptt Double 09-12 • Liberty 4T Rst 04 • Liberty 4T Sport 06-08 • Liberty 4T 00-08 • Liberty Moc 2T-4T & Elle 09-13 • Liberty Ptt Eu2 04-05 • Liberty 97-05 • Nrg Power Dd Serie Speciale 07-12 • Nrg Power Dd 05-13 • Nrg Power Dt Serie Speciale 07-08 • Nrg Power Dt 06-11 • Nrg Powerjet 04-11 • Nrg Purejet 10 • Typhoon 2T Eu2 10-12 • Typhoon 2T Eu3 Ch 11 • Vespa Et2 97-05 • Vespa Et4 00-05 • Vespa Lx 2T Touring & 30 Km/h 10-13 • Vespa Lx 2T 05-13 • Vespa Lx 4T-4V Touring 10-13 • Vespa Lx 4T-4V 09-13 • Vespa Lx 4T 05-08 • Vespa Lxv 2T Navy 08 • Vespa Lxv 2T 06-09 • Vespa primavera 2T 13-15 • Vespa Primavera 4T-4V 13-14 • Vespa S 2T & College 07-12 • Vespa S 4T-4V & College 08-12 • Vespa Sprint 2T 2V 14-15 • Vespa Sprint 4T 4V 14 • Zip 2T 08-13 • Zip 4T 00-13 • Zip Sp Eu2 06-13 • Zip Sp 01-04 • Zip 00-04 • **100:** Fly 4T 06-10 • **125:** Fly Eu3 • Fly Eu3 07-11 • Fly 05-07 • Hexagon Gtx 00 • Hexagon Lx4 98-99 • Liberty 4T 2V Eu3 09-12 • Liberty 4T 2V ie Ptt Ita 12 • Liberty 4T Eu3 Delivery Single 07-15 • Liberty 4T Eu3 Delivery Tnt 08-09 • Liberty 4T Eu3 06-08 • Liberty 4T Sport Eu3 06-08 • Liberty 4T 06-07 • Liberty Rst Ptt 05-11 • Liberty Rst 04-05 • Liberty Sport 06 • Liberty 01-02 • Skipper 4T 00-02 • Super Hexagon Gtx 12 01-02 • Typhoon 4T 2V Eu3 10-11 • Vespa 946 4T 3V Abs 13-14 • Vespa Et4 99-02 • Vespa Lx 4T 3V ie Touring 12-13 • Vespa Lx 4T Eu3 Touring 10-11 • Vespa Lx 4T FL 09 • Vespa Lx Eu3 ie 09-11 • Vespa Lx Eu3 06-08 • Vespa Lx 05-06 • Vespa Lxv 4T Eu3 06-09 • Vespa Lxv 4T Navy Eu3 07-08 • Vespa Lxv ie 4T 10-13 • Vespa S 4T 3V ie 12 • Vespa S 4T Eu3 07-08 • Vespa S 4T ie & College 09-11 • X7 Eu3 08 • X9 01-02 • Zip 00-02 • **150:** Fly Eu3 08-11 • Fly 05-07 • Liberty 4T Eu3 08 • Liberty 4T Sport Eu3 08 • Liberty Moc 4T Eu3 09-13 • Vespa Lx 4T 3V ie Touring 12-13 • Vespa Lx 4T FL 09 • Vespa Lx Eu3 ie 09-11 • Vespa Lx Eu3 06-08 • Vespa Lx Touring 10-12 • Vespa Lx 05-06 • Vespa S 4T ie & College 09-12 • Vespa S 4T 08-09 • **180:** X9 Amalfi 00-03 • **200:** Liberty 4T Eu3 06-08 • Liberty 4T Sport Eu3 06-07 • Liberty Rst 04 • Liberty Sport 06 • Liberty 06 • X9 02-03 • **250:** Hexagon Gt - Gtx 98-00 • X7 Eu3 08 • X9 00-01 • **500:** X9 01-02
(R.O. 643133)

24 605 0710



PIAGGIO 50: Nrg Extreme 99-00 • Nrg Mc3 01-04 • Nrg Purejet 02-04 • Typhoon 01-11 • Zip Rst 96-99
(R.O.580639)



24 605 0230



PIAGGIO: Vespa Et3-Vespa Px-Vespa Pe
(R.O.160743)



24 605 0660



COMMUTATORE A CHIAVE - KEY SWITCH
PIAGGIO 50: Vespa Et2 Iniezione 97-00
125: Vespa Et4 96-98
(R.O. 298687)





PIAGGIO

24 605 0670 

COMMUTATORE A CHIAVE - KEY SWITCH
PIAGGIO 50: Ape 09 • Rst Mix 99-03 • Mix 2T
98-08 • FL3 Europa 96-99 • FL/FL2 89-95
(R.O. 291582)



24 605 0693 

COMMUTATORE A CHIAVE - KEY SWITCH
PIAGGIO: Vespa Px 125-150-200 Vnx-Vlx-Vsx
• Vespa Pk 50-125
(R.O. 178593)



24 605 0740 

COMMUTATORE - SWITCH
PIAGGIO 160: Vespa 160 Gs
Vsb1 ('63-'64)
5 Posizioni/5 Positions
(R.O. 70113)



NEW



YAMAHA

24 605 0750 

COMMUTATORE - SWITCH
PIAGGIO: Vespa 150 GS ('59-'61) VS5
Vespa 160 GS ('62-'64) VSB1
(R.O. 92962)



NEW



24 605 0130 

50: Bw'S Bump 97-98 • Bw'S Next Generation
97-02 • Bw'S Next Generation Cat. 99-00 • Cw
Rs Spy 95-98 • (kit 2 pezzi - key set 2 pcs)
(R.O.45BH20210200)



24 605 0141 

50: Bw'S Original 97-02 • Bw'S Original Eu2 02
• Bw'S R 01 • Ew Slider 00-02 • Ew Slider 00/02
(kit 2 pezzi -key set 2 pcs)
(R.O.3VLH250100-5JHH20210000)



24 605 0150 

50: Yn Neo'S 97-01
(R.O.5ADH25010100)



24 605 0161 

50: Yq Aerox 97-98 • Yq Aerox 01-02 • Yq Aerox
R 99-00
(kit 2 pezzi - key set 2 pcs)
(R.O.5BR-H2021-0000)



24 605 0271 

50: Yn Neo'S 97-01
(kit 2 pezzi - key set 2 pcs)
(R.O.5AD-H2501-00)





QUADRETTI AVVIAMENTO
IGNITION SWITCHES KIT

YAMAHA

24 605 0280 



ZADI

24 605 0282 

50: Yq Aerox 97-98 • Yq Aerox 01-02 • Yq Aerox R 99-00
(kit 4 pezzi
key set 4 pcs)
(R.O.5BR-H2021-0100)



24 605 0290 

50: Yh Why 98 • Yh Why 01-02 • Yh Why Eu1 99-00
(kit 3 pezzi - key set 3 pcs)
(R.O.5EU-H2021-00)



24 605 0360 

125: Yp E Majesty 98-00
150: Yp Majesty 00
(kit 2 pezzi - key set 2 pcs)
(R.O.5DSS25010100)



24 605 0460 

50: Cs Jog R 02 • Cs Jog R 06-10 • Cs Jog R Eu2 02-05 • Yn Neo'S 02 • Yn Neo'S 04-06
• Yn Neo'S Eu2 02-03
100: Yn Neo'S 99-02
(R.O.5KKH25010000)



24 605 0581 

NEW

50: Bw'S 04-11 • Bw'S Naked 04-11 • Cw L Bw'S 04
(R.O.5WWH25010000)



24 605 0591 

50: Yq L Nitro Jaguar 04 • Yq Nitro Eu 2 03
• Yq Nitro 04
(R.O.5WJH20211000)



CILINDRETTI SERRATURA SCOOTER - APE

CYLINDER LOCKS SCOOTER - APE



12 179 0010 

PIAGGIO
(1 cilindretto - *Cylinder lock 1 pc.*)
(R.O. 573905)



12 179 0020 

PIAGGIO
(2 cilindretti - *Cylinders lock 2 pcs.*)
(R.O. 573905)



12 179 0040 

GILERA - PIAGGIO
(Kit 2 pezzi cilindretti - *Cylinder lock 2 pcs*)
(R.O. 179292)



12 179 0042 

GILERA - PIAGGIO
(Kit 2 pezzi cilindretti - *Cylinder lock 2 pcs*)
(R.O. 179292)



12 179 0160 

GILERA
(2 cilindretti - *Cylinder locks 2 pcs*)
(R.O. 576718)



12 179 0212 

PIAGGIO
Kit Serratura completa - *Complete lock*
(R.O. 258664)



12 179 0280 

APRILIA - PIAGGIO
(2 cilindretti - *Cylinder locks 2 pcs*)
(R.O. 860193)





CILINDRETTI SERRATURA SCOOTER - APE

CYLINDER LOCKS SCOOTER - APE

Modello - Model	Cc	Anno Year	Codice RMS RMS Code	Rifer. Originale Oem Number	Modello - Model	Cc	Anno Year	Codice RMS RMS Code	Rifer. Originale Oem Number
APRILIA									
Sport City One 2T	50	08-11	12 179 0280	860193	Vespa Lxv 2T Navy	50	08	12 179 0010	573905
Sport City One 4T	50	08-10	12 179 0280	860193	Vespa Lxv 2T Navy	50	08	12 179 0020	573905
Sr Motard 2T	50	12-14	12 179 0280	860193	Vespa N	50	89-90	12 179 0040	179292
Sr Motard 4T 4V	50	13-14	12 179 0280	860193	Vespa N	50	89-90	12 179 0042	179292
Sport City One 4T Eu3	125	08-11	12 179 0280	860193	Vespa Pk	50	82-84	12 179 0040	179292
Sr Motard	125	12-14	12 179 0280	860193	Vespa Pk	50	82-84	12 179 0042	179292
GILERA									
Easy Moving	50	95-96	12 179 0040	179292	Vespa Pk XL	50	85-88	12 179 0040	179292
Easy Moving	50	95-96	12 179 0042	179292	Vespa Pk XL	50	85-88	12 179 0042	179292
Ice	50	01-05	12 179 0160	576718	Vespa Pk XL Plurimatic	50	85-90	12 179 0040	179292
Runner	50	97-00	12 179 0160	576718	Vespa Pk XL Plurimatic	50	85-90	12 179 0042	179292
Runner Poggiali	50	02	12 179 0160	576718	Vespa Pk XL Rush	50	88-89	12 179 0040	179292
Runner Purejet	50	02-04	12 179 0160	576718	Vespa Pk XL Rush	50	88-89	12 179 0042	179292
Runner Sp	50	02-04	12 179 0160	576718	Vespa Primavera 4T-4V	50	13-17	12 179 0010	573905
Storm	50	94-95	12 179 0040	179292	Vespa Primavera 4T-4V	50	13-17	12 179 0020	573905
Storm	50	94-95	12 179 0042	179292	Vespa S 2T & College	50	07-12	12 179 0010	573905
Typhoon	50	94-97	12 179 0040	179292	Vespa S 2T & College	50	07-12	12 179 0020	573905
Typhoon	50	94-97	12 179 0042	179292	Vespa S 4T-4V & College	50	08-12	12 179 0010	573905
Typhoon X	50	98-99	12 179 0040	179292	Vespa S 4T-4V & College	50	08-12	12 179 0020	573905
Typhoon X	50	98-99	12 179 0042	179292	Zip	50	92-93	12 179 0040	179292
Typhoon Xr	50	00	12 179 0040	179292	Zip	50	92-93	12 179 0042	179292
Typhoon Xr	50	00	12 179 0042	179292	Zip	50	95-96	12 179 0040	179292
Runner Fx-Fxr 125-180	125	97-02	12 179 0160	576718	Zip	50	95-96	12 179 0042	179292
Runner Vx-Vxr 125-200	125	02-04	12 179 0160	576718	Zip Fast Raider	50	93-94	12 179 0040	179292
Typhoon	125	95-98	12 179 0040	179292	Zip Fast Raider	50	93-94	12 179 0042	179292
Typhoon	125	95-98	12 179 0042	179292	Skr City	80	99	12 179 0040	179292
Typhoon X-Xr	125	99-00	12 179 0040	179292	Skr City	80	99	12 179 0042	179292
Typhoon X-Xr	125	99-00	12 179 0042	179292	Cosa CL-CLX	125	88-91	12 179 0040	179292
Runner Fx-Fxr 125-180	180	97-02	12 179 0160	576718	Cosa CL-CLX	125	88-91	12 179 0042	179292
Runner Vx-Vxr 125-200	200	02-04	12 179 0160	576718	Sfera	125	95-97	12 179 0040	179292
PIAGGIO									
Ape FL - FL2	50	89-95	12 179 0212	258664	Sfera	125	95-97	12 179 0042	179292
Ape FL3 Europa	50	96-99	12 179 0212	258664	Skipper	125	94-97	12 179 0040	179292
Free	50	92-94	12 179 0040	179292	Skipper	125	94-97	12 179 0042	179292
Free	50	92-94	12 179 0042	179292	Typhoon 4T 2V Eu3	125	10-11	12 179 0280	860193
Nrg	50	94-96	12 179 0040	179292	Vespa Et4	125	96-98	12 179 0010	573905
Nrg	50	94-96	12 179 0042	179292	Vespa Et4	125	96-98	12 179 0020	573905
Ntt	50	95-96	12 179 0040	179292	Vespa Pk XL	125	86-89	12 179 0040	179292
Ntt	50	95-96	12 179 0042	179292	Vespa Pk XL	125	86-89	12 179 0042	179292
Quartz	50	92-96	12 179 0040	179292	Vespa Px	125	11-17	12 179 0040	179292
Quartz	50	92-96	12 179 0042	179292	Vespa Px	125	11-17	12 179 0042	179292
Sfera	50	91-93	12 179 0040	179292	Vespa Px	125	98-01	12 179 0040	179292
Sfera	50	91-93	12 179 0042	179292	Vespa Px	125	98-01	12 179 0042	179292
Sfera Maquillage 2	50	94	12 179 0040	179292	Vespa Px 30 Anni	125	07-08	12 179 0040	179292
Sfera Maquillage 2	50	94	12 179 0042	179292	Vespa Px 30 Anni	125	07-08	12 179 0042	179292
Sfera Rst	50	95-97	12 179 0040	179292	Vespa Px Eu2	125	01-07	12 179 0040	179292
Sfera Rst	50	95-97	12 179 0042	179292	Vespa Px Eu2	125	01-07	12 179 0042	179292
Typhoon	50	01-04	12 179 0040	179292	Vespa Px T5	125	85-89	12 179 0040	179292
Typhoon	50	01-04	12 179 0042	179292	Vespa Px T5	125	85-89	12 179 0042	179292
Typhoon 2T Eu3 Ch	50	11	12 179 0280	860193	Vespa Pxe Arcobaleno	125	81-97	12 179 0040	179292
Vespa Et2	50	97-05	12 179 0010	573905	Vespa Pxe Arcobaleno	125	81-97	12 179 0042	179292
Vespa Et2	50	97-05	12 179 0020	573905	Vespa S 4T Eu3	125	07-08	12 179 0010	573905
Vespa Et4	50	00-05	12 179 0010	573905	Vespa S 4T Eu3	125	07-08	12 179 0020	573905
Vespa Et4	50	00-05	12 179 0020	573905	Vespa S 4T le & College	125	09-11	12 179 0010	573905
Vespa Lx 2T	50	09-13	12 179 0010	573905	Vespa S 4T le & College	125	09-11	12 179 0020	573905
Vespa Lx 2T	50	09-13	12 179 0020	573905	Vespa Lt 4T 3V le	150	14	12 179 0010	573905
Vespa Lx 2T	50	05-08	12 179 0010	573905	Vespa Lt 4T 3V le	150	14	12 179 0020	573905
Vespa Lx 2T	50	05-08	12 179 0020	573905	Vespa Px	150	11-17	12 179 0040	179292
Vespa Lx 2T Touring & 30 Km	50	10-13	12 179 0010	573905	Vespa Px	150	11-17	12 179 0042	179292
Vespa Lx 2T Touring & 30 Km	50	10-13	12 179 0020	573905	Vespa S 4T	150	08-09	12 179 0010	573905
Vespa Lx 4T	50	05-09	12 179 0010	573905	Vespa S 4T	150	08-09	12 179 0020	573905
Vespa Lx 4T	50	05-09	12 179 0020	573905	Vespa S 4T le & College	150	09-12	12 179 0010	573905
Vespa Lx 4T-4V	50	09-13	12 179 0010	573905	Vespa S 4T le & College	150	09-12	12 179 0020	573905
Vespa Lx 4T-4V	50	09-13	12 179 0020	573905					
Vespa Lx 4T-4V Touring	50	10-13	12 179 0010	573905					
Vespa Lx 4T-4V Touring	50	10-13	12 179 0020	573905					
Vespa Lxv 2T	50	06-09	12 179 0010	573905					
Vespa Lxv 2T	50	06-09	12 179 0020	573905					

CILINDRETTI SERRATURA VESPA

CYLINDER LOCKS VESPA



12 179 0060 

12 179 0090 

12 179 0232 



12 179 0062 



12 179 0092 



PIAGGIO 50-125: Vespa Pk • Pk XL • Px Arcobaleno
Kit 5 pezzi cilindretti
Cylinder lock set 5 pcs.
(R.O. 196467)

PIAGGIO 50-125: Vespa Pk • Pk XL • Px Arcobaleno
Kit 3 pezzi cilindretti
Cylinder lock set 3 pcs.
(R.O. 179292)

PIAGGIO 50-125: Vespa Pk • Pk XL • Px Arcobaleno
Cilindretto per serratura
Cylinder lock 1 pc. g
(R.O.196486)



12 179 0293 

12 179 0303 

12 179 0713 



PIAGGIO 125: Vespa VNA-VNB 57-65
150: Vespa VBA-VBB 59-65
Serratura sterzo - *Steering lock*
(R.O. 082416)

PIAGGIO 125: Vespa 51-57
150: Vespa 54-56 • Vespa Gs VS1 55
Serratura sterzo - *Steering lock*
Piastrina corta - *Short plate*
(R.O. 20456)

PIAGGIO 150: Vespa VB1 57-58 • Vespa Gs 56-61
Serratura sterzo - *Steering lock*
Piastrina lunga - *Long plate*
(R.O. 060727)



12 179 0272 



12 179 0162 



12 179 0262 



PIAGGIO 50: Vespa
125: Primavera • P125X
150: Vespa P150S • Super
200: Rally
Kit serratura 4 mm + Bauletto
Kit cylinder 4 mm + Tool box
(R.O. 139188)

PIAGGIO 125-150-200: Vespa Px 1 serie
125-150: GL Sprint Super
Kit serratura 4 mm + Bauletto - Chiavi in plastica
Kit cylinder 4 mm + Tool box - Plastic keys
(R.O.: 139188)

PIAGGIO 125-150: Vespa Px
200: Vespa P200E 78-84
Kit serratura 4 mm + Bauletto + Sella
Kit cylinder 4 mm + Tool box - Seat
(R.O. 184860)



12 179 0172 



12 179 0122 



12 179 0192 



PIAGGIO 50: Vespa S • Elestart
125: Primavera Et3 • Px • Pe
Kit serratura 6 mm + Bauletto
Kit cylinder 6 mm + Tool box
(R.O. 182178)

PIAGGIO 50: Vespa
125: Primavera Px
150: Vespa Px • Super • Sprint • Rally
Serratura sterzo - Chiavi in plastica
Steering lock - Plastic 2 keys
Guida mm 4 - *Size mm 4*
(R.O. 152096)

PIAGGIO 50: Vespa
125: Primavera Px
150: Vespa Px • Super • Sprint • Rally
Serratura sterzo - Chiavi in metallo
Steering lock - Metal 2 keys
Guida mm 4 - *Size mm 4*
(R.O. 152096)





CILINDRETTI SERRATURA VESPA

CYLINDER LOCKS VESPA

12 179 0132 



PIAGGIO 50: Vespa S • Elestart
125: Vespa Et3 • Px • Pe
 Serratura sterzo - Chiavi in plastica
Steering lock - Plastic 2 keys
 Guida mm 6 - *Size mm 6*
 (R.O. 139371)



12 179 0202 



PIAGGIO 50: Vespa S • Elestart
125: Vespa Et3 • Px • Pe
 Serratura sterzo - Chiavi in metallo
Steering lock - Metal 2 keys
 Guida mm 6 - *Size mm 6*
 (R.O. 139371)



12 179 0222 



PIAGGIO 50: Vespa R • Ss • Special
125: Vespa Primavera • Super Sprint
 Serratura sterzo - Chiavi in metallo
Steering lock - Metal 2 keys
 Guida mm 4 - *Size mm 4*
 (R.O. 120328)



12 179 0141 

12 179 0142 



PIAGGIO 125: Vespa Et3 Primavera • Super • Px
150: Vespa Px - **200:** Vespa Px • Rally
 Serratura bauletto - *Tool box lock*
 (R.O. 139379)



12 179 0180 

PIAGGIO 50: Vespa N 89-90 • Pk XL Rush 88-90
 Pk XL 85-88
125: Vespa Px T5 85-89
125-150-200: Vespa Px 98-01 • Px
 • Arcobaleno 81-97
 Serratura bauletto - *Tool box lock*
 (R.O. 198560)



12 179 0252 

PIAGGIO 125-150: Vespa Px Millenium
 Serratura bauletto - *Tool box lock*
 (R.O. 576998)



12 179 0513 

PIAGGIO 150: Vespa VL3 - VBA - VBB1 - VBB2
 • Vespa Sprint VLB 1° Serie • Vespa Gs VS2 - VS5
 Serratura bauletto laterale o posteriore
Tool box rear or side lock
 (R.O. 025911)



12 179 0613 

NEW

PIAGGIO: Vespa 150
 VBA-VBB-VNA-VNB-VNC-VBC
 Con Coperchio-*With Cover*



12 179 0152 



PIAGGIO 50-90-125: Vespa Primavera
 Serratura sportello laterale - *Side door lock*



12 179 0313 

PIAGGIO 125-150-200: Vespa Px 1 Serie
 VNX-VLX-VSX
 Serratura sella - *Seat lock*
 (R.O. 190013-437959)



12 179 0170 

PIAGGIO 125: Vespa • Px 30 Anni 07-08 • Px
 Eu 2 01-07 • Px T5 85-89
125-150: Pxe Arcobaleno 81-97
125-150-200: Pk 98-01
 Serratura sella - *Seat lock*
 (R.O. 178887)



12 179 0413 

PIAGGIO: Vespa Millenium
 Serratura sella - *Seat lock*
 (R.O. 577267)





12 179 0190 

COPERCHIETTO SERRATURA
LOCK COVER

PIAGGIO Vespa Px 1° serie - Ape 50
(R.O. 174628)



12 179 0242 

SBOZZATO CHIAVE - KEY BLANK

PIAGGIO: Vespa • Ape
(R.O. 120330)



12 195 0090 

MOLLA SERRATURA BAULETTO
TOOLBOX LOCK SPRING

PIAGGIO: Vespa 125 Primavera-Sprint-Rally-Px
(R.O. 073260)



12 187 0080 

CORPO CILINDRETTO SERRATURA
CYLINDER LOCK BODY

APRILIA: Sport City 50 08 • Sport City 125 08
GILERA: Ice 50 01 • Runner 50 • FL • Poggiali Pu-
rejet 97-04 • Runner 125-150-200 • Fx • Fxr-Vx •
Vxr-97-02
PIAGGIO: Beverly 125-200-250-500 01-04
Rst 125 04 • Fly 50 2-4 T-150 05 • Hexagon Lx4
125 98-99 • Lx-Lxt 125-180 98-99 • Super Gtx 12"
125-180 01-02 • Hexagon Gt-S. Hexagon Gtx
250 98-00 • Super Hexagon Gtx 125-180 00 •
Liberty 50 2-4 T 97-02 • Rst 50 2/4 T 125 04
Rst 125-150-200 98-05 • Skipper 4T 125-150 00-
02 • Lx 125-150 98-99 • Vespa 50 Et2
Iniezione 97-0 • Et4 50 00-02 • Et4 125-125-150
96-02 • Vespa Gran Turismo 125-200 03 •
X8 125-200 04 • X9 125-200-250-500 01-03 •
X9 Evolution 125-200-250-500 03 > X9 Amalfi
180 00-03 • Zip Sp 50 01-04 • Zip 50 Euro 1 00-
02 • Zip 4T 50 00-04
(R.O. 298581)



12 187 0012 

CORPO CILINDRETTO SERRATURA
CYLINDER LOCK BODY

PIAGGIO - GILERA
(R.O. 297777)



12 187 0022 

CORPO CILINDRETTO SERRATURA
CYLINDER LOCK BODY

PIAGGIO 50: Vespa Pk • FL • Sfera • Free
125-150: Skipper
125-150-200: Cosa 2
(R.O. 254536)



12 183 0460 

FONDELLO BLOCCA STERZO
GASKET FOR CYLINDER LOCK

PIAGGIO 125-150-200: Vespa Px
VNX - VLX - VSX
(R.O. 174092)



12 179 0182 

KIT COPERCHIETTO SERRATURA
LOCK COVER

PIAGGIO 50-90-125: Vespa Primavera
150: Vespa GL • Sprint - Rally
(R.O. 152097-8-9)





IMPIANTI ELETTRICI CABLE HARNESS

IMPIANTI ELETTRICI VESPA - VESPA CABLE HARNESS



CODICE RMS RMS CODE	DESCRIZIONE DESCRIPTION	CODICE ORIGINALE ORIGINAL CODE	BARCODE
24 649 0041	Impianto Elettrico Vespa 125 Modello 1955 <i>Vespa Cable Harness 125 Model 1955</i>	022681	
24 649 0051	Impianto Elettrico Vespa 125 <i>Vespa Cable Harness 125</i>	091462	
24 649 0061	Impianto Elettrico Vespa 50 <i>Vespa Cable Harness 50</i>	102462	
24 649 0071	Impianto Elettrico Vespa 180 Rally-Gtr 125-Sprint Vel.150 <i>Vespa Cable Harness 180 Rally-Gtr 125-Sprint Vel.150</i>	114309	
24 649 0081	Impianto Elettrico Vespa 50 Special <i>Vespa Cable Harness 50 Special</i>	142965	
24 649 0091	Impianto Elettrico Vespa 90-125 Primavera <i>Vespa Cable Harness 90-125 Primavera</i>	144505	
24 649 0101	Impianto Elettrico Vespa 125 ET3 <i>Vespa Cable Harness 125 ET3</i>	149247	
24 649 0111	Impianto Elettrico Vespa Px 2 Serie - (Con frecce) <i>Vespa Cable Harness Px 2nd Series - (With flashers)</i>	243566	
24 649 0121	Impianto Elettrico Vespa GL 150 <i>Vespa Cable Harness GL 150</i>	090388	
NEW 24 649 0141	Impianto Elettrico Vespa Pk 50 S V5X2T <i>Vespa Cable Harness Pk 50 S V5X2T</i>	243203	
NEW 24 649 0151	Impianto Elettrico Vespa Px 125-150-200 - (Senza avviamento elettrico) <i>Vespa Cable Harness Px 125-150-200 - (No electric starter)</i>	217897	
NEW 24 649 0161	Impianto Elettrico Vespa Px 125-150-200 - (Con avviamento elettrico) <i>Vespa Cable Harness Px 125-150-200 - (With electric starter)</i>	242182	
24 649 0171	Impianto Elettrico Vespa 125 V30T-V33T-VM1T-VU1T <i>Vespa Cable Harness 125 V30T-V33T-VM1T-VU1T</i>	018201	
24 649 0181	Impianto Elettrico Vespa 150 VBB1 <i>Vespa Cable Harness 150 VBB1</i>	057126	
24 649 0191	Impianto Elettrico Vespa Gs 160 VSB1 <i>Vespa Cable Harness Gs 160 VSB1</i>	070124	
24 649 0211	Impianto Elettrico Vespa 150 VLA1T <i>Vespa Cable Harness 150 VLA1T</i>	070651	
24 649 0221	Impianto Elettrico Vespa 150 VL2/3-VB1 <i>Vespa Cable Harness 150 VL2/3-VB1</i>	81300	
24 649 0231	Impianto Elettrico Vespa 125 VNA1/2T <i>Vespa Cable Harness 125 VNA1/2T</i>	081021	
24 649 0241	Impianto Elettrico Vespa 150 VBA1 <i>Vespa Cable Harness 150 VBA1</i>	084354001	
24 649 0251	Impianto Elettrico Vespa 160 VSB1 <i>Vespa Cable Harness 160 VSB1</i>	093736	
24 649 0261	Impianto Elettrico Vespa 125 VNB2/3/4 <i>Vespa Cable Harness 125 VNB2/3/4</i>	093489	
24 649 0271	Impianto Elettrico Vespa Px 125-150-200 I° serie - (Senza frecce) <i>Vespa Cable Harness Px 125-150-200 I° series - (Without blinkers)</i>	162064	
24 649 0291	Impianto Elettrico Vespa 150 Ss 180 VBB2-VSC1 <i>Vespa Cable Harness 150 Ss 180 VBB2-VSC1</i>	098253	
24 649 0301	Impianto Elettrico Vespa Ss 180 VSC1 <i>Vespa Cable Harness Ss 180 VSC1</i>	098235001	
NEW 24 649 0302	Impianto Elettrico Vespa Gs 150 58-61 VS4T VS5T <i>Vespa Cable Harness Gs 150 58-61 VS4T VS5T</i>	084612	
NEW 24 649 0303	Impianto Elettrico Vespa 150 VBB 1961 <i>Vespa Cable Harness 150 VBB 1961</i>	086844	
NEW 24 649 0304	Impianto Elettrico Vespa 50 1°serie 63-65 <i>Vespa Cable Harness 50 1°serie 63-65</i>	-	
NEW 24 649 0305	Impianto Elettrico Vespa 125 VNB1T 59-61 <i>Vespa Cable Harness 125 VNB1T 59-61</i>	087212	



24 633 0180 

PORTA CONNETTORI ELETTRICI "SUPERSEAL"
ELECTRICAL HOLD CONNECTORS "SUPERSEAL"

- 2 Vie 3 pezzi - 2 Pins 3 pcs
- 3 Vie 3 pezzi - 3 Pins 3 pcs
- 4 Vie 3 pezzi - 4 Pins 3 pcs
- Connettori e gommini inclusi - *Connectors and seals included*



24 633 0190 

PORTA CONNETTORI ELETTRICI "MINITIMER"
ELECTRICAL HOLD CONNECTORS "MINITIMER"

- 3 pezzi - 3 pcs
- Connettori e gommini inclusi - *Connectors and seals included*



24 633 0200 

PORTA CONNETTORI ELETTRICI "090"
ELECTRICAL HOLD CONNECTORS "090"

- 2 Vie 1 pezzo - 2 Pins 1 pcs
- 3 Vie 1 pezzo - 3 Pins 1 pcs
- 4 Vie 1 pezzo - 4 Pins 1 pcs
- 6 Vie 1 pezzo - 6 Pins 1 pcs
- Connettori e gommini inclusi - *Connectors and seals included*



24 633 0210 

PORTA CONNETTORI ELETTRICI "BOSCH"
ELECTRICAL HOLD CONNECTORS "BOSCH"

- 3 Pezzi - 3 pcs
- Connettori e gommini inclusi - *Connectors and seals included*



24 633 0220 

PORTA CONNETTORI ELETTRICI 6,3 mm
ELECTRICAL HOLD CONNECTORS 6,3 mm

- 2 Vie 3 pezzi - 2 Pins 3 pcs
- 3 Vie 3 pezzi - 3 Pins 3 pcs
- 4 Vie 3 pezzi - 4 Pins 3 pcs
- 6 Vie 3 pezzi - 6 Pins 3 pcs
- 9 Vie 3 pezzi - 9 Pins 3 pcs
- Connettori inclusi - *Connectors included*



24 633 0230 

PORTA CONNETTORI ELETTRICI 110 ml
ELECTRICAL HOLD CONNECTORS 110 ml

- 2 Vie 3 pezzi - 2 Pins 3 pcs
- 3 Vie 3 pezzi - 3 Pins 3 pcs
- 4 Vie 3 pezzi - 4 Pins 3 pcs
- 6 Vie 3 pezzi - 6 Pins 3 pcs
- 9 Vie 3 pezzi - 9 Pins 3 pcs
- Connettori inclusi - *Connectors included*





IMPIANTI ELETTRICI

CABLE HARNESS

24 633 0240



FASTOM FEMMINA 6,3 mm
CONFEZIONE 100 PEZZI
FEMALE FASTOM 6,3 mm 100 PCS PACK



24 633 0250



COPRI FASTOM MASCHIO 6,3 mm
CONFEZIONE 100 PEZZI
MALE FASTOM COVER 6,3 mm 100 PCS PACK



24 633 0260



COPRI FASTOM FEMMINA 6,3 mm
CONFEZIONE 100 PEZZI
FEMALE FASTOM COVER 6,3 mm 100 PCS PACK



24 633 0270



FASTOM MASCHIO 6,3 mm CONFEZIONE 100 PEZZI
MALE FASTOM 6,3 mm 100 PCS PACK



24 633 0280



OCCHIELLI 6,3 mm CONFEZIONE 100 PEZZI
ROUND CONNECTOR 6,3 mm 100 PCS PACK



24 633 0290



FASTOM CILINDRICI MASCHIO CONFEZIONE 100 PEZZI
CYLINDRICAL FASTOM MALE 100 PCS PACK



24 633 0300



NEW

FASTOM CILINDRICI FEMMINA
CONFEZIONE 100 PEZZI
CYLINDRICAL FASTOM FEMALE 100 PCS PACK



24 633 0310



CONFEZIONE 35 CONNETTORI PREISOLATI
(7 tipi)
PACK OF 35 PLASTIC COATED CONNECTORS
(7 types)



24 633 0320



CONFEZIONE 75 OCCHIELLI Ø 6 mm
M6 1,5-6-10 mm² - (25 pezzi x tipo)
PACK OF 75 Ø 6 mm ROUND CONNECTORS
M6 1,5-6-10 mm² - (25 pcs x types)



24 633 0330



CONFEZIONE 5 GUAINE TERMORETRAIBILI
VARIE MISURE
PACK OF 5 HEAT SHRINKABLE TUBE IN
DIFFERENT MEASURES



24 633 0340



NEW

SERIE RUBACORRENTE - CABLE CLAMPS
15 (Pz-Pcs)





24 649 0020 

PRESA BASSA TENSIONE- L.T. SOCKET ASSY
PIAGGIO: Vespa 50-90 Primavera
 (R.O. 070744)



24 649 0030 

PRESA BASSA TENSIONE-L.T. SOCKET ASSY
PIAGGIO: Vespa 125 • Gt-Rally
 (R.O. 120811)



24 649 0133 

PRESA DI CORRENTE - L.T. SOCKET ASSY
 Vespa Px 125-150-T5
 VNX2-VLX2-VSX2-VNX5T
 (R.O. 178895)



24 649 0280 

PRESA BASSA TENSIONE
L.T. SOCKET ASSY
 Vespa Et3 VMB1
 (R.O. 185458)



24 649 0310 

PRESA DI CORRENTE - L.T. SOCKET ASSY
PIAGGIO 125: Vespa Gtr
150: Sprint Veloce • Super
200: Rally
 (R.O. 149082)



24 649 0330 

PRESA DI CORRENTE - L.T. SOCKET ASSY
 Vespa Pxe 125-150-200
 VNX-VLX-VSX
 (R.O. 163476)



24 649 0320 

PRESA DI CORRENTE - L.T. SOCKET ASSY
 Vespa PX 125-50-200
 VNX-VLX-VSX
 Modello con frecce - *Blinkers Model*
 (R.O. 163603)



24 649 0200 

GUAINA CABLAGGIO - ELECTRIC SHEATH
PIAGGIO: Vespa
 Vari Modelli Vespa - *Varios Vespa Models*
 (R.O. 610076M)



12 183 0560 

CAPPUCCIO BOBINA - COIL CAP
PIAGGIO 50-125: Vespa Pk • Rush • N
 (R.O. 231751)



12 183 0570 

CAPPUCCIO CENTRALINA - CDI UNIT CAP
PIAGGIO 50-125: Vespa Pk • Rush • N
 (R.O. 255526)



12 183 0580 

CAPPUCCIO CENTRALINA - CDI UNIT CAP
PIAGGIO 125-150-200: Vespa Px • Cosa 1-2
 (R.O. 198686)



12 183 0910 

CAPPUCCIO BOBINA - COIL CAP
PIAGGIO: Vespa 150 • 150 GI-180 Rally
 Vba1tvbb1/2T-15 • Vla1t-Vsd1t
 (R.O. 048525)



NEW



CONDENSATORI
CONDENSERS

24 619 0010



PIAGGIO 50-125: Vespa
(R.O. 078937)



24 619 0020



PIAGGIO 50: Vespa • Ape • P
125: Vespa P
(R.O. 079697)



24 619 0030



PIAGGIO 125-150: Vespa Px
(R.O. 182343)



24 619 0040



PIAGGIO 550: Ape Mvp
600: Ape Mp • Ape Mpv
(R.O. 123828)



24 619 0050



PIAGGIO 50: Si • Bravo • Ciao • Boxer • Grillo
(R.O. 102939)



24 619 0060



PIAGGIO 125: Vespa Gtr
150: Sprint GL • Super
180: Rally
(2 Fili - 2 wires)
(R.O. 155973)



24 619 0070



PIAGGIO: Vespino Spagna



24 619 0080



PIAGGIO 125: Vespa
150: Vespa Gs
(R.O. 018941)



24 619 0090



PIAGGIO 125-150: Vespa Super
(R.O. 133052)



24 619 0110



INNOCENTI 125-150-200: Lambretta Li



24 619 0120



INNOCENTI 125-150-200: Lambretta DL





24 615 0010 

PIAGGIO 50: Ciao • Bravo • Boxer • Si Ape • Cba
(R.O. 103133)



24 615 0020 

PIAGGIO 50: Vespa • Special • L • R • N
(R.O. 101761)



24 615 0030 

PIAGGIO 50: Ape • Ape P 71>
90-125: Vespa Primavera • Ape
180: Rally 72>
(R.O. 141838)



24 615 0040 

PIAGGIO 550: Ape Mp
600: Ape Mpv • Ape Mp
(R.O. 118540)



24 615 0050 

PIAGGIO 150: Vespa Sprint • Gtr • Super
400-500: Ape 71>
(R.O. 129434)



24 615 0060 

PIAGGIO 150: Vespa Px 1° serie
(Impianto Bobina - *Models with coil*)
Vespa Sprint • Super 74>
400: Ape P
(R.O. 140963)



24 615 0070 

PIAGGIO 125-150: Vespa Px Modello con frecce
Models with flashers
(R.O. 134117/182342)



24 615 0080 

PIAGGIO 125: Vespa Vnb4t-Vnb5t-Vns4t-
Vespa Gt VNL1T
150: Vespa GL VLA1T
(R.O. 97478)



24 615 0090 

PIAGGIO 180: Vespa Rally-Super Sport
200: Rally VSC1T-VSD1T-VSE1T
(R.O. 111300)



24 615 0100 

PIAGGIO: Vespino Spagna



24 615 0120 

PIAGGIO 98-125: Vespa
(R.O. 610075M)



24 615 0130 

PIAGGIO 150: Vespa Gs
(R.O. 097477)



24 615 0140 

INNOCENTI 125-150-200: Lambretta Li - DL



24 615 0150

CONTATTI KS436
KS436 CONTACT BREAKER



24 615 0160

CONTATTI KS458
KS458 CONTACT BREAKER



24 615 0170

CONTATTI KS465
KS465 CONTACT BREAKER



24 615 0180

CONTATTI KS466
KS466 CONTACT BREAKER



24 615 0190

CONTATTI KS469
KS469 CONTACT BREAKER



24 615 0200

CONTATTI KS710
KS710 CONTACT BREAKER



24 615 0210

CONTATTI KS183
KS183 CONTACT BREAKER



24 619 0130

CONDENSATORI ZK100
ZK100 CONDENSER



24 619 0150

CONDENSATORI ZK213
ZK213 CONDENSER



24 619 0160

CONDENSATORI ZK235
ZK235 CONDENSER



Modello - Model	cc	Anno Year	Contatti Contact Breakers	Condensatore Condenser	Modello - Model	cc	Anno Year	Contatti Contact Breakers	Condensatore Condenser
AGRATI-GARELLI					Sei 1st Series 900 79 24 603 0330				
Bonanza	50	70-76	24 615 0180		BMW				
Bonanza	50	76-80	24 615 0170	24 619 0150	R 45	450	80-85	24 601 0600	
Bonanza	50	81-81	24 615 0200	24 619 0160	R 45/N	450	80-85	24 601 0600	
Bonanza 25	50	76-76	24 615 0180	24 619 0150	R 45/N/T/TN	450	78-85	24 603 0330	
Bonanza 25	50	76-80	24 615 0170	24 619 0150	R 50/2	500	67-69	24 603 0330	
Bonanza 25	50	81-00	24 615 0200	24 619 0160	R 50/5	500	69-75	24 603 0330	
Eureka Flex	50	71-00	24 615 0160	24 619 0160	R 60/5	600	69-75	24 603 0330	
Eureka Matic	50	72-73		24 619 0130	R 60/6	600	73-77	24 603 0330	
Eureka Matic	50	73-80	24 615 0160	24 619 0160	R 60/7	600	76-81	24 603 0330	
Eureka MK	50	78-80	24 615 0160	24 619 0160	R 60/7 TIC	600	78-81	24 603 0330	
Europed 40 SL	50	72-73		24 619 0130	R 69 S	600	61	24 603 0330	
Europed 40 SL	50	73-80	24 615 0160	24 619 0160	R 65	650	78-88	24 603 0330	
Europed SL	50	71-73		24 619 0130	R 65 GS	650	87-92	24 601 0600	
Europed SL	50	74-80	24 615 0160	24 619 0160	R 65 GS	650	87-93	24 603 0330	
GT	50	76-80	24 615 0170	24 619 0150	R 65 LS	650	81-85	24 603 0330	
Katia	50	78-81	24 615 0160	24 619 0160	R 65 RT	650	85-89	24 603 0330	
Katia 1 VN, 2 VN	50	81-00	24 615 0160	24 619 0160	R 65 T	650	81-85	24 603 0330	
NOI	50	79-00	24 615 0160	24 619 0160	R 65/20	650	85-94	24 603 0330	
NOI Matic 2 V	50	80-00	24 615 0160	24 619 0160	R 65/35	650	85-89	24 603 0330	
NOI Matic KL	50	81-00	24 615 0160	24 619 0160	R 75/5	750	69-75	24 603 0330	
NOI Self Mix	50	82-00	24 615 0160	24 619 0160	R 75/6	750	73-77	24 603 0330	
VIP 1 (RA)	50	81-81	24 615 0200	24 619 0160	R 75/7	750	76-79	24 603 0330	
VIP 1/2/3/4 VN	50	81-00	24 615 0200	24 619 0160	R 75/7	750	76-79	24 603 0330	
VIP 3 (A, B)	50	81-00	24 615 0200	24 619 0160	R 80	800	77-85	24 603 0330	
VIP 3 V	50	78-80	24 615 0170	24 619 0150	R 80	800	85-95	24 603 0330	
VIP 3 V	50	81-81	24 615 0200	24 619 0160	R 80 G/S/PD	800	80-87	24 603 0330	
VIP 4 V	50	79-80	24 615 0170	24 619 0150	R 80 GS	800	80-87	24 601 0600	
VIP 4 V	50	81-81	24 615 0200	24 619 0160	R 80 GS	800	90-95	24 601 0600	
Mokick Cross, Sport		76-78	24 615 0170	24 619 0150	R 80 GS Basic	800	96	24 603 0330	
BATAVUS					R 80 GS Basic	800	96-96	24 601 0600	
Ascot	50	79-00	24 615 0160	24 619 0160	R 80 GS, BD	800	87-95	24 601 0600	
Batavette 21	50	70-73		24 619 0150	R 80 GS/PD/CH	800	87-96	24 603 0330	
Batavette A	50	79-79	24 615 0170	24 619 0150	R 80 R	800	91-95	24 603 0330	
Batavette S	50	79-85	24 615 0200	24 619 0160	R 80 R Mystic	800	94-95	24 603 0330	
Bingo (40 km/h)	50	74-80	24 615 0170	24 619 0150	R 80 RT	800	82-85	24 603 0330	
Bingo V 25, VA 25	50	74-80	24 615 0170	24 619 0150	R 80 RT	800	84-85	24 601 0600	
Bronco (40 km/h)	50	75-77	24 615 0170	24 619 0150	R 80 RT	800	85-95	24 601 0600	
Go-Go	50	70-74	24 615 0170	24 619 0150	R 80 RT	800	85-96	24 603 0330	
Go-Go (HS 50)	50	75-81	24 615 0170	24 619 0150	R 80 ST	800	82-84	24 601 0600	
Go-Go VA 25	50	75-79	24 615 0170	24 619 0150	R 80 ST	800	82-84	24 603 0330	
Grand Prix	50	81-00	24 615 0200	24 619 0160	R 80 TIC	800	78-85	24 603 0330	
HS 50	50	77-79	24 615 0160	24 619 0160	R 80/7	800	75-84	24 603 0330	
HS 60	50	79-79	24 615 0170	24 619 0150	R 90 S	900	73-77	24 603 0330	
HS 60	50	79-81	24 615 0200	24 619 0160	R 90/6	900	73-76	24 603 0330	
Mini Batavette	50	70-74	24 615 0170	24 619 0150	R 100 GS Dakar Classic	980	95-96	24 601 0600	
MK 2	50	74-78	24 615 0170	24 619 0150	R 100 GS, Dakar	980	87-95	24 601 0600	
Mot-O-Mat	50	75-79	24 615 0170	24 619 0150	R 100 GS, PD	980	92-96	24 601 0600	
Mot-O-Mat	50	79-85	24 615 0200	24 619 0160	R 100 R, R Mystic	980	91-96	24 601 0600	
Mot-O-Mat (Saxonette)	50	70-74	24 615 0170	24 619 0150	R 100 RS	980	80-84	24 601 0600	
Pronto VA 25, VA 40	50	76-80	24 615 0160	24 619 0160	R 100 RT	980	80-84	24 601 0600	
Starflite Bronco 25, 40	50	74-77	24 615 0170	24 619 0150	R 100, CS	980	80-84	24 601 0600	
Starflite GTM	50	74-77	24 615 0170	24 619 0150	K 1	1000	88-93	24 601 0610	
Starflite Swing 25, 40	50	76-79	24 615 0160	24 619 0160	K 100 RS	1000	89-92	24 601 0610	
Starflite Tramp Junior, Luxus, Tramp 40	50	74-77	24 615 0170	24 619 0150	R 100 CS	1000	80-85	24 603 0330	
TS 49	50	72-76	24 615 0170	24 619 0150	R 100 GS/PD	1000	87-96	24 603 0330	
TS 49 S	50	72-76	24 615 0180	24 619 0130	R 100 R Classic	1000	91-96	24 603 0330	
BENELLI					R 100 R Mystic	1000	94-96	24 603 0330	
S 50	50	81-89	24 615 0200	24 619 0160	R 100 RS/RT	1000	76-96	24 603 0330	
GTS Moto Guzzi	350	74	24 603 0330		R 100 S	1000	76-81	24 603 0330	
RS	350	77	24 603 0330		R 100 TIC Touring	1000	81-85	24 603 0330	
Touring/Sport	354	80	24 603 0330		R 100/7/T/7T	1000	76-85	24 603 0330	
GTS Moto Guzzi	400	74	24 603 0330		K 1100 LT	1100	92-99	24 601 0610	
Sport	504	80	24 603 0330		K 1100 LT High Line	1100	97-99	24 601 0610	
Tornado S 2nd Series	650	72-76	24 603 0330		K 1100 LT Special Edition	1100	94-99	24 601 0610	
Sport	654	80	24 603 0330		K 1100 RS	1100	93-96	24 601 0610	
Sei	750	75	24 603 0330						

Modello - Model	cc	Anno Year	Contatti Contact Breakers	Condensatore Condenser	Modello - Model	cc	Anno Year	Contatti Contact Breakers	Condensatore Condenser
CLAEYS - FLANDRIA					MK 3 M, 4 M	50	72-74	24 615 0170	24 619 0150
037 AF-F, AF-A	50	76-81	24 615 0160	24 619 0160	Mofa M 1, M 2	50	74-77	24 615 0160	24 619 0160
Daytona 4	50	76-81	24 615 0170	24 619 0150	Mofa M 3	50	72-74	24 615 0160	24 619 0160
Gigi	50	76-81	24 615 0160	24 619 0160	Mofa M 4, M 5	50	74-78	24 615 0170	24 619 0150
Karina, Karina S	50	76-81	24 615 0170	24 619 0150	MP 2, 4	50	72-77	24 615 0170	24 619 0150
Penny, Penny S, Polo	50	76-81	24 615 0160	24 619 0160	Optima MP 4, 3, P 3, 3 S	50	78-79	24 615 0170	24 619 0150
Record 4	50	76-81	24 615 0170	24 619 0150	P 1 Moped	50	72-77	24 615 0170	24 619 0150
Scrab	50	76-81	24 615 0170	24 619 0150	P 3	50	74-77	24 615 0170	24 619 0150
Apollo		71-76	24 615 0170	24 619 0150	Prima 1, 2, 2 N	50	78-00	24 615 0160	24 619 0160
Apollo AF		71-76		24 619 0150	Prima 4 S	50	79-79	24 615 0170	24 619 0150
Bang		71-74	24 615 0170	24 619 0150	Prima 4, 4 N	50	78-79	24 615 0170	24 619 0150
Bang		74-75	24 615 0170	24 619 0130	Prima 4, 4 N	50	79-00	24 615 0200	24 619 0160
Comet IV, CT 637 S		74-76	24 615 0170	24 619 0150	Prima 5 S	50	79-80	24 615 0200	24 619 0160
Diana AF		71-76		24 619 0150	Prima 5, 5 N	50	78-79	24 615 0170	24 619 0150
Furie		71-74	24 615 0170	24 619 0150	Prima 5, 5 N	50	79-00	24 615 0200	24 619 0160
Furie		74-75	24 615 0170	24 619 0130	Prima 6	50	79-80	24 615 0200	24 619 0160
Futura		71-76		24 619 0150	Prima G 3	50	79-00	24 615 0200	24 619 0160
Indiana		74-76	24 615 0170	24 619 0150	Prima S	50	80-00	24 615 0170	24 619 0130
Iris		71-74	24 615 0170	24 619 0150	Roller 50	50	70-77	24 615 0170	24 619 0150
Iris		74-75	24 615 0170	24 619 0130	SB 1 Sport-Bike	50	72-76	24 615 0180	24 619 0130
Luna		71-76	24 615 0170	24 619 0150	SB 2 Sport-Bike	50	72-79	24 615 0170	24 619 0150
Luna AF, Mini Futura		71-76		24 619 0150	K 125 BW Military	125	74-00	24 615 0180	24 619 0130
Mistral		71-74	24 615 0170	24 619 0150	W 2000	294	74-78	24 615 0180	24 619 0130
Mistral		74-75	24 615 0170	24 619 0130	KREIDLER				
Rallye, Record		71-74	24 615 0170	24 619 0150	Flory SL	50	77-80	24 615 0170	24 619 0150
Rallye, Record		74-75	24 615 0170	24 619 0130	MF 2, C, CL	50	72-82	24 615 0160	24 619 0160
SP 537 SC, SP 547		74-75	24 615 0170	24 619 0130	RM (K 54/421)	50	73-82	24 615 0170	24 619 0130
SP 747		71-74	24 615 0170	24 619 0150	RMC .. (K 54/421)	50	76-82	24 615 0170	24 619 0130
SP 747		74-75	24 615 0170	24 619 0130	RS .. (54/53) F, (K 54/504)	50	76-82	24 615 0180	24 619 0130
Tornado		71-74	24 615 0170	24 619 0150	Flory (MF 12, 13)		76-80	24 615 0170	24 619 0150
Tornado		74-75	24 615 0170	24 619 0130	Flory (MF 12, 13)		80-80	24 615 0200	24 619 0160
CYRUS					Flory (MF 20, 22)		79-82	24 615 0170	24 619 0130
Royal Super	49	72-75	24 615 0180	24 619 0130	Flory SL (MF 23)		80-80	24 615 0200	24 619 0160
Royal S 5, Royal Trial 80	73	72-75	24 615 0180	24 619 0130	LF (K 54/307), LF (K 54/308) B		76-78	24 615 0170	24 619 0130
DKW (ZWEIRAD-UNION)					LF (K 54/310) Export		73-78	24 615 0170	24 619 0130
530	50	76-83	24 615 0160	24 619 0160	LF (K 54/319)		77-78	24 615 0170	24 619 0130
532 - 534	50	76-83	24 615 0170	24 619 0150	LF (K 54/32)		70-75	24 615 0170	24 619 0130
533 - 535	50	76-83	24 615 0200	24 619 0160	LF-F		78-82	24 615 0170	24 619 0130
139 Jet		72-76	24 615 0180	24 619 0130	LH (K 53/302) Export		73-75	24 615 0170	24 619 0130
139 M		72-76	24 615 0170	24 619 0150	LH (K 54/307)		76-77	24 615 0170	24 619 0130
159 Jet		72-76	24 615 0180	24 619 0130	LH (K 54/32)		70-75	24 615 0170	24 619 0130
504 M, 505 P, 506 M, 510		72-76		24 619 0150	MF 4		70-73		24 619 0150
629, 630, 632		72-76	24 615 0170	24 619 0150	MF 4		73-74	24 615 0160	24 619 0160
Sportmofa		80-00	24 615 0200	24 619 0160	Mokick 40		76-82	24 615 0180	24 619 0130
FANTIC					MP 19 (Export)		78-82	24 615 0160	24 619 0160
174 Lei	50	80-81	24 615 0160	24 619 0160	MP 2, MP 7 Export		73-73		24 619 0150
317 issimo Moped	50	78-81	24 615 0160	24 619 0160	MP 2, MP 7 Export		73-82	24 615 0160	24 619 0160
Issimo Sport	50	81-84	24 615 0160	24 619 0160	TM (K 54/508) Export		72-76	24 615 0180	24 619 0130
317 issimo Mokick		80-81	24 615 0160	24 619 0160	TM (K 54/54) Export		73-76	24 615 0180	24 619 0130
TX 172 Lei 25 km/h		78	24 615 0160	24 619 0160	KTM				
TX 174 Lei 40 km/h, TX 310 issimo		79-81	24 615 0160	24 619 0160	Comet	50	76-83	24 615 0170	24 619 0150
HERCULES					Mofa , Moped	50	81-00	24 615 0200	24 619 0160
C 1, C 2 City Bike	50	72-74		24 619 0150	Mofa, Moped	50	76-81	24 615 0170	24 619 0150
C 3 City Bike	50	74-78		24 619 0150	MAICO				
HR 1 Hobby Rider	50	72-74	24 615 0170	24 619 0150	MD 50/6	50	72-00	24 615 0180	24 619 0130
HR 2 Hobby Rider	50	74-79	24 615 0170	24 619 0150	125 GS/6	125	70-83	24 615 0180	24 619 0130
HR 2 Hobby Rider	50	79-87	24 615 0200	24 619 0160	Mofa 25		78-00	24 615 0160	24 619 0160
Lastboy	50	72-74	24 615 0170	24 619 0150	MOTO GUZZI				
MF 3	50	72-74	24 615 0170	24 619 0150	V 35	350	77-80	24 603 0330	
MK 1 S	50	78-79	24 615 0170	24 619 0150	V 35 C Custom	350	81-86	24 603 0330	
MK 1, MK 2	50	74-77	24 615 0170	24 619 0150	V 35 Carabinieri/PA	350	92-1	24 603 0330	
MK 2 S	50	79-80	24 615 0200	24 619 0160	V 35 Florida	350	86-90	24 603 0330	

CONDENSATORI E CONTATTI

CONDENSERS AND CONTACT BREAKERS



Modello - Model	cc	Anno Year	Contatti Contact Breakers	Condensatore Condenser	Modello - Model	cc	Anno Year	Contatti Contact Breakers	Condensatore Condenser
V 35 II	350	80-85	24 603 0330		High-Sport Super L	50	79-00	24 615 0200	24 619 0160
V 35 III	350	85-92	24 603 0330		Libelle E 21, E 23	50	74-78	24 615 0170	24 619 0150
V 35 Imola	350	79-80	24 603 0330		Libelle FT, FTH	50	74-78	24 615 0160	24 619 0160
V 35 Imola/II	350	80	24 603 0330		Libelle GHT	50	76-79	24 615 0170	24 619 0150
V 35 TT	350	84-86	24 603 0330		Libelle GHT	50	79-00	24 615 0200	24 619 0160
V 50	500	76-80	24 603 0330		Libelle GTH	50	74-76	24 615 0160	24 619 0160
V 50 C Custom	500	82-86	24 603 0330		Libelle High Sport Super R 503	50	74-78	24 615 0170	24 619 0160
V 50 II	500	79-80	24 603 0330		Libelle High-Sport Super R 503	50	78-79	24 615 0170	24 619 0150
V 50 III	500	80-84	24 603 0330		Libelle High-Sport Super R 503	50	79-80	24 615 0200	24 619 0160
V 50 III PA/Polizia	500	82-90	24 603 0330		Libelle High-Sport Super R 503	50	80-00	24 615 0170	24 619 0130
V 50 Monza	500	80-85	24 603 0330		RS 50 B III, B IV	50	78-82	24 615 0170	24 619 0150
V 50 PA/Polizia	500	92-01	24 603 0330		Standard, H	50	74-78	24 615 0170	24 619 0150
NTX	650	87-90	24 603 0330		Tourismo 4	50	74-78	24 615 0170	24 619 0150
V 65	650	82-87	24 603 0330		Tourismo E 21 E, EL	50	79-00	24 615 0200	24 619 0160
V 65 Custom	650	82-87	24 603 0330		Tourismo E 21, E, EL	50	76-79	24 615 0170	24 619 0150
V 65 Florida	650	85-94	24 603 0330		Tourismo SL 40	50	78-79	24 615 0170	24 619 0150
V 65 PA/Polizia	650	88-95	24 603 0330		Tourismo SL 40	50	79-00	24 615 0200	24 619 0160
V 65 SP	650	82-87	24 603 0330		SOLO				
V 65 TT	650	84-89	24 603 0330		708	50	73-73		24 619 0150
S	750	74	24 603 0330		708	50	73-73	24 615 0160	24 619 0160
S 3	750	75	24 603 0330		704 City Bike	50	73-74	24 615 0160	24 619 0160
V 7 Sport	750	71-73	24 603 0330		704 City-Bike	50	73-73		24 619 0150
V 75	750	85-90	24 603 0330		710 D	50	72-73		24 619 0150
V 75 PA/Polizia	750	92-96	24 603 0330		710 D	50	73-76	24 615 0160	24 619 0160
V7 Spezial VM	750	69-71	24 615 0210		711 C	50	72-73		24 619 0150
V7 Sport VK	750	72-74	24 615 0210		711 C	50	73-76	24 615 0160	24 619 0160
X Polizia	750	92-02	24 603 0330		712 Super-Luxus	50	78-00	24 615 0160	24 619 0160
Le Mans I/II/III	850	76-84	24 603 0330		712, 713	50	75-80	24 615 0160	24 619 0160
T	850	75-77	24 603 0330		715, 716	50	72-73		24 619 0150
T3/Base/California/T4	850	79-85	24 603 0330		715, 716	50	73-75	24 615 0160	24 619 0160
T5 I/II/III Series	850	83-88	24 603 0330		725, 726	50	76-77	24 615 0160	24 619 0160
T5 Polizia/Carabinieri/PA	850	85-89	24 603 0330		725, 726 Mini-Bike	50	77-00	24 615 0160	24 619 0160
V7 California VP	850	72-74	24 615 0210		731, 732 (Sport)	50	78-82	24 615 0160	24 619 0160
V7 GT VP	850	72-74	24 615 0210		731-D	50	80-82	24 615 0160	24 619 0160
California II	1000	78-85	24 603 0330		Mars 25 De Luxe (712)	50	72-73		24 619 0150
G5	1000	78-85	24 603 0330		Mars 25 De Luxe (712)	50	73-80	24 615 0160	24 619 0160
G5 V Civile/PA	1000	78-85	24 603 0330		Mars 40 De Luxe (713 B)	50	72-73		24 619 0150
GT	1000	87-93	24 603 0330		Mars 40 DE Luxe (713)	50	73-80	24 615 0160	24 619 0160
Le Mans IV/V	1000	84-93	24 603 0330		Mars Komfort 25, Luxus	50	80-00	24 615 0160	24 619 0160
SP	1000	79-83	24 603 0330		Mars Komfort Super 25	50	80-00	24 615 0160	24 619 0160
SP II	1000	83-88	24 603 0330		Mars Standard 25 (710)	50	72-73		24 619 0150
V I-Confort Civile/PA	1000	75-84	24 603 0330		Mars Standard 25 (710)	50	73-76	24 615 0160	24 619 0160
Nuovo Trotter 25, 40		70-73	24 615 0170	24 619 0150	Mars Standard 25 (710)	50	73-76	24 615 0160	24 619 0160
MOTOBECANE					Mars Super-Luxus 40	50	78-00	24 615 0160	24 619 0160
Monty L, SP	0	77-00	24 615 0160	24 619 0160	Mars Top Rider 25 (717)	50	72-73		24 619 0150
TM 4, TM 4 Luxus	0	79-00	24 615 0160	24 619 0160	Mars Top Rider 25 (717)	50	73-74	24 615 0160	24 619 0160
Monty MB 3 V, SB 3 V	50	77-83	24 615 0160	24 619 0160	Mars Top Rider 40 (718)	50	72-73		24 619 0150
MV AGUSTA					Mars Top Rider 40 (718)	50	73-74	24 615 0160	24 619 0160
750 S	750	73	24 615 0190		MK 40 (740), MS 40	50	79-00	24 615 0170	24 619 0130
750 S	750	73	24 615 0190		MS 25 Sport 2 (735)	50	80-00	24 615 0170	24 619 0130
750 S Sport America	750		24 615 0190		MS 25 Sport 3	50	80-00	24 615 0170	24 619 0130
800 S	800	75-80	24 615 0190		SPARTA				
900 S	900	75-80	24 615 0190		Buddy	50	79-79	24 615 0200	24 619 0160
ODYSSEE					Buddy	50	79	24 615 0170	24 619 0150
710 U, 711, 712 U	50	76-81	24 615 0170	24 619 0130	Buddy	50	79	24 615 0160	24 619 0160
713 U, 714 U, 715 U	50	76-81	24 615 0170	24 619 0130	Happy	50	78-79	24 615 0170	24 619 0150
RIXE					Happy	50	79-81	24 615 0200	24 619 0160
Champion FTH	50	76-79	24 615 0170	24 619 0150	Lucky	50	78-79	24 615 0160	24 619 0160
Champion FTH	50	79-00	24 615 0200	24 619 0160	Rocky	50	78-81	24 615 0160	24 619 0160
Champion FTH, FT	50	74-76	24 615 0160	24 619 0160	STEYR-DAIMLER-PUCH				
Champion FTH, FT	50	79-00	24 615 0200	24 619 0160	Dakota 3000	50	75-80	24 615 0170	24 619 0150
Derby B	50	74-78	24 615 0170	24 619 0150	Dakota 3000	50	80-00	24 615 0170	24 619 0130
FTH, FT	50	76-79	24 615 0170	24 619 0150	DS 50 L (A)	50	74-80	24 615 0170	24 619 0130
Geschäftsmoped	50	74-78	24 615 0170	24 619 0150	M 50 Cross (A)	50	72-00	24 615 0170	24 619 0130
High-Sport	50	76-79	24 615 0170	24 619 0150	M 50 Grand Prix (A)	50	74-79	24 615 0170	24 619 0130
High-Sport	50	79-00	24 615 0200	24 619 0160	M 50 Racing	50	73-78	24 615 0170	24 619 0130
High-Sport Super L	50	78-79	24 615 0170	24 619 0150	M 50 S (A)	50	71-77	24 615 0170	24 619 0130
					M 50 SG, M 50 Sport (A)	50	74-78	24 615 0170	24 619 0130

Modello - Model	cc	Anno Year	Contatti Contact Breakers	Condensatore Condenser	Modello - Model	cc	Anno Year	Contatti Contact Breakers	Condensatore Condenser
Maxi	50	69-79	24 615 0170	24 619 0150	ZL 25	50	80-82	24 615 0170	24 619 0130
Maxi	50	79-00	24 615 0200	24 619 0160	ZR 10	50	77-80	24 615 0160	24 619 0160
Maxi 2-25	50	73-79	24 615 0170	24 619 0150	ZR 20	50	76-80	24 615 0160	24 619 0160
Maxi 2-25	50	79-00	24 615 0200	24 619 0160	ZR 30	50	77-79	24 615 0160	24 619 0160
Maxi L (A)	50	71-79	24 615 0170	24 619 0150	ZS 25	50	81-82	24 615 0170	24 619 0130
Maxi L (A)	50	79-00	24 615 0200	24 619 0160	ZX 25	50	79-81	24 615 0170	24 619 0150
Maxi L 2	50	78-79	24 615 0170	24 619 0150	ZX 25	50	81-84	24 615 0200	24 619 0160
Maxi L 2	50	79-82	24 615 0200	24 619 0160					
Maxi S	50	72-79	24 615 0170	24 619 0150					
Maxi S	50	79-00	24 615 0200	24 619 0160					
Maxi Sport	50	77-79	24 615 0170	24 619 0150					
Maxi Sport	50	79-00	24 615 0200	24 619 0160					
Maxi Stockvis/Casablanca	50	72-73	24 615 0170	24 619 0150					
MC 50-3	50	78-81	24 615 0170	24 619 0130					
MS 25	50	64-78	24 615 0170	24 619 0150					
MS 50 V	50	69-78	24 615 0170	24 619 0150					
MV 50 Stockvis/Casablanca	50	72-79	24 615 0170	24 619 0150					
MV 50 Stockvis/Casablanca	50	79-80	24 615 0200	24 619 0160					
MV 50 Super	50	75-80	24 615 0170	24 619 0150					
N 50-4 Monza	50	76-81	24 615 0170	24 619 0130					
N 50-4 Monza	50	82-00	24 615 0200	24 619 0160					
VS 50	50	64-77	24 615 0170	24 619 0150					
X 30 A	50	74-79	24 615 0170	24 619 0150					
X 30 A	50	79-81	24 615 0200	24 619 0160					
X 30 N	50	74-79	24 615 0170	24 619 0150					
X 30 N	50	79-00	24 615 0200	24 619 0160					
X 40 M	50	78-79	24 615 0170	24 619 0150					
X 40 M	50	79-83	24 615 0200	24 619 0160					
X 50-2 M	50	78-82	24 615 0170	24 619 0130					
X 50-3	50	78-82	24 615 0200	24 619 0160					
SWM									
Mini Cross 50	50	79-00	24 615 0160	24 619 0160					
TL 320 MW, NW	275	80-00	24 615 0170	24 619 0130					
TOMOS									
4 L (4-Gang)	50	74-78	24 615 0170	24 619 0150					
A 3	50	74-81	24 615 0170	24 619 0150					
A 3	50	81-82	24 615 0200	24 619 0160					
Mini B 1	50	78-81	24 615 0170	24 619 0150					
Mini B 1	50	81-00	24 615 0200	24 619 0160					
ST 50, Sport 50	50	74-78	24 615 0180	24 619 0130					
ZUNDAPP									
Automatic-Mofa	50	70-73		24 619 0150					
Automatic-Mofa	50	72-73		24 619 0150					
Automatic-Mofa	50	73-76	24 615 0160	24 619 0160					
Automatic-Mofa	50	73-76	24 615 0160	24 619 0160					
C 50 Sport	50	69-79	24 615 0170	24 619 0130					
C 50 Super	50	69-76	24 615 0170	24 619 0130					
CS 25	50	80-84	24 615 0170	24 619 0130					
CS 50	50	79-84	24 615 0170	24 619 0130					
GTS 50 (4-Gang)	50	72-79	24 615 0170	24 619 0130					
GTS 50 (5-Gang)	50	79-82	24 615 0170	24 619 0130					
Hai 25	50	80-82	24 615 0170	24 619 0130					
Hai 50	50	80-82	24 615 0170	24 619 0130					
High-Riser	50	72-73		24 619 0150					
High-Riser	50	73-76	24 615 0160	24 619 0160					
KS 50 Cross	50	72-74	24 615 0180	24 619 0130					
KS 50 Sport	50	76-78	24 615 0180	24 619 0130					
KS 50 Super Sport	50	71-75	24 615 0180	24 619 0130					
M 50, Mofa 25	50	70-77	24 615 0170	24 619 0150					
R 50	50	70-82	24 615 0170	24 619 0130					
RS 50 Super	50	65-79	24 615 0180	24 619 0130					
ZA 25	50	79-84	24 615 0160	24 619 0160					
ZA 40, ZB 22	50	78-80	24 615 0160	24 619 0160					
ZD 10	50	77-79	24 615 0160	24 619 0160					
ZD 25 TS	50	78-79	24 615 0170	24 619 0130					
ZD 30, ZD 20	50	79-80	24 615 0170	24 619 0130					
ZD 40	50	76-82	24 615 0170	24 619 0130					
ZD 50 TS	50	78-80	24 615 0170	24 619 0130					

▶ GOMME
TIRES

▶ CAMERE D'ARIA
TUBES

▶ **KENDA**

▶ 
DURO

IL LINGUAGGIO DELLE SCOLPITURE	
COMAND 2	Stradale
MAC P	Stradale posteriore
MICH	Scolpitura tradizionale stradale
MICH M+S	 Scolpitura tradizionale stradale invernale
BOPP	Sportivo stradale
ROAD	Stradale
REGGAE	Tassellato largo doppio uso
MAC F	Stradale anteriore
SLICK	Scolpitura liscia stradale
DEXT	Tassello misto stradale
DEXT M+S	Tassello misto stradale - <i>All seasons</i>
DRAGO F	Scolpitura liscia stradale anteriore
DRAGO	Scolpitura liscia stradale posteriore
COMAND P	Stradale posteriore
DRAKE	Scolpitura liscia stradale posteriore
ROCK	Sterrato
UNIK	Tassellato medio stradale
CHOCOLATE	Tassello alto fuoristrada
CLASSIC	Tassello quadro stradale

COME "SCEGLIERE" UN PNEUMATICO - HOW TO "CHOOSE" A TYRE	
1	Marchio di fabbrica - <i>Trade-Mark</i>
2	Senso di rotolamento - <i>Sense of Rotation</i>
3	Pneumatico senza camera aria - <i>Tyre without tube "Tubeless"</i>
4	Simbolo categoria velocità - <i>Category Speed Symbol</i>
5	Indice di carico - <i>Load Index</i>
6	Tipo di battistrada - <i>Tyre Tread Type</i>
7	Diametro nominale di calettamento (in pollici) - <i>Nominal Keying Diameter (in inches)</i>
8	Rapporto altezza/sezione H/S - <i>Ratio Height/Section H/S</i>
9	Larghezza nominale di sezione (mm) - <i>Nominal Section Length (mm)</i>

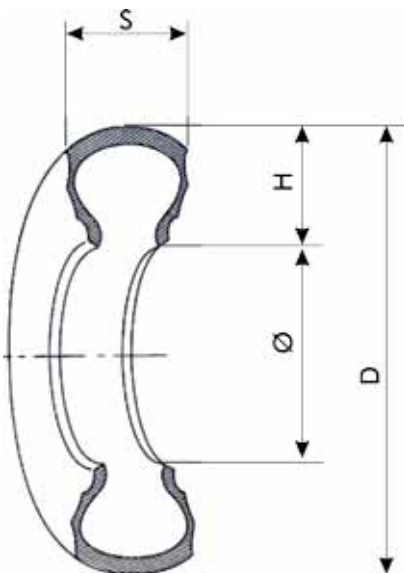
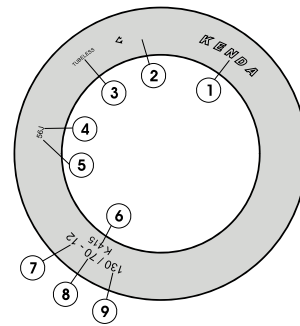

LE "MISURE" DEL PNEUMATICO - THE "MEASURES" OF THE TYRE	
D	Diametro esterno - <i>External Diameter</i>
H	Altezza di sezione - <i>Section Height</i>
S	Sezione massima del pneumatico - <i>Maximum Tyre Section</i>
Ø	Diametro di calettamento - <i>Keying Diameter</i>



INDICE DI CARICO - LOAD INDEX								
LI	KG.	LBS	LI	KG.	LBS	LI	KG.	LBS
19	77,5	112,7	47	175	254,4	75	387	562,5
20	80	116,3	48	180	261,6	76	400	581,4
21	82,5	119,9	49	185	268,9	77	412	598,9
22	85	123,6	50	190	276,2	78	425	617,8
23	87,5	127,2	51	195	283,5	79	437	635,2
24	90	130,8	52	200	290,7	80	450	654,1
25	92,5	134,5	53	206	299,4	81	462	671,6
26	95	138,1	54	212	308,2	82	475	690,5
27	97,5	141,7	55	218	316,9	83	487	707,9
28	100	145,4	56	224	325,6	84	500	726,8
29	103	149,7	57	230	334,3	85	515	748,6
30	106	154,1	58	236	343	86	530	770,4
31	109	158,4	59	243	353,2	87	545	792,2
32	112	162,8	60	250	363,4	88	560	814
33	115	167,2	61	257	373,6	89	580	843,1
34	118	171,5	62	265	385,2	90	600	872,2
35	121	175,9	63	272	395,4	91	615	894
36	125	181,7	64	280	407	92	630	915,8
37	128	186,1	65	290	421,5	93	650	944,8
38	132	191,9	66	300	436,1	94	670	973,9
39	136	197,7	67	307	446,3	95	690	1003
40	140	203,5	68	315	457,9	96	710	1032,1
41	145	210,8	69	325	472,4	97	730	1061,1
42	150	218	70	335	487	98	750	1090,2
43	155	225,3	71	345	501,5	99	775	1126,5
44	160	232,6	72	355	516	100	800	1162,9
45	165	239,8	73	365	530,6			
46	170	247,1	74	375	545,1			

CODICE DI VELOCITA' - SPEED SYMBOL	
CODICE - SYMBOL	VELOCITA' - SPEED (KM/H)
B	50
C	60
D	65
E	70
F	80
G	90
J	100
K	110
L	120
M	130
N	140
P	150
Q	160
R	170
S	180
T	190
H	210
V	240
W	270

10"

CODICE CODE	MISURA SIZE	BATTISTRADA TREAD	PATTERN	INDICE DI CARICO LOAD INDEX	INDICE DI VELOCITÀ SPEED INDEX	COPERTURE TYRES	BARCODE
99 110 0001	3.00-10	Mich 83	K333	42	J	TT	
99 110 0005	3.00-10	-	K333	42	J	TT	
99 110 0102	3.00-10	Mich M+S	K701	47	L	TL	
99 120 0102	3.50-10	Mich M+S	K701	56	L	TL	
99 120 0001	3.50-10	Mich 83	K333	51	J	TT	
99 120 0003	3.50-10	-	K333	51	J	TT	
99 160 5002	90/90-10	Bopp	K413	50	J	TL	
99 160 7002	90/90-10	Dext	K415	50	J	TL	
99 170 5002	100/80-10	Bopp	K413	52	J	TL	
99 170 5003	100/80-10	Bopp	K413	53	M	TL	
99 170 9003	100/80-10	Unik	K423	53	M	TL	
99 180 7002	100/90-10	Dext	K415	56	J	TL	
99 188 9003	120/70-10	Unik	K423	54	M	TL	
99 190 1003	120/90-10	Road	K346	57	J	TL	
99 190 5003	120/90-10	Bopp	K413	57	M	TL	
99 190 5004	120/90-10	Bopp	K413	57	J	TL	
99 190 6003	120/90-10	Chocolate	K451	57	J	TL	
99 190 8002	120/90-10	Reggae	K761	56	J	TL	
99 207 5002	130/70-10	Bopp	K413	52	J	TL	
99 200 1002	130/90-10	Road	K346	61	J	TL	
99 200 5002	130/90-10	Bopp	K413	61	J	TL	
99 200 5003	130/90-10	Bopp	K413	61	M	TL	
99 200 6002	130/90-10	Chocolate	K451	61	J	TL	
99 200 7002	130/90-10	Dext	K415	61	J	TL	
99 200 8002	130/90-10	Reggae	K761	61	J	TL	
99 500 8002	150/80-10	Reggae	K761	65	L	TL	

TL = Tubeless - TT = Set copertura + camera (Kit tyre and inner tube)



11"							
CODICE CODE	MISURA SIZE	BATTISTRADA TREAD	PATTERN	INDICE DI CARICO LOAD INDEX	INDICE DI VELOCITÀ SPEED INDEX	COPERTURE TYRES	BARCODE
99 554 9002	110/70-11	Unik	K423	45	L	TL	
99 554 9003	110/70-11	-	K415 M+S	45	M	TL	
99 554 9004	110/70-11	Mich M+S	K701	45	M	TL	
99 564 5003	120/70-11	Unik	K423	56	L	TL	
99 564 5004	120/70-11	-	K415 M+S	56	L	TL	
99 564 5005	120/70-11	Mich M+S	K701	56	L	TL	

TL = Tubeless

12"							
CODICE CODE	MISURA SIZE	BATTISTRADA TREAD	PATTERN	INDICE DI CARICO LOAD INDEX	INDICE DI VELOCITÀ SPEED INDEX	COPERTURE TYRES	BARCODE
99 143 1002	100/60-12	Mach 2	K433F	39	J	TL	
99 183 5003	110/70-12	Bopp	K413	56	M	TL	
99 186 5002	110/90-12	Bopp	K413	64	J	TL	
99 186 5003	110/90-12	Bopp	K413	64	M	TL	
99 196 1104	120/70-12	Drago F	K763F	51	P	TL	
99 196 1105	120/70-12	Mich M+S	K701	58	P	TL	
99 196 5002	120/70-12	Bopp	K413	51	J	TL	
99 196 5003	120/70-12	Bopp	K413	51	M	TL	
99 196 7002	120/70-12	Dext	K415	51	J	TL	
99 196 8002	120/70-12	Reggae	K761	51	J	TL	
99 198 8002	120/80-12	Reggae	K761	65	J	TL	
99 206 1104	130/70-12	Drago	K763	62	P	TL	
99 206 1105	130/70-12	Mich M+S	K701	62	P	TL	
99 206 5002	130/70-12	Bopp	K413	56	J	TL	
99 206 5003	130/70-12	Bopp	K413	62	M	TL	
99 206 7002	130/70-12	Dext	K415	56	J	TL	
99 206 8002	130/70-12	Reggae	K761	56	J	TL	
99 202 8002	130/80-12	Reggae	K761	69	J	TL	
99 211 5002	140/70-12	Bopp	K413	60	J	TL	
99 211 5003	140/70-12	Bopp	K413	60	M	TL	

TL = Tubeless

13"

CODICE CODE	MISURA SIZE	BATTISTRADA TREAD	PATTERN	INDICE DI CARICO LOAD INDEX	INDICE DI VELOCITÀ SPEED INDEX	COPERTURE TYRES	BARCODE
99 187 1104	110/90-13	Drago F	K763F	56	P	TL	
99 197 5003	120/70-13	Bopp	K413	53	M	TL	
99 197 5004	130/70-13	-	K703 F	53	P	TL	
99 205 5002	130/60-13	Bopp	K413	53	J	TL	
99 205 5003	130/60-13	Bopp	K413	53	M	TL	
99 205 8002	130/60-13	Reggae	K761	53	J	TL	
99 208 1103	130/70-13	Drago	K763	57	M	TL	
99 208 1104	130/70-13	Drago	K763	63	P	TL	
99 208 1105	130/70-13	-	K703	57	P	TL	
99 212 5002	140/60-13	Bopp	K413	57	J	TL	
99 212 5003	140/60-13	Bopp	K413	57	M	TL	
99 212 8002	140/60-13	Reggae	K761	57	J	TL	
99 215 1305	150/70-13	Mach P	K434	64	S	TL	

TL = Tubeless



14"

CODICE CODE	MISURA SIZE	BATTISTRADA TREAD	PATTERN	INDICE DI CARICO LOAD INDEX	INDICE DI VELOCITÀ SPEED INDEX	COPERTURE TYRES	BARCODE
99 346 1300	100/90-14	Mach P	K434	51	P	TL	
99 185 0002	110/80-14	Classic	K425	59	J	TL	
99 464 1205	120/70-14	Drake F	K764F	55	S	TL	
99 464 1305	120/70-14	Mach 2	K433F	55	S	TL	
99 465 1100	120/80-14	Drago	K763	58	P	TL	
99 483 1205	140/60-14	Drake	K764	64	S	TL	
99 484 1205	140/70-14	Drake	K764	68	S	TL	
99 484 1305	120/80-14	Mach 2	K433F	58	S	TL	
99 504 1305	150/70-14	Mach P	K434	66	S	TL	

TL = Tubeless



15"

CODICE CODE	MISURA SIZE	BATTISTRADA TREAD	PATTERN	INDICE DI CARICO LOAD INDEX	INDICE DI VELOCITÀ SPEED INDEX	COPERTURE TYRES	BARCODE
99 198 1002	120/70-15	Mach 2	K433F	56	S	TL	
99 199 1002	130/80-15	Road	K346	63	P	TL	

16"

CODICE CODE	MISURA SIZE	BATTISTRADA TREAD	PATTERN	INDICE DI CARICO LOAD INDEX	INDICE DI VELOCITÀ SPEED INDEX	COPERTURE TYRES	BARCODE
99 145 0002	70/90-16	Classic	K425	42	J	TL	
99 310 0001	2½ 16	Mich	K77	31	B	TT	
99 310 1001	2.50-16	Slick	K327	36	J	TT	
99 310 1002	2.50-16	Slick	K327	42	J	TT	
99 320 1001	2¾16	Slick	K327	36	B	TT	
99 330 1001	2¾16	Slick	K327	40	J	TT	
99 330 1002	2¾16	Slick	K327	46	J	TL	
99 150 0002	80/80-16	Classic	K425	46	J	TL	
99 150 0004	80/80-16	Classic	K425	46	P	TL	
99 336 1300	90/90-16	Mach P	K434	48	P	TL	
99 155 0002	90/80-16	Classic	K425	52	J	TL	
99 157 0004	100/80-16	Classic	K425	56	P	TL	
99 157 1104	100/80-16	Drago F	K763F	56	P	TL	
99 345 1104	100/80-16	Drago	K763	50	P	TL	
99 345 1105	100/80-16	Mich M+S	K701	50	P	TL	
99 354 2004	110/70-16	Mac F	K671F	52	P	TL	
99 365 1004	120/80-16	-	K428	60	P	TL	
99 365 1104	120/80-16	Drago	K763	60	P	TL	
99 365 1105	120/80-16	Mich M+S	K701	60	P	TL	
99 365 2004	120/80-16	Comand P	K430	60	P	TL	
99 158 2005	130/70-16	Mac P	K671	61	S	TL	
99 159 1104	130/80-16	Drago	K763	64	P	TL	
99 384 2004	140/70-16	Mac P	K671	65	P	TL	

TT = Set copertura + camera (Kit tyre and inner tube)



17"							
CODICE CODE	MISURA SIZE	BATTISTRADA TREAD	PATTERN	INDICE DI CARICO LOAD INDEX	INDICE DI VELOCITÀ SPEED INDEX	COPERTURE TYRES	BARCODE
99 340 0001	2.00	Mich	K77		Non omologata Not homologated	TT	
99 340 0101	2.50	Off Road	K772A		Non omologata Not homologated	TL	

TT = Set copertura + camera (Kit tyre and inner tube)



TRASPORTO							
CODICE CODE	MISURA SIZE	BATTISTRADA TREAD	PATTERN	INDICE DI CARICO LOAD INDEX	INDICE DI VELOCITÀ SPEED INDEX	COPERTURE TYRES	BARCODE
99 130 0001	4.50-10	Trasporto	K355	72	M	TT	
99 130 0002	4.50-10	Trasporto	K355	76	M	TT	

TT = Set copertura + camera (Kit tyre and inner tube)



TR13	TR4	TR6	TR87
Valvola standard rivestita in gomma <i>Rubber covered straight valve</i> L: 35 mm Ø foro valvola: 11,5 mm Ø Valve hole: 11,5 mm	Valvola standard con base in gomma <i>Straight valve with rubber base</i> L: 33 mm Ø foro valvola: 7,5 mm Ø Valve hole: 7,5 mm	Valvola standard con base in gomma <i>Straight valve with rubber base</i> L: 33 mm Ø foro valvola: 8,3 mm Ø Valve hole: 8,3 mm	Valvola a gomito con base in gomma <i>90° valve with rubber base</i> A: 17 mm - B: 33 mm 90° Ø foro valvola: 10,2 mm Ø Valve hole: 10,2 mm

CODICE CODE	MISURA SIZE	MARCA TRADE MARK	VALVOLA VALVE	CONFEZIONE PACKAGING	BARCODE
99 910 0000	3.50-8	KENDA	TR 13 (1)	Scatola	
99 910 0100	3.50-8	KENDA	TR 87 (1)	Scatola	
99 920 0001	3.00/3.50-10	KENDA	TR 87 (1)	Scatola	
99 925 0001	100/110/90-10	KENDA	TR 87 (1)	Scatola	
99 930 0001	120/130/90-10	KENDA	TR 87 (1)	Scatola	
99 932 0001	120/130/70-12	KENDA	TR 87 (1)	Scatola	
99 933 0001	130/60-13	KENDA	TR 87 (1)	Scatola	
99 940 0001	4.50-10	KENDA	TR 13 (1)	Scatola	
99 942 0001	4.50-12	KENDA	TR 13 (1)	Scatola	
99 950 0001	2.75/3.00-14	KENDA	TR 6 (1+4)	Scatola	
99 960 0001	2.25/2.50-16	KENDA	TR 6 (1+4)	Scatola	
99 970 0001	2.75-16	KENDA	TR 6 (1+4)	Scatola	
99 990 0001	2.00/2.25-17	KENDA	TR 6 c	Scatola	
99 990 0101	2.25/2.50-17	KENDA	TR 4 (1+4)	Scatola	
99 991 0201	2.75/3.00-18	KENDA	TR 4 (1+4)	Scatola	
99 990 0201	2.50/2.75-17	KENDA	TR 4 (1+4)	Scatola	

(1) Valvola vulcanizzata - (4) Valvola munita di rondella bloccaggio

VALVOLE TUBELESS - TUBELESS VALVE

99 999 9020 NEW	99 999 9000 		99 999 9010 	
TR412 Valvola standard rivestita in gomma <i>Rubber covered straight valve</i> L: 25 mm	TR413 Valvola standard rivestita in gomma <i>Rubber covered straight valve</i> L: 35 mm		PVRT70 Valvola a gomito con base in gomma <i>90° valve with rubber base</i> A: 17 mm B: 33 mm 90° Ø foro valvola: 10,2 mm Ø Valve hole: 10,2 mm	

COPERTURE 10" - 14" - CARRIOLA

TIRES 10" - 14" - WHEEL BARROW



10"									
CODICE CODE	MISURA SIZE	BATTISTRADA	PATTERN	N° TELE	INDICE DI CARICO LOAD INDEX	INDICE DI VELOCITÀ SPEED INDEX	COPERTURE TYRES	VALVOLE VALVES	BARCODE
99 110 3001	3.00-10	Rock	HF204A	4	Non omologata <i>Not homologated</i>		TT	TR87	
99 120 3001	3.50-10	Rock	HF204	4	Non omologata <i>Not homologated</i>		TT	TR87	
14"									
99 210 2001	80/80-14	Slick	HF346	-	43	J	TT	-	
16"									
99 310 1003	2.50-16	Rock	HF311	4	36	L	-	-	

TT = Set copertura + camera (Kit tyre and inner tube) - TL = Tubeless



CARRIOLA									
CODICE CODE	MISURA SIZE	BATTISTRADA	PATTERN	N° TELE	INDICE DI CARICO LOAD INDEX	INDICE DI VELOCITÀ SPEED INDEX	COPERTURE TYRES	VALVOLE VALVES	BARCODE
99 100 2101	3.50-8	Carriola	HF207	-	-	-	TT	TR13	
TRASPORTO									
99 130 0020	4.50-10	Trasporto	HF267	6	76	M	-	-	
99 129 0020	4.00-12	trasporto	HF267	-	Non omologata <i>Not homologated</i>		-	-	

TT = Set copertura + camera (Kit tyre and inner tube)



RMS
YOUR BEST PARTNER

▶ LINEA WORKSHOP

WORKSHOP LINE



PETRONAS

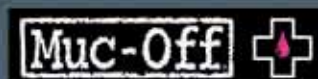

CLEAN

26 720 8051 

DETERGENTE CON NEBULIZZATORE 1LT

26 720 8039 

DETERGENTE 5 LT

26 720 8042 

DETERGENTE 25 LT

Sgrassatore gel pronto all'uso, sicuro su tutte superfici, compresa la fibra in carbonio e il metallo anodizzato. Delicato sulla vernice.

Studiato per non danneggiare guarnizioni, cavi, pastiglie dei freni o rotori. Formula alcalina 100% biodegradabile esente da CFC, solventi o acidi.



26 720 8013 

GEL CONCENTRATO 500ML

26 720 8010 

GEL CONCENTRATO 1LT

26 720 8011 

GEL CONCENTRATO 5LT

Ricarica gel concentrato per detergente cod. 267208051. Diluisci 250 ml di prodotto in 750 ml di acqua.



26 720 8035 

SGRASSATORE SPRAY 500 ML

26 720 8046 

SGRASSATORE SPRAY 750 ML

Sgrassatore 100% biodegradabile rapido e sicuro. Rimuove olio, grasso e sporczia da metallo, plastica, gomma e guarnizioni. Permette la rimozione anche dello sporco più duro, come il grasso resistente all'acqua e i residui di cera. La formula solubile in acqua permette il rapido risciacquo e lascia le componenti della moto completamente pulite.



26 720 8043 

TAPPO EROGATORE

Tappo per detergente 25 lt Cod. 26 720 8042



26 720 8037 

PULITORE CATENA 400 ML

Pulitore per catena 100% Biodegradabile. Non intacca componenti in fibra di carbonio, metallo e gomma di moto.

Compatibile anche con catene con O, X e Z ring.

Formulato per rimuovere in modo sicuro e rapido sporczia, olio lubrificante e grasso, lasciando la catena interamente pulita.

Formula solubile in acqua esente da CFC.



26 720 8027 

PULITORE FRENI 400 ML

26 720 8021 

PULITORE FRENI 750 ML

Il prodotto migliora le prestazioni di frenata rimuovendo polvere, olio, grasso e sporczia da tutte le parti frenanti.

La sua formula è stata studiata per reidratare le pastiglie dei freni a disco, per ridurre drasticamente lo stridio e prolungare la vita del disco. Sicuro sulla fibra di carbonio e su tutte le parti dei freni, dischi, rotori e pastiglie. Esente da CFC



26 720 8007 

PANNO MICROFIBRA

Il panno in microfibra contiene una straordinaria tecnologia "Split-Fibre" che aumenta enormemente la superficie di assorbimento per eliminare facilmente macchie e sporco su bici e moto. Il panno intrappola lo sporco e grazie alle fibre molto piccole garantisce una pulizia più profonda. Prodotto lavabile in lavatrice; può essere riutilizzato.



26 720 8049 

PANNO MICROFIBRA CASCO

Panno in microfibra per la pulizia del casco e della visiera; ideale per la pulizia delle parti delicate.

Dato le dimensioni contenute è un prodotto comodo da portare anche in viaggio.

Prodotto lavabile in lavatrice; può essere riutilizzato.



26 720 8009 

SPUGNA SALVASPAZIO

Spugna resistente dalla forma ergonomica; comoda confezione sottovuoto per occupare poco spazio.



CLEAN

26 720 8015 

PENNELLO PULIZIA CATENA

Pennello per la pulizia della catena.



26 720 8016 

SPAZZOLA RUOTE

Spazzola per la pulizia delle ruote.



26 720 8020 

SPAZZOLA DUE BRACCI

Spazzola a due bracci per moto. Le due spazzole gemelle che la compongono possono essere riposizionate per raggiungere anche gli spazi più ristretti. La spazzola dispone di una struttura di alta qualità con setole di nylon resistenti.



26 720 8019 

SPAZZOLA DETTAGLIO

Spazzola multiuso per moto, ideale per rimuovere lo sporco da punti difficili da raggiungere e aree particolarmente strette. La spazzola dispone di una struttura di alta qualità con setole di nylon resistenti e da zone di contatto gommate per la massima protezione sulle finiture più delicate.



26 720 8018 

SPAZZOLA MULTIUSO

Spazzola ruote per moto; adatta per passare tra i raggi e nelle parti più anguste delle ruote. La spazzola dispone di una struttura di alta qualità con setole di nylon resistenti.



26 720 8002 

SPAZZOLA "CLAW"

Spazzola multiuso per moto; ideale per la pulizia delle finiture delicate. La spazzola dispone di una struttura di alta qualità con setole di nylon resistenti.



26 720 8017 

SPAZZOLA MORBIDA

Spazzola morbida per moto; perfetta per la pulizia della carrozzeria e delle parti verniciate. La spazzola dispone di una struttura di alta qualità con setole di nylon resistenti.



26 720 8012 

SPAZZOLA PULIZIA CATENA

Spazzola ideale per la pulizia della catena, una estremità a forma di C permette la pulizia veloce e pratica della catena. La spazzola dispone di una struttura di alta qualità con setole di nylon resistenti.



26 720 8006 

KIT 3 SPAZZOLE

Kit composto da:
N°1 cod. 26 720 8002 spazzola "claw"
N°1 cod. 26 720 8017 spazzola morbida
N°1 cod. 26 720 8019 spazzola dettaglio



26 720 8003 

KIT 5 SPAZZOLE

Kit composto da:
N°1 cod. 26 720 8002 spazzola "claw"
N°1 cod. 26 720 8017 spazzola morbida
N°1 cod. 26 720 8019 spazzola dettaglio
N°1 cod. 26 720 8018 spazzola multiuso
N°1 cod. 26 720 8015 spazzola due bracci



PROTECT & SHINE

26 720 8044 

LUBRIFICANTE MULTIUSO 400ML

Spray lubrificante multiuso. Sicuro su tutte le superfici, compresa la fibra in carbonio, plastica e colori opachi. La sua formula penetra efficacemente e rapidamente, lubrificando le parti mobili e lasciando un sottile strato protettivo di lunga tenuta. La presenza di P.T.F.E. riduce l'attrito, disperde l'acqua e impedisce l'adesione di sporcizia. Formula esente da CFC, contiene marcatore fluorescente.



26 720 8024 

GRASSO PROTETTIVO 500 ML

26 720 8022 

GRASSO PROTETTIVO 750 ML

Spray protettivo per moto. Il prodotto disperde l'acqua e lascia uno strato protettivo brillante, non adesivo e invisibile sulle parti metalliche e plastiche, sulla gomma e sulla vernice. La funzione è garantita dalla presenza del P.T.F.E utilizzato nei rivestimenti antiadesivi. Questa componente forma una pellicola protettiva su tutte le parti della moto per proteggerle da acqua e sporco, diminuendo la frequenza di lavaggio.



26 720 8030 

SILICONE SPRAY 500 ML

Spray lubrificante al silicone. Riduce fortemente l'attrito nelle sospensioni ed evita l'adesione dello sporco. Spruzzato sugli steli delle forcelle migliora la scorrevolezza ed aumenta la durata dei parapolvere / paraoli. Formula esente da CFC, sicura sulla fibra di carbonio.



26 720 8031 

POLISH SPRAY 400 ML

Polish Spray è un prodotto 2 in 1 facile e veloce da utilizzare: un polish e una cera. Sicuro anche sui componenti in fibra di carbonio. È stato formulato per creare sulla carrozzeria una barriera che resiste all'acqua.



26 720 8045 

CERA LUCIDANTE 500 ML

Cera protettiva e lucidante di alta qualità, garantisce una profonda lucentezza alla carrozzeria. Il prodotto contiene due cere naturali:
 - Carnauba pura: la cera più dura tra quelle in natura, per conferire durabilità e resistenza;
 - Cera d'Api per assicurare una profonda brillantezza. Crea una barriera impermeabile e rimuove le imperfezioni e graffi. Grazie alla tecnologia a «Fluoro Polimeri», le zone trattate sono protette dagli agenti atmosferici e dagli inquinanti.



26 720 8047 

FINITURE OPACHE 750 ML

Spray ideato per rimuovere impronte e macchie sulle vernici opache satinare. Riduce lo sporco creando un rivestimento protettivo su qualsiasi superficie opaca.



26 720 8032 

METAL POLISH 100 ML

Basta una piccola quantità di Metal Polish per far risplendere i metalli come se fossero nuovi. Cromo, ottone, alluminio e superfici in acciaio ritornano profondamente lucenti, grazie agli abrasivi contenuti in questo prodotto.



LUBE

26 720 8048 

LUBRIFICANTE CATENA PTFE 50 ML

26 720 8036 

LUBRIFICANTE CATENA PTFE 400 ML

26 720 8023 

LUBRIFICANTE CATENA PTFE 750 ML

Ideale per polvere, sabbia e climi secchi.

Lubrificante protettivo per catena, compatibile con catene con O, X e Z ring. Il prodotto è stato realizzato per penetrare in profondità nei collegamenti delle catene, nei perni e nei rulli.

La formula avanzata «Formula Dry» crea uno strato di cera resistente e protettivo sulla catena, che inibisce lo sviluppo di ruggine e corrosione. Il P.T.F.E. aggiunto riduce l'attrito superficiale e garantisce l'efficienza della catena, proteggendola da acqua e sporco.

Formula esente da CFC, contiene marcatore fluorescente.



26 720 8034 

LUBRIFICANTE CATENA ENDURANCE 400 ML

Ottimo per tutte le condizioni, lunga durata.

Lubrificante protettivo per moto, compatibile anche con catene con O, X e Z ring. La formula a ceramica penetra in profondità nei perni, rulli e collegamenti.

Formula esente da CFC, contiene marcatore fluorescente.



26 720 8026 

LUBRIFICANTE CATENA EXTREME 400 ML

Ideale per pioggia, fango e climi umidi.

Lubrificante protettivo per moto, compatibile con catene con O, X e Z ring. La formula a polimeri penetra in profondità nei collegamenti delle catene per ridurre l'usura e l'attrito al minimo, anche in caso di pioggia.

Formula esente da CFC, contiene marcatore fluorescente.



26 720 8050 

ANTI APPANNANTE 32ML

Spray anti appannante per tutti i tipi di maschere, occhiali, lenti, visiere. Il prodotto utilizza la tecnologia di assorbimento di umidità; la formula anti-nebbia crea un sottilissimo rivestimento anti appannante. Lo spray anti appannante può essere utilizzato anche sulla parte esterna delle lenti per aiutare l'acqua a scivolare via e quindi migliorare la visibilità in caso di maltempo.



26 720 8004 

PULITORE VISIERA 32ML

26 720 8005 

PULITORE VISIERA 250ML

Pulitore rapido e sicuro per visiera. Rimuove polvere, sporcizia, neve, sudore e residui oleosi da caschi, occhiali e maschere.

Formulato con acqua deionizzata, è sicuro su tutti i tipo di materiali e lenti, incluse quelle in policarbonato. Formula Antibatterica a PH neutro. Ideale utilizzo con il panno in microfibra nero 26 720 8049.

Prodotto 100% biodegradabile privo di solventi e sostanze chimiche.



32 ml



250 ml

26 720 8025 

IMPERMEABILIZZANTE 400 ML

Spray protettivo e impermeabilizzante, crea una barriera invisibile che protegge i tessuti. Dopo numerosi lavaggi i capi impermeabili perdono la loro efficacia dettata dal trattamento idrorepellente applicato in fabbrica. Questo prodotto ripristina le condizioni ottimali del capo e la resistenza all'acqua. Prodotto formulato e testato per ogni tessuto, anche quelli traspiranti.



26 720 8000 

SCHIUMA CASCO 400 ML

Schiuma detergente di facile utilizzo.

Ideale per le fodere del casco, la pulizia di guanti, scarpe e protezioni moto cross.

Il prodotto ha una immediata azione schiumogena, che rimuove delicatamente polvere e sporcizia dai tessuti.



KIT VARI

26 720 8001 

KIT PULIZIA MASCHERA

Kit composto da:

- N°1 cod. 26 720 8004 pulitore visiera 32 ml
 - N°1 cod. 26 720 8049 panno microfibra casco
- Compreso nella confezione un pratico sacchetto in microfibra.



26 720 8029 

KIT "CARE PACK"

Kit composto da:

- N°1 cod. 26 720 8024 grasso protettivo 500 ml
- N°1 cod. 26 720 8051 detergente 1 lt tap+neb



26 720 8033 

KIT "ESSENTIALS CARE"

Kit composto da:

- N°1 cod. 26 720 8024 grasso protettivo 500 ml
- N°1 cod. 26 720 8051 detergente 1 lt tap+neb
- N°1 cod. 26 720 8009 spugna salvaspazio
- N°1 cod. 26 720 8018 spazzola multiuso



26 720 8041 

KIT "PULIZIA, PROTEZIONE E LUBRIFICANTE"

Kit composto da:

- N°1 cod. 26 720 8024 grasso protettivo 500 ml
- N°1 cod. 26 720 8051 detergente 1 lt tap+neb
- N°1 cod. 26 720 8036 lubrificante catena PTFE 400 ml

26 720 8040 

KIT "MULTI PACK"

Kit composto da:

- N°1 cod. 26 720 8035 sgrassatore spray 500 ml
- N°1 cod. 26 720 8034 lubrificante catena endurance 400 ml
- N°1 cod. 26 720 8024 grasso protettivo 500 ml
- N°1 cod. 26 720 8002 spazzola claw

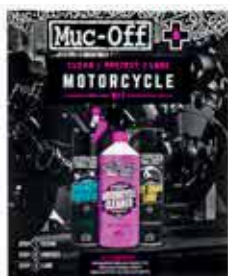

26 720 8008 

KIT ULTIMATE

Kit composto da:

- N°1 cod. 26 720 8024 grasso protettivo 500 ml
- N°1 cod. 26 720 8031 polish spray 400 ml
- N°1 cod. 26 720 8051 detergente 1 lt tap+neb
- N°1 cod. 26 720 8007 panno microfibra
- N°1 cod. 26 720 8017 spazzola morbida
- N°1 cod. 26 720 8018 spazzola multiuso
- N°1 cod. 26 720 8002 spazzola «claw»
- N°1 cod. 26 720 8019 spazzola dettaglio
- N°1 cod. 26 720 8009 spugna salvaspazio



KIT VARI

26 720 8028 

KIT VALIGIA "VALET"

Kit composto da:

- N°1 cod. 26 720 8024 grasso protettivo 500 ml
- N°1 cod. 26 720 8030 silicone spray 500 ml
- N°1 cod. 26 720 8031 polish spray 400 ml
- N°1 cod. 26 720 8034 lubrificante catena endurance 400 ml
- N°1 cod. 26 720 8027 pulitore freno 400 ml
- N°1 cod. 26 720 8035 sgrassatore spray 500 ml
- N°1 cod. 26 720 8051 detergente 1 lt tap+neb
- N°1 cod. 26 720 8007 panno microfibra
- N°1 cod. 26 720 8017 spazzola morbida
- N°1 cod. 26 720 8009 spugna salvaspazio
- N°1 cod. 26 720 8018 spazzola multiuso
- N°1 cod. 26 720 8002 spazzola "claw"



26 720 8052 

GREMBIULE DA OFFICINA

Taglia Unica



26 725 1001 

1 L

GP4T Performance Racing 5W30
Olio Motore 4T - 100% Sintetico



26 725 1011 

1 L

GP4T Ultra Racing 10W40
Olio Motore 4T - 100% Sintetico



26 725 1021 

1 L

GP4T Ultra Enduro 15W50
Olio Motore 4T - 100% Sintetico



26 725 1031 

1 L

26 725 1032 

4 L

26 725 1034 

60 L

Max Performance 10W40
Olio Motore 4T - Synthetic technology



26 725 1041 

1 L

26 725 1044 

60 L

Max Performance Offroad 10W40
Olio Motore 4T - Synthetic technology



26 725 1051 

1 L

Max Performance 10W30
Olio Motore 4T - Synthetic technology



26 725 1061 

1 L

Performance 20W50
Olio Motore 4T - Minerale



26 725 1071 

1 L

City Performance Scooter 10W40
Olio Motore 4T - Synthetic technology



26 725 1081 

1 L

City Performance Scooter Gear Oil
Olio Trasmissione - Synthetic technology



26 725 1091 

1 L

Max Performance 2-Stroke
Olio Miscela 2T - Synthetic technology







NUOVA LINEA PRODOTTI MOTO
NEW MOTORCYCLE PRODUCT LINE

26 720 0730



LUBRIFICANTE CATENA P.T.F.E.
CHAIN P.T.F.E. LUBRIFICANT SPRAY
 Conf. 200 ML



26 720 0740



LUBRIFICANTE CATENA
CHAIN LUBRIFICANT
 Conf. 200 ML



26 720 0750



PULITORE CATENA
CHAIN CLEANER
 Conf. 500 ML



26 720 0760



GOMMA SPRAY - INFLATE AND REPAIR
 Conf. 200 ML



26 720 0770



CROMATURE BRILLANTI - CHROME CARE
 Conf. 150 Gr



26 720 0780



DETERGENTE MOTO - BIKE DEGREASER
 Conf. 400 ML



26 720 0790



RAIN OFF VISIERE
VISORS RAIN OFF
 Conf. 75 ML



26 720 0800



IGIENIZZANTE CASCO
HELMET SANITIZING
 Conf. 75 ML



26 725 0150 

OLIO MOTORE SUPERPLUS 2T
Litri - Liter 1



Specifiche API TC++, JASO FB (Low smoke)
ISO GLOBAL L-EGD

26 725 0160 

OLIO MOTORE SCOOTER MIX 2T SYNTHETIC
Litri - Liter 1



Specifiche API TC+, JASO FC (Low smoke)
ISO GLOBAL L-EGD

26 725 0170 

**OLIO MOTORE TOP RACING 2T FULLY
SYNTHETIC**
Litri - Liter 1



Specifiche API TC+, JASO FC (Low smoke)
ISO GLOBAL L-EGD

26 725 0180 

OLIO MOTORE SUPER SYNTHETIC 4T
Litri - Liter 1



Specifiche API SH, JASO MA-MA2
15W50

26 725 0190 

**OLIO MOTORE SCOOTER ONE 4T
SYNTHETIC**
Litri - Liter 1



Specifiche API SL, JASO MA-MA2
10W40



GUANTI IN NITRILE (Conf. 100Pz.)

- Monouso senza polvere ambidestri
- Protezione delle mani per usi di breve durata
- Eccellente sensibilità
- Si indossano e si tolgono facilmente
- Esenti da rischi di allergia al lattice

Rispettano le norme: ASTM-D3578-77(91), EN 455 1 e 2

NITRILE GLOVES (Packaging 100 pcs)

- Single-use with-out powder, ambidextrous
- Protective gloves for short-term use
- Excellent sensitivity
- You put on and take off easily
- No risk of latex allergy

According to: ASTM-D3578-77(91), EN 455 1 and 2



26 720 0230



Taglia - Size "M" - 100 Guanti

26 720 0240



Taglia - Size "L" - 100 Guanti

26 720 0250



Taglia - Size "XL" - 100 Guanti

GUANTI IN NITRILE SPESSO (Conf. 50Pz.)

- Per uso professionale Classe 8.0 MIL
- Monouso ed ambidestri
- Esenti da rischi di allergia al lattice
- Rispettano le norme: EN388-EN455 1 e 2-ASTM D3578

NITRILE THICK GLOVES (Packaging 50 pcs)

- For professional use Class 8.0 MIL
- Single-use and ambidextrous.
- No risk of latex allergy

According to: EN388-EN455 1 and 2-ASTM D3578



26 720 0260



Taglia - Size "M" - 50 Guanti

26 720 0270



Taglia - Size "L" - 50 Guanti

26 720 0280



Taglia - Size "XL" - 50 Guanti

26 720 0160



VERNICE SPRAY NERO OPACO PER MARMITTE

(Conf. 400 ml)

Smalto Spray per Alta Temperatura Nero opaco
Può essere utilizzato su superfici di metallo sottoposte ad alte temperature quali: parti del motore, impianti di scarico, stufe ecc.

Resiste fino a 600° C.

EXHAUSTS MATT BLACK SPRAY PAINT

High Temperature Spray Spray Matt Black. Can be used on metal surfaces subjected to high temperatures such as parts of engine, exhaust systems, heaters and so on. Resists up to 600 °



26 720 0162



VERNICE SPRAY TRASPARENTE PER MARMITTE

(Conf. 400 ml)

Smalto Spray per Alta Temperatura trasparente
Può essere utilizzato su superfici di metallo sottoposte ad alte temperature quali: parti del motore, impianti di scarico, stufe ecc.

Resiste fino a 600° C.

EXHAUSTS TRANSPARENT SPRAY PAINT

High Temperature Spray transparent. Can be used on metal surfaces subjected to high temperatures such as parts of engine, exhaust systems, heaters and so on. Resists up to 600 °



26 720 0620

SVITOL LUBRIFICANTE (400 ml)
L'esclusiva multifunzionalità lo rende l'alleato sicuro e indispensabile nelle mille occasioni d'uso quotidiano: dalla casa al giardino, dallo sport alla nautica, dal lavoro al fai da te.
Lubrifica
Sblocca
Protegge dalla corrosione
Elimina l'umidità
SVITOL LUBRICANT SPRAY (400 ml)
Exclusively and multifunctional. your safe, essentially for hundreds of everyday uses: home, garden, sport, boats, work and diy.
Lubricates
Unlocks
Corrosion protection
Removes humidity



26 720 0630

SVITOL LUBRIFICANTE (200 ml)
L'esclusiva multifunzionalità lo rende l'alleato sicuro e indispensabile nelle mille occasioni d'uso quotidiano: dalla casa al giardino, dallo sport alla nautica, dal lavoro al fai da te.
Lubrifica
Sblocca
Protegge dalla corrosione
Elimina l'umidità
SVITOL LUBRICANT SPRAY (200 ml)
Exclusively and multifunctional. your safe, essentially for hundreds of everyday uses: home, garden, sport, boats, work and diy.
Lubricates
Unlocks
Corrosion protection
Removes humidity



26 720 0460

SVITOL PROFESSIONAL SILIKON IMPERMEABILIZZANTE LUBRIFICANTE (400 ml)
Impermeabilizzante e lubrificante.
Resiste all'acqua e allo sfregamento.
Protegge da gelo e corrosione.
Ideale per le guarnizioni.
PROFESSIONAL SVITOL SILIKON WATERPROOFING LUBRICANT (400 ml)
*Lubricant and waterproofing
Resistant to water and rubbing
Protects from frost and corrosion
Ideal for seals*



26 720 0470

SVITOL PROFESSIONAL LUBRIFICANTE MULTIUSO SPECIALE OFFICINE (400 ml)
Lubrificante multiuso, protettivo e detergente, specifico per autofficine e autoriparatori.
Non contiene silicone: ideale per utilizzo in carrozzeria.
PROFESSIONAL SVITOL SPECIAL MULTI-PURPOSE LUBRICANT FOR GARAGES (400 ml)
*Multipurpose lubricant
protecting and cleansing
specific for workshops and garages.
Does not contains silicone
ideal for use in body shop*



26 720 0480

SVITOL PROFESSIONAL GRASSO LUBRIFICANTE AD ALTE PRESTAZIONI PTFE (400 ml)
Grasso lubrificante spray ad alte prestazioni
Grasso spray ad alte prestazioni.
Diminuisce l'attrito e resiste a forti pressioni.
Lunga durata.
Non attira sporco e impurità.
SVITOL PROFESSIONAL PTFE HIGH PERFORMANCE LUBRICATING GREASE (400 ml)
*High performance long lasting lubricant grease.
Does not attract dust and impurities*



26 720 0490

SVITOL PROFESSIONAL LUBRIFICANTE AL LITIO (400 ml)
Lubrificante al litio ad alta viscosità
Lunga resistenza all'acqua e all'usura.
Grasso lubrificante ad alta viscosità.
Sicuro anche su gomma e plastiche.
SVITOL PROFESSIONAL LITHIUM LUBRICANT (400 ml)
*High-viscosity lithium lubricant
Long-lasting resistance to water and use
Safe on rubber and plastic*



26 720 0500

SVITOL PROFESSIONAL PULITORE CONTATTI (400 ml)
Protegge dall'ossidazione e dall'umidità.
Disossida e riattiva i contatti ossidati.
Sicuro su plastiche, metalli e gomma.
SVITOL PROFESSIONAL CONTACTS CLEANER (400 ml)
*Protects from oxidation and moisture
Deoxidizes and reactivates contacts
Does not damage rubber and plastic parts*



26 720 0400

FRENAFILETTI MEDIO (50 ml)

Frenatura di prigionieri, dadi e bulloni non soggetti a smontaggio. Prodotto a bassa viscosità.

Elimina gli allentamenti dovuti a vibrazioni, urti, sbalzi di temperatura. Impedisce la corrosione ed il grippaggio.

THREADLOCKER MEDIUM (50 ml)

Tightening of studs, nuts and bolts not subject to removal. Low viscosity product. Avoid loosening due to vibrations, shocks and temperature changes.

Prevents corrosion and seizing up. Permanent tightening.



26 720 0170

FRENAFILETTI FORTE (10 ml)

Frenatura di prigionieri, dadi e bulloni non soggetti a smontaggio. Prodotto a bassa viscosità.

Elimina gli allentamenti dovuti a vibrazioni, urti, sbalzi di temperatura. Impedisce la corrosione ed il grippaggio. Frenatura permanente.

THREADLOCKER STRONG (10 ml)

Tightening of studs, nuts and bolts not subject to removal. Low viscosity product. Avoid loosening due to vibrations, shocks and temperature changes.

Prevents corrosion and seizing up. Permanent tightening.



26 720 0640

PULITORE FRENI E METALLI (500 ml)

Prodotto spray per la pulizia di freni a tamburo, a disco, pinze e ceppi. Dissolve e rimuove rapidamente grasso, olio, residui, ecc.

MOTORCYCLE BRAKES AND METAL PARTS CLEANER (500 ml)

Spray products for cleaning brake drums, disks, calipers and brake shoes.

Quickly dissolves and removes grease, oil and dirt



26 720 0370

STARTER SPRAY (200 ml)

Applicazione: motore.

Facilita l'avviamento dei motori diesel e benzina durante la stagione invernale, assicurando sempre una rapida accensione anche a temperature molto basse.

Facilitates starting during winter season, always ensuring a fast ignition even at very low temperatures.



26 720 0290

PULITORE INIETTORI BENZINA (250 ml)

Ripristina con effetto immediato l'efficacia del sistema di alimentazione.

Pulisce all'istante e disincrosta gli iniettori. Scioglie depositi e residui nel sistema di alimentazione.

Migliora la combustione

FUEL INJECTORS CLEANER (250 ml)

Restore with immediate effect the efficiency of the power system.

Instantly cleans and descaling the injectors.

Dissolves deposits and wastes in power system improves the combustion



26 720 0420

PULITORE SISTEMA ASPIRAZIONE E CARBURATORE (Conf. 500 ml)

Applicazione: per motori alimentati

a benzina, gpl, metano.

Pulisce ed elimina i depositi nei condotti di aspirazione dell'aria senza la necessità di smontaggio. Scioglie gomme, lacche ed ogni genere di depositi nei corpi farfallati. Indicato per la pulizia dei carburatori.

CLEANER CARBURETOR

It cleans and eliminates debris in the air intake ducts, without having to take them down. It dissolves rubber, build-up and every type of debris contained inside the throttle body. It is suitable for cleaning carburetors.

It restores CO and HC values.

It is suitable for all single-point, multi-point injection engines, throttle bodies and carburetors.



26 720 0130

MOTORSIL D ROSSA pasta per guarnizioni 60 gr
Tenuta di accoppiamenti meccanici, termomeccanici, chimici, elettronici, elettromeccanici, che operino in condizioni particolarmente difficili.

RED MOTORSIL D GASKET SEALANT

Sealant for mechanical, thermo-mechanical, chemical, electronic, electro-mechanical couplings working in particularly difficult conditions.



26 720 0310

MASTICE PER GUARNIZIONE (100 ml)

Posizionamento e fissaggio di ogni tipo di guarnizione tradizionale. Alto potere adesivo, assicura una tenuta perfetta anche su superfici non regolari. Resiste ad oli, benzina, fluidi refrigeranti e alle pressioni.

SEALING GASKET CEMENT (100 ml)

Positioning and securing of any type of standard gasket. High power adhesive, ensuring a perfect seal also on irregular surfaces. Resistant to oils, gas, refrigerant fluids and pressure.



26 720 0710

PASTA MONTAGGIO MARMITTE

EXHAUST-MUFFLER SEALANT

80 ml



26 720 0140

MOTORBLACK NERA pasta per guarnizioni 60 gr

Sigillatura coppa olio motori Fire e giunti dinamici, differenziale, scatola cambio, pompa acqua.

BLACK MOTORBLACK GASKET SEALANT

Sealant for Fire engine oil sump and dynamic joints, differentials, gearboxes, coolant pumps.



26 720 0550

RIPARA METALLO (57 gr)

Pronto all'uso. Forte, facile, rapido. Applicabile anche in presenza di fuoriuscita di acqua. Aderisce anche su superfici bagnate. Non ritira durante l'indurimento. Dopo l'indurimento, può essere trapanato, levigato, lavorato, verniciato. Serve per riparare, ricostruire, otturare, sigillare, stuccare metallo, ferro, alluminio, rame, ottone, bronzo ghisa, piombo e plastiche dure. Ripara tubi, valvole, serbatoi, parti di motore, arnesi di metallo, condotti per l'aria, parti di bici, moto ed auto

METAL REPAIRER (57 gr)

Ready to use. Strong, easy, fast. Applicable even in the presence of leakage of water. Adheres to wet surfaces. Non-shrinking during hardening. After curing, it can be drilled, sanded, machined, painted. It is used to repair, rebuild, fill, seal, caulk metal, iron, aluminum, copper, brass, bronze, cast iron, lead, and hard plastics. Repair pipes, valves, tanks, motor parts, metal tools, air ducts, parts of bicycles, motorcycles and cars.



26 720 0570

CARBOSILICIUM Acqua Grana Fine

(scatola in metallo 70 ml)

Prodotto per la rapida smerigliatura lucidatura delle valvole e dei condotti dei motori a combustione interna. Massimo grado di purezza. Durezza elevatissima. Smerigliatura perfetta.

CARBOSILICIUM WATER (Fine-grain)

Product for the rapid grinding polishing of valves and ducts of internal combustion engines.

Maximum degree of purity. Extreme hardness. Grinding perfect.



26 720 0580

GRASSO AL LITIO NLGI 3 (0,85 kg)

Speciale Multiuso al Litio indicato in particolare per l'ingrassaggio di mozzi ruote, trasmissioni e cuscinetti.

Elevata stabilità termica per l'utilizzo con temperature da -20°C a +120°C. L'eccellente stabilità meccanica permette di ridurre al minimo la fuoriuscita d'olio. Alta resistenza all'ossidazione per una migliore durata del grasso. Alta resistenza all'acqua per una superiore tenuta all'azione dilavante dell'acqua. Il prodotto si presenta di colore verde scuro e di aspetto pomatoso e filante.

LITHIUM GREASE NLGI 3 (0,85 kg)

High thermal stability for use in temperatures from -20 °C to +120 °C. The excellent mechanical stability allows to minimize the leakage of oil. High oxidation resistance for better durability of the grease. High water resistance. The product has a dark green color.



26 720 0560

GRASSO ALTE PRESTAZIONI (100 ml)

A base di litio complesso. Fortemente adesivo, riduce l'attrito e protegge dall'ossidazione, resiste all'umidità, a carichi elevati, a bassissime ed alte velocità, a temperature elevate per lungo tempo (da -40°C a +240°C con punto di goccia a +300°C). Lubrifica parti rotanti dei macchinari e, in particolare, dei cuscinetti a rotolamento, anche in condizioni estreme di esercizio. Per lubrificare anche macchine da giardino, agricole, movimento terra. Resiste a vibrazioni e centrifugazioni e al dilavamento (acqua dolce o salata). Permette intervalli di manutenzione più lunghi.

HIGH-PERFORMANCE GREASE (100 ml)

Lithium-based complex. Strongly adhesive, reduces friction and protects against oxidation, high resistant, high loads, at very low and high speeds, at high temperatures for a long time (from -40 °C to +240 °C with a drop point in +300 °C). Lubricates the rotating parts of the machinery and, in particular, of the bearings, even in extreme operating conditions. To lubricate garden machines, agricultural, earthmoving. Resistant to vibration and centrifugation and wash-off (freshwater or saltwater). Allows for longer maintenance intervals.



26 720 0150

ROLIN FLUID VERDE LIQUIDO PER RADIATORI (1 Lt.)

Liquido concentrato pluristagionale per radiatori, ad azione protettiva, antigelo e antiebollizione.

può essere utilizzato anche per rabbocchi, in aggiunta a qualsiasi liquido preesistente di colore diverso.

CONDENSED RADIATOR FLUID (1 Lt.)

Multi seasonal concentrated liquid radiator, acting protective, anti-freeze and anti-boiling. can also be used for filling, in addition to any liquid existing in a different color.



26 720 0660

(500 ml)

26 720 0670

(1000 ml)

GRASSO CUSCINETTI AL LITIO

Grasso al litio complesso, speciale per alte temperature.

Elevata adesività. Ottima resistenza all'acqua.

Resiste a vibrazioni e centrifugazione.

Riduce l'attrito e protegge dalla corrosione.

Altissima resistenza meccanica ed elevata resistenza al carico.

Permette più lunghi intervalli di manutenzione.

Temperatura di impiego: da -25°C a +180°C, con punte fino a +220°C.

BEARING LITHIUM GREASE

Lithium complex grease special for high temperatures.

Excellent water resistance.

Resistant to vibrations and centrifugation.

Reduces friction and protects against corrosion.



26 720 0120

LIQUIDO FRENI DOT 4 (175 ml)

Compatibile con tutti i tipi di gommini

impiegati in primo impianto

punto di ebollizione 260° (ERBP)

Punto di ebollizione a umido min. 140°C (WERBP)

BRAKE FLUID DOT 4 (175 ml)

Compatible with all types of rubbers used in O.E.

Boiling point of 260 ° (ERBP)

Wet boiling point min. 140 °C (WERBP)



26 720 0650

TURAFALLE METALLICO (25 gr)

Sigilla ogni tipo di incrinatura nei carter di alluminio. Forte e tenace.

Azione super rapida. Consigliato

per sigillare le soffiature di fusione.

Sigilla le saldature

imperfette delle riparazioni del monoblocco.

Monodose facile da usare.

METALLIC SEALING COMPOUND (25 gr)

Seals every kind of cracking in alloy crankcase.

Strong and tenacious.

Super fast action.



26 720 0590

ACQUAZERO (400 ml)

Lava, lucida e protegge la carrozzeria di auto, scooter, camper, senza l'utilizzo di acqua: è sufficiente spruzzarlo sulla superficie da trattare e poi passare un panno di cotone asciutto. E' ideale per la carrozzeria, ma valido anche per le gomme e le parti in plastica. La formulazione a base di speciali cere nutritive, oltre catturare e rimuovere la polvere, escrementi di uccelli, insetti, sporco in genere, lascia la superficie trattata perfettamente lucida e protetta.

ACQUAZERO CLEANER (400 ml)

Washes, polishes and protects the bodywork of cars, scooters, motor homes, without the use of water: just spray it on the surface to be treated and then wipe with a dry cotton. Ideal for the body, but also valid for the tires and plastic parts. The formulation based on special waxes nutrients, as well as capture and remove dust, bird droppings, insects, dirt in general, leaving the treated surface perfectly polished and protected.



26 720 0300

PELLE DI DAINO SINTETICA

Wizzy pelle sintetica prima qualità' in contenitore.

Confezione : 35x40 cm

SYNTHETIC LEATHER

Wizzy synthetic leather top quality 'in box

Packaging: 35x40 cm



26 720 0220

PASTA LAVAMANI (5 lt)

SOOTHING HAND CLEANING PASTE



26 720 0700

SMASH LUCIDA CRUSCOTTI

DASHBOARD CLEANER

600 ml



26 720 0390

IMPERMEABILIZZANTE (200 ml)

Impermeabilizzante per tutti i materiali porosi.

FULCRON WATERPROOFING (200 ml)

Water proofing for all porous materials.



26 720 0360

RINNOVA FANALI (150 gr.)

Pasta per la lucidatura manuale di fari opacizzati e può essere usato anche per la lucidatura di parabrezza di scooter o cupolini di moto.

HEADLIGHT LENS CLEANING PASTE (150 gr.)

Designed to restore the transparency of motorcycle lights and for the brightness windscreens.



26 720 0200

(500 ml)

26 720 0210

(5 Lt.)

**FULCRON CONCENTRATO
SUPERPULITORE SGRASSANTE
NON TOSSICO**

Sgrassante per tutte le superfici di auto, industria, casa, caravaning, Nautica, tempo Libero, ecc.
**FULCRON CONDENSED GREASE
REMOVER**

For all surfaces: cars, industry, home, caravans, boats, leisure, etc.



26 720 9900



Colore: Giallo Traffico
Colour: Traffic Yellow



26 720 9901



Colore: Arancio Puro
Colour: Pure Orange



26 720 9902



Colore: Rosso Fuoco
Colour: Flame Red



26 720 9903



Colore: Rosso Traffico
Colour: Traffic Red



26 720 9904



Colore: Rosa Chiaro
Colour: Light Pink



26 720 9905



Colore: Viola Erica
Colour: Heather Violet



26 720 9906



Colore: Lilla Bluastro
Colour: Blue Lilac



26 720 9907



Colore: Blu Napoli
Colour: Naples Blue



26 720 9908



Colore: Blu Traffico
Colour: Traffic Blue



26 720 9909



Colore: Turchese
Colour: Turquoise Blue



26 720 9910



Colore: Grigio Argento
Colour: Silver Grey



26 720 9912



Colore: Verde Menta
Colour: Mint Green



26 720 9913



Colore: Marrone Cioccolata
Colour: Chocolate Brown



26 720 9914



Colore: Nero Opaco
Colour: Black Matt



26 720 9915



Colore: Bianco Opaco
Colour: Pure White Matt



26 720 9916 

Colore: Trasparente Opaco
Colour: *Transparent Matt*



26 720 9917 

Colore: Trasparente Lucido
Colour: *Transparent Glossy*



26 720 9918 

Colore: Argento
Colour: *Silver*



26 720 9919 

Colore: Oro
Colour: *Gold*



26 720 9920 

Colore: Giallo Fluo
Colour: *Fluo Yellow*



26 720 9921 

Colore: Rosso Fluo
Colour: *Fluo Red*



26 720 9922 

Colore: Fuxia Fluo
Colour: *Fluo Fuxia*



26 720 9923 

Colore: Verde Fluo
Colour: *Fluo Green*



26 720 9924 

Colore: Blu Fluo
Colour: *Fluo Blue*



26 720 9925 

Colore: Arancio Fluo
Colour: *Fluo Orange*



26 720 9926 

Colore: Blue Horizon
Colour: *Blue Horizon*



26 720 9927 

Colore: Beige Sand
Colour: *Beige Sand*



26 720 9928 

Colore: Verde Canna
Colour: *Reed Green*



26 720 9929 

Colore: Kaki Olive
Colour: *Kaki Olive*



26 720 9930 

Colore: Grigio Verde
Colour: *Grey Green*



26 720 9931 

Colore: Grigio Scuro
Colour: Dar Grey



26 720 9932 

Colore: Mostarda
Colour: Mustard



26 720 9933 

Colore: Glitter Argento
Colour: Silver Glitter



26 720 9934 

Colore: Glitter Oro
Colour: Gold Glitter



26 720 9936 

Colore: Grigio Titanio
Colour: Titanium grey



26 720 9937 

Colore: Nero metallizzato
Colour: Black metalized



26 720 9941 

Colore: Verde Kawasaki
Colour: Kawasaki Green



26 720 9944 

Colore: Blu scuro navy
Colour: Dark blue navy



NEW

26 720 9938 

PISTOLA PER BOMBOLETTA SPRAY
SPRAY CAN GUN



26 720 9939 

COPRI VALVOLA CERCHI
RIM VALVE MASKING PROTECTION



26 720 9940 

KIT 15 CARTONCINI MASCHERATURA
15 PCS RIM MASKING CARD



26 720 9942 

EROGATORE BIANCO (RICAMBIO)
WHITE CAN NOZZLE (SPARE)



26 720 9943 

EROGATORE NERO – SPRUZZO FINE
BLACK CAN NOZZLE (ROUND SPRAY)



26 720 9935 

EROGATORE ROSSO PROFESSIONALE
REGOLABILE – SPRUZZO A VENTAGLIO
FINO A 20cm
RED CAN NOZZLE (WIDE SPRAY TO 20 cm)





RMS
YOUR BEST PARTNER



▶ LINEA ACCESSORI
ACCESSORIES

▶ *air***MAN**[®]
BUILT FOR YOUR MOBILITY.

26 700 1000

EASY RIDER

- Kit di riparazione pneumatici
- Compressore d'aria ad alta pressione adatto per gomme scooter, auto, bici, Atv
- Connettori: Pinze batteria, anelli batteria, presa 12V accendisigari
- Tempi di gonfiaggio: Pneumatico moto 3 min
Pneumatico auto standard 5 min.
- Adattatori giochi gonfiabili e pneumatici ciclo

- *Tire repair kit*
- *High pressure air compressor for scooter, car, bicycle and Atv*
- *Power connections: Scooter rings, crocodile clamps, 12V plug*
- *Inflation times: Scooter tire 3 min - Standard car tire 5 min*
- *Adaptors for inflatable toys and bicycle tire*

- Pressione massima 6 bar
Max pressure 6 Bar
- Dimensioni: 120 x 145 mm
Dimensions: 120 x 145 mm
- Manometro integrato
Built in pressure gauge
- Flacone 250 ml di prodotto sigillante
250 ml sealant bottle



26 700 1010

EASY RIDER MODELLO BMW

- Kit di riparazione pneumatici
- Compressore d'aria ad alta pressione adatto per gomme scooter, auto e bici
- Connettori: Spina 12V modello DIN (3,4 m)
- Tempi di gonfiaggio: Pneumatico moto 3 min

- *Tire repair kit*
- *High pressure air compressor*
- *Power connections: 12V Plug DIN (3,4 m)*
- *Inflation times: Motorcycle tire 3 min*

- Pressione massima 6 bar
Max pressure 6 Bar
- Dimensioni: 120 x 145 mm
Dimensions: 120 x 145 mm
- Manometro integrato
Built in pressure gauge
- Flacone 250 ml di prodotto sigillante
250 ml sealant bottle



26 700 1030

TOUR

- Kit di riparazione pneumatici
- Compressore d'aria ad alta pressione adatto per gomme scooter, auto e bici
- Connettori: Spina 12V modello DIN (3,4 m)
- Tempi di gonfiaggio: Pneumatico moto 3 min

- *Tire repair kit*
- *High pressure air compressor*
- *Power connections: 12V Plug DIN (3,4 m)*
- *Inflation times: Motorcycle tire 3 min*

- Pressione massima 6 bar
Max pressure 6 Bar
- Dimensioni: 120 x 145 mm
Dimensions: 120 x 145 mm
- Manometro integrato
Built in pressure gauge



26 720 0600

FLACONE 250 ML DI PRODOTTO SIGILLANTE - 250 ML SEALANT BOTTLE

- Tecnologia gel
- Facilmente lavabile ad acqua

- *Gel technology*
- *Washed off with water*



26 700 1020

AIRGUN

- Compressore professionale ricaricabile senza fili
- Pressione massima 10 Bar
- Adattatori giochi gonfiabili e pneumatici ciclo
- Applicabile a: ATV, Pneumatici ciclo, equipaggiamenti sportivi

- High pressure professional air compressor
- rechargeable cordless
- Max pressure 10 Bar
- Adaptor for inflatable toys and bicycle tire
- Applications: ATV, Bicycle tires, sporting equipments

- Dimensioni: 160 x 260 mm
Dimensions: 160 x 260 mm
- Manometro integrato a led
Built in pressure led gauge
- Settaggio della pressione
Pressure preset
- 1 Batteria Li-ion 230V ricaricabile, 1 con adattatore 12V (3,4 m)
1 rechargeable Li-ion batterie 230V, 1 with 12V plug (3,4 m)



AIRMAN : CARATTERISTICHE TECNICHE - TECHNICAL FEATURES

	EASY RIDER	AIRGUN	EASY RIDER	AIRGUN
NOTA - NOTE	Può lavorare al max 10 minuti in continuo	Può lavorare al max 10 minuti in continuo	Can work max 10 minutes continuously	Can work max 10 minutes continuously
COMPRESSORE - COMPRESSOR				
Corrente - Power	10A	10A	10A	10A
Pressione massima - Max pressure	6 bar	10 bar	6 bar	10 bar
Dimensioni (BxH) - Compressor size (BxH)	120 x 145 mm	160 x 260 mm batteria inclusa	120 x 145 mm	160 x 260 mm included Battery
Connettori - Power connection	Modello standard: Pinze batteria, anelli batteria, presa 12V accendisigari Modello Bmw: Spina 12V Modello DIN	Batteria con 12V adattatore, 230V-Li-Ion-battery	Standard model: Scooter rings, Crocodile clamps, 12V plug Bmw model: 12V Plug DIN	Battery with 12V plug, 230V-Li-Ion-battery
Indicatore di Pressione - Pressure display	Indicatore in bar & psi	Pre-set, indicatore in bar, kpi, psi	Lighted display in bar & psi	Pre-set, lighted display in bar, kpi, psi
Tempi di gonfiaggio gomme (2,5 bar): Inflation times (2,5 bar):	Bici 3:00 Minuti Auto (media) 5:00 Minuti Auto (grande) 7:30 Minuti	Bici 1:00 Minuto Moto 3:00 Minuti	Bicycle 3:00 Minutes Car (standard) 5:00 Minutes Car (big) 7:30 Minutes	Bicycle 1:00 Minute Motorcycle 3:00 Minutes
SIGILLANTE - SEALANT				
Tipo - Sealant type	Tecnologia Gel	-	Particle Gel Technology	-
Quantità - Sealant size	250 ml	-	250 ml	-
Dimensione foro massimo - Max. puncture	10 mm	-	10 mm	-
Proprietà del sigillante Properties of sealant	Lavabile ad acqua con estrema facilità, non tossico, non infiammabile	-	Washed off with water, non-toxic, Non-flammable	-
Durata a stock - Shelf life	5 anni	-	5 years	-
ACCESSORI - ACCESSORIES				
Adattatori / Giochi - Adaptor / toys	Gomme bici (bassa pressione), palloni, gonfiabili	Bike tires (also high pressure), Balls, inflatable toys, extension hose, line adaptor	Bike tires (low pressure), balls, inflatable toys, valve extractor	Bike tires (also high pressure), Balls, inflatable toys, extension hose, line adaptor
Confezione - Transport bag	Borsa con logo	Borsa con logo	Cotton bag with Logo	Nylon bag with Logo
SICUREZZA - SAFETY				
Distanza percorribile dopo la riparazione Recommended driving distance after repair	max. 200 km	-	max. 200 km	-
Velocità max dopo la riparazione Max. speed limit	80 km/h	-	80 km/h	-
Certificazioni - Certification	CE-Certification, ISO 9001:2008, ISO 14001:2004, ISO TS 16949:2	CE-Certification, ISO 9001:2008, ISO 14001:2004, ISO TS 16949:2	CE-Certification, ISO 9001:2008, ISO 14001:2004, ISO TS 16949:2	CE-Certification, ISO 9001:2008, ISO 14001:2004, ISO TS 16949:2



KIT RIPARAZIONE PNEUMATICI

TYRES REPAIR KIT



26 702 0110 

Kit gonfiaggio e riparazione tubeless in borsa Rms composto da:

- 1 Tubetto mastice 12 cc.
- 1 Punteruolo
- 1 Tronchesino
- 3 bombolette Co2 16 Gr.
- 1 Raccordo universale
- 1 Prolunga raccordo flessibile
- 1 Set coni riparazione

Tyre repair kit In Rms bag

- 1 Rubber cement 12 cc.
- 1 Awl
- 1 Cutter
- 3 Carbon dioxide cartridgess
- 1 Universal connector
- 1 Flexible connector extension
- 1 Tyre plug kit

26 702 0160 

NEW

Kit 3 Coni ricambio per 26 702 0110
3 Pcs Tyre Plug kit for 26 702 0110



26 702 0020 

KIT RIPARAZIONE COPERTURA TUBELESS IN SCATOLA COMPOSTO DA:

- 1 tubetto mastice 22 cc - 2 punteruoli
1 taglierino - 5 pezzi di pura gomma
TUBLESS TYRE REPAIR KIT WITH:
1 Tyre rubber cement 22 cc tube - 2 Awles
1 Cutter - 5 rubber sticks

BOMBOLETTE CO2 - CO2 CARTRIDGES

58 808 0750 

NEW

- 3 pcs con filetto 25 gr.
- 3 pcs with thread 25 gr.

BOMBOLETTE CO2 - CO2 CARTRIDGES

58 808 0751 

NEW

- 30 pcs con filetto 25 gr.
- 30 pcs with thread 25 gr.

58 808 0190 

NEW

- 3 pcs con filetto 16 gr.
- 3 pcs with thread 16 gr.

58 808 0192 

NEW

- 50 pcs con filetto 16 gr.
- 50 pcs with thread 16 gr.



26 702 0030 

Stecche di gomma
per riparazione tubeless
Tyre repairing rubber sticks



56 702 0200 

Scatola tubetti mastice 22 cc
(cont. 12 tubetti)
Pack 12 pcs tyre rubber cement 22 cc tubes



56 702 0060 

Kit riparazione camera d'aria (no Tubeless)
Confezione in blister composto da:

- 5 pezze assortite
 - 1 tubetto mastice 10 cc
 - 1 raschietto
- Inner tube repair kit
Blister packaging with:
5 tyre repair patches
1 Rubber cement 10 cc tube
1 Scraper





26 700 2010 

XSTRAP
STANDARD DUTY

SET 2 CINGHIE A CRICCHETTO PER TRASPORTO MOTO

- Lunghezza 3 Mt.
 - Carico d'esercizio 136 Kg.
 - Carico Max 408 Kg.
- 2 RATCHET TIE DOWN**
- Lenght 3 Mt.
 - Safe work load 136 Kg.
 - Break strenght 408 Kg.



26 700 2020 

XSTRAP
HEAVY DUTY

SET 2 CINGHIE A CRICCHETTO PER TRASPORTO MOTO

- Lunghezza 3 Mt.
 - Carico d'esercizio 454 Kg.
 - Carico Max 1363 Kg.
- 2 RATCHET TIE DOWN**
- Lenght 3 Mt.
 - Safe work load 454 Kg.
 - Break strenght 1363 Kg.



26 700 2040 

RETE ELASTICA FISSAGGIO BAGAGLI

- Dimensioni 40 x 40 Cm.
 - 10 ganci metallici rivestiti in gomma
- CARGO STRETCH NET**
- Dimensions 40 x 40 Cm.
 - 10 coated steel hooks



26 700 2050 

RETE ELASTICA FISSAGGIO BAGAGLI

- Dimensioni 40 x 80 Cm.
 - 10 ganci metallici rivestiti in gomma
- CARGO STRETCH NET**
- Dimensions 40 x 80 Cm.
 - 10 coated steel hooks



26 700 2110 

TAGLIA - SIZE: M 203x89x119 cm

26 700 2120 

TAGLIA - SIZE: L 228x99x124 cm

26 700 2130 

TAGLIA - SIZE: XL 246x104x127 cm

26 700 2140 

TAGLIA - SIZE: XXL 264x104x127 cm

TELO COPRI MOTO

- Materiale: PEVA+PP
- Per esterni: impermeabile e resistente UV
- Cuciture termosaldate
- Anello antifurto
- Cinghia chiusura sottomoto

MOTORCYCLE COVER

- Material: PEVA+PP
- Outdoor use: water and UV resistant
- Termoweld stitch
- Lock hole
- Under motorbike strap

26 700 2140 su BMW R1200RT con valigie e bauletto
26 700 2140 on BMW R1200RT with side bag and top case



CAVALLETTI REGGIMOTO

Paddock Stand

26 700 0450



NEW

CAVALLETTO REGGIMOTO ANTERIORE
FRONT STAND



26 700 0460



NEW

CAVALLETTO REGGIMOTO POSTERIORE
REAR STAND

Da utilizzare con (To use with)

- 26 700 0470

- 26 700 0480



26 700 0470



NEW

ADATTATORE CAVALLETTO A FORCHETTA
FORK REAR STAND ADAPTER

Per Cavalletto posteriore 26 700 0460

For 26 700 0460 Rear stand



26 700 0480



NEW

ADATTATORE CAVALLETTO A SLITTA
FLAT REAR STAND ADAPTER

Per Cavalletto posteriore 26 700 0460

For 26 700 0460 Rear stand



26 700 0500



NEW

SUPPORTI CAVALLETTO UNIVERSALI
UNIVERSAL STAND SUPPORTS

Da utilizzare con (To use with)

- 26 700 0510

- 26 700 0520

- 26 700 0530



26 700 0510



NEW

ADATTATORI M6 PER SUPPORTO
CAVALLETTO UNIVERSALE
M6 SUPPORT ADAPTERS

Da utilizzare con (To use with)

- 26 700 0500



26 700 0520



NEW

ADATTATORI M8 PER SUPPORTO
CAVALLETTO UNIVERSALE
M8 SUPPORT ADAPTERS

Da utilizzare con (To use with)

- 26 700 0500



26 700 0530



NEW

ADATTATORI M10 PER SUPPORTO
CAVALLETTO UNIVERSALE
M10 SUPPORT ADAPTERS

Da utilizzare con (To use with)

- 26 700 0500



26 700 0490



NEW

CAVALLETTO BASE MOBILE
MOVABLE STAND





28 800 0630 

LUCCHETTO CATENA 10 X 10 X 1500

- Catena in acciaio temperato a maglia quadra.
- Rivestimento in nylon antigraffio.
- Lucchetto disc lock separabile con serratura sistema antiacqua/polvere
- Tre chiavi piatte
- Una con mini lampadina incorporata.

LOCK AND CHAIN 10 X 10 X 1500

- Hexagonal chain in hardened-steel
- Covered with anti-scratch nylon
- Separate disc lock
- Waterproof and anti-dust lock
- Three flat keys
- Integrated mini bulb



28 800 0640 

LUCCHETTO DISC LOCK 70x155 mm

- Serratura sistema antiacqua/polvere
 - Tre chiavi piatte
 - Una con mini lampadina incorporata
- DISC LOCK 70x155 mm**
- Waterproof and anti-dust lock
 - Three flat keys
 - Integrated mini-bulb



28 800 0690 

LUCCHETTO PITONE MONOBLINDO

- Lunghezza 1200 mm
 - Spessore 22 mm
 - Chiave piatta
 - Rivestimento in nylon antigraffio
 - Testa ricoperta in resina
 - Confezione in blister
- SECURITY LOCKABLE CHAIN**
- Length 1200 mm
 - Thickness 22 mm
 - Flat key
 - Covered with anti-scratch nylon
 - Resin-covered head lock
 - Blister packaging



28 800 0400 

NUOVO PITONE MONOBLINDO (Chiave piatta)

- Lunghezza 1200 mm
 - Ø 18 mm
 - Copertura antiacqua e polvere per la serratura
 - Confezione in blister
- NEW SECURITY LOCKABLE CHAIN (Flat key)**
- Length 1200 mm
 - Ø 18 mm
 - Waterproof and anti-dust lock cover
 - Blister packaging





LUCCHETTI ANTIFURTO VARI

VARIOUS LOCKS

28 800 0091 

MAXI DISK LOCK DE-LUXE

- Lucchetto al freno disco perno Ø 10 mm.
- Serratura con tappo di protezione
- Colori: rosso e giallo
- Chiave piatta
- Completo di borsetta
- Confezione in blister
- *Disc lock with Ø 10 pin*
- *Lock protection cover*
- *Colours: Red and Yellow*
- *Flat Key*
- *Bag included*
- *Blister packaging*

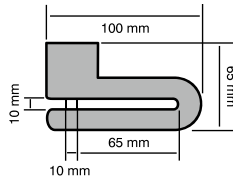

28 800 0101 

MINI DISK LOCK DE-LUXE

- Lucchetto al freno disco perno Ø 6 mm.
- Serratura con tappo di protezione
- Colori: rosso e giallo
- Chiave piatta
- Completo di borsetta
- Confezione in blister
- *Disc lock with Ø 6 pin*
- *Lock protection cover*
- *Colours: Red and Yellow*
- *Flat Key*
- *Bag included*
- *Blister packaging*

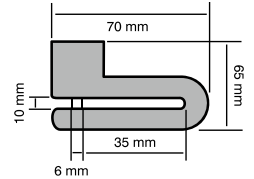

28 800 0130 

MICRO DISK LOCK

- Colorato
- Con borsetta
- Lucchetto al freno disco, perno Ø 6 mm
- Chiusura in acciaio cromato
- con meccanismo automatico.
- Chiavi tubolari.
- Confezione da 24 pezzi in blister
- *Coloured bag included*
- *Disc lock with Ø 6 mm pin*
- *Automatic chromed steel locking*
- *Tubular keys*
- *24 pcs blister packaging*

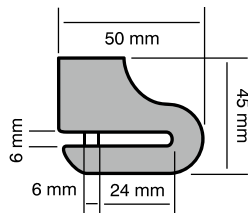

28 800 0120 

- Senza borsetta
- *Bag not included*

28 800 9000 

CAVO SPIRALE 4 x 1500 mm

- Posizionato sul manubrio è efficace
- per ricordare di non partire
- con lucchetto disco inserito
- Applicabile a tutti i lucchetti al disco
- Colori: rosso / giallo

SECURITY LOOP-CABLE 4 x 1500 mm

- *If installed on handlebar it reminds you not to start with the disc lock inserted*
- *Suitable for all disc locks*
- *Colours: Red and Yellow*



28 800 0650 

DISC LOCK CON ALLARME SONORO

- Lucchetto al freno disco perno Ø 6 mm
- Doppi sensori d'urto e movimento
- Attivazione automatica dell'allarme 30 secondi dopo la chiusura del lucchetto
- Finitura lucida
- Completo di borsetta
- Batterie (Tipo LR44 6 pezzi incluse)

DISC LOCK WITH ALARM

- *Disc lock with Ø 6 mm pin*
- *Double shock and motion sensors*
- *After locking the self-arming system will be set automatically 30 seconds later*
- *Glossy finish*
- *Bag included*
- *Batteries (Type LR44 - 6 pcs included)*

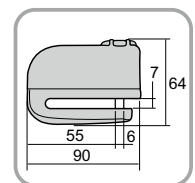

28 800 0270 

CATENA IN ACCIAIO CEMENTATO

ricoperta in PVC.

ANTI-THEFT PVC COATED CHAIN

Ø 4,5 mm - Lungh. - Length 80 cm





26 700 2060 

KIT PRONTO SOCCORSO - FIRST AID PACK

Conforme DIN13167 - 2014

Contenuto:

- 1 x rotolo cerotto adesivo
- 4 x bende adesive (10 x 6cm)
- 2 x cerotti resistenti all'acqua confezionati singolarmente (4 x 6,5 cm)
- 2 x cerotti resistenti all'acqua (12 x 2 cm)
- 2 x cerotti resistenti all'acqua confezionati singolarmente (1,9 x 7,2 cm)
- 4 x cerotti resistenti all'acqua confezionati singolarmente (2,5 x 7,2 cm)
- 1 x tampobenda sterile (8 x 10 cm)
- 1 x tampobenda sterile (10 x 12 cm)
- 1 x fasciatura sterile (ustioni)
- 1 x coperta isoterma d'emergenza
- 1 x forbici
- 4 x guanti monouso
- 2 x salviettine umidificate confezionate singolarmente
- 1 x lista del contenuto
- 1 x manuale kit pronto soccorso

Conforms to DIN13167 - 2014

Kit contents:

- 1 x adhesive plaster tape
- 4 x adhesive plaster bandages (10 x 6cm)
- 2 x water resistant single-packed plasters (4 x 6,5 cm)
- 2 x water resistant plasters (12 x 2 cm)
- 2 x water resistant single-packed plasters (1,9 x 7,2 cm)
- 4 x water resistant single-packed plasters (2,5 x 7,2 cm)
- 1 x first aid bandage roll (8 x 10 cm)
- 1 x first aid bandage roll (10 x 12 cm)
- 1 x sterile dressing (burns)
- 1 x first aid blanket
- 1 x scissors
- 4 x disposable gloves
- 2 x single-packed wet wipes
- 1 x list of contents
- 1 x first aid kit manual





RMS
YOUR BEST PARTNER

▶ BIKE SERVICE

BIKE SERVICE



ATTREZZI IMPIANTI ELETTRICI

////////////////////
ELECTRIC SYSTEM TOOLS

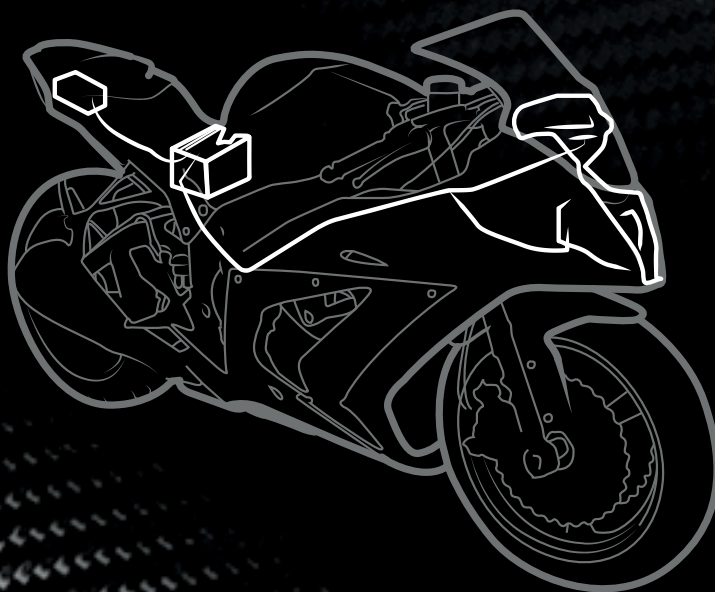

KIT GUAINA PER CABLAGGI ELETTRICI TERMORETRAIBILE IMPERMEABILE

Protezione e isolamento ottimali di componenti e cablaggi elettrici.

Rivestimento adesivo impermeabile della parete interna, realizza una sigillatura che impedisce la penetrazione dell'umidità.

Termoretrazione semplice e rapida con pistola termica.

WATERPROOF HEAT SHRINKABLE TUBE SET

Provides well protection and insulation of components and wires. Water Proof adhesive lined inner wall seals, preventing moisture ingress.

Quick and simple to shrink by heat gun.

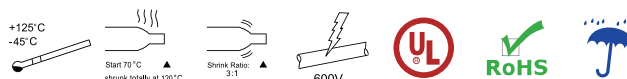

26 700 5000 | BS1031



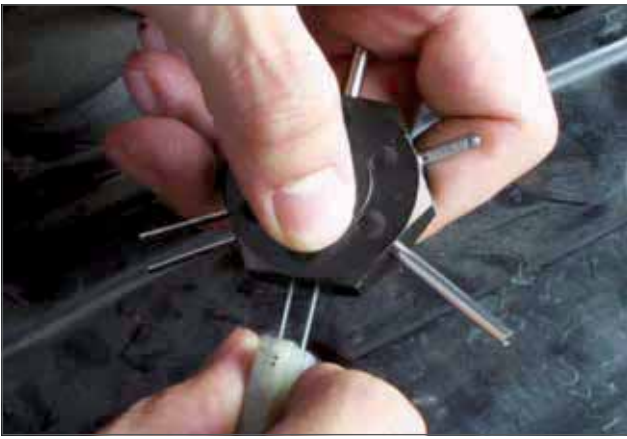

ELETTRICO | ELECTRIC





ATTREZZO SMONTAGGIO CONNETTORI ELETTRICI

Per rimuovere i cavi dai connettori senza danneggiarli.
Attrezzo multifunzione grazie alle diverse lame.

WIRE TERMINAL TOOL

Designed to remove wires from terminal without causing damage
to either. Multi-Functional with different shaped blades.

A 26 700 5010 | BS1815 

B 26 700 5020 | BS1814 



PINZA PROFESSIONALE SPELAFILI

Pinza spelafili con tagliacavo. Ideale per spelare e tagliare rapidamente fili e cavi intrecciati in rame e alluminio.

PROFESSIONAL WIRE STRIPPER

Tool with plier nose and wire cutter. Copper stranded wire quickly, Suitable for stripping and cutting aluminum and copper wire quickly.

26 700 5040 | BS9484 



ATTREZZI MANUTENZIONE MOTORE

ENGINE SERVICE TOOLS

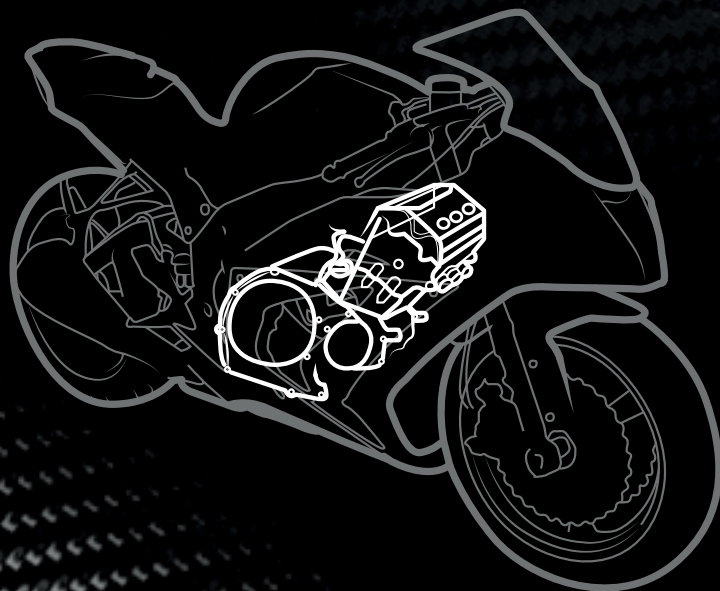

ATTREZZO SEPARATORE CARTER MOTORE

Adatto alla maggior parte dei motori a due e quattro tempi con carter a suddivisione verticale.

I braccetti mobili consentono di operare con diverse configurazioni di viti.

Completo di viti di montaggio, perno di trazione centrale e telaio a tre bracci.

CRANK CASE SEPARATOR TOOL SET

Suits most two and four stroke engines that have a vertically split crankcase. Moveable fingers allow for a multitude of bolt patterns.

Includes mounting bolts, pulling center bolt and three leg frame.

26 700 5310 | BS2300





ATTREZZO ESTRAZIONE CUSCINETTI

Ideale per diversi interventi di estrazione cuscinetti. Include separatore da 2" e 3" per una capacità di intervento da 30 mm a 75 mm, una piastra forgiata e una vite di spinta da 180 mm. I tiranti principali possono estendersi fino a max. 170 mm e 220 mm.

MECHANICAL BEARING PULLER SET

Suits a wide range of bearing extracting jobs. Includes 2" and 3" bearing splitter for pulling capacity from 30 mm-75 mm, one forged yoke and 180 mm trust bolt. Main rods extends long reach ability in maximum 170 mm and 220 mm.

26 700 5550 | BS4017



ATTREZZO MONTAGGIO FASCE PISTONI

Per il montaggio di fasce pistoni da 35 mm a 111 mm (da 1-3/8" a 4-3/8"). La pinza si può usare tangenzialmente o perpendicolarmente al blocco cilindro, essendo concepita per utilizzo con diverse angolazioni. L'impugnatura a cricchetto consente di tenere in posizione l'anello di compressione per un montaggio agevole delle fasce dei pistoni.

PISTON RING COMPRESSOR SET

Installs piston rings from 35 mm~111 mm (1-3/8" ~ 4-3/8"). Pliers can be used parallel or perpendicular to the cylinder block, an all angles operation designed pliers. Ratcheting function handle holds the compressing rings in position for easy installation of piston rings.

26 700 5150 | BS3032





ATTREZZO CONTROLLO PERDITE IMPIANTI RAFFREDDAMENTO / RADIATORI

Pompa manuale per aumentare e misurare la pressione per individuare eventuali perdite negli impianti di raffreddamento e nei radiatori.

La valvola a pulsante consente il rilascio della pressione in tutta sicurezza al termine della verifica.

COOLING SYSTEM & RADIATOR PRESSURE TEST

Hand operated pump increase and displays pressure to locate leaks in cooling and radiator systems.

Push-button valve safely relieves pressure when testing is completed.

26 700 5230 | BS0244



SET 8 ATTREZZI SMONTAGGIO / MONTAGGIO FILTRI OLIO

Il set di attrezzi per lo smontaggio/montaggio filtri olio consente di rimuovere e installare facilmente tutti i tipi di filtro anche quando si trovano in posizioni difficilmente accessibili. Può operare fino a una coppia di serraggio di 12 Kgm. La particolare forma a tazza esercita una presa ideale riducendo al minimo la possibilità di rottura del filtro. Utilizzare utensili con attacco quadro da 3/8" e chiave esagonale da 19 mm. Verniciatura anodica nera anticorrosione.

8 PC OIL FILTER WRENCH SET

The oil filter cap wrench set allows easy removal and installation, even in tight locations of motorcycle. It can withstand up to 12 kgm of torque. Cup type design grips like socket thus minimizing the possibility of crushing filters.

Use 3/8" square driver with 19 mm hex driver tools. Coated with dust-proof electro-black oxide.

26 700 5280 | BS6659





ATTREZZO UNIVERSALE PER SMONTAGGIO FILTRI OLIO A CARTUCCIA

Consente di smontare facilmente i filtri olio a cartuccia anche in punti difficilmente accessibili. I supporti con rivestimento vinilico riducono la possibilità di danneggiare il filtro. Adatto per filtri di diametro 63 mm - 99 mm (2 1/2"-3 7/8"). Insetto quadro da 3/8".

UNIVERSAL 3 LEG OIL FILTER WRENCH (63~99 MM)

Allows easy removal of cartridge style oil filters even in tight locations.

Vinyl dipped legs minimize filter damage.

Suits filters with 63 mm-99 mm (2 1/2"-3 7/8") diameter.

3/8" Sq. Dr.

26 700 5300 | BS6656



VASCA 4 LITRI DRENAGGIO / TRASPORTO OLIO ESAUSTO

Tappo a vite per massima praticità di riempimento e svuotamento. L'allentamento delle viti laterali è utile nelle operazioni di cambio olio. Sicurezza di trasporto e stoccaggio, senza fuoriuscite.

Realizzato in PE rinforzato resistente agli urti fino a 50 kg.

4L PORTABLE OIL DRAIN CAN

Screw cap for an easy fill and empty.

Loosening the side screws assists in the oil-changing process.

Ensures safe transportation and storage without spillage.

Durable reinforced PE material resistant to 50 kg impact.

26 700 5290 | BS8006



SPESSEMETRO MISURE METRICHE / POLLICI

Gamma misure metriche: 0,05 / 0,08 / 0,10 / 0,15 / 0,20 / 0,25 / 0,30 / 0,38.

Gamma misure in pollici: 0,0015" / 0,002" / 0,003" / 0,004" / 0,006" / 0,008" / 0,0100" / 0,012" / 0,015" / 0,025".

BLADE FEELER GAUGE

Metric size range: 0.05 / 0.08 / 0.10 / 0.15 / 0.20 / 0.25 / 0.30 / 0.38.

SAE Size range: 0.0015" / 0.002" / 0.003" / 0.004" / 0.006" / 0.008" / 0.0100" / 0.012" / 0.015" / 0.025".



26 700 5160 | BS3105



ATTREZZO REGOLAZIONE VALVOLE

Include chiavi di 3 misure: 8 mm, 9 mm, 10 mm.
Include 3 adattatori: tipo a vite e con inserto quadro da 3 mm e 4 mm.
Adattatori e chiavi intercambiabili per nove diverse combinazioni.
Idoneo alla regolazione di valvole sulla maggior parte dei motocicli e quad.

TAPPET ADJUSTING TOOL

Includes 3 size wrenches: 8 mm, 9 mm, 10 mm.
Includes 3 adjusters: at screw type, 3 mm and 4 mm square type.
Replaceable adjusters and wrenches for nine different combinations.
Fits most motorcycles and ATVs tappet adjusting.



A	26 700 5090 BS2201A 3 mm Quadrato / Square	
B	26 700 5100 BS2201B 4 mm Quadrato / Square	
C	26 700 5110 BS2201C 8 mm Esagono / Hex	
D	26 700 5120 BS2201D 9 mm Esagono / Hex	
E	26 700 5130 BS2201E 10 mm Esagono / Hex	
F	26 700 5140 BS2201F Vite testa piatta / Flat Screw	



ATTREZZO SMONTAGGIO SEMICONI VALVOLE

Per rimuovere i semiconi valvole nei motori a 4 tempi.
Mantiene in posizione i semiconi durante la sostituzione.
Adatto per la maggior parte dei motori a 4 tempi.

VALVE SPRING COLLET REMOVE/REPLACE TOOL

Removes valve spring split collets in 4 stroke engines.
Holds valve spring collets in position during replacement.
Suits most 4 stroke motorcycle engines.

A	26 700 5170 BS9828	
B	26 700 5180 BS9829	



SET PROFESSIONALE PER APERTURA/ CHIUSURA CATENE DISTRIBUZIONE

Con la semplice rotazione della chiave a T e l'apposita spina consente l'apertura semplice e rapida della catena di distribuzione per interventi di riparazione. Design pulito e compatto per la massima praticità d'uso. Adatto per diverse tipologie di maglie: 2x3 / 3x4 / 4x5. Spina realizzata in materiale SUJ2.

TIMING CHAIN BREAKING/RIVETING TOOL KIT

With the rotation of the T-bar and appropriate Push Pin, it provides a simplest way to break timing chain and repair it. Simple design, small volume for an easy use. Suits Chain Plate quantity: 2x3 / 3x4 / 4x5. Press Pin is material in SUJ2.

26 700 5580 | BS3550



BUSSOLA CANDELA EXTRASOTTILE

In acciaio al cromo vanadio temperato con inserto integrato in gomma per trattenere la candela durante il montaggio; attacco quadro 3/8" ed esagonale. Bussole a doppio esagono per facilitare l'accesso agli stretti alloggiamenti delle candele.

EXTRA THIN WALL SPARK SOCKET

3/8" Sq Dr. and Hex Dr. Hardened chrome vanadium steel with inbuilt rubber insert to hold plug during installation. Extra thin wall bi-hex sockets designed to access narrow spark plug holes.



A 26 700 5050 | BS9132 | 14 mm



B 26 700 5060 | BS9133 | 16 mm



C 26 700 5070 | BS9134 | 18 mm



D 26 700 5080 | BS9135 | 20.8 mm



ATTREZZO MONTAGGIO / SMONTAGGIO SONDA LAMBDA

Attrezzo per il montaggio o smontaggio della sonda lambda esagonale da 22 mm (7/8") e 11/16" su tutti i modelli a iniezione, attacco quadro 3/8".

OXYGEN SENSOR SOCKET TOOL

This tool is used to remove or install the 22 mm (7/8") and 11/16" hex oxygen sensor on all fuel injected models 3/8" Sq. Dr.



26 700 5460 | BS4224 | 11/16"



26 700 5470 | BS4224C | 22 mm





ESTRATTORE VOLANO

Estrattore filettato per volani. Punta con sfera in lega di acciaio al cromo per ridurre lo stress da attrito durante l'uso.

MAGNETIC FLYWHEEL PULLER

Thread puller designed for magneto flywheels. Chrome alloy steel ball tip on shaft to reduce friction stress during use.

ALTRE MISURE DISPONIBILI A PAG. 1059
NEW MEASURES SEE PAGE 1059



A	26 700 5320	BS2405	M22 x 1.5 mm	
B	26 700 5330	BS2441	M19 x 1.0 mm	
C	26 700 5340	BS2442	M24 x 1.0 mm	
D	26 700 5350	BS2443	M27 x 1.0 mm	
E	26 700 5360	BS2444	M27 x 1.25 mm	
F	26 700 5370	BS2470	M26 x 1.0 mm	
G	26 700 5380	BS2472	M28 x 1.0 mm	
H	26 700 5390	BS2473	M30 x 1.5 mm	
I	26 700 5400	BS2477	M22 x 1.5 mm	
L	26 700 5410	BS2479	M26 x 1.5 mm	
M	26 700 5420	BS2487	M35 x 1.0 mm	



ATTREZZO PER MODIFICARE/ ADATTARE DIAMETRO TUBI SCARICO

Attrezzo per l'espansione interna per aumentare il diametro di tutte le tipologie di tubi di scarico, manovra a chiave. Barra esagonale extra lunga per una maggiore praticità.

EXHAUST PIPE EXPANDER

Internal expanding designed tool operates with wrench to expand all exhaust pipe. Extra long hex rod for better handling.



A	26 700 5480	BS6101	29~44 mm	
B	26 700 5490	BS6103	38~64 mm	



ATTREZZO SMONTAGGIO MOLLE IMPIANTO DI SCARICO

Per lo smontaggio delle molle dell'impianto di scarico, le molle del cavalletto laterale e altri componenti.

EXHAUST SPRINGS U HOOK HANDLE

Used to remove exhaust pipe springs, side stand springs and other parts.

26 700 5950 | BS5201



ATTREZZO MONTAGGIO / SMONTAGGIO PRIGIONIERI

Agevola lo smontaggio e il montaggio dei prigionieri senza danneggiare il filetto. Adatto alle più comuni filettature.

STUD REMOVE AND INSTALL TOOL

Easily removes and installs studs without damaging threads. Suitable for most popular stud thread sizes.

A 26 700 5190 | BS2311 | M6 x P1.0



B 26 700 5200 | BS2312 | M8 x P1.25



C 26 700 5210 | BS2313 | M10 x P1.25



D 26 700 5220 | BS2314 | M10 x P1.5



ATTREZZO UNIVERSALE PER MONTAGGIO / SMONTAGGIO PRIGIONIERI

Assicura una presa ottimale sui prigionieri con filetto ruggine, agevolandone lo smontaggio e la sostituzione.

UNIVERSAL STUD SETTER AND EXTRACTOR

Powerful grip for stud with rusted threads, or for setting new ones.

26 700 5430 | BS4328



ATTREZZI MANUTENZIONE TRASMISSIONE FINALE

TRANSMISSION TOOLS

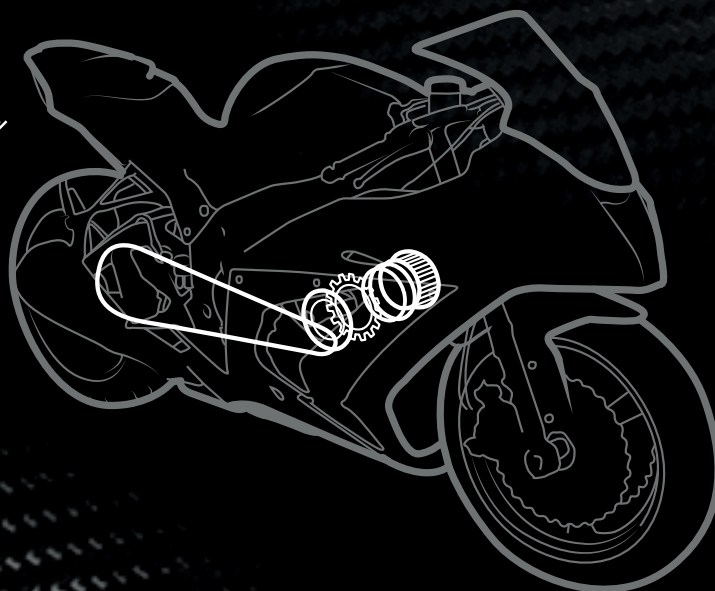

Bikeservice
Motorcycle Service Tools





CHIAVE PER SMONTAGGIO FRIZIONE VARIATORE

Per lo smontaggio e la sostituzione del dado campana frizione su scooter.

CLUTCH NUT WRENCH

For removing and replacing the clutch bell nut on scooter.

A 26 700 5510 | BS9861 | 34 mm 

B 26 700 5520 | BS9862 | 39 mm 

C 26 700 5530 | BS9863 | 41 mm 

D 26 700 5540 | BS9864 | 46 mm 



**ATTREZZO BLOCCAGGIO CAMPANA
FRIZIONE VARIATORE**

Impugnatura fucinata con fascia in pelle molto resistente. La fascia si stringe intorno alla puleggia all'aumentare della forza applicata. Per diametri da: 25 mm a 160 mm.

HEAVY DUTY PULLEY HOLDER WRENCH

Drop forged handle with heavy duty leather strap. The strap tightens around the pulley as more effort is applied. Diameter: 25 mm~160 mm.

26 700 5500 | BS6728



**ATTREZZO PER CONTROLLO TENSIONE
CINGHIA TRASMISSIONE**

Design compatto con scala di misura per facilitare la lettura. Compatibile per tutti i modelli di cinghie di trasmissione.

BELT TENSION GAUGE

Compact design with graduated scale for easy reference. Designed to work with all belt drive models.

26 700 5590 | BS4532



**SET PROFESSIONALE PER APERTURA/CHIUSURA
CATENE TRASMISSIONE**

Il set professionale universale per la riparazione delle catene di trasmissione è ideale per l'apertura di catene di misura fino a 632 esercitando pressione sui perni forati e sulle piastre della falsa maglia di catene.

Attrezzo per utilizzo manuale (serraggio a mano) con chiave a T o con l'inserto quadro 3/8" e 19 mm con chiave 21 mm. Spina realizzata in materiale SUJ2.

**UNIVERSAL TRANSMISSION CHAIN
REPAIRING MASTER SET**

Universal Chain Repairing Master Set is designed to break chains up to chain size #632 and press the hollow link pins and plates of the Master Link.

The Tool is designed for hand use (tightened by hand) utilizing the T-Bar or 3/8" Square and 19mm with 21 mm spanner. Push Pin is material in SUJ2.

26 700 5600 | BS35101



ATTREZZI MANUTENZIONE TELAIO

////////////////////
FRAME SERVICE TOOLS

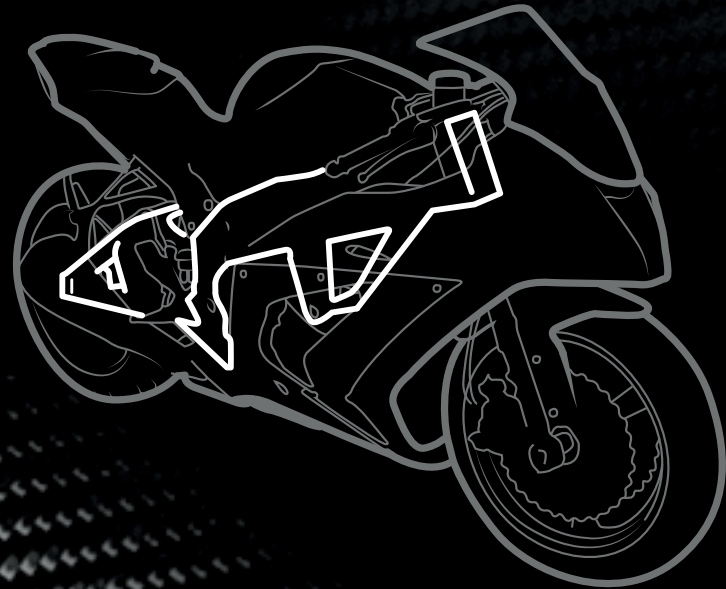

SET 17 PEZZI PER INSTALLAZIONE / RIMOZIONE CUSCINETTI

Per lo smontaggio e l'installazione di cuscinetti su motocicli, automobili, camion, trattori, macchine per movimento terra, motori elettrici e molte altre applicazioni. Comprende 3 impugnature di manovra in una valigetta metallica e 14 adattatori per cuscinetti da 10 mm - 42 mm.

17 PCS BUSHING DRIVER SET (METRIC)

Removes and installs bushes on motorcycles, cars, trucks, tractors, construction equipment, electric motors and many other applications.
Includes 3 drive handles in metal storage case and 14 adapters from 10 mm - 42 mm bushing drivers for 14 pcs.

26 700 5560 | BS9144



ATTREZZO ESTRAZIONE CUSCINETTI STERZO

Evita il danneggiamento del cannotto grazie al semplice smontaggio della pista esterna. 4 punti di contatto assicurano una presa uniforme. Adatto per cannotti di sterzo Ø 39 mm - Ø 57 mm (1½-2 3/16").
Lunghezza: 320 mm (12½").
Rimuovere le protezioni in plastica prima dell'uso.

STEERING BEARING REMOVE TOOL

Avoiding tube damage with easy outer race removal.
4 contact points ensures even race removal.
Suits tube Ø 39 mm - Ø 57 mm (1½-2 3/16").
Length: 320 mm (12½").
Remove plastic protection ears before using.



26 700 5570 | BS4201



ESTRATTORE CUSCINETTO PIASTRA INFERIORE STERZO

Attrezzo per smontare il cuscinetto conico dalla piastra inferiore di sterzo. L'estrattore è dotato di un'apertura molto sottile per operare tra la piastra e il cuscinetto. Grazie all'asta estensibile è adatto a diverse misure di perno sterzo.

STEERING/ LOWER TRIPLE CLAMP BEARING PULLER

Use this tool to remove the lower fork stem (separator) tapered bearing.
Tapered fork stem bearing remover features extra thin opening for slot entry between stem and bearing. Rod extension can be used on multiple sizes of fork stems.

26 700 5890 | BS9892



- A** Ø30~56 mm
Separatore cuscinetti / Bearing separator
- B** 2pc (L) 240~320 mm
Asta estensibile / Extension bar
- C** (L) 100 mm
Vite di spinta / Forcing screw
- D** Ø28 mm
Testa spintore girevole / Rotating pusher head
- E** 45~100 mm
Traversa / Beam
- F** 17 mm and 19 mm
Chiave a cricchetto / Ratchet wrench
- G** M8 x (L) 75 mm
Vite e dado separatore / Separator bolt and nut



**ATTREZZO MONTAGGIO CUSCINETTO
PIASTRA INFERIORE STERZO**

L'adattatore in materiale plastico consente il montaggio semplice e sicuro del cuscinetto della piastra inferiore. Basta scegliere l'adattatore idoneo, infilare l'inserto di regolazione sul canotto di sterzo e posizionare il cuscinetto con l'ausilio di un martello o pressa, evitando qualsiasi rischio di danneggiamento. Misure adattatori: 24, 26, 27, 28, 30 mm.

**STEERING / LOWER TRIPLE CLAMP BEARING
INSTALLER TOOL SET**

The P.O.M. adaptor offers a new, safe approach to lower bearing installation.
Simply choose the correct adaptor, slide the setting driver over the steering tube and tap the bearing into place with hammer or press, avoiding any risk of damage.
Adaptor sizes: 24, 26, 27, 28, 30 mm.



26 700 5900 | BS9893



**ATTREZZO SMONTAGGIO / MONTAGGIO
PERNO RUOTA ANTERIORE**

Idoneo per lo smontaggio della maggior parte dei perni della ruota anteriore.
4 misure in un unico attrezzo: 17, 19, 22, 24 mm (esagono 6 punti).
Attacco quadro 3/8", coppia max 12 Kgm.

FRONT WHEEL SPLINDLE REMOVE TOOL

Designed to fit most spindles during front wheel removal.
4 sizes in 1 tool which covers sizes 17, 19, 22, 24 mm (Hex 6 Point).
3/8" Sq.Dr., for maximum 12 Kgm torque.



26 700 6000 | BS5530







CHIAVE A SETTORE REGOLABILE

Acciaio temperato al cromo vanadio.
Speciali chiavi a C temperate ideali per l'utilizzo con ghiera di tenuta scanalate. L'estremità ad uncino, sottile solo 4 mm, consente l'accesso anche alle zone più difficili dello sterzo e delle sospensioni.

ADJUSTABLE C HOOK WRENCH

Chrome vanadium hardened steel.
Tempered C-hook wrenches are specially designed for using with slotted retaining rings.
4 mm thin hook allows to access to narrow areas in motorcycle steering and suspension.

A 26 700 5610 | BS0350 | 19-51 mm 

B 26 700 5620 | BS0351 | 32-76 mm 

C 26 700 5630 | BS0352 | 51-120 mm 



ATTREZZO PER LUBRIFICAZIONE INTERNA CAVI GAS-FRENO-FRIZIONE

Per la corretta lubrificazione dei cavi gas, freno e frizione.
Si applica all'estremità della guaina, iniettando direttamente dalla bomboletta il lubrificante.

CABLE WIRE LUBRICATION TOOL

Injects lubricant into cable housing directly from lubricant aerosol bottle.
Designed to lubricate throttle, brake and clutch cables.

26 700 5030 | BS4531 

ATTREZZI MANUTENZIONE IMPIANTI FRENANTI

//////
BRAKE SYSTEM SERVICE TOOLS

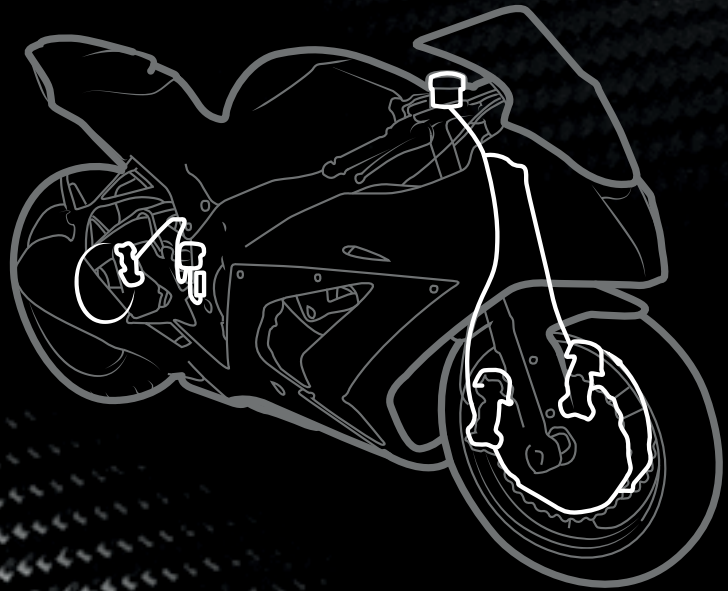

■ POMPA PER DISAERAZIONE IMPIANTO FRENANTE

Attrezzo per la disaerazione degli impianti frenanti e frizioni idrauliche.

Fornito completo di connettori in tre misure e diversi adattatori.

Corpo in alluminio pressofuso completo di manometro e kit accessori.

Facile da smontare per le operazioni di pulizia.

Fornito in una valigetta di metallo.

VACUUM PUMP AND BRAKE BLEEDER KIT

Tool for bleeding operation in brake systems and hydraulic clutch

Supplied complete with three connector sizes and various adaptors.

Die cast body with gauge and accessory kit.

Easily dismantled for cleaning.

Supplied in metal case.

26 700 5960 | BS5582





ATTREZZO SMONTAGGIO MOLLE FRENO

Realizzato in lega di acciaio trattato termicamente, studiato specificamente per lo smontaggio e l'installazione delle molle dei freni, solitamente difficili da raggiungere.
Lunghezza: 150 mm (6"), con chiave a T di largh. 75 mm (3").

HEADLIGHT AND BRAKE SPRING HOOK

Made from heat treated alloy steel, specially designed for removing and installing brake springs.
Length: 150 mm (6"), with a 75 mm (3") wide T-handle.

26 700 5930 | BS0044



TESTER DIGITALE PER FLUIDO IMPIANTI FRENANTI

Infilare l'asta del tastatore per pulire i due elettrodi sulla testa dell'astina di prova.
Immergere la testa dell'astina di prova nel nuovo fluido frenante per circa 20 mm.
Premere il tasto test.
Con un cacciavite Phillips regolare la vite di reset.
Ruotare fino a quando la spia verde di reset lampeggia (a sinistra).

BRAKE FLUID CONDITION TESTER

Twist down the test probe bar to clean the two electrodes on the test bar head.
Immerse the test bar head into new brake fluid approximately 20 mm.
Press the test button.
Use a Phillips screwdriver to adjust the reset screw.
Turn until the green reset indicator (far left) ashes.

26 700 5940 | BS0245



ATTREZZO PER ALLARGARE PISTONI PINZA FRENO

Allarga i pistoni delle pinze freno per agevolare la sostituzione delle pastiglie.

CALIPER PISTONS SPREADER

Widens caliper pistons for easy pad replacement.

A 26 700 5970 | BS9870 | 30 mm



B 26 700 5980 | BS9871 | 70 mm



ATTREZZI MANUTENZIONE FORCELLA

FRONT FORK SERVICE TOOLS

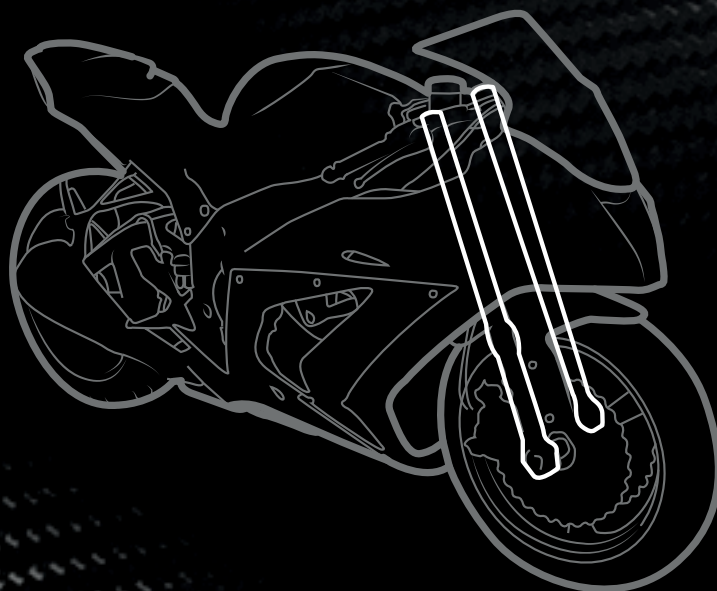

ATTREZZO INSERIMENTO/ VERIFICA LIVELLO OLIO FORCELLA

Per controllare e regolare il livello dell'olio su tutte le forcelle. L'anello regolabile consente la lettura del livello dell'olio da 0 a 300 mm con passi da 0,5 cm. La siringa ha una capacità di 60 ml.

Può essere utilizzato su biciclette dotate di sospensione anteriore.

FORK OIL LEVEL GAUGE TOOL

For checking and adjusting the oil level on all forks. Adjustable ring will measure oil levels from 0 to 300 mm in 0.5 cm increments.

The syringe has a capacity of 60 ml.
Can be used on bicycles equipped with front suspension.

26 700 5920 | BS41500 





BUSSOLA 1/2" CHIAVE MASCHIO



Bussole chiave maschio con diverse tipologie di inserti per svariati modelli e misure di forcella. Attacco quadro 1/2".

1/2" BIT SOCKET

Bit sockets with different screw standard for various designs and sizes of the front forks.
1/2" Sq.Dr.

 **26 700 5640** | BS9730A | 8 mm 

 **26 700 5650** | BS9730B | 10 mm 

 **26 700 5670** | BS9730C | 12 mm 



ATTREZZO MONTAGGIO PARAOLI FORCELLA

Consente l'installazione facile e precisa dei paraoli della forcella.
Ampia gamma di inserti per garantire la compatibilità con la maggior parte delle forcelle (21 diverse misure).

FRONT FORK OIL SEAL DRIVER

Allows an easy installation of front fork oil seals.
Full range of driver sizes to suit most of forks (21 sizes).

26 700 5820 BS9827Q 27 mm	
26 700 5830 BS9827R 30 mm	
26 700 5840 BS9827S 31 mm	
26 700 5680 BS9827A 32 mm	
26 700 5690 BS9827B 33 mm	
26 700 5850 BS9827T 34 mm	
26 700 5700 BS9827C 35 mm	
26 700 5710 BS9827D 36 mm	
26 700 5720 BS9827E 37 mm	
26 700 5730 BS9827F 38 mm	
26 700 5740 BS9827G 39 mm	

26 700 5750 BS9827H 40 mm	
26 700 5760 BS9827J 41 mm	
26 700 5860 BS9827U 42 mm	
26 700 5770 BS9827K 43 mm	
26 700 5780 BS9827L 45 mm	
26 700 5790 BS9827M 46 mm	
26 700 5870 BS9827V 47 mm	
26 700 5800 BS9827N 48 mm	
26 700 5880 BS9827W 49 mm	
26 700 5810 BS9827P 50 mm	

ATTREZZI PER PNEUMATICI

TIRE SERVICE TOOLS

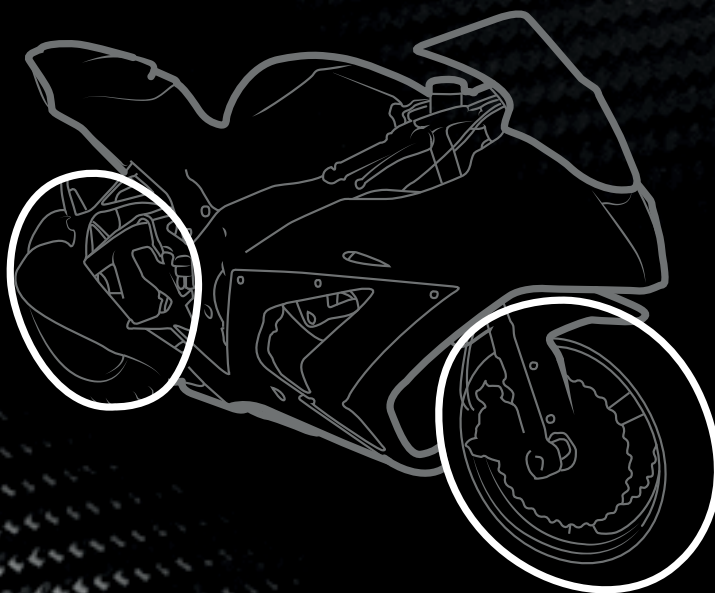

LEVA SMONTAGOMME

Lega di acciaio forgiato e temperato.
Ideale per lo smontaggio degli pneumatici moto.

TIRES LEVER

Drop forged and tempered alloy steel.
Designed for motorcycle tires removal.

A 26 700 6040 | BS5603 | L 200 mm



B 26 700 6050 | BS5604 | L 400 mm



C 26 700 6060 | BS5612 | Curva / Curved





PNEUMATICI | TIRE



SET 3 PEZZI PROTEZIONE CERCHI PER SMONTAGGIO PNEUMATICI

Protegge il cerchio da eventuali danni durante lo smontaggio del pneumatico.
Lunghezza totale 150 mm.

3 PC RIMS PROTECTOR SET

Protects wheel rims from damage during tyre removal.
Overall length 150 mm.

26 700 6010 | BS9952



MANOMETRO DIGITALE PRESSIONE PNEUMATICI

Ugello angolare adatto a tutte le tipologie di valvole dei motocicli.
Taratura in bar, kPa e PSI con la semplice pressione di un tasto per cambiare l'unità di misura. Funzionamento con una mano sola, lettura accurata su display LCD.
Auto Power o basso consumo.
Campo di misurazione 2-100 PSI (0,15-7,00 bar).
Risoluzione 0,5 PSI (0,05 bar o 5 kPa).
Precisione +1% +0,5 PSI.
Temperatura d'esercizio 10°C-30°C/50°F-86°F.
Alimentazione con batteria al litio 3V.

DIGITAL TIRE PRESSURE GAUGE

Angled nozzle fits all types of motorcycle valves.
Calibration in bar, kPa and PSI at the push of a button for unit change.
One hand operation, accurate digital LCD reading.
Auto Power o, low power consumption.
Measuring range 2-100 PSI (0.15-7.00 bar).
Resolution 0.5 PSI (0.05 bar or 5 kPa).
Accuracy +1% +0.5 PSI.
Operating temperature 10°C-30°C/50°F-86°F.
Power 3V Lithium battery.

26 700 6020 | BS3238



ATTREZZO MONTAGGIO / SMONTAGGIO VALVOLE PNEUMATICI TUBELESS

La barra in acciaio con manicotto mobile in gomma offre la leva ideale per lo smontaggio delle valvole tubeless. Evita il danneggiamento dei cerchi in lega.

TIRE VALVES EXTRACTOR BAR

Steel bar with movable rubber sleeve offers maximum leverage during removal of snap-in valves. Prevents damage to alloy wheels.



26 700 6030 | BS3699



ATTREZZI GENERICI

//////
HAND TOOLS

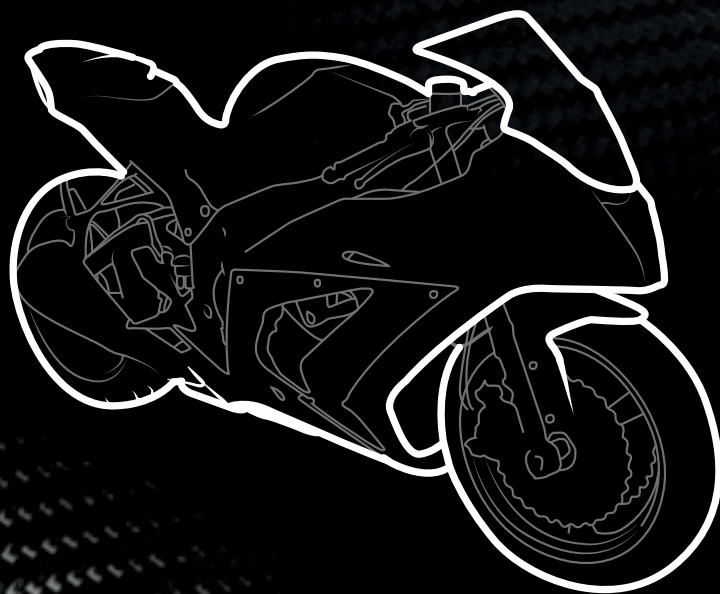

SET 8 PZ. CHIAVI 6-19 MM COMBinate

Adatte a dadi misura metrica e SAE da 6pt, 12pt, torx, quadrati.

8PC (6-19 MM) MULTI DRIVER WRENCH SET

Fits Metric and SAE 6pt, 12pt, TX-Star, Square.

DISPONIBILI ANCHE SINGOLARMENTE A PAG. 1059
ALSO AVAILABLE SINGLE PIECES PAG. 1059

26 700 6130 | BS6012





SET CHIAVI COMBINATA A CRICCHETTO 6-19 MM

Interamente cromata lucida.
Serie brevettata di chiavi a cricchetto combinate con estremità ad anello. L'impugnatura sottile in lega di acciaio forgiato offre prestazioni ottimali negli interventi di riparazione.

RATCHET WRENCH SET 6-19 MM

Fully polished chrome plated.
Patented ratcheting ring end combination wrenches.
Forged alloy steel thin provides high performance in repairing jobs.



DISPONIBILI ANCHE SINGOLARMENTE A PAG. 1060
ALSO AVAILABLE SINGLE PIECES PAG. 1060

26 700 6260 | BS7407



CRICCHETTO REVERSIBILE

Cricchetto reversibile, a sgancio rapido, 72 denti con rivestimento heavy duty. L'impugnatura robusta e resistente offre anche caratteristiche di isolamento dal calore. Specificamente concepito per lavorare sulle moto senza danneggiare le superfici.

RATCHET HANDLE

Reversible and quick release ratchet with 72 teeth covered with heavy duty coating.
Strong and durable handle provides heat insulation features.
Designed for specific motorcycle work without damage to bike surfaces.



A 26 700 6220 | BS7288 | 1/4"



B 26 700 6230 | BS7291 | 1/2"





CHIAVE DINAMOMETRICA DIGITALE

Disponibile con innesto quadro 1/4", 1/2".
Cricchetto a 72 denti.
Display LED con visualizzazione in Nm, ft.Lbs, in.Lbs, kgm, kg-cm.
Segnale acustico (clic) al raggiungimento della coppia di serraggio.
Funzionamento a batteria CR 2032 (3 volt).
Involucro resistente agli urti e agli oli.
Spegnimento automatico dopo 2 minuti.
Completo di certificato di taratura.

DIGITAL READING TORQUE WRENCH

Available in 1/4", 1/2" Sq. Dr.
72 teeth ratchet.
LED displays in Nm, ft.Lbs, in.Lbs, kgm, kg-cm.
Click sounds as torque achieved.
Battery operated use CR 2032 (3volt).
Oil resistant impact resistant casing.
Automatic power off after 2 minutes.
Calibration certificate supplied.

A 26 700 6240 | BS5421 | 1/4"



B 26 700 6250 | BS5423 | 1/2"



SET 2 PZ. CHIAVI A CRICCHETTO 4 IN 1

Chiave a cricchetto reversibile a doppia estremità, comprende 4 misure in un unico attrezzo.

2 PC "4 IN 1" REVERSIBLE RATCHET WRENCH SET

Reversible type dual end ratchet wrench, includes four sizes in one tool.

26 700 6150 | BS7525



CRICCHETTO REVERSIBILE 1/2" CON PROLUNGA (DA 340 A 500 MM)

Cricchetto a 36 denti con resistente impugnatura allungabile, lunghezza da 34 cm a 50 cm.

1/2" DRIVE F HANDLE TELESCOPING RATCHET (340 - 500 MM)

36 tooth ratchet with durable and extensible handle length 34 cm to 50 cm.



26 700 6080 | BS5420





SET CHIAVI ESAGONALI A T L 300 MM

Bussola e asta in acciaio forgiato al cromo vanadio con finitura cromata trattata termicamente. Impugnatura in acciaio al carbonio. Lunghezza: 300 mm.

300 MM LONG T-HANDLE SOCKET

Drop forged chrome vanadium steel socket and shaft with heat treated and chrome plated finish. Handle is carbon-steel. Length: 300 mm.

DISPONIBILI ANCHE SINGOLARMENTE A PAG. 1059
ALSO AVAILABLE SINGLE PIECES PAG. 1059



26 700 6070 | BS1660



SET BUSSOLE ESAGONALI SQUARE DRIVE BITS SOCKET SET

A 26 700 6200 | BS9200 | 1/4"



B 26 700 6210 | BS9202 | 1/2"





PINZA CHIUSURA TUBAZIONI IN GOMMA

Consente di risparmiare tempo in diversi interventi sul motore. L'anello di serraggio assicura una presa sicura in ogni posizione.

La speciale morsa raggiata evita danni ai componenti.

HOSE CLAMP PLIER

Helps save time in various engine jobs.

The locking ring provides tight grip in any positions. Special radius jaw design prevents damage.

A 26 700 5240 | BS9036



B 26 700 5250 | BS9037



C 26 700 5260 | BS9041



SET 9 PEZZI CHIAVI TX LUNGHE CON CALAMITA

Interamente cromate lucide.

Misure Torx: T10, T15, T20, T25, T27, T30, T40, T45, T50

In acciaio al cromo vanadio, con potente magnete incorporato per trattenere le viti.

9 PC EXTRA LONG TX-STAR KEY SET

Fully polished chrome plated.

Tx-star sizes: T10, T15, T20, T25, T27, T30, T40, T45, T50

Chrome vanadium steel made, build-in strong magnet to prevent screws dropping.

26 700 6090 | BS9101



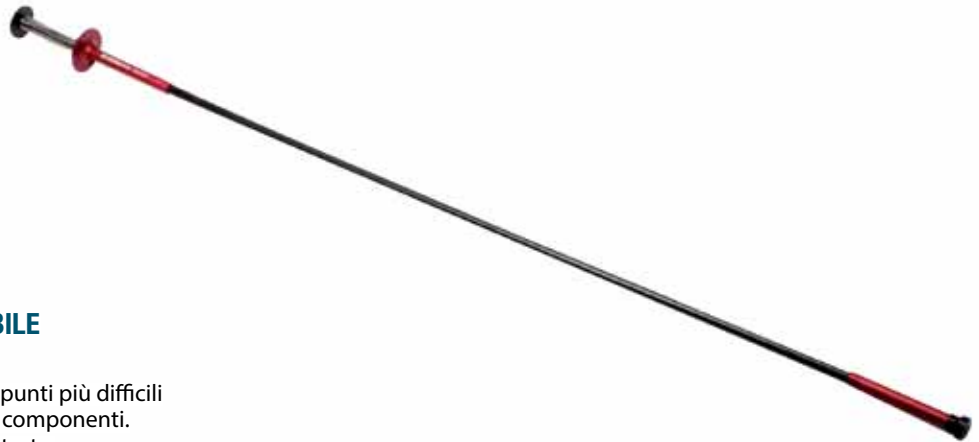

ATTREZZO MAGNETICO FLESSIBILE PER RACCOLTA OGGETTI

L'asta flessibile consente l'accesso ai punti più difficili per il recupero di minuteria e piccoli componenti. Artiglio apribile con la pressione del tasto. Magnete per pesi fino a 0,5 kg. Lunghezza: 700 mm. Massima apertura artiglio: 25 mm.

FLEXIBLE MAGNETIC CLAW PICK UP TOOL

The flexible spring shaft allows the tool to reach awkward areas to grab parts. Press the button to extend claw. Magnet loads weight up to 0,5 kg. Length: 700 mm. Claw maximum opening: 25 mm.

26 700 6140 | BS7030



Tasto a pressione a molla
Spring Push Button



Morsa a molla con presa magnetica
Magnetic pick up and Spring Claw



Ideale per il recupero di viteria e minuteria
Grab the screws



SET 9 PEZZI CHIAVI ESAGONALI MASCHIO LUNGHE CON ESTREMITÀ A SFERA

Interamente cromate lucide.
Misure esagono: 1,5 - 2 - 2,5 - 3 - 4 - 5 - 6 - 8 - 10 mm.
In acciaio al cromo vanadio, con potente magnete incorporato per trattenere le viti.

9 PC EXTRA LONG BALL POINT HEX

Fully polished chrome plated.
Hex sizes: 1.5, 2, 2.5, 3, 4, 5, 6, 8, 10 mm
Chrome vanadium steel made, build-in strong magnet to hold screws in position.

26 700 6100 | BS9103





GIRAVITE FLESSIBILE CON INSERTI

L'asta flessibile consente l'accesso ai punti più difficili per lo smontaggio e il montaggio della maggior parte delle fascette stringitubo.

FLEXIBLE HOSE CLAMP NUT/ SCREW DRIVERS

Flexible shaft allows access to awkward locations for easy removal and installation of most hose clamps.

26 700 5270 | BS2008



SET CACCIAVITE A PERCUSSIONE CON INSERTI

Per allentare dadi e bulloni ruggini o grippati. Reversibile per la massima sicurezza nello smontaggio e nel serraggio.

4 inserti Phillips: PH1, PH2, PH3, PH4.
3 inserti piatti: 8 mm, 10 mm, 12 mm.

IMPACT DRIVER SET

Loosens rusted or seized nuts and bolts. Reversible for secure tightening and removal.

4 Phillips bits: PH1, PH2, PH3, PH4.
3 Flat bits: 8 mm, 10 mm, 12 mm.

26 700 6110 | BS9651



SET BUSSOLA 1/2" CHIAVE MASCHIO TX

Bussole chiave maschio TX con diverse tipologie di inserti. Le bussole chiave maschio permettono un angolo di manovra fino a 30°, migliorando l'accessibilità a zone difficili e consentendo di raggiungere il dispositivo di fissaggio da posizioni angolate. Attacco quadro 1/2".

3PC 1/2" TX-STAR BIT SOCKET SET

TX sockets with different screw standard for various designs and sizes of the front shock absorber.

Bit sockets allow a working angle up to 30°, provide improved access to hard-to-reach areas and allow angle access to the fastener.

1/2" Sq.Dr.

26 700 5910 | BS9731



A Lunghezza asta: 152 mm (6").
Lunghezza complessiva: 241 mm (9-1/2").
L'asta extra lunga consente di raggiungere anche O-ring e paraoli posizionati in profondità.

Shaft length: 152 mm (6").
OAL.: 241 mm (9-1/2").

Extra long shaft reaches o-rings or seals set in deep areas.

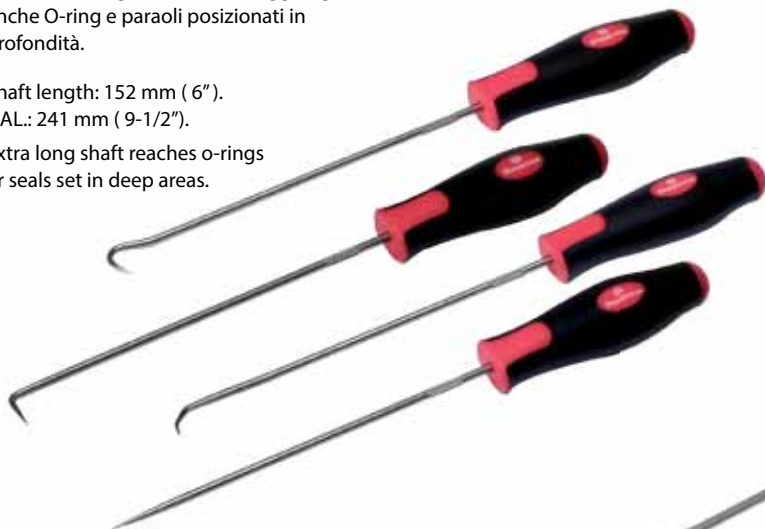

SET 4 ATTREZZI PER RIMOZIONE O-RING / PARAOLI

Ideale per lo smontaggio agevole di O-ring, perni scanalati, tenute e boccole su vari componenti meccanici. Ogni attrezzo è realizzato in acciaio inox con un'impugnatura soft grip in plastica resistente. Il set comprende attrezzi con puntale diritto, a uncino, curvo (45° e 90°). Ideale per lavori di precisione e interventi di scalfitura e rimozione.

4PC PICK & HOOK SET

Designed for easy removal of O-rings, split pins, seals and bushes in various mechanical applications. Each hook and pick is made of stainless steel with durable plastic soft grip handle. Contains straight awl, hook tool, 45° and 90° bent picks. Use for detail work and scribing, picking jobs.

B Lunghezza asta: 76 mm (3").
Lunghezza complessiva.: 162 mm (6-3/8").
Shaft length: 76 mm (3").
OAL.: 162 mm (6-3/8").



Puntale a uncino
Hook pick



Puntale a 90°
90° angle pick



Puntale a 45°
45° combination pick



Puntale diritto
Straight pick / Awl

A 26 700 5440 | BS0230 

B 26 700 5450 | BS1234 



ATTREZZO PER RIMUOVERE O-RING PARAOLI 150 MM E 170 MM

Rimozione semplice e rapida di O-ring e paraoli. La speciale testa dalla conformazione angolare consente maggiore facilità di accesso rispetto agli attrezzi tradizionali. Lunghezza: 170 mm e 150 mm.

2PC SEAL PICK SET 150 MM AND 170 MM

Quick and easy removal of O-Ring and oil seals. Special angle designed head provides easier access for removal than traditional tools. Length: 170 mm and 150 mm.

26 700 5990 | BS1235 



ATTREZZO RINFORZATO RIMOZIONE GUARNIZIONI

Attrezzo multifunzione per interventi generali di rimozione e raschiatura.

Ideale per rimuovere stemmi, guarnizioni, strisce decorative e decalcomanie.

Evita il rischio di danneggiare le superfici in metalli morbidi o le parti verniciate.

Impugnatura robusta e resistente idonea per l'uso di un martello dove sia necessario applicare una forza maggiore.

Lunghezza: 280 mm (11").

REINFORCED PLASTIC SCRAPER

The scraper is a multi-function tool designed for general scraping jobs.

Ideal for removal of badges, gaskets, stripes, decals etc.

Eliminates damage to the surface of soft metals and paintwork. Durable tough handle suitable for hammer use where extra force is required.

Length: 280 mm (11").

A 26 700 6170 | BS2260 | 15 mm 

B 26 700 6180 | BS2261 | 30 mm 

C 26 700 6190 | BS2262 | 50 mm 



ATTREZZO PER RILEVAMENTO PROFILI 250 MM

Per il rilevamento rapido e semplice di forme complesse per interventi di taglio e sagomatura.

Lunghezza: 250 mm

250 MM PROFILE GAUGE

Quick and easy to gauge difficult shapes for cutting and shaping.

Length: 250 mm

26 700 6160 | BS4502 

SET RIPARAZIONE FILETTATURE METRICO

Inseri filettati: M5-0,8 x 1,5D, M6-1,0 x 1,5D, M8-1,25 x 1,5D, M10-1,5 x 1,5D, M12-1,75 x 1,5D.

Misura punta a forare: 5,2 - 6,3 - 8,3 - 10,5 - 12,5 mm

THREADED COIL INSERT REPAIR KIT (METRIC)

Screw-Coil: M5-0.8 x 1.5D, M6-1.0 x 1.5D, M8-1.25 x 1.5D, M10-1.5 x 1.5D, M12-1.75 x 1.5D.

Drill size: 5.2, 6.3, 8.3, 10.5, 12.5 mm

26 700 6120 | BS02961 



ALTRI ATTREZZI - TOOLS

COD. RMS RMS CODE	BARCODE	CODICE BIKESERVICE BIKESERVICE CODE	DESCRIZIONE	DESCRIPTION
26 700 6520 NEW		BS2302	Attrezzo rimozione tappi ispezione motore	Timing and inspection plug tool
26 700 6530 NEW		BS9947	Attrezzo montaggio valvole	Fitting valves tool
26 700 6540 NEW		BS8008	Attrezzo stallonamento pneumatici	Tire change extruders tool
26 700 6550 NEW		BS5610	Fermo per montaggio pneumatici	Tire bead holding tool
26 700 6560 NEW		BS80017	Chiave 3/8 snodata a T	3/8 Jointed T handle wrench
26 700 6570 NEW		BS80018	Chiave 1/4 snodata a T	1/4 Jointed T handle wrench
26 700 6580		BS2461	Estrattore volano femmina m24x1,5	Magneto flywheel puller m24x1,5
26 700 6590		BS2462	Estrattore volano femmina m26x1,0	Magneto flywheel puller m26x1,0
26 700 6600		BS2463	Estrattore volano femmina m30x1,5	Magneto flywheel puller m30x1,5
26 700 6610		BS2464	Estrattore volano femmina m30x1,0	Magneto flywheel puller m30x1,0
26 700 6620		BS2465	Estrattore volano femmina m30x1,5 I 50	Magneto flywheel puller m30x1,5 I 50
26 700 6630		BS2467	Estrattore volano femmina m33x1,5	Magneto flywheel puller m33x1,5
26 700 6640		BS2469	Estrattore volano femmina m35x1,5	Magneto flywheel puller m35x1,5
26 700 6650		BS2483	Estrattore volano femmina m24x1,0	Magneto flywheel puller m24x1,0
26 700 6660		BS2484	Estrattore volano femmina m28x1,0	Magneto flywheel puller m28x1,0
26 700 6670		BS2485	Estrattore volano femmina M30x1,25	Magneto flywheel puller M30x1,25
26 700 6680		BS2486	Estrattore volano femmina M32x1,5	Magneto flywheel puller M32x1,5
26 700 6700		BS2488	Estrattore volano femmina M38x1,5	Magneto flywheel puller M38x1,5
26 700 6710		BS2489	Estrattore volano femmina M42x1,5	Magneto flywheel puller M42x1,5
26 700 6280		BS1661	Chiave Esagonale a T L. 300 - 6 mm	T-Handle Socket T.L. 300 - 6 mm
26 700 6290		BS1662	Chiave Esagonale a T L. 300 - 8 mm	T-Handle Socket T.L. 300 - 8 mm
26 700 6300		BS1663	Chiave Esagonale a T L. 300 - 10 mm	T-Handle Socket T.L. 300 - 10 mm
26 700 6310		BS1664	Chiave Esagonale a T L. 300 - 12 mm	T-Handle Socket T.L. 300 - 12 mm
26 700 6320		BS1665	Chiave Esagonale a T L. 300 - 13 mm	T-Handle Socket T.L. 300 - 13 mm
26 700 6330		BS1666	Chiave Esagonale a T L. 300 - 14 mm	T-Handle Socket T.L. 300 - 14 mm
26 700 6340		BS1667	Chiave Esagonale a T L. 300 - 17 mm	T-Handle Socket T.L. 300 - 17 mm
26 700 6350		BS1668	Chiave Esagonale a T L. 300 - 19 mm	T-Handle Socket T.L. 300 - 19 mm
26 700 6360		BS6012A	Chiave Combinata 6 mm	Multi Driver Wrench 6 mm
26 700 6370		BS6012B	Chiave Combinata 8 mm	Multi Driver Wrench 8 mm
26 700 6380		BS6012C	Chiave Combinata 10 mm	Multi Driver Wrench 10 mm

ALTRI ATTREZZI - TOOLS

26 700 6390		BS6012D	Chiave Combinata 12 mm	<i>Multi Driver Wrench 12 mm</i>
26 700 6400		BS6012E	Chiave Combinata 13 mm	<i>Multi Driver Wrench 13 mm</i>
26 700 6410		BS6012F	Chiave Combinata 14 mm	<i>Multi Driver Wrench 14 mm</i>
26 700 6420		BS6012G	Chiave Combinata 17 mm	<i>Multi Driver Wrench 17 mm</i>
26 700 6430		BS6012H	Chiave Combinata 19 mm	<i>Multi Driver Wrench 19 mm</i>
26 700 6510		BS7407H	Chiave Combinata a Cricchetto 6 mm	<i>Ratchet Wrench 6 mm</i>
26 700 6440		BS7407A	Chiave Combinata a Cricchetto 8 mm	<i>Ratchet Wrench 8 mm</i>
26 700 6450		BS7407B	Chiave Combinata a Cricchetto 10 mm	<i>Ratchet Wrench 10 mm</i>
26 700 6460		BS7407C	Chiave Combinata a Cricchetto 12 mm	<i>Ratchet Wrench 12 mm</i>
26 700 6470		BS7407D	Chiave Combinata a Cricchetto 13 mm	<i>Ratchet Wrench 13 mm</i>
26 700 6480		BS7407E	Chiave Combinata a Cricchetto 14 mm	<i>Ratchet Wrench 14 mm</i>
26 700 6490		BS7407F	Chiave Combinata a Cricchetto 17 mm	<i>Ratchet Wrench 17 mm</i>
26 700 6500		BS7407G	Chiave Combinata a Cricchetto 19 mm	<i>Ratchet Wrench 19 mm</i>



26 700 0070 

ESTRATTORE VOLANO - FLYWHEEL PULLER
 Bosch-Ducati-Motoplat
 Scooter 50 Malaguti-Aprilia
 (con volani Ducati) - Ø 22x1,5 (dx)



26 700 0100 

ESTRATTORE VOLANO - FLYWHEEL PULLER
 Kimco People-Vivio 125/150 - Movie 125
 Honda-Mbk-Yamaha Minarelli - Suzuki
 Kawasaki-Peugeot-Malaguti-Aprilia-Beta
 Ø 27x1 (sx)

26 700 0080 

ESTRATTORE VOLANO - FLYWHEEL PULLER
 Kimco Dink 50-Honda-Peugeot
 Ø 24x1 (dx)

26 700 0120 

ESTRATTORE VOLANO - FLYWHEEL PULLER
 Vespa - Pk - Et3 - Px - Ape 50 - Gilera Rv -Rx
 Motoplat
 Ø 28x1 (dx)

26 700 0090 

ESTRATTORE VOLANO - FLYWHEEL PULLER
 Piaggio scooter 50 tutti i modelli - *All models*
 Ø 26x1 (dx)

26 700 0150 

ESTRATTORE SMONTAGGIO FRIZIONE
CLUTCH PULLER
 Vespa 50 - 90 - 125 Et3
 (filetto interno - *Internal thread*)



26 700 0160 

ATTREZZO SMONTAGGIO GHIERA FRIZIONE
CLUTCH NUT REMOVAL TOOL
 Vespa Pe - Px



26 700 0140 

ATTREZZO SPINGIDISCO FRIZIONE
CLUTCH PRESSURE PLATE TOOL
 Vespa 50 - 90 - 125 Et3



26 700 0010 

ATTREZZO TENDICAVO FRENO FRIZIONE
BRAKE AND CLUTCH CABLE TENSIONER TOOL



26 700 0030 

LEVA GOMME CICLOMOTORE - 1 pz.
MOPED TIRES LEVER - 1 pc



26 700 0193 

SET CHIAVI - KEYS SET
 Vespa 50



26 700 9123 

SUPPORTO MOTORE
ENGINE SUPPORT
 Vespa Px • LML

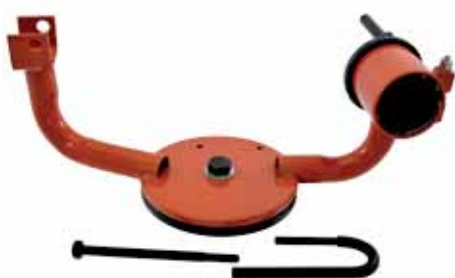



ESTRATTORI VOLANO - CHIAVI CANDELA
FLYWHEEL PULLERS - SPARK PLUG WRENCH

26 700 0180 

CHIAVE CANDELA - SPARK PLUGS WRENCH
 Chiave candela ciclomotore
 Esagonale - *Hexagonal* 13x21



26 700 0190 

CHIAVE CANDELA - SPARK PLUGS WRENCH
 Chiave candela per ciclomotore
 Standard



26 700 0240 

CHIAVE CANDELA A TUBO CON SPINA
SPARK PLUG WRENCH WITH PIN
 Esagonale - *Hexagonal* Ø 16x100



26 700 0250 

Esagonale - *Hexagonal* Ø 16x140

26 700 0260 

Esagonale - *Hexagonal* Ø 18x100

26 700 0270 

Esagonale - *Hexagonal* Ø 21x120

26 700 0200 

CHIAVE CANDELA - SPARK PLUGS WRENCH
 Chiave candela vespa 125 Et3
 Esagonale - *Hexagonal* 13x13x21



26 700 0220 

CHIAVE CANDELA - SPARK PLUGS WRENCH
 Vespa Px 125 - Px 150
 125 - 150 Sprint
 Esagonale - *Hexagonal* 13x11x21 / 22



26 700 0230 

CHIAVE CANDELA SNODATA PER MOTO
ARTICULATED SPARK PLUG WRENCH
 Esagonale - *Hexagonal* Ø 21 - lungh. 230
 mm.



26 700 0210 

CHIAVE CANDELA - SPARK PLUGS WRENCH
 Vespa 50 - 90
 Esagonale - *Hexagonal* 11x13x21

26 700 0170 

CHIAVE SEBATOIO - TOOL TANK
 Vari tipi di Vespa - *Various Vespa Models*

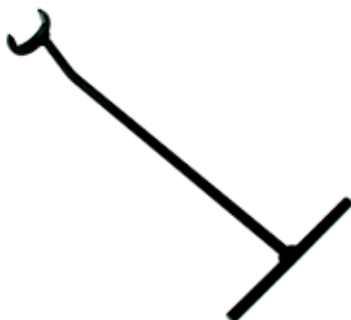

26 700 0173 

CHIAVE SERBATOIO - TANK TOOL
 Vespa Gs 160



26 700 0183 

CHIAVE SERBATOIO - TANK TOOL
 Vespa 50

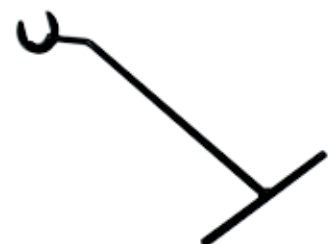

The background of the entire page is a repeating pattern of various icons related to motorcycles and vehicle maintenance. The icons include motorcycles, gears, wrenches, screwdrivers, batteries, pistons, and other mechanical parts, all rendered in a light gray color.

RMS

YOUR BEST PARTNER



CONDIZIONI GENERALI DI VENDITA

Gli ordini sono assunti "salvo approvazione della casa" e tale approvazione viene anche manifestata con la sola evasione degli stessi. Con il conferimento degli ordini si intendono accettate dal committente, senza riserve, le condizioni generali di seguito riportate.

- 1) I prodotti inclusi nei cataloghi sono di normale vendita. Agli stessi potranno essere apportate modifiche e varianti al fine di migliorare la funzionalità. Le illustrazioni e le caratteristiche tecniche rappresentate nei cataloghi pertanto non sono vincolanti. Tutti i Riferimenti Originali sono di proprietà esclusiva delle case produttrici.
- 2) I prezzi esposti nei listini non sono impegnativi, in quanto potranno essere aggiornati in qualunque momento, per intervenute variazioni dei relativi costi.
- 3) Gli ordini verranno evasi secondo la disponibilità del momento senza garanzie di saldo. Eventuali rimanenze saranno inviate appena disponibili, salvo che vengano annullate dal committente al ricevimento della prima spedizione.
- 4) La merce viaggia a rischio e pericolo del committente anche se venduta Franco Fabbrica.
- 5) Il pagamento della fornitura deve essere effettuato esclusivamente presso la sede del venditore, con le modalità ed entro i termini stabiliti al perfezionamento del contratto di vendita. L'eventuale emissione di tratte o di ricevute bancarie non comporta deroga del luogo di pagamento. In caso di ritardato pagamento di una o più forniture decorreranno a carico del compratore gli interessi secondo il tasso praticato dalle banche sugli scoperti di conto corrente. Il mancato o ritardato pagamento di una fornitura ci autorizza a ritenerci liberi da qualsiasi impegno e a ritenere annullati tutti i contratti di vendita in corso. Non sono accettati pagamenti con rimesse dirette. Per i nuovi clienti il pagamento dei primi ordini dovrà avvenire esclusivamente con bonifico bancario anticipato o in contrassegno.
- 6) Resi per errata ordinazione od errata spedizione saranno accettati solo se giustificati ed effettuati entro 15 (quindici) giorni dalla consegna della merce, comunque, preventivamente autorizzati da **RMS s.p.a.** inviando una mail a **logistica@rms.it**. Resi non precedentemente autorizzati dalla nostra Società o non accompagnati da documento di trasporto che deve recare gli estremi del nostro DDT o della ns. fattura di vendita non saranno accettati e di conseguenza saranno rinviati al mittente. I resi che NON rientrano nei termini qui sopra indicati (cioè oltre i 15 giorni dal ricevimento della merce) dovranno comunque essere autorizzati da **RMS s.p.a.** contattando **logistica@rms.it**.
- 7) Tutti i prodotti sono garantiti da regolare costruzione e funzionalità. L'eventuale restituzione di prodotti ritenuti difettosi dovrà essere preventivamente concordata con il venditore ed inviata in Porto Franco alla **RMS s.p.a.** I difetti lamentati dovranno essere specificati nella "bolla di accompagnamento" a fianco dei singoli prodotti resi e saranno presi in esame esclusivamente se la bolla recherà anche i riferimenti delle forniture (numero e data delle fatture del venditore). Qualora venga accettata la validità del reclamo la garanzia del venditore non andrà oltre l'accredito o la sostituzione dei prodotti stessi. I prodotti che invece risultassero non funzionanti per cause non imputabili alla loro qualità, bensì a seguito di manomissioni, rotture, errato montaggio, eccetera, saranno rispediti in porto assegnato al committente.
- 8) Al momento dell'ordinazione deve essere sempre precisato il codice articolo completo. Questo permetterà una evasione del Vs. ordine in modo corretto. Se al posto del nostro codice articolo vi fosse una semplice descrizione, la **RMS s.p.a.** non si assume alcuna responsabilità per eventuali errori.
- 9) Per qualsiasi controversia relativa alla interpretazione o esecuzione delle suddette condizioni, viene accettata dalle parti la competenza esclusiva del foro di Milano.

RMS s.p.a.

A norma delle leggi sul diritto d'autore e del codice civile. E' tassativamente vietata la riproduzione di questo catalogo/listino o di parte di esso, con qualsiasi metodo elettronico, meccanico, per mezzo di fotocopie, microfilms, registrazioni o altro. I diritti sono riservati per tutti i paesi.

Disegni e dati (descrizioni, caratteristiche, codifiche, prezzi ecc.) riportati su cataloghi e listini, possono essere soggetti a modifiche e variazioni. La **RMS s.p.a.** si riserva la facoltà di effettuare cambiamenti anche senza preavviso.

Tutti i riferimenti originali sono di proprietà esclusiva delle case produttrici.



GENERAL SALES CONDITIONS

The orders we receive are accepted "unless the company does not accept them" and the acceptance is declared just with the preparation of the material. By sending the order, the customer automatically accepts the following general conditions:

- 1) The products included in the catalogue are products sold normally by our company. To these products there can be the possibility of the application of changes and modifications in order to improve their usage. The photos, drawings and technical characteristics described in this catalogue are not at all binding.
- 2) The prices in the price list are to be considered not binding. They can be updated in every moment due to changes in the purchase prices.
- 3) The orders will be prepared according to the availability of the precise moment without any ensuring of the balance. The backorders will be sent to the customer with the following order unless they are deleted by the customer itself.
- 4) The material is shipped at risk of the customer as we are selling it ExWorks.
- 5) The payment should be done to the seller with conditions and terms previously decided. In case of any delayed payment there will be the extra charge of bank interests on the open amounts of debts on the bank account. The missed or delayed payment of just one invoice authorizes RMS s.p.a. to cancel all the selling contracts and commitments. For new customers we will accept only payment as advanced payment on proforma.
- 6) Warranty items will be accepted only when described and declared within 15 days from the delivery of the material, and they have anyway to be accepted and confirmed by **RMS s.p.a.** by sending a mail to **logistica@rms.it** or by filling in the form on our website. Warranty items sent to us without delivery note and descriptions of the problems, and without references to the invoice number and date, will be rejected and sent back to the customer. The warranty items which are not included into the already mentioned terms should anyway be authorized by **RMS s.p.a.** by contacting **logistica@rms.it**
- 7) All the products are guaranteed with correct quality and construction. The warranty items which has been authorized by **RMS s.p.a.** has to be sent free of charge to our storage. The defects and problems of the items should be mentioned on the delivery note traveling with the material sent back and they will be checked only if in the delivery note is mentioned also the date of invoice and number of the invoice. In case the warranty items will be accepted we will credit the value or substitute the items. All the products for which the damage is due to incorrect installation, breaking of parts after selling and tampering will be sent back to the customer at its costs.
- 8) While ordering there should be mentioned always the correct item code. This will allow us to prepare the order in a proper way. If there will just be a description of the item, **RMS s.p.a.** will not be responsible for any mistake.
- 9) For any dispute regarding interpretation and execution of the above mentioned conditions, the parties accept the exclusive competence of the court of Milan.

RMS s.p.a.

As for the copyright laws and the civil code laws, it's forbidden the reproduction of this catalogue/price list or any extract of the same with any electronical,mechanical means. No photocopies are allowed and also any microchips, recording or else. The rights are reserved for all the countries in which we sell.

Drawing, data (descriptions, characteristics, codes, price and so on) that are described on price lists and catalogues can be subject to changes and modifications. **RMS s.p.a.** has the right to change any of these conditions without any advanced notice.

All the original references are of exclusive property of the producers.

RMS SPA
Via Macallè 156 20831 Seregno (MB)
Tel. +39 0362 27301 Fax +39 0362 2730270
www.rms.it info@rms.it

