



PROFESSIONAL TOOLS

NO.1-2, Bade Ln., Minsheng Rd., Wufong Dist.,
Taichung City 41347, Taiwan (R.O.C)

www.selta.com.tw
Made in Taiwan

**GENERAL
CATALOGUE 2020**



SELTA
PROFESSIONAL TOOLS

www.selta.com.tw



Made in
TAIWAN

**Create The Most Professional
Quality With Heart...**

 **SELTA**
PROFESSIONAL TOOLS

Certificate of Registration

This is to certify that the
QUALITY MANAGEMENT SYSTEM

of

RIO TOOLS CO., LTD.

No. 32, Lane 496, Kuanghsin Rd., Taiping Dist., Taichung City, TAIWAN, R.O.C.

for

Design, Manufacture and Sales of Hand Tools

has been assessed and registered against the provisions of

ISO 9001:2015

International Standard with

Registration Number: 17QMB30036
Registration Date: 15 Aug., 2017
Issue Date: 04 Aug., 2020
Expiration Date: 14 Aug., 2023
Cycle Start Date: 15 Aug., 2020
Certification Approved:



UNIVERSAL CERTIFICATION SERVICE CO., LTD.

Management System
Certification
MS008

1. This certificate is the property of Universal Certification Service Co., Ltd., 4F-1, No. 21, Sec. 4, Nanjing E. Rd., Songshan District, Taipei City, Taiwan, R.O.C.
2. The Registration Information and authenticity of this certificate can be confirmed at www.ucscert.com.tw
3. Registration is subject to the management system being continually maintained to the above standard under regular surveillance audit. Should surveillance audit not take place when required, registration shall be removed.

SELTA is a Taiwan-based brand specialized in hand tools and auto repair tools and auto accessories

Factory located in Taiwan, with more than 40 years experiences, we offer customers quality products with continuous innovation and development by our skillful R & D and Application team.

By launching a distribution center in Dubai, one of the biggest transit centers, we deliver our goods worldwide with fast delivery.

SELTA, a reliable brand you can always trust.



Metallic Lock



SELTA

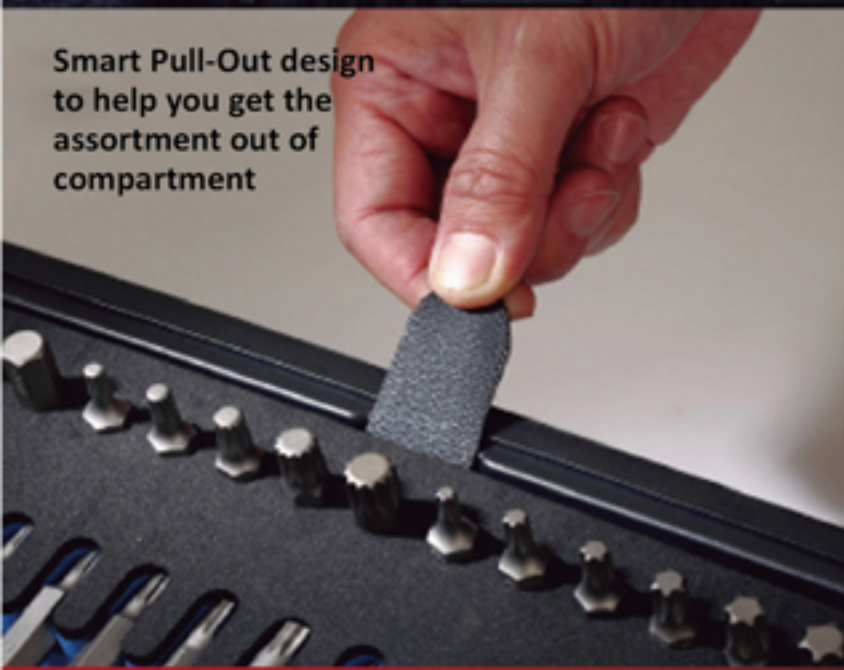

Smart Pull-Out design
to help you get the
assortment out of
compartment



Thoughtful groove design to secure
the overlapping compartments tightly

Revolutionary Products

Clever Case L





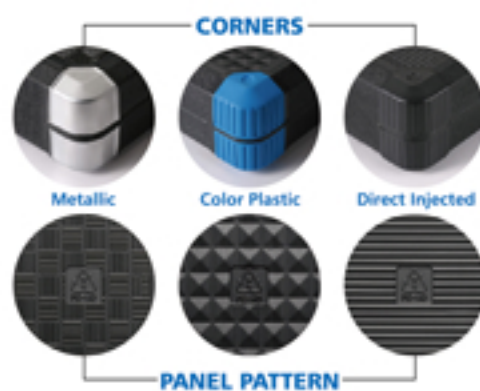







Clever Case S











Clever Hidden Compartment Suitable For Storage Of (e.g.) Screws, Bolts, Papers, Tapes And File ,ETC...



Clever Concept & Beyond

	Trolleys	008
	Tool Box & Tool Set	022
	Socket Series	054
	Impact Wrench	106
	Bit Set & Bits	130
	Hex key	150
	Wrench	166
	Torque Wrench	182
	Screwdriver	192
	Hammer & Chisel	202

	Engine Series	208
	Body Series	232
	Undercar Series	242
	Battery & Electrical	260
	Pliers & Scissors	266
	General Tools	292
	Garden & Construction	310
	Hydraulic Series	318
	Gifts & Accessories	322



 **SELTA**
PROFESSIONAL TOOLS



TROLLEYS

A red SELTA trolley is the central focus, filled with various tools like screwdrivers and wrenches. The background shows a workshop with other toolboxes and equipment.

 **SELTA**

7 Drawers Trolley
359 Pcs Tool Trolley Set

71613S
13 Pcs Star Screwdriver Set (Tray)

7014
14 Pcs Screwdriver Set (Tray)

2565
64 Pcs 1/4" Dr. Socket Combination Set (Tray)

81516
16 Pcs Combination Wrench Set (Tray)

83508
8 Pcs 75 Degree Offset Ring Set (Tray)

82511
11 Pcs Double Open End Wrench Set (Tray)

30712
7 Pcs 3/8" Dr. Ratchet Handle Set (Tray)

3531
31 Pcs 3/8" Dr. Socket Combination Set (Tray)

3533
33 Pcs 3/8" Dr. Flank & Star Socket Set (Tray)

3538
38 Pcs Star & Spline Set (Tray)

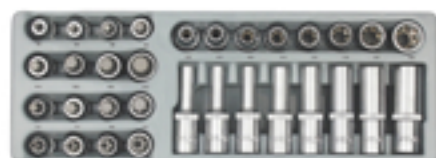
40612
6 Pcs 1/2" Dr. Accessory Set (Tray)

4532
32 Pcs 1/2" Dr. Star & Spline Set (Tray)

4248
24 Pcs Socket Set (Tray)

4520
20 Pcs Socket Set (Tray)

1046
4 Pcs Pliers Set (Tray)



5038

3 Pcs Pliers Set (Tray)



5053

5 Pcs Hammer Chisel Set (Tray)



5131

13 Pcs Chisel & Punch Set (Tray)

BEST CHOICE



77409S

9 Pcs Hex Nut Driver T Handle Set (Tray)

BEST CHOICE



76510S

10 Pcs Hex Ball Point Grip Key Set (Tray)



10207

7 Drawers Trolley (Empty Trolley)



10207-359

7 Drawers Trolley With 359 Pcs Tools

- Finished: Red/ Mat
- 677mm x 459mm x 1000mm (The Height With Wheels)
- 1pc/68kg/72.1kg/13'
- 5 Drawer 569 x 398 x 75mm
- 2 Drawer 569 x 398 x 154mm

Tray Collocation:

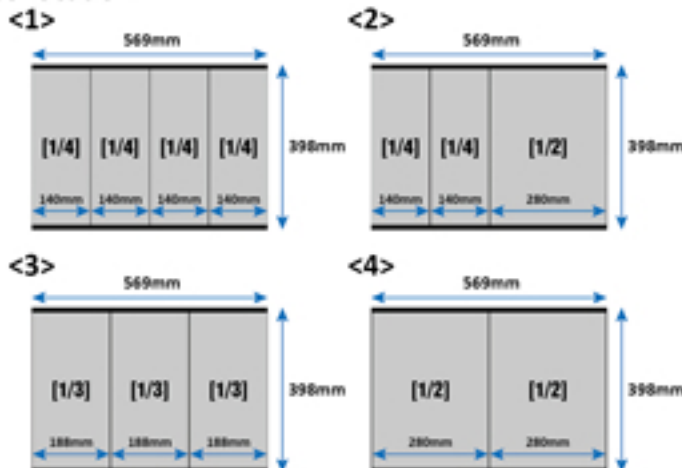

71613S
13 Pcs Star Screwdriver Set (Tray)

- 5 SETS/CTN



- 13pcs Star Screwdriver :
 T5 x 65mmL, T6 x 65mmL, T7 x 65mmL,
 T8 x 65mmL, T9 x 65mmL, T10 x 80mmL,
 T15 x 80mmL, T20 x 100mmL, T25 x 100mmL,
 T27 x 115mmL, T30 x 115mmL, T40 x 130mmL,
 T45 x 140mmL

7014
14 Pcs Screwdriver Set (Tray)

- 5 SETS/CTN



- 6pcs Slotted Screwdriver :
 3 x 75mmL, 3.5 x 100mmL, 4 x 100mmL
 5.5 x 125mmL, 6.5 x 150mmL, 8 x 175mmL
- 2pcs Slotted Stubby Screwdriver :
 5.5 x 25mmL, 6.5 x 25mmL
- 6pc Phillips Screwdriver :
 PH0 x 60mmL, PH1 x 80mmL,
 PH2 x 100mmL, PH3 x 150mmL
- 2pcs Phillips Stubby Screwdriver :
 PH1 x 25mmL, PH2 x 25mmL

2565
64 Pcs 1/4" Dr. Socket Combination Set (Tray)

- 5 SETS/CTN



- 13pcs 1/4" Dr. Socket 6pt: 4, 4.5, 5, 5.5, 6, 7, 8, 9, 10, 11, 12, 13, 14mm
- 9pcs 1/4" Dr. Deep Socket 6pt: 5, 6, 7, 8, 9, 10, 11, 12, 13mm
- 7pcs 1/4" Dr. Socket Bit(37mmL): H3, H4, H5, H6, H7, H8, H10
- 3pcs 1/4" Dr. Socket Bit(37mmL): PH1, PH2, PH3
- 3pcs 1/4" Dr. Socket Bit(37mmL): PZ1, PZ2, PZ3
- 3pcs 1/4" Dr. Socket Bit(37mmL): SL4, SL5.5, SL6.5
- 8pcs 1/4" Dr. Socket Bit(37mmL): T8, T10, T15, T20, T25, T27, T30, T40
- 1pc 1/4" Dr. Ratchet Handle 72T
- 3pcs 1/4" Dr. Extension Bar 2", 4", 6"
- 1pc 1/4" Dr. Sliding T Handle
- 1pc 1/4" Dr. Universal Joint
- 1pc 1/4" Dr. Spinner
- 1pc 1/4" x 1/4" Dr. Coupler
- 9pcs Hex Key With Ball Type: 1.5, 2, 2.5, 3, 4, 5, 6, 8, 10mm

81516
16 Pcs Combination Wrench Set (Tray)
 - 5 SETS/CTN

- Size: 6, 7, 8, 9, 10, 11, 12, 13, 14, 15, 16, 17, 18, 19, 22, 24mm

83508
8 Pcs 75 Degree Offset Ring Wrench Set (Tray)
 - 5 SETS/CTN

- Size: 6 x 7, 8 x 9, 10 x 11, 12 x 13, 14 x 15, 16 x 17, 18 x 19, 21 x 23mm

82511
11 Pcs Double Open End Wrench Set (Tray)
 - 5 SETS/CTN



- Size: 6 x 7, 8 x 9, 10 x 11, 12 x 13, 14 x 15, 16 x 17, 18 x 19, 20 x 22, 21 x 23, 24 x 27, 30 x 32mm

30712
7 Pcs 3/8" Dr. Ratchet Handle Set (Tray)
 - 5 SETS/CTN

 - 1pc 3/8" Dr. Torque Wrench 20~110Nm
 - 1pc 3/8" Dr. Flexible Ratchet Handle 72T
 - 1pc 3/8" Dr. Ratchet Handle 72T
 - 1pc 3/8" Dr. Stubby Ratchet Handle 72T
 - 3pcs 3/8" Dr. Spark Plug Sokcet: 16, 18, 21mm

3531
31 Pcs 3/8" Dr. Socket Combination Set (Tray)
 - 5 SETS/CTN

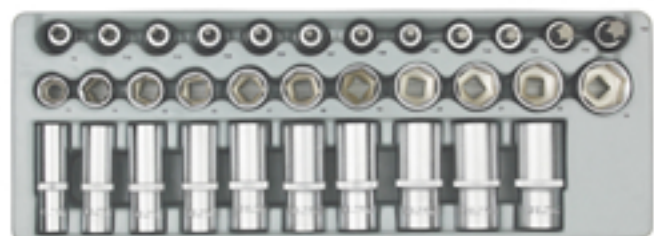
 - 7pcs 3/8" Dr. Socket 6pt: 6, 7, 8, 9, 10, 11, 12mm
 - 7pcs 3/8" Dr. Deep Socket 6pt: 6, 7, 8, 9, 10, 11, 12mm
 - 10pcs 3/8" Dr. Hex Socket Bit(48mmL):
 H3, H4, H5, H5.5, H6, H7, H8, H9, H10, H12
 - 1pc 3/8" Dr. Swivel Handle 215mmL
 - 4pcs 3/8" Dr. Extension Bar: 2" & 3" & 6" & 10"
 - 1pc 3/8" Dr. Universal Joint
 - 1pc 3-Way Adaptor 1/2"(F) x 3/8"(M)

3533
33 Pcs 3/8" Dr. Flank & Star Socket Set (Tray)
 - 5 SETS/CTN

 - 11pcs 3/8" Dr. Socket 6pt:
 13, 14, 15, 16, 17, 18, 19, 20, 21, 22, 24mm
 - 10pcs 3/8" Dr. Deep Socket 6pt:
 13, 14, 15, 16, 17, 18, 19, 20, 21, 22mm
 - 12pcs 3/8" Dr. Star Socket Bit(50mmL):
 T8, T10, T15, T20, T25, T27, T30, T40, T45, T50, T55, T60

3538
38 Pcs Star & Spline Set (Tray)

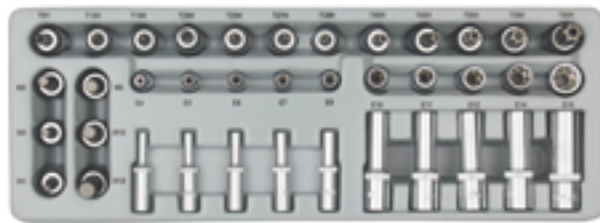
- 5 SETS/CTN



- 10pcs Star Socket :
 - 1/4" Dr. Star Socket: E4, E5, E6, E7, E8
 - 3/8" Dr. Star Socket: E10, E11, E12, E14, E16
- 5pcs 1/4" Dr. Star Deep Socket (50mml):E4, E5, E6, E7, E8
- 5pcs 3/8" Dr. Star Deep Socket (63mml):E10, E11, E12, E14, E16
- 12pcs 3/8" Dr. Star Tamperproof Socket Bit(48mml):
 - TP8, TP10, TP15, TP20, TP25, TP27, TP30, TP40,
 - TP45, TP50, TP55, TP60
- 6pcs 3/8" Dr. Spline Socket Bit(48mml):
 - M5, M6, M8, M9, M10, M12

40612
6 Pcs 1/2" Dr. Accessory Set (Tray)

- 5 SETS/CTN



- 1pc 1/2" Dr. Ratchet Handle 72T
- 2pcs 1/2" Dr. Extension Bar 5" & 10"
- 1pc 1/2" Dr. Sliding T Handle
- 1pc 1/2" Dr. Universal Joint
- 1pc 1/2" Dr. Swivel Handle 15"

4532
32 Pcs 1/2" Dr. Star & Spline Set (Tray)

- 5 SETS/CTN

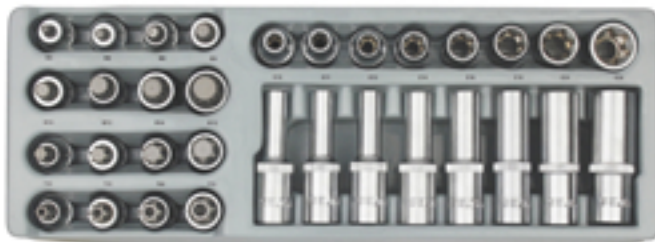

- 8pcs 1/2" Dr. E Socket:
 - E10, E11, E12, E14, E16, E18, E20, E24
- 8pcs 1/2" Dr. E Deep Socket:
 - E10, E11, E12, E14, E16, E18, E20, E24
- 4pcs 1/2" Dr. Star Socket Bit(55mml): T50, T55, T60, T70
- 4pcs 1/2" Dr. Tamper Proof Socket Bit(55mml):
 - TP50, TP55, TP60, TP70
- 8pcs 1/2" Dr. Spline Socket Bit(55mml):
 - M5, M6, M8, M9, M10, M12, M14, M16

4248
24 Pcs Socket Set (Tray)

- 5 SETS/CTN



- 12pcs 1/2" Dr. Socket 6pt:
 - 8, 9, 10, 11, 12, 13, 14, 15, 16, 17, 18, 19mm
- 12pcs 1/2" Dr. Deep Socket 6pt:
 - 8, 9, 10, 11, 12, 13, 14, 15, 16, 17, 18, 19mm

4520
20 Pcs Socket Set (Tray)

- 5 SETS/CTN

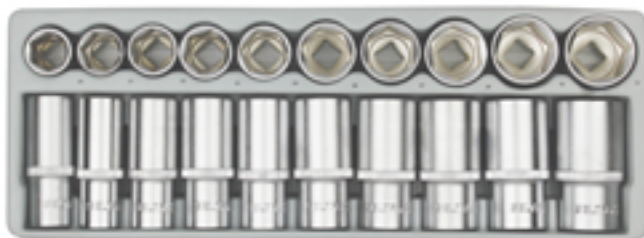

- 10pcs 1/2" Dr. Socket 6pt:
 - 20, 21, 22, 23, 24, 26, 27, 28, 30, 32mm
- 10pcs 1/2" Dr. Deep Socket 6pt:
 - 20, 21, 22, 23, 24, 26, 27, 28, 30, 32mm

1046
4 Pcs Pliers Set (Tray)

- 5 SETS/CTN



- 1pc Combination Pliers 7"
- 1pc Diagonal Pliers 7"
- 1pc Long Nose Pliers 8"
- 1pc Bent Long Nose Pliers 8"

5038
3 Pcs Pliers Set (Tray)
 - 5 SETS/CTN

- 1pc Adjustable Wrench 10"
- 1pc Waterpump Pliers 10"
- 1pc Locking Pliers 10"

5053
5 Pcs Hammer Chisel Set (Tray)
 - 5 SETS/CTN

- 1pc Engineer Hammer 300g
- 1pc Rubber Hammer 520g (280mmL)
- 3pcs Chisel:
 15mm(W) x 14mm(Dia) x 180mmL,
 19mm(W) x 16mm(Dia) x 180mmL,
 25mm(W) x 16mm(Dia) x 220mmL

5131
13 Pcs Chisel & Punch Set (Tray)
 - 5 SETS/CTN



- 5pcs Chisel:
 10mm(W) x 10mm(Dia) x 150mmL,
 12mm(W) x 10mm(Dia) x 150mmL,
 15mm(W) x 14mm(Dia) x 180mmL,
 19mm(W) x 18mm(Dia) x 200mmL,
 22mm(W) x 18mm(Dia) x 200mmL
- 3pcs Pin Punch:
 2mm(Tip) x 10mm(Dia) x 140mmL,
 3mm(Tip) x 10mm(Dia) x 150mmL,
 4mm(Tip) x 10mm(Dia) x 190mmL
- 3pcs Taper Punch:
 2mm(Tip) x 10mm(Dia) x 185mmL,
 3mm(Tip) x 10mm(Dia) x 185mmL,
 4mm(Tip) x 10mm(Dia) x 185mmL
- 1pc Center Punch: 4 x 185mmL
- 1pc Cape Chisle:
 5mm(Tip) x 10mm(Dia) x 150mmL
- Material: CR-MO With Black Finished

77409S
9 Pcs Hex Nut Driver T Handle
 - 5 SETS/CTN

BEST CHOICE

- 9pcs Hex Nut Driver T Handle (300mmL):
 5, 6, 7, 8, 9, 10, 11, 12, 13mm

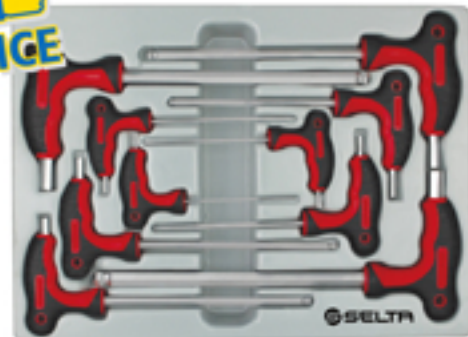
76510S
10 Pcs Hex Ball Point Grip Key
 - 5 SETS/CTN

BEST CHOICE

- 10pcs Hex Ball Point Grip Key:
 2 x 90mmL, 2.5 x 100mmL, 3 x 115mmL,
 4 x 120mmL, 5 x 140mmL, 6 x 160mmL,
 7 x 170mmL, 8 x 175mmL, 10 x 175mmL, 12 x 225mmL

1046E
4 Pcs Pliers Set (EVA)

- 5 SETS/CTN



- 1pc Combination Pliers 7"
- 1pc Diagonal Cutting Pliers 7"
- 1pc Bent Long Nose Pliers 8"
- 1pc Long Nose Pliers 8"

5132E
4 Pcs Circlip Pliers Set (EVA)

- 5 SETS/CTN



- 1pc External Straight Circlip Pliers 180mmL
- 1pc Internal Bent Circlip Pliers 180mmL
- 1pc External Bent Circlip Pliers 180mmL
- 1pc Internal Straight Circlip Pliers 180mmL

5038E
3 Pcs Pliers Set (EVA)

- 5 SETS/CTN



- 1pc Adjustable Wrench 10"
- 1pc Waterpump Pliers 10"
- 1pc Locking Pliers 10"

3531E
31 Pcs 3/8" Dr. Socket Combination Set (EVA)

- 5 SETS/CTN



- 7pcs 3/8" Dr. Socket 6pt: 6, 7, 8, 9, 10, 11, 12mm
- 7pcs 3/8" Dr. Deep Socket 6pt: 6, 7, 8, 9, 10, 11, 12mm
- 10pcs 3/8" Dr. Hex Socket Bit(48mmL):
H3, H4, H5, H5.5, H6, H7, H8, H9, H10, H12
- 1pc 3/8" Dr. Swivel Handle 215mmL
- 4pcs 3/8" Dr. Extension Bar: 2" & 3" & 6" & 10"
- 1pc 3/8" Dr. Universal Joint
- 1pc 3-Way Adaptor 1/2"(F) x 3/8"(M)

4520E
20 Pcs Socket Set (EVA)

- 5 SETS/CTN



- 10pcs 1/2" Dr. Socket 6pt:
20, 21, 22, 23, 24, 26, 27, 28, 30, 32mm
- 10pcs 1/2" Dr. Deep Socket 6pt:
20, 21, 22, 23, 24, 26, 27, 28, 30, 32mm

3533E
33 Pcs 3/8" Dr. Flank & Star Socket Set (EVA)

- 5 SETS/CTN

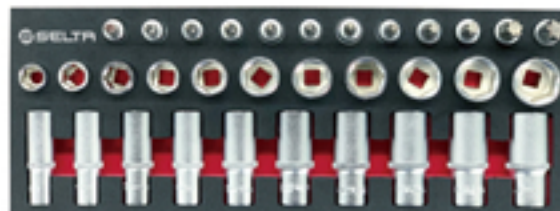

- 11pcs 3/8" Dr. Socket 6pt:
13, 14, 15, 16, 17, 18, 19, 20, 21, 22, 24mm
- 10pcs 3/8" Dr. Deep Socket 6pt:
13, 14, 15, 16, 17, 18, 19, 20, 21, 22mm
- 12pcs 3/8" Dr. Star Socket Bit(50mmL):
T8, T10, T15, T20, T25, T27, T30, T40, T45, T50, T55, T60

3538E
38 Pcs Star & Spline Set (EVA)
 - 5 SETS/CTN

- 10pcs Star Socket :
 - 1/4" Dr. Star Socket: E4, E5, E6, E7, E8
 - 3/8" Dr. Star Socket: E10, E11, E12, E14, E16
- 5pcs 1/4" Dr. Star Deep Socket (50mmL):E4, E5, E6, E7, E8
- 5pcs 3/8" Dr. Star Deep Socket (63mmL):E10, E11, E12, E14, E16
- 12pcs 3/8" Dr. Star Tamperproof Socket Bit(48mmL):
 - TP8, TP10, TP15, TP20, TP25, TP27, TP30, TP40, TP45, TP50, TP55, TP60
- 6pcs 3/8" Dr. Spline Socket Bit(48mmL):
 - M5, M6, M8, M9, M10, M12

4532E
32 Pcs 1/2" Dr. Star & Spline Set (EVA)
 - 5 SETS/CTN

- 8pcs 1/2" Dr. E Socket:
 - E10, E11, E12, E14, E16, E18, E20, E24
- 8pcs 1/2" Dr. E Deep Socket:
 - E10, E11, E12, E14, E16, E18, E20, E24
- 4pcs 1/2" Dr. Star Socket Bit(55mmL): T50, T55, T60, T70
- 4pcs 1/2" Dr. Tamper Proof Socket Bit(55mmL):
 - TP50, TP55, TP60, TP70
- 8pcs 1/2" Dr. Spline Socket Bit(55mmL):
 - M5, M6, M8, M9, M10, M12, M14, M16

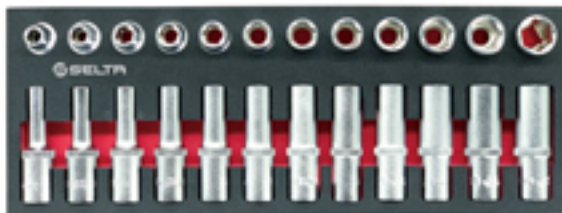
4248E
24 Pcs Socket Set (EVA)
 - 5 SETS/CTN

- 12pcs 1/2" Dr. Socket 6pt:
 - 8, 9, 10, 11, 12, 13, 14, 15, 16, 17, 18, 19mm
- 12pcs 1/2" Dr. Deep Socket 6pt:
 - 8, 9, 10, 11, 12, 13, 14, 15, 16, 17, 18, 19mm

81516E
16 Pcs Combination Wrench Set (EVA)
 - 5 SETS/CTN

- Size: 6, 7, 8, 9, 10, 11, 12, 13, 14, 15, 16, 17, 18, 19, 22, 24mm

83508E
8 Pcs 75 Degree Offset Ring Wrench Set (EVA)
 - 5 SETS/CTN

- Size: 6 x 7, 8 x 9, 10 x 11, 12 x 13, 14 x 15, 16 x 17, 18 x 19, 21 x 23mm

82511E
11 Pcs Double Open End Wrench Set (EVA)
 - 5 SETS/CTN

- Size: 6 x 7, 8 x 9, 10 x 11, 12 x 13, 14 x 15, 16 x 17, 18 x 19, 20 x 22, 21 x 23, 24 x 27, 30 x 32mm

5053E
5 Pcs Hammer Chisel Set (EVA)

- 5 SETS/CTN



- 1pc Engineer Hammer 300g
- 1pc Rubber Hammer 520g (280mmL)
- 3pcs Chisel:
 - 15mm(W) x 14mm(Dia) x 180mmL,
 - 19mm(W) x 16mm(Dia) x 180mmL,
 - 25mm(W) x 16mm(Dia) x 220mmL

40612E
6 Pcs 1/2" Dr. Accessory Set (EVA)

- 5 SETS/CTN



- 1pc 1/2" Dr. Ratchet Handle 72T
- 2pcs 1/2" Dr. Extension Bar 5" & 10"
- 1pc 1/2" Dr. Sliding T Handle 10"
- 1pc 1/2" Dr. Universal Joint
- 1pc 1/2" Dr. Swivel Handle 15"

2565E
64 Pcs 1/4" Dr. Socket Combination Set (EVA)

- 5 SETS/CTN



- 13pcs 1/4" Dr. Socket 6pt: 4, 4.5, 5, 5.5, 6, 7, 8, 9, 10, 11, 12, 13, 14mm
- 9pcs 1/4" Dr. Deep Socket 6pt: 5, 6, 7, 8, 9, 10, 11, 12, 13mm
- 7pcs 1/4" Dr. Hex Socket Bit(37mmL): H3, H4, H5, H6, H7, H8, H10
- 3pcs 1/4" Dr. Phillips Socket Bit(37mmL): PH1, PH2, PH3
- 3pcs 1/4" Dr. Pozidriv Socket Bit(37mmL): PZ1, PZ2, PZ3
- 3pcs 1/4" Dr. Slotted Socket Bit(37mmL): SL4, SL5.5, SL6.5
- 8pcs 1/4" Dr. Torx Socket Bit(37mmL): T8, T10, T15, T20, T25, T27, T30, T40
- 1pc 1/4" Dr. Ratchet Handle 72T
- 3pcs 1/4" Dr. Extension Bar 2", 4", 6"
- 1pc 1/4" Dr. Sliding T Handle
- 1pc 1/4" Dr. Universal Joint
- 1pc 1/4" Dr. Spinner
- 1pc 1/4" x 1/4" Dr. Coupler
- 9pcs Hex Key With Ball Type 1.5, 2, 2.5, 3, 4, 5, 6, 8, 10mm

5131E
13 Pcs Chisel & Punch Set (EVA)

- 5 SETS/CTN



- 5pcs Chisel:
 - 10mm(W) x 10mm(Dia) x 150mmL,
 - 12mm(W) x 10mm(Dia) x 150mmL,
 - 15mm(W) x 14mm(Dia) x 180mmL,
 - 19mm(W) x 18mm(Dia) x 200mmL,
 - 22mm(W) x 18mm(Dia) x 200mmL
- 3pcs Pin Punch:
 - 2mm(Tip) x 10mm(Dia) x 140mmL,
 - 3mm(Tip) x 10mm(Dia) x 150mmL,
 - 4mm(Tip) x 10mm(Dia) x 190mmL
- 3pcs Taper Punch:
 - 2mm(Tip) x 10mm(Dia) x 185mmL,
 - 3mm(Tip) x 10mm(Dia) x 185mmL,
 - 4mm(Tip) x 10mm(Dia) x 185mmL
- 1pc Center Punch: 4 x 185mmL
- 1pc Cape Chisle:
 - 5mm(Tip) x 10mm(Dia) x 150mmL
- Material: CR-MO With Black Finished

30712E
7 Pcs 3/8" Dr. Ratchet Handle Set (EVA)
 - 5 SETS/CTN

- 1pc 3/8" Dr. Torque Wrench 20~110Nm
- 1pc 3/8" Dr. Flexible Ratchet Handle 72T
- 1pc 3/8" Dr. Ratchet Handle 72T
- 1pc 3/8" Dr. Stubby Ratchet Handle 72T
- 3pcs 3/8" Dr. Spark Plug Sokcet: 16, 18, 21mm

77409SE
9 Pcs Hex Nut Driver T Handle Set (EVA)
 - 5 SETS/CTN

- 9pcs Hex Nut Driver T Handle (300mmL):
5, 6, 7, 8, 9, 10, 11, 12, 13mm

76510SE
10 Pcs Hex Ball Point Grip Key Set (EVA)
 - 5 SETS/CTN

- 10pcs Hex Ball Point Grip Key:
2 x 90mmL, 2.5 x 100mmL, 3 x 115mmL,
4 x 120mmL, 5 x 140mmL, 6 x 160mmL,
7 x 170mmL, 8 x 175mmL, 10 x 175mmL, 12 x 225mmL

71613SE
13 Pcs Star Screwdriver Set (EVA)
 - 5 SETS/CTN

- 13pcs Star Screwdriver :
T5 x 65mmL, T6 x 65mmL, T7 x 65mmL,
T8 x 65mmL, T9 x 65mmL, T10 x 80mmL,
T15 x 80mmL, T20 x 100mmL, T25 x 100mmL,
T27 x 115mmL, T30 x 115mmL, T40 x 130mmL,
T45 x 140mmL

7014E
14 Pcs Screwdriver Set (EVA)

- 5 SETS/CTN



- 6pcs Slotted Screwdriver :
3 x 75mmL, 3.5 x 100mmL, 4 x 100mmL
5.5 x 125mmL, 6.5 x 150mmL, 8 x 175mmL
- 2pcs Slotted Stubby Screwdriver :
5.5 x 25mmL, 6.5 x 25mmL
- 4pc Phillips Screwdriver :
PH0 x 60mmL, PH1 x 80mmL,
PH2 x 100mmL, PH3 x 150mmL
- 2pcs Phillips Stubby Screwdriver :
PH1 x 25mmL, PH2 x 25mmL

94542E
42pcs 1/2" Dr. Impact Socket Set(EVA)

- 17pcs 1/2" Dr. Impact Socket : 10, 11, 12, 13, 14, 15, 16, 17, 18, 19, 21, 22, 23, 24, 27, 30, 32
- 14pcs 1/2" Dr. Deep Impact Socket : 10, 11, 12, 13, 14, 15, 16, 17, 18, 19, 21, 22, 23, 24
- 3pcs 1/2" Dr. Rim Protective Wheel Socket : 17, 19, 21
- 2pcs 1/2" Dr. Impact Extension Bar :125, 250mm
- 1pc 1/2" Dr. Impact Universal Joint
- 1pc 1/2" Traditional Torque Wrench 42-210Nm
- 1pc 1/2" Drive Impact Wrench
- 1pc 1/4" 8mm High Pressure Air Blower Gun
- 2pcs 1/4" Quick Coupler Connector

20107 / 20106 Roller Wagon(7 / 6 Drawer)

**7 Drawer
20107**



5" x 1-1/4" Casters

- Overall : 683mm(W) x 460mm(D) x 853mm(H)
- Overall With Casters : 683mm(W) x 460mm(D) x 980mm(H)
- 5 Drawers: 530mm(W) x 397mm(D) x 50mm(H)
- 2 Drawers: 530mm(W) x 397mm(D) x 130mm(H)

**6 Drawer
20106**

5" x 1-1/4" Casters

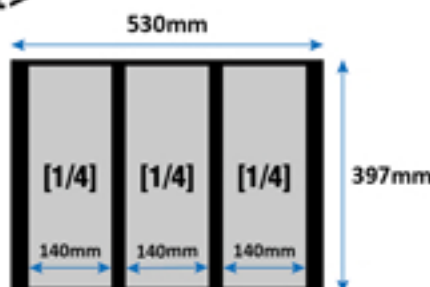
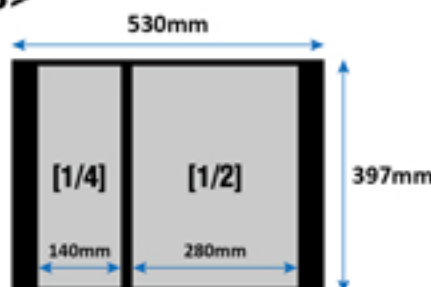
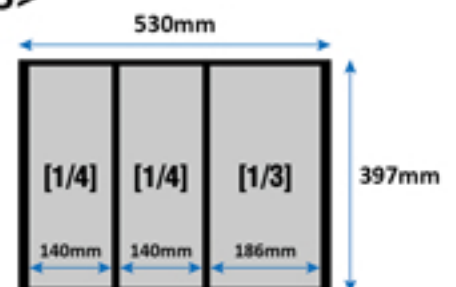
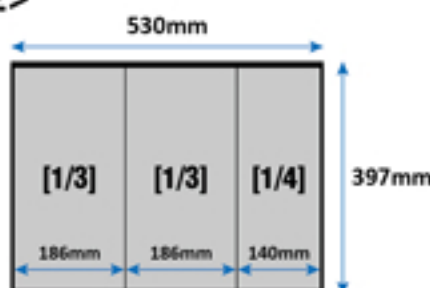
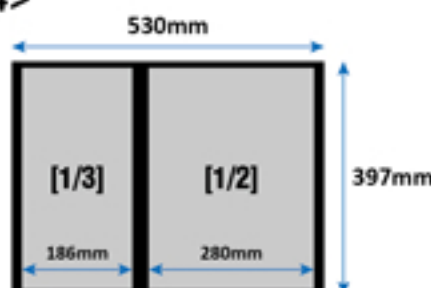
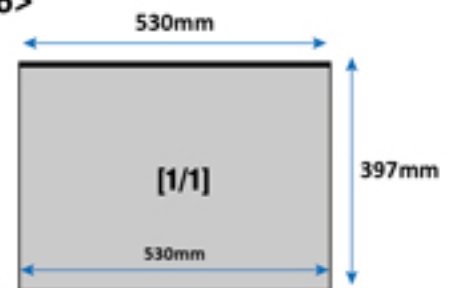
- Overall : 765mm(W) x 460mm(D) x 740mm(H)
- Overall With Casters: 765mm(W) x 460mm(D) x 900mm(H)
- 4 Drawers: 530mm(W) x 397mm(D) x 50mm(H)
- 2 Drawers: 530mm(W) x 397mm(D) x 130mm(H)

EVA Collocation:
<1>

<3>

<5>

<2>

<4>

<6>

11103

Socket Box



- Size:420mm(W) x 350mm(D) x 350mm(H)

Clever Cases

CleverCase Sizes Are As Below

Clever Case L



Clever Case S



Inside Dimension:
(W)385 x (D)295 x (H)50mm



Inside Dimension:
(W)385 x (D)195 x (H)50mm

The Following Sizes Of Modules Are Workable With Our CleverCase:

EVA Foam / Plastic Tray

[1/2]: 375 x 280 x 40mm

[1/3]: 375 x 188 x 40mm

[1/4]: 375 x 140 x 40mm

- Clever Case(L):

1pc [1/2] Size Module Or 2pcs [1/4] Size Modules

- Clever Case(S):

1pc [1/3] Size Module

The Choices of Corners, Panel Pattern & Logo





TOOL BOX & TOOL SET

 **SELTA**

10205A

5 Layers Empty Tool Chest



10205-101

5 Layers Tool Chest With 101 Pcs Of Tools

- #C5153 First Layer
- #C5142 Second Layer
- #C4482 Third Layer
- #C7008 Fourth Layer
- #C5136 Fifth Tool Set Layers



C5153

15 Pcs Combination Wrench Set (Tray)

- 4 SETS/CTN



- 15pcs Combination Wrench:
- 8, 10, 11, 12, 13, 14, 15, 16, 17, 18, 19, 21, 22, 23, 24mm

C5142

14 Pcs Pliers And Hex Key Set (Tray)

- 4 SETS/CTN



- 1pc Waterpump Pliers 10"
- 1pc Long Nose Pliers 8"
- 1pc Combination Pliers 7"
- 1pc High Leverage Diagonal Pliers 7"
- 10pcs Hex Key: H1.27, H1.5, H2, H2.5, H3, H4, H5, H6, H8, H10mm

C4482
48 Pcs 1/4" & 1/2" Dr. Socket Combination Set (Tray)

- 4 SETS/CTN



- 11pcs 1/4" Dr. Flank Socket 6pt:
4, 4.5, 5, 5.5, 6, 7, 8, 9, 10, 11, 12mm
- 2pcs 1/4" Dr. Extension Bar 2" & 6"
- 1pc 1/4" Dr. Universal Joint
- 1pc 1/4" Dr. Magnetic Socket Pick-Up
- 1pc 1/4" Dr. Coupler
- 1pc 1/4" Dr. Ratchet Handle 72TH
- 1pc 1/4" Dr. Sliding T Bar
- 1pc 1/4" Dr. Spinner
- 11pcs 1/4" Dr. Socket Bits:
(SL): 5.5, 6.5 mm
(PH): 0, 1, 2, 3 (PZ): 0, 1, 2, 3
- 1pc 1/4" Dr. Magnetic Quick-Release Bit Holder
- 13pcs 1/2" Dr. Flank Socket 6pt:
10, 11, 12, 13, 14, 15, 16, 17, 18, 19, 21, 22, 24mm
- 1pc 1/2" Dr. Adaptor For Extension
- 1pc 1/2" Dr. Universal Joint
- 1pc 1/2" Dr. Ratchet Handle 72TH
- 2pcs 1/2" Dr. Extension Bar 5" & 10"

C7008
8 Pcs Screwdriver Set (Tray)

- 4 SETS/CTN

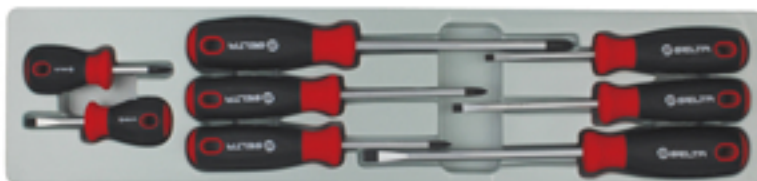

- 4pcs Slotted Screwdriver:
SL6 x 40mm, SL5 x 75mm
SL5 x 75mm, SL8 x 150mm
- 4pcs Phillips Screwdriver:
PH2 x 40mm, PH1 x 75mm
PH2 x 100mm, PH3 x 150mm

C5136
12 Pcs Combination Set (Tray)

- 4 SETS/CTN



- 1pc Utility Knife
- 1pc 5M Measuring Tape
- 4pcs Quakeproof And Safe Chisel(Flat Chisel)
15mm(W) x 14mm(Dia) x 180mmL,
2mm(Tip) x 10mm(Dia) x 140mmL,
3mm(Tip) x 10mm(Dia) x 150mmL,
4mm(Tip) x 10mm(Dia) x 190mmL
- 1pc Locking Pliers 10"
- 1pc Engineer Hammer 300g
- 1pc Rubber Hammer 280mmL
- 1pc Adjustable Gauged Wrench
- 1pc Mini Hacksaw
- 1pc Saw Blade

10205B
5 Layers Empty Tool Chest

10205-62
5 Layers Tool Chest With 62 Pcs Of Tools

- # C4606 First Layer
- # C4620 Second Layer
- # C5107 Third Layer
- # C5120 Fourth Layer
- # C5103 + C5106 Fifth Tool Set Layers



- C4606
- C4620
- C5107
- C5103
- C5106
- C5120

C4620
Socket Combination Set

- 18pcs 1/2" Dr. 6pt Socket:
10, 11, 12, 13, 14, 15, 16, 17, 18, 19, 20,
21, 22, 23, 24, 27, 30, 32mm
- 1pc 1/2" Dr. Universal Joint
- 1pc 1/2" Dr. Ratchet Handle 72TH

C4606
Wobble Extension Bar

- 3pcs 1/2" Dr. Extension Bar: 3", 5", 10"
- 1pc 1/2" Dr. Swival Handle 18"
- 1pc 1/2" Dr. Sliding T Bar 10"
- 1pc 1/2" Dr. Spark Plug Socket 21mm

C5120
11 Pcs Combination Spanner & 9 Pcs Long Hex Key Set

- 11pcs Combination Spanner:
6, 7, 8, 9, 10, 11, 12, 13, 14, 15, 16mm
- 9pcs Long Hex Key Set:
H1.5, H2, H2.5, H3, H4, H5, H6, H8, H10

C5107
7 Pcs Combination Spanner

- 7pcs Combination Spanner:
17, 18, 19, 20, 21, 22, 24mm

C5103/C5106
3 Pcs Cutting Plier & 6 Pcs Screwdriver Set

C5103 - Cutting Plier

- 1pc Long Nose Plier : 200mm
- 1pc Diagonal Cutting Plier : 180mm
- 1pc Combination Cutting Plier : 180mm

C5106 - Screwdriver Set

- 6pcs Go-Through Screwdriver :
PH2 x 100mm, PH3 x 150mm, PH3 x 200mm,
SL6 x 100mm, SL6 x150mm, SL8 x 200mm

2517
17 Pcs 1/4" Dr. Socket Set

- 10 SETS/CTN N.W.: 9.7KGS G.W.: 10.7KGS CUFT: 1.15'

72T

S2

Cr-V

 1/4"
6.3mm

Contents:

- 12pcs 1/4" Dr. Socket:
4, 4.5, 5, 5.5, 6, 7, 8, 9, 10, 11, 12, 13mm
- 1pc 1/4" Dr. Ratchet Handle 72TH
- 1pc 1/4" Dr. Universal Joint
- 1pc 1/4" Dr. Spinner Handle
- 1pc 1/4" Dr. Extension Bar 50mm
- 1pc 1/4" Dr. Sliding T Bar : 110mm



Metallic Locks



Color Sleeve

2521
21 Pcs 1/4" Dr. Socket Set

72T

S2

Cr-V

 1/4"
6.3mm

Contents:

- 11pcs 1/4" Dr. Socket:
4, 4.5, 5, 6, 7, 8, 9, 10, 11, 12, 13mm
- 1pc 1/4" Dr. Ratchet Handle 72TH
- 1pc 1/4" Dr. Universal Joint
- 1pc 1/4" Dr. Spinner Handle
- 1pc 1/4" Dr. Extension Bar 50mm
- 6pcs 1/4" Dr. Bit Socket:
(SL): 4, 5.5, 7
(PH): 1, 2, 3



Metallic Locks



Color Sleeve

2528
28 Pcs 1/4" Dr. Socket Set

- 10 SETS/CTN N.W.: 11.5KGS G.W.: 12.5KGS CUFT: 1.15'

72T

S2

Cr-V

 1/4"
6.3mm

Contents:

- 12pcs 1/4" Dr. Socket:
4, 4.5, 5, 5.5, 6, 7, 8, 9, 10, 11, 12, 13mm
- 1pc 1/4" Dr. Ratchet Handle 72TH
- 1pc 1/4" Dr. Universal Joint
- 1pc 1/4" Dr. Spinner Handle
- 1pc 1/4" Dr. Extension Bar 50mm
- 1pc 1/4" Dr. Sliding T Bar
- 11pcs 1/4" Dr. Bit Socket:
(Hex): 3, 4, 5, 6, 7
(SL): 4, 5.5, 7
(PH): 1, 2, 3



Metallic Locks



Color Sleeve

2546

46 Pcs 1/4" Dr. Socket Set

- 12 SETS/CTN N.W.: 14 KGS
G.W.: 15 KGS CUFT: 0.8'

72T

S2

Cr-V

1/4"
6.3mm



Color Sleeve

BEST CHOICE

Contents:

- 13pcs 1/4" Dr. Socket:
4, 4.5, 5, 5.5, 6, 7, 8, 9, 10, 11, 12, 13, 14mm
- 2pcs 1/4" Dr. Extension Bar 2" & 4"
- 1pc 1/4" Dr. Universal Joint
- 1pc 1/4" Dr. Sliding T Bar 110mm
- 1pc 1/4" Dr. Spinner Handle
- 21pcs 1/4" Dr. Bits Socket:
(Hex): 3, 4, 5, 6, 7, 8 (SL): 4, 5.5, 7 (PH): 1, 2, 3
(PZ): 1, 2, 3 (Torx): 10, 15, 20, 25, 30, 40
- 1pc 1/4" Dr. Ratchet Handle 72TH
- 1pc 1/4" Dr. Flexible Extension Bar 145mm
- 4pcs Hex Key: 1.27, 1.5, 2, 2.5mm
- 1pc Adapter 1/4" x 1/4"

2557

57 Pcs 1/4" Dr. Socket Set

- 10 SETS/CTN N.W.: 18KGS G.W.: 19KGS CUFT: 1.15'

72T

S2

Cr-V

1/4"
6.3mm



Metallic Locks



Color Sleeve

Contents:

- 13pcs 1/4" Dr. Socket:
4, 4.5, 5, 5.5, 6, 7, 8, 9, 10, 11, 12, 13, 14mm
- 8pcs 1/4" Dr. Deep Socket:
6, 7, 8, 9, 10, 11, 12, 13mm
- 6pcs 1/4" Dr. Star Socket: E4, E5, E6, E7, E8, E10
- 1pc 1/4" Dr. Ratchet Handle 72TH
- 1pc 1/4" Dr. Sliding T Bar
- 1pc 1/4" Dr. Spinner Handle
- 1pc 1/4" Dr. Extension Bar 3" & 6"
- 1pc 1/4" Dr. Flexible Joint Bar 145mm
- 1pc 1/4" Dr. Universal Joint
- 22pcs 1/4" Dr. Bit Socket:
(Hex): 3, 4, 5, 6, 7, 8 (SL): 4, 5.5, 6.5
(PH): 1, 2, 3 (PZ): 1, 2, 3
(Torx): 8, 10, 15, 20, 25, 30, 40

2561T

61 Pcs 1/4" Dr. Socket Set

72T

S2

Cr-V

1/4"
6.3mm



Contents:

- 13pcs 1/4" Dr. Socket:
4, 4.5, 5, 5.5, 6, 7, 8, 9, 10, 11, 12, 13, 14mm
- 8pcs 1/4" Dr. Deep Socket: 6, 7, 8, 9, 10, 11, 12, 13mm
- 1pc 1/4" Dr. Ratchet Handle 72TH
- 1pc 1/4" Dr. Sliding T-Bar 110mm
- 1pc 1/4" Dr. Universal Joint
- 1pc 1/4" Dr. Spinner Handle
- 2pcs 1/4" Dr. Extension Bar 50, 150mm
- 6pcs 1/4" Dr. E-Socket: E4, E5, E6, E7, E8, E10
- 27pcs 1/4" Dr. Bit Socket:
(Hex): 2, 2.5, 3, 4, 5, 6, 7, 8
(SL): 4, 5.5, 7 (PH): 1, 2 (PZ): 1, 2
(Torx): 10, 15, 20, 25, 27, 30, 40
(Spline): 4, 5, 6, 8, 10

3533T

33 Pcs 3/8" Dr. Socket Set

72T

S2

Cr-V

3/8"
10mm



Contents:

- 12pcs 3/8" Dr. Socket:
6, 8, 10, 11, 12, 13, 14, 16, 17, 18, 19, 22mm
- 1pc 3/8" Dr. Universal Joint
- 1pc 3/8" Dr. Ratchet Handle 72TH
- 2pcs 3/8" Dr. Extension Bar 75, 150mm
- 1pc 3/8" Dr. Sliding T-Bar 200mm
- 15pcs 3/8" Dr. Bit Socket:
(Hex): 5, 6, 8, 10
(Torx): 15, 20, 25, 30, 40, 45, 50
(Spline): 5, 6, 8, 10

3569
69 Pcs 3/8" Dr. Socket Set

- 3 SETS/CTN N.W.: 13 KGS G.W.: 14 KGS CUFT: 1.18'

72T

S2

Cr-V

 3/8"
10mm

Contents:

- 3pcs 1/4" Dr. Star Socket: E8, E10, E12
- 1pc 1/4" Dr. Spinner Handle
- 16pcs 1/4" Dr. Bits Socket:
 - (Hex): 3, 4, 5, 6 (SL): 4, 5.5, 6.5 (PH): 1, 2, 3
 - (Torx): T8, T10, T15, T20, T25, T30
- 10pcs 5/16" Dr. x 30 mmL Bits:
 - (Hex): 7, 8, 10, 12
 - (PH): 2 (SL): 8 (Torx): 40, 45, 50, 55
- 16pcs 3/8" Dr. Socket:
 - 8, 9, 10, 11, 12, 13, 14, 15, 16, 17, 18,
 - 19, 20, 21, 22, 24mm
- 9pcs 3/8" Dr. Deep Socket:
 - 8, 10, 12, 13, 14, 15, 17, 18, 19mm
- 4pcs 3/8" Dr. Star Socket: E14, E16, E18, E20
- 2pcs 3/8" Dr. Spark Plug Socket 16 & 21 mm
- 1pc 3/8" Dr. Ratchet Handle 72TH
- 1pc 3/8" Dr. Sliding T Bar
- 3pcs 3/8" Dr. Extension Bar: 2", 3", 6"
- 1pc 3/8" Dr. Universal Joint
- 1pc 3/8" Dr. Bit Holder For 5/16" Bit
- 1pc Adaptor 3/8"(F) x 1/4"(M)



Gloves



Metallic Locks



Flexible handle



Color Sleeve

4517
17 Pcs 1/2" Dr. Socket Set

 6 SETS/CTN N.W.: 15 KGS
G.W.: 16 KGS CUFT: 0.92'

72T

Cr-V

 1/2"
12.5mm

Contents:

- 13pcs 1/2" Dr. Socket:
 - 10, 11, 12, 13, 14, 15, 16, 17, 19, 21, 22, 24, 27mm
- 1pc 1/2" Dr. Ratchet Handle 72TH
- 1pc 1/2" Dr. Extension Bar 5"
- 1pc 1/2" Dr. Flexible Handle 380 mmL

4524T
24 Pcs 1/2" Dr. Socket Set

72T

S2

Cr-V

 1/2"
12.5mm

Contents:

- 18pcs 1/2" Dr. Socket:
 - 10, 11, 12, 13, 14, 15, 16, 17, 18, 19,
 - 20, 21, 22, 23, 24, 27, 30, 32mm
- 1pc 1/2" Dr. Universal Joint
- 1pc 1/2" Dr. Ratchet Handle 72TH
- 2pcs 1/2" Dr. Extension Bar 125, 250mm
- 1pc Dr. 3-Way Adapter 3/8"(F) x 1/2"(M)

4525
25 Pcs 1/2" Dr. Socket Set

72T

S2

Cr-V

 1/2"
12.5mm

Contents:

- 19pcs 1/2" Dr. Socket:
8, 9, 10, 11, 12, 13, 14, 15, 16, 17,
18, 19, 21, 22, 23, 24, 27, 30, 32mm
- 1pc 1/2" Dr. Universal Joint
- 2pcs 1/2" Dr. Extension Bar 5" & 10"
- 1pc 1/2" Dr. Sliding T Bar 12"
- 1pc 1/2" Dr. Ratchet Handle 72TH



Metallic Locks



Color Sleeve

4545
45 Pcs 1/2" Dr. Tool Set

- 3 SETS/CTN N.W.: 21KGS G.W.: 22KGS CUFT: 1.48'

72T

S2

Cr-V

 1/2"
12.5mm

Contents:

- 18pcs 1/2" Dr. Socket:
10, 11, 12, 13, 15, 16, 17, 18, 19,
20, 21, 22, 23, 24, 27, 30, 32mm
- 1pc 1/2" Dr. Ratchet Handle 72TH
- 2pcs 1/2" Dr. Extension Bar 125 & 250mm
- 1pc 1/2" Dr. Sliding T Bar 250mm
- 1pc 1/2" Dr. Universal Joint
- 1pc 1/2" Dr. Flexible Handle 15"
- 8pcs Combination Wrenches:
10, 11, 12, 13, 14, 15, 17, 19mm
- 1pc Water Pump Plier 250mm
- 1pc Combination Plier 180mm
- 4pcs Hex Key Wrench: 5, 6, 8, 10mm
- 5pcs Screwdrivers:
(SL): 6 x 40, 6 x 100
(PH): 2 x 40, 2 x 100 (PZ): 2 x 200
- 1pc Auto Tester



Gloves



Metallic Locks



Color Sleeve

3534
34 Pcs 1/4" & 3/8" Dr. Socket Set

- 10 SETS/CTN N.W.: 11.5KGS G.W.: 12.5KGS CUFT: 1.15'

72T

S2

Cr-V

 1/4"
6.3mm

 3/8"
10mm

Contents:

- 1pc 1/4" Dr. Spinner Handle
- 15pcs 1/4" Dr. Bit Socket:
(Hex): 3, 4, 5, 6 (PH): 0, 1, 2, 3
(Torx): 10, 15, 20, 25, 27, 30, 40
- 12pcs 3/8" Dr. Socket:
6, 8, 10, 11, 12, 13, 14, 15, 16, 17, 18, 19mm
- 1pc 3/8" Dr. Ratchet Handle 72TH
- 1pc 3/8" Dr. Universal Joint
- 1pc 3/8" Dr. Sliding T Bar 8"
- 2pcs 3/8" Dr. Extension Bar 3" & 6"
- 1pc 3/8" Dr. Adapter



Metallic Locks



Color Sleeve

4556
56 Pcs 1/4" & 1/2" Dr. Tool Set

- 3 SETS/CTN N.W.: 16KGS G.W.: 17KGS CUFT: 1.5'

72T

S2

Cr-V

1/4"

6.3mm

1/2"

12.5mm

Contents:

- 6pcs 1/4" Dr. Socket:
8, 9, 10, 11, 12, 13mm
- 1pc 1/4" Dr. Spinner Handle
- 1pc 1/4" Dr. Bit Coupler
- 14pcs 1/4" Dr. Bits 25mmL:
(PH): 1, 2, 3 (SL): 3, 4, 5, 6
(Torx): 10, 15, 20, 25, 27, 30, 40
- 10pcs 1/2" Dr. Socket:
10, 11, 12, 13, 15, 17, 19, 22, 24, 27mm
- 1pc 1/2" Dr. Ratchet Handle 72TH
- 2pcs 1/2" Dr. Spark Plug Socket 16 & 21mm
- 1pc 1/2" Dr. Extension Bar 125
- 1pc 1/2" Dr. Universal Joint
- 6pcs Combination Wrenches:
11, 12, 13, 14, 15, 17mm
- 1pc Water Pump Plier 250mm
- 1pc Combination Plier 180mm
- 4pcs Hex Key Wrench: 1.5, 2, 3, 4mm
- 1pc Hammer 300g
- 5pcs Screwdrivers:
(SL): 6 x 40, 6 x 100
(PH): 2 x 40, 2 x 100
(PZ): 2 x 200



Gloves



Metallic Locks



Flexible handle



Color Sleeve

4572
72 Pcs 1/4" & 1/2" Dr. Tool Set

- 3 SETS/CTN N.W.: 21 KGS G.W.: 22 KGS CUFT: 1.64'

72T

S2

Cr-V

1/4"

6.3mm

1/2"

12.5mm

Contents:

- 10pcs 1/4" Dr. Socket: 4, 5, 6, 7, 8, 9, 10, 11, 12, 13mm
- 5pcs 1/4" Dr. Deep Socket: 5, 6, 7, 8, 9mm
- 1pc 1/4" Dr. Ratchet Handle 72TH
- 1pc 1/4" Dr. Extension Bar 3"
- 1pc 1/4" Dr. Universal Joint
- 1pc 1/4" Dr. Spinner Handle
- 1pc 1/4" Dr. Coupler x 1/4"
- 14pcs 1/4" Dr. Bits:
(SL): 3, 4, 5, 6 (PH): 1, 2, 3
(Torx): 10, 15, 20, 25, 27, 30, 40
- 13pcs 1/2" Dr. Socket:
10, 11, 12, 13, 14, 15, 17, 19, 22, 24, 27, 30, 32mm
- 1pc 1/2" Dr. Ratchet Handle 72TH
- 2pcs 1/2" Dr. Spark Plug Socket 16 & 21mm
- 1pc 1/2" Dr. Extension Bar 5"
- 1pc 1/2" Dr. Universal Joint
- 8pcs Combination Wrenches:
10, 11, 12, 13, 14, 15, 17, 19mm
- 1pc Locking Pliers 10"
- 1pc Water Pump Pliers 10"
- 1pc Combination Pliers 7"
- 3pcs Hex Key Wrenches: 1.5, 2, 3mm
- 1pc Hammer 300g
- 5pcs Screwdrivers:
(SL): 6 x 40, 6 x 100mm
(PH): 2 x 40, 2 x 100mm (PZ): 2 x 200mm



Gloves



Metallic Locks



Flexible handle



Color Sleeve

4577
77 Pcs 1/4" & 1/2" Dr. Tool Set

- 3 SETS/CTN N.W.: 18KGS G.W.: 19KGS CUFT: 1.54'

72T

S2

Cr-V

 1/4"
6.3mm

 1/2"
12.5mm

Contents:

- 9pcs 1/4" Dr. Socket: 4, 5, 6, 7, 8, 9, 10, 11, 13mm
- 4pcs 1/4" Dr. Deep Socket: 8, 10, 12, 13mm
- 1pc 1/4" Dr. Lightweight Ratchet Handle 72TH
- 1pc 1/4" Dr. Extension Bar 3"
- 1pc 1/4" Dr. Flexible Extension Bar
- 1pc 1/4" Dr. Sliding T Bar
- 1pc 1/4" Dr. Coupler x 1/4"
- 1pc 1/4" Dr. Spinner Handle
- 1pc 1/4" Dr. Universal Joint
- 18pcs 1/4" Dr. Bits :
(Hex): 3, 4, 5, 6 (SL): 4, 5, 6, 7 (PH): 1, 2, 3
(Torx): 10, 15, 20, 25, 27, 30, 40
- 8pcs Combination Wrenches:
8, 10, 12, 13, 14, 15, 17, 19mm
- 13pcs 1/2" Dr. Socket:
10, 11, 12, 13, 14, 15, 17, 19, 22, 24, 27, 30, 32mm
- 1pc 1/2" Dr. Lightweight Ratchet Handle 72TH
- 2pcs 1/2" Dr. Extension Bar 125 & 250mm
- 1pc 1/2" Dr. Universal Joint
- 2pcs 1/2" Dr. Spark Plug Socket 16, 21mm
- 1pc 3-Way Adapter 3/8"(F) x 1/2" (M)
- 1pc Hammer 300g
- 5pcs Screwdrivers:
(SL): 4 x 100, 6 x 100, (PH): 1 x 75, 2 x 100, 3 x 150
- 1pc Water Pump Pliers 250mm
- 1pc Combination Pliers 180mm
- 3pcs Hex Key Wrench: 1.5, 2, 2.5 mm



Gloves



Metallic Locks



Flexible handle



Color Sleeve

4578
77 Pcs 1/4" & 1/2" Dr. Tool Set

- 3 SETS/CTN N.W.: 18KGS G.W.: 19KGS CUFT: 1.48'

72T

S2

Cr-V

 1/4"
6.3mm

 1/2"
12.5mm

Contents:

- 9pcs 1/4" Dr. Socket:
4, 5, 6, 7, 8, 9, 10, 11, 12mm
- 1pc 1/4" Dr. Ratchet Handle 72TH
- 1pc 1/4" Dr. Extension Bar 3"
- 1pc 1/4" Dr. Sliding T Bar
- 1pc 1/4" Dr. Universal Joint
- 1pc 1/4" Dr. Bit Coupler
- 21pcs 1/4" Dr. Bits 30mL:
(Hex): 2, 3, 4, 5, 6 (SL): 3, 4, 5.5, 7
(PH): 0, 1, 2, 3 (PZ): 1, 2, 3
(Torx): 10, 15, 20, 25, 30
- 4pcs Double Flexible Socket Wrench:
8 x 9, 10 x 11, 12 x 13, 14 x 15
- 13pcs 1/2" Dr. Socket: 10, 11, 12, 13, 14,
15, 17, 19, 22, 24, 27, 30, 32mm
- 1pc 1/2" Dr. Ratchet Handle 72TH
- 1pc 1/2" Dr. Spark Plug Socket 21mm
- 2pcs 1/2" Dr. Extension Bar 125 & 250mm
- 1pc 1/2" Dr. Universal Joint
- 1pc Bit Adapter
- 11pcs Combination Wrenches:
7, 8, 9, 10, 11, 12, 13, 14, 15, 17, 19mm
- 7pcs Hex Key Wrench: 1.5, 2, 2.5, 5, 6, 8, 10mm



Gloves



Metallic Locks



Flexible handle



Color Sleeve

4582
82 Pcs 1/4" & 1/2" Dr. Tool Set

- 3 SETS/CTN N.W.: 17.5 KGS G.W.: 18.5 KGS CUFT: 1.18'

72T

S2

Cr-V

1/4"

6.3mm

1/2"

12.5mm

Contents:

- 13pcs 1/4" Dr. Socket:
 - 4, 4.5, 5, 5.5, 6, 7, 8, 9, 10, 11, 12, 13, 14mm
- 1pc 1/4" Dr. Ratchet Handle 72TH
- 1pc 1/4" Dr. Universal Joint
- 2pcs 1/4" Dr. Extension Bar 2" & 4"
- 17pcs 1/4" Dr. Bits socket:
 - (Hex): 3, 4, 5, 6 (SL): 4, 5.5, 6.5 (PH): 1, 2
 - (PZ): 1, 2 (Torx): 8, 10, 15, 20, 25, 30
- 1pc 1/4" Dr. Sliding T Bar
- 1pc 1/4" Dr. Spinner Handle
- 1pc 1/4" Dr. Flexible Extension Bar 150 mm
- 12pcs 1/2" Dr. Socket:
 - 14, 15, 16, 17, 18, 19, 20, 22, 24, 27, 30, 32mm
- 1pc 1/2" Dr. Ratchet Handle 72TH
- 1pc 1/2" Dr. Universal Joint
- 2pcs 1/2" Dr. Extension Bar 5" & 10"
- 2pcs 1/2" Dr. Spark Plug Socket 16 & 21 mm
- 15pcs Bits 10mm x 30mmL:
 - (Hex): 8, 10, 12, 14 (SL): 8, 10, 12 (PH): 3, 4
 - (PZ): 3, 4 (Torx): 40, 45, 50, 55
- 1pc 3-Way Adaptor 3/8"(F) x 1/2"(M)
- 1pc 1/2" Dr. Coupler 5/16"
- 1pc Bit Adaptor
- 9pcs Combination Wrenches:
 - 8, 10, 12, 13, 14, 15, 17, 19, 22mm



Gloves



Metallic Locks



Flexible handle



Color Sleeve

4588
88 Pcs 1/4" & 1/2" Dr. Tool Set

- 3 SETS/CTN N.W.: 17.5 KGS G.W.: 18.5 KGS CUFT: 1.18'

72T

S2

Cr-V

1/4"

6.3mm

1/2"

12.5mm

Contents:

- 13pcs 1/4" Dr. Socket: 4, 4.5, 5, 5.5, 6, 7, 8, 9, 10, 11, 12, 13, 14 mm
- 1pc 1/4" Dr. Ratchet Handle 72TH
- 1pc 1/4" Dr. Universal Joint
- 2pcs 1/4" Dr. Extension Bar 2" & 4"
- 17pcs 1/4" Dr. Bits Socket:
 - (Hex): 3, 4, 5, 6 (SL): 4, 5.5, 6.5
 - (PH): 1, 2 (PZ): 1, 2
 - (Torx): 8, 10, 15, 20, 25, 30
- 1pc 1/4" Dr. Sliding T Bar
- 1pc 1/4" Dr. Spinner Handle
- 1pc 1/4" Dr. Flexible Extension Bar 150 mm
- 15pcs 1/2" Dr. Socket: 10, 12, 13, 14, 15, 16, 17, 18, 19, 20, 22, 24, 27, 30, 32 mm
- 1pc 1/2" Dr. Ratchet Handle 72TH
- 1pc 1/2" Dr. Universal Joint
- 2pcs 1/2" Dr. Extension Bar 5" & 10"
- 2pcs 1/2" Dr. Spark Plug Socket 16 & 21 mm
- 1pc 1/2" Dr. Coupler 5/16"
- 15pcs Bits 10 mm x 30 mmL:
 - (Hex): 8, 10, 12, 14 (SL): 8, 10, 12
 - (PH): 3, 4 (PZ): 3, 4
 - (Torx): 40, 45, 50, 55
- 1pc 3-Way Adaptor 3/8"(F) x 1/2"(M)
- 1pc Bit Adaptor
- 12pcs Combination Wrenches:
 - 8, 10, 11, 12, 13, 14, 15, 16, 17, 18, 19, 22 mm



Gloves



Metallic Locks



Flexible handle



Color Sleeve

4589
89 Pcs 1/4" & 1/2" Dr. Tool Set

- 3 SETS/CTN N.W.: 24.5KGS G.W.: 25.9KGS CUFT: 1.5'

72T

S2

Cr-V

1/4"

6.3mm

1/2"

12.5mm

Contents:

- 11pcs 1/4" Dr. Socket: 4, 4.5, 5, 5.5, 6, 7, 8, 9, 10, 12, 13mm
- 1pc 1/4" Dr. Ratchet Handle 72TH
- 2pcs 1/4" Dr. Extension Bar 50 & 100mm
- 1pc 1/4" Dr. Universal Joint
- 1pc 1/4" Dr. Spinner Handle
- 1pc 1/4" Dr. Sliding T Bar
- 1pc 1/4" Dr. Bit Coupler
- 1pc 1/4" Flexible Handle 150mm
- 22pcs 1/4" Dr. Bits 30mL:
 (Hex): 2, 3, 4, 5, 6, 7 (SL): 3, 4, 5.5, 7
 (PH): 0, 1, 2, 3 (PZ): 2, 3 (Torx): 10, 15, 20, 25, 27, 30
- 1pc Water Pump Plier 250mm
- 1pc Combination Plier 180mm
- 5pcs Hex Key Wrench: 5, 6, 7, 8, 10mm
- 5pcs Screwdrivers:
- 9pcs Combination Wrenches:
 8, 10, 11, 12, 13, 14, 15, 17, 19mm
- 1pc Blow Case
- 18pcs 1/2" Dr. Socket: 8, 10, 12, 13, 14, 15, 16, 17, 18,
 19, 20, 21, 22, 23, 24, 27, 30, 32mm
- 1pc 1/2" Dr. Ratchet Handle 72TH
- 2pcs 1/2" Dr. Spark Plug Socket 16, 21mm
- 2pcs 1/2" Dr. Extension Bar 75 & 250mm
- 1pc 1/2" Dr. Universal Joint
- 1pc 1/2" Dr. Sliding T Bar 250mm
- 1pc 1/2" Flexible Handle 375mm



Gloves



Metallic Locks



Flexible handle



Color Sleeve

4591
91 Pcs 1/4" & 1/2" Dr. Tool Set

- 2 SETS/CTN N.W.: 20.2KGS G.W.: 21.2KGS CUFT: 1.49'

72T

S2

Cr-V

1/4"

6.3mm

1/2"

12.5mm

Contents:

- 12pcs 1/4" Dr. Socket:
 4, 4.5, 5, 5.5, 6, 7, 8, 9, 10, 11, 12, 13mm
- 2pcs 1/4" Dr. Extension Bar 2" & 4"
- 1pc 1/4" Dr. Universal Joint
- 1pc 1/4" Dr. Sliding T Bar
- 1pc 1/4" Dr. Spinner Handle
- 24pcs 1/4" Dr. x 30 mmL Bits:
 (Hex): 2, 3, 4, 5, 6, 7, 8, 10 (SL): 5.5, 7 (PH): 0, 1, 2, 3
 (PZ): 1, 2, 3 (Torx): 10, 15, 20, 25, 27, 30, 40
- 1pc 1/4" Dr. Ratchet Handle 72TH
- 1pc 1/4" Dr. Flexible Extension Bar 150mm
- 1pc 1/4" Dr. Magnetic Socket Pick-Up
- 12pcs 1/2" Dr. Socket:
 8, 10, 12, 13, 14, 15, 16, 17, 18, 19, 20, 21mm
- 5pcs 1/2" Dr. Deep Socket: 22, 24, 27, 30, 32mm
- 2pcs 1/2" Dr. Spark Plug Socket 16, 21mm
- 2pcs 1/2" Dr. Wobble Extension Bar 2" & 5"
- 1pc 1/2" Dr. Extension Bar 10"
- 1pc 1/2" Dr. Universal Joint
- 1pc 3-Way Adapter 3/8"(F) x 1/2" (M)
- 1pc 1/2" Dr. Ratchet Handle 72TH
- 1pc 1/2" Dr. Flexible Ratchet Handle 15"
- 10pcs Combination Wrench:
 6, 8, 10, 12, 13, 14, 15, 17, 19, 22mm
- 4pcs Screwdrivers:
 (SL): 5.5 x 40, 6.5 x 150 (PH): 1 x 75, 2 x 215
- 1pc Flat Chisel: 15 x 180mmL
- 1pc Pin Punch 6 x 210mmL
- 1pc Water Pump Pliers 10"
- 1pc Combination Pliers 7"
- 1pc Long Nose Pliers 8"
- 1pc Hammer 300g



Gloves



Metallic Locks



Flexible handle



Color Sleeve

4594

94 Pcs 1/4" & 1/2" Dr. Socket Set

- 3 SETS/CTN N.W.: 19 KGS G.W.: 20 KGS CUFT: 1.18'

72T

S2

Cr-V

1/4"

6.3mm

1/2"

12.5mm

BEST CHOICE



Gloves



Metallic Locks



Flexible handle



Color Sleeve

Contents:

- 13pcs 1/4" Dr. Socket:
 - 4, 4.5, 5, 5.5, 6, 7, 8, 9, 10, 11, 12, 13, 14 mm
- 8pcs 1/4" Dr. Deep Socket: 6, 7, 8, 9, 10, 11, 12, 13 mm
- 1pc 1/4" Dr. Flexible Extension Bar 6"
- 1pc 1/4" Dr. Offset Ratchet Handle 72TH
- 2pcs 1/4" Dr. Extension Bar 2" & 4"
- 1pc 1/4" Dr. Universal Joint
- 1pc 1/4" Dr. Spinner Handle
- 17pcs 1/4" Dr. Bits Socket:
 - (Hex): 3, 4, 5, 6 (SL): 4, 5.5, 7
 - (PH): 1, 2 (PZ): 1, 2 (Torx): 8, 10, 15, 20, 25, 30
- 1pc 1/4" Dr. Sliding T Bar
- 18pcs 1/2" Dr. Socket:
 - 10, 11, 12, 13, 14, 15, 16, 17, 18, 19, 20, 21, 22, 23, 24, 27, 30, 32 mm
- 4pcs 1/2" Deep Socket: 14, 15, 17, 19 mm
- 1pc 1/2" Dr. Ratchet Handle 72TH
- 2pcs 1/2" Dr. Spark Plug Socket 16 & 21 mm
- 2pcs 1/2" Dr. Extension Bar 5" & 10"
- 1pc 3-Way Adaptor 1/2"(F) x 3/8"(M)
- 1pc 1/2" Dr. Bits Coupler
- 1pc 1/2" Dr. Universal Joint
- 15pcs Bits: (Hex): 8, 10, 12, 14 (SL): 8, 10, 12
- (PH): 3, 4 (PZ): 3, 4 (Torx): 40, 45, 50, 55
- 1pc Bit Adapter
- 3pcs Hex Key Wrenches: 1.5, 2, 2.5 mm

4595
95 Pcs 1/4" & 1/2" Dr. Tool Set
72T
S2
Cr-V
1/4"
6.3mm
1/2"
12.5mm

Gloves



Metallic Locks



Flexible handle



Color Sleeve

Contents:

- 12pcs 1/4" Dr. Socket: 4, 4.5, 5, 5.5, 6, 7, 8, 9, 10, 11, 12, 13mm
- 1pc 1/4" Dr. Light Weight Ratchet Handle 72TH
- 1pc 1/4" Dr. Extension Bar: 4"
- 1pc 1/4" Dr. Universal Joint
- 20pcs 1/4" Dr. Bit Sockets: (Hex): 3, 4, 5, 6 (SL): 4, 5.5, 6.5 (PH): 1, 2, 3 (PZ): 1, 2, 3 (Torx): 10, 15, 20, 25, 27, 30, 40
- 1pc 1/2" Dr. Lightweight Ratchet Handle 72TH
- 1pc 1/2" Dr. Extension Bar: 5"
- 1pc 1/2" Dr. Universal Joint
- 16pcs 1/2" Dr. Socket: 10, 11, 12, 13, 14, 15, 16, 17, 19, 20, 21, 22, 24, 27, 30, 32mm
- 9pcs Short Torx Hex Key Set W/ Holder: T10, T15, T20, T25, T27, T30, T40, T45, T50
- 9pcs Short Hex Key Set W/ Holder: 1.5, 2, 2.5, 3, 4, 5, 6, 8, 10
- 1pc Longnose Plier 200mm
- 1pc Sidecutter 160mm
- 1pc Utility Knife
- 4pcs Slotted Screwdrivers: 3 x 75mmL, 4 x 80mmL, 5.5 x 125mmL, 6.5 x 150mmL
- 3pcs Phillips Screwdrivers: 0 x 75mmL, 1 x 80mmL, 2 x 100mmL
- 12pcs Combination Wrench: 8, 9, 10, 11, 12, 13, 14, 15, 16, 17, 18, 19mm
- 1pc Hammer 300g

4599
99 Pcs 1/4" & 1/2" Dr. Tool Set

- 3 SETS/CTN N.W.: 20.5KGS G.W.: 21.5KGS CUFT: 1.5'

72T

S2

Cr-V

1/4"

6.3mm

1/2"

12.5mm



Gloves



Metallic Locks



Flexible handle



Color Sleeve

Contents:

- 10pcs 1/4" Dr. Socket: 4, 5, 6, 7, 8, 9, 10, 11, 12, 13mm
- 5pcs 1/4" Dr. Deep Socket: 9, 10, 11, 12, 13mm
- 1pc 1/4" Dr. Ratchet Handle 72TH
- 1pc 1/4" Dr. Extension Bar 3"
- 1pc 1/4" Dr. Universal Joint
- 1pc 1/4" Dr. Spinner Handle
- 13pcs 1/4" Dr. Bits 25mm:
 - (Hex): 3, 4, 5, 6 (SL): 4, 5.5, 7
 - (PH): 1, 2, 3 (Torx): 15, 20, 30
- 1pc Adapter
- 13pcs 1/2" Dr. Socket:
 - 10, 11, 12, 13, 14, 15, 17, 19, 22, 24, 27, 30, 32mm
- 1pc 1/2" Dr. Ratchet Handle 72TH
- 2pcs 1/2" Dr. Spark Plug Socket 16, 21mm
- 1pc 1/2" Dr. Extension Bar 125mm
- 1pc 1/2" Dr. Universal Joint
- 8pcs Combination Wrenches:
 - 10, 11, 12, 13, 14, 15, 17, 19mm
- 1pc Crimping Tool
- 26pcs Terminals
- 1pc Water Pump Plier 250mm
- 1pc Combination Plier 180mm
- 3pcs Hex Key Wrench: 1.5, 2, 2.5 mm
- 1pc Hammer 300g
- 5pcs Screwdrivers:
 - (SL): 6 x 40, 6 x 100
 - (PH): 2 x 40, 2 x 100 (PZ): 2 x 200,
- 1pc Auto Tester
- 1pc Blow Case

45101
101 Pcs 1/4" & 1/2" Dr. Tool Set

- 2 SETS/CTN N.W.: 20KGS G.W.: 21KGS CUFT: 1.48'

72T

S2

Cr-V

1/4"

6.3mm

1/2"

12.5mm



Gloves



Metallic Locks



Flexible handle



Color Sleeve

Contents:

- 9pcs 1/4" Dr. Socket:
4, 4.5, 5, 5.5, 6, 7, 8, 9, 10mm
- 6pcs 1/4" Dr. E-Socket: E4, E5, E6, E7, E8, E10
- 2pcs 1/4" Dr. Extension Bar 3" & 6"
- 1pc 1/4" Dr. Sliding T Bar
- 1pc 1/4" Dr. Spinner Handle
- 1pc 1/4" Dr. Ratchet Handle 72TH
- 1pc 1/4" Dr. Universal Joint
- 20pcs 1/4" Dr. Bits:
(Hex): 3, 4, 5, 6, 7, 10, 12
(Torx): 15, 20, 25, 27, 30, 40, 45, 50
(Spline): M6, M8, M10, M12
- 1pc 1/4" Dr. Cupler
- 1pc 1/4" Dr. Flexible Extension Bar
- 1pc Locking Pliers 250mm
- 1pc Combination Pliers 180mm
- 4pcs Screwdrivers:
(PH): 1 x 75, 2 x 100
(SL): 5 x 100, 6 x 150
- 1pc Telescoping Magnetic Pick-Up Tool
- 3pcs Wrench: 8 x 10, 11 x 13, 12 x 14mm
- 14pcs Combination Wrench: 8, 10, 11, 12, 13, 14, 15, 16, 17, 18, 19, 21, 22, 24mm
- 20pcs 1/2" Dr. Socket:
8, 9, 10, 11, 12, 13, 14, 15, 16, 17, 18, 19, 20, 21, 22, 23, 24, 27, 30, 32mm
- 5pcs 1/2" Dr. E-Socket: E11, E12, E14, E16, E18
- 3pcs 1/2" Dr. Extension Bar 2", 5", 10"
- 2pcs 1/2" Dr. Spark Plug Socket 16, 21mm
- 1pc 1/2" Dr. Ratchet Handle 72TH
- 1pc 1/2" Dr. Sliding T Bar
- 1pc 1/2" Dr. Universal Joint

45107
107 Pcs 1/4" & 1/2" Dr. Tool Set

- 2 SETS/CTN N.W.: 22.4KGS G.W.: 23.4KGS CUFT: 1.49'

72T

S2

Cr-V

1/4"

6.3mm

1/2"

12.5mm



Gloves



Metallic Locks



Flexible handle

Contents:

- 12pcs 1/4" Dr. Socket:
4, 4.5, 5, 5.5, 6, 7, 8, 9, 10, 11, 12, 13mm
- 2pcs 1/4" Dr. Extension Bar 2" & 4"
- 1pc 1/4" Dr. Universal Joint
- 1pc 1/4" Dr. Sliding T Bar
- 1pc 1/4" Dr. Couler x 1/4"
- 1pc 1/4" Dr. Spinner Handle
- 24pcs 1/4" Dr. x 30mmL Bits:
(Hex): 2, 3, 4, 5, 6, 7, 8, 10 (SL): 5.5, 7
(PH): 0, 1, 2, 3 (PZ): 1, 2, 3
(Torx): 10, 15, 20, 25, 27, 30, 40
- 1pc 1/4" Dr. Ratchet Handle 72TH
- 1pc 1/4" Dr. Flexible Extension Bar 150mm
- 1pc 1/4" Dr. Magnetic Socket Pick-Up
- 12pcs 1/2" Dr. Socket:
8, 10, 12, 13, 14, 15, 16, 17, 18, 19, 20, 21mm
- 5pcs 1/2" Dr. Deep Socket: 22, 24, 27, 30, 32mm
- 2pcs 1/2" Dr. Spark Plug Socket 16, 21mm
- 2pcs 1/2" Dr. Wobble Extension Bar 2" & 5"
- 1pc 1/2" Dr. Extension Bar 10"
- 1pc 1/2" Dr. Universal Joint
- 1pc 3-Way Adapter 3/8"(F) x 1/2" (M)
- 1pc 1/2" Dr. Ratchet Handle 72TH
- 1pc 1/2" Dr. Flexible Extension Bar 15"
- 16pcs Combination Wrench: 6, 7, 8, 9, 10, 11, 12, 13, 14, 15, 16, 17, 18, 19, 21, 22mm
- 5pcs Flare Nut Wrenches:
8 x 10, 10 x 12, 11 x 13, 12 x 14, 17 x 19mm
- 1pc Flat Chisel: 15 x 180mmL
- 10pcs Hex Key: 2.5, 3, 4, 5, 6, 7, 8, 10, 12, 14mm
- 1pc Water Pump Pliers 180mm
- 1pc Combination Pliers 180mm
- 1pc 20 Blade Feeler Gage
- 1pc Hammer 300g

45108
108 Pcs 1/4" & 1/2" Dr. Socket Set

- 3 SETS/CTN N.W.: 19.5 KGS G.W.: 20.5 KGS CUFT: 1.18'

72T

S2

Cr-V

1/4"

6.3mm

1/2"

12.5mm



Gloves



Metallic Locks



Flexible handle

Contents:

- 13pcs 1/4" Dr. Socket:
 - 4, 4.5, 5, 5.5, 6, 7, 8, 9, 10, 11, 12, 13, 14 mm
- 8pcs 1/4" Dr. Deep Socket: 6, 7, 8, 9, 10, 11, 12, 13 mm
- 5pcs 1/4" Dr. E-Socket: E4, E5, E6, E7, E8
- 1pc 1/4" Dr. Ratchet Handle 72TH
- 2pcs 1/4" Dr. Extension Bar 2" & 3"
- 1pc 1/4" Dr. Sliding T Bar
- 1pc 1/4" Dr. Universal Joint
- 1pc 1/4" Dr. Spinner Handle
- 18pcs 1/4" Dr. Bits Socket:
 - (Hex): 3, 4, 5, 6 (SL): 4, 5.5, 6.5
 - (PH): 1, 2 (PZ): 1, 2
 - (Torx): 8, 10, 15, 20, 25, 27, 30
- 17pcs 1/2" Dr. Socket:
 - 10, 11, 12, 13, 14, 15, 16, 17, 18, 19,
 - 20, 21, 22, 24, 27, 30, 32 mm
- 8pcs 1/2" Dr. E-Socket:
 - E10, E11, E12, E14, E16, E18, E20, E24
- 5pcs 1/2" Deep Socket: 14, 15, 17, 19, 22 mm
- 1pc 1/2" Dr. Ratchet Handle 72TH
- 2pcs 1/2" Dr. Spark Plug Socket 16 & 21 mm
- 2pcs 1/2" Dr. Extension Bar 5" & 10"
- 1pc 3-Way Adaptor 1/2"(F) x 3/8"(M)
- 1pc 1/2" Dr. Bits Coupler
- 1pc 1/2" Dr. Universal Joint
- 17pcs 5/16" Dr. Bits:
 - (Hex): 7, 8, 10, 12, 14 (SL): 8, 10, 12
 - (PH): 3, 4 (PZ): 3, 4 (Torx): 40, 45, 50, 55, 60
- 3pcs Hex Key Wrenches: 1.5, 2, 2.5 mm

45124
124 Pcs 1/4" & 1/2" Dr. Tool Set

- 2 SETS/CTN N.W.: 21KGS G.W.: 22KGS CUFT: 1.49'

72T

S2

Cr-V

1/4"

6.3mm

1/2"

12.5mm



Gloves



Metallic Locks



Flexible handle

Contents:

- 12pcs 1/4" Dr. Socket:
 - 4, 4.5, 5, 5.5, 6, 7, 8, 9, 10, 11, 12, 13mm
- 5pcs 1/4" Dr. E-Socket: E4, E5, E6, E7, E8
- 1pc 1/4" Dr. Ratchet Handle 72TH
- 2pcs 1/4" Dr. Extension Bar 2" & 4"
- 1pc 1/4" Dr. Universal Joint
- 1pc 1/4" Dr. Flexible Extension Bar
- 1pc 1/4" Dr. Spinner Handle
- 1pc 1/4" Dr. Sliding T Bar 115mmL
- 1pc 1/4" Dr. Bit Holder
- 22pcs 1/4" Dr. Bits:
 - (Hex): 3, 4, 5, 6, 8
 - (SL): 4, 5.5, 6.5
 - (PH): 1, 2 (PZ): 1, 2
 - (Torx): 8, 10, 15, 20, 25, 27, 30, 40
- 20pcs 5/16" Dr. Bits:
 - (Hex): 7, 8, 9, 10, 12, 14
 - (SL): 6, 8, 10, 12
 - (PH): 3, 4 (PZ): 3, 4
 - (Trox): 30, 40, 45, 50, 55, 60
- 17pcs 1/2" Dr. Socket:
 - 8, 10, 11, 12, 13, 14, 1, 16, 17, 18, 19, 20, 21, 24, 27, 30, 32mm
- 1pc 1/2" Dr. Ratchet Handle 72TH
- 8pcs 1/2" Dr. E-Socket:
 - E10, E11, E12, E14, E16, E18, E20, E24
- 3pcs 1/2" Dr. Extension Bar: 3", 5", 10"
- 1pc 1/2" Dr. Flexible Extension Bar 150mm
- 1pc 1/2" Dr. Universal Joint
- 1pc 3-Way Adapter 3/8"(F) x 1/2" (M)
- 11pcs Combination Wrench:
 - 8, 10, 12, 13, 14, 15, 16, 17, 19, 21, 22mm
- 1pc Water Pump Pliers 250mm
- 1pc Combination Pliers 180mm
- 1pc Diagonal Cutting Pliers 6"
- 1pc Hammer 300g
- 4pcs Screwdrivers:
 - (SL): 5.5 x 40, 5.5 x 125, 6.5 x 150
 - (PH): 1 x 75, 2 x 40, 2 x 100, 3 x 150
- 1pc Flexible Screwdrivers 1/4" Dr. x 500mmL
- 1pc Telescopic Magnetic Pick-Up

45141T
141 Pcs 1/4" & 3/8" & 1/2" Dr. Tool Set
72T
S2
Cr-V
1/4"
6.3mm
3/8"
10mm
1/2"
12.5mm

Contents:

- 13pcs 1/4" Dr. Socket:
 - 4, 4.5, 5, 5.5, 6, 7, 8, 9, 10, 11, 12, 13, 14mm
- 7pcs 1/4" Dr. Deep Socket: 6, 7, 8, 9, 10, 11, 12mm
- 5pcs 1/4" Dr. E-Socket: E4, E5, E6, E7, E8
- 2pcs 1/4" Dr. Wobble Extension Bar 50, 100mm
- 1pc 1/4" Dr. Ratchet Handle 72TH
- 1pc 1/4" Dr. Universal Joint
- 18pcs 1/4" Dr. Bit Socket:
 - (Hex): 3, 4, 5, 6 (SL): 4, 5.5, 6.5
 - (PH): 1, 2 (PZ): 1, 2
 - (Torx): 8, 10, 15, 20, 25, 27, 30
- 11pcs 3/8" Dr. Socket:
 - 8, 10, 11, 12, 13, 14, 15, 16, 17, 18, 19mm
- 5pcs 3/8" Dr. Deep Socket: 10, 11, 12, 13, 14mm
- 8pcs 3/8" Dr. E-Socket: E8, E10, E11, E12, E14, E16, E18, E20
- 2pcs 3/8" Dr. Spark Plug Socket: 14, 16mm
- 2pcs 3/8" Dr. Wobble Extension Bar 50, 150mm
- 1pc 3/8" Dr. Ratchet Handle 72TH
- 1pc 3/8" Dr. Universal Joint
- 3pcs 3/8" Dr. Bit Socket:
 - (Torx): 30, 40, 50
- 11pcs 1/2" Dr. Socket:
 - 14, 15, 17, 18, 19, 21, 22, 24, 27, 30, 32mm
- 4pcs 1/2" Dr. Deep Socket: 14, 17, 19, 22mm
- 2pcs 1/2" Dr. Wobble Extension Bar 50, 250mm
- 1Pc 1/2" Dr. Ratchet Handle 72TH
- 1Pc 1/2" Dr. Swivel Handle 375mm(15")
- 8pcs 1/2" Dr. Bit Socket:
 - (Hex): 6, 7, 8, 10, 12 (Torx): 50, 55, 60
- 3pcs 1/2" Dr. Impact Socket: 17, 19, 21mm
- 1pc 1/2" Dr. Impact Universal Joint
- 1pc Dr. 3-Way Adapter 1/2"(F) x 3/8"(M)
- 1pc Dr. 3-Way Adapter 3/8"(F) x 1/2"(M)
- 1pc Dr. Adapter 3/8"(F) x 1/2"(M)
- 3pcs Double Ring Flat Gear Spanner 72TH:
 - 8 x 10, 12 x 13, 17 x 19mm
- 13pcs Combination Spanner:
 - 8, 10, 11, 12, 13, 14, 15, 16, 17, 18, 19, 22, 24mm
- 10pcs Hex Key: 1.27, 1.5, 2, 2.5, 3, 4, 5, 6, 8, 10

45142
142 Pcs 1/4" & 3/8" & 1/2" Dr. Tool Set

- 2 SETS/CTN N.W.: 27 KGS G.W.: 28 KGS CUFT: 1.49'

72T

S2

Cr-V

1/4"

6.3mm

3/8"

10mm

1/2"

12.5mm



Gloves



Metallic Locks



Flexible handle

Contents:

- 9pcs 1/4" Dr. Socket: 4, 4.5, 5, 5.5, 6, 7, 8, 9, 10 mm
- 5pcs 1/4" Dr. E-Socket: E4, E5, E6, E7, E8
- 3pcs 1/4" Dr. Extension Bar: 2", 4", 6"
- 1pc 1/4" Dr. Universal Joint
- 1pc 1/4" Dr. Sliding T Bar
- 1pc 1/4" Dr. Spinner Handle
- 26pcs 1/4" Dr. x 30 mmL Bits:
 - (Hex): 2, 3, 4, 5, 6, 7, 8, 10 (SL): 4, 5.5, 7
 - (PH): 0, 1, 2, 3 (PZ): 0, 1, 2, 3
 - (Torx): 10, 15, 20, 25, 27, 30, 40
- 1pc 1/4" Dr. Ratchet Handle 72TH
- 1pc 1/4" Dr. Flexible Extension Bar 150 mm
- 1pc Bit Holder 1/4" x 30L
- 1pc Adaptor 3/8"(F) x 1/4"(M)
- 15pcs 3/8" Dr. Socket:
 - 6, 7, 8, 9, 10, 11, 12, 13, 14, 15, 17, 18, 19, 21, 22 mm
- 2pcs 3/8" Dr. Extension bar 3" & 6"
- 1pc 3/8" Dr. Universal Joint
- 1pc 3/8" Dr. Flexible Ratchet Handle
- 19pcs 1/2" Dr. Socket:
 - 8, 10, 12, 13, 14, 15, 16, 17, 18, 19, 20, 21, 22, 23, 24, 25, 27, 30, 32 mm
- 5pcs 1/2" Dr. E-Socket: E10, E12, E14, E16, E20
- 17pcs Combination Wrenches:
 - 6, 7, 8, 9, 10, 11, 12, 13, 14, 15, 16, 17, 18, 19, 21, 22, 24 mm
- 2pcs 1/2" Dr. Spark Plug Socket 16 & 21 mm
- 2pcs 1/2" Dr. Extension Bar 3" & 10"
- 1pc 1/2" Dr. Universal Joint
- 1pc 1/2" Dr. Ratchet Handle 72TH
- 1pc Adaptor 3/8"(F) x 1/2"(M)
- 1pc L handle
- 1pc Swivel Handle (430 mmL)
- 10pcs Hex Key: 2.5, 3, 4, 5, 6, 7, 8, 10, 12, 14 mm
- 5pcs Flare Nut Wrenches:
 - 8 x 10, 10 x 12, 11 x 13, 12 x 14, 17 x 19 mm
- 1pc Engineering Hammer 300g
- 1pc Combination Pliers 7"
- 1pc Locking Pliers 10"
- 1pc Stubby Screwdriver (PH) 1 x 40
- 1pc Screwdriver (PH) 2 x 150
- 1pc Hammer Screwdriver (PH) 2 x 100
- 1pc Stubby Screwdriver (SL) 5.5 x 40
- 1pc Screwdriver (SL) 6.5 x 100
- 1pc Hammer Screwdriver (SL) 6.5 x 150

45145
145 Pcs 1/4" & 1/2" Dr. Tool Set

- 2 SETS/CTN N.W.: 23KGS G.W.: 24KGS CUFT: 1.49'

72T

S2

Cr-V

1/4"

6.3mm

1/2"

12.5mm



Gloves



Metallic Locks



Flexible handle

Contents:

- 10pcs 1/4" Dr. Socket:
4, 5, 6, 7, 8, 9, 10, 11, 12, 13mm
- 2pcs 1/4" Dr. Extension Bar 2" & 4"
- 1pc 1/4" Dr. Universal Joint
- 1pc 1/4" Dr. Sliding T Bar
- 1pc 1/4" Dr. Coupler x 1/4"
- 1pc 1/4" Dr. Spinner Handle
- 22pcs 1/4" Dr. x 30 mmL Bits:
(Hex): 3, 4, 5, 6, 7
(SL): 3, 4, 5.5, 7
(PH): 0, 1, 2, 3 (PZ): 1, 2, 3
(Torx): 10, 15, 20, 25, 27, 30
- 1pc 1/4" Dr. Ratchet Handle 72TH
- 1pc 1/4" Dr. Flexible Extension Bar 150mm
- 21pcs 5/16" Dr. Bits:
(Hex 75mmL): 4, 5, 6, 7, 8, 10, 12
(SL): 4, 5.5, 7 (PH): 1, 3, 4
(Torx 30mmL): 10, 20, 25, 27, 30, 40, 45, 50
- 18pcs 1/2" Dr. Socket:
10, 11, 12, 13, 14, 15, 16, 17, 18, 19, 20,
21, 22, 23, 24, 27, 30, 32mm
- 16pcs Combination Wrench:
6, 7, 8, 9, 10, 11, 12, 13, 14, 15, 16, 17, 19,
22, 24, 27mm
- 2pcs 1/2" Dr. Spark Plug Socket 16, 21mm
- 2pcs 1/2" Dr. Extension Bar 3", 10"
- 1pc 1/2" Dr. Universal Joint
- 1pc 1/2" Dr. Coupler x 5/16"
- 1pc 1/2" Dr. Ratchet Handle 72TH
- 1pc 1/2" Dr. Flexible Ratchet Handle 15"
- 4pcs Screwdrivers:
(SL): 6 x 40, 8 x 200
(PH): 2 x 40, 2 x 200
- 4pcs Drift Pin Punch: 1.5 x 150, 3 x 150, 4 x 150, 5 x 150
- 1pc Center Punch: 5 x 120mm
- 2pcs Flat Chisel: 18 x 150 & 24 x 200mm
- 1pc Water Pump Pliers 250mm
- 1pc Combination Pliers 180mm
- 1pc Crimping Tool 215mm
- 26pcs Terminals
- 1pc Hammer 300g

45150
150 Pcs 1/4" & 3/8" & 1/2" Dr. Socket Set

- 2 SETS/CTN N.W.: 17 KGS G.W.: 18 KGS CUFT: 0.99'

72T

S2

Cr-V

1/4"

6.3mm

3/8"

10mm

1/2"

12.5mm



Gloves



Color Sleeve



Sliding Locks

Contents:

- 13pcs 1/4" Dr. Socket:
 - 4, 4.5, 5, 5.5, 6, 7, 8, 9, 10, 11, 12, 13, 14 mm
- 7pcs 1/4" Dr. Deep Socket: 4, 5, 6, 7, 8, 9, 10 mm
- 5pcs 1/4" Dr. E-Socket: E4, E5, E6, E7, E8
- 1pc 1/4" Dr. Ratchet Handle 72TH
- 1pc 1/4" Dr. Universal Joint
- 1pc 1/4" Dr. Spinner Handle
- 2pcs 1/4" Dr. Extension Bar 2" & 4"
- 1pc 1/4" Dr. Sliding T Bar
- 30pcs 1/4" Dr. Bits Socket:
 - (Hex): 3, 4, 5, 6 (SL): 4, 5.5, 6.5, 7
 - (PH): 0, 1, 2 (PZ): 0, 1, 2
 - (Torx): 8, 9, 10, 15, 20, 25, 27, 30
 - (TP): 8, 9, 10, 15, 20, 25, 27, 30
- 10pcs 3/8" Dr. Socket:
 - 10, 11, 12, 13, 14, 15, 16, 17, 18, 19 mm
- 6pcs 3/8" Dr. Deep Socket: 10, 11, 12, 13, 14, 15 mm
- 6pcs 3/8" Dr. E-Socket: E10, E11, E12, E14, E16, E18
- 1pc 3/8" Dr. Ratchet Handle 72TH
- 1pc 3/8" Dr. Universal Joint
- 1pc 3/8" Dr. Extension Bar 5"
- 1pc 3/8" Dr. Coupler x 5/16"
- 1pc 3/8" Dr. Spark Plug Socket 18 mm
- 17pcs 1/2" Dr. Socket:
 - 10, 11, 12, 13, 14, 15, 16, 17, 18, 19,
 - 20, 21, 22, 24, 27, 30, 32 mm
- 5pcs 1/2" Dr. Deep Socket: 16, 17, 18, 19, 22 mm
- 2pcs 1/2" Dr. E-Socket E20 & E24
- 1pc 1/2" Dr. Ratchet Handle 72TH
- 2pcs 1/2" Dr. Extension Bar 5" & 10"
- 1pc 1/2" Dr. Universal Joint
- 2pcs 1/2" Dr. Spark Plug Socket 16 & 21 mm
- 1pc 3-Way Adaptor 3/8"(F) x 1/2"(M)
- 1pc 1/2" Dr. Coupler x 5/16"
- 7pcs Hex Key Wrenches: 1.27, 1.5, 2, 2.5, 3, 4, 5 mm
- 24pcs 5/16" Dr. Bits:
 - (Hex): 7, 8, 10, 12, 14 (SL): 8, 10, 12
 - (PH): 3, 4 (PZ): 3, 4 (Torx): 40, 45, 50, 55, 60, 70
 - (TP): 40, 45, 50, 55, 60, 70

45163
163 Pcs 1/4" & 3/8" & 1/2" Dr. Tool Set

- 1 SETS/CTN N.W.: 17 KGS G.W.: 18 KGS CUFT: 1.25'

72T

S2

Cr-V

1/4"

6.3mm

3/8"

10mm

1/2"

12.5mm



Gloves



Metallic Locks



Flexible handle



Color Sleeve

Contents:

- 11pcs 1/4" Dr. Socket 6pt:
4, 4.5, 5, 6, 7, 8, 9, 10, 11, 12, 13 mm
- 5pcs 1/4" Dr. Deep Socket: 6, 7, 8, 9, 10 mm
- 5pcs 1/4" Dr. E-Socket: E4, E5, E6, E7, E8
- 1pc 1/4" Dr. Ratchet Handle 72TH
- 1pc 1/4" Dr. Extension Bar 4"
- 1pc 1/4" Dr. Universal Joint
- 1pc 1/4" Dr. Spinner Handle
- 6pcs 1/4" Dr. Bits Socket:
(SL): 5, 6, 7
(PH): 1, 2, 3
- 10pcs 3/8" Dr. Socket 6pt:
8, 9, 10, 11, 12, 13, 14, 15, 16, 17 mm
- 6pcs 3/8" Dr. Deep Socket 6pt: 10, 11, 12, 13, 14, 17 mm
- 8pcs 3/8" Dr. E-Socket:
E8, E10, E11, E12, E14, E16, E18, E20
- 1pc 3/8" Dr. Ratchet Handle 72TH
- 1pc 3/8" Dr. Universal Joint
- 2pcs 3/8" Dr. Extension Bar 3" & 6"
- 11pcs 3/8" Dr. Bits Socket:
(Hex): 3, 4, 5, 6, 7, 8, 10
(Torx): 20, 25, 27, 30
- 17pcs 1/2" Dr. Socket-6pt:
10, 11, 12, 13, 14, 15, 16, 17, 18,
19, 20, 21, 22, 24, 27, 30, 32 mm
- 9pcs 1/2" Dr. Deep Socket:
10, 12, 13, 14, 15, 16, 17, 18, 19 mm
- 1pc 1/2" Dr. Ratchet Handle 72TH
- 1pc 1/2" Dr. Universal Joint
- 1pc 1/2" Dr. Sliding T Bar 12"
- 2pcs 1/2" Dr. Extension Bar 5" & 10"
- 1pc 1/2" Dr. Swivel Handle (375 mL)
- 2pcs 1/2" Dr. Spark Plug Socket 16 & 21 mm
- 2pcs Adapter 3/8"(F) x 1/2"(M) & 1/2"(F) x 3/8"(M)
- 1pc Ratchet Adaptor 1/2"(F) x 1/2"(M)
- 3pcs 1/2" Dr. Deep Impact Socket: 17, 18, 19 mm
- 2pcs 1/2" Dr. Coupler x 5/16" & 10mm
- 5pcs 1/2" Dr. Bits Socket: (Torx): 40, 45, 50, 55, 60
- 12pcs Combination Wrenches:
8, 9, 10, 11, 12, 13, 14, 15, 16, 17, 18, 19 mm
- 3pcs Double Box Flat Gear Spanner :
8 x 10, 12 x 13, 17 x 19 mm
- 9pcs Hex key Wrenches: 1.5, 2, 2.5, 3, 4, 5, 6, 8, 10 mm
- 10pcs 1/4" Dr. Bits 25 mm:
(SL): 5.5 (PH): 1, 2
(TP): 10, 15, 20, 25, 27, 30, 40
- 12pcs 10 x 75mm:
(Torx): 30, 40, 45 (PH): 6, 7, 8, 10
(M): 6, 8, 10, 12, 14

45172
172 Pcs 1/4" & 3/8" & 1/2" Dr. Socket Set

- 2 SETS/CTN N.W.: 17 KGS G.W.: 18 KGS CUFT: 1.04'

72T

S2

Cr-V

 1/4"
6.3mm

 3/8"
10mm

 1/2"
12.5mm

Gloves



Color Sleeve



Sliding Locks

Contents:

- 13pcs 1/4" Dr. Socket:
 - 4, 4.5, 5, 5.5, 6, 7, 8, 9, 10, 11, 12, 13, 14 mm
- 7pcs 1/4" Dr. Deep socket: 4, 5, 6, 7, 8, 9, 10 mm
- 5pcs 1/4" Dr. E-Socket: E4, E5, E6, E7, E8
- 30pcs 1/4" Dr. Bits Socket:
 - (Hex): 3, 4, 5, 6 (SL): 4, 5.5, 6.5, 7
 - (PH): 0, 1, 2 (PZ): 0, 1, 2
 - (Torx): 8, 9, 10, 15, 20, 25, 27, 30
 - (TP): 8, 9, 10, 15, 20, 25, 27, 30
- 2pcs 1/4" Dr. Extension Bar 50 & 100 mm
- 1pc 1/4" Dr. Spinner Handle
- 1pc 1/4" Dr. Lightweight Ratchet Handle 72TH
- 1pc 1/4" Dr. Sliding T Handle
- 1pc 1/4" Dr. Universal Joint
- 7pcs 1/4" Dr. L Type Wrenches: 1.27, 1.5, 2, 2.5, 3, 4, 5 mm
- 1pc 1/4" Dr. Coupler
- 20pcs 1/4" x 1/4" Dr. Bits:
 - (Spline): M5, M6, M8
 - (Ribe): 5, 6, 7, 8, 9
 - (Torx): 5, 6, 7
 - (TP): 7, 10, 15, 20, 25, 27, 30, 40, 45
- 12pcs 5/16" Dr. Bits:
 - (Torx): 40, 45, 50, 55, 60, 70
 - (W/Tamperproof): 40, 45, 50, 55, 60, 70
- 1pc 3/8" Dr. Spark Plug Socket 18 mm
- 1pc 3/8" Dr. Lightweight Ratchet Handle 72TH
- 1pc 3/8" Dr. Universal Joint
- 6pcs 3/8" Dr. E-Socket: E10, E11, E12, E14, E16, E18
- 6pcs 3/8" Dr. Deep Socket: 10, 11, 12, 13, 14, 15 mm
- 10pcs 3/8" Dr. Socket:
 - 10, 11, 12, 13, 14, 15, 16, 17, 18, 19 mm
- 1pc 3/8" Dr. Coupler
- 1pc 3/8" Dr. Extension Bar 125 mm
- 17pcs 1/2" Dr. Socket:
 - 10, 11, 12, 13, 14, 15, 16, 17, 18,
 - 19, 20, 21, 22, 24, 27, 30, 32 mm
- 5pcs 1/2" Dr. Deep Socket: 16, 17, 18, 19, 22 mm
- 2pcs 1/2" Dr. E-Socket E20 & E24
- 2pcs 1/2" Dr. Spark Plug Socket 16 & 21 mm
- 1pc 1/2" Dr. Universal Joint
- 2pcs 1/2" Dr. Extension Bar 125 & 250 mm
- 1pc 1/2" Dr. Coupler
- 1pc 1/2" Dr. Lightweight Ratchet Handle 72TH
- 12pcs 1/2" x 5/16" Dr. Bits:
 - (Hex): 7, 8, 10, 12, 14 (SL): 8, 10, 12
 - (PH): 3, 4 (PZ): 3, 4
- 1pc 3-Way Adaptor 3/8"(F) x 1/2"(M)

45180
180 Pcs 1/4" & 3/8" & 1/2" Dr. Tool Set

- 1 SETS/CTN N.W.: 15 KGS G.W.: 16 KGS CUFT: 1.25'

72T

S2

Cr-V

1/4"

6.3mm

3/8"

10mm

1/2"

12.5mm



Gloves



Metallic Locks



Flexible handle



Color Sleeve

Contents:

- 9pcs 1/4" Dr. Socket: 4, 4.5, 5, 5.5, 6, 7, 8, 9, 10 mm
- 5pcs 1/4" Dr. Deep Socket: 6, 8, 10, 12, 13 mm
- 5pcs 1/4" Dr. E-Socket: E4, E5, E6, E7, E8
- 3pcs 1/4" Dr. Extension Bar: 2", 3", 4"
- 1pc 1/4" Dr. Universal Joint
- 1pc 1/4" Dr. Sliding T Bar
- 13pcs 1/4" x 25 mmL Bits:
 - (Hex): 1.5, 2, 2.5 (SL): 3, 4
 - (PH): 0 (PZ): 0 (Torx): T4, 5, 6, 7, 8, 9
- 1pc 1/4" Dr. Ratchet Handle 72TH
- 1pc 1/4" Dr. Flexible Extension Bar 145 mm
- 1pc 1/4" Dr. Coupler x 1/4"
- 17pcs 5/16" x 30 mmL Bits:
 - (Hex): 3, 4 (SL): 5.5, 6.5, 8, 9.5, 10
 - (PH): 1, 2, 3 (PZ): 1, 2, 3 (Torx): 10, 15, 20, 30, 40
- 32pcs 3/8" x 30 mmL Bits:
 - (Hex): 5, 6, 7, 8, 10, 12, 14 (SL): 6, 8, 10, 12, 14, 16
 - (PH): 1, 2, 3 (PZ): 1, 2 (TP): 10, 15, 20, 30, 40, 45, 50
 - (Ribe): 5, 6, 7, 8, 10, 12, 14
- 3pc 3-Way Adaptor:
 - 3/8" (F) x 1/4" (M), 1/2" (F) x 3/8" (M),
 - 3/8" (F) x 1/2" (M)
- 7pcs 3/8" Dr. Socket: 8, 9, 10, 11, 12, 13, 14 mm
- 6pcs 3/8" Dr. Deep Socket: 10, 11, 12, 13, 14, 15 mm
- 4pcs 3/8" Dr. E-Socket: E10, E11, E12, E14
- 1pc 3/8" Dr. Ratchet Handle 72TH
- 1pc 3/8" Dr. Sliding T Bar
- 3pcs 3/8" Dr. Extension Bar: 3", 6", 10"
- 1pc 3/8" Dr. Coupler x 5/16"
- 1pc 3/8" Dr. Universal Joint
- 17pcs 1/2" Dr. Socket:
 - 8, 9, 10, 11, 12, 13, 14, 15, 16, 17, 18, 19,
 - 22, 24, 27, 30, 32 mm
- 3pcs 1/2" Dr. Deep Socket: 17, 19, 22 mm
- 5pcs 1/2" Dr. E-Socket: E16, E18, E20, E22, E24
- 1pc 1/2" Dr. Sliding T Bar
- 1pc 1/2" Dr. Coupler x 3/8"
- 1pc 1/2" Dr. Universal Joint
- 2pcs 1/2" Dr. Spark Plug Socket 16 & 21 mm
- 2pcs 1/2" Dr. Extension Bar 5" & 10"
- 1pc 1/2" Dr. Ratchet Handle 72TH
- 1pc 1/2" Dr. Swivel Handle (375 mmL)
- 14pcs Combination Wrenches:
 - 8, 10, 11, 12, 13, 14, 15, 16, 17, 18, 19,
 - 21, 22, 24 mm
- 3pcs Flare Nut Wrenches: 8 x 10, 11 x 13, 12 x 14 mm
- 1pc Magnetic Pick-Up 130~640 mmL
- 1pc Combination Pliers 7"
- 1pc Locking Pliers 10"
- 1pc Diagonal Pliers 150 mm
- 1pc Water Pump Pliers 250 mm
- 1pc Stubby Screwdriver (PH): 2 x 40 mm
- 1pc Screwdriver (PH): 1 x 75 mm
- 1pc Hammer Phillips Screwdriver 2 x 100 mm
- 1pc Stubby Screwdriver (SL): 6.5 x 40 mm
- 2pcs Screwdrivers (SL): 5.5 x 125 & 6.5 x 150 mm

45202
202 Pcs 1/4" & 3/8" & 1/2" Dr. Tool Set

- 1 SETS/CTN N.W.: 17 KGS G.W.: 18 KGS CUFT: 1.25'

72T

S2

Cr-V

1/4"

6.3mm

3/8"

10mm

1/2"

12.5mm



Gloves



Metallic Locks



Flexible handle



Color Sleeve

Contents:

- 8pcs 1/4" Dr. Socket: 6, 7, 8, 9, 10, 12, 13, 14 mm
- 8pcs 1/4" Dr. Deep Socket: 6, 7, 8, 9, 10, 11, 12, 13 mm
- 3pcs 1/4" Dr. Star Socket: E8, E10, E12
- 1pc 1/4" Dr. Ratchet Handle 72TH
- 1pc 1/4" Dr. Bit Holder
- 1pc 1/4" Dr. Spinner
- 1pc 1/4" Dr. Sliding T Handle 115 mm
- 2pcs 1/4" Dr. Extension Bar 50 & 100 mm
- 1pc 1/4" Dr. Flexible Extension Bar 150 mm
- 1pc 1/4" Dr. Universal Joint
- 33pcs 1/4" x 25 mmL Bits:
 - (Hex): 3, 4, 5, 6 (SL): 3, 4, 5.5, 6.5
 - (PH): 1, 2, 3 (PZ): 1, 2, 3
 - (Torx): 6, 7, 8, 9, 10, 15, 20, 27, 30, 35, 40
 - (Five-Sided Star Tamperproof): 10, 15, 20, 25, 27, 30, 40, 45
- 13pcs 3/8" Dr. Flank Socket:
 - 6, 7, 8, 9, 10, 12, 13, 14, 15, 16, 17, 19, 21 mm
- 6pcs 3/8" Dr. Deep Socket: 10, 12, 13, 14, 15, 17 mm
- 1pc 3/8" Dr. Ratchet Handle 72TH
- 1pc 3/8" Dr. Sliding T Handle 165 mm
- 2pcs-3/8" Dr. Extension Bar 75 & 150 mm
- 1pc 3/8" Dr. Universal Joint
- 1pc 3/8" Bit Holder For 5/16" Bits
- 18pcs 1/2" Dr. Flank Socket:
 - 10, 11, 12, 13, 14, 15, 16, 17, 18, 19, 20, 21, 22, 24, 27, 30, 32, 36 mm
- 5pcs 1/2" Dr. Deep Socket: 14, 15, 17, 19, 22 mm
- 6pcs 1/2" Dr. Star Socket: E10, E12, E14, E16, E18, E20
- 1pc 1/2" Dr. Ratchet Handle 72TH
- 3pcs 1/2" Dr. Spark Plug Socket: 16, 18, 21 mm
- 1pc 1/2" Dr. Swivel Handle (375 mmL)
- 1pc 1/2" Dr. L Handle 250 mm
- 2pcs 1/2" Dr. Extension Bar 125 & 250 mm
- 1pc 1/2" Dr. Universal Joint
- 2pcs 1/2" Dr. Square Socket 8 & 10 mm
- 2pcs 1/2" Bit Holder For 5/16" Bits & For 10mm Bits
- 1pc Magnetic Pick-Up Tool
- 1pc Hammer 300g
- 1pc Locking Pliers 10"
- 1pc Combination Pliers 7"
- 4pcs Screwdrivers:
 - (SL): 6 x 40, 5 x 100 mm (PH): 2 x 40, 1 x 75 mm
- 2pcs Hammer Phillips Screwdrivers
 - (PH): 2 x 100mm & (SL): 6 x 150 mm
- 2pcs Adaptor 3/8"(F) x 1/4"(M) & 1/2"(F) x 3/8"(M)
- 1pc 3-Way Adaptor 3/8"(F) x 1/2"(M)
- 17pcs Combination Wrenches:
 - 6, 7, 8, 9, 10, 11, 12, 13, 14, 15, 16, 17, 18, 19, 21, 22, 24 mm
- 4pcs Flare Nut Wrenches: 8 x 10, 9 x 11, 12 x 13, 14 x 17 mm
- 2pcs Duble Ring Ratchet Wrenches 8 x 10 & 12 x 13mm
- 32pcs 5/16" Dr. x 30 mmL Bits:
 - (Hex): 6, 7, 8, 9, 10, 11, 12, 13, 14, 16
 - (SL): 8, 10, 12 (PH): 2, 3, 4 (PZ): 2, 3, 4
 - (Star): 40, 45, 50, 55, 60
 - (Ribe): 8, 10, 12, 14 (Spline): 6, 8, 10, 12
- 6pcs 10mm x 80mmL Bits:
 - (Hex): 17, 19 (Spline): 14, 16 (TP): 18 (Torx): 70

45215
215 Pcs 1/4" & 3/8" & 1/2" Dr. Tool Set

- 2 SETS/CTN N.W.: 22 KGS G.W.: 23 KGS CUFT: 1.49'

72T

S2

Cr-V

1/4"

6.3mm

3/8"

10mm

1/2"

12.5mm



Gloves



Color Sleeve



Sliding Locks

Contents:

- 13pcs 1/4" Dr. Socket:
 - 4, 4.5, 5, 5.5, 6, 7, 8, 9, 10, 11, 12, 13, 14 mm
- 7pcs 1/4" Dr. Deep Socket: 4, 5, 6, 7, 8, 9, 10 mm
- 5pcs 1/4" Dr. E-Socket: E4, E5, E6, E7, E8
- 1pc 1/4" Dr. Ratchet Handle 72TH
- 1pc 1/4" Dr. Universal Joint
- 1pc 1/4" Dr. Spinner Handle
- 2pcs 1/4" Dr. Extension Bar 2" & 4"
- 1pc 1/4" Dr. Sliding T Bar
- 1pc 1/4" Dr. Coupler
- 30pcs 1/4" Dr. Bits Socket:
 - (Hex): 3, 4, 5, 6 (SL): 4, 5.5, 6.5, 7
 - (PH): 0, 1, 2 (PZ): 0, 1, 2
 - (Torx): 8, 9, 10, 15, 20, 25, 27, 30
 - (TP): 8, 9, 10, 15, 20, 25, 27, 30
- 44pcs 1/4" Dr. Bits:
 - (Hex): 2, 2.5, 3, 4, 5, 6 (Torx): 5, 6, 7 (Torx TP): 7
 - (Spanner): 6, 8, 10 (Keyway): 5, 6, 7, 8, 9
 - (Much Tooth): 5, 6, 8 (Torq): 4, 6, 8, 10
 - (Tri-Wing): 1, 2, 3, 4
 - (Five Star): 10, 15, 20, 25, 27, 30, 40, 45
 - (Square): 0, 1, 2, 3 (Butterfly): 1, 2, 3
- 1pc 1/4" Dr. Screwdriver With Magnet
- 10pcs 3/8" Dr. Socket:
 - 10, 11, 12, 13, 14, 15, 16, 17, 18, 19 mm
- 6pcs 3/8" Dr. Deep Socket: 10, 11, 12, 13, 14, 15 mm
- 6pcs 3/8" Dr. E-Socket: E10, E11, E12, E14, E16, E18
- 1pc 3/8" Dr. Ratchet Handle 72TH
- 1pc 3/8" Dr. Universal Joint
- 1pc 3/8" Dr. Extension Bar 5"
- 1pc 3/8" Dr. Coupler 5/16"
- 1pc 3/8" Dr. Spark Plug Socket 18 mm
- 14pcs 1/2" Dr. Socket:
 - 13, 14, 15, 16, 17, 18, 19, 20, 21, 22, 24, 27, 30, 32 mm
- 5pcs 1/2" Dr. Deep Socket: 16, 17, 18, 19, 22 mm
- 3pcs 1/2" Dr. E-Socket: E20, E22, E24
- 1pc 1/2" Dr. Ratchet Handle 72TH
- 2pcs 1/2" Dr. Extension Bar 5" & 10"
- 1pc 1/2" Dr. Universal Joint
- 1pc 3-Way Adaptor 1/2"(F) x 3/8"(M)
- 2pcs 1/2" Dr. Spark Plug Socket 16 & 21 mm
- 1pc 1/2" Dr. Coupler x 5/16"
- 2pcs 1/2" Bits Socket (Hex): 14 & (Torx): T70
- 7pcs Hex Key Wrenches: 1.27, 1.5, 2, 2.5, 3, 4, 5 mm
- 12pcs Combination Wrenches:
 - 8, 9, 10, 11, 12, 13, 14, 15, 16, 17, 18, 19
- 30pcs Bits 5/16" x 30 mmL:
 - (Hex): 7, 8, 10, 12 (SL): 8, 10, 12
 - (PH): 2, 3, 4 (PZ): 2, 3, 4
 - (Much tooth): 10, 12 (Torx): 40, 45, 50, 55, 60
 - (TP): 40, 45, 50, 55, 60 (Keyway): 10, 11, 12, 13
 - (Five Star): 50
- 1pc Bit Adapter

45218
218 Pcs 1/4" & 3/8" & 1/2" Dr. Tool Set

- 2 SETS/CTN N.W.: 22 KGS G.W.: 23 KGS CUFT: 1.49'

72T

S2

Cr-V

1/4"

6.3mm

3/8"

10mm

1/2"

12.5mm



Gloves



Metallic Locks



Flexible handle



Color Sleeve

Contents:

- 13pcs 1/4" Dr. Socket:
 - 4, 4.5, 5, 5.5, 6, 7, 8, 9, 10, 11, 12, 13, 14 mm
- 7pcs 1/4" Dr. Deep Socket: 4, 5, 6, 7, 8, 9, 10 mm
- 5pcs 1/4" Dr. E-Socket: E4, E5, E6, E7, E8
- 2pcs 1/4" Dr. Extension Bar 2" & 4"
- 1pc 1/4" Dr. Universal Joint
- 1pc 1/4" Dr. Sliding T Bar
- 1pc 1/4" Dr. Spinner Handle
- 30pcs 1/4" Dr. Bits Socket:
 - (Hex): 3, 4, 5, 6 (SL): 4, 5, 5.5, 6, 7
 - (PH): 0, 1, 2 (PZ): 0, 1, 2
 - (Torx): 9, 10, 15, 20, 25, 27, 30
 - (TP): 8, 9, 10, 15, 20, 25, 27, 30
- 44pcs 1/4" Dr. Bits 25mm:
 - (PH): 1, 2, 3 (PZ): 1, 2, 3 (SL): 4, 5, 5.5, 6
 - (Tri-wing): 1, 2, 3, 4 (Torg Set): 6, 8, 10
 - (Square): 1, 2, 3
 - (Spanner): 4, 6, 8, 10 (Hex Security): 3, 4, 5, 6
 - (Ribe): 5, 6, 7, 8, 9 (Spline): 4, 5, 6, 8
 - (TP): 10, 15, 20, 25, 30, 40, 45
- 1pc 1/4" Dr. Flexible Extension Bar 145 mm
- 1pc 1/4" Dr. Magnetic Inhex Spinner
- 1pc 1/4" Dr. Coupler
- 1pc 1/4" Dr. Bit Adapter (30 mmL)
- 1pc 1/4" Dr. Ratchet Handle 72TH
- 24pcs 5/16" Dr. Bits 30 mm:
 - (Hex): 6, 7, 8, 10, 12, 14 (SL): 8, 10, 12 (PH): 2, 3, 4
 - (PZ): 3, 4 (Torx) 40, 45, 50, 55, 60 (TP): 40, 45, 50, 55, 60
- 10pcs 3/8" Dr. Socket:
 - 10, 11, 12, 13, 14, 15, 16, 17, 18, 19 mm
- 6pcs 3/8" Dr. Deep Socket: 10, 11, 12, 13, 14, 15 mm
- 6pcs 3/8" Dr. E-Socket: E10, E11, E12, E14, E16, E18
- 1pc 3/8" Dr. Ratchet Handle 72TH
- 1pc 3/8" Dr. Extension Bar 5"
- 1pc 3/8" Dr. Universal Joint
- 1pc 3/8" Dr. Spark Plug Socket 18 mm
- 1pc 3-Way Adapter 3/8"(F) x 1/2"(M)
- 15pcs 1/2" Dr. Socket: 10, 11, 12, 13, 14, 15, 17, 19, 20, 21, 22, 24, 27, 30, 32 mm
- 5pcs 1/2" Dr. Deep Socket: 16, 17, 18, 19, 22 mm
- 3pcs 1/2" Dr. E-Socket: E20, E22, E24
- 2pcs 1/2" Dr. Spark Plug Socket 16 & 21 mm
- 2pcs 1/2" Dr. Extension Bar 5" & 10"
- 1pc 1/2" Dr. Universal Joint
- 1pc 1/2" Dr. Ratchet Handle 72TH
- 1pc 1/2" Dr. Coupler
- 2pcs 1/2" Dr. Bits Socket (Hex): 14 & (Torx): 70
- 14pcs Combination Wrenches:
 - 7, 8, 9, 10, 11, 12, 13, 14, 15, 16, 17, 18, 19, 21 mm
- 10pcs Hex Key Wrenches:
 - (Hex): 1.27, 1.5, 2, 3, 4, 5, 6 (Torx): 20, 27, 30
- 1pc Adapter 1/2"(F) x 3/8"(M)

6520B1
20 Pcs 3/4" Dr. Socket Set

- 1 SETS/CTN N.W.: 15KGS G.W.: 16KGS CUFT: 0.8'

Cr-V

 3/4"
19mm

Gloves



Color Sleeve

Contents:

- 12pcs 3/4" Dr. Socket: 19, 21, 22, 24, 27, 30, 32, 36, 38, 41, 46, 50mm
- 1pc 3/4" Dr. Ratchet Handle 24TH
- 1pc 3/4" Dr. Sliding T-Bar: 18"
- 1pc 3/4" Dr. L Type Handle: 18"
- 2pcs 3/4" Dr. Extension Bars: 4", 8"
- 1pc 3/4" Dr. Universal Joint
- 1pc Adapter 3/4" (F) x 1/2" (M)
- 1pc Adapter 3/4" (F) x 1" (M)

6520B2
20 Pcs 3/4" Dr. Socket Set

- 1 SETS/CTN N.W.: 15KGS G.W.: 16KGS CUFT: 0.8'

Cr-V

 3/4"
19mm

Gloves



Color Sleeve

Contents:

- 16pcs 3/4" Dr. Socket: 19, 21, 22, 23, 24, 26, 27, 29, 30, 32, 35, 36, 38, 41, 46, 50mm
- 1pc 3/4" Dr. Ratchet Handle 24TH
- 1pc 3/4" Dr. Sliding T Bar 18"
- 2pcs 3/4" Dr. Extension Bar 4", 8"

6321
21 Pcs 3/4" Dr. Spline Socket Set
24T

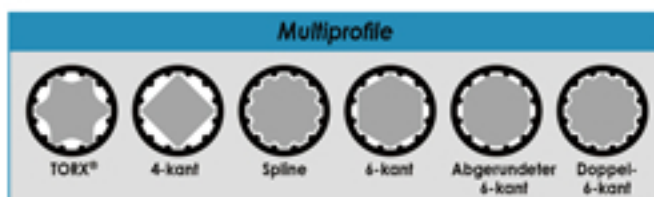
Cr-V
3/4"
19mm

Gloves



Color Sleeve

Contents:

- 16pcs 3/4" Dr. Spline Socket:
19, 21, 22, 23, 24, 26, 27, 29, 30, 32,
35, 36, 38, 41, 46, 50 mm
- 1pc 3/4" Dr. Release Ratchet Handle
- 3pcs 3/4" Dr. Extension Bar 4" & 8" & 16"
- 1pc 3/4" Dr. Sliding T Bar

6324
24 Pcs 3/4" Dr. Spline Socket Set
60T

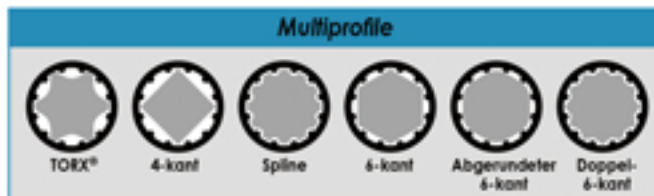
Cr-V
3/4"
19mm

Gloves



Metallic Locks



Flexible handle



Color Sleeve

Contents:

- 16pcs 3/4" Dr. Spline Socket:
19, 21, 22, 23, 24, 26, 27, 29, 30, 32,
35, 36, 38, 41, 46, 50 mm
- 1pc 3/4" Dr. 60TH Quick Release Ratchet Handle
- 1pc 3/4" Dr. Connection Extended Bar
- 3pcs 3/4" Dr. Extension Bar 4" & 8" & 16"
- 1pc 3/4" Dr. Universal Joint
- 1pc 3/4" Dr. Sliding T Bar
- 1pc 3/4" Dr. T Head For Sliding T Bar

The SELTA logo features a stylized red 'S' inside a white circle, followed by the word 'SELTA' in a bold, black, sans-serif font.

SELTA

The background of the advertisement is a vibrant yellow with a repeating pattern of embossed leaf-like shapes. A large, irregular white shape, resembling a torn piece of paper, is centered over the image. The text 'SOCKET SERIES' is printed in white, bold, sans-serif capital letters within this white shape. The background image shows a close-up of a socket set in a black plastic tray. The sockets are arranged in rows, with some numbered (10, 9, 8, 7, 6, 5, 4, 3, 2, 1). A black ratchet handle is visible in the upper left, and a black torque wrench with a red button is in the lower right. The overall aesthetic is industrial and professional.

SOCKET SERIES

2516
16 Pcs 1/4" Dr. Socket Set

 - 10 SET/CTN N.W.: 10.1 KGS
 G.W.: 11.1 KGS CUFT: 0.62'

72T



Cr-V

1/4"

6.3mm

Contents:

- 9pcs 1/4" Dr. Socket :
4, 5, 6, 7, 8, 9, 10, 11, 12 mm
- 1pc 1/4" Dr. Extendable Ratchet Handle 72TH
- 1pc 1/4" Dr. Universal Joint
- 1pc 1/4" Dr. Spinner Handle
- 2pcs 1/4" Dr. Extension Bar 2" & 6"
- 1pc 1/4" Dr. Disc
- 1pc Metal Case

2524
24 Pcs 1/4" Dr. Socket Set

 - 10 SET/CTN N.W.: 17.2 KGS
 G.W.: 18.2 KGS CUFT: 0.57'

72T



Cr-V

1/4"

6.3mm

Contents:

- 9pcs 1/4" Dr. Socket: 4, 5, 6, 7, 8, 9, 10, 11, 12 mm
- 9pcs 1/4" Dr. Deep Socket: 4, 5, 6, 7, 8, 9, 10, 11, 12 mm
- 1pc 1/4" Dr. Ratchet Handle 72TH
- 1pc 1/4" Dr. Universal Joint
- 1pc 1/4" Dr. Spinner Handle
- 2pcs 1/4" Dr. Extension Bar 2" & 6"
- 1pc Metal Case

2926EM
26 Pcs 1/4" Dr. Socket Set (EVA)

Cr-V

1/4"

6.3mm

Contents:

- 13pcs 1/4" Dr. Socket (12pt):
4, 4.5, 5, 5.5, 6, 7, 8, 9, 10, 11, 12, 13, 14mm
- 13pcs 1/4" Dr. Deep Socket (12pt):
4, 4.5, 5, 5.5, 6, 7, 8, 9, 10, 11, 12, 13, 14mm

2527
27 Pcs 1/4" Dr. Socket Set

72T

Cr-V

1/4"

6.3mm

Contents:

- 13pcs 1/4" Dr. Socket:
4, 4.5, 5, 5.5, 6, 7, 8, 9, 10, 11, 12, 13, 14mm
- 9pcs 1/4" Dr. Deep Socket: 6, 7, 8, 9, 10, 11, 12, 13, 14mm
- 1pc 1/4" Dr. Universal Joint
- 3pcs 1/4" Dr. Wobble Extension Bar 2" & 3" & 6"
- 1pc 1/4" Dr. Ratchet Handle 48TH

2546M
46 Pcs 1/4" Dr. Socket Set
72T
Cr-V
1/4"
6.3mm

Contents:

- 13pcs 1/4" Dr. Socket:
 - 4, 4.5, 5, 5.5, 6, 7, 8, 9, 10, 11, 12, 13, 14mm
- 9pcs 1/4" Dr. Socket: 6, 7, 8, 9, 10, 11, 12, 13, 14mm
- 18pcs 1/4" Dr. Bits Socket:
 - (PH): 1, 2, 3 (PZ): 1, 2 (Hex): 3, 4, 5, 6, 7, 8
 - (SL): 5.5 (Torx): 10, 15, 20, 25, 30, 40
- 1pc 1/4" Dr. Spinner Handle
- 1pc 1/4" Dr. Universal Joint
- 2pcs 1/4" Dr. Wobble Extension Bar 2" & 4"
- 1pc 1/4" Dr. Sliding T Bar 110mm
- 1pc 1/4" Dr. Ratchet Handle

3516
16 Pcs 3/8" Dr. Socket Set

- 10 SET/CTN N.W.: 17.2 KGS

G.W.: 18.2 KGS CUFT: 0.57'

72T
Cr-V
3/8"
10mm

Contents:

- 10pcs 3/8" Dr. Socket :
 - 10, 11, 12, 13, 14, 15, 16, 17, 19, 22 mm
- 1pc 3/8" Dr. Extendable Ratchet Handle 72TH
- 2pcs 3/8" Dr. Extension Bar 3" & 6"
- 2pcs 3/8" Dr. Spark Plug Socket 16 & 21 mm
- 1pc Metal Case

3520
20 Pcs 3/8" Dr. Tool Set

- 10 SETS/CTN N.W.: 25 KGS

G.W.: 26 KGS CUFT: 0.84'

72T
Cr-V
3/8"
10mm

Gloves

Contents:

- 13pcs 3/8" Dr. Socket:
 - 6, 7, 8, 9, 10, 11, 12, 13, 14, 17, 19, 21, 22 mm
- 1pc 3/8" Dr. Ratchet Handle 72TH
- 1pc 3/8" Dr. Sliding T Bar 8"
- 2pcs 3/8" Dr. Extension Bar 3" & 6"
- 1pc 3/8" Dr. Flexible Handle 8"
- 1pc 3/8" Dr. Spark Plug Socket 21 mm
- 1pc 3/8" Dr. Universal Joint

6933EM
33 Pcs 3/8" Dr. Socket Set (EVA)

- 4 SETS/CTN N.W.: 24 KGS

G.W.: 25 KGS CUFT: 0.9'

Cr-V
3/8"
10mm

Contents:

- 19pcs 3/8" Dr. Socket (12pt): 6, 7, 8, 9, 10, 11, 12, 13, 14, 15, 16, 17, 18, 19, 20, 21, 22, 23, 24mm
- 14pc 3/8" Dr. Deep Socket (12pt):
 - 6, 7, 8, 9, 10, 11, 12, 13, 14, 15, 16, 17, 18, 19mm

3535
35 Pcs 3/8" Dr. Tool Set

 - 4 SETS/CTN N.W.: 24 KGS
 G.W.: 25 KGS CUFT: 0.9'

72T

Cr-V

 3/8"
 10mm

Gloves

Contents:

- 17pcs 3/8" Dr. Socket:
6, 7, 8, 9, 10, 11, 12, 13, 14, 15, 16,
17, 18, 19, 20, 21, 22 mm
- 1pc 3/8" Dr. Ratchet Handle 72TH
- 3pcs 3/8" Dr. Extension Bar: 3", 6", 10"
- 1pc 3-Way Adaptor 1/2"(F) x 3/8"(M)
- 1pc 3/8" Dr. Universal Joint
- 2pcs 3/8" Dr. Spark Plug Socket 16 & 21 mm
- 10pcs Combination Wrenches:
8, 10, 11, 12, 13, 14, 15, 16, 17, 19 mm

6538
38 Pcs 3/8" Dr. Tool Set

 - 4 SETS/CTN N.W.: 24 KGS
 G.W.: 25 KGS CUFT: 0.9'

72T

Cr-V

 3/8"
 10mm

Contents:

- 18pcs 3/8" Dr. Socket: 6, 7, 8, 9, 10, 11, 12, 13, 14, 15,
16, 17, 18, 19, 20, 21, 22, 24mm
- 14pcs 3/8" Dr. Deep Socket:
6, 7, 8, 9, 10, 11, 12, 13, 14, 15, 16, 17, 18, 19mm
- 3pcs 3/8" Dr. Wobble Extension Bar 2" & 4" & 8"
- 1pc 3/8" Dr. Universal Joint
- 1pc 3/8" Dr. Ratchet Handle 72TH
- 1pc 3-Way Adapter 1/2"(F) x 3/8"(M)

4614S
14 Pcs 1/2" Dr. Star Socket Set

 - 2 SETS/CTN N.W.: 17 KGS
 G.W.: 18 KGS CUFT: 1.04'

S2

Cr-V

 1/2"
 12.5mm

Contents:

- 1/2" Dr. Star Socket: E10, E12, E14, E16, E18, E20
- Star Bit 30mmL: T25, T27, T30, T40, T45, T50, T55
- 1pc 1/2" Dr. Coupler

4514DA/4914D
14 Pcs 1/2" Dr. Deep Socket Set

 - 6 SETS/CTN N.W.: 20.5 KGS
 G.W.: 21.5 KGS CUFT: 0.66'

Cr-V

 1/2"
 12.5mm

- 4514D 6pt(Deep) & 4914D 12pt(Deep)

- Size:
8, 10, 12, 13, 14, 15, 17, 19, 21, 22,
24, 27, 30, 32 mm

4616
16 Pcs 1/2" Dr. Star Socket Set

 - 10 SETS/CTN N.W.: 16 KGS
 G.W.: 16.6 KGS CUFT: 0.54'

Cr-V

 1/2"
 12.5mm

Contents:

- Star Socket:
E10, E11, E12, E14, E16, E18, E20, E22, E24
- Star Bits Socket 55mmL:
T30, T40, T45, T50, T55, T60, T70

4522
22 Pcs 1/2" Dr. Socket Set

72T

Cr-V

 1/2"
 12.5mm

Contents:

- 16pcs 1/2" Dr. Socket: 10, 11, 12, 13, 14, 15, 16, 17, 18, 19, 21, 22, 24, 27, 31, 32, mm
- 1pc 1/2" Dr. Ratchet Handle 72TH
- 1pc 1/2" Dr. Universal Joint
- 1pc 1/2" Dr. Flexible Handle 15"
- 2pcs 1/2" Dr. Wobble Extension Bar 5" & 10"
- 1pc 3-Way Adapter 3/8(F)" x 1/2"(M)

4524/4524SAE/4924
24 Pcs 1/2" Dr. Socket Set / 24 Pcs 1/2" Dr. Socket Set(SAE)

- 4 SETS/CTN N.W.: 20KGS G.W.: 21KGS CUFT:0.81'

72T



Cr-V

 1/2"
 12.5mm

Gloves

4524 (6pt) & 4924 (12pt) Contents:

- 18pcs 1/2" Dr. Socket:
8, 9, 10, 11, 12, 13, 14, 15, 16, 17, 18, 19, 21, 22, 24, 27, 30, 32 mm
- 1pc 1/2" Dr. Ratchet Handle 72TH
- 1pc 1/2" Dr. Universal Joint
- 1pc 1/2" Dr. Sliding T Bar 10"
- 2pcs 1/2" Dr. Extension Bar 5" & 10"
- 1pc 1/2" Dr. Spark Plug Socket 21 mm

4524SAE (6pt) Contents:

- 18pcs 1/2" Dr.Socket:
5/16", 3/8", 7/16", 1/2", 9/16", 19/32", 5/8", 11/16", 3/4", 25/32", 13/16", 7/8", 15/16", 1", 1-1/16", 1-1/8", 1-3/16", 1-1/4"
- 1pc 1/2" Dr. Ratchet Handle 72TH
- 1pc 1/2" Dr. Universal Joint
- 1pc 1/2" Dr. Sliding T Bar 10"
- 2pcs 1/2" Dr. Extension Bar 5" & 10"
- 1pc 1/2" Dr. Spark Plug Socket 21 mm

4524A
24 Pcs 1/2" Dr. Socket Set (With Speedy Handle)

- 4SETS/CTN N.W.: 22.5KGS G.W.: 23.5KGS CUFT: 0.9

72T



Cr-V

1/2"

12.5mm

Contents:

- 18pcs 1/2" Dr. Socket: 10, 11, 12, 13, 14, 15, 16, 17, 18, 19, 20, 21, 22, 23, 24, 27, 30, 32 mm
- 2pcs 1/2" Dr. Extension Bar 5" & 10"
- 1pc 1/2" Dr. Sliding T Bar 10"
- 1pc 1/2" Dr. Universal Joint
- 1pc 1/2" Dr. Speeding Handle
- 1pc 1/2" Dr. Ratchet Handle 72TH



Gloves

4524-BM
24 Pcs 1/2" Dr. Socket Set With Flexible Handle (Black Matt Finish)

- 1 SET/CTN N.W.: 13.4KGS G.W.: 14.5KGS CUFT:0.28'

72T



Cr-V

1/2"

12.5mm

Contents:

- 18pc 1/2" Dr. Socket : 10, 11, 12, 13, 14, 15, 16, 17, 18, 19, 20, 21, 22, 23, 24, 27, 30, 32mm
- 2pcs 1/2" Dr. Extension Bar 5" & 10"
- 1pc 1/2" Dr. Sliding T Bar 10"
- 1pc 1/2" Dr. Ratchet Handle 72TH
- 1pc 1/2" Dr. Flexible Handle
- 1pc 1/2" Dr. Universal Joint



Gloves

4524S-BM
24 Pcs 1/2" Dr. Socket Set With Speeding Handle 6PT (Black Matt Finish)

- 1 SET/CTN N.W.: 13.4KGS G.W.: 14.5KGS CUFT:0.28'

72T



Cr-V

1/2"

12.5mm

Contents:

- 18pc 1/2" Dr. Socket : 10, 11, 12, 13, 14, 15, 16, 17, 18, 19, 20, 21, 22, 23, 24, 27, 30, 32mm
- 2pcs 1/2" Dr. Extension Bar 5" & 10"
- 1pc 1/2" Dr. Sliding T Bar 10"
- 1pc 1/2" Dr. Ratchet Handle 72TH
- 1pc 1/2" Dr. Speeding Handle
- 1pc 1/2" Dr. Universal Joint



Gloves

4524B
25 Pcs 1/2" Dr. Socket Set (With Flexible Handle)

- 4SETS/CTN N.W.: 22.5KGS G.W.: 23.5KGS CUFT: 0.9

72T



Cr-V

1/2"

12.5mm



Gloves

Contents:

- 18pcs 1/2" Dr. Socket: 8, 9, 10, 11, 12, 13, 14, 15, 16, 17, 18, 19, 21, 22, 24, 27, 30, 32mm
- 1pc 1/2" Dr. Ratchet Handle 72TH
- 1pc 1/2" 3 Way Adaptor 3/8"(F) x 1/4"(M)
- 1pc 1/2" Dr. Flexible Handle
- 1pc 1/2" Dr. Universal Joint
- 2pcs 1/2" Dr. Extension Bar 5", 10"
- 1pc 1/2" Dr. Spark Plug Socket 21mm

4927
27 Pcs 1/2" Dr. Socket Set

72T

Cr-V

1/2"

12.5mm

Contents:

- 20pcs 1/2" Dr. Socket: 8, 9, 10, 11, 12, 13, 14, 15, 16, 17, 18, 19, 21, 22, 24, 27, 30, 32, 34, 36mm
- 3pcs 1/2" Dr. Wobble Extension Bar 2" & 5" & 10"
- 1pc 1/2" Dr. Universal Joint
- 1pc 1/2" Dr. Ratchet Handle 48TH
- 1pc Dr. 3-Way Adapter 3/8"(F) x 1/2"(M)
- 1pc 1/2" Dr. Breaker Bar

4528
28 Pcs 1/2" Dr. Socket Set

72T

Cr-V

1/2"

12.5mm

Contents:

- 18pcs 1/2" Dr. Socket: 10, 11, 12, 13, 14, 15, 16, 17, 18, 19, 21, 22, 24, 27, 30, 32, 34, 36mm
- 4pcs 1/2" Dr. Deep Socket: 10, 13, 17, 19mm
- 2pcs 1/2" Dr. Spark Plug Socket 16, 21mm
- 2pcs 1/2" Dr. Wobble Extension Bar 5" & 10"
- 1pc 1/2" Dr. Universal Joint
- 1pc 1/2" Dr. Ratchet Handle 48TH
- 1pc 3-Way Adapter 3/8"(F) x 1/2"(M)

4541
41 Pcs 1/2" Dr. Socket Set

- 4 SETS/CTN N.W.: 28.5 KGS G.W.: 29.5 KGS CUFT: 0.81

72T

Cr-V

1/2"

12.5mm



Gloves

Contents:

- 20pcs 1/2" Dr. 6PT Socket: 8, 9, 10, 11, 12, 13, 14, 15, 16, 17, 18, 19, 20, 21, 22, 23, 24, 27, 30, 32 mm
- 14pcs 1/2" Dr. 6PT Socket: 3/8", 7/16", 1/2", 9/16", 5/8", 11/16", 3/4", 7/8", 13/16", 15/16", 1", 1-1/16", 1-1/8", 1-3/16"
- 1pc 1/2" Dr. Extendable Ratchet Handle 72TH
- 2pcs 1/2" Dr. Extension Bar 5" & 10"
- 2pcs 1/2" Dr. Spark Plug Socket 16 & 21 mm
- 1pc 1/2" Dr. Universal Joint
- 1pc 1/2" Dr. Sliding T Bar 10"

3540
40 Pcs 1/4" & 3/8" Dr. Socket Set

- 10 SET/CTN N.W.: 22 KGS G.W.: 23 KGS CUFT: 1.06

72T

Cr-V

1/4"

6.3mm

3/8"

10mm



Gloves

Contents:

- 9pcs 1/4" Dr. Socket: 4.5, 5, 6, 7, 8, 9, 10, 11, 12 mm
- 9pcs 1/4" Dr. Socket: 3/16", 7/32", 1/4", 9/32", 5/16", 11/32", 3/8", 7/16", 1/2"
- 9pcs 3/8" Dr. Socket: 9, 10, 11, 12, 13, 14, 16, 17, 19mm
- 7pcs 3/8" Dr. Socket: 3/8", 7/16", 1/2", 9/16", 5/8", 11/16", 3/4"
- 1pc 3/8" Dr. Extension Bar 3"
- 1pc 1/4" Dr. 3-Way Spinner Handle
- 1pc 3/8" Dr. Ratchet Handle 72TH
- 1pc 3-Way Adaptor 3/8"(F) x 1/4"(M)
- 1pc 3/8" Dr. Spark Plug Socket 21 mm

6515/6915
15 Pcs 3/4" Dr. Metal Set

- 1 SET/CTN N.W.: 13.4KGS G.W.: 14.5KGS CUFT:0.28'

Cr-V

3/4"

19mm



Gloves

To Be Used With A Socket Containing A Pin
Contents:

- 6515 6pt & 6915 12pt
- 10pcs 3/4" Dr.Socket: 22, 24, 27, 30, 32, 36, 38, 41, 46, 50 mm
- 2pcs 3/4" Dr. Extension Bars: 8", 16"
- 1pc 3/4" Dr. Universal Joint
- 1pc 3/4" Dr. Ratchet Handle 72TH
- 1pc 3/4" Dr. Sliding T-Bar: 18"

6516
16 Pcs 3/4" Dr. Socket Set

- 1 SETS/CTN N.W.: 10.5 KGS G.W.: 11.5 KGS CUFT: 0.3'

Contents:

- 13pcs 3/4" Dr. Socket: 17, 19, 21, 24, 27, 30, 32, 33, 36, 38, 41, 46, 50 mm
- 1pc 3/4" Dr. Ratchet Handle 24TH
- 1pc 3/4" Dr. Extension Bar 200 mm
- 1pc 3/4" Dr. Sliding T Bar 18"



Gloves

6517
17 Pcs 3/4" Dr. Socket Set

- 1 SETS/CTN N.W.: 14KGS G.W.: 15KGS CUFT: 0.35'

Contents:

- 12pcs 3/4" Dr. Socket: 21, 22, 23, 24, 27, 30, 32, 36, 38, 41, 46, 50mm
- 1pc 3/4" Dr. Ratchet Handle 24TH
- 1pc 3/4" Dr. Sliding T-Bar: 18"
- 1pc 3/4" Dr. Flexible Handle: 19"
- 2pcs 3/4" Dr. Extension Bars: 8", 16"



Gloves

6520
20 Pcs 3/4" Dr. Socket Set

- 1 SETS/CTN N.W.: 12.8KGS G.W.: 13.3KGS CUFT: 0.29'

Contents:

- 16pcs 3/4" Dr. Socket: 19, 22, 23, 24, 25, 26, 27, 29, 30, 32, 35, 36, 38, 41, 46, 50 mm
- 1pc 3/4" Dr. Ratchet Handle 24TH
- 1pc 3/4" Dr. Sliding T-Bar: 18"
- 2pcs 3/4" Dr. Extension Bars: 4", 8"



Gloves

6524/6924
24 Pcs 3/4" Dr. Socket Set

- 1 SETS/CTN N.W.: 15.5 KGS G.W.: 16.5 KGS CUFT: 0.39'

Contents:

- 6524 6pt , 6924 12pt
- 16pcs 3/4" Dr. Socket:
17, 19, 21, 22, 24, 27, 30, 32, 33, 34,
35, 36, 38, 41, 46, 50 mm
- 1pc 3/4" Dr. Ratchet Handle 24TH
- 1pc 3/4" Dr. Universal Joint
- 1pc 3/4" Dr. Sliding T Bar 18"
- 3pcs 3/4" Dr. Extension Bar: 100, 200, 400 mm
- 2pcs Adaptor 3/4"(F) x 1/2"(M) & 3/4"(F) x 1"(M)

6913
13 Pcs 1" Dr. Metal Set (12PT)

- 1 SET/CTN N.W.: 21.9 KGS G.W.: 22.9 KGS CUFT: 2'

Contents:

- 18pcs 1" Dr.Short Socket 12pt:
36, 41, 46, 50, 55, 60, 65, 70mm
- 2pcs 1" Dr. Extension Bar: 8", 16"
- 1pc 1" Dr. Ratchet Head
- 1pc 1" Dr. Sliding T Bar
- 1pc 1" Dr. Sliding T Head

8914
15 Pcs 1" Dr. Socket Set

- 1 SET/CTN N.W.: 26.5 KGS G.W.: 27.5 KGS CUFT: 0.66'

Contents:

- 10pcs 1" Dr. 12pt Socket:
36, 41, 46, 50, 55, 60, 65, 70, 75, 80 mm
- 1pc 1" Dr. Ratchet Handle 24TH
- 1pc 1" Dr. Handle Bar 550 mL
- 1pc Adaptor
- 1pc 1" Dr. Extension Bar 8"
- 1pc 1" Dr. Extension Bar 16"

8522
22 Pcs 1" Dr. Socket Set

- 1 SET/CTN N.W.: 40 KGS G.W.: 41 KGS CUFT: 1.2'

Cr-V

 1"
25mm

Gloves

Contents:

- 17pcs 1" Dr. Socket:
36, 38, 41, 46, 50, 54, 55, 58, 60,
63, 65, 67, 70, 71, 75, 77, 80 mm
- 1pc 1" Dr. Ratchet Handle 24TH
- 1pc 1" Dr. Universal Handle
- 1pc 1" Dr. Sliding T Head
- 2pcs 1" Dr. Extension Bar 8" & 16"

54926
26 Pcs 1/2" Dr. Spline Bits Socket Set

- 4 SETS/CTN N.W.: 19.6KGS G.W.: 20.6KGS CUFT: 1.5'

 CR
MO

Cr-V

 1/2"
12.5mm

Contents:

- 26pcs 1/2" Dr. Bits Socket:
55mmL: M5, M6, M8, M9, M10, M12, M14, M16
100mmL: M5, M6, M8, M9, M10, M12, M14
140mmL: M5, M6, M8, M9, M10, M12, M14
200mmL: M8, M10, M12, M14



Sliding Locks

54430
30 Pcs 1/2" Dr. Hex Bits Socket Set

- 4 SETS/CTN N.W.: 19.6KGS G.W.: 20.6KGS CUFT: 1.5'

 CR
MO

Cr-V

 1/2"
12.5mm

Contents:

- 30pcs 1/2" Dr. Bits Socket:
55mmL: H5, H6, H7, H8, H10, H12, H14, H17, H19
100mmL: H5, H6, H7, H8, H10, H11, H12, H13
140mmL: H5, H6, H7, H8, H10, H12, H14
200mmL: H5, H6, H7, H8, H10, H12



Sliding Locks

54632
32 Pcs 1/2" Dr. Torx Bits Socket Set

- 4 SETS/CTN N.W.: 19.6KGS G.W.: 20.6KGS CUFT: 1.5'

 CR
MO

Cr-V

 1/2"
12.5mm

Sliding Locks

Contents:

- 32pcs 1/2" Dr. Bits Socket:

55mmL:T20, T25, T27, T30, T40, T45, T50, T55, T60, T70

100mmL:T20, T25, T27, T30, T40, T45, T50, T55, T60, T70

140mmL:T40, T45, T50, T55, T60, T70

200mmL:T40, T45, T50, T55, T60, T70

3106
6 Pcs 3/8" Dr. Spark Plug Socket

- 72mmL (Flexible Joint)

 3/8"
10mm

Color Sleeve

Contents:

- 6 Pcs 3/8" Dr. Spark Plug Socket:

8, 9, 10, 12, 14, 16 mm

Cr-V Steel Material, 72 mmL

3106L
6 Pcs 3/8" Dr. Spark Plug Socket

- 158mmL

 3/8"
10mm

Color Sleeve

Contents:

- 6 Pcs 3/8" Dr. Spark Plug Socket:

8, 9, 10, 12, 14, 16 mm

Cr-V Steel Material, 158 mmL

65918
18 Pcs 3/8" Sq. Drive Oil Drain Plug Key Set

 3/8"
10mm

Color Sleeve

Contents:

- Manufactured From High Quality Chrome Vanadium Steel With Satin Chrome Finished

- Suitable For Sump Plugs On Engine, Gearbox And Back Axle

- Specifications:

- 1pc Sliding T-Bar

- 6pcs Hex: 8, 9, 10, 12, 14, 17mm

- 9pcs Square: 7, 8, 10, 11, 12, 13, 14mm, 5/16" & 3/8"

- 1pc Female Square: 10mm

- 1pc Triangular: 10mm

54408
8 Pcs 1/2" Dr. Bits Socket Set (Hex) 110mmL

 - 12 SETS/CTN N.W.: 15.7 KGS
 G.W.: 16.7 KGS CUFT: 0.57'

Color Sleeve

Contents:

 - 8pcs 1/2" Dr. Bits Socket:
 (Hex) 110mmL: 5, 6, 7, 8, 10, 12, 14, 17 mm

54411
11 Pcs 1/2" Dr. Bits Socket Set (Hex) 55mmL

 - 12 SETS/CTN N.W.: 17.2 KGS
 G.W.: 18.2 KGS CUFT: 0.57'

Color Sleeve

Contents:

 - 11pcs 1/2" Dr. Bits Socket:
 (Hex) 55mmL: 5, 6, 7, 8, 10, 12, 14, 16, 17, 18, 19 mm

54609
9 Pcs 1/2" Dr. Bits Socket Set (Torx) 55mmL

 - 12 SETS/CTN N.W.: 11.9 KGS
 G.W.: 12.9 KGS CUFT: 0.57'

Color Sleeve

Contents:

 - 9pcs 1/2" Dr. Bits Socket:
 (Torx) 55mmL:
 T20, T25, T27, T30, T40, T45, T50, T55, T60

54609L
9 Pcs 1/2" Dr. Bits Socket Set (Torx) 100mmL

 - 12 SETS/CTN N.W.: 9.9 KGS
 G.W.: 10.9 KGS CUFT: 0.57'

Color Sleeve

Contents:

 - 9pcs 1/2" Dr. Bits Socket:
 (Torx) 100mmL:
 T20, T25, T27, T30, T40, T45, T50, T55, T60

54709LTH
9 Pcs 1/2" Dr. Bits Socket Set (Torx Tamperproof) 100mmL

 - 12 SETS/CTN N.W.: 9.9 KGS
 G.W.: 10.9 KGS CUFT: 0.57'

 CR
 MO

Cr-V

 1/2"
 12.5mm

Color Sleeve

Contents:

- 9pcs 1/2" Dr. Bits Socket: (TP) 100mmL: TP20, TP25, TP27, TP30, TP40, TP45, TP50, TP55, TP60

54806
6 Pcs 1/2" Dr. Bits Socket Set (Spline) 100mmL

 - 12 SETS/CTN N.W.: 10.9 KGS
 G.W.: 11.9 KGS CUFT: 0.57'

 CR
 MO

Cr-V

 1/2"
 12.5mm

Color Sleeve

Contents:

- 6pcs 1/2" Dr. Bits Socket: (Spline) 100mmL: M5, M6, M8, M10, M12, M14

65906
6 Pcs Adapter Set

- 30 SETS/CTN N.W.: 16 KGS G.W.: 17 KGS CUFT: 1'

Cr-V

 1/4"
 6.3mm

 3/8"
 10mm

 1/2"
 12.5mm

 3/4"
 19mm

Color Sleeve

Contents:

- Adapter 1/4"(F) x 3/8" (M)
- Adapter 3/8"(F) x 1/4" (M)
- Adapter 3/8"(F) x 1/2" (M)
- Adapter 1/2"(F) x 3/8" (M)
- Adapter 1/2"(F) x 3/4" (M)
- Adapter 3/4"(F) x 1/2" (M)

65912
12 Pcs Adapter Set

- 12 SETS/CTN N.W.: 9 KGS G.W.: 10 KGS CUFT: 0.81'

Cr-V

 1/4"
 6.3mm

 3/8"
 10mm

 1/2"
 12.5mm

 3/4"
 19mm

Color Sleeve

Contents:

- Adapter 1/4"(F) x 3/8" (M) - Coupler 1/4" x 1/4"
- Adapter 3/8"(F) x 1/4" (M) - Coupler 3/8" x 5/16"
- Adapter 3/8"(F) x 1/2" (M) - Coupler 1/2" x 10mm
- Adapter 1/2"(F) x 3/8" (M) - Bit Extension Bar 1/4" x 1/4" 65L
- Adapter 1/2"(F) x 3/4" (M) - Bit Extension Bar 3/8" x 1/4" 65L
- Adapter 3/4"(F) x 1/2" (M) - Bit Extension Bar 1/2" x 1/4" 72L

4512/4912 12 Pcs 1/2" Dr. Socket Set

- 10 SET/CTN N.W.: 9 KGS
G.W.: 10 KGS CUFT: 0.56'



- 4512 6pt & 4912 12pt
- Size:
10, 11, 12, 13, 14, 15, 16, 17, 18, 19, 22, 24 mm

4516/4916 16 Pcs 1/2" Dr. Socket Set

- 10 SET/CTN N.W.: 16.1 KGS
G.W.: 17.1 KGS CUFT: 0.87'



- 4516 6pt & 4916 12pt
- Size:
10, 11, 12, 13, 14, 15, 16, 17, 18, 19, 21, 22,
24, 27, 30, 32 mm

4607 7 Pcs 1/2" Dr. E-Socket Set

- 40 SET/CTN N.W.: 19.6 KGS
G.W.: 20.8 KGS CUFT: 1.34'



- Size: E10, E12, E14, E16, E18, E20, E22

4608 8 Pcs 1/2" Dr. Deep E-Socket Set

- 10 SET/CTN N.W.: 11.3 KGS
G.W.: 12.1 KGS CUFT: 0.53'



- Size: E10, E11, E12, E14, E16, E18, E20, E24

4609E 9 Pcs 1/2" Dr. E-Socket Set

- 20 SET/CTN N.W.: 13.6 KGS
G.W.: 14.6 KGS CUFT: 0.75'



- Size: E10, E11, E12, E14, E16, E18, E20, E22, E24

4614 14 Pcs 1/4" & 3/8" & 1/2" Dr. E-Socket Set

- 24 SET/CTN N.W.: 15.4 KGS
G.W.: 16.4 KGS CUFT: 0.94'



- 1/4": E4, E5, E6, E7, E8
- 3/8": E10, E11, E12, E14
- 1/2": E16, E18, E20, E29, E24

2510D/2910D

10 Pcs 1/4" Dr. Deep Socket Set

- 40 SET/CTN N.W.: 16 KGS
G.W.: 17 KGS CUFT: 1.14'



- 2510D 6pt & 2910D 12pt
- Size: 5, 6, 7, 8, 9, 10, 11, 12, 13, 14mm

2511/2911

11 Pcs 1/4" Dr. Socket Set

- 80 SET/CTN N.W.: 15.6 KGS
G.W.: 16.6 KGS CUFT: 1.15'



- 2511 6pt & 2911 12pt
- Size: 4, 5, 5.5, 6, 7, 8, 9, 10, 11, 12, 13mm

2511D/2911D

11 Pcs 1/4" Dr. Deep Socket Set

- 40 SET/CTN N.W.: 16.8 KGS
G.W.: 17.8 KGS CUFT: 1.14'



- 2511D 6pt & 2911D 12pt
- Size: 4, 5, 6, 7, 8, 9, 10, 11, 12, 13, 14mm

3511/3911

11 Pcs 3/8" Dr. Socket Set

- 40 SET/CTN N.W.: 19.2 KGS
G.W.: 20.2 KGS CUFT: 1.59'



- 3511 6pt & 3911 12pt
- Size: 8, 10, 11, 12, 13, 14, 15, 16, 17, 18, 19mm

3610
10 Pcs 1/4" & 3/8" Dr. E-Socket Set

 - 40 SET/CTN N.W.: 10.8 KGS
 G.W.: 11.8 KGS CUFT: 0.68'

- 1/4": E4, E5, E6, E7, E8
- 3/8": E10, E12, E14, E16, E18

3510D/3910D
10 Pcs 3/8" Dr. Deep Socket Set

 - 20 SET/CTN N.W.: 19.5 KGS
 G.W.: 20.5 KGS CUFT: 0.81'

- 3510D 6pt & 3910D 12pt
- Size:
8, 10, 12, 13, 14, 15, 16, 17, 18, 19mm

4510D/4910D
10 Pcs 1/2" Dr. Deep Socket Set

 - 10 SET/CTN N.W.: 14.7 KGS
 G.W.: 15.7 KGS CUFT: 0.61'

- 4510D 6pt & 4910D 12pt
- Size:
10, 11, 12, 13, 14, 17, 19, 21, 22, 24mm

2109ST

9 Pcs 1/4" Dr. Torx Tamperproof Bits Socket Set

- 40 SET/CTN N.W.: 7.2 KGS
G.W.: 8.2 KGS CUFT: 0.74'



- Size: TP10, TP15, TP20, TP25, TP27, TP30, TP40, TP45, TP50

3008H

8 Pcs 3/8" Dr. Hex Bits Socket Set

- 40 SET/CTN N.W.: 15.2 KGS
G.W.: 16.2 KGS CUFT: 0.9'



- Size: H3, H4, H5, H6, H7, H8, H9, H10

4009H

9 Pcs 1/2" Dr. Hex Bits Socket Set

- 20 SET/CTN N.W.: 16 KGS
G.W.: 17 KGS CUFT: 0.7'



- Size: H4, H5, H6, H7, H8, H9, H10, H12, H14

4109T

9 Pcs 1/2" Dr. Torx Bits Socket Set

- 10 SET/CTN N.W.: 13.4 KGS
G.W.: 14.4 KGS CUFT: 0.7'



- Size: T20, T25, T27, T30, T40, T45, T50, T55, T60

54709TH

9 Pcs 1/2" Dr. Torx Tamperproof Bit Socket Set

- 20 SET/CTN N.W.: 13 KGS
G.W.: 14 KGS CUFT: 0.7'

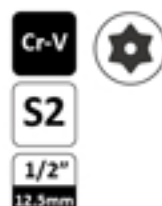

- Size: TP20, TP25, TP27, TP30, TP40, TP45, TP50, TP55, TP60

54807

7 Pcs 1/2" Dr. Spline Bit Socket Set

- 20 SET/CTN N.W.: 12.3 KGS
G.W.: 13.3 KGS CUFT: 0.62'



- Size: M5, M6, M8, M10, M12, M14, M16

2511LH/2911LH

11 Pcs 1/4" Dr. Socket Set



72T

Cr-V

1/4"
6.3mm

- 2511LH 6pt & 2911LH 12pt
- 1/4" Dr. Socket 5, 6, 7, 8, 9, 10, 11, 12, 13, 14mm
- 1/4" Dr. Ratchet Handle 72TH

2515MS/2915MS

15 Pcs 1/4" Dr. Socket Set (In Hanger)

- 40 SETS/CTN N.W.: 17.5 KGS
G.W.: 18.5 KGS CUFT: 1.05'



72T

Cr-V

1/4"
6.3mm

- 2515MS 6pt & 2915MS 12pt
- Socket:
4, 4.4, 5, 5.5, 6, 7, 8, 9, 10, 11, 12, 13, 14, mm
- Extension Bar 100mm
- 1/4" Dr. Ratchet Handle 72TH

2528MS/2928MS

28 Pcs 1/4" Dr. Socket Set(In Hanger)

- 20 SETS/CTN N.W.: 14.1 KGS
G.W.: 15.1 KGS CUFT: 1.05'



72T

Cr-V

1/4"
6.3mm

- 2528MS 6pt & 2928MS 12pt
- Socket: 4, 5, 5.5, 6, 7, 8, 9, 10, 11, 12, 13, 14, mm
- Extension Bar 100mm
- 1/4" Bit Socket:
(Hex): 3, 4, 5, 6 (SL): 4, 5.5, 7
(PH): 1, 2 (Torx): 10, 15, 20, 25, 30
- 1/4" Dr. Ratchet Handle 72TH

3510LH/3910LH

10 Pcs 3/8" Dr. Socket Set



72T

Cr-V

3/8"
10mm

- 3510LH 6pt & 3910LH 12pt
- 3/8" Dr. Socket 10, 11, 12, 13, 14, 15, 16, 17, 18mm
- 3/8" Dr. Ratchet Handle 72TH

3519MS/3919MS
19 Pcs 3/8" Dr. Socket Set

- 3519MS 6pt & 3919MS 12pt
- 3/8" Dr. Socket 6, 7, 8, 9, 10, 11, 12, 13, 14, 15, 16, 17, 18, 19, 21, 22, 24mm
- 3/8" Dr. Ratchet Handle 72TH
- 3/8" Dr. Extension Bar 3"

4511LH/4911LH
11 Pcs 1/2" Dr. Socket Set

- 4511LH 6pt & 4911LH 12pt
- 1/2" Dr. Socket 9, 10, 11, 12, 13, 14, 15, 17, 18, 19mm
- 1/2" Dr. Ratchet Handle 72TH

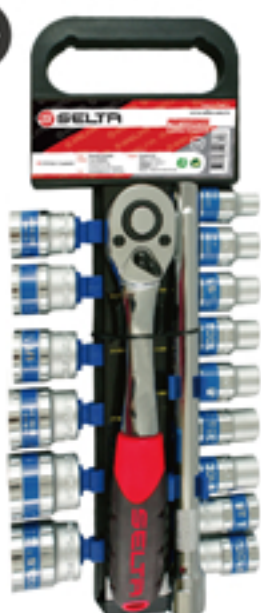
4517MS/4917MS
17 Pcs 1/2" Dr. Socket Set

- 4517MS 6pt & 4917MS 12pt
- 1/2" Dr. Socket 8, 10, 11, 12, 13, 14, 15, 17, 19, 20, 22, 24, 27, 30, 32mm
- 1/2" Dr. Ratchet Handle 72TH
- 1/2" Dr. Extension Bar 10"

4520MS/4920MS
20 Pcs 1/2" Dr. Socket Set (In Hanger)

 - 10 SETS/CTN N.W.: 24.5 KGS
 G.W.: 25 KGS CUFT: 1.16'

- 4520MS 6pt & 4920MS 12pt
- Size:
Sockets: 8, 9, 10, 11, 12, 13, 14, 15, 16, 17, 19, 21, 22, 23, 24, 27, 30, 32mm
- Extension Bar 125mm
- 1/2" Dr. Ratchet Handle 72TH

3526MS/3926MS

26 Pcs 1/4" & 3/8" Dr. Socket Set (In Hanger)

- 10 SETS/CTN N.W.: 12 KGS
G.W.: 13 KGS CUFT: 0.94'



72T
Cr-V
1/4"
6.3mm
3/8"
10mm

- 3526MS 6pt & 3926MS 12pt
- 1/4" Dr. Socket:
4, 5, 5.5, 6, 7, 8, 9, 10, 11, 12, 13, 14 mm
- 3/8" Dr. Socket:
8, 10, 11, 12, 13, 14, 15, 16, 17, 18, 19 mm
- Adaptor 3/8"(F) x 1/4"(M)
- 3/8" Dr. Extension Bar 125mm
- 3/8" Dr. Ratchet Handle 72TH

3527MS /3927MS

27 Pcs 1/4" & 3/8" Dr. Socket Set (In Hanger)



72T
Cr-V
1/4"
6.3mm
3/8"
10mm

- 3527MS 6pt & 3927MS 12pt
- 10pcs 3/8" Dr. Flank Socket:
10, 11, 12, 13, 14, 15, 16, 17, 18, 19 mm
- 14pcs 1/4" Dr. Socket Bit
(Hex):3, 4, 5, 6 (SL):4, 5.5, 7
(PH):1, 2 (Torx):10, 15, 20, 25, 30
- 1pc- 3/8"(F) x 1/4"(M)
- 1pc- 3/8" Dr. Extension Bar 150mm
- 1pc- 3/8" Dr. Ratchet Handle 72TH

2510L/2910L

10 Pcs 1/4" Dr. Socket Set

- 50 SETS/CTN N.W.: 12 KGS
G.W.: 13 KGS CUFT: 0.85'



Cr-V
1/4"
6.3mm



- 2510L 6pt & 2910L 12pt
- Size:5, 6, 7, 8, 9, 10, 11, 12, 13, 14mm

2510DL/2910DL

10 Pcs 1/4" Dr. Deep Socket Set

- 50 SETS/CTN N.W.: 18.5 KGS
G.W.: 19.5 KGS CUFT: 0.84



Cr-V
1/4"
6.3mm

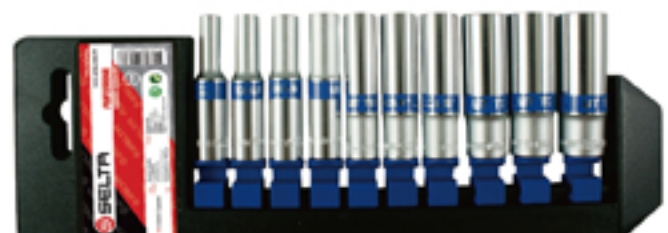

- 2510DL 6pt & 2910DL 12pt
- Size:4, 5, 6, 7, 8, 9, 10, 11, 12, 13mm

2614L

14 Pcs 1/4" Dr. E-Socket & Torx Bit Socket Set

- 50 SETS/CTN N.W.: 13.5 KGS
G.W.: 14.5 KGS CUFT: 0.89'



- 1/4" Dr. E-Socket: E4, E5, E6, E7, E8, E10
- 1/4" Dr. Bit Socket: T8, T9, T10, T15, T20, T25, T27, T30

2614BL

14 Pcs 1/4" Dr. Bit Socket Set

- 50 SETS/CTN N.W.: 13.5 KGS
G.W.: 14.5 KGS CUFT: 0.89'



- Size:
- H3, H4, H5, H6, H7, H8
 - T8, T10, T15, T20, T25, T30, T40, T45

3509L/3909L

9 Pcs 3/8" Dr. Socket Set

- 50 SETS/CTN N.W.: 20.5 KGS
G.W.: 21.5 KGS CUFT: 1'



- 3509L 6pt & 3909L 12pt
- Size: 10, 11, 12, 13, 14, 15, 16, 17, 18mm

3509DL/3909DL

9 Pcs 3/8" Dr. Deep Socket Set

- 20 SETS/CTN N.W.: 18 KGS
G.W.: 19 KGS CUFT: 0.6'

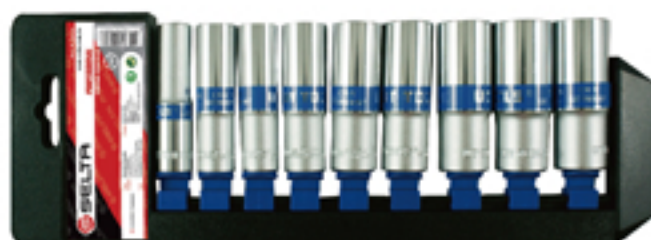

- 3509DL 6pt & 3909DL 12pt
- Size: 10, 12, 13, 14, 15, 16, 17, 18, 19mm

4506DL/4906DL

6 Pcs 1/2" Dr. Deep Socket Set

- 20 SETS/CTN N.W.: 16.3 KGS
G.W.: 17.3 KGS CUFT: 0.58'



- 4506L 6pt & 4906L 12pt
- Size: 13, 14, 15, 16, 17, 18mm

XL4509-1S

9 Pcs 1/2" Dr. Bit Socket Set

- 20 SETS/CTN N.W.: 16 KGS
G.W.: 17 KGS CUFT: 0.7'



- Size: H4, H5, H6, H7, H8, H10, H12, H14, H17mm

XL4509-2S 9 Pcs 1/2" Dr. Bit Socket Set

- 20 SETS/CTN N.W.: 16 KGS
G.W.: 17 KGS CUFT: 0.7'



- PH: 2, 3
- SL: 10, 12
- Spline: M5, M6, M8, M10, M12

XL4509-3S 9 Pcs 1/2" Dr. Bit Socket Set

- 20 SETS/CTN N.W.: 14.5 KGS
G.W.: 15.5 KGS CUFT: 0.7'



- Torx: 20, 25, 27, 30, 40, 45, 50, 55, 60mm

4510LH 10 Pcs 1/2" Dr. Socket Set

- 20 SETS/CTN N.W.: 13.2 KGS
G.W.: 14.2 KGS CUFT: 0.6'



- Size: 9, 10, 11, 12, 13, 14, 15, 17, 18, 19mm

234611 11 Pcs 1/4" & 3/8" & 1/2" Dr. E-Socket Set

- 50 SETS/CTN N.W.: 22 KGS
G.W.: 23 KGS CUFT: 1.07'



- 1/4" Dr. E-Socket: E4, E5, E6, E7
- 3/8" Dr. E-Socket: E8, E10, E12
- 1/2" Dr. E-Socket: E14, E16, E18, E20

4506D 6 Pcs 1/2" Dr. Deep Socket Set

- 10 SETS/CTN N.W.: 12.1 KGS
G.W.: 13.1 KGS CUFT: 0.94'



- Size: 10, 12, 13, 14, 17, 19mm

3507D 7 Pcs 3/8" Dr. Deep Socket Set



- Size: 10, 12, 13, 14, 15, 17, 19mm

61672

3/4" Dr. Ratchet Handle

72T



- 72 Teeth Extendable Ratchet Handle Is
- 5° Angle Of Rotation, 530mmL



To Be Used With A Socket Containing A Pin



60272/60372/60472

Ratchet Handle

72T 1/4" 6.3mm
Cr-V 3/8" 10mm
1/2" 12.5mm



Repair Kit



- Repair Kit

Item no.	size
60272P	1/4" x 72T
60372P	3/8" x 72T
60472P	1/2" x 72T



Color Box



- W/Full Polished Handle

Item no.	size	PCS/CTN	Box
60272	1/4" x 72T	100	10
60372	3/8" x 72T	60	10
60472	1/2" x 72T	40	10

62272/62372/62472

Ratchet Handle W/Knurling

72T 1/4" 6.3mm
Cr-V 3/8" 10mm
1/2" 12.5mm



Repair Kit



- Repair Kit

Item no.	size
62272P	1/4" x 72T
62372P	3/8" x 72T
62472P	1/2" x 72T



Color Box



Item no.	size	PCS/CTN	Box
62272	1/4" x 72T	60	10
62372	3/8" x 72T	40	10
62472	1/2" x 72T	20	10

61245/61345/61445 Ratchet Handle W/Knurling

45T 1/4"
6.3mm
Cr-V 3/8"
10mm
1/2"
12.5mm

- Repair Kit

Item no.	size
61245P	1/4" x 45T
61345P	3/8" x 45T
61445P	1/2" x 45T

Color Box



Item no.	size	PCS/CTN	Box
61245	1/4" x 45T	60	1
61345	3/8" x 45T	40	1
61445	1/2" x 45T	20	1

616500/618550/618650 Ratchet Handle W/Black Head

24T 3/4"
19mm
Cr-V 1"
25mm

- Repair Kit

Item no.	size
616P	3/4" x 24T
618P	1" x 24T

Color Box



Item no.	size	L(mm)	PCS/CTN	Box
616500	3/4" x 24T	500	4	2
618550	1" x 24T	550	4	2
618650	1" x 24T	650	6	2

61272/61372/61472 Ratchet Handle

72T 1/4"
6.3mm
Cr-V 3/8"
10mm
1/2"
12.5mm

- Repair Kit

Item no.	size
612P	1/4" x 72T
613P	3/8" x 72T
614P	1/2" x 72T

Color Box

- W/Two Tone Grip

Item no.	size	PCS/CTN	Box
61272	1/4" x 72T	60	1
61372	3/8" x 72T	40	1
61472	1/2" x 72T	20	1

61272T/61372T/61472T Telescopic Ratchet Handle

72T 1/4"
6.3mm
Cr-V 3/8"
10mm
1/2"
12.5mm



Repair Kit



- Repair Kit

Item no.	size
612P	1/4" x 72T
613P	3/8" x 72T
614P	1/2" x 72T



Color Box

Item no.	size	L(mm)	PCS/CTN	Box
61272T	1/4" x 72T	155~205	60	1
61372T	3/8" x 72T	225~325	40	1
61472T	1/2" x 72T	305~445	20	1

61272F/61372F/61472F Flexible Ratchet Handle

72T 1/4"
6.3mm
Cr-V 3/8"
10mm
1/2"
12.5mm



Repair Kit



- Repair Kit

Item no.	size
612P	1/4" x 72T
613P	3/8" x 72T
614P	1/2" x 72T



Color Box

- W/Two Tone Grip

Item no.	size	PCS/CTN	Box
61272F	1/4" x 72T	60	1
61372F	3/8" x 72T	20	1
61472F	1/2" x 72T	20	1

612272/612372/612472 Light Weight Ratchet Handle

72T 1/4"
6.3mm
Cr-V 3/8"
10mm
1/2"
12.5mm



Repair Kit



- Repair Kit

Item no.	size
612P	1/4" x 72T
613P	3/8" x 72T
614P	1/2" x 72T



Color Box

- Abundant Color To Satisfy Your Designated Color

Item no.	size	PCS/CTN	Box
612272	1/4" x 72T	100	1
612372	3/8" x 72T	60	1
612472	1/2" x 72T	40	1

61260/61360/61460
One-Hand Switch Ratchet Handle

Color Box

60T	1/4"	6.3mm
Cr-V	3/8"	10mm
	1/2"	12.5mm

Repair Kit
- Repair Kit

Item no.	size
61260P	1/4" x 60T
61360P	3/8" x 60T
61460P	1/2" x 60T

Item no.	size	PCS/CTN	Box
61260	1/4" x 60T	100	10
61360	3/8" x 60T	60	10
61460	1/2" x 60T	40	10

61248/61348/61448
Ratchet Handle 48T

Color Box

48T	1/4"	6.3mm
Cr-V	3/8"	10mm
	1/2"	12.5mm

Repair Kit
- Repair Kit

Item no.	size
61248P	1/4" x 48T
61348P	3/8" x 48T
61448P	1/2" x 48T

Item no.	size	PCS/CTN	Box
61248	1/4" x 48T	60	1
61348	3/8" x 48T	40	1
61448	1/2" x 48T	20	1

802223D/802323D/802423D
3D Ratchet Handle

Color Box

72T	1/4"	6.3mm
Cr-V	3/8"	10mm
	1/2"	12.5mm



Item no.	size	PCS/CTN
802223D	1/4" x 72T	60
802323D	3/8" x 72T	40
802423D	1/2" x 72T	20

61248W/61348W/61448W
Ratchet Handle 48T

Color Box

- 48T** **1/2"**
12.5mm
- Cr-V** **1/4"**
6.3mm
- 3/8"**
10mm



Item no.	size	PCS/CTN	Box
61248W	1/4" x 48T	60	1
61348W	3/8" x 48T	40	1
61448W	1/2" x 48T	20	1

631...
Swivel Handle

Repair Kit

- Repair Kit

Item no.	size
6312P	1/4"
6313P	3/8"
6314P	1/2"

Item no.	size	L(mm)	PCS/CTN	Box
6312155T	1/4"	155~205	60	1
6313225T	3/8"	225~325	40	1
6314305T	1/2"	305~445	20	1

631...
Swivel Handle

Repair Kit

- Repair Kit

Item no.	size
6312P	1/4"
6313P	3/8"
6314P	1/2"
6316P	3/4"

Item no.	size	L(mm)	PCS/CTN	Box
6312150	1/4"	150(6")	60	40
6313200	3/8"	200(8")	60	10
6314250	1/2"	250(10")	40	10
6314375	1/2"	375(15")	20	10
6314430	1/2"	430(17")	20	10
6314450	1/2"	450(18")	20	10
6314475	1/2"	475(19")	10	10
6316475	3/4"	475(19")	12	6
6316600	3/4"	600(24")	4	2

631...

Breaker Bar



Item no.	size	L(mm)	PCS/CTN	Box
63161000	3/4"	1000(40")	4	1
63181000	1"	1000(40")	4	1

Breaker Bar Repair Kit

Item no.	size
6316U-P	3/4"
6318U-P	1"

6314...

1/2" Dr. Breaker Bar



Item no.	L(mm)	PCS/CTN	Box
6314300	300(12")	24	6
6314500	450(18")	10	5
6314600	600(24")	10	5
6314750	750(30")	10	5

Breaker Bar Repair Kit

Item no.	size
6314U-P	1/2"

61660

3/4" Dr. Ratchet Handle 60T



Repair Kit



- Repair Kit

Item no.	size
61660P	3/4" x 60T

- 60 Teeth Extendable Ratchet Handle Is Small Head, 770mml



822...
Double Socket Ratchet Wrench

Item no.	size(mm)	PCS/CTN	Item no.	size(mm)	PCS/CTN	Item no.	size(mm)	PCS/CTN
8221012	10 x 12	60	8221924	19 x 24	30	8223036	30 x 36	20
8221013	10 x 13	60	8222123	21 x 23	30	8223638	36 x 38	20
8221014	10 x 14	60	8222126	21 x 26	30	8223641	36 x 41	20
8221113	11 x 13	60	8222127	21 x 27	30	8223841	38 x 41	20
8221214	12 x 14	60	8222224	22 x 24	30	8223646	36 x 46	12
8221317	13 x 17	60	8222326	23 x 26	30	8223846	38 x 46	12
8221415	14 x 15	60	8222427	24 x 27	30	8224146	41 x 46	12
8221417	14 x 17	60	8222430	24 x 30	20	8223650	36 x 50	12
8221419	14 x 19	50	8222629	26 x 29	20	8223850	38 x 50	12
8221719	17 x 19	50	8222632	26 x 32	20	8224150	41 x 50	12
8221721	17 x 21	50	8222730	27 x 30	20	8224650	46 x 50	12
8221921	19 x 21	50	8222732	27 x 32	20	8224155	41 x 55	12
8221922	19 x 22	50	8223032	30 x 32	20	8224655	46 x 55	12
8221923	19 x 23	30	8223033	30 x 33	20	8225055	50 x 55	12

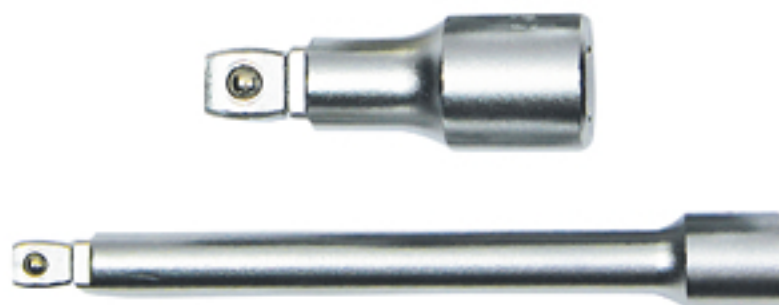
622...W/623...W/624...W
Wobble Extension Bar

1/4" Dr.

Item no.	L(mm)	PCS/CTN	Box
622050W	50(2")	480	20
622075W	75(3")	480	20
622100W	100(4")	360	20
622150W	150(6")	320	20
622250W	250(10")	120	30

3/8" Dr.

Item no.	L(mm)	PCS/CTN	Box
623050W	50(2")	200	20
623075W	75(3")	240	20
623150W	150(6")	120	10
623200W	200(8")	---	---
623250W	250(10")	60	10

1/2" Dr.

Item no.	L(mm)	PCS/CTN	Box
624050W	50(2")	100	10
624075W	75(3")	120	10
624125W	125(5")	80	10
624150W	150(6")	80	10
624175W	175(7")	80	10
624200W	200(8")	80	10
624250W	250(10")	40	10

622.../623.../624.../626.../628... Extension Bar

1/4" Dr.

Item no.	L(mm)	PCS/CTN	Box
622050	50(2")	480	20
622075	75(3")	480	20
622100	100(4")	360	20
622125	125(5")	360	20
622150	150(6")	320	20
622250	250(10")	120	20

3/8" Dr.

Item no.	L(mm)	PCS/CTN	Box
623050	50(2")	200	20
623075	75(3")	240	20
623125	125(5")	120	---
623150	150(6")	120	10
623250	250(10")	60	10

1/2" Dr.

Item no.	L(mm)	PCS/CTN	Box
624050	50(2")	100	10
624075	75(3")	120	10
624100	100(4")	120	10
624125	125(5")	80	10
624250	250(10")	40	10
624500	500(20")	20	5
624600	600(24")	20	5
624750	750(30")	10	5
624900	900(36")	10	5

3/4" Dr.

Item no.	L(mm)	PCS/CTN	Box
626100	100(4")	40	20
626200	200(8")	20	10
626400	400(16")	12	6

1" Dr.

Item no.	L(mm)	PCS/CTN	Box
628200	200(8")	10	5
628400	400(16")	6	3

63... & 63...P Sliding T Bar

Item no.	size	L(mm)	PCS/CTN	Box
632115	1/4"	110(4")	240	20
633165	3/8"	165(6")	100	10
633200	3/8"	200(8")	80	10
634250	1/2"	250(10")	40	10
634300	1/2"	300(12")	40	10

Item no.	size	L(mm)	PCS/CTN	Box
636450	3/4"	450(18")	16	4
636500	3/4"	500(20")	16	4
638500	1"	500(20")	10	5
638550	1"	550(22")	10	5
638650	1"	650(26")	4	1

Item no.	size	L(mm)	PCS/CTN	Box
636450P	3/4"	450(18")	16	4
636500P	1"	500(20")	16	4
636550P	1"	550(22")	16	4
636650P	1"	650(26")	16	4

677.../67701 Double-End Truck Wrench

Item no.	size	PCS/CTN	Box
6771921	19 x 21mm	15	5
6772427	24 x 27mm	10	5
6773032	30 x 32mm	10	5
6773233	32 x 33mm	10	5

Item no.	size	PCS/CTN	Box
67701	19 x 630mm	10	5

603... Universal Bar

Item no.	size	L(mm)	PCS/CTN	Box
603505	1" x 20"	505(20")	10	5
603550	1" x 22"	550(22")	10	5
603650	1" x 26"	650(26")	10	5

611... Flexible Extension Bar

Item no.	Size	L(mm)	PCS/CTN	Box
6111	1/4"	145	240	20
6111L	1/4"	450	60	10
6113	3/8"	200	60	10
6114	1/2"	200	60	10

51L...

Wheel Lug Nut Wrench



Item no.	size	PCS/CTN
51L17	17mm	26
51L19	19mm	26
51L21	21mm	26

606...

L Handle



Item no.	size	L(mm)	PCS/CTN	Box
6064190	1/2"	190	60	15
6064260	1/2"	260	40	10
6064300	1/2"	300	40	10
6064350	1/2"	350	20	10
6064400	1/2"	400	20	10

Item no.	size	L(mm)	PCS/CTN	Box
6066300	3/4"	300	---	---
6066450	3/4"	450	10	5
6068650	1"	650	4	1

6064315

1/2" Dr. 105° L Handle



Item no.	size	L(mm)	PCS/CTN	Box
6064315	1/2"	315	40	10

615410S

1/2" Dr. Speedy Handle



Item no.	L(mm)	PCS/CTN	Box
615410S	420	24	6

65623

1/4" 3-Way Spinner Handle



Item no.	size	L(mm)	PCS/CTN
65623	1/4"	150	100

6043

1/4" Dr. Spinner Handle



Item no.	size	L(mm)	PCS/CTN
6043	1/4"	150	100

6144

1/4" Dr. Magnetic Screwdriver



Item no.	size	L(mm)	PCS/CTN
6144	1/4"	200	40

PLL4/4

Speed Wheel Master Wrench



Packaging



- Socket:17~19mm & 21~23mm

257...

Multi-Function Palm Driver



Item no.	Size
25722	1/4"(F) x 1/4"(M)
25733	3/8"(F) x 3/8"(M)
25744	1/2"(F) x 1/2"(M)

616300/618300

Ratchet Head

24T



Item no.	size
616300	3/4"
618300	1"

656...
3-Way Adapter

Item no.	size	PCS/CTN	Box
65632	3/8" x 1/4"	240	20
65634	3/8" x 1/2"	240	10
65643	1/2" x 3/8"	150	15

659...
Adapter

Item no.	size	PCS/CTN	Box
65923	1/4"(F) x 3/8"(M)	360	30
65932	3/8"(F) x 1/4"(M)	240	20
65934	3/8"(F) x 1/2"(M)	200	20
65942	1/2"(F) x 1/4"(M)	150	15
65943	1/2"(F) x 3/8"(M)	150	15
65946	1/2"(F) x 3/4"(M)	100	10
65964	3/4"(F) x 1/2"(M)	100	10
65968	3/4"(F) x 1"(M)	---	---
65986	1"(F) x 3/4"(M)	60	10

418...
Drive Reversible Ratchet Adaptor



- Size:
 41802: 1/4"
 41803: 3/8"
 41804: 1/2"
 - L: 42 mm

611...
Bit Holder

Item no.	size	PCS/CTN	BOX
61122	1/4" x 1/4"	360	30
61135	3/8" x 5/16"	360	20
61145	1/2" x 5/16"	360	20

659...P
Adapter With Pin

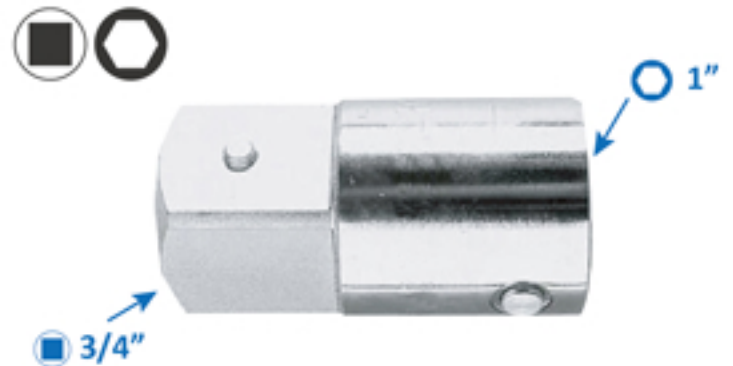
Item no.	size	PCS/CTN	Box
65964P	3/4"(F) x 1/2"(M)	100	10
65986P	1"(F) x 3/4"(M)	60	10

65968P
Adapter 3/4"(F) x 1"(M)

Item no.	size	PCS/CTN	Box
65968P	3/4"(F) x 1"(M)	60	10

636501/65981
Sliding T Bar Head

Item no.	size	PCS/CTN	Box
636501	3/4"	60	15
65981	1"	30	5

609...
Universal Joint

Item no.	size	L(mm)	PCS/CTN	Box
60921	1/4"	37	180	15
60931	3/8"	46	100	10
60941	1/2"	70	120	10
60961	3/4"	109	30	5

60961P
3/4" Dr. Universal Joint W/Pin

Item no.	size	L(mm)	PCS/CTN
60961P	3/4"	109	120

610...
Coupler

Item no.	size	L(mm)	PCS/CTN	Box
61022	1/4" x 1/4"	25	360	30
61032	3/8" x 1/4"	30	---	---
61035	3/8" x 5/16"	30	240	20
61037	3/8" x 10mm	30	240	20
61042	1/2" x 1/4"	38	---	---
61045	1/2" x 5/16"	38	240	20
61047	1/2" x 10mm	38	240	20

609...
Spark Plug Socket

6pt - 3/8"

Item no.	size(mm)	L(mm)	PCS/CTN	Box
609314	14	65	120	10
609316	16	65	120	10
609318	18	65	100	10
609321	21	65	100	10

6pt - 1/2"

Item no.	size(mm)	L(mm)	PCS/CTN	Box
609414	14	65	120	10
609416	16	65	120	10
609418	18	65	80	10
609421	21	65	80	10



Color Box

609...M
Magnetic Spark Plug Socket

6pt - 1/2"

Item no.	size(mm)	L(mm)	PCS/CTN	Box
609414M	14	65	120	10
609416M	16	65	120	10
609418M	18	65	100	10
609421M	21	65	100	10

12pt - 3/8"

Item no.	size(mm)	L(mm)	PCS/CTN	Box
609314M	14	65	120	10



Color Box

125.../129...

1/4" Dr. Socket



Color Box



6pt		12pt		Size(mm)	L(mm)	PCS/CTN	Box
Item no.	Item no.	Item no.	Item no.				
12504	12904	12504	12904	4	25	360	60
125045	129045	125045	129045	4.5	25	360	60
12505	12905	12505	12905	5	25	360	60
125055	129055	125055	129055	5.5	25	360	60
12506	12906	12506	12906	6	25	360	60
12507	12907	12507	12907	7	25	360	60
12508	12908	12508	12908	8	25	360	60
12509	12909	12509	12909	9	25	240	40
12510	12910	12510	12910	10	25	240	40
12511	12911	12511	12911	11	25	240	40
12512	12912	12512	12912	12	25	240	40
12513	12913	12513	12913	13	25	120	20
12514	12914	12514	12914	14	25	120	20

6pt (SAE)		12pt (SAE)		Size	L(mm)	PCS/CTN	Box
Item no.	Item no.	Item no.	Item no.				
1253.16	1293.16	1253.16	1293.16	3/16"	25	360	60
1257.32	1297.32	1257.32	1297.32	7/32"	25	360	60
1251.4	1291.4	1251.4	1291.4	1/4"	25	360	60
1259.32	1299.32	1259.32	1299.32	9/32"	25	360	60
1255.16	1295.16	1255.16	1295.16	5/16"	25	360	60
12511.32	12911.32	12511.32	12911.32	11/32"	25	360	60
1253.8	1293.8	1253.8	1293.8	3/8"	25	240	40
1257.16	1297.16	1257.16	1297.16	7/16"	25	240	40
1251.2	1291.2	1251.2	1291.2	1/2"	25	240	40
1259.16	1299.16	1259.16	1299.16	9/16"	25	240	40

12550.../12950... 1/4" Dr. Deep Socket

Color Box

6pt 12pt

Item no.	Item no.	Size(mm)	L(mm)	PCS/CTN	Box
1255004	1295004	4	50	240	40
12550045	12950045	4.5	50	240	40
1255005	1295005	5	50	240	40
12550055	12950055	5.5	50	240	40
1255006	1295006	6	50	240	40
1255007	1295007	7	50	240	40
1255008	1295008	8	50	240	40
1255009	1295009	9	50	240	40
1255010	1295010	10	50	180	30
1255011	1295011	11	50	240	30
1255012	1295012	12	50	240	30
1255013	1295013	13	50	240	30
1255014	1295014	14	50	240	30

126... 1/4" Dr. Star Socket

Color Box



Item no.	Size	L(mm)	PCS/CTN	Box
12604	E4	25	360	60
12605	E5	25	360	60
12606	E6	25	360	60
12607	E7	25	360	60
12608	E8	25	360	60
12610	E10	25	360	60
12611	E11	25	360	60
12612	E12	25	360	60

Star Deep Socket

Item no.	Size	L(mm)	PCS/CTN	Box
1265004	E4	50	240	40
1265005	E5	50	240	40
1265006	E6	50	240	40
1265007	E7	50	240	40
1265008	E8	50	240	40
1265010	E10	50	180	30

135.../139...

3/8" Dr. Socket



Color Box



6pt 12pt

Item no.	Item no.	Size(mm)	L(mm)	PCS/CTN	Box
13506	13906	6	28	240	20
13507	13907	7	28	240	20
13508	13908	8	28	240	20
13509	13909	9	28	240	20
13510	13910	10	28	240	20
13511	13911	11	28	240	20
13512	13912	12	28	240	20
13513	13913	13	28	240	20
13514	13914	14	28	180	15
13515	13915	15	28	180	15
13516	13916	16	28	180	15
13517	13917	17	30	180	15
13518	13918	18	30	120	10
13519	13919	19	30	120	10
13520	13920	20	30	120	10
13521	13921	21	30	120	10
13522	13922	22	30	120	10
13524	13924	24	30	120	10

6pt (SAE) 12pt (SAE)

Item no.	Item no.	Size	L(mm)	PCS/CTN	Box
1351.4	1391.4	1/4"	28	240	20
1355.16	1395.16	5/16"	28	240	20
1353.8	1393.8	3/8"	28	240	20
1357.16	1397.16	7/16"	28	240	20
1351.2	1391.2	1/2"	28	240	20
1359.16	1399.16	9/16"	28	180	15
1355.8	1395.8	5/8"	28	180	15
13511.16	13911.16	11/16"	30	120	10
1353.4	1393.4	3/4"	30	120	10
13513.16	13913.16	13/16"	30	120	10
1357.8	1397.8	7/8"	30	120	10

13563.../13963... 3/8" Dr. Deep Socket

Color Box

6pt 12pt

Item no.	Item no.	Size(mm)	L(mm)	PCS/CTN	Box
1356306	1396306	6	63	240	20
1356307	1396307	7	63	240	20
1356308	1396308	8	63	240	20
1356309	1396309	9	63	240	20
1356310	1396310	10	63	240	20
1356311	1396311	11	63	240	20
1356312	1396312	12	63	240	20
1356313	1396313	13	63	180	20
1356314	1396314	14	63	180	15
1356315	1396315	15	63	180	15
1356316	1396316	16	63	180	15
1356317	1396317	17	63	150	15
1356318	1396318	18	63	150	15
1356319	1396319	19	63	150	15
1356320	1396320	20	63	150	15
1356321	1396321	21	63	150	15
1356322	1396322	22	63	150	15

136... 3/8" Dr. Star Socket

Color Box



Item no.	Size(mm)	L(mm)	PCS/CTN	Box
13604	E4	28	240	20
13605	E5	28	240	20
13606	E6	28	240	20
13607	E7	28	240	20
13608	E8	28	240	20
13610	E10	28	240	20
13611	E11	28	240	20
13612	E12	28	240	20
13614	E14	28	240	20
13616	E16	28	180	15
13618	E18	28	120	10
13620	E20	28	120	10
1366310	E10	63	240	20
1366311	E11	63	240	20
1366312	E12	63	240	20
1366314	E14	63	180	15
1366316	E16	63	180	15

145.../149...

1/2" Dr. Socket



Color Box



6pt 12pt

Item no.	Item no.	Size(mm)	L(mm)	PCS/CTN	Box
14508	14908	8	38	240	10
14509	14909	9	38	240	10
14510	14910	10	38	240	10
14511	14911	11	38	240	10
14512	14912	12	38	240	10
14513	14913	13	38	240	10
14514	14914	14	38	240	10
14515	14915	15	38	240	10
14516	14916	16	38	240	10
14517	14917	17	38	240	10
14518	14918	18	38	240	10
14519	14919	19	38	240	10
14520	14920	20	38	240	10
14521	14921	21	38	240	10
14522	14922	22	38	100	10
14523	14923	23	38	100	10
14524	14924	24	38	100	10
14525	14925	25	40	100	10
14526	14926	26	42	100	10
14527	14927	27	42	100	10
14528	14928	28	42	80	10
14529	14929	29	42	80	10
14530	14930	30	44	80	10
14532	14932	32	44	80	10
14534	14934	34	48	60	6
14535	N/A	35	48	60	6
14536	14936	36	48	60	6

6pt (SAE) 12pt (SAE)

Item no.	Item no.	Size(inch)	L(mm)	PCS/CTN	Box
1455.16	1495.16	5/16"	38	240	10
1453.8	1493.8	3/8"	38	240	10
1457.16	1497.16	7/16"	38	240	10
14515.32	14915.32	15/32"	38	240	10
1451.2	1491.2	1/2"	38	240	10
1459.16	1499.16	9/16"	38	240	10
1455.8	1495.8	5/8"	38	240	10
14511.16	14911.16	11/16"	38	240	10
1453.4	1493.4	3/4"	38	240	10
14525.32	14925.32	25/32"	38	240	10
14513.16	14913.16	13/16"	38	240	10
1457.8	1497.8	7/8"	40	100	10
14515.16	14915.16	15/16"	40	100	10
1451.0	1491.0	1"	40	100	10
1451.1.16	1491.1.16	1.1/16"	42	100	10
1451.1.8	1491.1.8	1.1/8"	42	80	10
1451.3.16	1491.3.16	1.3/16"	42	80	10
1451.1.4	1491.1.4	1.1/4"	42	80	10

14577.../14977... 1/2" Dr. Deep Socket

6pt 12pt

Item no.	Item no.	Size(mm)	L(mm)	PCS/CTN	Box
1457708	1497708	8	77	120	10
1457709	1497709	9	77	120	10
1457710	1497710	10	77	120	10
1457711	1497711	11	77	120	10
1457712	1497712	12	77	120	10
1457713	1497713	13	77	120	10
1457714	1497714	14	77	120	10
1457715	1497715	15	77	120	10
1457716	1497716	16	77	120	10
1457717	1497717	17	77	80	10
1457718	1497718	18	77	80	10
1457719	1497719	19	77	80	10
1457720	1497720	20	77	80	10
1457721	1497721	21	77	80	10
1457722	1497722	22	77	80	10
1457723	1497723	23	77	64	8
1457724	1497724	24	77	64	8
1457725	1497725	25	77	60	10
1457726	1497726	26	77	60	10
1457727	1497727	27	77	60	10
1457728	1497728	28	77	60	10
1457729	1497729	29	77	60	10
1457730	1497730	30	77	60	10
1457732	1497732	32	77	60	10



Color Box

146.../14677... 1/2" Dr. Star Socket

Color Box

Star Socket

Item no.	Size	L(mm)	PCS/CTN	Box
14608	E8	38	240	10
14610	E10	38	240	10
14611	E11	38	240	10
14612	E12	38	240	10
14614	E14	38	240	10
14616	E16	38	240	10
14618	E18	38	240	10
14620	E20	38	240	10
14622	E22	38	180	10
14624	E24	38	180	10

Star Deep Socket

Item no.	Size	L(mm)	PCS/CTN	Box
1467710	E10	77	240	10
1467711	E11	77	240	10
1467712	E12	77	240	10
1467714	E14	77	240	10
1467716	E16	77	240	10
1467718	E18	77	240	10
1467720	E20	77	240	10
1467722	E22	77	240	10
1467724	E24	77	240	10

165.../169...

3/4" Dr. Socket



Color Box



6pt 12pt

Item no.	Item no.	Size(mm)	L(mm)	PCS/CTN	Box
16517	16917	17	50	48	6
16518	16918	18	50	48	6
16519	16919	19	50	48	6
16520	16920	20	50	48	6
16521	16921	21	50	48	6
16522	16922	22	50	48	6
16523	16923	23	50	48	6
16524	16924	24	50	48	6
16525	16925	25	52	48	6
16526	16926	26	52	48	6
16527	16927	27	52	48	6
16528	16928	28	52	48	6
16529	16929	29	52	48	6
16530	16930	30	54	48	6
16532	16932	32	56	48	6
16533	16933	33	56	36	6
16534	16934	34	58	36	6
16535	16935	35	58	36	6
16536	16936	36	58	36	6
16538	16938	38	58	36	6
16540	16940	40	62	24	4
16541	16941	41	64	24	4
16542	16942	42	64	24	4
16544	N/A	44	68	24	4
16546	16946	46	68	24	4
16548	16948	48	72	16	4
16550	16950	50	72	16	4
N/A	16952	52	76	16	4
16555	16955	55	76	16	4
16556	16956	56	78	16	4
16560	16960	60	78	16	4
16565	16965	65	82	16	4

6pt (SAE) 12pt (SAE)

Item no.	Item no.	Size	L(mm)	PCS/CTN	Box
1655.16	1695.16	5/16"	50	48	6
1651.0	1691.0	1"	50	48	6
1651.1.16	1691.1.16	1.1/16"	52	48	6
1651.1.8	1691.1.8	1.1/8"	52	48	6
1651.3.16	1691.3.16	1.3/16"	54	48	6
1651.1.4	1691.1.4	1.1/4"	56	48	6
1651.5.16	1691.5.16	1.5/16"	56	36	6
1651.3.8	1691.3.8	1.3/8"	58	36	6
1651.7.16	1691.7.16	1.7/16"	58	36	6
1651.1.2	1691.1.2	1.1/2"	58	36	6
1651.5.8	1691.5.8	1.5/8"	64	24	4
1651.11.16	1691.11.16	1.11/16"	64	24	4
1651.3.4	1691.3.4	1.3/4"	68	24	4
1651.13.16	1691.13.16	1.13/16"	68	24	4
1651.7.8	1691.7.8	1.7/8"	70	16	4
1652.0	1692.0	2"	72	16	4

165...P/169...P 3/4" Dr. Socket

6pt 12pt

Item no.	Item no.	Size(mm)	L(mm)	PCS/CTN	Box
16522P	16922P	22	50	48	6
16524P	16924P	24	50	48	6
16527P	16927P	27	52	48	6
16530P	16930P	30	54	48	6
16532P	16932P	32	56	48	6
16534P	16934P	34	56	36	6
16536P	16936P	36	58	36	6
16538P	16938P	38	60	36	4
16541P	16941P	41	64	24	4
16546P	16946P	46	68	24	4
16550P	16950P	50	68	20	4
16555P	16955P	55	76	16	4
16560P	16960P	60	78	16	4
16565P	16965P	65	78	16	4



Color Box

185.../189... 1" Dr. Socket

Color Box

6pt 12pt

Item no.	Item no.	Size(mm)	L(mm)	PCS/CTN	Box
18536	18936	36	65	40	5
18538	18938	38	65	40	5
18541	18941	41	70	20	5
18546	18946	46	75	20	5
18550	18950	50	75	10	5
18554	18954	54	80	10	5
18555	18955	55	80	10	5
18558	18958	58	80	10	5
18560	18960	60	84	10	5
18563	18963	63	87	10	5
18565	18965	65	87	10	5
18567	18967	67	90	10	5
18570	18970	70	93	10	5
18571	18971	71	93	10	5
18575	18975	75	97	10	5
18577	18977	77	103	10	5
18580	18980	80	103	10	5

6pt (SAE) 12pt (SAE)

Item no.	Item no.	Size	L(mm)	PCS/CTN	Box
1851.5.8	1891.5.8	1.5/8"	70	20	5
1851.13.16	1891.13.16	1.13/16"	75	20	5
1851.7.8	1891.7.8	1.7/8"	75	20	5
1852.0	1892.0	2"	75	10	5
1852.1.8	1892.1.8	2.1/8"	80	10	5
1852.3.16	1892.3.16	2.3/16"	80	10	5
1852.1.4	1892.1.4	2.1/4"	80	10	5
1852.3.8	1892.3.8	2.3/8"	84	10	5
1852.1.2	1892.1.2	2.1/2"	87	10	5
1852.5.8	1892.5.8	2.5/8"	90	10	5
1852.3.4	1892.3.4	2.3/4"	93	10	5
1852.15.16	1892.15.16	2.15/16"	97	10	5
1853.0	1893.0	3"	103	10	5
1853.1.8	1893.1.8	3.1/8"	103	10	5

120.../130.../140.../160... Spline Socket
Cr-V

1/4"
6.3mm

3/8"
10mm

1/2"
12.5mm

3/4"
19mm

Color Box
1/4"

Item no.	Size(mm)	L(mm)	PCS/CTN	Box
12025045	4.5	25	360	60
1202505	5	25	360	60
12025055	5.5	25	360	60
1202506	6	25	360	60
1202507	7	25	360	60
1202508	8	25	360	60
1202509	9	25	240	40
1202510	10	25	240	40
1202511	11	25	240	40
1202512	12	25	240	40
1202513	13	25	120	20
1202514	14	25	120	20

3/8"

Item no.	Size(mm)	L(mm)	PCS/CTN	Box
1302807	7	28	240	20
1302808	8	28	240	20
1302809	9	28	240	20
1302810	10	28	240	20
1302811	11	28	240	20
1302812	12	28	240	20
1302813	13	28	240	20
1302814	14	28	180	15
1302815	15	28	180	15
1303016	16	30	180	15
1303017	17	30	180	15
1303018	18	30	120	10
1303019	19	30	120	10
1303220	20	32	120	10
1303221	21	32	120	10
1303222	22	32	120	10
1303224	24	32	120	10

1/2"

Item no.	Size(mm)	L(mm)	PCS/CTN	Box
1403808	8	38	240	10
1403809	9	38	240	10
1403810	10	38	240	10
1403811	11	38	240	10
1403812	12	38	240	10
1403813	13	38	240	10
1403814	14	38	240	10
1403815	15	38	240	10
1403816	16	38	240	10
1403817	17	38	240	10
1403818	18	38	240	10
1403819	19	38	240	10
1403820	20	38	240	10
1403821	21	38	240	10
1403822	22	38	100	10
1404023	23	40	100	10
1404024	24	40	100	10
1404227	27	42	100	10
1404430	30	44	80	10
1404432	32	44	80	10

3/4"

Item no.	Size(mm)	L(mm)	PCS/CTN	Box
1605019	19	50	48	6
1605021	21	50	48	6
1605022	22	50	48	6
1605023	23	50	48	6
1605024	24	50	48	6
1605026	26	50	48	6
1605227	27	52	48	6
1605229	29	52	48	6
1605430	30	54	48	6
1605632	32	56	48	6
1605835	35	58	36	6
1605836	36	58	36	6
1606038	38	60	36	6
1606441	41	64	24	4
1606846	46	68	24	4
1607250	50	72	16	4

128.../138.../148... Non-Slip Sockets

Color Box

Cr-V



1/4"

6.3mm

3/8"

10mm

1/2"

12.5mm

1/4"

Item no.	Size(mm)	L(mm)	PCS/CTN	Box
1282504	4	25	360	60
12825045	4.5	25	360	60
1282505	5	25	360	60
12825055	5.5	25	360	60
1282506	6	25	360	60
1282507	7	25	360	60
1282508	8	25	240	40
1282509	9	25	240	40
1282510	10	25	240	40
1282511	11	25	240	40
1282512	12	25	120	20
1282513	13	25	120	20
1282514	14	25	120	20

3/8"

Item no.	Size(mm)	L(mm)	PCS/CTN	Box
1382806	6	28	240	20
1382807	7	28	240	20
1382808	8	28	240	20
1382809	9	28	240	20
1382810	10	28	240	20
1382811	11	28	240	20
1382812	12	28	240	20
1382813	13	28	180	15
1382814	14	28	180	15
1383015	15	30	180	15
1383016	16	30	180	15
1383017	17	30	120	10
1383018	18	30	120	10
1383019	19	30	120	10
1383220	20	32	120	10
1383221	21	32	120	10
1383222	22	32	120	10
1383223	23	32	120	10
1383224	24	32	120	10

1/2"

Item no.	Size(mm)	L(mm)	PCS/CTN	Box
1483808	8	38	240	10
1483809	9	38	240	10
1483810	10	38	240	10
1483811	11	38	240	10
1483812	12	38	240	10
1483813	13	38	240	10
1483814	14	38	240	10
1483815	15	38	240	10
1483816	16	38	240	10
1483817	17	38	240	10
1483818	18	38	240	10
1483819	19	38	240	10
1483820	20	38	240	10
1483821	21	38	240	10
1483822	22	38	100	10
1484023	23	40	100	10
1484024	24	40	100	10
1484227	27	42	100	10
1484430	30	44	80	10
1484432	32	44	80	10

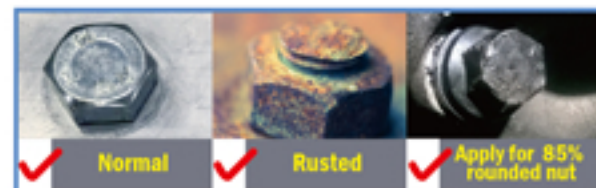
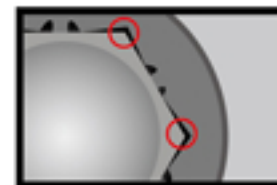

31132... 1/4" Dr. Phillips Bit Socket

Color Box

Item no.	size	L(mm)	PCS/CTN	Box
3113200	PH0	37	300	50
3113201	PH1	37	300	50
3113202	PH2	37	300	50
3113203	PH3	37	300	50

31223... 1/4" Dr. Pozidriv Bit Socket

Color Box

Item no.	size	L(mm)	PCS/CTN	Box
3122300	PZ0	37	300	50
3122301	PZ1	37	300	50
3122302	PZ2	37	300	50
3122303	PZ3	37	300	50

31333... 1/4" Dr. Slotted Bit Socket

Color Box

Item no.	size	L(mm)	PCS/CTN	Box
3133303	SL3	37	300	50
3133304	SL4	37	300	50
3133305	SL5	37	300	50
31333055	SL5.5	37	300	50
3133306	SL6	37	300	50
3133307	SL7	37	300	50

31443... 1/4" Dr. Hex Bit Socket

Color Box

Item no.	size	L(mm)	PCS/CTN	Box
3144304	H4	37	300	50
3144305	H5	37	300	50
3144306	H6	37	300	50
3144307	H7	37	300	50
3144308	H8	37	300	50
3144309	H9	37	300	50
3144310	H10	37	300	50

31632... 1/4" Dr. Torx Bit Socket

Color Box

Item no.	size	L(mm)	PCS/CTN	Box
3163208	T8	37	300	50
3163209	T9	37	300	50
3163210	T10	37	300	50
3163215	T15	37	300	50
3163220	T20	37	300	50
3163225	T25	37	300	50
3163227	T27	37	300	50
3163230	T30	37	300	50
3163235	T35	37	300	50
3163240	T40	37	300	50

31755... 1/4" Dr. Tamper Proof Bit Socket

Color Box

Item no.	size	L(mm)	PCS/CTN	Box
3175508	TP8	37	300	50
3175509	TP9	37	300	50
3175510	TP10	37	300	50
3175515	TP15	37	300	50
3175520	TP20	37	300	50
3175525	TP25	37	300	50
3175527	TP27	37	300	50
3175530	TP30	37	300	50
3175540	TP40	37	300	50

46...
1/2" Dr. Torx Bit Socket

Color Box

Item no.	Size	L(mm)	PCS/CTN	Box
4605520	T20	55	160	10
4605525	T25	55	160	10
4605527	T27	55	160	10
4605530	T30	55	160	10
4605535	T35	55	160	10
4605540	T40	55	160	10
4605545	T45	55	160	10
4605550	T50	55	160	10
4605555	T55	55	160	10
4605560	T60	55	160	10
4605570	T70	55	160	10

Item no.	Size	L(mm)	PCS/CTN	Box
4610020	T20	100	80	10
4610025	T25	100	80	10
4610027	T27	100	80	10
4610030	T30	100	80	10
4610040	T40	100	80	10
4610045	T45	100	80	10
4610050	T50	100	80	10
4610055	T55	100	80	10
4610060	T60	100	80	10
4610070	T70	100	80	10

Item no.	Size	L(mm)	PCS/CTN	Box
4614040	T40	140	80	10
4614045	T45	140	80	10
4614050	T50	140	80	10
4614055	T55	140	80	10
4614060	T60	140	80	10
4614070	T70	140	80	10

Item no.	Size	L(mm)	PCS/CTN	Box
4620040	T40	200	80	10
4620045	T45	200	80	10
4620050	T50	200	80	10
4620055	T55	200	80	10
4620060	T60	200	80	10
4620070	T70	200	80	10

46055...T/46100...T
1/2" Dr. Torx Tamper Proof Bit Socket

Color Box

Item no.	Size	L(mm)	PCS/CTN	Box
4605520T	TP20	55	160	10
4605525T	TP25	55	160	10
4605527T	TP27	55	160	10
4605530T	TP30	55	160	10
4605540T	TP40	55	160	10
4605545T	TP45	55	160	10
4605550T	TP50	55	160	10
4605555T	TP55	55	160	10
4605560T	TP60	55	160	10
4605570T	TP70	55	160	10

Item no.	Size	L(mm)	PCS/CTN	Box
4610020T	TP20	100	80	10
4610025T	TP25	100	80	10
4610027T	TP27	100	80	10
4610030T	TP30	100	80	10
4610040T	TP40	100	80	10
4610045T	TP45	100	80	10
4610050T	TP50	100	80	10
4610055T	TP55	100	80	10
4610060T	TP60	100	80	10
4610070T	TP70	100	80	10

444...

1/2" Dr. Square Bit Socket



Color Box



Item no.	Size	L(mm)	PCS/CTN	Box
44408	S8	40	240	20
444095	S9.5	40	240	20
44410	S10	40	240	20
444105	S10.5	40	240	20
44412	S12	40	160	20
444127	S12.7	40	160	20
444135	S13.5	40	160	20
44419	S19	40	160	20

4344...

1/2" Dr. Hex Bit Socket



Color Box



Item no.	Size	L(mm)	PCS/CTN	Box
434408	H8	42	160	20
434410	H10	42	160	20
434412	H12	42	160	20
434414	H14	42	160	20
434417	H17	42	160	20
434419	H19	42	160	20

544055.../544110... 1/2" Dr. Hex Bit Socket

Color Box



Item no.	Size	L(mm)	PCS/CTN	Box
54405505	H5	55	160	10
54405506	H6	55	160	10
54405507	H7	55	160	10
54405508	H8	55	160	10
54405510	H10	55	160	10
54405512	H12	55	160	10
54405514	H14	55	160	10
54405516	H16	55	80	10
54405517	H17	55	80	10
54405519	H19	55	80	10

Item no.	Size	L(mm)	PCS/CTN	Box
54411005	H5	110	80	10
54411006	H6	110	80	10
54411007	H7	110	80	10
54411008	H8	110	80	10
54411010	H10	110	80	10
54411012	H12	110	80	10
54411014	H14	110	80	10
54411016	H16	110	80	10
54411017	H17	110	80	10
54411019	H19	110	80	10

546055.../546100... 1/2" Dr. Torx Bit Socket

Color Box



Item no.	Size	L(mm)	PCS/CTN	Box
54605520	T20	55	160	10
54605525	T25	55	160	10
54605527	T27	55	160	10
54605530	T30	55	160	10
54605535	T35	55	160	10
54605540	T40	55	160	10
54605545	T45	55	160	10
54605550	T50	55	160	10
54605555	T55	55	160	10
54605560	T60	55	160	10
54605570	T70	55	160	10

Item no.	Size	L(mm)	PCS/CTN	Box
54610020	T20	100	80	10
54610025	T25	100	80	10
54610027	T27	100	80	10
54610030	T30	100	80	10
54610035	T35	100	80	10
54610040	T40	100	80	10
54610045	T45	100	80	10
54610050	T50	100	80	10
54610055	T55	100	80	10
54610060	T60	100	80	10
54610070	T70	100	80	10

547055.../547100... 1/2" Dr. Torx Tamper Proof Bit Socket

Color Box



Item no.	Size	L(mm)	PCS/CTN	Box
54705520	TP20	55	160	10
54705525	TP25	55	160	10
54705527	TP27	55	160	10
54705530	TP30	55	160	10
54705540	TP40	55	160	10
54705545	TP45	55	160	10
54705550	TP50	55	160	10
54705555	TP55	55	160	10
54705560	TP60	55	160	10

Item no.	Size	L(mm)	PCS/CTN	Box
54710020	TP20	100	80	10
54710025	TP25	100	80	10
54710027	TP27	100	80	10
54710030	TP30	100	80	10
54710040	TP40	100	80	10
54710045	TP45	100	80	10
54710050	TP50	100	80	10
54710055	TP55	100	80	10
54710060	TP60	100	80	10

548055.../548100... 1/2" Dr. Spline Bit Socket

Color Box



Item no.	Size	L(mm)	PCS/CTN	Box
54805505	M5	55	80	10
54805506	M6	55	80	10
54805508	M8	55	80	10
54805509	M9	55	80	10
54805510	M10	55	80	10
54805512	M12	55	80	10
54805514	M14	55	80	10
54805516	M16	55	80	10
54805516T	MP16	55	80	10

Item no.	Size	L(mm)	PCS/CTN	Box
54810005	M5	100	80	10
54810006	M6	100	80	10
54810008	M8	100	80	10
54810009	M9	100	80	10
54810010	M10	100	80	10
54810012	M12	100	80	10
54810014	M14	100	80	10
54810016	M16	100	80	10
54810016T	MP16	100	80	10

IMPACT



WERBENCOE

 **SELTA**

94503C**3 Pcs Aluminum Impact Socket**

- 20 SET/CTN N.W.: 18 KGS G.W.: 19 KGS CUFT: 0.85'



Color Sleeve

- 6pt:17, 19, 21mm

94503TH**3 Pcs Impact Thin Wall Deep Socket Set**

- 20 SET/CTN N.W.: 18 KGS G.W.: 19 KGS CUFT: 0.85'



Color Sleeve

- 6pt:17, 19, 21mm

9857S**7 Pcs Impact Socket Set**

- 1 SET/CTN N.W.: 14 KGS G.W.: 15 KGS CUFT: 0.35'



- 6pt:24, 27, 30, 32, 36, 41, 46mm

9857DS
7 Pcs Deep Impact Socket Set

- 1 SET/CTN N.W.: 17.5 KGS G.W.: 18.5 KGS CUFT: 0.36'

 CR
MO

 1"
25mm

- 6pt:24, 27, 30, 32, 36, 41, 46mm

96510S
10 Pcs Impact Socket Set

- 3 SET/CTN N.W.: 17.5 KGS G.W.: 18.5 KGS CUFT: 0.47'

 CR
MO

 3/4"
19mm

- 6pt:17, 19, 22, 24, 27, 30, 32, 36, 41, 46mm

94512S/94512DS
12 Pcs 1/2" Dr. Impact & Deep Impact Socket Set

 CR
MO

 1/2"
12.5mm

Gloves

Item no.		size	L(mm)	PCS/CTN
94512S	Impact	1/2"	10, 12, 13, 14, 15, 16, 17, 18, 19, 21, 22, 24	10
94512DS	Deep Impact	1/2"	10, 12, 13, 14, 15, 16, 17, 18, 19, 21, 22, 24	6

94516DS

16 Pcs 1/2" Dr. Deep Impact Socket Set

- 4 SET/CTN N.W.: 20 KGS G.W.: 21 KGS CUFT: 0.7'

CR
MO



1/2"
12.5mm



- 1/2" Dr. Deep Socket:

10, 12, 13, 14, 15, 16, 17, 18, 19, 21,
22, 24, 27, 30, 32, 36mm

94515S

15 Pcs 1/2" Dr. Impact Socket Set

- 5 SET/CTN N.W.: 11 KGS G.W.: 12 KGS CUFT: 0.3'

CR
MO



1/2"
12.5mm



Gloves

- 1/2" Dr. Socket:

10, 12, 13, 14, 15, 16, 17, 18, 19, 21,
22, 24, 27, 30, 32mm

904010
10 Pcs 1/2" Dr. Twist Socket Set

Color Sleeve

- Socket: 10, 11, 12, 13, 14, 15, 16, 17, 19mm
- Straight Rod: 12mm(Dia.) x 80mm(L)

903412
12 Pcs 3/8" & 1/2" Dr. Twist Socket Set



Color Sleeve

- 3/8" Dr. Sockets: 8, 10, 12, 13mm
- 1/2" Dr. Sockets: 14, 15, 16, 17, 19, 21mm
- Straight Rods:
 - Ø6.0mm x Ø8.0mm x 74mm(L)
 - Ø7.0mm x Ø12.0mm x 80mm(L)

902415
15 Pcs 1/4" & 1/2" Dr. Twist Socket Set

Color Sleeve

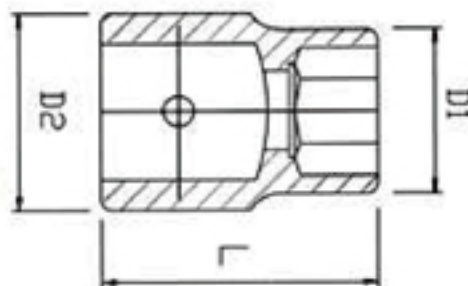
- 1/4" Dr. Sockets: 6, 8, 10, 11, 12mm
- 1/2" Dr. Sockets: 13, 14, 15, 17, 19, 21, 24, 27mm
- Straight Rods:
 - Ø6.0mm x Ø8.0mm x 74mm(L)
 - Ø7.0mm x Ø12.0mm x 80mm(L)



Color Box

3/8" Dr. Impact Socket

Item no.	size	L(mm)	D1(mm)	D2(mm)	PCS/CTN	Box
93506	6mm	32	19	10.8	240	20
93507	7mm	32	19	12.1	240	20
93508	8mm	32	19	13.5	240	20
93509	9mm	32	19	14.6	240	20
93510	10mm	32	19	15.9	240	20
93511	11mm	32	19	17.2	240	20
93512	12mm	32	19	18.4	240	20
93513	13mm	32	22	19.6	240	20
93514	14mm	32	22	20.9	180	15
93515	15mm	32	22	22.0	180	15
93516	16mm	32	22	23.4	180	15
93517	17mm	32	22	24.6	180	15
93518	18mm	32	22	25.9	120	10
93519	19mm	32	22	27.1	120	10
93520	20mm	32	22	28.7	120	10
93521	21mm	32	22	30.3	120	10
93522	22mm	32	22	31.6	120	10

1/2" Dr. Impact Socket

Item no.	size	L(mm)	D1(mm)	D2(mm)	PCS/CTN	Box
94508	8mm	38	24	14.6	240	10
94509	9mm	38	24	15.8	240	10
94510	10mm	38	25	17.1	240	10
94511	11mm	38	25	18.4	240	10
94512	12mm	38	25	19.6	240	10
94513	13mm	38	25	20.8	240	10
94514	14mm	38	25	22.1	240	10
94515	15mm	38	30	23.3	240	10
94516	16mm	38	30	24.6	240	10
94517	17mm	38	30	25.8	160	10
94518	18mm	38	30	27.1	160	10
94519	19mm	38	30	28.3	160	10
94520	20mm	38	30	29.5	160	10
94521	21mm	38	30	30.8	160	10
94522	22mm	38	30	32.3	120	10
94523	23mm	38	30	33.3	120	10
94524	24mm	43	30	34.6	120	10
94525	25mm	43	30	35.8	80	10
94526	26mm	43	30	37.0	80	10
94527	27mm	43	30	38.3	80	10
94528	28mm	48	30	39.5	80	10
94529	29mm	48	30	40.8	80	10
94530	30mm	48	30	42.1	80	10
94532	32mm	48	30	43.3	80	10
94533	33mm	48	30	45.0	60	10
94534	34mm	48	30	46.0	60	10
94536	36mm	48	30	50.0	48	8

965.../985...

3/4" & 1" Dr. Impact Socket

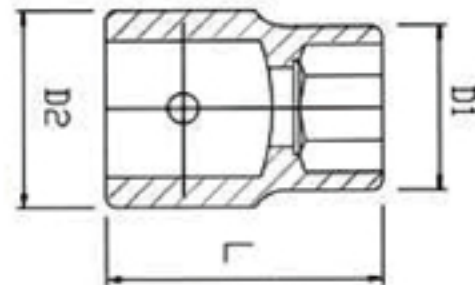

Color Box

3/4" Dr. Impact Socket

Item no.	size	L(mm)	D1(mm)	D2(mm)	PCS/CTN	Box
96517	17mm	50	30.1	44	48	6
96518	18mm	50	31.4	44	48	6
96519	19mm	50	32.6	44	48	6
96520	20mm	50	33.8	44	48	6
96521	21mm	50	35.1	44	48	6
96522	22mm	50	36.6	44	48	6
96524	24mm	50	38.9	44	48	6
96525	25mm	50	40.1	44	48	6
96527	27mm	53	42.6	44	48	6
96529	29mm	53	45.1	44	32	4
96530	30mm	53	46.4	44	32	4
96532	32mm	56	48.9	44	32	4
96533	33mm	56	50.6	44	32	4
96534	34mm	56	51.4	44	32	4
96535	35mm	56	52.7	44	32	4
96536	36mm	56	53.9	44	32	4
96538	38mm	57	56.4	44	32	4
96541	41mm	57	60.1	44	32	4
96546	46mm	62	66.4	44	32	4
96550	50mm	72	71.4	54	12	2
96555	55mm	75	77.0	54	12	2
96560	60mm	77	84.0	54	12	2
96565	65mm	78	88.0	54	8	2
96570	70mm	85	96.0	54	8	2

1" Dr. Impact Socket

Item no.	size	L(mm)	D1(mm)	D2(mm)	PCS/CTN	Box
98522	22mm	58	40	54	32	4
98524	24mm	58	42	54	32	4
98527	27mm	58	46	54	32	4
98530	30mm	60	52	54	24	4
98532	32mm	60	52	54	24	4
98533	33mm	60	55	54	24	4
98534	34mm	62	55	54	24	4
98536	36mm	65	56	54	24	4
98538	38mm	65	59	54	24	4
98540	40mm	67	62	54	24	4
98541	41mm	67	63	54	24	4
98542	42mm	74	64	54	24	4
98546	46mm	74	69	54	16	4
98550	50mm	80	74	54	16	4
98551	51mm	80	76	54	16	4
98552	52mm	84	77	54	8	4
98555	55mm	84	80	54	8	2
98556	56mm	84	81	54	8	2
98560	60mm	87	86	54	8	2
98565	65mm	90	92	54	4	2
98570	70mm	96	99	54	4	2
98575	75mm	98	104	86	4	1
98580	80mm	100	109	86	4	1
98585	85mm	100	115	86	4	1
98590	90mm	105	119	86	2	1
98595	95mm	106	130	86	2	1
985100	100mm	112	135	86	2	1
985105	105mm	112	145	127	2	1
985110	110mm	122	150	127	2	1
985115	115mm	122	155	127	2	1

9125...

1-1/2" Dr. Impact Socket

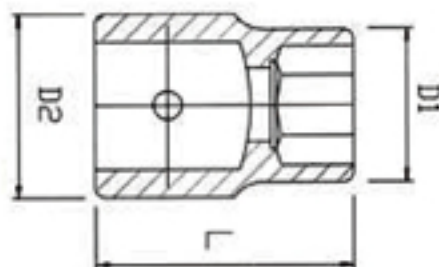

1-1/2" Dr. Impact Socket

Item no.	size	L(mm)	D1(mm)	D2(mm)	PCS/CTN
912532	32mm	75	60	86	1
912533	33mm	75	60	86	1
912534	34mm	75	60	86	1
912535	35mm	75	60	86	1
912536	36mm	80	64	86	1
912537	37mm	80	64	86	1
912538	38mm	80	64	86	1
912539	39mm	80	70	86	1
912540	40mm	80	70	86	1
912541	41mm	80	70	86	1
912542	42mm	80	70	86	1
912543	43mm	80	75	86	1
912544	44mm	80	75	86	1
912545	45mm	80	75	86	1
912546	46mm	80	75	86	1
912547	47mm	80	75	86	1
912548	48mm	82	80	86	1
912549	49mm	82	80	86	1
912550	50mm	82	80	86	1
912551	51mm	82	80	86	1
912552	52mm	82	80	86	1
912554	54mm	89	86	86	1
912555	55mm	89	86	86	1
912556	56mm	92	86	86	1
912557	57mm	92	86	86	1

Item no.	size	L(mm)	D1(mm)	D2(mm)	PCS/CTN
912558	58mm	92	92	86	1
912559	59mm	92	92	86	1
912560	60mm	92	92	86	1
912561	61mm	96	96	86	1
912562	62mm	96	96	86	1
912565	65mm	96	100	86	1
912567	67mm	101	103	86	1
912570	70mm	101	105	86	1
912573	73mm	105	109	86	1
912575	75mm	105	109	86	1
912576	76mm	110	115	86	1
912577	77mm	110	115	86	1
912580	80mm	110	115	86	1
912585	85mm	116	121	86	1
912586	86mm	116	127	86	1
912590	90mm	118	130	86	1
912595	95mm	118	135	127	1
9125100	100mm	125	140	127	1
9125105	105mm	125	150	127	1
9125110	110mm	137	155	127	1
9125115	115mm	137	160	127	1
9125120	120mm	145	165	127	1
9125125	125mm	145	170	127	1
9125130	130mm	145	175	127	1

9205.../9285...
2-1/2" & 3-1/2" Dr. Impact Socket
2-1/2" Dr. Impact Socket

Item no.	size	L(mm)	D1(mm)	D2(mm)	PCS/CTN
920541	41mm	115	104	127	1
920542	42mm	115	104	127	1
920543	43mm	115	104	127	1
920544	44mm	115	104	127	1
920545	45mm	115	104	127	1
920546	46mm	115	104	127	1
920547	47mm	115	104	127	1
920548	48mm	115	104	127	1
920549	49mm	115	104	127	1
920550	50mm	115	104	127	1
920551	51mm	115	104	127	1
920552	52mm	115	104	127	1
920554	54mm	115	104	127	1
920555	55mm	115	104	127	1
920556	56mm	115	104	127	1
920557	57mm	115	104	127	1
920558	58mm	115	104	127	1
920559	59mm	115	104	127	1
920560	60mm	115	104	127	1
920561	61mm	115	104	127	1
920562	62mm	115	104	127	1
920565	65mm	115	104	127	1
920567	67mm	115	104	127	1
920570	70mm	115	104	127	1
920573	73mm	125	115	127	1
920575	75mm	125	115	127	1
920576	76mm	125	115	127	1
920577	77mm	125	115	127	1
920580	80mm	125	115	127	1
920585	85mm	130	115	127	1

Item no.	size	L(mm)	D1(mm)	D2(mm)	PCS/CTN
920586	86mm	130	127	127	1
920590	90mm	132	135	127	1
920595	95mm	132	140	127	1
9205100	100mm	141	145	127	1
9205105	105mm	141	150	127	1
9205110	110mm	150	160	127	1
9205115	115mm	150	165	127	1
9205120	120mm	158	170	127	1
9205125	125mm	158	170	127	1
9205130	130mm	174	180	127	1
9205135	135mm	174	190	127	1
9205140	140mm	176	190	127	1
9205145	145mm	182	200	150	1
9205150	150mm	190	210	150	1
9205155	155mm	190	210	150	1
9205160	160mm	194	220	150	1
9205165	165mm	201	230	175	1
9205170	170mm	201	230	175	1
9205175	175mm	208	240	175	1
9205180	180mm	214	240	175	1
9205185	185mm	214	250	175	1
9205190	190mm	218	260	175	1
9205195	195mm	222	260	175	1
9205200	200mm	226	270	175	1
9205210	210mm	232	280	175	1
9205215	215mm	239	290	175	1
9205225	225mm	258	300	175	1
9205230	230mm	258	310	175	1
9205235	235mm	275	310	175	1

3-1/2" Dr. Impact Socket

Item no.	size	L(mm)	D1(mm)	D2(mm)	PCS/CTN
9285100	100mm	165	175	175	1
9285105	105mm	165	175	175	1
9285110	110mm	174	175	175	1
9285115	115mm	174	175	175	1
9285120	120mm	182	175	175	1
9285125	125mm	182	175	175	1
9285130	130mm	190	180	175	1
9285135	135mm	198	190	175	1
9285140	140mm	205	200	175	1
9285145	145mm	212	210	175	1
9285150	150mm	212	210	175	1
9285155	155mm	214	220	175	1
9285160	160mm	218	220	175	1

Item no.	size	L(mm)	D1(mm)	D2(mm)	PCS/CTN
9285165	165mm	230	230	175	1
9285170	170mm	230	240	175	1
9285175	175mm	230	250	175	1
9285180	180mm	237	250	175	1
9285185	185mm	237	260	175	1
9285190	190mm	242	260	175	1
9285195	195mm	246	270	175	1
9285200	200mm	249	280	175	1
9285210	210mm	256	290	175	1
9285215	215mm	263	300	175	1
9285225	225mm	273	310	175	1
9285230	230mm	276	310	175	1
9285235	235mm	279	320	175	1

93585.../94585...

3/8" & 1/2" Dr. Deep Impact Socket

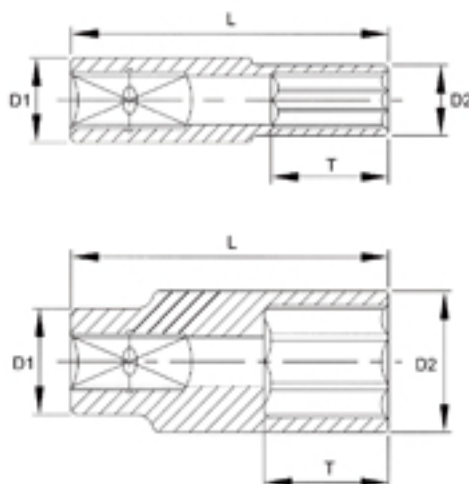

Color Box

3/8" Dr. Deep Impact Socket

Item no.	size	L(mm)	D1(mm)	D2(mm)	PCS/CTN	Box
9358506	6mm	63	19	10.8	240	----
9358507	7mm	63	19	12.1	240	----
9358508	8mm	63	19	13.5	240	----
9358509	9mm	63	19	14.6	240	----
9358510	10mm	63	19	15.9	240	----
9358511	11mm	63	19	17.2	240	----
9358512	12mm	63	19	18.4	240	----
9358513	13mm	63	22	19.6	180	----
9358514	14mm	63	22	20.9	180	----
9358515	15mm	63	22	22.0	180	----
9358516	16mm	63	22	23.4	180	----
9358517	17mm	63	22	24.6	150	----
9358518	18mm	63	22	25.9	150	----
9358519	19mm	63	22	27.1	150	----
9358520	20mm	63	22	28.7	150	----
9358521	21mm	63	22	30.3	150	----
9358522	22mm	63	22	31.6	150	----

1/2" Dr. Deep Impact Socket

Item no.	size	L(mm)	D1(mm)	D2(mm)	PCS/CTN	Box
9458508	8mm	78	24	14.6	120	10
9458509	9mm	78	24	15.8	120	10
9458510	10mm	78	25	17.1	120	10
9458511	11mm	78	25	18.4	120	10
9458512	12mm	78	25	19.6	120	10
9458513	13mm	78	25	20.8	120	10
9458514	14mm	78	25	22.1	120	10
9458515	15mm	78	30	24.0	120	10
9458516	16mm	78	30	24.0	60	10
9458517	17mm	78	30	26.0	60	10
9458518	18mm	78	30	28.0	60	10
9458519	19mm	78	30	28.0	60	10
9458520	20mm	78	30	30.0	60	10
9458521	21mm	78	30	30.0	60	10
9458522	22mm	78	30	32.3	60	5
9458523	23mm	78	30	33.3	60	5
9458524	24mm	78	30	34.6	60	5
9458525	25mm	78	30	35.8	40	5
9458526	26mm	78	30	37.0	40	5
9458527	27mm	78	30	38.3	40	5
9458528	28mm	78	30	39.5	40	5
9458529	29mm	78	30	40.8	40	5
9458530	30mm	78	30	42.1	40	5
9458532	32mm	78	30	44.6	40	5
9458533	33mm	78	30	45.0	40	5
9458534	34mm	78	30	46.0	40	5
9458536	36mm	78	30	50.0	40	5

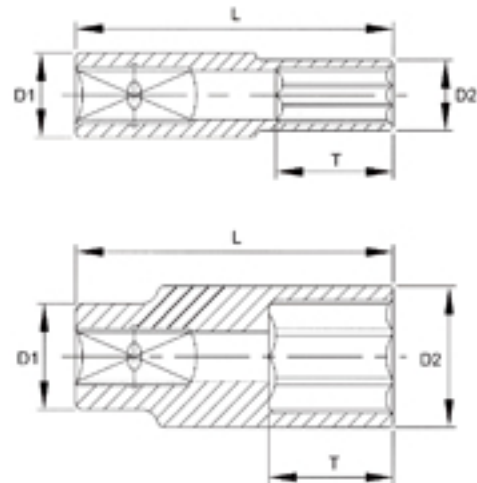
965100.../985100... 3/4" & 1" Dr. Deep Impact Socket

Color Box

3/4" Dr. Deep Impact Socket

Item no.	size	L(mm)	D1(mm)	D2(mm)	PCS/CTN	Box
96510017	17mm	90	30.1	44	24	6
96510018	18mm	90	31.4	44	24	6
96510019	19mm	90	32.6	44	24	6
96510020	20mm	90	33.8	44	24	6
96510021	21mm	90	35.1	44	24	6
96510022	22mm	90	36.6	44	24	6
96510024	24mm	90	38.9	44	24	6
96510025	25mm	90	40.1	44	24	6
96510026	26mm	90	41.3	44	24	6
96510027	27mm	90	42.6	44	24	6
96510029	29mm	90	45.1	44	24	6
96510030	30mm	90	46.4	44	16	4
96510032	32mm	90	48.9	44	16	4
96510033	33mm	90	50.6	44	16	4
96510034	34mm	90	51.4	44	16	4
96510035	35mm	90	52.7	44	16	4
96510036	36mm	90	53.9	44	16	4
96510038	38mm	90	56.4	44	16	4
96510041	41mm	90	61.4	44	16	4
96510046	46mm	90	66.4	44	12	3
96510050	50mm	90	71.4	54	12	3
96510055	55mm	90	71.4	54	12	3
96510060	60mm	90	71.4	54	12	3
96510065	65mm	90	71.4	54	12	3
96510070	70mm	90	71.4	54	12	3

1" Dr. Deep Impact Socket

Item no.	size	L(mm)	D1(mm)	D2(mm)	PCS/CTN	Box
98510022	22mm	100	40	54	18	3
98510024	24mm	100	42	54	18	3
98510027	27mm	100	46	54	18	3
98510030	30mm	100	50	54	18	3
98510032	32mm	100	52	54	18	3
98510033	33mm	100	53	54	18	3
98510034	34mm	100	55	54	18	3
98510036	36mm	100	56	54	16	1
98510038	38mm	100	59	54	16	1
98510041	41mm	100	63	54	16	1
98510042	42mm	100	64	54	16	1
98510046	46mm	100	69	54	16	1
98510050	50mm	100	74	54	8	1
98510052	52mm	100	77	54	8	1
98510055	55mm	100	80	54	8	1
98510060	60mm	120	86	54	8	1
98510065	65mm	125	92	54	4	1
98510070	70mm	125	99	54	4	1
98510075	75mm	135	104	86	4	1
98510080	80mm	135	109	86	4	1
98510085	85mm	140	115	86	4	1
98510090	90mm	140	125	86	2	1
985100100	100mm	140	137	95	2	1
985100105	105mm	155	143	95	2	1
985100110	110mm	155	147	95	2	1
985100115	115mm	155	152	95	2	1

9085

8 Pcs 1/2" Dr. Impact Spline Bit Socket Set



Color Sleeve



- Size: M5, M6, M8, M10, M12, M14, M16, M18

9086

8 Pcs 1/2" Dr. Impact Ribe Bit Socket Set



Color Sleeve



- Size: RM5, RM6, RM7, RM8, RM9, RM10, RM12, RM14

9087

8 Pcs 1/2" Dr. Impact Hex Bit Socket Set

- 10 SET/CTN N.W.: 12 KGS
G.W.: 13 KGS CUFT: 0.67'



Color Sleeve



- Size: H5, H6, H8, H10, H12, H14, H17, H19

9088

8 Pcs 1/2" Dr. Impact Torx Bit Socket Set

- 10 SET/CTN N.W.: 12 KGS
G.W.: 13 KGS CUFT: 0.67'



Color Sleeve



- Size: T30, T40, T45, T50, T55, T60, T70, T80

944...

1/2" Dr. Impact Hex Socket Bit 40L

946...

1/2" Dr. Impact Star Socket Bit 40L



Color Box



Item no.	size	L(mm)	PCS/CTN
94405	H5	40	120
94406	H6	40	120
94408	H8	40	120
94410	H10	40	120
94412	H12	40	120
94414	H14	40	120
94417	H17	40	80
94419	H19	40	80



Color Box



Item no.	size	L(mm)	PCS/CTN
94630	T30	40	120
94640	T40	40	120
94645	T45	40	120
94650	T50	40	120
94655	T55	40	120
94660	T60	40	120

964...

3/4" Dr. Impact Hex Socket Bit 55L

9447.../9467...

1/2" Dr. Impact Socket Bit 78L



Color Box



Item no.	size	L(mm)	PCS/CTN
96414	H14	55	80
96417	H17	55	80
96419	H19	55	80
96422	H22	55	80
96424	H24	55	80



Impact Hex Socket Bit

Item no.	size	L(mm)	PCS/CTN
9447805	H5	78	120
9447806	H6	78	120
9447808	H8	78	120
9447810	H10	78	120
9447812	H12	78	120
9447814	H14	78	120
9447817	H17	78	80
9447819	H19	78	80

Impact Star Socket Bit

Item no.	size	L(mm)	PCS/CTN
9467820	T20	78	120
9467825	T25	78	120
9467827	T27	78	120
9467830	T30	78	120
9467840	T40	78	120
9467845	T45	78	120
9467850	T50	78	120
9467855	T55	78	120
9467860	T60	78	120
9467870	T70	78	80
9467880	T80	78	80



Color Box

94585... 1/2" Dr. Deep Impact Socket (Thin-Wall)

Color Box



Item no.	size	PCS/CTN
9458517TH	17mm	60
9458519TH	19mm	60
9458521TH	21mm	60

905...MPB Impact Universal Joint

Color Box

Item no.	size	PCS/CTN
90521MPB	1/4"	---
90531MPB	3/8"	---
90541MPB	1/2"	10
90561MPB	3/4"	5
90581MPB	1"	2

9046...MPB 3/4" Dr. Impact Extension Bar

Color Box



Item no.	L(mm)	inch	PCS/CTN	Box
9046100MPB	100	4"	20	10
9046150MPB	150	6"	16	8
9046175MPB	175	7"	16	8
9046200MPB	200	8"	16	8
9046250MPB	250	10"	10	5
9046325MPB	325	13"	10	5
9046400MPB	400	16"	10	5

9044...MPB 1/2" Dr. Impact Extension Bar

Color Box



Item no.	L(mm)	inch	PCS/CTN
9044075MPB	75	3"	--
9044125MPB	125	5"	80
9044250MPB	250	10"	40

9048...MPB 1" Dr. Impact Extension Bar

Item no.	L(mm)	inch	PCS/CTN
9048075MPB	75	3"	10
9048175MPB	175	7"	6
9048200MPB	200	8"	6
9048325MPB	325	13"	6
9048400MPB	400	16"	6



Color Box

90641A 1/2" Dr. Square Head

- High Quality Reduction Designed For Impact And Pneumatic Tools.
- Extremely Durable Due To the Use Of A Molybdenum Steel Alloy

90864MPB 3/4"(F) x 1/2"(M) New Impact Adapter

Color Box

909... Impact Adapter

Item no.	size	PCS/CTN
90932MPB	3/8"(F) x 1/4"(M)	240
90934MPB	3/8"(F) x 1/2"(M)	240
90943MPB	1/2"(F) x 3/8"(M)	240
90946MPB	1/2"(F) x 3/4"(M)	120
90964MPB	3/4"(F) x 1/2"(M)	100
90968MPB	3/4"(F) x 1"(M)	60
90986MPB	1"(F) x 3/4"(M)	60
909812MPB	1"(F) x 1-1/2"(M)	60
909128MPB	1-1/2"(F) x 1"(M)	60



Color Box

927.../937.../947...

1/4" & 3/8" & 1/2" Dr. Twist Socket



Color Box

- 1/4" Twist Socket

Item no.	Size(mm)	PCS/CTN
92706	6	300
92708	8	300
92710	10	300
92711	11	300
92712	12	300

- 1/2" Twist Socket

Item no.	Size(mm)	PCS/CTN
94710	10	300
94711	11	300
94712	12	300
94713	13	300
94714	14	300
94715	15	300
94716	16	300
94717	17	300
94718	18	300
94719	19	300
94721	21	300
94722	22	300
94724	24	300
94727	27	300
94728	28	300
94730	30	300
94732	32	300
94733	33	300
94734	34	300
94736	36	300

- 3/8" Twist Socket

Item no.	Size(mm)	PCS/CTN
93708	8	300
93710	10	300
93712	12	300
93713	13	300

24585...C

1/2" Dr. Rim Protective Wheel Socket



Color Box



Item no.	size	Color	PCS/CTN	Box
2458517C	17	Blue	40	5
2458519C	19	Yellow	40	5
2458521C	21	Red	40	5

3015
3/8" Dr. Stubby Ratchet Wrench

Color Box



Ratchet

- Free Speed: 350 RPM
- Anvil Size Inch: 3/8" (10)mm
- Maximum Torque Ft-lbs: 30 (40.7)Nm
- Air Inlet: 1/4" NPT
- Hose Size ID Inch: 3/8" (10)mm
- Air Consumption CFM: 4 (113) L/Min
- Length Inch: 5-1/4" (133)mm
- Weight Lbs: 0.9 (0.4)Kg
- Noise Level: 85 dB(A)

3024
3/8" Dr. Mini Ratchet Wrench

Color Box



Ratchet

- Free Speed: 200 RPM
- Anvil Size Inch: 3/8" (10)mm
- Maximum Torque Ft-lbs: 30 (41)Nm
- Working Torque Range Ft-lbs: 5~30 (7~41)Nm
- Air Inlet: 1/4" NPT
- Hose Size ID Inch: 3/8" (10)mm
- Air Consumption CFM: 4 (113) L/Min
- Length Inch: 7-3/4" (196)mm
- Weight Lbs: 1.1 (0.5)Kg
- Noise Level: 79 dB(A)

3023
1/2" Dr. Air Ratchet Wrench

Color Box



Ratchet

- Free Speed: 150 RPM
- Anvil Size Inch: 1/2" (13)mm
- Maximum Torque Ft-lbs: 50(68)Nm
- Working Torque Range Ft-lbs: 10~50 (14~68)Nm
- Air Inlet: 1/4" NPT
- Hose Size ID Inch: 3/8" (10)mm
- Air Consumption CFM: 4 (113) L/Min
- Length Inch: 10.1" (256)mm
- Weight Lbs: 2.6 (1.2)Kg
- Noise Level: 79 dB(A)

3117
1/2" Dr. Impact Ratchet Wrench

Color Box



Pin Clutch

- Free Speed: 600 RPM
- Anvil Size Inch: 1/2" (12.7)mm
- Maximum Torque Ft-lbs: 90(122)Nm
- Air Inlet: 1/4" NPT
- Hose Size ID Inch: 3/8" (10)mm
- Air Consumption CFM: 4 (113) L/Min
- Length Inch: 11" (280)mm
- Weight Lbs: 2.82 (1.28)Kg
- Noise Level: 90 dB(A)

4012P
3/8" Dr. Impact Wrench

Twin Hammer

Color Box

- Free Speed: 11000 RPM
- Anvil Size Inch: 3/8" (10)mm
- Maximum Torque Ft-lbs: 430 (583)Nm
- Working Torque Range Ft-lbs: 25~250 (34~338)Nm
- Air Inlet: 1/4" NPT
- Hose Size ID Inch: 3/8" (10)mm
- Air Consumption CFM: 4 (113) L/Min
- Length Inch: 6" (153)mm
- Weight Lbs: 2.6 (1.2)Kg
- Noise Level: 83 db(A)

4412P
1/2" Dr. Mini Impact Wrench

Color Box

- Free Speed: 11000 RPM
- Anvil Size Inch: 1/2" (13)mm
- Maximum Torque Ft-lbs: 960 (1302)Nm
- Working Torque Range Ft-lbs: 25~250 (34~338)Nm
- Air Inlet: 1/4" NPT
- Hose Size ID Inch: 3/8" (10)mm
- Air Consumption CFM: 4 (113) L/Min
- Length Inch: 6" (153)mm
- Weight Lbs: 2.6 (1.2)Kg
- Noise Level: 83 db(A)

4033P2
1/2" Dr. Impact Wrench

Pin Clutch

Color Box

- Free Speed: 7000 RPM
- Anvil Size Inch: 1/2" (13)mm
- Maximum Torque Ft-lbs: 1,000 (1,375)Nm
- Working Torque Range Ft-lbs: 50~650 (68~882)Nm
- Air Inlet: 1/4" NPT
- Hose Size ID Inch: 3/8" (10)mm
- Average Air Consumption CFM: 4 (113) L/Min
- Length Inch: 7-3/16" (183)mm
- Weight Lbs: 4 (1.9)Kg
- Noise Level: 83 dB(A)

4033P
1/2" Dr. Impact Wrench

Twin Hammer

Color Box

- Free Speed: 7000 RPM
- Anvil Size Inch: 1/2" (13)mm
- Maximum Torque Ft-lbs(Reverse): 820 (1,112)Nm
- Working Torque Range Ft-lbs: 50~580 (68~786)Nm
- Air Inlet: 1/4" NPT
- Hose Size ID Inch: 3/8" (10)mm
- Average Air Consumption CFM: 4 (113) L/Min
- Length Inch: 7-3/16" (183)mm
- Weight Lbs: 4 (1.9)Kg
- Noise Level: 83 dB(A)

4033PL 1/2" Dr. Impact Wrench

Twin Hammer

- Free Speed: 7000 RPM
- Anvil Size Inch: 1/2" (13)mm
- Maximum Torque Ft-lbs(Reverse): 820 (1,112)Nm
- Working Torque Range Ft-lbs: 50~580 (68~786)Nm
- Air Inlet: 1/4" NPT
- Hose Size ID Inch: 3/8" (10)mm
- Average Air Consumption CFM: 4 (113) L/Min
- Length Inch: 9-1/4" (236)mm
- Weight Lbs: 4.4 (2.0)Kg
- Noise Level: 83 dB(A)



Color Box

4037G 1/2" Dr. Impact Wrench

Twin Hammer

- Free Speed: 8000 RPM
- Anvil Size Inch: 1/2" (13)mm
- Maximum Torque Ft-lbs(Reverse): 900 (1,220) Nm
- Working Torque Range Ft-lbs: 50~700 (68~949) Nm
- Air Inlet: 1/4" NPT
- Hose Size ID Inch: 3/8" (10)mm
- Average Air Consumption CFM: 6 (170) L/Min
- Length Inch: 7-3/8" (185)mm
- Weight Lbs: 6 (2.7) kg



Color Box

4051P 3/4" Dr. Impact Wrench

Twin Hammer

- Free Speed: 5500 RPM
- Anvil Size Inch: 3/4" (19)mm
- Maximum Torque Ft-lbs(Reverse): 1,500 (2,034)Nm
- Working Torque Range Ft-lbs: 200~1,200 (271~1,627)Nm
- Air Inlet: 3/8" NPT
- Hose Size ID Inch: 1/2"(13)mm
- Average Air Consumption CFM: 7 (198) L/Min
- Length Inch: 8-1/2" (215)mm
- Weight Lbs: 7.5 (3.4)Kg
- Noise Level: 90 dB(A)



Color Box

4051PL 3/4" Dr. Impact Wrench

Twin Hammer

- Free Speed: 5500 RPM
- Anvil Size Inch: 3/4" (19)mm
- Maximum Torque Ft-lbs(Reverse): 1,500 (2,034)Nm
- Working Torque Range Ft-lbs: 200~1,200 (271~1,627)Nm
- Air Inlet: 3/8" NPT
- Hose Size ID Inch: 1/2" (13)mm
- Average Air Consumption CFM: 7 (198) L/Min
- Length Inch: 14-1/2" (368)mm
- Weight Lbs: 8.8 (4.0)Kg
- Noise Level: 90 dB(A)



Color Box

4051P1 1" Dr. Impact Wrench

Twin Hammer

- Free Speed: 5500 RPM
- Anvil Size Inch: 1" (25.4)mm
- Maximum Torque Ft-lbs(Reverse): 1,500 (2,034)Nm
- Working Torque Range Ft-lbs: 200~1,200 (271~1,627)Nm
- Air Inlet: 3/8" NPT
- Hose Size ID Inch: 1/2" (13)mm
- Average Air Consumption CFM: 7 (198) L/Min
- Length Inch: 8-3/4" (223)mm
- Weight Lbs: 7.7 (3.5)Kg
- Noise Level: 90 dB(A)



Color Box

4071 1" Dr. Heavy Duty Impact Wrench (Pinless Clutch)

Pinless Clutch

- Free Speed: 5000 RPM
- Anvil Size Inch: 1" (25.4)mm
- Maximum Torque Ft-lbs(Reverse): 2,200 (2,983)Nm
- Working Torque Range Ft-lbs: 400~1,650 (542~2,237)Nm
- Air Inlet: 1/2" NPT
- Hose Size ID Inch: 1/2" (13)mm
- Average Air Consumption CFM: 10 (282) L/Min
- Length Inch: 14" (346)mm
- Weight Lbs: 23.3 (10.56)Kg



Color Box

4072
1" Dr. Heavy Duty Impact Wrench (Twin Hammer)

Twin Hammer

- Free Speed: 5000 RPM
- Anvil Size Inch: 1" (25.4)mm
- Maximum Torque Ft-lbs(Reverse): 2,500 (3,390)Nm
- Working Torque Range Ft-lbs: 400~1,800 (542~2,441)Nm
- Air Inlet: 1/2" NPT
- Hose Size ID Inch: 1/2" (13)mm
- Average Air Consumption CFM: 10 (282) L/Min
- Length Inch: 16.2" (412)mm
- Weight Lbs: 22 (10)Kg



Color Box

4072L6
1" Dr. Heavy Duty Impact Wrench (Twin Hammer)

Twin Hammer

- Free Speed: 5000 RPM
- Anvil Size Inch: 1" (25.4)mm
- Maximum Torque Ft-lbs(Reverse): 2,500 (3,390)Nm
- Working Torque Range Ft-lbs: 400~1,800 (542~2,441)Nm
- Air Inlet: 1/2" NPT
- Hose Size ID Inch: 1/2" (13)mm
- Average Air Consumption CFM: 10 (282) L/Min
- Length Inch: 20-1/4" (514)mm
- Weight Lbs: 24 (10.9)Kg



Color Box

4073
1" Dr. Heavy Duty Impact Wrench

Twin Hammer

- Free Speed: 6000 RPM
- Anvil Size Inch: 1" (25.4)mm
- Maximum Torque Ft-lbs(Reverse): 1,800 (2,441)Nm
- Working Torque Range Ft-lbs: 200~1,500 (271~2,033)Nm
- Air Inlet: 1/2" NPT
- Hose Size ID Inch: 1/2" (13)mm
- Average Air Consumption CFM: 10 (282) L/Min
- Length Inch: 12-3/4"(324)mm
- Weight Lbs: 14.3(6.5)Kg
- Noise Level: 96 dB(A)



Color Box

4081

Air Hammer

- Packing (1 Carton) : 10 pcs/1 cu.ft/G:21 kgs



- Round Shank
- Chisel Shank : 10.2 mm
- Piston Stroke : 89 mm
- Stroke Speed : 2,100 bpm
- Net Weights : 2.0 kgs
- Length : 225 mm
- Air Cons. : 0.42 m3/min
- Air Inlet : 1/4"
- Hose Size : 6.5 mm
- Sound Pressur : 96 dBA
- Vibration : 13.5 m/s²
- Air Pressure : 90 psi



Color Box

4033PK

1/2" Dr. Impact Wrench Set



- 1pc 1/2" Dr. Impact Wrench
- 3pcs Impact Socket: 17-19-21 mm
- 3pcs Deep Socket With Sleeve: 17-19-21 mm
- 1pc Blow Mold Case

75-5505 & 75-5512

8mm High Pressure Air Blower Gun



- With Steel Reinforced Inlet
- Body Material:POM
- Port Size: 1/4"(PT, NPT, G)
- Max. Pressure:175 PSI (12Bar/1.2Mpa)
- Nozzle Length(cm/ inch):
 - 75-5505: 100mm(4")
 - 75-5512: 270mm(10.6")

050815H - 101515H Pu Braid Hose

Item no.	size
050815H	5mm(I.D) x 8mm(O.D) x 15m(L)
081205H	8mm(I.D) x 12mm(O.D) x 5m(L)
081210H	8mm(I.D) x 12mm(O.D) x 10m(L)
651015H	6.5mm(I.D) x 10mm(O.D) x 15m(L)
101515H	10mm(I.D) x 15mm(O.D) x 15m(L)

0812... Pu Braid Hose (UEC + OP + Spring)

Item no.	size
081205HU	8mm(I.D) x 12mm(O.D) x 5m(L)
081210HU	8mm(I.D) x 12mm(O.D) x 10m(L)
081215HU	8mm(I.D) x 12mm(O.D) x 15m(L)

75-20PFA Quick Coupler Connector

- 1/4" Hose Plug Steel
- N.W: 10.35 kgs
- G.W: 12.35 kgs
- CUFT: 1.22'
- CTN: 500/CTN

75-20PMA Quick Coupler Connector

- 1/4" Hose Plug Steel
- N.W: 12.50 kgs
- G.W: 14.50 kgs
- CUFT: 1.22'
- CTN: 500/CTN

75-25PHA Quick Coupler Connector

- 5/16" Hose Plug Europe Type Steel
- N.W: 12.75 kgs
- G.W: 14.75 kgs
- CUFT: 1.22'
- CTN: 500/CTN

75-30PHA Quick Coupler Connector

- 1/4" Hose Plug Steel
- N.W: 11.90 kgs
- G.W: 13.90 kgs
- CUFT: 1.22'
- CTN: 500/CTN

75-20SFA Quick Coupler Connector

- 1/4" Female:Socket Universal
- N.W: 18.60 kgs
- G.W:20.40 kgs
- CUFT: 0.89'
- CTN: 200/CTN

75-20SMA Quick Coupler Connector

- 1/4" Male Socket Universal Steel
- N.W: 17.30 kgs
- G.W: 19.90 kgs
- CUFT: 0.89'
- CTN: 200/CTN

75-20SHA Quick Coupler Connector

- 1/4" Hose Socket Universal Steel
- N.W: 16.70 kgs
- G.W: 18.50 kgs
- CUFT: 0.89'
- CTN: 200/CTN

75-30SHA Quick Coupler Connector

- 3/8" Hose Socket Universal Steel
- N.W: 17.80 kgs
- G.W: 19.80 kgs
- CUFT: 0.89'
- CTN: 200/CTN

90215 5pcs Brass Quick Coupler Connector Set

BEST CHOICE 



- Stainless Steel Ball Bearing Rings
- 1/4" NPT Pins
- 1 pcs Quick Coupler
- 3 pcs Male Plug (1/4" NPT)
- 1 pcs Female Plug (1/4" NPT)

BITS SETS & BITS

1/4" · 25mm136

1/4" · 30mm139

1/4" · 50/65mm140

5/16" · 30mm142

5/16" · 75mm144

10H · 30/75mm145

1/4H · 65mm147

1/4H · 110mm147

The SELTA logo features a stylized red 'S' inside a white circle, followed by the word 'SELTA' in a bold, black, sans-serif font.

SELTA

4140
40 Pcs 3/8" & 1/2" Dr. Bits Set

- 5 SET/CTN N.W.: 9 KGS G.W.: 10 KGS CUFT: 0.37'

S2
Cr-V
3/8"
10mm
1/2"
12.5mm

Contents:

- 1pc 1/2" Dr. Coupler 10mm
- 1pc 3/8" Dr. Coupler 10mm
- 19pcs 10mm Bit 30mmL:
 - (Torx): T20, T25, T30, T40, T45, T50, T55
 - (Hex): H4, H5, H6, H7, H8, H10, H12
 - (Spline): M5, M6, M8, M10, M12
- 19pcs 10mm Bit 75mmL:
 - (Torx): T20, T25, T30, T40, T45, T50, T55
 - (Hex): H4, H5, H6, H7, H8, H10, H12
 - (Spline): M5, M6, M8, M10, M12

4140P
40 Pcs 3/8" & 1/2" Dr. Bits Set

- 10 SET/CTN N.W.: 20 KGS G.W.: 21 KGS CUFT: 0.79'

Cr-V
3/8"
10mm
1/2"
12.5mm

Contents:

- 1pc 1/2" Dr. Coupler 10mm
- 1pc 3/8" Dr. Coupler 10mm
- 19pcs 10mm Bit 30mmL:
 - (Torx): T20, T25, T30, T40, T45, T50, T55
 - (Hex): H4, H5, H6, H7, H8, H10, H12
 - (Spline): M5, M6, M8, M10, M12
- 19pcs 10mm Bit 75mmL:
 - (Torx): T20, T25, T30, T40, T45, T50, T55
 - (Hex): H4, H5, H6, H7, H8, H10, H12
 - (Spline): M5, M6, M8, M10, M12

2071
71 Pcs Color Ring Bits Set

- 24 SET/CTN N.W.: 18 KGS G.W.: 19 KGS CUFT: 0.6'



Also Available In Blue Color Box.

Contents:

- 25mm Color Ring Bits:
 - 12pcs Phillips: PH1 x 3, PH2 x 6, PH3 x 3
 - 12pcs Pozidrive: PZ1 x 3, PZ2 x 6, PZ3 x 3
 - 6pcs Slotted: SL4 x 3, SL6 x 3
 - 9pcs Hexagon: 4 x 3, 5 x 3, 6 x 3
 - 21pcs Torx: T10 x 3, T25 x 3, T20 x 3, T25 x 3, T27 x 3, T30 x 3, T40 x 3
- 75mm Color Ring Bits:
 - 3pcs Phillips: PH1, PH2, PH3
 - 2pcs Pozidrive: PZ1, PZ2
 - 2pcs Slotted: SL4, SL6
 - 2pcs Torx: T20, T25
- 60mm Stainless Magnetic Bit Holder
- 65mm Curvy Magnetic Bit Holder

4111M
11 Pcs Power Bit Set (Spline)

- 20 SETS/CTN N.W.: 12.6KGS G.W.: 13.6KGS CUFT: 0.69'

S2
Cr-V
3/8"
10mm
1/2"
12.5mm

- Contents:

- 5pcs 10mm x 30mmL Bit: M5, M6, M8, M10, M12
- 5pcs 10mm x 75mmL Bit: M5, M6, M8, M10, M12
- 1pc 1/2" x 10mm Coupler

4115H
15 Pcs Power Bit Set (Hex)

- 20 SETS/CTN N.W.: 12.6KGS G.W.: 13.6KGS CUFT: 0.69'

S2
Cr-V
3/8"
10mm
1/2"
12.5mm

- Contents:

- 7pcs 10mm x 30mmL Bit:
H4, H5, H6, H7, H8, H10, H12
- 7pcs 10mm x 75mmL Bit:
H4, H5, H6, H7, H8, H10, H12
- 1pc 1/2" x 10mm Coupler

4115R
15 Pcs Power Bit Set (Ribe)

- 20 SETS/CTN N.W.: 12.6KGS G.W.: 13.6KGS CUFT: 0.69'

S2
Cr-V
3/8"
10mm
1/2"
12.5mm

- Contents:

- 7pcs 10mm x 30mmL Bit:
RM6, RM7, RM8, RM9, RM10, RM12, RM14
- 7pcs 10mm x 75mmL Bit:
RM6, RM7, RM8, RM9, RM10, RM12, RM14
- 1pc 1/2" x 10mm Coupler

4115T
15 Pcs Power Bit Set (Torx)

- 20 SETS/CTN N.W.: 12.6KGS G.W.: 13.6KGS CUFT: 0.69'

S2
Cr-V
3/8"
10mm
1/2"
12.5mm

- Contents:

- 7pcs 10mm x 30mmL Bit:
T20, T25, T30, T40, T45, T50, T55
- 7pcs 10mm x 75mmL Bit:
T20, T25, T30, T40, T45, T50, T55
- 1pc 1/2" x 10mm Coupler

1/4" · 25mm

S2

1/4"

25 mm



52125... 1/4" Phillips Bit



Item no.	size	L(mm)	⌀	PCS/CTN	Box
521250	PH0	25	10	120	20
521251	PH1	25	10	120	20
521252	PH2	25	10	120	20
521253	PH3	25	10	120	20
521254	PH4	25	10	120	20

52225... 1/4" Pozidriv Bit



Item no.	size	L(mm)	⌀	PCS/CTN	Box
522250	PZ0	25	10	120	20
522251	PZ1	25	10	120	20
522252	PZ2	25	10	120	20
522253	PZ3	25	10	120	20
522254	PZ4	25	10	120	20

52325... 1/4" Slotted Bit



Item no.	size	L(mm)	⌀	PCS/CTN	Box
5232503	SL3	25	10	120	20
52325035	SL3.5	25	10	120	20
5232504	SL4	25	10	120	20
52325045	SL4.5	25	10	120	20
5232505	SL5	25	10	120	20
52325055	SL5.5	25	10	120	20
5232506	SL6	25	10	120	20
52325065	SL6.5	25	10	120	20
5232507	SL7	25	10	120	20
5232508	SL8	25	10	120	20

52425... 1/4" Hex Bit



Item no.	size	L(mm)	⌀	PCS/CTN	Box
52425015	H1.5	25	10	120	20
5242502	H2	25	10	120	20
52425025	H2.5	25	10	120	20
5242503	H3	25	10	120	20
5242504	H4	25	10	120	20
5242505	H5	25	10	120	20
5242506	H6	25	10	120	20
5242507	H7	25	10	120	20
5242508	H8	25	10	120	20
5242510	H10	25	10	120	20
524255.32	5/32"	25	10	120	20
524253.16	3/16"	25	10	120	20
524257.32	7/32"	25	10	120	20
524251.4	1/4"	25	10	120	20
524255.16	5/16"	25	10	120	20

1/4" · 25mm

S2

1/4"

25 mm



52P25... 1/4" Hex Security Bit



Item no.	size	L(mm)	⌀	PCS/CTN	Box
52P2502	HP2	25	10	120	20
52P25025	HP2.5	25	10	120	20
52P2503	HP3	25	10	120	20
52P2504	HP4	25	10	120	20
52P2505	HP5	25	10	120	20
52P2506	HP6	25	10	120	20
52P2507	HP7	25	10	120	20
52P2508	HP8	25	10	120	20
52P2510	HP10	25	10	120	20

52S25... 1/4" Square Bit



Item no.	size	L(mm)	⌀	PCS/CTN	Box
52S250	S0	25	10	120	20
52S251	S1	25	10	120	20
52S252	S2	25	10	120	20
52S253	S3	25	10	120	20

52625... 1/4" Torx Bit



Item no.	size	L(mm)	⌀	PCS/CTN	Box
5262504	T4	25	10	120	20
5262505	T5	25	10	120	20
5262506	T6	25	10	120	20
5262507	T7	25	10	120	20
5262508	T8	25	10	120	20
5262509	T9	25	10	120	20
5262510	T10	25	10	120	20
5262515	T15	25	10	120	20
5262520	T20	25	10	120	20
5262525	T25	25	10	120	20
5262527	T27	25	10	120	20
5262530	T30	25	10	120	20
5262535	T35	25	10	120	20
5262540	T40	25	10	120	20
5262545	T45	25	10	120	20
5262550	T50	25	10	120	20

52725... 1/4" Tamper Proof Bit



Item no.	size	L(mm)	⌀	PCS/CTN	Box
5272506	TP6	25	10	120	20
5272507	TP7	25	10	120	20
5272508	TP8	25	10	120	20
5272509	TP9	25	10	120	20
5272510	TP10	25	10	120	20
5272515	TP15	25	10	120	20
5272520	TP20	25	10	120	20
5272525	TP25	25	10	120	20
5272527	TP27	25	10	120	20
5272530	TP30	25	10	120	20
5272535	TP35	25	10	120	20
5272540	TP40	25	10	120	20
5272545	TP45	25	10	120	20
5272550	TP50	25	10	120	20

1/4" · 25mm

S2

1/4"

25
mm



52825... 1/4" Spline Bit



Item no.	size	L(mm)	📦	PCS/CTN	Box
5282504	M4	25	10	120	20
5282505	M5	25	10	120	20
5282506	M6	25	10	120	20
5282508	M8	25	10	120	20
5282510	M10	25	10	120	20
5282512	M12	25	10	120	20

52X25... 1/4" Torq-Set Bit



Item no.	size	L(mm)	📦	PCS/CTN	Box
52X2504	X4	25	10	120	20
52X2506	X6	25	10	120	20
52X2508	X8	25	10	120	20
52X2510	X10	25	10	120	20

52Y25... 1/4" Tri Wing Bit



Item no.	size	L(mm)	📦	PCS/CTN	Box
52Y2501	Y1	25	10	120	20
52Y2502	Y2	25	10	120	20
52Y2503	Y3	25	10	120	20
52Y2504	Y4	25	10	120	20

52U25... 1/4" Spanner Bit



Item no.	size	L(mm)	📦	PCS/CTN	Box
52U2504	U4	25	10	120	20
52U2506	U6	25	10	120	20
52U2508	U8	25	10	120	20
52U2510	U10	25	10	120	20

52925... 1/4" Ribe Bit



Item no.	size	L(mm)	📦	PCS/CTN	Box
5292504	RM4	25	10	120	20
5292505	RM5	25	10	120	20
5292506	RM6	25	10	120	20
5292507	RM7	25	10	120	20
5292508	RM8	25	10	120	20
5292509	RM9	25	10	120	20
5292510	RM10	25	10	120	20

1/4" · 25mm

S2

1/4"

25 mm



52025... 1/4" Clutch Bit



Item no.	size	L(mm)		PCS/CTN	Box
5202500	C0	25	10	120	20
5202501	C1	25	10	120	20
5202502	C2	25	10	120	20
5202503	C3	25	10	120	20

52F25... 1/4" Torx Star Tamper Proof Bit



Item no.	size	L(mm)		PCS/CTN	Box
52F2510	TS10	25	10	120	20
52F2515	TS15	25	10	120	20
52F2520	TS20	25	10	120	20
52F2525	TS25	25	10	120	20
52F2527	TS27	25	10	120	20
52F2530	TS30	25	10	120	20
52F2540	TS40	25	10	120	20
52F2545	TS45	25	10	120	20

1/4" · 30mm

S2

1/4"

30 mm



52A230 1/4" Bit Adaptor



Item no.	size	L(mm)		PCS/CTN	Box
52A230	1/4"	30	10	120	20

1/4" · 50/65mm

S2

1/4"

50 mm

65 mm



52150.../52165...

1/4" Phillips Bit



Item no.	size	L(mm)	⊞	PCS/CTN	Box
5215001	PH1	50	10	120	20
5215002	PH2	50	10	120	20
5215003	PH3	50	10	120	20
5215004	PH4	50	10	120	20
5216501	PH1	65	10	120	20
5216502	PH2	65	10	120	20
5216503	PH3	65	10	120	20
5216504	PH4	65	10	120	20

52250.../52265...

1/4" Pozidriv Bit



Item no.	size	L(mm)	⊞	PCS/CTN	Box
5225001	PZ1	50	10	120	20
5225002	PZ2	50	10	120	20
5225003	PZ3	50	10	120	20
5225004	PZ4	50	10	120	20
5226501	PZ1	65	10	120	20
5226502	PZ2	65	10	120	20
5226503	PZ3	65	10	120	20
5226504	PZ4	65	10	120	20

52350.../52365...

1/4" Slotted Bit



Item no.	size	L(mm)	⊞	PCS/CTN	Box
5235003	SL3	50	10	120	20
52350035	SL3.5	50	10	120	20
5235004	SL4	50	10	120	20
52350045	SL4.5	50	10	120	20
5235005	SL5	50	10	120	20
52350055	SL5.5	50	10	120	20
5235006	SL6	50	10	120	20
52350065	SL6.5	50	10	120	20
5235008	SL8	50	10	120	20
5236503	SL3	65	10	120	20
52365035	SL3.5	65	10	120	20
5236504	SL4	65	10	120	20
52365045	SL4.5	65	10	120	20
5236505	SL5	65	10	120	20
52365055	SL5.5	65	10	120	20
5236506	SL6	65	10	120	20
52365065	SL6.5	65	10	120	20
5236508	SL8	65	10	120	20

52450.../52465...

1/4" Hex Bit



Item no.	size	L(mm)	⊞	PCS/CTN	Box
5245002	H2	50	10	120	20
52450025	H2.5	50	10	120	20
5245003	H3	50	10	120	20
5245004	H4	50	10	120	20
5245005	H5	50	10	120	20
5245006	H6	50	10	120	20
5245008	H8	50	10	120	20
5246502	H2	65	10	120	20
52465025	H2.5	65	10	120	20
5246503	H3	65	10	120	20
5246504	H4	65	10	120	20
5246505	H5	65	10	120	20
5246506	H6	65	10	120	20
5246508	H8	65	10	120	20

1/4" · 50/65mm

S2

1/4"

50 mm

65 mm



52S50.../52S65...

1/4" Square Bit



Item no.	size	L(mm)	PCS/CTN	Box
52S501	S1	50	10	20
52S502	S2	50	10	20
52S503	S3	50	10	20
52S651	S1	65	10	20
52S652	S2	65	10	20
52S653	S3	65	10	20

52650.../52665...

1/4" Torx Bit



Item no.	size	L(mm)	PCS/CTN	Box
5265005	T5	50	10	20
5265006	T6	50	10	20
5265007	T7	50	10	20
5265008	T8	50	10	20
5265009	T9	50	10	20
5265010	T10	50	10	20
5265015	T15	50	10	20
5265020	T20	50	10	20
5265025	T25	50	10	20
5265027	T27	50	10	20
5265030	T30	50	10	20
5265035	T35	50	10	20
5265040	T40	50	10	20
5266505	T5	65	10	20
5266506	T6	65	10	20
5266507	T7	65	10	20
5266508	T8	65	10	20
5266509	T9	65	10	20
5266510	T10	65	10	20
5266515	T15	65	10	20
5266520	T20	65	10	20
5266525	T25	65	10	20
5266527	T27	65	10	20
5266530	T30	65	10	20
5266535	T35	65	10	20
5266540	T40	65	10	20

5/16" · 30mm

S2

5/16"

30 mm



52130... 5/16" Phillips Bit



Item no.	size	L(mm)	⌀	PCS/CTN	Box
5213001	PH1	30	10	120	20
5213002	PH2	30	10	120	20
5213003	PH3	30	10	120	20
5213004	PH4	30	10	120	20

52230... 5/16" Pozidriv Bit



Item no.	size	L(mm)	⌀	PCS/CTN	Box
5223001	PZ1	30	10	120	20
5223002	PZ2	30	10	120	20
5223003	PZ3	30	10	120	20
5223004	PZ4	30	10	120	20

52330... 5/16" Slotted Bit



Item no.	size	L(mm)	⌀	PCS/CTN	Box
52330055	SL5.5	30	10	120	20
5233006	SL6	30	10	120	20
52330065	SL6.5	30	10	120	20
5233007	SL7	30	10	120	20
5233008	SL8	30	10	120	20
5233010	SL10	30	10	120	20
5233012	SL12	30	10	120	20

52430... 5/16" Hex Bit



Item no.	size	L(mm)	⌀	PCS/CTN	Box
5243003	H3	30	10	120	20
5243004	H4	30	10	120	20
5243005	H5	30	10	120	20
5243006	H6	30	10	120	20
5243007	H7	30	10	120	20
5243008	H8	30	10	120	20
5243009	H9	30	10	120	20
5243010	H10	30	10	120	20
5243011	H11	30	10	120	20
5243012	H12	30	10	120	20
5243013	H13	30	10	120	20
5243014	H14	30	10	120	20
5243016	H16	30	10	120	20

5/16" · 30mm

S2

5/16"

30 mm



52630... 5/16" Torx Bit



Item no.	size	L(mm)	PCS/CTN	Box
5263010	T10	30	10	20
5263015	T15	30	10	20
5263020	T20	30	10	20
5263025	T25	30	10	20
5263027	T27	30	10	20
5263030	T30	30	10	20
5263040	T40	30	10	20
5263045	T45	30	10	20
5263050	T50	30	10	20
5263055	T55	30	10	20
5263060	T60	30	10	20
5263070	T70	30	10	20

52730... 5/16" Tamper Proof Bit



Item no.	size	L(mm)	PCS/CTN	Box
5273040	TP40	30	10	20
5273045	TP45	30	10	20
5273050	TP50	30	10	20
5273055	TP55	30	10	20
5273060	TP60	30	10	20
5273070	TP70	30	10	20

52830... 5/16" Spline Bit



Item no.	size	L(mm)	PCS/CTN	Box
5283006	M6	30	10	20
5283008	M8	30	10	20
5283010	M10	30	10	20
5283012	M12	30	10	20

52930... 5/16" Ribe Bit



Item no.	size	L(mm)	PCS/CTN	Box
5293006	RM6	30	10	20
5293008	RM8	30	10	20
5293010	RM10	30	10	20
5293011	RM11	30	10	20
5293012	RM12	30	10	20
5293013	RM13	30	10	20
5293014	RM14	30	10	20

5/16" · 75mm

S2

5/16"

75
mm



52775...

5/16" Tamper Proof Bit



Item no.	size	L(mm)	PCS/CTN	Box
5277545	TP45	75	5	60
5277550	TP50	75	5	60

52475...

5/16" Hex Bit



Item no.	size	L(mm)	PCS/CTN	Box
5247504	H4	75	5	60
5247505	H5	75	5	60
5247507	H7	75	5	60
5247508	H8	75	5	60
5247510	H10	75	5	60
5247512	H12	75	5	60

52875...

5/16" Spline Bit



Item no.	size	L(mm)	PCS/CTN	Box
5287508	M8	75	5	60

52675...

5/16" Torx Bit



Item no.	size	L(mm)	PCS/CTN	Box
5267540	T40	75	5	60
5267545	T45	75	5	60
5267550	T50	75	5	60

10H · 30/75mm

S2

10H

30 mm

75 mm



51130... 10H Phillips Bit



Item no.	size	L(mm)	📦	PCS/CTN	Box
511301	PH1	30	5	60	10
511302	PH2	30	5	60	10
511303	PH3	30	5	60	10
511304	PH4	30	5	60	10

51230... 10H Pozidriv Bit



Item no.	size	L(mm)	📦	PCS/CTN	Box
512301	PZ1	30	5	60	10
512302	PZ2	30	5	60	10
512303	PZ3	30	5	60	10
512304	PZ4	30	5	60	10

51330... 10H Slotted Bit



Item no.	size	L(mm)	📦	PCS/CTN	Box
51330065	SL6.5	30	5	60	10
5133008	SL8	30	5	60	10
5133010	SL10	30	5	60	10
5133012	SL12	30	5	60	10

51430.../51475... 10H Hex Bit



Item no.	size	L(mm)	📦	PCS/CTN	Box
5143004	H4	30	5	60	10
5143005	H5	30	5	60	10
5143006	H6	30	5	60	10
5143007	H7	30	5	60	10
5143008	H8	30	5	60	10
5143009	H9	30	5	60	10
5143010	H10	30	5	60	10
5143012	H12	30	5	60	10
5143014	H14	30	5	60	10
5147504	H4	75	5	60	10
5147505	H5	75	5	60	10
5147506	H6	75	5	60	10
5147507	H7	75	5	60	10
5147508	H8	75	5	60	10
5147510	H10	75	5	60	10
5147512	H12	75	5	60	10

51930... 10H Ribe Bit



Item no.	size	L(mm)	📦	PCS/CTN	Box
5193004	RM4	30	5	60	10
5193005	RM5	30	5	60	10
5193006	RM6	30	5	60	10
5193007	RM7	30	5	60	10
5193008	RM8	30	5	60	10
5193009	RM9	30	5	60	10
5193010	RM10	30	5	60	10
5193011	RM11	30	5	60	10
5193012	RM12	30	5	60	10
5193013	RM13	30	5	60	10
5193014	RM14	30	5	60	10

10H · 30/75mm

S2

10H

30 mm

75 mm



51830.../51875...

10H Spline Bit



Item no.	size	L(mm)	PCS/CTN	Box
5183004	M4	30	5	60
5183005	M5	30	5	60
5183006	M6	30	5	60
5183008	M8	30	5	60
5183009	M9	30	5	60
5183010	M10	30	5	60
5183012	M12	30	5	60
5183014	M14	30	5	60
5183016	M16	30	5	60
5183018	M18	30	5	60
5187505	M5	75	5	60
5187506	M6	75	5	60
5187508	M8	75	5	60
5187510	M10	75	5	60
5187512	M12	75	5	60
5187514	M14	75	5	60

51630.../51675...

10H Torx Bit



Item no.	size	L(mm)	PCS/CTN	Box
5163010	T10	30	5	60
5163015	T15	30	5	60
5163020	T20	30	5	60
5163025	T25	30	5	60
5163027	T27	30	5	60
5163030	T30	30	5	60
5163040	T40	30	5	60
5163045	T45	30	5	60
5163050	T50	30	5	60
5163055	T55	30	5	60
5163060	T60	30	5	60
5163070	T70	30	5	60
5167510	T10	75	5	60
5167515	T15	75	5	60
5167520	T20	75	5	60
5167525	T25	75	5	60
5167527	T27	75	5	60
5167530	T30	75	5	60
5167540	T40	75	5	60
5167545	T45	75	5	60
5167550	T50	75	5	60
5167555	T55	75	5	60
5167560	T60	75	5	60
5167570	T70	75	5	60

51730...

10H Tamper Proof Bit



Item no.	size	L(mm)	PCS/CTN	Box
5173010	TP10	30	5	60
5173015	TP15	30	5	60
5173020	TP20	30	5	60
5173025	TP25	30	5	60
5173027	TP27	30	5	60
5173030	TP30	30	5	60
5173040	TP40	30	5	60
5173045	TP45	30	5	60
5173050	TP50	30	5	60
5173055	TP55	30	5	60
5173060	TP60	30	5	60

1/4H · 65mm

S2

1/4
H

65
mm



521165... 1/4H Phillips Double Ended Bit



Item no.	size	L(mm)	PCS/CTN	Box
52116512	PH1 x PH2	65	5	60
52116513	PH1 x PH3	65	5	60
52116522	PH2 x PH2	65	5	60

1/4H · 110mm

S2

1/4
H

110
mm



5211110... 1/4H Phillips Double Ended Bit



Item no.	size	L(mm)	PCS/CTN	Box
521111011	PH1 x PH1	110	5	60
521111012	PH1 x PH2	110	5	60
521111022	PH2 x PH2	110	5	60
521111023	PH2 x PH3	110	5	60
521111033	PH3 x PH3	110	5	60

2031 31 Pcs 1/4" Dr. Torsion Color Bits Set

S2



Torsion Color Belt



Contents:

- 4pcs Slotted Bits : (SL)3, 4, 5, 6
- 4pcs Hex Bits : (H)3, 4, 5, 6
- 4pcs Phillips Bits : (PH)1, 2, 2, 3
- 4pcs Porzidriv Bits : (PZ)1, 2, 2, 3
- 7pcs Tamperproof Bits : (TP)10, 15, 20, 25, 27, 30, 40
- 7pcs Torx Bits : (T)10, 15, 20, 25, 27, 30, 40
- 1pc 1/4" Dr. Magnetic Quick Release Bits Holder 60L

Soft Mattress With 45° Angle Slope For Better View

2031260 Magnetic Quick Release Bits Holder

S2

Item no.	size	L(mm)
2031260	1/4"	60

52125...C Torsion Color Bits, S2 Steel Material - Phillips

S2

Item no.	size(mm)	L(mm)
5212501C	PH1	1/4" x 25mm
5212502C	PH2	1/4" x 25mm
5212503C	PH3	1/4" x 25mm

52225...C Torsion Color Bits, S2 Steel Material - Pozidriv

S2

Item no.	size(mm)	L(mm)
5222501C	PZ1	1/4" x 25mm
5222502C	PZ2	1/4" x 25mm
5222503C	PZ3	1/4" x 25mm

52325...C Torsion Color Bits, S2 Steel Material - Slotted

S2



Item no.	size(mm)	L(mm)
5232503C	SL3	1/4" x 25mm
5232504C	SL4	1/4" x 25mm
5232505C	SL5	1/4" x 25mm
5232506C	SL6	1/4" x 25mm

52425...C Torsion Color Bits, S2 Steel Material - Hex

S2

Item no.	size(mm)	L(mm)
5242503C	H3	1/4" x 25mm
5242504C	H4	1/4" x 25mm
5242505C	H5	1/4" x 25mm
5242506C	H6	1/4" x 25mm

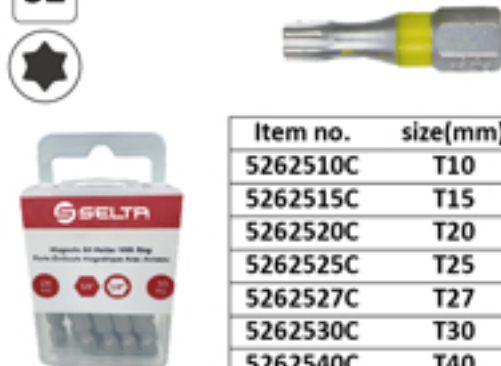
52625...C Torsion Color Bits, S2 Steel Material - Torx

S2

Item no.	size(mm)	L(mm)
5262510C	T10	1/4" x 25mm
5262515C	T15	1/4" x 25mm
5262520C	T20	1/4" x 25mm
5262525C	T25	1/4" x 25mm
5262527C	T27	1/4" x 25mm
5262530C	T30	1/4" x 25mm
5262540C	T40	1/4" x 25mm

52725...C Torsion Color Bits, S2 Steel Material - Tamper Proof

S2



Item no.	size(mm)	L(mm)
5272510C	TP10	1/4" x 25mm
5272515C	TP15	1/4" x 25mm
5272520C	TP20	1/4" x 25mm
5272525C	TP25	1/4" x 25mm
5272527C	TP27	1/4" x 25mm
5272530C	TP30	1/4" x 25mm
5272540C	TP40	1/4" x 25mm

71225 1/4" Dr. Magnetic Pick Up Head



- Magnetic Head
- CR-V Housing
- Dual Finished w/Knurl
- Can Use With 1/4"Dr. Extension & Spin Handle
- Size: 25mm(L) x 10mm(Dia.)

709... Bit Adapter

S2



Item no.	size	PCS/CTN
709265	1/4" x 1/4" x 65mmL	300
709365	3/8" x 1/4" x 65mmL	300
709472	1/2" x 1/4" x 72mmL	300

4407
7 Pcs Impact Driver Kit

Contents:

- 1pc Impact Driver
- 4pcs 8mm x 36L Bit
- 2pcs 8mm x 80L Bit
- 1pc 5/16" x 1/2" Coupler

4407A
7 Pcs Impact Driver Kit

Contents:

- 1pc Impact Driver
- 4pcs 8mm x 36L Bit
- 2pcs 8mm x 80L Bit
- 1pc 5/16" Hex 5/16" x 1/2" Coupler

4408
8 Pcs 1/2" Dr. Impact Driver Set

Contents:

- 1pc 1/2" Dr. Impact Driver - 145mm (L)
- 1pc Quick Change Bit Holder:
1/2" Dr. x 5/16" (H) - 38mm (L)
- 2pcs 5/16" Hex Shank Slotted Insert Bits:
1.2 x 8 mm & 1.6 x 10 mm - 36mm (L)
- 2pcs 5/16" Hex Shank Phillips Insert Bits:
PH2 & PH3 - 36mm (L)
- 2pcs 5/16" Hex Shank Phillips Insert Bits:
PH2 & PH3 - 80mm (L)

1064
6 Pcs 1/2" Dr. Impact Screwdriver & Bits Set

Material:

- S2 Bis W/Phosphate Zinc Finished
- Cr-v Impact Driver W/Satin Finished
- 1pc 1/2" Dr. Impact Screwdriver
- 1pc 1/2" Sq. (F) x 5/16" Hex. (F) Adapter
(Cr-v W/Satin Finished)
- 4pcs 5/16: Hex x 36mm(L) S2 Bits:
PH:2, 3
SL:9, 11

4203

1/4" Dr. Mini Type Impact Driver Kit



Contents:

- 1pc 1/4" Impact Driver
- 8pcs 1/2" x 25L Bit
- 6pcs 1/4" Socket: 5, 6, 7, 8, 9, 10mm
- 1pc 1/4" x 1/4" Coupler

4201

1/4" Dr. Mini Impact Driver



4401

1/2" Dr. Standard Impact Driver



HEX KEY



 **SELTA**

1009...C
9 Pcs Hex Key Set (Multicolor)

S2
Cr-V

Double Holder

Item no.	size
1009LHC Long	H1.5, H2, H2.5, H3, H4, H5, H6, H8, H10
1009XLHC Extra Long	H1.5, H2, H2.5, H3, H4, H5, H6, H8, H10

1009...LC
9 Pcs Torx Hex Key Set (Multicolor)

S2
Cr-V

Double Holder

Item no.	size
1009LC Long	T10, T15, T20, T25, T27, T30, T40, T45, T50
1009XLC Extra Long	T10, T15, T20, T25, T27, T30, T40, T45, T50

1009T...LC
9 Pcs Torx Tamper Hex Key Set (Multicolor)

S2
Cr-V

Double Holder

Item no.	size
1009TLC Long	TP10, TP15, TP20, TP25, TP27, TP30, TP40, TP45, TP50
1009TXLC Extra Long	TP10, TP15, TP20, TP25, TP27, TP30, TP40, TP45, TP50

1009...LBC
9 Pcs Ball Hex Key Set (Multicolor)

S2
Cr-V

Double Holder

Item no.	size
1009LBC Long	1.5, 2, 2.5, 3, 4, 5, 6, 8, 10
1009XLBC Extra Long	1.5, 2, 2.5, 3, 4, 5, 6, 8, 10

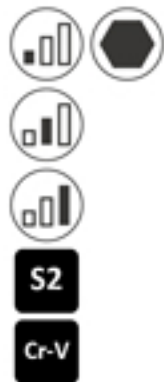
1009H...
9 Pcs Hex Key Set

Double Holder

Item no.	size	
1009H	Short	H1.5, H2, H2.5, H3, H4, H5, H6, H8, H10
1009HL	Long	H1.5, H2, H2.5, H3, H4, H5, H6, H8, H10
1009HXL	Extra Long	H1.5, H2, H2.5, H3, H4, H5, H6, H8, H10

1009...
9 Pcs Torx Hex Key Set

Double Holder

Item no.	size	
1009	Short	T10, T15, T20, T25, T27, T30, T40, T45, T50
1009L	Long	T10, T15, T20, T25, T27, T30, T40, T45, T50
1009XL	Extra Long	T10, T15, T20, T25, T27, T30, T40, T45, T50

1009TP...
9 Pcs Torx Tamper Proof Hex Key Set

Double Holder

Item no.	size	
1009TP	Short	TP10, TP15, TP20, TP25, TP27, TP30, TP40, TP45, TP50
1009TPL	Long	TP10, TP15, TP20, TP25, TP27, TP30, TP40, TP45, TP50
1009TPXL	Extra Long	TP10, TP15, TP20, TP25, TP27, TP30, TP40, TP45, TP50

1009...B...
9 Pcs Ball Hex Key Set

Double Holder

Item no.	size	
1009B	Short	1.5, 2, 2.5, 3, 4, 5, 6, 8, 10
1009LB	Long	1.5, 2, 2.5, 3, 4, 5, 6, 8, 10
1009XLB	Extra Long	1.5, 2, 2.5, 3, 4, 5, 6, 8, 10
1009XLB SAE	Extra Long	1/16", 5/64", 3/32", 1/8", 5/32", 3/16", 1/4", 5/16", 3/8"

1007...
7 Pcs Hex Key Set

Item no.	size
1007	Short H1.5, H2, H2.5, H3, H4, H5, H6
1007L	Long H1.5, H2, H2.5, H3, H4, H5, H6
1007XL	Extra Long H1.5, H2, H2.5, H3, H4, H5, H6

1007H...
7 Pcs Hex Key Set

Item no.	size
1007H	Short H2.5, H3, H4, H5, H6, H8, H10
1007HL	Long H2.5, H3, H4, H5, H6, H8, H10
1007HXL	Extra Long H2.5, H3, H4, H5, H6, H8, H10

1007T...
7 Pcs Torx Hex Key Set

Item no.	size
1007T	Short T10, T15, T20, T25, T27, T30, T40
1007TL	Long T10, T15, T20, T25, T27, T30, T40
1007TXL	Extra Long T10, T15, T20, T25, T27, T30, T40

1007TP... 7 Pcs Torx Tamper Hex Key Set

Item no.	size
1007TP Short	TP10, TP15, TP20, TP25, TP27, TP30, TP40
1007TPL Long	TP10, TP15, TP20, TP25, TP27, TP30, TP40
1007TPXL Extra Long	TP10, TP15, TP20, TP25, TP27, TP30, TP40

1007B... 7 Pcs Ball Hex Key Set

Item no.	size
1007B Short	1.5, 2, 2.5, 3, 4, 5, 6
1007BL Long	1.5, 2, 2.5, 3, 4, 5, 6
1007BXL Extra Long	1.5, 2, 2.5, 3, 4, 5, 6

1007HB... 7 Pcs Ball Hex Key Set

Item no.	size
1007HB Short	2.5, 3, 4, 5, 6, 8, 10
1007HBL Long	2.5, 3, 4, 5, 6, 8, 10
1007HBXL Extra Long	2.5, 3, 4, 5, 6, 8, 10

1010...
10 Pcs Hex Key Set

S2
Cr-V

Double Holder

Item no.		size
1010	Short	H1.27, H1.5, H2, H2.5, H3, H4, H5, H6, H8, H10
1010L	Long	H1.27, H1.5, H2, H2.5, H3, H4, H5, H6, H8, H10
1010XL	Extra Long	H1.27, H1.5, H2, H2.5, H3, H4, H5, H6, H8, H10

1010B...
10 Pcs Ball Hex Key Set

S2
Cr-V

Double Holder

Item no.		size
1010B	Short	1.27, 1.5, 2, 2.5, 3, 4, 5, 6, 8, 10
1010BL	Long	1.27, 1.5, 2, 2.5, 3, 4, 5, 6, 8, 10
1010BXL	Extra Long	1.27, 1.5, 2, 2.5, 3, 4, 5, 6, 8, 10

1008H

8 Pcs Short Hex Key Set

S2
Cr-V

Item no.	size
1008H	H1.5, H2, H2.5, H3, H4, H5, H6, H8

1008

8 Pcs Short Torx Hex Key Set

S2
Cr-V

Item no.	size
1008	T9, T10, T15, T20, T25, T27, T30, T40

1008TP

8 Pcs Short Torx Tamper Hex Key Set

S2
Cr-V

Item no.	size
1008TP	TP9, TP10, TP15, TP20, TP25, TP27, TP30, TP40

1008B

8 Pcs Short Ball Hex Key Set

S2
Cr-V

Item no.	size
1008B	1.5, 2, 2.5, 3, 4, 5, 6, 8

1007F
7 Pcs Metal Folding Hex Key Wrench Set

S2
Cr-V

Item no.	size
1007F	H2.5, H3, H4, H5, H6, H8, H10

1008F
8 Pcs Metal Folding Star Key Wrench Set

S2
Cr-V

Item no.	size
1008F	T9, T10, T15, T20, T25, T27, T30, T40

1008TF
8 Pcs Metal Folding Tamper Key Wrench Set

S2
Cr-V

Item no.	size
1008TF	TP9, TP10, TP15, TP20, TP25, TP27, TP30, TP40

864...
Hex Key

S2
Cr-V

Short

Item no.	Size	PCS/CTN	Box
8640127	H1.27	400	200
864015	H1.5	400	200
86402	H2	400	200
864025	H2.5	400	200
86403	H3	400	200
86404	H4	400	200
86405	H5	300	150
86406	H6	300	50
86407	H7	300	50
86408	H8	300	50
86410	H10	300	50
86412	H12	100	50
86414	H14	60	30
86417	H17	40	20
86419	H19	24	12
86422	H22	16	8
86427	H27	10	N/A
86430	H30	8	N/A
86432	H32	8	N/A
86436	H36	4	N/A

Short (SAE)

Item no.	Size	PCS/CTN	Box
8641.16	1/16"	400	200
8645.64	5/64"	400	200
8643.32	3/32"	400	200
8641.8	1/8"	400	200
8645.32	5/32"	400	200
8643.16	3/16"	300	150
8641.4	1/4"	300	50
8645.16	5/16"	300	50
8643.8	3/8"	100	50

Long

Item no.	Size	PCS/CTN	Box
8640127L	H1.27	400	200
864015L	H1.5	400	200
86402L	H2	400	200
864025L	H2.5	400	200
86403L	H3	400	200
86404L	H4	240	120
86405L	H5	200	100
86406L	H6	200	100
86407L	H7	140	70
86408L	H8	120	60
86410L	H10	60	30

Extra Long

Item no.	Size	PCS/CTN	Box
8640127XL	H1.27	400	200
864015XL	H1.5	400	200
86402XL	H2	400	200
864025XL	H2.5	400	200
86403XL	H3	400	200
86404XL	H4	400	200
86405XL	H5	400	100
86406XL	H6	280	70
86407XL	H7	140	70
86408XL	H8	140	70
86410XL	H10	80	40
86412XL	H12	40	20
86414XL	H14	32	16
86417XL	H17	24	12
86419XL	H19	12	6

866...

Torx Hey Key



S2

Cr-V



Short

Item no.	Size	PCS/CTN	Box
86610	T10	400	200
86615	T15	400	200
86620	T20	400	200
86625	T25	400	200
86627	T27	400	200
86630	T30	300	50
86640	T40	300	50
86645	T45	300	50
86650	T50	300	50
86655	T55	300	50

Long

Item no.	Size	PCS/CTN	Box
86610L	T10	400	200
86615L	T15	300	150
86620L	T20	240	120
86625L	T25	200	100
86627L	T27	200	100
86630L	T30	200	100
86640L	T40	140	70
86645L	T45	120	60
86650L	T50	80	40
86655L	T55	80	40

Extra Long

Item no.	Size	PCS/CTN	Box
86610XL	T10	400	200
86615XL	T15	400	200
86620XL	T20	400	200
86625XL	T25	400	100
86627XL	T27	400	100
86630XL	T30	280	70
86640XL	T40	140	70
86645XL	T45	140	70
86650XL	T50	80	40
86655XL	T55	80	40

867...
Tamper Proof Torx Hey Key

Short

Item no.	Size	PCS/CTN	Box
86710	TP10	400	200
86715	TP15	400	200
86720	TP20	400	200
86725	TP25	400	200
86727	TP27	400	200
86730	TP30	300	50
86740	TP40	300	50
86745	TP45	300	50
86750	TP50	300	50
86755	TP55	300	50

Long

Item no.	Size	PCS/CTN	Box
86710L	TP10	400	200
86715L	TP15	300	150
86720L	TP20	240	120
86725L	TP25	200	100
86727L	TP27	200	100
86730L	TP30	200	100
86740L	TP40	140	70
86745L	TP45	120	60
86750L	TP50	80	40
86755L	TP55	80	40

Extra Long

Item no.	Size	PCS/CTN	Box
86710XL	TP10	400	200
86715XL	TP15	400	200
86720XL	TP20	400	200
86725XL	TP25	400	100
86727XL	TP27	400	100
86730XL	TP30	280	70
86740XL	TP40	140	70
86745XL	TP45	140	70
86750XL	TP50	80	40
86755XL	TP55	80	40

S2
Cr-V

Short

Item no.	Size	PCS/CTN	Box
8650127	1.27	400	200
865015	1.5	400	200
86502	2	400	200
865025	2.5	400	200
86503	3	400	200
86504	4	400	200
86505	5	300	150
86506	6	300	50
86507	7	300	50
86508	8	300	50
86510	10	100	50
86512	12	100	50
86514	14	100	50

Extra Long

Item no.	Size	PCS/CTN	Box
865015XL	1.5	400	200
86502XL	2	400	200
865025XL	2.5	400	200
86503XL	3	400	200
86504XL	4	400	200
86505XL	5	400	100
86506XL	6	280	70
86507XL	7	140	70
86508XL	8	140	70
86510XL	10	80	40
86512XL	12	40	20
86514XL	14	32	16

Long

Item no.	Size	PCS/CTN	Box
8650127L	1.27	400	200
865015L	1.5	400	200
86502L	2	400	200
865025L	2.5	400	200
86503L	3	400	200
86504L	4	240	200
86505L	5	200	100
86506L	6	200	100
86507L	7	140	70
86508L	8	120	60
86510L	10	60	30
86512L	12	60	30
86514L	14	60	30

Extra Long (SAE)

Item no.	Size	PCS/CTN	Box
8651.16	1/16"	400	200
8655.64	5/64"	400	200
8653.32	3/32"	400	200
8651.8	1/8"	400	200
8655.32	5/32"	400	200
8653.16	3/16"	400	100
8657.32	7/32"	400	100
8651.4	1/4"	280	100
8655.16	5/16"	140	70
8653.8	3/8"	140	70
8657.16	7/16"	80	40
8651.2	1/2"	40	20
8655.8	5/8"	32	16
8653.4	3/4"	32	16

1013...

Short / Extra Long 13 Pcs Hex Key Set



S2

Cr-V

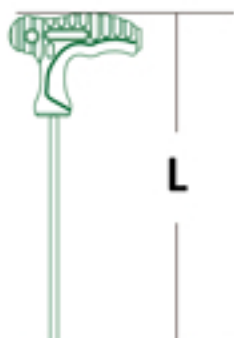

Item no.		size
1013	Short	H2, H2.5, H3, H4, H5, H6, H7, H8, H10, H12, H14, H17, H19
1013XL	Extra Long	H2, H2.5, H3, H4, H5, H6, H7, H8, H10, H12, H14, H17, H19

764...
T-Handle Hex Key

Item no.	Size	L(mm)	PCS/CTN	Box
764015	H1.5	80	300	50
76402	H2	90	300	50
764025	H2.5	100	300	50
76403	H3	115	300	50
76404	H4	120	120	10
76405	H5	140	120	10
76406	H6	160	120	10
76407	H7	170	120	10
76408	H8	175	80	10
76409	H9	185	80	10
76410	H10	200	40	10
76412	H12	225	40	10

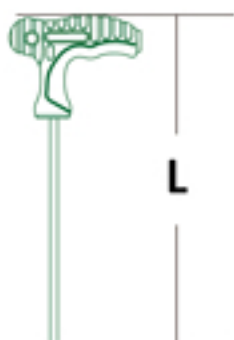
766...
T-Handle Torx Hex Key

Item no.	Size	L(mm)	PCS/CTN	Box
76609	T9	90	300	50
76610	T10	100	300	50
76615	T15	115	300	50
76620	T20	120	120	10
76625	T25	130	120	10
76627	T27	140	120	10
76630	T30	150	120	10
76640	T40	160	120	10
76645	T45	175	80	10
76650	T50	200	80	10
76655	T55	225	40	10

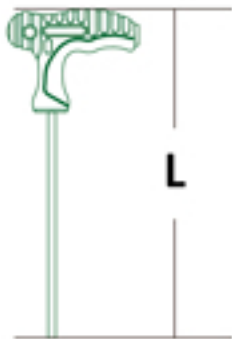
767...
T-Handle Torx Tamper Hex Key

Item no.	Size	L(mm)	PCS/CTN	Box
76709	TP9	90	300	50
76710	TP10	100	300	50
76715	TP15	115	300	50
76720	TP20	120	120	10
76725	TP25	130	120	10
76727	TP27	140	120	10
76730	TP30	150	120	10
76740	TP40	160	120	10
76745	TP45	175	80	10
76750	TP50	200	80	10
76755	TP55	225	40	10

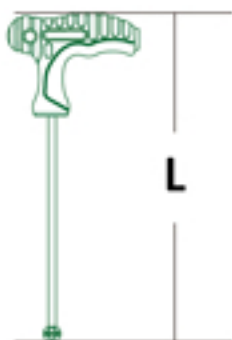
765...
T-Handle Ball Point Hex Key

Item no.	Size	L(mm)	PCS/CTN	Box
765015	1.5	80	300	50
76502	2	90	300	50
765025	2.5	100	300	50
76503	3	115	300	50
76504	4	120	120	10
76505	5	140	120	10
76506	6	160	120	10
76507	7	170	120	10
76508	8	175	80	10
76509	9	185	80	10
76510	10	200	40	10
76512	12	225	40	10

SAE

Item no.	Size	L(mm)	PCS/CTN	Box
7653.32	3/32	90	300	50
7657.64	7/64	100	300	50
7651.8	1/8	115	300	50
7659.64	9/64	120	120	10
7655.32	5/32	120	120	10
7653.16	3/16	140	120	10
7657.32	7/32	160	120	10
7651.4	1/4	160	80	10
7655.16	5/16	175	80	10
7653.8	3/8	200	300	50

774...

T-Handle Nut Driver

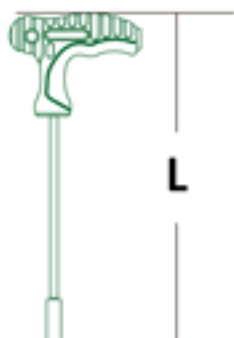

Item no.	Size	L(mm)	PCS/CTN	Box
77405	5mm	290	120	12
774055	5.5mm	290	120	12
77406	6mm	290	120	12
77407	7mm	290	120	12
77408	8mm	290	80	10
77409	9mm	290	80	10
77410	10mm	290	80	10
77411	11mm	290	60	10
77412	12mm	290	60	10
77413	13mm	290	60	10
77414	14mm	290	60	10

A close-up photograph of a person's arm and hand holding a metal adjustable wrench. The person is wearing a light-colored t-shirt and blue denim jeans. The background is dark. In the top right corner, there is a logo consisting of a red stylized 'S' inside a white circle, followed by the word 'SELTA' in bold black capital letters.

SELTA

WRENCHES

825824
**8 Pcs Double Open End
Spanner Set**

- Size: 8 x 9, 10 x 11, 12 x 13, 14 x 15, 16 x 17, 18 x 19,
21 x 23, 22 x 24mm

825632
**12 Pcs Double Open End
Spanner Set**

- Size: 6 x 7, 8 x 9, 10 x 11, 12 x 13, 14 x 15, 16 x 17, 17 x 19,
18 x 19, 21 x 23, 22 x 24, 24 x 27, 30 x 32mm

81512
12 Pcs Combination Spanner Set

- Size: 8, 10, 12, 13, 14, 17, 19, 22, 24, 27, 30, 32 mm

81512-1
12 Pcs Combination Spanner Set

- Size: 8, 10, 11, 12, 13, 14, 15, 16, 17, 19, 22, 24mm

81514
14 Pcs Combination Spanner Set

- Size: 10, 12, 13, 14, 15, 16, 17, 18, 19, 21, 24, 27, 30, 32 mm

81518
18 Pcs Combination Spanner Set

- Size: 8, 9, 10, 11, 12, 13, 14, 15, 16, 17, 18, 19,
21, 22, 24, 27, 30, 32mm

81525
25 Pcs Combination Spanner Set

- Size: 6, 7, 8, 9, 10, 11, 12, 13, 14, 15, 16, 17, 18, 19, 20, 21, 22, 23, 24, 25, 26, 27, 28, 30, 32mm

835824
8 Pcs 75° Offset Double Ring Spanner Set



- Size: 8 x 9, 10 x 11, 12 x 13, 14 x 15, 16 x 17, 18 x 19, 21 x 23, 22 x 24mm

81512-2
12 Pcs Combination Spanner Set

- Size: 8, 9, 10, 11, 12, 13, 14, 15, 16, 17, 18, 19mm

845819
6 Pcs Double Flexible Spanner Socket

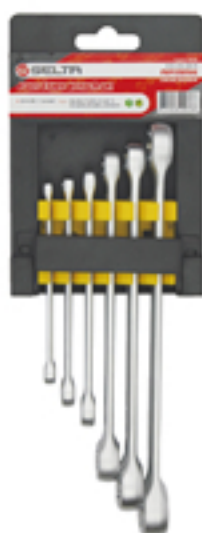
- Size: 8 x 9, 10 x 11, 12 x 13, 14 x 15, 16 x 17, 18 x 19mm

845624
6 Pcs E Type Spanner Set

- Size: E6 x E8, E7 x E11, E10 x E12, E14 x E18, E16 x E22, E20 x E24

51310
13 Pcs Ratchet Wrench Set

- Size: 8, 10, 11, 12, 13, 14, 15,
16, 17, 18, 19, 21, 22mm

11110A & 11110
**10 Pcs, 3/8" Dr. Crowfoot
Spanner Set**

11110A

- 6PT SIZE: 10, 11, 12, 13, 14, 15, 16, 17, 18, 19mm

11110

- 12PT SIZE: 10, 11, 12, 13, 14, 15, 16, 17, 18, 19mm

82...
Double Open End Spanner

Item no.	Size(mm)	PCS/CTN
820607	6 x 7	500
820708	7 x 8	500
820809	8 x 9	500
820810	8 x 10	500
821011	10 x 11	200
821012	10 x 12	200
821013	10 x 13	200
821113	11 x 13	200
821213	12 x 13	200
821214	12 x 14	200
821315	13 x 15	100
821317	13 x 17	100
821415	14 x 15	100
821617	16 x 17	100
821618	16 x 18	100
821719	17 x 19	100
821819	18 x 19	100

Item no.	Size(mm)	PCS/CTN
821922	19 x 22	100
822022	20 x 22	100
822123	21 x 23	60
822224	22 x 24	60
822426	24 x 26	60
822427	24 x 27	60
822528	25 x 28	60
822729	27 x 29	60
822730	27 x 30	50
822732	27 x 32	40
823032	30 x 32	40
823236	32 x 36	20
823436	34 x 36	20
823641	36 x 41	20
824146	41 x 46	20
824650	46 x 50	10

810...
Combination Spanner

Item no.	Size(mm)	PCS/CTN
81006	6	720
81007	7	720
81008	8	720
81009	9	720
81010	10	360
81011	11	360
81012	12	360
81013	13	240
81014	14	180
81015	15	120
81016	16	120
81017	17	120
81018	18	120
81019	19	120
81020	20	80
81021	21	80
81022	22	80

Item no.	Size(mm)	PCS/CTN
81023	23	60
81024	24	60
81025	25	60
81026	26	60
81027	27	30
81028	28	30
81029	29	30
81030	30	30
81032	32	30
81033	33	20
81034	34	20
81035	35	20
81036	36	20
81038	38	20
81041	41	10
81043	43	10
81046	46	10

Item no.	Size(mm)	PCS/CTN
81048	48	10
81050	50	10
81055	55	8
81058	58	--
81060	60	--
81065	65	--
81070	70	--
81075	75	--
81080	80	--
81085	85	--
81090	90	--
81095	95	--
81100	100	--
81105	105	--

816...
Flare Nut Spanner

Item no.	Size(mm)	PCS/CTN
8160810	8 x 10	240
8160911	9 x 11	240
8161011	10 x 11	240
8161012	10 x 12	240
8161113	11 x 13	120
8161213	12 x 13	120
8161214	12 x 14	120
8161417	14 x 17	100
8161719	17 x 19	100

83...
75° Offset Ring Spanner

Item no.	Size(mm)	PCS/CTN
830607	6 x 7	300
830809	8 x 9	300
830810	8 x 10	200
831011	10 x 11	200
831012	10 x 12	200
831213	12 x 13	120
831214	12 x 14	100
831317	13 x 17	100
831415	14 x 15	100
831617	16 x 17	80
831819	18 x 19	50
831922	19 x 22	50

Item no.	Size(mm)	PCS/CTN
832022	20 x 22	50
832123	21 x 23	40
832224	22 x 24	40
832426	24 x 26	40
832427	24 x 27	40
832528	25 x 28	40
832729	27 x 29	40
833032	30 x 32	30
833236	32 x 36	20
833641	36 x 41	10
834146	41 x 46	8
834650	46 x 50	8

857...
Combination Reversible Gear Spanner



Item no.	Size(mm)	PCS/CTN
857055	5.5	100
85706	6	100
85707	7	100
85708	8	100
85709	9	100
85710	10	100
85711	11	100
85712	12	100
85713	13	100
85714	14	100
85715	15	100
85716	16	100
85717	17	100
85718	18	100
85719	19	100
85720	20	100

Item no.	Size(mm)	PCS/CTN
85721	21	50
85722	22	50
85723	23	50
85724	24	50
85725	25	50
85726	26	50
85727	27	20
85728	28	20
85729	29	20
85730	30	20
85731	31	20
85732	32	20
85733	33	20
85734	34	10
85735	35	10
85736	36	10

757...
Combination Non-Reversible Gear Spanner

Item no.	Size(mm)	PCS/CTN
757055	5.5	600
75706	6	600
75707	7	600
75708	8	300
75709	9	300
75710	10	300
75711	11	300
75712	12	300
75713	13	200
75714	14	150
75715	15	150

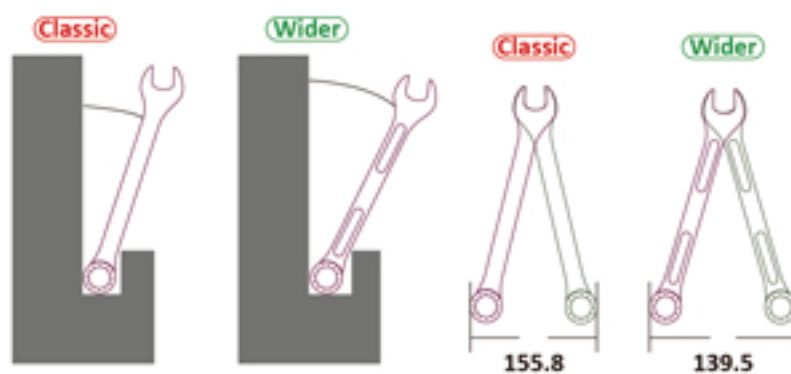
Item no.	Size(mm)	PCS/CTN
75716	16	120
75717	17	100
75718	18	100
75719	19	80
75721	21	50
75722	22	50
75724	24	50
75727	27	30
75730	30	20
75732	32	20

8557...AS
AS Type Combination Reversible Gear Spanner

Turning radius of lightweight

Item no.	Size(mm)	PCS/CTN
855706AS	6	100
855707AS	7	100
855708AS	8	100
855709AS	9	100
855710AS	10	100
855711AS	11	100
855712AS	12	100
855713AS	13	100
855714AS	14	100
855715AS	15	100
855716AS	16	100
855717AS	17	100
855718AS	18	100
855719AS	19	100
855720AS	20	100
855721AS	21	50
855722AS	22	50
855723AS	23	50
855724AS	24	50
855725AS	25	50
855726AS	26	50

858...

Flexible Gear Spanner



Item no.	Size(mm)	PCS/CTN
85806	6	200
85807	7	200
85808	8	200
85810	10	200
85811	11	200
85812	12	200
85813	13	200
85814	14	100
85815	15	100
85816	16	100
85817	17	100
85818	18	100
85819	19	100
85820	20	50
85821	21	50
85822	22	50
85824	24	40

85...

Double Box Flat Gear Spanner

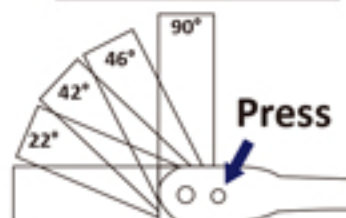

Item no.	Size(mm)	PCS/CTN
850607	6 x 7	600
850708	7 x 8	600
850809	8 x 9	300
850810	8 x 10	300
851011	10 x 11	300
851213	12 x 13	200
851317	13 x 17	150
851415	14 x 15	150
851618	16 x 18	100
851719	17 x 19	80
852022	20 x 22	60

858...P
Lockable 1-Way Ratchet Combination Wrench

Item no.	Size(mm)
85806P	6
85807P	7
85808P	8
85810P	10
85811P	11
85812P	12
85813P	13
85814P	14
85815P	15
85816P	16
85817P	17
85818P	18
85819P	19
85820P	20
85821P	21
85822P	22
85824P	24

859...
Stubby Combination Gear Spanner

Item no.	Size(mm)	PCS/CTN
85906	6	200
85907	7	200
85908	8	200
85910	10	200
85911	11	200
85912	12	200
85913	13	200
85914	14	100
85915	15	100
85916	16	100
85917	17	100
85918	18	100

855...

Reversible Double Box 15° Gear Spanner



Item no.	Size(mm)	PCS/CTN
8550607	6 x 7	200
8550809	8 x 9	200
8550810	8 x 10	200
8551011	10 x 11	200
8551012	10 x 12	200
8551013	10 x 13	200
8551214	12 x 14	100
8551415	14 x 15	100
8551417	14 x 17	100
8551617	16 x 17	100
8551618	16 x 18	100
8551619	17 x 19	100

831...

Square Drive



Item no.	■ Size	● Size
831210	1/4"	10mm
831313	3/8"	13mm
831419	1/2"	19mm
831632	3/4"	32mm

832...

Bit Holder



Item no.	● Size	● Size
832119	1/4"	10mm
832813	5/16"	13mm
832210	10mm	19mm

749...
Heavy Duty Adjustable Wrench

Item no.	Size	Maximum Jaw Opening Width
749100	4"	17mm
749150	6"	23.9mm
749200	8"	28.6mm
749250	10"	32.8mm
749300	12"	38.1mm
749380	15"	50mm
749460	18"	60mm

749...R
Paw Adjustable Wrench

Item no.	Size	Maximum Jaw Opening Width
749150R	6"	23.9mm
749200R	8"	28.6mm
749250R	10"	32.8mm
749300R	12"	38.1mm

- Material: Chrome Vanadium.
- Comfortable And Strong Grip TPR Handle.
- Type: 22.5 Degree, Screw Pin W/ Front Side Metric Scale.
- Wider Jaw Opening.
- Lighter Weight Caused By Geometric Round Handle Design.
- Hardness: HRC 40~50 Of Handle And Jaw.

851...
Open-End Ratcheting Wrench



Item no.	Size	Length
85110	10mm	135mm
85111	11mm	135mm
85112	12mm	135mm
85113	13mm	135mm
85114	14mm	135mm
85117	17mm	185mm
85119	19mm	185mm
85122	22mm	230mm
85124	24mm	230mm
85127	27mm	320mm
85132	32mm	320mm

86...
Adjustable Hook Spanner Wrench

Item no.	Diameter Capacity	Overall Length (L)
861335	13 ~ 35mm	168L
863550	35 ~ 50mm	202L
865080	50 ~ 80mm	280L
8680120	80 ~ 120mm	345L
86120180	120 ~ 180mm	492L

850...

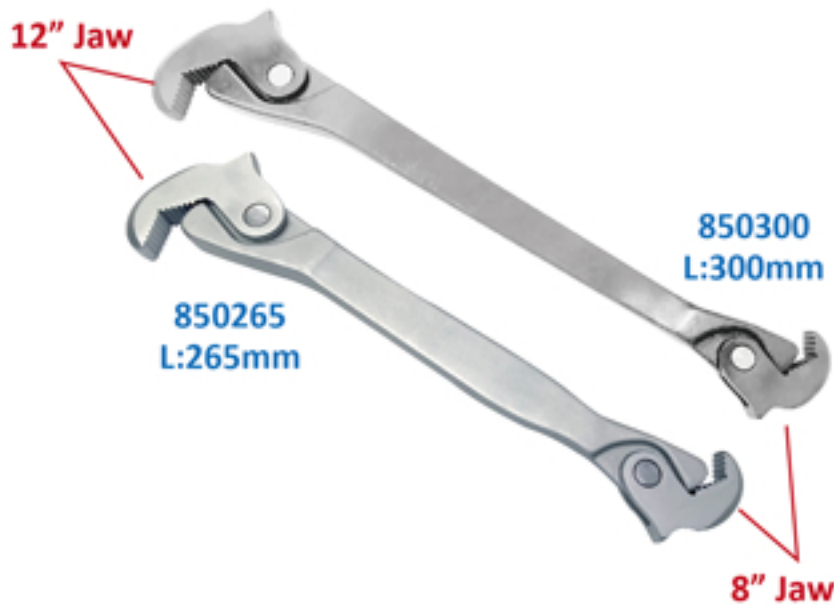
Double Head Quick Wrench



Apply Both For New Down To 70% Rounded Bolt

Features:

- One Hand Operation , Thumb Only To Lock The Bolt
- Special Design Teeth To Prevent Slip
- Fit To All Type Of Bolt
(Spline 、 6 Point 、 12 Point 、 Star 、 Square)
- Fit Both Metric And Inch Size

Specifications:

- 8" Jaw Cappacity: 8~17mm (5/16"~11/16")
- 12" Jaw Cappacity: 14~32mm (9/16"~1-1/4")
- Material: CR-V
- Whole Piece Drop Forge
- Harden And Tempered Jaws
- Over All Size: 30 x 6.5 x 1.3cm

895...

Extrnsion Bar For Single Ended Ring Spanner

Item no.	L(mm)	Weight
895350	350	960g
895580	580	1600g
895850	850	2300g

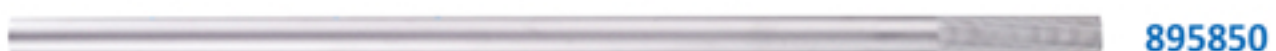
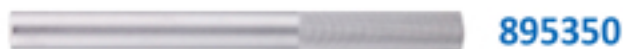

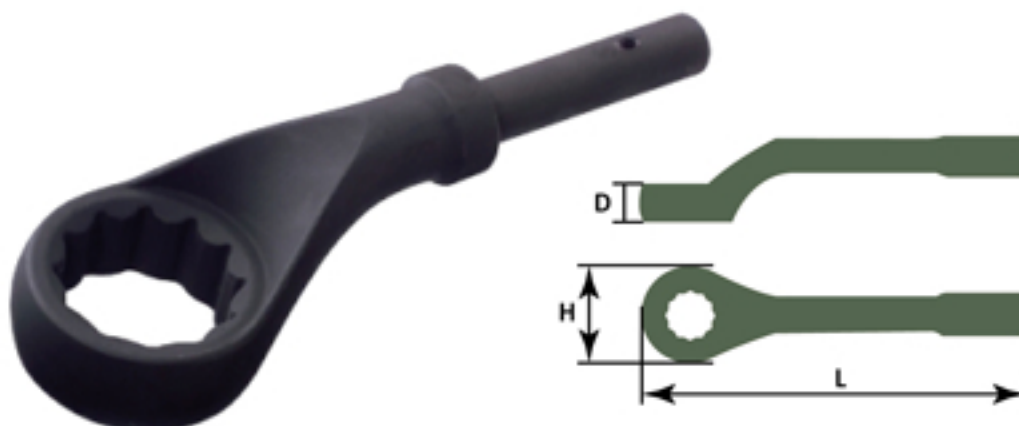
895...
Slogging Ring Wrench 45° Offset

Item no.	L(mm)	D(mm)	H(mm)	Weight
89524	190	46	63	640g
89527	190	46	63	600g
89530	195	51	63	745g
89532	195	51	63	705g
89536	213	60	71	1040g
89538	213	60	71	1020g
89541	251	70	79	1360g
89543	251	70	79	1320g
89546	274	80	81	1860g
89550	274	80	81	1800g
89555	287	90.5	82	2120g
89560	300	96.5	87	2340g

Item no.	L(mm)	D(mm)	H(mm)	Weight
89565	309	110	99	3500g
89570	309	110	99	3340g
89575	340	128	108	4500g
89580	340	128	108	4760g
89585	360	153	119	7220g
89590	360	153	119	7040g
89595	378	165	134	9080g
895100	378	165	134	8720g
895105	380	173	134	9340g
895110	380	173	134	13920g
895115	380	173	134	13420g

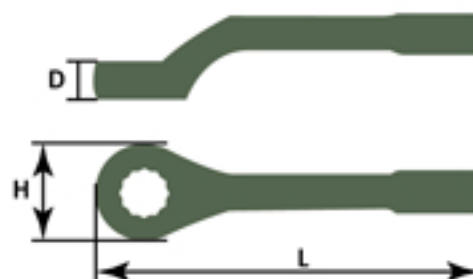
894...
Slogging Ring Wrench 45° Offset

Item no.	L(mm)	D(mm)	H(mm)	Weight
89424	250	46	64	1320g
89427	250	46	64	1260g
89430	270	51	64	1505g
89432	270	51	64	1465g
89436	300	60	71	1800g
89438	300	60	71	1760g
89441	317	70	80	2640g
89443	317	70	80	2580g
89446	360	80	81	3400g
89450	360	80	81	3300g
89455	360	90.5	82	3344g
89460	360	96.5	87	3560g

Item no.	L(mm)	D(mm)	H(mm)	Weight
89465	380	110	101	5500g
89470	380	110	101	7900g
89475	420	128	110	7000g
89480	420	128	110	7460g
89485	450	153	122	8000g
89490	450	153	122	10750g
89495	500	165	134	13920g
894100	500	165	134	13560g
894105	515	173	134	14260g
894110	515	173	134	13920g
894115	515	173	134	13420g

753..

Angle Spanner With Hole



Item no.	size(mm)	Short x Long (A)	Short x Long (B)
75308	8	6pt x 12pt	6pt x 6pt
75310	10	6pt x 12pt	-----
75312	12	6pt x 12pt	6pt x 6pt
75313	13	6pt x 12pt	6pt x 6pt
75317	17	6pt x 12pt	-----
75319	19	6pt x 12pt	-----

84...

Double Flexible Socket Spanner

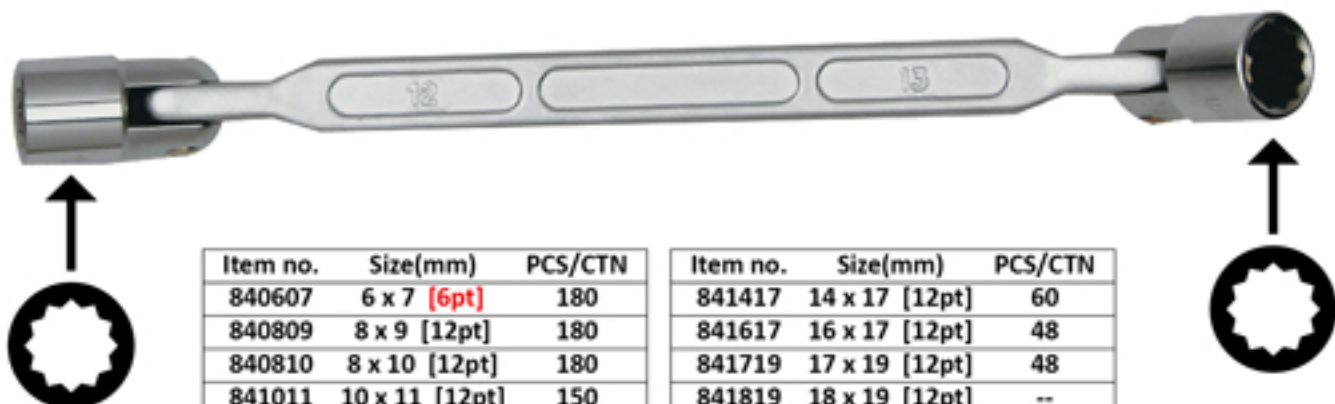

Item no.	Size(mm)	PCS/CTN
840607	6 x 7 [6pt]	180
840809	8 x 9 [12pt]	180
840810	8 x 10 [12pt]	180
841011	10 x 11 [12pt]	150
841012	10 x 12 [12pt]	120
841213	12 x 13 [12pt]	90
841214	12 x 14 [12pt]	90
841317	13 x 17 [12pt]	90
841415	14 x 15 [12pt]	60

Item no.	Size(mm)	PCS/CTN
841417	14 x 17 [12pt]	60
841617	16 x 17 [12pt]	48
841719	17 x 19 [12pt]	48
841819	18 x 19 [12pt]	--
841922	19 x 22 [12pt]	--
842022	20 x 22 [12pt]	--
842123	21 x 23 [12pt]	--
842427	24 x 27 [12pt]	--
843032	30 x 32 [12pt]	--

88450...**Universal T Handle Socket Spanner**

Item no.	Size	PCS/CTN
8845008	8mm x 450mmL	40
8845010	10mm x 450mmL	40
8845012	12mm x 450mmL	40
8845013	13mm x 450mmL	40
8845014	14mm x 450mmL	40

88300...**T Handle Socket Spanner**

Item no.	Size	PCS/CTN
8830008	8mm x 300mmL	6
8830009	9mm x 300mmL	6
8830010	10mm x 300mmL	6
8830011	11mm x 300mmL	6
8830012	12mm x 300mmL	6
8830013	13mm x 300mmL	6
8830014	14mm x 300mmL	6
8830015	15mm x 300mmL	6
8830017	17mm x 300mmL	6
8830019	19mm x 300mmL	6

TORQUE WRENCH

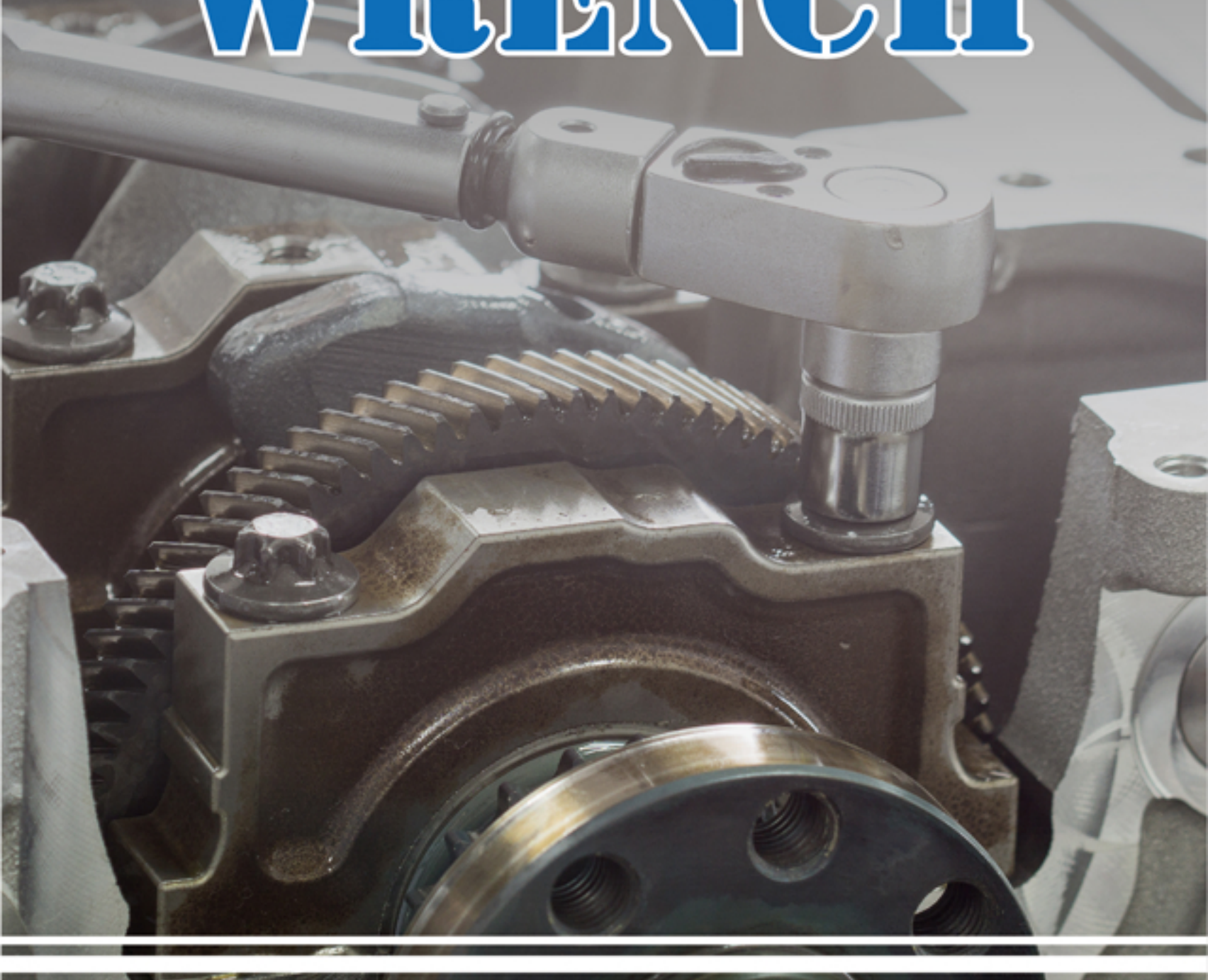

 **SELTA**

747... Traditional Torque Wrench



- Accuracy: CW \pm 4%
- Right Hand Direction Click Only.
- Cr-V Alloy Steel W/Satin Chrome Finished
- Locked-Able Grip

Item no.	Square Driver	Teeth	Range	L(mm)	PCS/CTN
7472270	1/4"	24T	5-25Nm	280	15
7473270	3/8"	24T	5-25Nm	280	15
7473365	3/8"	24T	19-110Nm	336	15
7474470	1/2"	24T	42-210Nm	470	15
7474630	1/2"	24T	70-350Nm	633	6
7476850	3/4"	24T	65-450Nm	850	4
74761030	3/4"	24T	140-700Nm	1063	4
74781213	1"	24T	140-980Nm	1213	2

748... Window Type Torque Wrench



- Accuracy: CW \pm 4% (CCW \pm 6%)
- Easily Adjustment, Endurable Handle Locking Mechanism, Pull Down Handle To Unlock And Pull Up To Lock That Prevent Any Accidental Adjust When Operating.
- Convex Lens For Micro Torque Values Selection.
- Clear And Large Window For Torque Setting.
- Nox-Toxic, Green Safety ABS Handle.
- Meet DIN-ISO And ASME International Standards Requirement.

Item no.	Square Driver	Teeth	Range	Graduation	L(mm)	PCS/CTN
7480420	1/4"	36T	4-20Nm	0.1	374	25
74820100	3/8"	36T	20-100Nm	0.5	478	12
74840210	1/2"	24T	40-210Nm	1.0	562	12
74860360	1/2"	24T	60-360Nm	0.5	630	12

747... Industrial Torque Wrench



- Accuracy: CW \pm 4% (CCW \pm 4%)
- ABS Handle

Item no.	Square Driver	Teeth	Range	Graduation	L(mm)	PCS/CTN
7472295	1/4"	24T	2-26Nm	26.6-239 IN-LB	0.2	308
7473380	3/8"	24T	20-110Nm	16.6-83.2 FT LB	0.5	340
7474535	1/2"	24T	40-210Nm	33.2-158.6 FT LB	1.0	531
7474645	1/2"	24T	50-350Nm	44.3-265.5 FT LB	2.0	585
7476865	3/4"	24T	100-600Nm	92-461 FT LB	5.0	1048
74761095	3/4"	24T	150-800Nm	129-609 FT LB	5.0	1177

747...
Professional Torque Wrench

- Accuracy: CW \pm 3% (CCW \pm 5%)
- TPR Handle

Item no.	Square Driver	Teeth	Range		Graduation	L(mm)	PCS/CTN
74781177	1"	24T	200-1000Nm	166-756 FT-LB	5.0	1177	2
74781700	1"	24T	300-1500Nm	257-1143 FT LB	10.0	1900	1
74784200	1"	24T	400-2000Nm	330-1514 FT LB	10.0	1900	1

74715
3/8" Interchangeable Torque Wrench Set 12 Pcs

- Industrial Application
- Accuracy: CW \pm 3%
- Quality Meets DIN ISO 6789 & ASME B107.300-2010.
- Head Size: 9 x 12mm
- NM: 20~110
- Ratchet: 3/8"
- Open Ended: 10, 11, 12, 13, 14, 15, 16, 17, 18, 19mm

74705
1/2" Interchangeable Torque Wrench Set 11 Pcs

- Industrial Application
- Accuracy: CW \pm 3%
- Quality Meets DIN ISO 6789 & ASME B107.300-2010.
- Head Size: 14 x 18mm
- NM: 40~200
- Ratchet: 1/2"
- Open Ended: 13, 14, 15, 17, 19, 22, 24, 27, 30mm

713... & 724... Interchangeable Torque Wrench



- Accuracy: CW \pm 3%
- Industrial Application
- Applied To Both Clockwise And Counterclockwise Directions
- Quality Meets DIN ISO 6789 & ASME B107.300-2010

Item no.	Head Size	Range	Graduation	L(mm)
7132430	9 x 12mm	20-100Nm	0.5	430
7241484	14 x 18mm	40-200Nm	1.0	484
7242585	14 x 18mm	60-340Nm	2.0	585

743... Ratchet Insert Tools

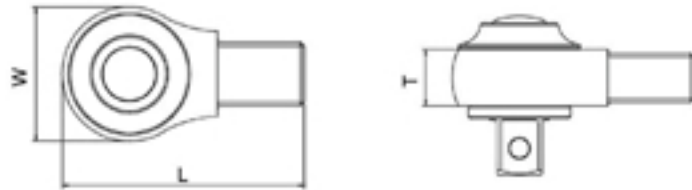

Item no.	Head Size	Teeth	Drive	L(mm)	W(mm)	T(mm)
743103	9 x 12mm	72T	3/8"	46.0	24.8	11.2
743204	14 x 18mm	72T	1/2"	68.8	38.0	16.0
743207	14 x 18mm	72T	3/4"	99.8	61.5	22.0

74111418 Insert Adatper



14 x 18

9 x 12

Item no.	F(mm)	M(mm)	L(mm)
74111418	14 x 18	9 x 12	50

74120912 Insert Adatper



9 x 12

14 x 18

Item no.	F(mm)	M(mm)	L(mm)
74120912	9 x 12	14 x 18	45

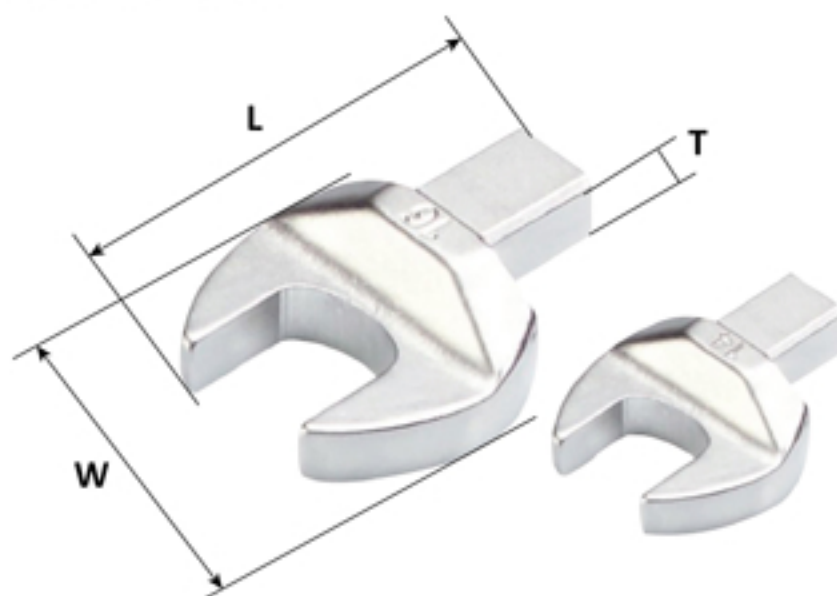
7411...
Open Ended Insert Tools

Item no.	Size(mm)	Head Size	L(mm)	W(mm)	T(mm)
741107	7	9 x 12mm	37.6	20.7	5.7
741108	8		37.6	22.0	5.7
741109	9		37.6	23.5	5.7
741110	10		39.8	24.8	5.7
741111	11		39.8	26.0	5.7
741112	12		39.8	27.5	5.7
741113	13		40.0	28.8	5.7
741114	14		43.0	31.5	7.7
741115	15		44.0	33.5	7.7
741116	16		44.0	36.0	7.7
741117	17		44.0	37.7	7.7
741118	18		45.2	39.0	7.7
741119	19		45.2	41.6	7.7

Item no.	Size(mm)	Head Size	L(mm)	W(mm)	T(mm)
741213	13	14 x 18mm	58.0	29.5	7.0
741214	14		58.0	31.4	7.0
741215	15		58.0	33.5	7.0
741216	16		58.5	36.0	7.0
741217	17		59.5	37.0	9.0
741218	18		60.4	39.0	9.0
741219	19		61.5	40.6	9.0
741221	21		61.5	45.5	11.0
741222	22		62.3	47.3	11.0
741223	23		62.3	47.8	11.0
741224	24		63.2	50.8	11.0
741225	25		69.0	58.4	13.8
741226	26		69.0	58.4	13.8
741227	27		69.0	58.4	13.8
741230	30		70.5	62.5	13.8
741232	32		72.5	65.0	13.8
741234	34		74.0	67.5	13.8
741236	36		74.0	67.5	13.8
741238	38		74.0	67.5	13.8
741241	41		80.5	82.3	13.8
741246	46		91.1	98.6	20.0
741248	48		96.9	105.0	30.5
741250	50		96.9	105.0	30.5
741270	70		136.2	149.2	33.5

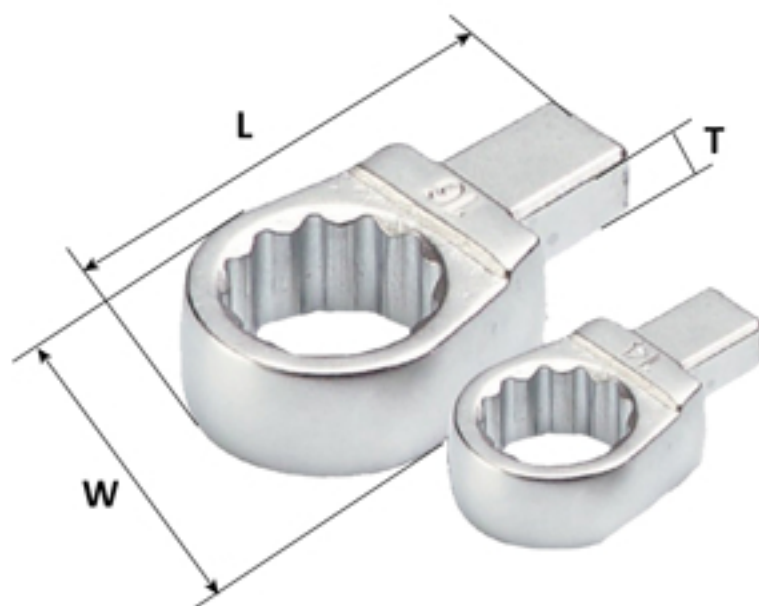

Item no.	Size(mm)	Head Size	L(mm)	W(mm)	T(mm)
742107	7	9 x 12mm	40.8	19.8	8.0
742108	8		40.8	19.8	8.0
742109	9		40.8	19.8	8.0
742110	10		42.6	20.0	8.0
742111	11		43.5	20.2	8.0
742112	12		44.0	22.2	12.0
742113	13		44.5	22.2	12.0
742114	14		46.0	23.5	12.0
742115	15		46.7	24.6	12.0
742116	16		47.0	26.4	13.0
742117	17		47.3	27.3	13.0
742118	18		48.4	29.0	13.0
742119	19		49.4	31.0	13.0
742121	21		49.8	33.4	14.7
742122	22	51.4	35.0	14.7	

Item no.	Size(mm)	Head Size	L(mm)	W(mm)	T(mm)
742213	13	14 x 18mm	61.5	30.0	12.0
742214	14		62.0	30.0	12.0
742215	15		62.5	30.0	12.0
742216	16		62.5	30.0	12.0
742217	17		64.0	30.5	12.5
742218	18		64.5	30.5	12.5
742219	19		66.0	31.0	12.5
742221	21		67.4	33.4	15.0
742222	22		68.0	35.2	15.0
742224	24		68.5	37.4	15.0
742227	27	77.5	41.7	17.5	
742230	30	79.0	45.3	17.5	
742232	32	80.3	47.8	17.5	
742234	34	82.3	50.8	19.0	
742236	36	82.6	53.0	19.0	
742241	41	85.5	59.3	19.0	



- Accuracy: CW±4%
- Matt Finish
- ABS Handle

Item no.	Square Driver	Teeth	Range	PCS/CTN
747805G	1/4"	24T	4-25Nm	25
747806G	1/4"	24T	5-30Nm	25
747807G	3/8"	24T	20-110Nm	12
747808G	3/8"	24T	25-140Nm	12
747809G	1/2"	24T	40-210Nm	12

7478...
1/4", 3/8" & 1/2" Dr. Digital Torque Adapter

- Converts Any Ratchet Or Breaker Bar Into A Digital Torque Wrench
- Displaying Torque Value When Pressure Is Applied
- 180 Degrees Swivel Screen
- LED Backlight
- 10 Memory Settings

Item no.	Size	Accuracy	Range	
747802	1/4"	±3%	6-30Nm	5-22 FT-LB
747803	3/8"	±2%	27-135Nm	20-100 FT LB
747804	1/2"	±2%	40-200Nm	30-148 FT LB

726...
1/4" Hex Drive Torque Screwdriver

- Accuracy: CW±6%

Item no.	Range	Graduation	L(mm)	PCS/CTN
726017	0.4-2.6Nm	0.02	180	24
726204	1-3.5Nm	0.05	195	24

725017
1/4" Square Drive Torque Screwdriver

- Accuracy: CW±6%

Item no.	Range	Graduation	L(mm)	PCS/CTN
725017	0.4-2.6Nm	0.02	180	24

747414M Angular Torque Gauge



- Flexible Arm
- Strong Magnet
- Square Drive: 1/2" x 1/2"
- Weight: 255g

747414 Angular Torque Gauge



- 360° Scale Clearly Marked In 2° Increment
- Indicator Etched On Clear Plate, Protects Angle Scale From Dirt And Grease
- For Angle Indicate To Use With Torque Wrench Torque Wrench Or Ratchet
- Square Drive: 1/2" x 1/2"
- Weight: 159g
- Blister Card/CTN: 100

747414S/747616 Angular Torque Gauge



- Robust Aluminum Alloy Scale Plate
- Two Lengths Arm Flexibility to Fixed Working Surface

Item no.	Square Drive	Weight	Blister Card/CTN
747414S	1/2" x 1/2"	360	50
747616	3/4" x 3/4"	621	25

748...

Torque Multiplier



- 5:1 Torque Multiplication
- Multiplication Accuracy $\pm 5\%$
- Supplied With 2 Reaction Bars

Item no.	Ratio	Range		Input	Output
748416	5:1	1500Nm	1100 FT-LB	1/2"	3/4"
748418	5:1	1500Nm	1100 FT LB	1/2"	1"
748618	5:1	2700Nm	2000 FT LB	3/4"	1"

748...

5 Pcs Torque Multiplier Set



Content:

- Multiplication Accuracy $\pm 5\%$
- Break-Away Safety Addppter
- 380mmL Straight Reaction Bar
- 90° Reaction Bar
- 90° Reaction Base
- Break-Away Adapter

Item no.	Ratio	Range	Input	Output
748614	1:6.5	231-1500Nm	1/2"	3/4"
748712	1:12	208-2500Nm	1/2"	1"

748818

5 Pcs Powerful Torque Multiplier Set



- Includes 32, 33mm Sockets, Handle And Extension Bar.
- Multiplication Accuracy $\pm 5\%$

Item no.	Ratio	Range	Input	Output
748818	1:56	3200Nm	1"	1"

The SELTA logo features a stylized red 'S' inside a white circle, followed by the word 'SELTA' in a bold, black, sans-serif font.

SELTA

The background is a collage of images related to screwdrivers. The top left shows several screwdrivers with black handles and silver shafts lying on a wooden surface. The bottom right shows a set of screwdrivers with red and black handles standing upright on a white surface. The design is accented with bold yellow and black diagonal stripes.

SCREWDRIVER

81401
Screwdriver Set In Plastic Case

- SL5.5, SL6.5 + PH1, PH2, PH3

81402
Screwdriver Set In Plastic Case

- SL3, SL4, SL5.5, SL6.5 + PH1, PH2

81403
VDE Screwdriver Set In Plastic Case

- SL3, SL4, SL5.5, SL6.5 + PH0, PH1, PH2

81404
VDE Screwdriver Set In Plastic Case

- SL3, SL4, SL5.5, SL6.5 * PZ0, PZ1, PZ2

837506
Precision Professional Screwdriver Set In Plastic Case

- SL2, SL2.5, SL3 + PH00, PH0, PH1

837507
Precision Professional Screwdriver Set In Plastic Case

- SL1.5, SL2, SL2.5, SL3 + PH00, PH0, PH1

837508
Precision Professional Screwdriver Set In Plastic Case

SL2, SL2.5, SL3, SL3.5, SL4 PH00, PH0, PH1

837507N
Insulated Precision Screwdriver Set In Plastic Case

SL1.5, SL2, SL2.5, SL3 PH00, PH0, PH1

81405
5 Pcs Impact Screwdriver Set

SL5.5, SL6.5 PH1, PH2, PH3

7008
8 Pcs Professional Phillips & Slotted Combination Screwdriver Set

- 10 SET/CTN N.W.: 8.3 KGS G.W.: 9.3 KGS CUFT: 1.23'



Item no.	Size	L(mm)
81305B	SL5	75
81306BS	SL6	40
81306B	SL6	100
81308B	SL8	150
8111B	PH1	73
8112BS	PH2	40
8112B	PH2	100
8113B	PH3	150

7010

10 Pcs Professional Hammer Phillips & Slotted Combination Screwdriver Set
 - 5 SET/CTN N.W.: 13 KGS G.W.: 15 KGS CUFT: 1.2'



S2

10 Pcs



Item no.	Size	L(mm)
813055M	SL5.5	125
813065M	SL6.5	150
81308M	SL8	150
81310M	SL10	200
81312M	SL12	200
81314M	SL14	250
8111M	PH1	80
8112M	PH2	100
8113M	PH3	150
8114M	PH4	200

7007H

7 Pcs Professional Go-Through Combination Impact Screwdriver Set
 - 10 SET/CTN N.W.: 11.5 KGS G.W.: 12.5 KGS CUFT: 1.23'



S2

7 Pcs

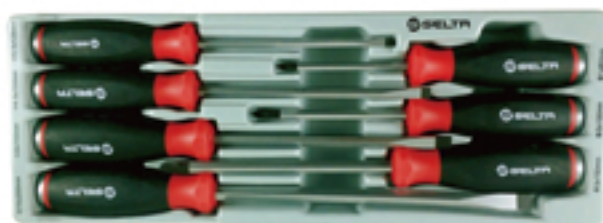

Item no.	Size	L(mm)
813055M	SL5.5	125
813065M	SL6.5	150
81308M	SL8	150
81310M	SL10	200
8111M	PH1	80
8112M	PH2	100
8113M	PH3	150

74412S

12 Pcs Hex Nut Screwdriver Set
 - 5 SET/CTN N.W.: 10.5 KGS
 G.W.: 11.5 KGS CUFT: 1.2'



Cr-V

12 Pcs



- Length: 150mm

- Contents:

74404: 4mm	74409: 9mm
74405: 5mm	74410: 10mm
744055: 5.5mm	74411: 11mm
74406: 6mm	74412: 12mm
74407: 7mm	74413: 13mm
74408: 8mm	74414: 14mm

811...
**Professional Screwdriver
Phillips Tip**

S2

Item no.	Size	L(mm)	PCS/CTN
8110B60	PH0	60	240
8110B100	PH0	100	240
8111S	PH1	25	240
8111BS	PH1	40	240
8111B	PH1	75	120
8111B80	PH1	80	120
8111B100	PH1	100	120
8111B150	PH1	150	120
8111B300	PH1	300	100
8112S	PH2	25	240
8112BS	PH2	40	100
8112B	PH2	100	120
8112B6	PH2	150	120
8112L200	PH2	200	40
8113B	PH3	150	40
8113BX200	PH3	200	40

811...M
**Professional Go-Through
Combination Impact Screwdriver
Phillips Tip**

S2

Item no.	Size	L(mm)	PCS/CTN
8111M	PH1	80	120
8112M	PH2	100	120
8112M150	PH2	150	120
8113M	PH3	150	80
8113M200	PH3	200	40

812...
**Professional Screwdriver
Pozidriv Tip**

S2

Item no.	Size	L(mm)	PCS/CTN
8120B	PZ0	60	240
8120B75	PZ0	75	240
8121BS	PZ1	25	240
8121B	PZ1	80	120
8121B100	PZ1	100	120
8122BS	PZ2	25	240
8122BX	PZ2	100	120
8122B	PZ2	200	40
8123B200	PZ3	200	40

812...M
**Professional Go-Through
Combination Impact Screwdriver
Pozidriv Tip**

S2

Item no.	Size	L(mm)	PCS/CTN
8121M	PZ1	80	120
8122M	PZ2	100	120
8123M	PZ3	150	80
8124M	PZ4	200	40
8124M300	PZ4	300	40

813...
**Professional Screwdriver
Slotted Tip**

S2

Item no.	Size	L(mm)	PCS/CTN
81303B3	SL3	75	240
813035B4	SL3.5	100	240
81304B4	SL4	100	240
81305B	SL5	75	120
81305B4	SL5	100	120
81355S	SL5.5	25	240
813055BS	SL5.5	40	240
813055B100	SL5.5	100	120
813055B	SL5.5	125	120
81306BS	SL6	40	240
81306B	SL6	100	120
81306BX	SL6	150	120
81365S	SL6.5	25	240
813065BS	SL6.5	40	240
813065B	SL6.5	100	120
813065B6	SL6.5	150	120
81308B	SL8	150	80
81308B7	SL8	175	80
81308L200	SL8	200	40

813...M
**Professional Go-Through
Combination Impact Screwdriver
Slotted Tip**

S2

Item no.	Size	L(mm)	PCS/CTN
813055M	SL5.5	125	120
81306M100	SL6	100	120
81306M	SL6	150	120
813065M	SL6.5	150	120
81308M	SL8	150	80
81308M200	SL8	200	40
81310M	SL10	200	40
81312M	SL12	200	40
81314M	SL14	250	40

716...
**Professional Screwdriver
Star Tip**

S2

Item no.	Size	L(mm)	PCS/CTN
71604	T4	65	240
71605	T5	65	240
71606	T6	65	240
71607	T7	65	240
71608	T8	65	240
71609	T9	65	240
71610	T10	80	120
71615	T15	80	120
71620	T20	100	120
71625	T25	100	120
71627	T27	115	80
71630	T30	115	80
71640	T40	130	80
71645	T45	140	80
71650	T50	150	80

717...
**Professional Screwdriver
Tamper proof Tip**

S2

Item no.	Size	L(mm)	PCS/CTN
71705B	TP5	60	240
71706B	TP6	60	240
71707B	TP7	60	240
71708B	TP8	60	240
71709B	TP9	60	240
71710B	TP10	80	120
71715B	TP15	80	120
71720B	TP20	100	120
71725B	TP25	100	120
71727B	TP27	115	80
71730B	TP30	115	80
71740B	TP40	130	80
71745B	TP45	130	80
71750B	TP50	150	80

8175...
Precision Screwdriver Phillips Tip

S2

Item no.	Size	L(mm)	PCS/CTN
8175000	PH000	75	300
817500	PH00	75	300
81750	PH0	75	300
81751	PH1	75	300

8375... & 83100...
Precision Screwdriver Slotted Tip

S2

Item no.	Size	L(mm)	PCS/CTN
837515	SL1.5	75	300
83752	SL2	75	300
837524	SL2.4	75	300
83753	SL3	75	300
837535	SL3.5	75	300
83754	SL4	75	300

Item no.	Size	L(mm)	PCS/CTN
8310015	SL1.5	100	300
831002	SL2	100	300
8310024	SL2.4	100	300
831003	SL3	100	300
8310035	SL3.5	100	300
831004	SL4	100	300

8165...N
Insulated Precision Screwdriver Phillips Tip

S2

Item no.	Size	L(mm)	PCS/CTN
816500N	PH00	65	300
81650N	PH0	65	300
81651N	PH1	65	300

8365...N
Insulated Precision Screwdriver Slotted Tip

S2

Item no.	Size	L(mm)	PCS/CTN
836515N	SL1.5	65	300
83652N	SL2	65	300
836525N	SL2.5	65	300
83653N	SL3	65	300

811...N
Insulated Screwdriver Phillips Tip

Item no.	Size	L(mm)	PCS/CTN
8116500N	PH00	65	---
811600N	PH0	60	240
811650N	PH0	65	---
811651N	PH1	65	---
811801N	PH1	80	120
8111002N	PH2	100	120
8111503N	PH3	150	80

812...N
Insulated Screwdriver Pozidriv Tip

Item no.	Size	L(mm)	PCS/CTN
812600N	PZ0	60	240
812801N	PZ1	80	120
8121002N	PZ2	100	120
8121503N	PZ3	150	80

813...N
Insulated Screwdriver Slotted Tip

Item no.	Size	L(mm)	PCS/CTN
8136515N	SL1.5	65	---
813652N	SL2	65	---
8136525N	SL2.5	65	---
8137525N	SL2.5	75	240
813603N	SL3	60	240
813653N	SL3	65	---
8131003N	SL3	100	240
8131004N	SL4	100	240
81312555N	SL5.5	125	120
81315065N	SL6.5	150	120
8131758N	SL8	175	80

744...
Hex Nut Screwdriver

Cr-V

Item no.	Size	L(mm)	PCS/CTN
74404	4	150	240
744045	4.5	150	240
74405	5	150	240
744055	5.5	150	240
74406	6	150	240
74407	7	150	240
74408	8	150	80
74409	9	150	80
74410	10	150	80
74411	11	150	80
74412	12	150	80
74413	13	150	80
74414	14	150	80

10...-...PH / 10...-...SL
Plastic Screwdriver (Black Tip)

Cr-V

Item no.	Size	L(mm)	PCS/CTN
101-02PH	PH0	50	600
101-03PH	PH0	75	600
101-04PH	PH0	100	600
101-06PH	PH0	150	600
101-08PH	PH0	200	600
102-03PH	PH1	75	300
102-04PH	PH1	100	300
102-06PH	PH1	150	300
102-08PH	PH1	200	300
102-10PH	PH1	250	300
102-12PH	PH1	300	300
104-1.5PH	PH2	37.5	360
106-06PH	PH3	150	120
106-08PH	PH3	200	120
106-10PH	PH3	250	120
106-12PH	PH3	300	120
107-04PH	PH2	100	240
107-06PH	PH2	150	240
107-08PH	PH2	200	240
107-10PH	PH2	250	240
107-12PH	PH2	300	240

Item no.	Size	L(mm)	PCS/CTN
101-02SL	SL3.2	50	600
101-03SL	SL3.2	75	600
101-04SL	SL3.2	100	600
101-06SL	SL3.2	150	600
101-08SL	SL3.2	200	600
102-03SL	SL5	75	300
102-04SL	SL5	100	300
102-06SL	SL5	150	300
102-08SL	SL5	200	300
102-10SL	SL5	250	300
102-12SL	SL5	300	300
104-1.5SL	SL6	37.5	360
106-06SL	SL8	150	120
106-08SL	SL8	200	120
106-10SL	SL8	250	120
106-12SL	SL8	300	120
107-04SL	SL6	100	240
107-06SL	SL6	150	240
107-08SL	SL6	200	240
107-10SL	SL6	250	240
107-12SL	SL6	300	240

CL204STAND

Empty Plastic Screwdriver Stand (74 pcs)

- 4 SET/CTN N.W.: 19.5 KGS G.W.: 21.5 KGS CUFT: 2.38'



* Screwdriver not included *

HAMMER & CHISEL



 **SELTA**

716...
Engineer Hammer

Item no.	Weight(g)
716300	300
716500	500
716800	800
7161000	1000

514320
Fiberglass Engineers Hammer

- Head Wgt(g) : 500
- Head ϕ (mm) : 27
- L(mm) : 320

514329
Curved Claw Hammer

- Head Wgt(oz) : 16
- Head ϕ (mm) : 28
- L(mm) : 329

514335
One Piece Solid Forged Steel Claw Hammer

- Head Wgt(oz) : 20
- Head ϕ (mm) : 30
- L(mm) : 335

51...
Rubber Hammer

Item no.	Head ϕ	mm(L)	G
51400R	40	280	520
51580R	50	320	690
51810R	55	325	940

51...
Rubber Mallet

Item no.	Head Weight(oz)	Head ϕ	Head L(mm)	Total L(mm)	Weight
510335	8 oz	46mm	80	285	335g
510395	12 oz	48mm	86	285	395g
510595	16 oz	56mm	95	310	595g
510790	24 oz	63mm	107	330	790g
511030	32 oz	68mm	116	355	1030g

51425
Club Hammer

- Head Wgt(oz) : 2.5
- Head Ø(mm) : 37
- L(mm) : 265

514B...
Ball Peen Hammer

Item no.	Head WGT(oz)	Head Ø(mm)	L(mm)
514B08	8	23.5	300
514B16	16	30.5	350
514B24	24	35.5	396
514B32	32	38.5	400
514B40	40	43.0	416

514300
Interchangeable - Tip Mallets

- Material : Nylon
- Size : Ø35mm
- Headness : 66~85 Shore D

514300N

- Head Ø(mm) : 35
- L(mm) : 300

- Material : PU
- Size : Ø35mm
- Headness : 45±5 Shore D

514300P
514280
Tubular Steel Bricklayer's Hammer

- Head Wgt(oz) : 20
- Head Ø(mm) : 26.5
- L(mm) : 280

10613
6 Pcs, Pin Punch Set

- Material:CR-V
- Phosphate Finish W/ Semi-Polished
- 2 x 8.0 x 115mm
- 3 x 8.0 x 125mm
- 4 x 9.5 x 150mm
- 5 x 9.5 x 165mm
- 6 x 12.7 x 180mm
- 8 x 12.7 x 180mm

7305
5 Pcs 8" File Set

- 10 SET/CTN N.W.: 10 KGS G.W.: 11 KGS CUFT: 1.2'



- 7305P1 1pc Flat File 8"
- 7305P2 1pc Half Round File 8"
- 7305P3 1pc Round File 8"
- 7305P4 1pc Triangular File 8"
- 7305P5 1pc Square File 8"

1054S

5 Pcs Chisel Punch Set



- Pin Punch : 4 x 10 x 150mm
- Cape Chisel : 5 x 10 x 130mm
- Cold Chisel : 12 x 10 x 130mm
- Taper Punch : 3 x 10 x 120mm
- Center Punch : 2 x 10 x 120mm

1010P

10 Pcs Punch Set



- Pin Punch:
3 x 130, 4 x 150, 5 x 160,
6 x 180mm
- Taper Punch:
3 x 120, 6 x 160mm
- Center Punch:
3 x 100, 4 x 120, 5 x 130,
6 x 140mm

1055A

5 Pcs Flat Chisel Set



- Flat Chisel:
10 x 140mm,
12 x 150mm,
15 x 160mm,
19 x 180mm,
22 x 200mm

1055P

5 Pcs Ribbed Flat Chisel Set



- Ribbed Flat Chisels:
18 x 125mm,
21 x 150mm,
26 x 200mm,
29 x 250mm,
34 x 300mm

602...

Cold Chisel



Item no.	size	mm(L)
60210150	10mm	150
60212150	12mm	150
60215180	15mm	180
60218180	18mm	180
60219200	19mm	200
60222200	22mm	200

603...

Cape Chisel



Item no.	size	mm(L)
603150	5	150

604...
Pin Punch

Item no.	size	mm(L)
6042140	2	140
6043150	3	150
6044190	4	190
6045200	5	200
6046210	6	210
6048215	8	215
60410230	10	230
60412280	12	280
60414290	14	290
60416310	16	310

606...
Taper Punch

Item no.	size	mm(L)
6062185	2	185
6063185	3	185
6064120	4	120
6064185	4	185
6065185	5	185
6066185	6	185
6068185	8	185

607...
Center punch

Item no.	size	mm(L)
60725185	2.5	185
6074185	4	185
6076185	6	185
6078185	8	185
60710185	10	185

60715
Auto Center Punch

- L(mm) : 155mm

602...
Ribbed Flat Chisels / Ribbed Flat Chisels Handle

Item no.	Size
60218125	18 x 125 mm
60221150	21 x 150 mm
60226200	26 x 200 mm
60229250	29 x 250 mm
60234300	34 x 300 mm

602250
250L

602300
300L

 - Size(W) x (L)mm :
78 x 118mm(250L) & 78 x 118mm(300L)
- Color Ring Can Be Specified

102...
Soft Grip Cold Chisel

Item no.	size(mm)	L(mm)	Octagonal Shank(mm)
10210150	10	150	8.0
10215180	15	180	10.0
10219200	19	200	12.0
10225220	25	220	15.8

103...
Soft Grip Cape Chisel

Item no.	size(mm)	L(mm)	Octagonal Shank(mm)
1035170	5	170	10
1037180	7	180	12

104...
Soft Grip Pin Punch

Item no.	size(mm)	L(mm)	Octagonal Shank(mm)
1042140	2	140	8
1043150	3	150	8
1044180	4	180	10
1045200	5	200	10
1046210	6	210	12
1048220	8	220	12

106...
Soft Grip Taper Punch

Item no.	size(mm)	L(mm)	Octagonal Shank(mm)
1062185	2	185	10
1063185	3	185	10
1064185	4	185	10
1065185	5	185	10
1066185	6	185	12
1068185	8	185	12

107...
Soft Grip Center Punch

Item no.	size(mm)	L(mm)	Octagonal Shank(mm)
1074185	4	185	10
1076185	6	185	10



- Timing Tool
- Tester
- Sensor
- Sending Unit Socket Set
- Oil Filter & Wrench

ENGINE SERIES

719T09
7 Pcs Heavy-Duty Truck Oil Filter Cap Wrench Set

- Material: Aluminum
- Contents:
1pc Hex Spanner Driver
6pcs Cap Wrench:

Size m/m	Point	Suitable For Motorcar
100.5 m/m	P-15	MAZDA, TOYOTA, FUSO
106 m/m	P-15	EUROPEAN SERIES CAR
106 m/m	P-16	MITSUBISHI
108 m/m	P-16	FUSO, HINO
110 m/m	P-17	TOYOTA
118 m/m	P-16	ISUZU

71915
15 Pcs End Cap Oil Filter Wrench Set

- Fits 3/8" or 1/2" dr.
- Max. Torque:85 ft.lb
- Contents:
65mm(2-9/16") x 14 pt x 1 Step,
65~67mm(2-9/16" to 2-21/32") x 14 pt x 2 Step,
68mm(2-11/16") x 14 pt x 1 Step,
73mm(2-7/8") x 14 pt x 1 Step,
74~76mm(3-29/32" to 3") x 15 pt x 2 Step,
75~77mm(3-15/16" to 3-1/32") x 15 pt x 2 Step,
76mm(3") x 14 pt x 1 Step,
76mm(3") x 30 pt x 1 Step,
80mm(3-9/64") x 15 pt x 1 Step,
80~82mm(3-9/64" to 3-7/32") x 15 pt x 2 Step,
90mm(3-17/32") x 15 pt x 1 Step,
93mm(3-21/32") x 15 pt x 1 Step,
93mm(3-21/32") x 36 pt x 1 Step,
100mm(4") x 15 pt x 1 Step,
1/2"(F) x 3/8"(M) Dr. Adaptor

71916
16 Pcs End Cap Oil Filter Wrench Set

- Fits 3/8" or 1/2" Square Drive
- Max. Torque: 85 ft.lb
- Contents:
 - 66mm(2-9/16") x 6 pt x 1 Step,
 - 74~76mm(2-9/32" to 3") x 15 pt x 2 Step,
 - 76mm(3") x 8 pt x 1 Step,
 - 76mm(3") x 12 pt x 1 Step,
 - 76mm(3") x 14 pt x 1 Step,
 - 86mm(3-3/8") x 16 pt x 1 Step,
 - 86mm(3-3/8") x 18 pt x 1 Step,
 - 92mm(3-40/64") x 10 pt x 1 Step,
 - 93mm(3-21/32") x 15 pt x 1 Step,
 - 93mm(3-21/32") x 45 pt x 1 Step,
 - 96mm(3-3/4") x 18 pt x 1 Step,
 - 106mm(4-11/64") x 15 pt x 1 Step,
 - 108mm(4-8/32") x 15 pt x 1 Step,
 - 108mm(4-8/32") x 18 pt x 1 Step,
 - 3-Leg Adjustable Oil Filter Wrench:
 - 65~120mm(2-1/2" to 4-3/4")
 - 1/2"(F) x 3/8"(M) Dr. Adaptor

71917
17 Pcs Heavy-Duty Oil Filter Cap Wrench Set

- Material: Aluminum Alloy Steel
- Contents:
 - 1pc 27mm Spanner W/Dipping Grip
 - 1pc 1/2" Dr. Ratchet Handle
 - 15pcs Aluminum Cap Wrench:
 - P12-76mm, P15-73mm, P15-91mm(B),
 - P14-64mm, P15-78mm, P15-92mm,
 - P14-67mm, P15-79mm, P15-95mm,
 - P14-74mm, P15-89mm, P15-101mm,
 - P14-86mm, P15-91mm(A), P18-84mm

70923
23 Pcs Heavy-Duty Oil Filter Cap Wrench Set

- Material: Aluminum Alloy Steel

Contents:

- 1pc 27mm Spanner W/Dipping Grip
- 1pc 1/2" Dr. Ratchet Handle
- 21pcs Aluminum Cap Wrench:
 - P8-74mm, P14-86mm, P15-91mm(A),
 - P12-76mm, P15-73mm, P15-91mm(B),
 - P12-91mm, P15-74mm, P15-92mm, P14-64mm,
 - P15-75mm, P15-95mm, P14-67mm, P15-78mm,
 - P15-101mm, P14-73mm, P15-79mm,
 - P18-84mm, P14-74mm, P15-89mm, P30-73mm.

71930
30 Pcs End Cap Oil Filter Wrench Set

- Fits 3/8" or 1/2" dr.

- Max. Torque:85 Ft.lb

- Contents:

- 66mm(2-19/32") x 6-pt x 1 Step,
- 65mm(2-9/16") x 14-pt x 1 Step,
- 65~67mm(2-9/16" to 2-21/32") x 14-pt x 2 Step,
- 68mm(2-11/16") x 14-pt x 1 Step,
- 73mm(2-7/8") x 14-pt x 1 Step,
- 74mm(3-29/32") x 15-pt x 1 Step,
- 74~76mm(3-29/32" to 3") x 15-pt x 2 Step,
- 75~77mm(3-15/16" to 3-1/32") x 15-pt x 2 Step
- 76mm(3") x 12-pt x 1 Step, 76mm(3") x 14-pt x 1 step,
- 76mm(3") x 30-pt x 1 Step, 76mm(3") x 8-pt x 1 Step,
- 78mm(3-2/32") x 15-pt x 1 Step, 80mm(3-9/64") x 15-pt x 1 Step,
- 80~82mm(3-9/64" to 3-7/32") x 15-pt x 2 Step,
- 86mm(3-3/8") x 16-pt x 1 Step, 86mm(3-3/8") x 18-pt x 1 Step,
- 90mm(3-17/32") x 18-pt x 1 Step, 92mm(3-5/8") x 10-pt x 1 Step,
- 93mm(3-21/32") x 15-pt x 1 Step, 93mm(3-21/32") x 36-pt x 1 Step,
- 93mm(3-21/32") x 45-pt x 1 Step, 95mm(3-3/4") x 15-pt x 1 Step,
- 96mm(3-3/4") x 18-pt x 1 Step, 100mm(4") x 15-pt x 1 Step,
- 106mm(4-11/64") x 15-pt x 1 Step, 108mm(4-1/4") x 15-pt x 1 Step,
- 108mm(4-1/4") x 18-pt x 1 Step,
- Three Leg Oil Adjustable Filter Wrench: 65~120mm
- 1/2"(F) x 3/8"(M) Dr. Adaptor

90709
9 Pcs Diesel Injector Seat Cutter Set

- The Kit Includes 5 Seat Cutting Reamers For Bosch, Delphi And Universal Application Along
- With A Special Angled Reamer For Iveco/Fiat Applications
- Include 3 Sizes Of Reamer Chuck For 17,19 And 21mm Is Suitable Cleaning For Injector Nozzle End

909G5
9 Pcs Common Rail Injector Extractor Slide Hammer Kit

- For Removing Stuck And The Seized Common-Rail Injectors Without Dismount The Cylinder Head.
- The Robust Construction Enables Rapid With Drawal, Even The Most Severely Seized Injector Will Come Out With Little Fuss.
- Material: S45C Steel
- 3.1lb (1.75kg) Slider Hammer
- Adaptor M17 x 1.0
- Adaptor M27 x 1.0 For Bosch Injector Nozzle.
- Adaptor: Puller W/M12 x 1.75
- For CDI Engines & Mercedes CDI Engines OM 611, 612, 613 etc.

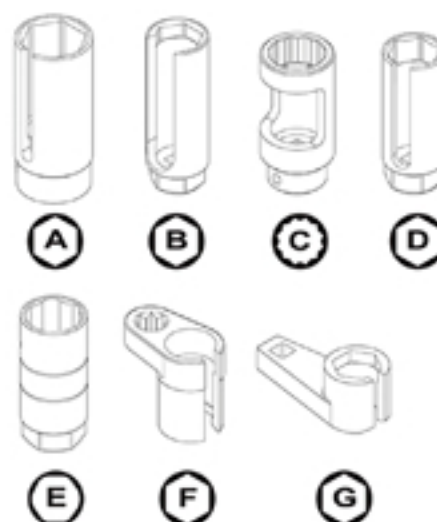
90707
7 Pcs Oxygen Sensor Socket Set

Contents	Drive	size	L(mm)
A	1/2"	1-3/16"(29mm)	90
B	3/8"	7/8"(22mm)	90
C	1/2"	1-1/16"(27mm)	78
D	3/8"	7/8"(22mm)	80
E	3/8"	1" & 1-1/16"(27mm)	74
F	1/2"	7/8"(22mm)	50
G	3/8"	7/8"(22mm)	30

77813
V-Belt Pulley Remover

Content :

- Spline Alternator Combination Bit Socket (W/33 Teeth Hex Reaction Nut)
1/2" Dr. x M10, L=110mm, Hex: 17mm
- Star Alternator Combination Bit Socket (W/33 Teeth Hex Reaction Nut)
- 10mm Hex Shank Hexagon Bits:
1/2" Dr. x T50, L=110mm,
Hex: 17mm, 8mm & 10mm (L=75mm)
- 10mm Hex Shank Star Bits:
T40 & T50 (L=75mm)
- 10mm Hex Shank Spline Bits:
M8 & M10 (L=75mm)
- Quick Change Bit Holder:
1/2" Dr. x 10mm (Hex)
- 33 Teeth Hex Reaction Nut:
Hex: 17mm, O.D. 19.5mm, I.D. 11.8mm L=30mm,
Hex: 22mm, O.D. 19.5mm, I.D. 11.8mm L=30mm
- Hexagon Reaction Nut:
Hex: 22mm, I.D. 11.8mm L=32mm
- 4 Pin Round Reaction Nut With Hex Tip:
Hex: 17mm, O.D. 35mm, I.D. 11.8mm L= 37mm

91456
56 Pcs Professional Threaded Coil-Insert Repair Kit (For Spark Plug Thread)

- Stainless Steel Screw Coil Inserts
 - 15pcs M10 x 1.0mm x 3/8" (L=9.5mm)
 - 15pcs M12 x 1.25mm x 3/4" (L=19mm)
 - 15pcs M14 x 1.25mm x 7/16" (L=11mm)
- Install Main Tool (P-type)
- Thread Taps
 - M10 x 1.0mm, M12 x 1.25mm, M14 x 1.25mm
- Coil Shielding Collar: M10, M12, M14
- Coil Installation Shank: M10, M12, M14
- Hex Key Wrench

91410
10 Pcs Professional Threaded Coil-Insert Repair Kit (For Spark Plug Thread)

- Install Main Tool (P-type)
 - 2 mm Hex Key Wrench
 - HSS Thread: M14 x 1.25 mm
 - Coil Shielding Collar: M14
 - Coil Installation Shank: M14
 - Stainless Steel Screw Coil Inserts
 - M14 x 1.25mm x 7/16" (L=11mm)

72109
Valve Spring Compressor Kit (One Man Operation Type)

- Valve Pusher Size: \varnothing 22mm
- Application: 12V, 16V, 20V, 24V Engine

72107
7 Pcs Valve Spring Compressor Kit

- Capacity(mm) : 30~130
- Throat Depth(mm) : 100

908G7
Valve Spring Compressor Tool

- Specification:
Suitable For The Replacement Of Valve Spring And Valve Stem Oil Seal Without The Need To Remove The Cylinder Head.
- Application:
Opel, BMW, Seat, VW, Audi, Hyundai, Toyota, Ford 16V, Runatle 19 & Clio

72105
Valve Spring Compressor Tool

- For Use On Most Foreign And Domestic Engines Including Audi, Nissan, Toyota, Chrysler, Infiniti, Honda, Mitsubishi, Porsche, Volvo, Volkswagen
- To Remove And Install The Valve
- Spring With The Cylinder Head On Or Off
- The OHV & OHC Petrol Or Diesel Engine

91338
38 Pcs Gasoline Engine Fuel Injection Pressure Test Kit

- Suitable For Using On American, European And Japanese Vehicles
- Large, Shock Protected
- Easy-Reading 3-1/2" Diameter Fuel Pressure Gauge With Dual Scale Reading Of 0-120 Psi And 0-8 Bar
- Includes 34 Types Of Fuel Valve Adapters And Various Tubes For Easier Connection

91308
8 Pcs Gasoline Cylinder Compression Test Kit

- Set For Testing Gasoline Engine Compression Pressure
- Includes 4 Adapters:
M10 x P1.0, M12 x P1.25, M14 x P1.25, & M18 x P1.5
- Also Includes Two Aluminum Bars (Straight And Angled) For Universal Application

91318
18 Pcs Diesel Engine Compression Test Kit

- Contents:
- 1pc 0-1000psi/0-70kg/cm² Gauge With 600mm Of Flexible Hose And Push On Adaptor Incorporating A Schrader One Way Valve.
- Side Pressure Relief Valve Allows Rapid Retesting.
- 2 pcs Non-Threaded Dummy Glowplugs
- 7 pcs Threaded Dummy Glowplugs Size:
 - 3 x M10 , 1 x M12 , 1 x M14 , 1 x M20 & 1 x M24
- 5pc Adaptor Sleeves Size:
 - 6,12,18,25 And 38mm
- 1pc 90° Coupling
- 1pc ' H ' Bracket
- 1pc Assorted Copper And Plastic Seals

91307
7 Pcs Multi-Port Fuel Injection Pressure Test Kit

- Large, Shock Protected
- Easy-Reading 3-1/2" Diameter Fuel Pressure Gauge With Dual Scale Reading Of 0~150 Psi And 0~1000 Kpa

91313
3 Pcs Cooling System Vacuum Filler Kit

- Easy Reading 2" Diameter Pressure Gauge With Dual Scale Reading Of -76~0 cmHg And -1~0 Bar

91418
18 Pcs Universal Radiator Pressure Test Kit

- Large And Easy Reading 2-1/2" Diameter Pressure Gauge With Protective Rubber Sleeve
- Pressure Range: 0~35 Psi, 0~2.5 Bar With Pressure Relief Valve And Quick Coupler
- Kit Includes A Pressure Testing Pump With Gauge, A Thermometer Needle, 13 Radiator Kits, 2 Connectors And An Adapter Handle

91428
28 Pcs Universal Radiator Pressure Tester & Vacuum Type Cooling System Kit

- Large And Easy Reading 2-1/2" Pressure Gauge And 2" Vacuum Pressure Gauge
- Pressure Range : 0~35 Psi / 0~2.5 Bar
- Vacuum Pressure Range : -76~0 cmHg / -1~0 Bar

91718
18 Pcs BMW Engine Timing Tool Set

- A Specific Tool Set For Adjustment And Arresting Of Twin Camshaft On Petrol Engine
- Blow Case: W450 x D320 x H55 (mm)
- Content :
 - Camshaft / Carrier Bracket Mounting Fixture x 1pc
 - Torsion Spring Remover / Installer x 1pc
 - Inlet Camshaft Securing Tool (Rear) x 1pc
 - Mounting Fixture Support - Long x 3pcs
 - Mounting Fixture Support - Short x 1pc
 - Intermediate Lever Clamp Set x 8pcs
 - Inlet Camshaft Securing Tool (Front) x 1pc
 - Inlet Camshaft Securing Tool (Front) Lock x 1pc
 - Bolt And Nut x 1pc

91704
4 Pcs Engine Timing Tool Set For VW Polo, Lupo

- VW Group 1.2 Single(6V) And Twin Camshaft(12V)
- 3 Cylinder Petrol Engines in SEAT, LBIZA/CORDOBA, SKODA, FABIA, VW, POLO
- Engines AWY And AZQ
- For Locking Of Both Camshafts And Crankshaft

91708
8 Pcs BMW Engine Timing Tool Set

- A Specific Tool Set For Adjustment And Arresting Of Twin Camshaft On Petrol Engine
- Blow Case: W330 x D235 x H50 (mm)
- Content :
 - VANOS Alignment Plate
 - Camshaft Setting Plate Securing Screw
 - Camshaft Setting Plate (Inlet)
 - Camshaft Setting Plate (Exhaust)
 - Timing Chain Tensioner Pre-Load Tool
 - Camshaft Turning Tool
 - Flywheel TDC Locking Pin
 - Crankshaft Alignment Pin

91717
Ford Engine Timing Tool Set

- Used For FORD 2.0 / 2.4 16V TDDi / TDCi Motoren, z.B. Mondeo, Transit (01-04) etc.
(Motorcode: FMBA/B, D5BA, ABFA, D3FA, F3FA, D2FA, D4FA, F4FA)

91710
Timing Chain Test Tool (For VW)

- Application: Checking Elongation Of Timing Chain
- Type/Model: Various Volkswagen Group Models
- Engine/Assembly Group:
 - 4 cyl. Injection Engine (1.2 | Engine, Direct Injection, Turbocharger)
 - 4 cyl. Injection Engine (1.4 | Engine, Direct Injection, Turbocharger)
- Reference: For Example Golf 2009

91731
Balancer Puller & Installer

- Professional Tool Set For Balancer Replacement.
- Built-In Bearing Makes Balancer Replacement Easy & Damage-Free For Use On Most Cars.
- 6 Slot Puller Plate Plus 9 Threaded Adaptors Fit To Balances On Most Engines For Use On Most Cars.

Contents :

- 1pc Puller Plate
- 7pcs Washers: 4pcs 20mm (DIA.) & 3pcs 16mm (DIA.)
- 12pcs Nuts, 3pcs Each Of:
 - 3/8NC16 x 57mm (L), 3/8NC24 x 57mm (L), M6 x 1.0 x 60mm (L), M8 x 1.25 x 60mm (L)
- 1pc 10mm Hex Centre Bolt
- 9pcs Threaded: M12 x 1.5 - 3/8NC16, M14 x 1.5 - 3/8NC16, M16 x 2.0 - 3/8NC16, 1/2 x NC20 - 3/8NC16, 9/16 x NC18 - 3/8NC16, 7/16 x NC20 - 3/8NC16, 3/4 x NC16 - 3/8NC16, 5/8 x NC18 - 3/8NC16, 3/8 x NC16 - 3/8NC16

91715
Engine Timing Tool Set-FORD & MAZDA

- This Comprehensive Set Of Tools Enables The Correct Engine Timing To Be Made When Replacing The Timing Belt.
- Applicable:
 - FORD Duratec Petrol Engine: 1.25, 1.4, 1.6, 1.7, 1.8, And 2.0 Twin Cam 16V.
 - FORD Duratorq Diesel Engine: 1.4, 1.6, 1.8, 2.0 TDCI.
 - MAZDA: PSA1.4, 1.6HDI Engine.

91709
8 Pcs Timing Locking Tool kit

- All Purpose Set Fits Nearly All Models:
- Camshafts Opel Calibra Omega, Sintra, Vectra -1.8/2.0
- Camshafts Opel Calibra Omega, Sintra, Vectra -1.4/1.6
- Right Camshaft SAAB 900, 900 -2.5/3.0
- Opel Calibra, Sintra Vectra -2.5/3.0
- Camshafts Locking Tool For VW, AUDI, SKODA, Seat Und Ford
- Flywheel Holding Tool For CITROEN Fiat Und Peugeot
- Flywheel Holding Tool For ISUZU 1.5/1.7 Diesel
- Opel:1.6 /1.7 Diesel Opel 1.2/1.4/1.6/1.8/2.0 OHC

91701
VW, AUDI Timing Tool Set (1.4 1.6 FSI)

- Installing And Removal Of Camshaft / Variable Camshaft Timing Unit
- Checking And Adjustment Of Timing
- Application:
VW POLO,Golf, Touran, Caddy, SKODA, Octavia AUDI A3

91702
Engine Timing Belt Tool Set

- No Damage And Overstretching Of Elastic Multi-Ribbed Belt During Mounting
- Applicable Vehicle:
ALFA ROMEO, BMW, CHRYSLER, SEAT, SKODA, SMART VOLVO, VW-AUDI, ETC

606375B
3 Pcs 3/8" Dr. Glow Plug Socket Set (6pt)

- 3/8" Dr. Glow Plug Sockets (75mmL)8, 10, 12mm
- Application:
Mercedes, Audi, VW, Opel, Fiat And ETC

609314U
3/8" Dr. Universal Spark-Plug Socket (12pt)

- 14mm x 3/8"D x Bi Hex (12pt)
- Length: 92mm
- Manufactured From Chrome Vanadium
- Bi-Hex Socket With Wobble Function
- Suitable For Spark Plugs With 12pt Profile On
BMW Vehicles: 1 Series (E81/E87-N43B),
3 Series (E90-N43B) & 5 Series (E60-N43B)

95558
Toothed Sockets For Truck Diesel Pressure And Injector

- Square Drive Nominal Size 12.5 = 1/2"
- 1/2" Dr. x 72mm(L) x 4 Toothes:
- Mercedes Trucks Engines
- OM 401/421, OM 403/423, LA, A, OM 470

95559
Toothed Sockets For Truck Diesel Pressure And Injector

- Square Drive Nominal Size 12.5 = 1/2"
- 1/2" Dr. x 72mm(L) x 4 Toothes:
- Mercedes Trucks Engines
- OM 401/421 , OM 403/423, LA, A , OM 470

70916
GM Thermal Sensor Switch Socket

- Material: CR-V
- Size:1/2" Dr. x 78mm(L) x 1-1/6" (27mm) (12pt)

77402
VW, AUDI V-Belt Pulley Remover

- Use With 17mm Wrench.
- Applicable:VW GOLF, VENTO,PASSAT, AUDI A3, & VOLVO

44327 & 44390
1/2" Dr. Long Oxygen Sensor Socket

Item no.	Size	mm(L)
44327	27mm x 12pt	78
44390	22mm x 6pt	90

443150
Extra Long Oxygen Sensor Socket

- Size:1/2" Dr. Socket 22mm x 6pt
- Material:CR-MO
- Length:150mm
- Suitable For
- MERCEDES-BENZ C/E, 602, 605, 606
- VW/AUDI/SKODA/SEAT,BMW,FORD,
- OPEL,ROVER,VOLVO

64101
5 Pcs Spark Plug Rethreader Set

- Repairing Stripped Or Damaged Threads In Aluminum Cylinder Heads.
- Solid Steel Inserts Replace Damaged Threads.

Content:

- 1pc 14mm Spark Plug Rethreader
- 4pcs Inserts 3/8" , 7/16" , 1/2" , 3/4" Long

43330
3/8" Dr. Oxygen Sensor Socket (Low Profile Offset)

- Size: 7/8" (22mm)
- L (mm): 30

44350
1/2" Dr. Heated Oxygen Sensor Socket (90°)

- Size: 7/8"(22mm)
- L (mm): 50

44385
1/2" Dr. Oxygen Sensor Socket

- Size: 7/8"(22mm)
- L (mm): 85

774
1/2" Dr. Alternator Tools

- Material: CR-V W/Satin Finished
- Contents:
- 1- 1/2" Dr. Spline Socket Bit: M10 x 110mmL

778
1/2" Dr. Alternator Tools

- Material: CR-V w/Satin Finished
- Contents:
- 1- 1/2" Dr. Trox Socket Bit: T50 x 110mmL
- 1- Reaction Corkscrew Cap: 33 Teeth x 19mm(Dia.) x 17mm (Hex)

71900

Oil Filter Remover Strap Wrench



- 1/2" Dr. Multiway For Driver
- Nylon Webbing Strap.
- Working Capacity:150mm(Dia.)

71903

3/8" & 1/2" Dr. Strap Type Oil Filter Wrench



- Extra Wide Nylon Webbing Strap.
- Also Be Used With 21mm (13/16") Spanner.

90301

Battery Pole And Terminal Cleaner



- Length(mm) : 84

2124

2 Pcs Spot Weld Cutter



- Double-Edged 3/8" & 5/16" Cutting Blade Assures Extra-Long Life.
- 500 R.P.M. Working Speed 1/4" Arbors.
- For Use With All 1/4" Or Larger Variable-Speed Drills.
- Heat-Treated Tool Steel Blades.

9U0706

S-Type Oil Drain Plug Key Wrench



- Body Dia: 12mm
- Length: 255mm
- Size: Square S8 x S10

9U0707

Injection Pump Wrench



- Size (mm) : 13
- L (mm) : 160

90103

Extra Long Valve Stem Seal Ring Pliers



- Medium Carbon Steel Jaw W/ Black Finished
- Satin Finish Grip
- Length:275mm

739230

Multi-Purpose Oil Filter Plier



- Material:CR-V w/Satin Nickel Finished
- Jaw Opening:2-1/8" ~ 4-5/8" (53~118mm)

739250/739300

9"(L) /10"(L) Hi-Deluxe Oil Filter Wrench



739250

- Material: Carbon Steel
- Removes Stubborn Filters: 60~90mm



739300

- Material: Carbon Steel
- Removes Stubborn Filters: 85~115mm

72517

Automatic Hose Clamp Pliers



- Adjustable Noses And Automatic Clamp Holders.
- For Self-Gripping Clamps With Flat Norma And Muhr And Bender Section Used On Refrigeration Circuit Sleeves.
- Red Dipping Handle
- Total Length:275mm

72518

Ratchet Type Hose Clamp Pliers Cross Type & Multiposition Lock



- For Easy Removal & Installation Of Ring Type Hose Clamp.
- Swivel Laws Are Cross For Positive Holding Of Large Or Small Clamps At Any Angle.
- Length:215mm

72519

Spark Plug Terminal Pliers



- Length(mm) : 200 (8")

970102 90° Bent Nose Circlip Pliers

- Tip (Dia):1.5mm

9M210 Mercedes Benz Oil Dipstick

- Benz 1997 & w/722.6 Transmission.
- Full Length:1220mm

71920 & 71924 Heavy-Duty Chain Wrench

- Material:Alloy Chain & SCM 415 Handle W/Satin Finish

Item no.	Handle	Chain Size	Working Capacity
71920	12"(L)	20"(L)	5-1/4" I.D.
71924	20"(L)	24-1/2"(L)	6-3/4" I.D.

71909 Adjustable Oil Filter Wrench

- With Notched Link Set To One Of Three Positions, This Wrench Removes Oil Filters From 2-3/4" To 4-1/4" (70mm To 108mm) In Diameter.
- Wide Range Of Sizes Makes This Wrench Nearly Universal.

71918 & 71919 Oil Filter Belt Wrench

- For Oil Filter Cartridges And Filter Housing Covers
- Profiled Steel Band Guarantees A Good Grip On The Filter
- Setting The Filter Diameter By Twisting The Knob At The End On The Handle Ergonomic Handle

Item no.	Capacity
71918	Ø65-105
71919	Ø110-165

71901 Chain Strap Oil Filter Wrench

- Material:Carbon Steel
- Driver:1/2" Dr. With 21mm(13/16") Out Hex Shank
- Working Capacity:120mm (Dia.)

71911 & 71912 Heavy-Duty Oil Filter Strap Wrench



Item no.	Length	Capacity
71911	12"	60~260mm
71912	9"	60~140mm

719... Oil Filter Chain Wrench



- Double Width Chain For Strength
- Available For All Type Of Oil Filter

Item no.	Range(mm)	Length(mm)
719350	60~105	350mm
719520	60~160	520mm

71921 12"(L) Heavy-Duty Chain Wrench



- Length:12"

719... Flexible Oil Filter Wrench



Item no.	Capacity
7196083	57~73mm
7197595	73~85mm
71992111	85~95mm
719100120	95~111mm

71922 & 71923 Steel Belt Oil Filter Wrench

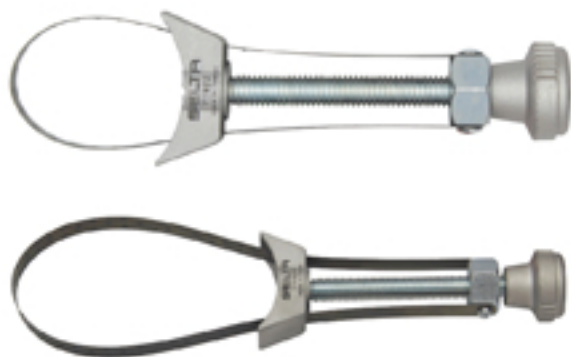

Item no.	Capacity
71922	65~105 mm
71923	110~155mm

719... Heavy-Duty Belt Type Oil Filter Wrench



Item no.	size
71907	- Grip: 246mm(L) x 16mm(w) x 6mm(T) - Belt: 730mm(L) x 22mm(w) x 5mm(T)
71908	- Grip: 210mm(L) x 18.5mm(w) x 3mm(T) - Belt: 570mm(L) x 19mm(w)
71913	- Grip: 246mm(L) x 16mm(w) x 6mm(T) - Belt: 900mm(L) x 22mm(w) x 5mm(T)

902...
Valve Lappers

- Hand Grind Small & Large Flat-Head Unslotted Valves.
- To Use Place Grinding Compound On Valve Face And Put In Seat.

Item no.	Size
90207	- 1pc 1-1/8"(29mm) And 1-3/8"(35mm) Diamter Cups For Large Valves. - 1pc 5/8"(16mm) And 13/16"(21mm) Diamter Cups For Small Valves.
90210	- 1pc 5/8"(16mm) And 13/16"(21mm) Diamter Cups For Small Valves.
90211	- 1pc 1-1/8"(29mm) And 1-3/8"(35mm)

903...
Valve Grinders With Wooden Shafts

- Suitable For Grinding-In Most Engine Valves.
- Hand Grind Small & Large Flat-Head Unslotted Valves.
- To Use Place Grinding Compound On Valve Face And Put In Seat.

Item no.	Size
90307	- 1pc 1-1/8"(29mm) And 1-3/8"(35mm) - 1pc 22 x 32mm x 255mm(L)
90310	- 1pc 19 x 22mm x 245mm(L)
90311	- 1pc 22 x 32mm x 255mm(L)

71905
2-Way , 3-Leg Adjustable Oil Filter Wrench

- 3/8"(M)sp. x 1/2"(F)sp. Adaptor(CR-V)
- 21mm Spanner Useable
- Filter Size Capacity: 63~102mm DIA.
- Operates Both Clock-Wise And Anti-Clockwise

71904
Oil Filter 3-Claw Spiral Wrench

- 1/2" & 3/8" Dr. Ratchet Handle
- Operated By 21mm Hex Adaptor:1/2"sq. x 3/8"sq.
- Two Way Operated Range:65~120mm

719... Two Way Oil Filter Wrench

- Use With 1/2" Dr. Or 21mm Wrench

Item no.	Capacity \varnothing (mm)
7196080	60~80
71980115	80~115
719115140	115~140

950178 Engine Cylinder Hone

- Suitable For Use With An Electric Or Air Drill
- The Maximum Working Speed Is 2400 rpm
- Length:300mm
- Working Capacity:50~178mm (Dia.)

950178A/B/C 3 Pcs Replacement Hone Stones

- Size:100mm(L) x 10.2mm(w) x 6.1mm(H)

Item no.	Fine Grit
950178A	100
950178B	200
950178C	300

723... Pulley Removing Wrench

Item no.	Capacity \varnothing (mm)	L(mm)
72301	50~100	215
72302	80~120	225
72303	110~160	255

719202 Hose Pinching Pliers Set

- Smooth, Rounded Jaw, Edged Prevent Damage To Internal Hose Reinforcement.
- Quick And Simple, One Handed Use
- Size:
Hose Clamp For Up To 15mm Line Diameter

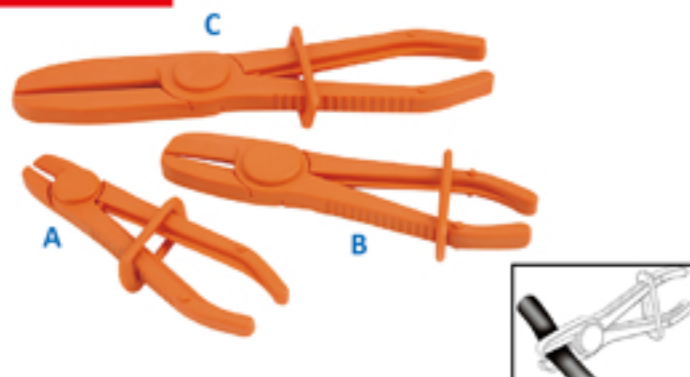
719203 3 Pcs Flexible Line Clamp Set

Item no.	Capacity \varnothing (mm)
719203A	Hose Clamp For Up To 10mm Line Diameter
719203B	Hose Clamp For Up To 15mm Line Diameter
719203C	Hose Clamp For Up To 24mm Line Diameter

72104
Valve Spring Compressor

- Opening Capacity: 35~200mm
- Restricted Access Adaptors: \varnothing 25mm & \varnothing 30mm

9G0318
Heavy Duty Seal Puller

- Heavy Duty, Heat Treated Steel 2 Tips For Multiple Applications
- Length(mm) : 318 (12-1/2")

90701
Flexible Oxygen Sensor Wrench W/Crank Handle

- Designed For All Oxygen Sensors With 7/8" Hex
- Ford Contours And 4.6L And 5.4L Ford Modular Engines Used In Trucks And SUV's Have This Application.
- 6pt Flank Drive Wrenches System For Greater Applied Torque
- Chrome Finish For Easy Cleanup And Protection Against Corrosion
- Compact, Low Clearance Head
- Overall Length: 10-3/4" (270mm)
- Hex: 7/8" (22mm), 6-point.
- Head Diameter: 1-9/16" (39.6mm)
- Slot Width: 1-5/16" (33.3mm)

90702
8-In-1 Universal Wrench For Oil Plugs

- It Has Two Swivel Heads With Locks And 8 Oil Plugs:
Square: 8, 10 mm & 3/8", 1/2"
Hexagon: 10, 12, 14, 17mm
- For Nissan Cars, Mercedes, Volkswagen, Peugeot, Renault, Toyota, BMW, Fiat, Audi, Alfa Romeo And Lancia

7203125

3" (75mm) Hi-Deluxe Piston Ring Compressor



- Material: SK5
- Adjust Dia.: 50~125mm

7203175

3" (75mm) Hi-Deluxe Piston Ring Compressor



- Material: SK5
- Adjust Dia.: 60~175mm

7204175

4" (100mm) Hi-Deluxe Piston Ring Compressor



- Material: SK5
- Adjust Dia.: 90~175mm

7206175

6" (150mm) Hi-Deluxe Piston Ring Compressor



- Material: SK5
- Adjust Dia.: 90~175mm

7316414L

End Cap Oil Filter Wrench



- Material: Iron
- 3/8" Dr. x 64.5(I.D.) x 14 Flutes
- Use For TOYOTA

7316414LT

End Cap Oil Filter Wrench



- Material: Iron
- 3/8" Dr. x 64.5(I.D.) x 14 Flutes
- Use For TOYOTA & LEXUS

70...

Heavy-Duty Oil Filter Cap Wrench



- Material: Aluminum Alloy Steel
- 1/2" Dr. (27mm) Hex Driver

Item no.	Size	Use for
706414	64mm x 14 Fluts	TOYOTA,NISSAN
706714	67mm x 14 Fluts	FORD,MAZDA
707314	73mm x 14 Fluts	TOYOTA,NISSAN
707315	73mm x 15 Fluts	GM,CHRYSLER,MITSUBISHI
707330	73mm x 30 Fluts	GM,CHRYSLER,MITSUBISHI
707408	74mm x 8 Fluts	FIAT
707414	74mm x 14 Fluts	BMW,AUDI,VW,OPEL,AUSTIM
707415	74mm x 15 Fluts	GM,CHRYSLER,ROVOR
707515	75mm x 15 Fluts	GM,CHRYSLER
707612	76mm x 12 Fluts	FORD,MAZDA,MITSUBISHI,DAIHATSU
707815	78mm x 15 Fluts	NISSAN,DAIHATSU,FORD
707915	79mm x 15 Fluts	ISUZU,FORD,DAIHATSU
708418	84mm x 18 Fluts	PEUGEOT,CITRON,RENAULT
708614	86mm x 14 Fluts	MAZDA,MITSUBISHI
708915	89mm x 15 Fluts	HONDA,CIVIC,MITSUBISHI
709112	91mm x 12 Fluts	CITRON,PEUGEOT,RENAULT
709115	91mm x 15 Fluts	TOYOTA,NISSAN
709115B	91mm x 15 Fluts	GM,FORD,CHRYSLER,LANCIA,FIAT
709215	92mm x 15 Fluts	HONDA,CIVIC,TOYOTA
709515	95mm x 15 Fluts	GM,FORD,CHRYSLER,ALFAROMEIO
7010115	101mm x 15 Fluts	MAZDA,MITSUBISHI,TOYOTA,DAIHATSU

71...

End Cap Oil Filter Wrench



- Material: 7 & 16 Gauge Sheet Metal W/ Electro-Black Finished
- Fit: 3/8" Dr. or 1/2" Dr.
- Max. Torque: 85 ft/lb

Item no.	Size	Use for
716514	65mm x 14 Fluts	CHAMP,HASTINGS,GM/AC,WIX NAPA PURPLATOR,DAIHATSU,TOYOTA
716567	65/67mm x 14 Fluts	FITS FRAM FILTERS OF CANADA INCLUDING PH4386,PH4967,PH6017,PH6018
716814	68mm x 14 Fluts	MAZDA,FORD ESCORT,CAPRI,SUBARU FRON,PH6607,MOTORCRAFT FL816
717314	73mm x 14 Fluts	TOYOTA,LEXUS
717476	74/76mm x 15 Fluts	FROM,AC,SATUM
717577	75/77mm x 15 Fluts	VW,CASLTE,GM/AC,HASTINGS, WIX NAPA,FORD,ISUZU
717614	76mm x 14 Fluts	CHAMPION,CHAMP LEE,PUROLATOR,MOPAR VW,PORSCHE,MERCEDES,BMW
717630	76mm x 30 Fluts	MOTORCRAFT,ONLY-FL400A
718015	80mm x 15 Fluts	HASTINGS,FROM,PUROLATOR,NISSAN,HONDA MOTOCECAFT,MAZDA,ISUZU,SUBARU
718082	80/82mm x 15 Fluts	MAZDA,SUBARU,TOYOTA,HONDA,ACURA NISSAN,NAPA
719015	90mm x 15 Fluts	HONDA ACCORD,MITSUBISHI,MOPAR,ISUZU
719315	93mm x 15 Fluts	CASITE,CHAMP,CHAMPION,GM,FROM,HASTINGS PUEROLATOR,WIX,NISSAN,VW,PORSCHE,RENAULT
719336	93mm x 36 Fluts	MOTORCRAFT,ONLY-FL1A,FL1B,FL300,FL820
7110015	100mm x 15 Fluts	MOTORCRAFT,WIX,ISUZU,MITSUBISHI
716414	64mm x 14 Fluts	TOYOTA
716606	66mm x 9 Fluts	FIAT,RENULT
717415	74mm x 15 Fluts	MF,AUDI,GM,ROVER,CHRYSLER
717608	76mm x 8 Fluts	FIAT,LANCIA
717612	76mm x 12 Fluts	FIAT,RENAULT,MERCEDES
717815	78mm x 15 Fluts	NISSAN,FORD,TOYOTA,ACCORD
718616	86mm x 16 Fluts	VOLVO
718618	86mm x 18Fluts	VW,AUDI,RENAULT,LAGUNA,SATRANE ESPACE,CITROEN,PEUGEOT
719210	92mm x 10 Fluts	CIUQUECENO,COUPE,CROMA,FLAT,PANDA REGATA,RITMO FLAT,SEICENTO,TEMPRA,TIPO
719345	93mm x 45 Fluts	VW,AUDI
719515	95mm x 15 Fluts	TOYOTA,ALFA,GM,FORD,CHRYSLER
719618	96mm x 18 Fluts	AUDI,VW,RENAULT,SEPACE,MEGANE
7110615	106mm x 15 Fluts	FIAT
7110815	108mm x 15 Fluts	VOLVO
7110818	108mm x 18 Fluts	RENAULT

91703
Crankshaft Locking Tool Vag 2.0 Belt Drive

- Design To Lock The Crankshafts On VW, AUDI, SEAT, SKODA 2.0 TDI Engine And ETC
- Length: 65mm

91705
3 Pcs Crankshaft Timing Belt Pulley Locking Tool Set Vag 1.9 Belt Drive

- A Special Engine Timing Tool Set For AUDI, VW, SEAT, TDI PD(1.9) And V6 Engine
- Contents:
Injection Pump Locking Pin Tensioner
Locking Tool
Crankshaft Locking Tool

324
Compression Tester

- Full 2-1/2" Scale
- Color-Coded Quadruple Calibrations With 0~300 psi 21kg/cm², 21 Bar And 2100 kpa.
- 6" Stem And 13" Durable Flexible Hose Included

92201
Diagnostic Sound Engine Tool

- Plastic Ear Pieces And 300mm Probe With Sound Amplifying Chamber

92202
Mechanic's Stethoscope

- 2 Pcs Metal Probe Extends (11~3/4") Allows Safe Access To Hard To Reach Spots

90801
Multi-Purpose Inner Tie Rod Tool

- Material: Iron W/Phosphate Black Finished
- Useable Range: 33~42mm



BODY SERIES

- Dent Puller Set
- Dolly Tools
- Axial Welding Pliers
- Remover Set
- Multi-Function Suction Cups

911G21
21 Pcs Universal Dent Puller Set

- 1pc Sliding Hammer Puller
- 1pc 22mm(w) Plastic Scraper
- 1pc Mini Dent Puller
- 1pc Heat Glue Gun Wax European Style Plug
- 9pcs Stick Pads
- 8pcs 1/2"(Dia.) x 25cm(L) Hot Melt Glue Stick

911G21-P

- 9pcs Plastic Sticker Pads.
- Material:PA6
- Replace For Universal Dent Puller Kit

76510B
10 Pcs LBS Nine Pieces Dent Puller Set

- All Packed In BMC
- Contents:

- 1pc Pipe (Dia. 22.5mm x 590mm)
- 1pc Pipe (Dia. 22.5mm x 200mm)
- 1pc 2 Hole Pipe (Dia. 29mm x 40mm)
- 1pc Hammer
- 1pc Plate(6 x 170mm)
- 1pc Plate(6 x 120mm)
- 1pc Plate(6 x 200mm)
- 1pc Plate(3 x 100mm)
- 1pc Chain & Hook
- 1pc Hex Nut(29mm)

70713B
7 Pcs Professional Grade Auto Body Repair Tool Set

- Head Material: 4140 Medium Carbon Steel
- Head Polished: Normal Polish
- Handle: Natural Color Hickory With Laser "Genuine Hickory"
- Packaging: Blow Case
- Content:

- Light Shrinking Hammer (Flat Face + Milled Square Face)
- Standard Bumping Hammer (Flat Face)
- Pick & Finishing Hammer (Crowned Face)
- Curved Dolly
- Toe Dolly
- Heel Dolly
- Utility Dolly

905M1
5 Pcs Auto Trim Removal Tool Set



- Material: Nylon + Fiberglass
- Contents:
 - 1pc Wide Edge Remover
 - 1pc Narrow Edge Remover
 - 1pc Pull Type Remover
 - 1pc Handle Remover
 - 1pc Upholstery Clip Remover

906M1
6 Pcs Mini Handy Remover Set

- Angled Clip Panel Remover
- Flat Clip Panel Remover
- Panel Remover
- Sharp Panel Removal
- Straight Panel Removal
- Clip Panel Remover

90405
5 Pcs Scraper And Remover Set

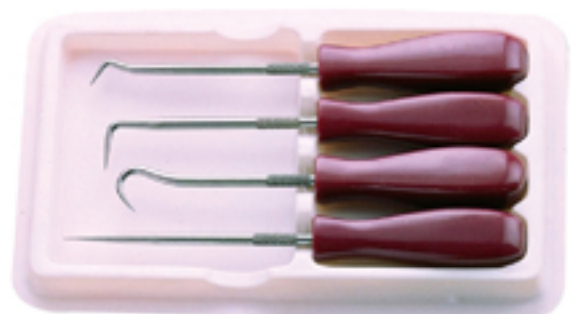
- Suitable For Variety Of Applications Including Removing Cotter Pins Radiator Hoses, Flaking Paint And Gaskets
- 11" Multipurpose Scraper
- 8-1/4" Multipurpose Scraper
- 7" Radiator Hose Remover
- 8-1/2" Scratch Awl
- 9" Cotter Pin Puller
- Packing: Display Window Box
- Material:
 - Blade: Carbon Steel
 - Handle:PP

90406
4 Pcs Mini Hook And Pick Set

- Design To Ease The Removal Of O-Ring, Cotter Pins Seals And Bushes In Various Automotive Application.
- 1pc Combination Pick
- 1pc 90° Pick
- 1pc Straight Pick
- 1pc Hook Pick
- All Lenth:125mm
- Packing: Sliding Card
- Material:
 - Blade: Stainless Steel
 - Handle:Acetate

90404

4 Pcs Door Panel Remover Set



- Carbon Steel W/Black Oxide Finish
- Removes A Variety Of Door And Body Trim Fasteners
- Long Curved Shank Supplies Adequate Leverage For Most Difficult Trim Fasteners
- Fits GM For Ford And Other Cars Using Type Of Clip Shown.
- Contents:
 - 1pc Square Notch Blade
 - 1pc Curved V Notch Blade
 - 1pc V Notch Blade
 - 1pc Door Handle & Window Lift Remover

90401 & 90402 & 90403 Trim Clip Remover

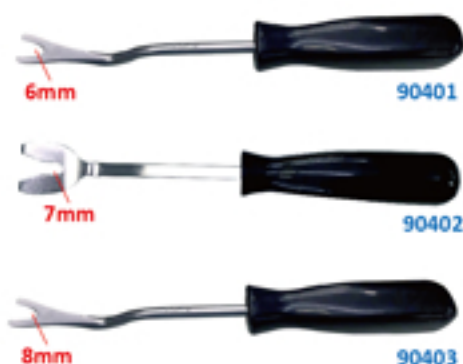

- Contents: Suitable For The Removal Of Door Trim Clip On Most Vehicles
- Material: Blade: Carbon Steel Handle: PP

905... Stainless Steel Putty Knife (Flexible Scraper)



Item no.	Size(W)	Thickness
90501	32mm	0.5mm
90502	50mm	0.5mm
90503	75mm	0.5mm

905... Stainless Steel Putty Knife (Chisel Scraper)



Item no.	Size(W)	Thickness
90505	20mm	1.2mm
90506	32mm	1.2mm
90507	75mm	1.2mm

90504 6" Flex Joint Knife w/Bit Scraper Set



- Blade Material: Stainless Steel
- Bit: 1/4" x 25mm L PH2

707152
Utility Dolly

- Head Material:
4140 Medium Carbon Steel
- Head Polished:
Red Baked Painted Finish, Normal Polish
- Packaging: PE Bag
- Packing: 6 / 12pcs / 16.5 / 16.9kgs /0.21'

707148
Thin Toe Dolly

- Head Material:
4140 Medium Carbon Steel
- Head Polished:
Sand-Blasted Finish, Fully Polish
- Packaging: PE Bag
- Packing: 6 / 24pcs / 23.1 / 23.7kgs /0.26'

707153
Curved Dolly

- Head Material:
4140 Medium Carbon Steel
- Head Polished:
Red Baked Painted Finish, Normal Polish
- Packaging: PE Bag
- Packing: 6 / 12pcs / 19.5 / 20.0kgs /0.21'

707222
Short Single Spoon

- Head Material:
4140 Medium Carbon Steel
- Head Polished:
Sand-Blasted Finish, Normal Polish
- Packaging: PE Bag
- Packing: 6 / 24pcs / 19.7 / 20.6kgs /0.44'

707168
**Light Bumping Hammer
(Flat Face)**

- Head Material:
4140 Medium Carbon Steel
- Head Polished:
Blue Baked Painted Finish, Normal Polish
- Handle:
Octagonal Shape Natural Color Hickory
Handle With Laser "Genuine Hickory"
- Packaging: Label
- Packing: 6 / 36pcs / 17.7 / 19.0kgs /0.99'

707169
**Light Shrinking Hammer
(Flat Face + Milled Square Face)**

- Head Material:
4140 Medium Carbon Steel
- Head Polished:
Blue Baked Painted Finish, Normal Polish
- Handle:
Octagonal Shape Natural Color Hickory
Handle With Laser "Genuine Hickory"
- Packaging: Label
- Packing: 6 / 36pcs / 17.7 / 19.3kgs /1.33'

707137
**Curved Pein & Finishing Hammer
(Crowned Face)**

- Head Material:
4140 Medium Carbon Steel
- Head Polished:
Red Baked Painted Finish, Normal Polish
- Handle:
Octagonal Shape Natural Color Hickory
Handle With Laser "Genuine Hickory"
- Packaging: Label
- Packing: 6 / 36pcs / 16.6 / 18.4kgs / 1.44'

707165
**Straight Pein & Finishing Hammer
(Crowned Face)**

- Head Material:
4140 Medium Carbon Steel
- Head Polished:
Red Baked Painted Finish, Normal Polish
- Handle:
Octagonal Shape Natural Color Hickory
Handle With Laser "Genuine Hickory"
- Packaging: Label
- Packing: 6 / 36pcs / 16.6 / 18.4kgs / 1.44'

1047
Air Spray Gun

- Fluid Tip Size(I.D.): \varnothing 0.8mm
- Nozzle Size: \varnothing 0.5, \varnothing 0.8 & \varnothing 1.5mm
- Cup Capacity:0.25L
- Fluid Inlet:M14 x 1.0
- Air Inlet:1/4" NPT
- Air Pressure: 35 PSI
- Air Consumption CFM:
4.5(127) L/Min
- Height Inch:12-13/16(325)mm
- Weight Lbs:0.7(0.3)kg
- Type:Gravity

1048
Air Spray Gun

- Fluid Tip Size(I.D.): \varnothing 1.4mm
- Nozzle Size: \varnothing 1.4, \varnothing 1.7 & \varnothing 2.0mm
- Cup Capacity:0.6L
- Fluid Inlet:M14 x 1.5
- Air Inlet:1/4" NPT
- Air Pressure: 50 - 70 PSI
- Air Consumption CFM:
8.8 ~ 11.3(249~320) L/Min
- Height Inch:9-1/2(241)mm
- Weight Lbs:1.6(0.7)kg
- Type:Gravity

96137
Trim Clip Removal Pliers

- L: 240(9-1/2")mm
- CR-MO

9M0106
Combination Punch & Flange Pliers

- Save Valuable Time Preparing Panel Edges.
- All Steel Construction With Spring Loaded Handles.
- Precision Made Jaws Make 10mm Flange On 18~20 Gauge Mild Steel Or Aluminium Sheet And Provide Smooth Flush Joint Between Panels.
- Turn The Head And You Have A 6mm Hole Punch For Spot Welding Or Brazing
- Fitted With Non-Slip PVC Grips.

70635

6 Pcs Axial Welding Plier set



- Contents:

- Axial Welding Pliers W-Type
- Axial Welding Pliers JJ-Type
- Axial Welding Pliers LL-Type
- Axial Welding Pliers J-Type
- Axial Welding Pliers L-Type
- Axial Welding Pliers T-Type

77901

Axial Welding Pliers W-Type



- Chrome Molybdenum Alloy Steel Jaw
- Jaw Adjustment: 0~12mm
- L:200mm
- Jaw: CR-MO
- Handle: Steel

77902

Axial Welding Pliers JJ-Type



- Chrome Molybdenum Alloy Steel Jaw
- Jaw Adjustment: 0~10mm
- L:230mm

77903

Axial Welding Pliers LL-Type



- Chrome Molybdenum Alloy Steel Jaw
- Jaw Adjustment: 0~10mm
- L:213mm

77904

Axial Welding Pliers J-Type



- Chrome Molybdenum Alloy Steel Jaw
- Jaw Adjustment: 0~14mm
- L:210mm

77905

Axial Welding Pliers L-Type



- Chrome Molybdenum Alloy Steel Jaw
- Jaw Adjustment: 0-15mm
- L:195mm

77906

Axial Welding Pliers T-Type



- Chrome Molybdenum Alloy Steel Jaw
- Jaw Adjustment: 0-12mm
- L:194mm

77909

Plug Weld Locking Pliers



- Jaw Adjustment: 0~80mm
- L:240mm
- Body:Steel Carbon W/H.T.

71301

Manual Vacuum Dent Puller



71301A

Air Vacuum Dent Puller



- Air Inlet: 1/4"
- Manual Vacuum Dent Puller

73102 & 73103

Double Suction Cups



- Loading Capacity:25kgs & 35kgs

73105

Multi-Function Suction Cups



- All Aluminum Body With Center Handle For Easy Lifting.
- Diameter:123mm
- Loading Capacity:25kg

73106

Multi-Function Suction Cups



- All Aluminum Body With Center Handle For Easy Lifting.
- Diameter:123mm
- Loading Capacity:40kg

73107

Multi-Function Suction Cups



- Triple Pad.
- A Triangular Formation Of Three Pads With A Common Handle.
- Diameter:123mm(4.84")
- Loading Capacity:35kg

73108

Multi-Function Suction Cups



- 4 Suction Cups
- Diameter:123mm(4.84")
- Loading Capacity:100kg

73104

Multi-Function Suction Cups



- The Vacuum Is Produced By Gripping The Two-Part Handle Together
- Special Feature: The Handle Allows One-Handed Operation And Thus Quick, Efficient Work.
- Diameter: 123mm
- Loading Capacity: 15kg

713...

Multi-Function Suction Cups



- The Longitudinal Holes In The Articulated Joints Allow The Transport Of Surface Which Are Curved Beyond Standard Such As Those Found On Some Automobile Windscreens.
- Aluminum Handle.

Item no.	Diameter	Loading Capacity
713075	75mm(2.95")	10 kgs
713100	100mm(3.93")	15 kgs
713125	125mm(4.92")	20 kgs

UNDERCAR SERIES

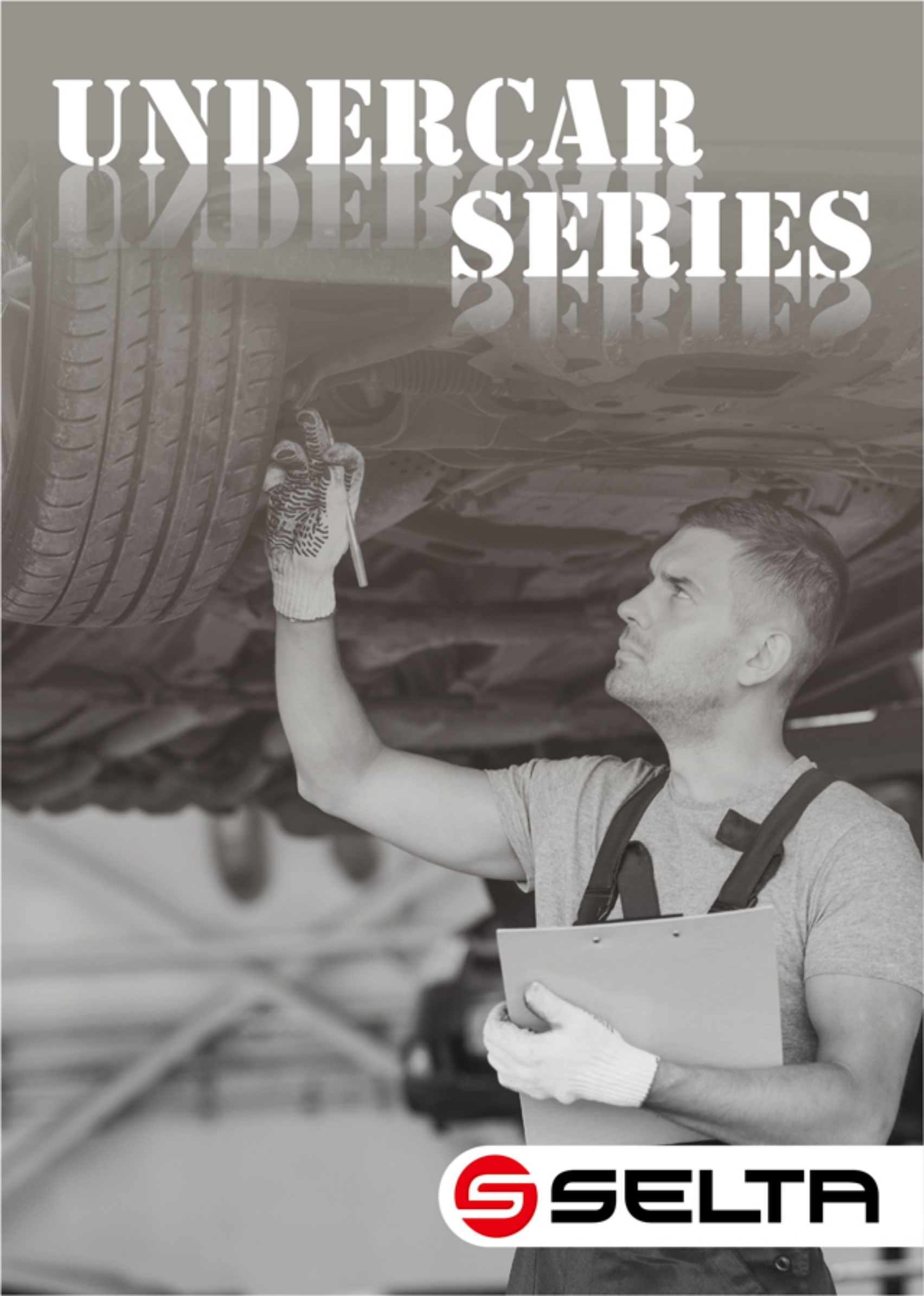

 **SELTA**

76737
Self-Adjusting Clutch Alignment Tool Kit (SAC Clutch)

- Kit Includes A Clamping Tool For SAC Clutches With 3(4) Hole Pitch, A Compression Strut, 2 Handle For Clamping Tool, A Face Spanner, A Clutch Resetting Tool, 10 Alignment Adapter, 4 Threaded Bolts - M6, M7 And M8, 4 Knurled Nuts, 4 Screw - M8

76612
12 Pcs Bearing Separator Kit

- Pull Out The Bearing With The H-Type Beam And Bolts
- Contents: 3 (Set)
 - 1pc Bearing Separator Set (Capacity 30~50mm)
 - 1pc Bearing Separator Set (Capacity 50~75mm)
 - 4pcs Main Rod
 - 4pcs Extension Rod
 - 1pc Beam
 - 1pc Central Bolt

76616
12 Pcs Bearing Separator & Puller Set

- Center Screw: 9/16"-10T/inch x 175mm(L) Yoke(S45C)
- Main/Extension Rod: Hex Bar 17mm x 127mm(L) x 3/8"-16T
- Main/Extension Rod: Hex Bar 14mm x 102mm(L) x 3/8"-16T
- 30~50mm Bearing Separator
- 50~75mm Bearing Separator

75812
12 Pcs Universal Caliper Disc Brake Wind Back Tool Kit

- Including 1pc Right Hand Threaded Rewind Tool
- 1pc Reaction Plate
- 10pcs Brake Piston Adapters
- Suitable For V.W, Audi, Ford, Nissan, Alfa Romeo, Rover, Saab, Subaru, Toyota, Jaguar And Most Of The General Motors

75818
18 Pcs Brake Caliper Wind Back Tool Set

- Suitable For Push Back And Wind Back Brake Pistons, Offers An Efficient Operation With Both Right And / Left Helix Bolt
- Magnetic Side Spindle Adapters

92424
24 Pcs FWD Front Wheel Bearing Removal & Installation Tool Kit

- Black Phosphate Finish For Corrosion Resistance
- 14 Sizes Bearing Cap Diameter: 50, 55, 59, 63.3, 66.5, 70.3, 71.5, 73.1, 73.4, 74.8, 77.5, 81.5, 83.4, 88.4 mm
- 4 Sizes Barrel Diameter: 76, 86, 91, 102 mm
- 2 Sizes Barrel Cap Diameter: 86, 102 mm
- Use With 27mm Or 32mm Wrench Or Socket

92452
52 Pcs Master Custom Built

- Discs Size: 18mm Through To 65mm In 1mm Increments And 74mm.
- Driver Handle Length: 180mm
- Select The Required Sizes And Assemble Your Driver Tool.
- Discs Are Connected With A Shaft And Screw Which Connects To The Driver Handle.

75819
Air Powered Brake Caliper Wind Back Tool Set

- Designed To Make Disc Brake Services Faster And Energy Saving
- Tool Can Be Turned Left And Right Ward Suitable For Regular And Reverse Threaded Pistons
- Pneumatic Powered Tool Is Able To Wind Pistons Back Simply Pressing A Button
- Includes 15 Adapter, Fitting A Wide Range Of Vehicles



Unit Weight (PC)	1.07 kg / 2.35 lbs
Size (mm)	258 x 173 x 97mm / 10.1 x 6.8x 3.8 in
Working Pressure	8 kg /cm ² / 113.7 psi
Noise Emission	64.3 dB
Vibration Emission	0.876 m/s ²

76624
24 Pcs Hydraulic Gear Puller Set

Contents:

- 1pc Hydraulic RAM: 37.7mm(1-1/2")Dia.
- 9pcs Leg(SCM415) 3pcs Of Each :
4"(100mm), 6"(150mm), 8"(200mm)
- 1pc Twin Head
- 1pc Triple Head
- 2pcs Extension Rods: 1"(Dia.) x 2"(L) & 1"(Dia.) x 4"(L)
- 2pcs 8"(L) Main Rod w/19mm Hex Bar
- 1pc 30mm(L) x 1"(Dia.) Sent Pop
- 1pc Beam
- 2pcs Bearing Separators: 75-150mm(L)
- 1pc Ram Ring
- 1pc Ram Part
- 2pcs 8"(L) Extension Rod w/19mm Hex Bar

7710
10 Pcs Blind Hole Bearing Puller Set

- Contents:

- 1pc Sliding Hammer:910g, Length:285mm
- 1pc Puller With 125mm Puller Range
- 5pcs Puller Bolt For Pulling Inside Bearing In Sizes 8~34mm
- 3pcs Adaptor For Removing Components With Inside Thread
- In The Following Sizes:
M6 x 1.0 , M8 x 1.25, M10 x 1.5
- Puller Bolt And Adaptors For Use With Slide Hammer And Two-Arm Pullers

76401
Master 2 & 3 Jaw Slide Hammer Puller Set

- Set Has All The Pulling Attachments For The Many Pulling Applications On Cars, Trucks, Farm Equipment And Other Machinery.

- Included:

- Adjustable Reversible Jaw x 3pcs
- Forcing Screw x 1pc, 2-Way Yoke x 1pc
- 3-Way Yoke x 1pc, Reversible Adjusting Nut x 1pc
- Screw & Nut x 3pcs, Handle Rod x 1pc
- 5 Lbs Hammer x 1pc, High Axle Puller x 1pc
- Low Axle Puller x 1pc, Inside Hook Jaw x 1pc
- Pivot Pin x 1pc, Hexagon Screw x 1pc
- Attachment x 1pc, Tapping Screw x 1, Nut x 1pc

- Working Range:

- 2/3 Way Puller Head Leg Small Reach 1.1/4"(32mm)
(Inside: 82~158mm, Outside: 19~190mm)
- 2/3 Way Puller Head Leg Medium Reach 1.7/8"(47mm)
(Inside: 31~88mm, Outside: 25~114mm)
- 2/3 Way Puller Head Leg Large Reach 4.7/8"(123mm)
(Inside: 19~70mm)

906T3
5 Pcs Front End Service Tool Set

Contents:

- 1pc Large C-Shape Puller:
Jaw Spread: 1-11/32", Throat Depth: 2-1/2"
- 1pc Small C-Shape Puller:
Jaw Spread: 1-1/8", Throat Depth: 2-1/8"
- 1pc Large Swing Arm Puller:
Jaw Spread: 0 to 2-1/2", Throat Depth: 3-1/4"
- 1pc Small L-Shape Puller:
Jaw Spread: 3/4", Throat Depth: 1-3/4"
- 1pc Large Rocker Arm Puller:
Jaw Spread: 7/8", Throat Depth: 2-1/4"

764
17 Pcs Universal Axles Slide Hammer Puller Set

- All Packed In BMC
- T Bar (5/8"-8T/inch x 24" L) S45C
- 5 Lbs Hammer, Cast Iron
- 2pcs Axle Puller (Pitch 130mm & 110mm) S45C
- Grip Wrench Adapter & Stopper Cone
- 3pcs Jaw S45C
- 3pcs Screw & Nut
- 50~75mm Bearing Separator

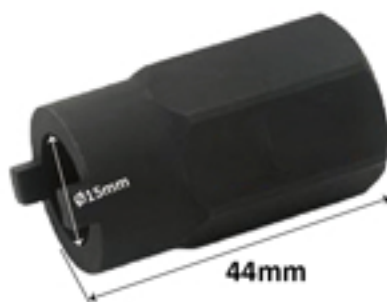
1718
VW,AUDI Strut Nut Socket

- Use With 22mm (7/8") Spanner L:44mm (1-3/4") ϕ 15mm
- Material: CR-MO
- Application: Suitable For Most VW, AUDI Vehicles

710801
Multi-Purpose Inner Tie Rod Tool

- Operated With 1/2 Inch Square Drive Hand Tools
- CR-MO
- Capacity :33~42mm

91007
Disc Brake Piston Spreader

- Chemically Blacken Steel Spreader Plates
- Maximum Pusher Width: 70mm (2-3/4")
- Capacity :0~70mm (0~2-3/4")

7B0102
Brake Spring Pliers

- Use To Remove And Install Shoe Return Springs On Most Drum Brakes
- Application: Suitable For Most VW, AUDI Vehicles
- Length:325mm (12-3/4")

72521
PSA Exhaust Pipe Clamp Pliers

- Total Length:300mm Max
- Jaws Opening:60mm
- Red Dipping Handle

72522
Angle Type Hose Clamp Pliers

- Designed With Angle Type To Any Space
- Swivel Tip Designed For Refitting And Release For Clic And Clic-R Type Hose Clamp
- Red Dipping Handle

72525
C.V. Joint Banding Tool (With Cutter)

- Use To Install And Tighten The Band-It And Strap Style Clamp On CV Joint Boots, Power Steering Rack And Pinion Steering Gear Boots
- Length:230mm(9")

72520
CV Boot Clamp Pliers - Ear Type

- Use To Remove And Install Shoe Return Springs On Most Drum Brakes
- Length:265mm (10-1/2")
- Material: CR-MO Alloy Steel

72526

CV Boot Clamp Pliers - Ear Type (Extension)



- 1/2" 4 Point Recess In The Handle For Additional Use With 1/2" Drive Ratchet, Torque Wrench And Etc.
- Length:240mm (9-1/2")

72528

CV Boot Clamp Pliers - Earless Type



- Length: 240mm (9-1/2")

7G0104

Clic-R Collar Pliers



- Material: CR-MO
- Length:180mm (7")

72801

Ball Joint Separator



- Spread Ball Joints Easily Where Space Prevents.
- Maximum Jaws Open:19mm

72804

Universal Ball Joint Separator



- Drop Forged Steel Body And Volt For Long And Rough Usage
- Material: CR-MO
- Jaw Size:22mm
- Max. Jaw Opening:56mm

72802

Universal Ball Joint Separator



- Jaw Size:22mm
- Max. Jaw Opening:60mm

72823

Ball Joint Separator



- Jaw Size A x B x C : 23 x 25 x 55mm
- M16 x 1.5 x 50
- Applicable:
Audi, BMW, Citroen, Ford, Mercedes, Opel,
Peugeot, Renault, Rover, Saab, Volvo, VW ETC.

72828

Ball Joint Separator

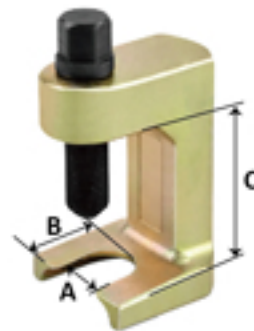

- Jaw Size A x B x C : 28 x 25 x 55mm
- M16 x 1.5 x 50
- Applicable:
Audi A4-A6-A8, VW, Passat ab '97 ETC.

728E...

Ball Joint Separator



Item no.	Jaw Size A x B x C(mm)		
728E18	18 x 36 x 38	M14 x 1.5 x 50	
728E23	23 x 45 x 47	M16 x 1.5 x 70	
728E29	29 x 62 x 65	M18 x 1.5 x 90	
728E40	40 x 63 x 76	7/8" - 14 UNF x 135	
728E46	46 x 76 x 100	7/8" - 14 UNF x 135	

72812

Pitman Arm Puller

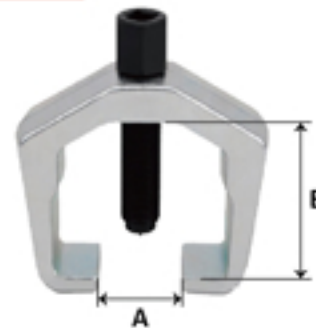

- Jaw Size A x B: 33 x 64mm
5/8"-18 UNF x 86 (1-5/16" x 2-1/2")

76604

Hub Slide Hammer Puller



- Designed To Work On Axles With Bolts And Studs Up To 9/16" Diameter.
- Fits 4 & 5 Bolt Pattern Hub, Stud Circle Diameter Range From 4" ~ 6"
- Heavy Duty Slide Hammer Action With 10 Lbs (4.5kgs) Hammer For Tough Pulling Jobs

76605

Front Wheel Drive Axle Puller



- Use To Remove And Install Shoe Return Springs On Most Drum Brakes Special Socket End Design Remove Spring From Anchor Stud, Notched End Install Spring On Anchor
- Length:325mm(12-3/4")

7506
3-Function Tire Pressure Gauge

- Pressure Range: 0~220 PSI, 0~15 Bar
- Flexible 20" High Pressure Rubber Hose With Clip-On Air Tire Chuck
- Variable Trigger, Two Control Position Inflate/Deflate Level
- Air Inlet: 1/4" PT

7507
3-Function Tire Pressure Gauge

- Multi-Function Tire Pressure Gauge: 1. Check Pressure 2. Inflate 3. Deflate
- Pressure Range: 0~160 PSI, 0~11 Bar
- Flexible 20" High Pressure Rubber Hose With Clip-On Air Tire Chuck
- Variable Trigger, Two Control Position Inflate/Deflate Level
- Ideal For Automotive Tires
- Air Inlet: 1/4" Pt

7508
4 Purpose Tire Inflator

- Dial Diameter: 2.5 Inch With Number
- Pressure Range: 0~240 PSI/ 16 Bar
- Hose Length: 16"
- Chuck: Clip Type

7501
Tire Tread Depth Gauge

- Zinc Alloy Body With Color Scale
- Easy To Read, Acrylic Lens
- Calibrated :
 - 0~11mm, Division = 1/10 di mm,
 - 0~14/32" 1 Division = 1/32 di 1"
 - Red: 0~1.6mm
 - Yellow: 1.6~2.0mm
 - Green: 2.0~11mm

7502

4 Units Tire Pressure Gauge



- Four Units: psi, bar, kpa, kg/cm²
- Dial Diameter: 2.5"
- Measures Pressure Range:
0-220 PSI, 0-15 Bar, 0-1500 Kpa, 15.3kg/cm²
- Air Inlet 1/4"
- Hose Length 32cm
- Material Aluminum

751...

Dual Tire Chuck



- Chrome-Plated Steel Dual Air Tire Chuck
- Air Inlet: 1/4" PT
- Head I.D.: 8mm
- 7512: Length 150mm (6")
- 7511: Length 205mm (8")
- 7510: Length 300mm (12")

52318

Professional Tire Repair Kit



- Professional Tire Repair Kit For All Tubeless Tire Including Steel Belted Radials, 100% Self Vulcanizing, No Cement Required.

91011 & 91012

Brake Line Flare Nut Wrench



Description:

- Material: CR-V
- Finish: Chrome Plated
- Size:
91011 : 10 x 11mm
91012 : 10 x 12mm
- Length: 185mm
- Profile: 6 Point

72527

Exhaust And Tailpipe Cutter



- Fifteen blades effectively cut pipe so only 1/4" turn is needed a complete cut
- Use tool to cut pipes 3/4" ~ 3" (19~76mm) in diameter
- Not for use on stainless steel

51400 & 51400A
Wheel Nut Wrench
 - 12 PCS/CTN

BEST CHOICE

- 17, 19, 21, 22mm With 1/2" Dr. Adapter (400mmL)
- For Most Car Wheel Nuts In Metric
- Chrome Vanadium Alloy Steel
- Polished Chrome Plated

51400A
75902...
Professional 2 Arms Gear Puller

- Material: CR-V W/Satin Finished

Item no.	size	Working Range
7590203	3"	40~76mm
7590204	4"	50~102mm
7590206	6"	60~152mm
7590208	8"	80~203mm
7590210	10"	100~254mm
7590212	12"	120~305mm

75903...
Professional 3-leg Gear Puller

- Material: Forged CR-V Steel
- Leg: Chrome Plated & Heat Treated
- Main Screw: Black Oxidised

Item no.	size	Working Range
7590303	3"	40~78mm
7590304	4"	50~102mm
7590306	6"	60~152mm
7590308	8"	80~203mm
7590310	10"	100~254mm
7590312	12"	120~305mm

7592304
Alloy 2 & 3 Jaws, Reversible Puller

- Forcing Screw (9/16"-20 T/inch x L175mm SCM 415)
- Cross Head (SCM 415)
- Steel Plate 6 Pieces
- Screw & Nut 6 Pieces
- 4" Jaw 3 Pieces (SCM 415)
- Max. Capacity: 5 ton

7592306
Alloy 2 & 3 Jaws, Reversible Puller

- Forcing Screw (9/16"-20 T/inch x L175mm SCM 415)
- Cross Head (SCM 415)
- Steel Plate 6 Pieces
- Screw & Nut 6 Pieces
- 6" Jaw 3 Pieces (SCM 415)
- Max. Capacity: 5 ton

65903
3 Jaw Universal Wheel Bearing Remover

- Spindle Length:200mm
- Spindle Thread:M20 x 1.5
- Pressure Mushroom:
 \varnothing 34mm Angesteckt Secured With O-Ring
- Arm Width:27mm
- Off Length:98mm
- Weight:2642g
- Use Range: \varnothing 50- \varnothing 120mm

766...
Universal Bearing Puller

- Material:Alloy Steel W/Black Oxide Finished
- This Is Kind Of Bearing Disassembly Tool For Amateur Cars, Electric Tools & Electric Products.

Item no.	Disassembly Out Wheel Capacity	Hook Length	Highest Loading Capacity
766035	19mm~35mm	50mm	1.0 ton
766055	24mm~55mm	100mm	1.3 ton

766...
Bearing Separator

- Material :CR-MO

Item no.	Size(mm)	Extension Rod
766050	30mm~50mm	3/8" - 16T
766075	50mm~75mm	3/8" - 16T
766105	75mm~105mm	M12 x 1.75P
766150	105mm~150mm	5/8" - 11T

76619
Pilot Bearing Puller.(PAT)

- Material:CR-V Alloy Steel Jaws
- From 1/2"(13mm) ~ 1-1/2" (38mm) Inside Diameter

75803
Brake Piston Wind Back Tool

- Suitable For:FORD, HONDA, JAGUAR, MAZDA, MITSUBISHI, NISSAN, ROVER

9502H
4-In-1 Ratchet Disc Brake Caliper Piston Spreader

- Works On Twin And Quad Piston Fixed Calipers, As Well As Single And Twin Piston Floating Calipers
- Centrally Located Ratchet Evenly Spreads Force In A Parallel Manner To Prevent Misalignment Of Pistons
- Ratchet Technology Gives A Full 360 Degree Swing So That The Spreader May Be Placed At Any Position
- Extended Reversing Lever Allows For Easy Change From Spreading To Retracting

7822
5 In 1 Wheel Balancing Weight Pliers

Install Clip-on Wheel Weight Remove Wheel Weight Install Wheel Weight

- The Special Design Of Patent Of Pliers Jaw Used For Two Type Wheel Balance Weights, Stick-on Wheel Weights & Clip-on Wheel Weights.
- For Stick-on Wheel Weights, The Pliers Don't Touch The Alloy Wheel , By Means Of Jaw Is Ensured That The Gripping Edges Do Not Grip Under The Adhesive Wights And Don't Damage The Rim.
- Corresponds To 95 Percent Of Adhesive Weights
- For Clip-on Wheel Weights, Also Can Used It By Special Design Of Pliers Jaw
- From The Other Side Of Pliers Jaw, Include Special Hammer For Wheel Weights, For Stick-on Wheel Weights, Please Used It With Plastic Cover To Avoid Damage The Rim, For Clip-on Wheel Weights, Please Removal Plastic Cover From Hammer Head
- On The Pliers, We Also Design Clamping Function For Clip-on Wheel Weights

7821
Wheel Balance Weight Tool

- Length:240mm
- Material:CR-V Alloy Steel

90832
Fuel Hose Clip Loosening Pliers

- For VW, Audi, Fiat, GM, Opel, And Others
- For Removal And Replacement Of Hose Clamps Connections On In-Line Fuel Filters

728300/728400
Tie Rod/Ball Joint Separator
728300

- Length:300mm(12")
- Jaw Opening Width:27mm (1-1/16")

728400

- Length:400mm(16")
- Jaw Opening Width:17mm (21/32)

90213
Brake Spring Tool

- For Domestic Brakes Not Using An Anchor Pin
- For Removal And Installation Of Retaining Spring On Such Drum Brakes

727270
Drop Forged Coil Spring Compressor

- Lead Screw Length:270mm
- Jaw Opening Width:270mm
- 5/8" - 10 Square Thread

727370
Drop Forged Coil Spring Compressor

- Lead Screw Length:370mm
- Jaw Opening Width:370mm
- 5/8"-10 Square Thread

727250
Coil Spring Compressor

- 2pcs Coil Spring Clamp, Two Jaw Type
- Ductile Cast Iron Jaw WITH/Zinc Plated
- Length:90(W) x 200(L)mm
- Bolt:1/2" Dr. x 21mm Dr. (Out Hex)
- Compress The Spring At 10mm Increments

75806
Fuel Tank Sender Spanner Set (Adjustable)

- Universal Application
- For Removing And Replacing The Plastic Retaining Ring On The Sender Unit On Fuel Tanks.
- Tank Sender Spanner Diameter 75~160 mm
- Drive:24mm

1022...
Universal Strut Nut Set

Item no.	Size(mm)	Applicable
1022-105	10.5 x 3.5	VW Golf Rear Axle.
1022-125	12.5 x 3.5	VW Polo Front Axle.
1022-140	14.0 x 2.5	Mercedes Benz; C-Class, CLK
1022-145A	14.5 x 5.0	Polo, Golf, Passat, Audi 80.
1022-145B	14.5 x 3.0	Austin Maestro.

72805
5 Pcs Tie-Rod/Ball-Joint Splitter Set

- Forks Made Of Drop Forged Heavy Duty Chrome Vanadium Steel
- 3 Drop Forged Forks:11/16", 15/16" & 1-1/8"
- 1 Handle For Use With Hammer
- 1 Handle Designed For Use With Pneumatic Air Hammer
- Both Handles Are Interchangeable

90833
Brake Fluid Tester

- Designed For Checking Quality Of Brake Fluid (DOT 4)
- Five LED To Indicate The Percentage Of Water In The Brake Fluid
- Length:150mm

9G0201
Flexible Hose Clamp Pliers

- Allows For Removal Of Plastic And Or Metal Self-Tightening Hose Clamps With Diameters Of 11/16" ~ 2-1/2"

90204
Fluid Siphon Pump

- Transferring Fuel From Car To Car Or Motorcycle To Motorcycle
- Pumping Fuel Into The Heater
- Extracting Water From Fish Tank
- Extracting Fluid From Tank
- Weight: 260g
- Dimension: 10m/n

90201
1L Vacuum Brake Fluid Bleeder

90202/90203
3L /1L Vacuum Brake Fluid Bleeder

90202: 3L

90203: 1L

738...
Oil & Battery Fluid Flask

Item no.	Size	PCS/CTN
73801	1L	20
73802	2L	20
73803	3L	20
73804	4L	20
73805	5L	20

90208L & 90212L

Waste Oil Receiving Pan

90224L

24L Waste Oil Receiving Pan



- Size:
90208L : 8L
90212L : 12L

90212

Oil Trays



- Size: L455 x W340 x H85mm

737...

Oil & Battery Fluid Flask



Item no.	Size	PCS/CTN
73705R	5L	20
73710R	10L	10
73720R	20L	5

76703

3 Pcs 1/2" Dr. Special Pentagon Socket Set



Content:

- 1pc 10mm x 56mm(L) Pentagon Bit Socket: For Girling Brake System
- 1pc 14mm x 38mm(L) 6-PT Socket:
For Pentagon Brakes On Rear Brake Opel, Vauxhall (Astra G, Zafira), Smart
- 1pc 19mm x 38mm(L) 6-PT Socket:
For Bendix Brakes Citroen, Peugeot, Renault

76706
6 Pcs Drive Shaft Socket Set

Content:

- Specifically Designed For Front Hub Nuts.
- Material : CR-MO
- Driver Size: 1/2" (12.5 mm)
- Sockets(12PT): 30mm, 32mm, 36mm
- Impact Hexagon Key: 14mm, 17mm, 19mm
- For: TOYOTA, FORD, SUBARU, MERCEDES, BMW, VW GROUP, FIAT, RENAULT, PSA...

90206
Hand Operated Oil Pump

Feature:

- Suitable For All Sorts Of Machinery, Vehicles, Airplanes, Ships, Etc. The Efficient Instrument For Infusing Grease Powerfully For Lubrication & Maintenance Purpose.
- The Barrel Is Of Japanese Type And Is Of High Class Design. The Base Is Equipped With Foot Stepping Stand. The Operation Will Be Even Better With Foot Stepped On It

90217
Air Operated Grease Pump

Feature:

- The Barrel Body Is Made Of High-Grade Steel Plate. It Came To Become Durable And Lasting Even More After Being Made Manually.
- Inside Diameter(ID) Of Barrel Is 350mm. The Inside Height Of Barrel Is 430mm.
- Suitable For All Sorts Of Machinery, Vehicles, Airplanes, Ships, Etc. The Efficient Instrument For Infusing Grease Powerfully For Lubrication & Maintenance Purpose.

Capacity	Air Input Pressure	Pressure Ratio	Grease Output Pressure	Deliver Rate	Hose Length
30L	4-9 Bar 60-130 Psi	45:1	180-450 Bar 2700-5850 Psi	30 cc/Sec	10 ft

92801**Wheel Dynamic Balancer****Contents:**

- Single Phase Power: 220v 60hz 1hp
- LCD Display Size: 160 x 136 mm
- LCD: Dc +5v.250mam, -5v.50ma
- LCD Display Mode: VGA
- Resolution: 800 x 600
- Max Wheel Diameter:10"~24"
- Max Wheel Width:1.5"~20"
- Max Wheel Weight:70kg
- Wheel Balancing Speed:210rpm
- Measurement Time: 10 sec
- Machine Size:120 x 70 x 110cm
- Machine Net Weight:85KG

92802**Tire Removal Machine****Contents:**

- Power:220v 50/60hz
- Bead Breaking Pressure:2700kg
- Working Pressure:8 ~ 8.5kg
- Max wheel Diameter:100cm
- Max rim Width:32cm
- External Clamping:10"~20"
- Internal Clamping:12"~22"
- Machine Dimension:105 x 88 x 175 cm
- Machine Weight:170kg



BATTERY & ELECTRICAL



76275
Tube Cutter, Flaring & Swaging Tool Set

- Content:
Flaring Bar (Small Size) :

1/8", 3/16", 1/4", 5/16", 3/8", 7/16" O.D. Tubing

Flaring Bar (Large Size) :

1/2", 5/8", 3/4" O.D. Tubing

Tube Cutter W/Retractable Reamer
Cutting Capacity : 1/8" ~ 1-1/8"
Steel Yoke
Swaging Adapter :

3 in 1(3/16", 1/4", 3/8"), 5/16", 1/2", 5/8", 3/4"

45° Flaring Adapter
76226
Tube Cutter & Double Flaring Tool Set

- Content:
Flaring Bar :

3/16", 1/4", 5/16", 3/8", 7/16", 1/2", 5/8", O.D. Tubing

Tube Cutter W/Retractable Reamer
Cutting Capacity : 1/8" ~ 1-1/8"
Steel Yoke W/45° Flaring Cone
Flaring Adapter :

3/16", 1/4", 5/16", 3/8", 7/16", 1/2", 5/8" O.D. Tubing

76522

Deluxe Flaring Tool Set



- 6 In 1 For Sizes: 3/16", 1/4", 5/16", 3/8", 1/2" & 5/8"
- With 6 In 1 Adapter

88023

23 Pcs Universal Terminal Release Tool Set



- Blow Case:
- W435 x D250 x H75 (mm)

110822

Universal Wrench



- Complete With Knurled Sides And An Adjustment Knob To Give A Snug Fit.
- Drop-Forged Chrome Vanadium Body w/Satin Finished
- Three Fixed Contact Points For High Torque; Applicable To Straight Nuts
- Working Range: 5/16"~7/8" (8~22mm)
- Size: 9"

111632

Universal Wrench



- Complete With Knurled Sides And An Adjustment Knob To Give A Snug Fit.
- Drop-Forged Chrome Vanadium Body w/Satin Finished
- Three Fixed Contact Points For High Torque; Applicable To Straight Nuts
- Working Range: 5/8"~1-1/4" (16~32mm)
- Size: 11"

952001

Battery Terminal / Wiper Pick Up Tool



- To Work For Battery Terminals And Windshield Wipers Etc

952002

Battery Terminal Alternator Bearing



- The Tight Terminals Will Be Lifted Off Without Damage To The Battery Case Or Posts

92588
Battery Load Tester

- Suitable For 6 & 12 Volt Batteries.
- Test:
 - State Of Charge
 - Cranking Ability
 - Charging System Output
 - Starter Motor Test

92588D
Digital Battery Load Tester & Charging System Analyzer

- Microprocessor Controlled Design Guarantees An Easy And Accurate Load Test Possible And No Need To Time Yourself Anymore.
- Suitable For 12 Volt Batteries.
- Test:
 - State Of Charge
 - Cranking Ability
 - Charging System Output
 - Starter Motor Test

68111
Digital Multimeter

- Maximum Display: 1999 Counts(3 1/2 Digits LCD) With Automatic Polarity Indication.
- Polarity:Automatic Negative Polarity Indication.
- Power Supply: One 9 Volt Battery

68427
3~48V Circuit Tester

- Probe: 2.0mm(Dia.) x 19mm (L)
- 90cm Insulated Electric Wire

68423
**6V~24V Circuit Electrical
Copper Tester**

- Material:Copper
- Wire Length:80cm
- Circuit Tester(6~24 Volt System)

68433
6~24V, Auto Car Electrical Probe Tester

- Material:Iron + AS
- Voltage Measurement Range:DC 6~24V
- Cable Length:85cm

7902
**Battery Clamp 600A Red &
Black In Set**

68434
LED Circuit Tester

- Quickly And Safely Tests High And Low Voltages On All Vehicle Voltage, Including Computerized Engine.
- Checks High And Low Voltages(Power And Ground) On 6, 12 And 24 Volt System.
- LED Indicates Red For Power (High) And Green For Ground (Low)

68104

Hydrometer Battery Tester



- Test all 6, 12, 24 Volt Systems

90444

Hydrometer Battery Tester



- Avoid Winter Freeze-Ups And Summer Boil-Over.
- Tests All Permanent (Ethylene Glycol) Solutions With Radiator Hot Or Color.
- Two Scales Show Freezing Point Of Radiator Solution And Boiling Point Of Summer Coolant.

68103

Battery Hydrometer



- For Testing Density Of Battery Electrolyte.
- With Glass Tube, PVC Bulb And Spout.

88020

20 Pcs Radio Removal Tool Set



 **SELTA**



**PLIERS &
SCISSORS**

79803

Professional Electrician Scissors

- 72PCS/CTN N.W.:9KGS G.W.:11KGS CUFT:1.88'

**MUST
HAVE**



- Blades Are Made From High Tensile Steel, And Allowing For Excellent Strength And Performance
- Light And Strong Handles Are Made From Impact
- Suitable For Cutting Soft Cable And Power Cords Off.
- Resistant Plastic Material
- Embedded An Anti-Slip Ridges TPR On Handles.

- Specifications:

Length: 150mm
Blades Material: 420J2 Stainless Steel
Thickness: 3.5mm
HRC: 53±2
Finish: Polish
Handle Material: PP+TPR

79804

Professional Electrician Scissors

- 48PCS/CTN, N.W: 8.1 KGS, G.W.:10.1 KGS, CUFT: 2.13'

**MUST
HAVE**



- Professional Scissors With Special Whole Steel Frame For High Resistance And Durable Life.
- High Hardness Blades And An Anti-Slip Serrated Edge For Making Precise.
- The Functions Of Wire Stripper Between Handles Are 1.5mm² / 2.5mm²

- Specifications:

Length: 160mm
Blades Material: 4034 Stainless Steel
Thickness: 4.0mm
HRC: 58±2
Finish: Polish
Handle Material: PP+TPR
Sheath Material: Nylon

79806

5 in 1 Multi-Function Professional Electrician Scissors

- 48PCS/CTN, N.W : 8.1 KGS, G.W. : 10.1 KGS, CUFT : 2.13'



Warning :

- This Scissor Are Not Insulated. It Is Strictly Prohibited To Use The Scissors To Cut The Electrified Power Cord Off In Order To Avoid Danger

- Professional Scissors With Stronger Whole Steel Frame For High Resistance And Durable Life.
- High Hardness Blades And An Anti-Slip Serrated Edge For Making Precise.
- Light And Strong Handles Are Made From Impact-Resistant Plastic Material
- The Functions Of Wire Stripper Between Handles Are 1.5mm² , 2.5mm² , 4mm²
- Materials:
 - Length: 170mm
 - Handle : PP+TPR
 - Blades : Japan Stainless Steel
 - Sheath : Nylon

79805

Professional Electrician Scissor

- 72PCS/CTN, N.W: 8.3 KGS, G.W.:10.0 KGS, CUFT: 1.69'



Safety Switch Of Protection Set



Protection Set Can Receive The Knife And Be Used For Assist In Stripping Sheathed Wire.

- Cable Stripping Knife It Has A Protection Sheath Receiving Knife.
- With Protection Sheath Which Can Be Used For Assisting In Stripping As Well.

- Specifications:
 - Length: 190mm
 - Blades Material: 4034 Stainless Steel
 - Thickness: 2.5mm
 - HRC: 58±2
 - Finish: Polish
 - Handle Material: Nylon

79801

Hi-Deluxe Electrician Scissors



- Blade:3.0mm(T) Stainless
- Total length:5-1/2"(125mm)

79802

Professional Technician Scissors



- Blade:3.0mm(T) Stainless
- Total length:5-3/4"(145mm)

7805

3-In-1 Automatic Wire Stripper



- Alloy Steel Jaws Can Strip All Types Of Wire Form 10-26AWG (0.15 ~ 6mm²)
- With additional Swivel Knob, Adjust To Strip Wire Maximun 8AWG (8mm²) Minimum 30AWG (0.05mm²)
- Romax Cable 14/2; 12/2 Or NM-B Cable 10-14AWG
- Metal Constructed Body With Heat Treatment.
- With Bi-Component Handle
- Length:205mm, Weight:305g

6707

2-In-1 Wire Stripper & Cutter



- For Wire 0.2mm²~6mm²
- Adjustable Stop For Consistency In Wire Strip Length
- Strips Even Multiconductor Flat Wire Up To 1/2" Wide
- Size:7" (175mm)L

8804
Euro Crimper

- For Cord End Sleeves 0.25~16mm²
- Medium Carbon Steel PP Red & TPR Black Handle
- Length:178mm

8805
Tele Crimper With Ratchet

- Body Made From Mid-Carbon Steel
- Crimping Modular: 6P8P
- PP Red & TPR Black Handle
- Length:203mm
- Crimp RJ45 & RJ11 Modular Plugs

8808
7 Way Heavy-Duty Crimping Tool

- Size:8-3/4"
- 6 Function:
 - For Cut Wire
 - For Crimping Insulated Terminal (2.5 & 6)
 - Non-Insulated Terminal (8)
 - For Shearing Threaded Metric Bolt (M2.3, 3.0, 3.5, 4.0, 5.0)
 - For Insulated Terminal (0.75, 1.0, 2.0, 2.5, 4.0, 6.0)
 - Non-Insulated Copper Terminal (7mm, 8mm)

8809
5 Way Crimping Tool

- Size:9-3/4"
- 5 Function:
 - For Cut Wire
 - For Crimping Insulated Terminal (1.5, 2.5 & 6)
 - For Shearing Threaded Metric Bolt (ISO, M2.6, M3.5, 3.0, 4.0, 5.0)
 - For Non-Insulated Terminal (1.5, 2.5, 4.6)
 - Cutter Wire Stripper(0.75, 1.0, 1.5, 2.5, 4.0, 6.0)

8810
8 Way Heavy-Duty Crimping Tool

- Size:10"
- 8 Function:
 - Wire Cutting
 - Crimping Insulated Terminal Size: 0.5~1.5mm² (Red) , 1.5~2.5mm² (Blue) And 5.5mm² (Yellow)
 - Crimping Non-Insulated Terminals: 0.5, 2.5, 5.5 mm²
 - Crimping Non-Insulated Terminals(Open Barrel): 1.5, 2.5, 5.5 mm²
 - Wire Stripping:0.5, 0.75, 1.25, 2.0, 3.5 And 5.5mm²
 - Shears Bolts Size:2.6, 3.0, 3.5, 4.0 And 5.0mm
 - Crimping Pin Terminals
 - Bending Wire

8813
Multi-Function Crimping Tool

- Function:
Remove The Layer And Cut Off The Wire Of AWG10~AWG24 The Tool Will Not Hurt The Internal Lines And Keep The Terminal Steady
- Materials:CHTL(Cold-Rolled Steel Sheet), Powder Metallurgy, PP Handle
- Packing Description:blisters

6708
Professional Cable Stripper

- It Cuts The Insulation Material Properly And Simply.
- The Blade Length Can Be Adjusted To Match The Insulation Material Thickness.
- It Has A Built-In Storage For An Extra Spare Blade.
- On The Top Of Blade Can Shave Off The Jacket Of Cable

Item no.	Length(mm)	Ø (mm)
6708	190	8~28

6709
Rotary Cable Stripper

- Rotary Cable Stripper For Cable.
- Lever For 90° Rotation Of The Blade
- Turn The Head To Adjust Cutting Depth

Item no.	L(mm)	Capacity
6709	140	8~28

8807
7 Pcs Quick Interchangeable Ratchet Crimping Tool Kit

- Contents :
Quick Interchangeable Ratchet Crimper
Insulated Terminal:

 0.5-1/1.5-2.5/4.0-6.0 mm²
Non-Insulated Terminal:

 1.5/2.5/6.0/10.0 mm²
Open-Barrel Terminal:

 0.5-1/1.5-2.5/4.0-6.0 mm²

 0.1-0.25/0.25-0.5/0.5-1.0 mm²
Open-Barrel Terminal & D-Sub, V3.5:

 2.5/0.5/8.0-10.0 mm²
Spark Plug Connector:

 1.0 mm²
8806
6 Pcs Quick Interchangeable Ratchet Crimping Tool Kit

- Contents :
Quick Interchangeable Ratchet Crimper
Insulated Terminal:

 0.5-1.0/1.5-2.5/4.0-6.0 mm²
Non-Insulated Terminal:

 1.5/2.5/6.0/10.0 mm²
Open-Barrel Terminal:

 0.5-1.0/1.5-2.5/4.0-6.0 mm²
Insulated Cord-End Terminal (For Small Size)

 0.5/0.75/1.0/1.5/2.5/4.0 mm²
Insulated Cord-End Terminal (For Large Size)

 6.0/10.0/16.0 mm²

8812
6.5" High-Leverage Terminal Crimping Pliers

- Crimping Range: 1.25, 2, 3.5 mm²
- AWG: 17-16, 15-14, 12-11 AWG
- L: 6.5"(170mm)

8811
15" High-Leverage Terminal Crimping Pliers

- Crimping Range: 5.5, 8, 14, 22, 38 mm²
- AWG: 10-9, 9-8, 6-5, 4-3, 2-1
- L: 15"(380mm)

6710
Automatic Wire Stripper

- Capacity : 0.2 - 6.0 mm², 24 - 10 AWG
- Wire Cutter Ø(mm) : 2
- L : 190mm

8527
Cable Tie Gun

- Hardened Metal Construction Aluminum Alloy Cover
- Maximum Cable Tie Width 4.8mm
- Features:
Adjustable Tension For Changing Cable Bundle
Pressure Automatic Cable Tie Cut-ff

710175
7" Combination Plier

712B150
Diagonal Plier

Item no.	Size
712B150	6"

1004

4 Pcs Circlip Pliers Set

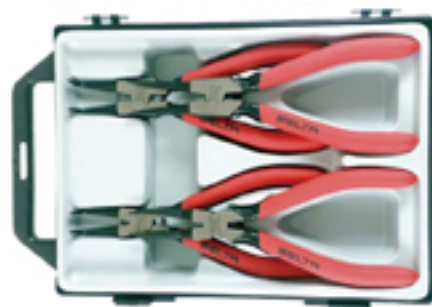

- 70180ES External(Straight) 180mm(L)
- 70180EB External(Bent) 180mm(L)
- 70180IS Internal(Straight) 180mm(L)
- 70180IB Internal(Straight) 180mm(L)

1046

4 Pcs, Professional Combination Pliers Set



- 710200A Long Nose Pliers 8"
- 710200AB Bent Long Nose Pliers 8"
- 711180A Combination Pliers 7"
- 712180A Diagonal Pliers 7"

70180ES

Circlip Pliers, External Straight, A Type



- Size:180mm

70180IB

Circlip Pliers, Internal Bent, A Type



- Size:180mm

70180EB

Circlip Pliers, External Bent, A Type



- Size:180mm

70180IS

Circlip Pliers, Internal Straight, A Type



- Size:180mm

710200AB Heavy-Duty Bent Nose Pliers

- Size:200mm(L)

710200A Heavy-Duty Long Nose Pliers

- Size:200mm(L)

711180A & 711200A Heavy-Duty Combination Pliers

Item no.	L(mm)
711180A	180
711200A	200

712180A & 712200A Heavy-Duty Diagonal Cutting Pliers

Item no.	L(mm)
712180A	180
712200A	200

719200

Double leverage Combination Pliers



- Size: 8" (200mm)
- Max Capacity :
Piano Wire : 2.5mm
Hard Wire : 3.0mm

719220

Double leverage Long Nose Pliers



- Size: 8-1/2" (220mm)
- Max Capacity :
Piano Wire: 2.5mm
Hard Wire: 3.0mm

719180

Double leverage Diagonal Combination Pliers



- Size: 7" (180mm)
- Max Capacity :
Piano Wire: 2.5mm
Hard Wire: 3.0mm

718125A

Pro-Series Electronics End Cutter Pliers



- Size: 5" (125mm)
- Max Capacity :
Soft Wire : 1.6mm

718125B

Pro-Series Electronics Diagonal Cutting Pliers



- Size: 5" (125mm)
- Max Capacity :
Soft Wire : 1.6mm

718125C

Pro-Series Electronics Combination Pliers



- Size: 5" (125mm)
- Max Capacity :
Soft Wire : 1.6mm

718150

Pro-Series Electronics Flat Nose Pliers



- Size: 6" (150mm)

718125D

Pro-Series Electronics Round Nose Pliers



- Size: 5" (125mm)

718115

Mini Side Cutter Pliers



- Size: 4.5" (115mm)
- Max Capacity :
Soft Wire : 1.2mm

742701

ESD Mini Combination Pliers



- Stainless Leaf Spring
- Size: 4.5" (115mm)
- Max Capacity:
Soft Wire: 1.4mm

742702

ESD Long Nose Pliers



- Stainless Leaf Spring
- Size: 5" (130mm)
- Max Capacity:
Soft Wire: 1.4mm

742703

ESD Bent Nose Pliers



- Size: 5" (130mm)
- Bent Nose of 40°
- Max Capacity:
Soft Wire: 1.4mm

742704

ESD Mini Diagonal Cutting Pliers



- Stainless Leaf Spring
- Size: 4.5" (115mm)
- Max Capacity:
Soft Wire: 1.6mm

742705
ESD Mini End Cutting Pliers

- Stainless Leaf Spring
- Size: 4.5" (115mm)
- Max Capacity:
Soft Wire: 1.6mm

742706
ESD Round Edges Long Nose Pliers

- Long Smooth Inside Jaws & Rounded Edges
- Stainless Leaf Spring
- Size: 5" (130mm)

742707
ESD Mini Flat Nose Pliers

- Long Slim Jaws
- Stainless Leaf Spring
- Size: 5" (130mm)

742708
ESD Mini Round Nose Pliers

- Stainless Leaf Spring
- Size: 5" (130mm)

7272...

Slip-Joint Pliers (With Wire Cutter)



- Specification :

Item no.	size	Soft wire	Medium Wire	Hard Thickness
727200	8"	2.5mm	1.6mm	8mm
727240	10"	2.9mm	1.6mm	10mm

711...M & 716...M

Long Reach Nose Pliers



Item no.	Length(mm)	Jaw Angle
71100M	11"(275)	0°
71145M	11"(275)	45°
71190M	11"(275)	90°
71600M	16"(400)	0°
71645M	16"(400)	45°
71690M	16"(400)	90°

711...M & 716...M

Long Hose Gripper Pliers



Item no.	Length(mm)	Jaw Dia.
711516M	11"(275)	5/16"
71112M	11"(275)	1/2"
71134M	11"(275)	3/4"
716516M	16"(400)	5/16"
71612M	16"(400)	1/2"
71634M	16"(400)	3/4"

720...
Circlip Pliers Straight External

Item no.	Length(mm)	Capacity	Tip Dia.
720140	5"(140)	3~10mm	0.9
720155	5"(140)	10~25mm	1.3
720180	7"(180)	19~60mm	1.8
720220	9"(230)	40~100mm	2.3
720300	12"(300)	85~140mm	3.2

721...
Circlip Pliers Bent External

Item no.	Length(mm)	Capacity	Tip Dia.
721140	5"(130)	3~10mm	0.9
721155	5"(130)	10~25mm	1.3
721180	7"(170)	19~60mm	1.8
721220	9"(215)	40~100mm	2.3
721300	12"(300)	85~140mm	3.2

722...
Circlip Pliers Straight Internal

Item no.	Length(mm)	Capacity	Tip Dia.
722140	5"(140)	8~13mm	0.9
722155	5"(140)	12~25mm	1.3
722180	7"(180)	19~60mm	1.8
722220	9"(230)	40~100mm	2.3
722300	12"(300)	85~140mm	3.2

723...
Circlip Pliers Bent Internal

Item no.	Length(mm)	Capacity	Tip Dia.	Handle
723140	5"(130)	8~13mm	0.9	140L
723155	5"(130)	12~25mm	1.3	155L
723180	7"(170)	19~60mm	1.8	180L
723220	9"(215)	40~100mm	2.3	220L
723300	12"(300)	85~140mm	3.2	300L

733...

Heavy Duty End Cutting Nippers



- Specification :

Item no.	size	Soft wire	Medium Hard Wire	Hard Wire
733150	6"	3.4mm	2mm	1.6mm
733200	8"	3.8mm	3mm	2.5mm

792250

Cable Cutter



- Size: 10"
- Max Capacity :
Cable : 17mm
Cable: 60mm²

726160 & 726200

Heavy Duty End Cutting Nippers



- 6" & 8" Can Fold 270° Multi-Functional Cutting
- Cutting Capacity:
Vinyl Coated Copper Aluminum Cables
- Specification :

Item no.	Length	Capacity Ø
726160	160mm(6")	9mm/22mm ²
726200	200mm(8")	11mm/38mm ²



716308
Heavy Duty Wire Cutter

Prohibit The Use Of Twist

- Size: 8"
- Max Capacity :
Piano Wire : 2mm
Medium Hard Wire : 4mm
Hard Wire : 3mm

717307
Wire Rope Cutter

- Size : 7-1/2"
- Max Capacity :
Wire Rope : 4mm
Hard Wire : 1.5mm

797...
Tower Pincers

- Material:CR-MO
- Max Capacity :

Item no.	size	Medium Hard Wire	Hard Wire
797230	9"	2.4mm	1.6mm
797250	10"	2.4mm	1.6mm

797230N & 797250N
Tower Pincers

- Size:
797230N: 9"
797250N: 10"
- Max Capacity :
Medium Hard Wire : 2.4mm
Hard Wire : 1.6mm

7978200
Carpenters Pincers

- Material:CR-MO
- Size: 8"
- Max Capacity :
Medium Hard Wire : 2.2mm

733175
End Cutter Pillaer

- Drop Forgrd & Heat Treated
- Precision Machined Serrated Jaws
- Comfortable Grip & Handle Material: PVC
- L(mm) : 7"(180mm)

705...
High Tensile Strength Bolt Cutter

Item no.	Size(mm)	Cutting Capacity Ø
70512	300(12")	5mm
70514	350(14")	7mm
70518	450(18")	8mm
70524	600(24")	10mm
70530	750(30")	13mm
70536	900(36")	16mm
70542	1050(42")	19mm

706...
Tin Snips

Item no.	Length
70608	180(7")
70610	250(10")
70612	300(12")

713150

Wire Stripping Pliers-With Spring



- Size: 6"
- Stripping Capacity : 10mm²

713150V

VDE Wire Stripping Pliers-With Spring



- Size: 6"
- Stripping Capacity : 10mm²

898250S/L/R

Aviation Tin Snips -
Straight/Left/Right Cut



898250L

898250S

898250R

- Drop Forged Curved Blades
- CR-MO Steel
- High Twisting Force
- Heavy Duty Mold Suitable For Sheet Metal Working And Repair
- Cutting Capacity:1.2mm Thick Steel
- Size:250mm (10 inch)
- Cuts Left And Straight
- PVC Impact Grip

899250L/R

Offset Tin Snips Left/Right Cut



899250L

899250R

- Offset Tin Snips: Left/Right Cut
- Heavy Twisting Force
- Cutting Capacity: 1.2 ~ 1.5mm Thick Steel
- L: 250mm(10")

714290F

Adjustable Jaw



Item no.	Length(mm)	Jaw Adjustment
714290F	290	91mm

714250F

Adjustable Jaw



Item no.	Length(mm)	Jaw Adjustment
714250F	250	62mm

714270F

Adjustable Jaw



Item no.	Length(mm)	Jaw Adjustment
714270F	270	73mm

714275F

Adjustable Jaw



Item no.	Length(mm)	Jaw Adjustment
714275F	275	80mm

714...AS/714... Curved Jaw-European Type

Item no.	Length(mm)	Jaw Adjustment
714125AS	6"(151mm)	0~25mm
714175AS	7"(189mm)	0~38mm
714250AS	9"(228mm)	0~48mm
714125	6"(151mm)	0~25mm
714175	7"(189mm)	0~38mm
714250	9"(228mm)	0~48mm

714A...AS/714A... Straight Jaw-European Type

Item no.	Length(mm)	Jaw Adjustment
714A175AS	7"(175mm)	0~35mm
714A250AS	9"(229mm)	0~40mm
714A175	7"(175mm)	0~35mm
714A250	9"(229mm)	0~40mm

715...AS/715... Long Nose Locking Pliers With Wire Cutters

Item no.	Length(mm)
715150AS	6"(150mm)
715225AS	9"(225mm)
715150	6"(150mm)
715225	9"(225mm)

714245AS/714250A Larger Jaw-European Type

Item no.	Length(mm)	Jaw Adjustment
714245AS	10"(245mm)	0~51mm
714250A	10"(245mm)	0~51mm



755215A/755215
Parrot Nose Locking Pliers With Sawteeth

Item no.	Length(mm)	Jaw Adjustment
755215A	8.5"(215mm)	6~32mm
755215	8.5"(215mm)	6~28mm

766205A
Sheet Metal Locking Pliers

Item no.	Length(mm)	Jaw Adjustment
766205A	8"(205mm)	0~51mm

722230AS/722230
Welding Clamps

Item no.	Length(mm)
722230AS	9"(230mm)
722230	9"(230mm)

766...PAS/766...P
C-Clamp Locking Pliers With Swivel Pads

Item no.	Length(mm)
766150PAS	6"(150mm)
766275PAS	11"(275mm)
766460PAS	18"(460mm)
766150P	6"(150mm)
766275P	11"(275mm)
766460P	18"(460mm)



766...AS/766... C-Clamp Locking Pliers With Standard Tip



Item no.	Length(mm)
766150AS	6"(150mm)
766275AS	11"(275mm)
766155	6"(150mm)
766275	11"(275mm)



71901A Multi-Way Chain Locking Plier



- Material: Chrome Molybdenum Steel
- Harden & Satin Nickel Finished
- Welding Brazed w/3 Rivets
- American Type w/Wire Cutter
- Chain Length: 18" (460mm)

75601 Ratchet Action Hose/ PVC Pipe Cutter



- Aluminum Alloy Handle
- Stainless Steel Blade
- Max. Cutting Range: 42mm (O.D.)

75602 Auto Return PVC Pipe Cutter



- Aluminum Body Is Lighter & Corrosion Resistant
- Locks In Closed Position For Extra Safety.
- Cutting Range: 45mm

784250
Professional Flexible Pipe Wrench

- 10"(250mm) Pipe Wrench Aluminum Body
- 9 Angle In 1 Pipe Wrench
- L:250mm
- Ø:49mm, 3/8~1-1/2"

713B...
Water Pump Plier

Item no.	size
713B200	8"
713B250	10"
713B300	12"

784...
Pipe Wrench

Item no.	size	Length (mm)	Jaw Adjustment	Weight(g)	PCS/CTN	Box
78408	8"	200	8~48mm	380	72	6
78410	10"	250	8~48mm	640	48	6
78412	12"	300	8~48mm	870	36	6
78414	14"	350	8~48mm	1180	24	6
78418	18"	450	8~48mm	1830	12	6
78424	24"	600	8~48mm	2880	10	5
78436	36"	900	8~48mm	5000	6	3

75604

Stillson-Type Pipe Wrench With Adjustable Head



Content:

- Steplessly Adjustable Via Quick Tensioning Mechanics
- Handle: Aluminum Handle
- Overall Length: 260mm
- With Loosening Lever
- Material:
 - Upper Jaw: Chrome Molybdenum
 - Lower Jaw: Chrome Vanadium
- Jaw Opening Capacity: 8~31mm(5/16"~1-1/4")
- Weight: 610g



Operational Video

786...

Pipe Wrench (45° / 46° / 47° Swedish Model Pipe Wrench With S-Shaped Jaw)



Item no.	Size	Jaw Opening Capacity Ø	L(mm)
78632	1"	1-1/2"	345mm
78648	1-1/2"	2-1/4"	440mm
78664	2"	2-1/2"	560mm

76501
Adjustable Tube Cutter

- Cut Copper, Brass, Aluminum & Mild Steel Tubing
- Working Range: 1/8"~1-1/4" (3~32mm) Outside Diameter

76523
Telescopic Tube Cutter



- For Copper
- Capacity: 1/8"~1-1/8" (3~28mm)
- Including One Spare Cutting Wheel

76524
Ratchet Pipe Cutter

- One Hand Operation
- Cutting Capacity ϕ (mm): 8~28 (5/16"~1-1/8")
- Application:
 - Stainless Steel Tube (Wall Thickness \leq 2mm)
 - Copper, Aluminum & Plastic Tube (Wall Thickness \leq 3mm)

76525
Ratchet Pipe Cutter

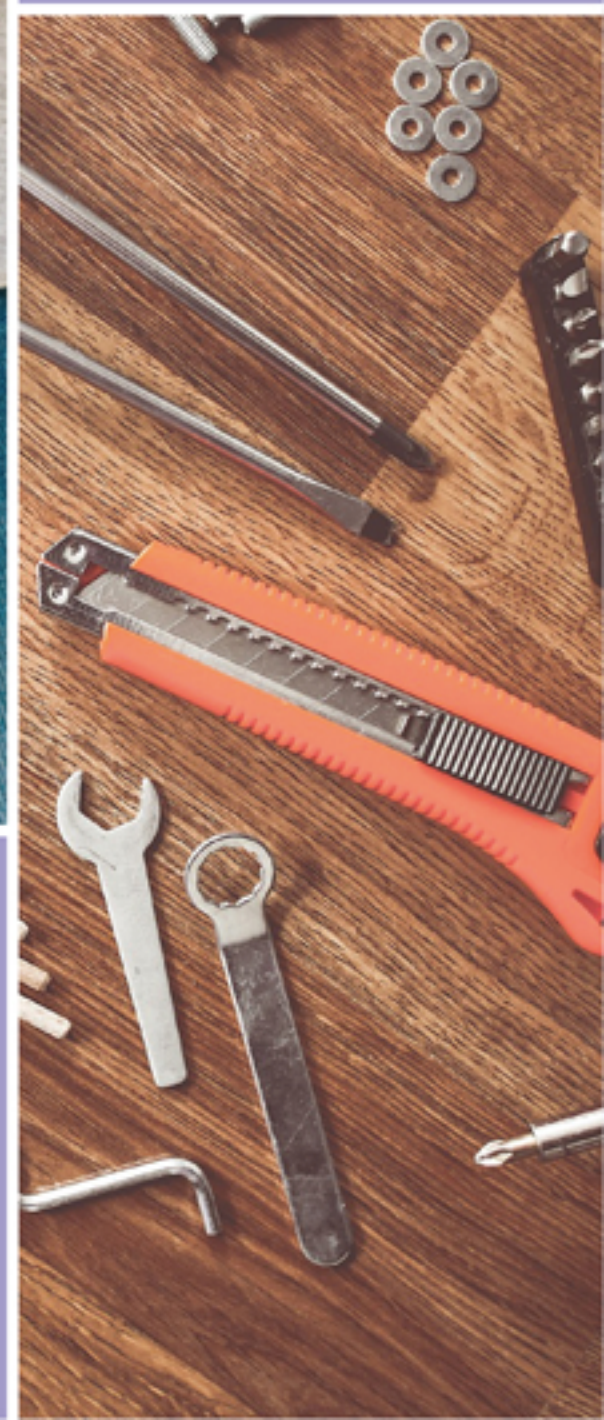
- One Hand Operation
- Cutting Capacity ϕ (mm): 28~67 (1-1/8"~2-5/8")
- Application:
 - Stainless Steel Tube (Wall Thickness \leq 2mm)
 - Copper, Aluminum & Plastic Tube (Wall Thickness \leq 3mm)



**GENERAL
TOOLS**

5042
1/2" Square Drive 4 Piece Stud Extractor Set

- Designed For Hard To Reach Studs.
- Three Internal Rollers Grip The Stud Securely In Either Direction For Quick And Easy Removal And Installation.
- For Stud Sizes 6, 8, 10 And 12mm.
- 1/2" Square Drive.

925U1
25 Pcs Screws Extractor / Drill & Guide Set

- Extracts Screws And Bolts
- Can Be Used On Thread Sizes : 3/16"~9/16" (5~16mm)
- Remove Broken Fastener Without Breaking Or Jamming
- Turns Broken Fasteners And Screws Out And Permits Highest Torque Without Expansion.

672...
4 Pcs Nut Splitter Set

Item no.	size
6720312	3~12mm (1/8"~1/2")
6721216	12~16mm (1/2"~5/8")
6721622	16~22mm (5/8"~7/8")
6722227	22~27mm (7/8"~1-1/16")

- Remove Rusted And Corroded Nuts.
- Chrome Vanadium Steel, Heat-Treated Blades.
- Hardened, Tempered Carbon Steel Handle.
- Chrome Plated For Rust Resistance.
- 4 Most Popular Sizes All-In-One Set.
- Sizes: 1/8"~1/2", 1/2"~5/8", 5/8"~7/8", 7/8"~1-1/16"

150500 & 150650

Powerful Wrecking Bar

150650B

Bent Type Powerful Wrecking Bar



- 150500: 500L(mm)
- 150650: 650L(mm)



- 150650B: 650L(mm)

609250...

Extra Long Spark Plug

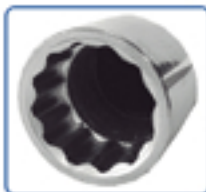

3/8"

Item no.	size
60925014M	14mm
60925016M	16mm
60925021M	20.8mm

623185F & 624225F

Flexible Extension Bar



Item no.	Contents
623185F	- Material: CR-MO
	- Satin Finished
	- Size: 3/8"
624225F	- Length: 185mm
	- Material: CR-MO
	- Satin Finished
	- Size: 1/2"
	- Length: 225mm

4031...

Step Wrench



Item no.	Contents
4031	1/2" Dr. 4 Step Radiator Spud Wrench - Size: 3/8", 1/2", 3/4", 1"
4031A	1/2" Dr. 5 Step Radiator Spud Wrench - Size: 3/8", 7/16", 1/2", 5/8", 13/16"
4031B	1/2" Dr. 7 Step Radiator Spud Wrench - Size: 3/8", 7/16", 1/2", 9/16", 11/16", 3/4", 7/8" (10, 12, 13, 14, 17, 19, 22mm)
4031C	1/2" Dr. 3 Step Radiator Spud Wrench - Size: 10, 13, 17mm
4031D	8-In-1 Slotted Step Wrench - Size: 3/8" (9.35mm), 7/16" (9.75mm), 15/32" (12mm), 1/2" (12.8mm), 35/65" (13.7mm), 3/4" (18.4mm), 27/32" (21.4mm), 7/8" (21.9mm)

71701

Flexible Magnetic Pickup Tool

BEST CHOICE



- 3.5 Lbs w/ Magnet

71702

Flexible Magnetic Pickup Tool
(1.3Lb)



- Flexible Magnetic Pick Up Tool (1.3Lb)
(1) Length:520mm
(2) Magnet Pick Up : 1.3Lb (0.6kg)

71703

24" (600mm)L Claw Pickup Tool



- W/Flexible Shaft
- Package: Lable

71704

28" (700mm)L 4-Jaw Pickup Tool



- Magnetic Tip
- Handle: Aluminum & Anodized Finish
- Flexible Shaft : Spring Steel W/PVC Cover
- 4 Jaw Claw : SK5
- Magnet : Neodymium
- With Laser Logo

799119

Air Blow Gun With High Pressure
Car Vacuum Cleaner Kits



- Function:
 - Quick Change From Blow To Vacuum Function
 - With Four Different Size Vacuum Accessories
 - Fits All jobs, Widely Application
- In Cludes 6 Rugged Attachments:
 - Extension Tubes x 2pcs
 - Shop Brush x 1pc
 - Flat Tube x 1pc
 - Tiny Tube x 1pc
 - Dust Bag x 1pc
- Normal Operating Range Is 100 PSI
- Max Operating Range Is 150 PSI

799125

Metal Air Suction & Blow Gun



- Function:
 - Quick Change From Blow To Vacuum Function
 - Metal Body
- Operating Pressure:90 PSI.
Air Flow At 100 PSI:18 CFM
Air Inlet:1/4"
Vacuum Power:1.2 kg
- Content:
 - Gun x 1pc, Extension Tube x 1pc,
 - Brush Tube x 1pc, Flat Tube x 1pc,
 - Tiny Tube x 1pc, Dust Bag x 1pc,
 - Air Hose x 1pc, Clamp x 2pcs

73005
5 Pcs Screw Extractor Set

- Made Of Chrome Moly Steel.
- Heat Treated.
- Quick & Easy Way To Remove Broken Screws, Pipes, Bolts & Studs.
- Size:
 $1/8'' \sim 1/4''$ (3~6mm), $1/4'' \sim 5/16''$ (6~8mm),
 $5/16'' \sim 7/16''$ (8~11mm), $7/16'' \sim 9/16''$ (11~14mm),
 $9/16'' \sim 3/4''$ (14~18mm)

73006
6 Pcs Screw Extractor Set

- Made Of Chrome Moly Steel
- Heat Treated
- Specification:
 $1/8'' \sim 1/4''$, $1/4'' \sim 5/16''$, $5/16'' \sim 7/16''$,
 $7/16'' \sim 9/16''$, $9/16'' \sim 3/4''$, $3/4'' \sim 1''$

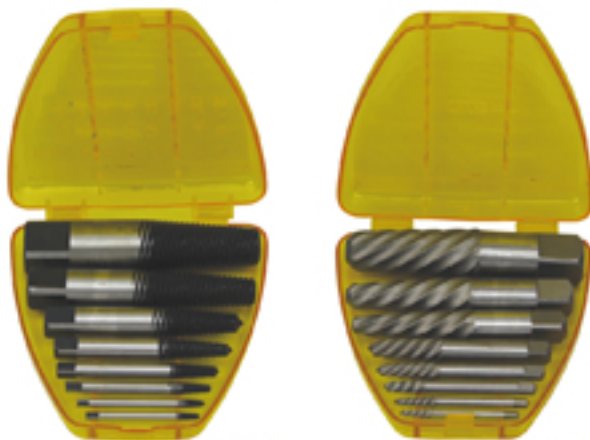
63008A & 63008B
8 Pcs Screw Extractor Set

63008A
63008B

- Material: CR-MO
- Heat Treated
- Size: $1/8''$, $1/4''$, $5/16''$, $7/16''$, $9/16''$, $3/4''$, $1''$, $1-1/8''$

71826
20 Pcs Blades Metric Feeler Gauge

- Size:
0.05, 0.10, 0.15, 0.20, 0.25, 0.30, 0.35, 0.40,
0.45, 0.50, 0.55, 0.60, 0.65, 0.70, 0.75, 0.80,
0.85, 0.90, 0.95, 1.00mm
- Blade:100mm(L)

71802
25 Pcs Blades Metric Feeler Gauge

- Sizes:
0.04, 0.05, 0.06, 0.07, 0.08, 0.09, 0.10, 0.15,
0.20, 0.25, 0.30, 0.35, 0.40, 0.45, 0.50, 0.55, 0.60,
0.65, 0.70, 0.75, 0.80, 0.85, 0.90, 0.95, 1.00mm
- Blade:85mm(L)

71803
26 Pcs Blades Feeler Gauge

- Sizes:
0.04, 0.05, 0.06, 0.08, 0.10, 0.13, 0.15, 0.18, 0.20,
0.23, 0.25, 0.28, 0.30, 0.33, 0.35, 0.38, 0.40, 0.43, 0.45,
0.48, 0.50, 0.53, 0.55, 0.58, 0.60, 0.63mm
- Blade:85mm(L)

717

3 In 1 Telescoping Inspection



- Mirror w/ Magnet Scriber

717D

Telescopic Magnetic Pick Up Tool
1.3LBS (0.5kg)



- Length:127mm~635mm

73701

Funnel W/Flexible Movable Hose

BEST CHOICE



- Material:P.P
- Size: 165 x 165 x 480mm
- Capacity: 1200 c.c

73109

Funnel W/Flexibe Movable Hose



- Material: P.E
- Size: 190 x 190 x 540 mm

78801

Magnetic Car Fender Cover With 4 Pockets



- Size : 1100 x 560mm

78802

40" Creeper Rolling Mechanic Cart

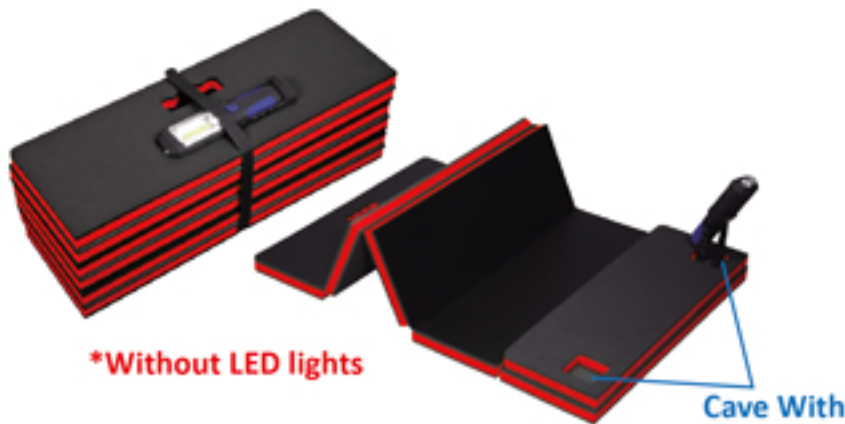

- 6 Durable 3" Rotating Ball Bearing Casters.
- 2 Tool Trays Hold Your Tools And Small Parts.
- Low Profile 1.25" Ground Clearance
- Weight Capacity: 127 kgs (280 pounds)
- Dimensions: (L)1010 x (W)475 x (H)130mm

77803
Foldable Pad

- Ingredients : EVA
- Size: (L)1000 x (W)570 x (H)30mm
- Folded Size: (L)200 x (W)570 x (H)185mm
- N.W. : 1.22kg
- Cave With(2 Slots) Magnet Plate
- Inner Dimension :(L)64 x (W)64 x (H)15mm

*Without LED lights

Cave With

77804
Industrial Riveter Tool

- Aluminum Body, Steel Tube Handle With Rubber Hand Grips
- 4 Nose Piece:
 - 3.2mm(1/8"), 4.0mm(5/32")
 - 4.8mm(3/16"), 6.4mm(1/4")
- Lever Design Reduse Physical Strength For All Rivet Sizes
- Extra Long Handle Provides Excellent Leverage

77805
Scissor Action Industrial Riveter

- Rugged All Steel Construction
- Single Pull Action For Fast Repetitive Applications
- Stretching Design For Use In Difficult Access Area
- Suitable For Industrial And Construction Applications
- 4 Interchangeable Nose Pieces:
 - 2.4mm(3/32"), 3.2mm(1/8"), 4.0mm(5/32"), 4.8mm(3/16")
- Extended Length: 310~835mm Max

77803
101 Pcs Hand Riveter Set

- 1pc Hand Riveter
- Aluminum Body, Drop-Forge Handle
- 4 Nose Piece:
 - 2.4mm(3/32"), 3.2mm(1/8"),
 - 4.0mm(5/32"), 4.8mm(3/16")
- 100 Pcs Rivets
- Plastic Case

77801
360° Degree Swivel Head Riveter

- Application Use W/All Material Rivet
- Material: Diecast Aluminum Alloy
- Jawcase & Jaws W/Heat Treated Alloy Steel
- Use For Rivet Size:
2.4mm(3/32"), 3.2mm(1/8"),
4.0mm(5/32"), 4.8mm(3/16")

77802
Hand Riveter

- Aluminum Body, Chrome Molybdenum Steel Handle
SCM435 Jaws, Carbon Steel Jaw Case And Pin
- 4 Nose Piece:
2.4mm(3/32"), 3.2mm(1/8"),
4.0mm(5/32"), 4.8mm(3/16")

77130
130 Pcs Professional Threaded Coil-Insert Repair Kit

Contents:

- Stainless Steel Screw Coil Inserts:
25pcs M5 x 0.8mm x 1.5D (L=7.5mm)
25pcs M6 x 1.0mm x 1.5D (L=9.0mm)
25pcs M8 x 1.25mm x 1.5D (L=12.0mm)
25pcs M10 x 1.5mm x 1.5D (L=15.0mm)
10pcs M12 x 1.75mm x 1.5D (L=18.0mm)
- Twist Drills:
M5(Ø5.2mm), M6(Ø6.3mm), M8(Ø8.3mm)
M10(Ø10.4mm), M12(Ø12.4mm)
- Thread Taps:
M5 x 0.8mm, M6 x 1.0mm, M8 x 1.25mm,
M10 x 1.5mm, M12 x 1.75mm
- Installation Tools:
M5, M6, M8, M10, M12
- Pin Breaking Tools:
M5, M6, M8, M10, M12

77040
40 Pcs Tap & Die Set

- Tap & Die:
M3 x 0.5, M3 x 0.6, M4 x 0.7, M4 x 0.75, M5 x 0.8,
M5 x 0.9, M6 x 0.75, M6 x 1.0, M7 x 0.75, M7 x 1.0,
M8 x 1.0, M8 x 1.25, M10 x 1.25, M10 x 1.5, M12 x 1.25,
M12 x 1.5, 1/8 NPT-27
- Die Stock Handle: 1" / 25mm O.D.
- Tap Wrench: M3~M12
- Screw Pitch Gauge:
0.5, 0.6, 0.7, 0.75, 0.8, 0.9, 1.0, 1.25, 1.5, 1.75, 27, 28
- Slotted Screwdriver: 0.6 x 3mm, L=93mm
- Blow Case: W300 x D230 x H53mm

77041
51 Pcs Tap & Die Set

- 20pcs Tap :
M6 x 0.75, M6 x 1.0, M8 x 1.0, M8 x 1.25, M10 x 1.25, M10 x 1.5, M2 x 1.5, M12 x 1.75, M14 x 1.5, M14 x 2.0, M16 x 1.5, M16 x 2.0, M18 x 1.5, M18 x 2.5, M20 x 1.5, M20 x 2.5, M22 x 1.5, M22 x 2.5, M24 x 1.5, M24 x 3.0
- 14pcs 1-1/2" OD Dies :
M6 x 0.75, M6 x 1.0, M8 x 1.0, M8 x 1.25, M10 x 1.25, M10 x 1.5, M12 x 1.5, M12 x 1.75, M14 x 1.5, M14 x 2.0, M16 x 1.5, M16 x 2.0, M18 x 1.5, M18 x 2.5
- 6pcs 2" OD Dies :
M20 x 1.5, M20 x 2.5, M22 x 1.5, M22 x 2.5, M24 x 1.5, M24 x 3.0
- 1pc Auto Center Punch
- 1pc "T" Type Tap Wrench
- 1pc Tap Wrench
- 2pcs 2" Diameter Die Stock With(1-1/2")Adapter
- 1pc Screw Driver

77042
16 Pcs Tap & Die Set

- 14pcs Tap :
M3 x 0.5, M4 x 0.7, M5 x 0.8, M6 x 1.0, M8 x 1.25, M10 x 1.5, M12 x 1.75
- 1pc Tap Wrench : M3 - M12
- 1pc Die Stock : 25mm

707...
Bi-Metal Hole Saw

Item no.	Cutting Diameter	inch	Item no.	Cutting Diameter	inch
70714	14 mm	9/16"	70741	41 mm	1-5/8"
70716	16 mm	5/8"	70744	44 mm	1-3/4"
70717	17 mm	11/16"	70751	51 mm	2"
70719	19 mm	3/4"	70754	54 mm	2-1/8"
70720	20 mm	25/32"	70757	57 mm	2-1/4"
70722	22 mm	7/8"	70760	60 mm	2-3/8"
70725	25 mm	1"	70762	62 mm	2-7/16"
70727	27 mm	1-1/16"	70764	64 mm	2-1/2"
70729	29 mm	1-1/8"	70765	65 mm	2-9/16"
70735	35 mm	1-3/8"	70776	76 mm	3"
70737	37 mm	1-7/16"	70789	89 mm	3-1/2"
70738	38 mm	1-1/2"	70792	92 mm	3-5/8"

70702
Arbors For Bi-Metal Hole Saws

- Arbor, 7/16" Hex Shank, Suitable For Hole Saw Size 32(1-1/4")mm~152mm(6")
- W/ 1/4" Drill x 81L
- Material:Carbon Steel
- Finish:Black Oxide

70706
Arbors For Bi-Metal Hole Saws

- Arbor, 3/8" Hex Shank, Suitable For Hole Saw Size 14mm(9/16")~30mm(1-3/16")
- W/ 1/4" Drill x 81L
- Material:Carbon Steel
- Finish:Black Oxide

788...
Jumbo Pry Bar

- 78805: 90 Degree Angle Tip Pry Bar (Wide Face) L: 25"
- 78806: 75 Degree Angle Tip Pry Bar (Narrow Face) L: 25"
- 78807: Straight Pry Bar (Wide Face) L: 36"
- 78809: 30 Degree Angle Tip Pry Bar (Wide Face) L: 36"

78804
4 Pcs Jumbo Pry Bar Set

- Contents:
- 30 Degree Angle Tip Pry Bar - 36" (L)
- 75 Degree Angle Tip Pry Bar - 25" (L)
- 90 Degree Angle Tip Pry Bar - 25" (L)
- Straight Pry Bar - 36" (L)

788...
Mechanic Pry Bar

- Size: 8", 12", 18", 24"

78810
4 Pcs Mechanic Pry Bar Set

- Contents:
- 8", 12", 18", 24" Pry Bar

78502 & 78532 Safety Glasses

CE



- Material: PC/NYLON
- Complies: EN166 EN170 1F CE ANSI Z87+

78521 & 78538 Safety Glasses

CE



- Material: PC/NYLON
- Complies: EN166 EN170 1S CE ANSI Z87+

78548 Safety Glasses

CE



- Material: PC/NYLON
- Complies: EN166 EN1701S CE ANSI Z87+

78002 Ear Muff

CE



- Material: ABS, POM
- Complies : EN352-1 : 2002 CE ANSI S3.19
- SNR : 24dB

78017 Ear Flaps

CE



- Material: ABS, POM
- Complies : EN352-1 : 2002 CE ANSI S3.19
- SNR : 29dB

798501
Continuous Flow Air Grease Gun

- Specification:
- Capacity: 400 c.c.(14 oz.)
- Working Pressure: 3600 psi
- Max. Pressure: 6000 psi
- Outer Cap With Stopper
- W/6.5" (172mm) Metallic Bent Spout

798502
Lever Grease Gun (Heavy Duty Type)

- Specification:
- Capacity: 400 c.c.(14 oz.)
- Working Pressure: 4500 psi (310 Bar)
- Max. Pressure: 10000 psi (690 Bar)
- Variable Stroke
- Outer Cap With Stopper
- W/6.5" (172mm) Metallic Bent Spout

798504
Pistol Grease Gun

- Specification:
- Capacity: 400 c.c.(14 oz.)
- Working Pressure: 4500 psi (310 Bar)
- Max. Pressure: 8000 psi
- Variable Stroke Action
- Outer Cap With Stopper
- W/6.5" (172mm) Straight Rigid Tube

798505
Lever Grease Gun

- Specification:
- Capacity: 400 c.c.(14 oz.)
- Working Pressure: 4500 psi (310 Bar)
- Max. Pressure: 10000 psi
- Inner Cap With Stopper
- W/6.5" (172mm) Rigid Tube

798503
Oil Suction Gun (Jumbo Type)

- Provides A Fast, Clean Method Of Removing An Adding Transmission Oil, Gear Oil, And Vehicle Fluids.
- Specification:
- Capacity: 1000 c.c. (35 oz.)
- W/11" (280mm) Flexible PVC Hose
- W/ 9" (240mm) Metallic Bent Spout

798500
Flexible Nylon Hose-12"

- 12" Long Nylon Material Flexible Hose
- 4 Jaws Standard Coupler
- Working Pressure: 4500 psi
- Max. Pressure: 10000 psi

798400
Aluminum Tube Caulking Gun

- 9" Ladder Putter Steel Frame Caulking Gun
- Standard 300ml / 10oz. Cartridge
- Seamless Die-Cast Aluminum Alloy Tube And Durable Trigger
- Riveted Pressure Plate & Push Rod
- Quick Release Thumb Lever
- Thrust Ratio: 13:1
- Ideal For Latex, Silicone, Adhesives, Sealant, Rubber Compound & Polyurethanes

798401
Caulking Gun

- 9" Ladder Putter Steel Frame Caulking Gun
- Standard 300ml / 10oz. Cartridge
- Hardened And Zinc-Coated Piston Round Steel Rod
- Riveted Pressure Plate & Push Rod
- Durable Die-Cast Aluminum Alloy Handle And Trigger
- Quick Release Thumb Lever
- Built-In Seal Puncture Tool
- Thrust Ratio: 10:1
- Ideal For Latex, Silicone, Adhesives, Sealant, Rubber Compound & Polyurethanes

798402
Revolving Barrel Caulking Gun

- 9" Ladder Putter Steel Frame Caulking Gun
- Standard 300ml / 10oz. Cartridge
- Easy Load, Revolving Open Barrel
- Hardened And Zinc-Coated Piston Round Steel Rod
- Durable Die-Cast Aluminum Alloy Handle And Trigger
- Quick Release Thumb Lever
- Thrust Ratio: 13:1
- Ideal For Latex, Silicone, Adhesives, Sealant, Rubber Compound & Polyurethanes

1049
Spray Gun

- Optional Nozzle Size:
 ϕ 1.5mm, ϕ 2.5mm
- Fully Adjustable Wide Fan Pattern Control
- Stainless Steel Nozzle And Needle
- Suitable For Medium To Large Size Work
- Pressure Type Available

Technical Data	
Fluid Tip Size (I.D.)mm	ϕ 2.0mm
Air Pressure KG/cm ² (PSI)	3.5(50)
Air Inlet	1/4"
Fluid Inlet	3/8"
Air Consumption L/Min (CFM)	250(8.8)
Weight (Kg)	0.95
Capacity Of Cup (L)	1.0
Type	Suction

D450
Powder Actuated Tool

Can Be Matched:
D450C07 - Piston

Applications:

- Wood And Metal To Concrete Or Steel, Electrical
- Installations(Switch Boxes)
- Clips, Clamps And Rings For Electric Cables, Conduits And Pipes
- Mouldings, Brackets, Sections Etc.
- General And Special Contractors
- Plant Maintenance
- Woodworking, Electrical Installation
- Mechanical Installation (Plumbing, Heating And Air Conditioning)
- Interior Finishing
- Plastering

710...
Steel Bench Vise

Item no.	size	Jaw Opening	Throat Depth	N.W	G.W	CUFT	PCS/CTN
710203	3"	3"	2"	6.00	6.50	0.35	1
710204	4"	4"	2-1/4"	7.25	7.90	0.38	1
710205	5"	5"	2-5/8"	10.20	11.00	0.55	1
710206	6"	6"	3"	14.00	15.00	0.77	1
710207	7"	7"	3"	14.8	16.3	0.87	1
710208	8"	8"	3-1/2"	18.00	19.50	1.10	1
710210	10"	10"	4"	24.00	25.80	1.66	1
710212	12"	12"	5"	32.20	34.50	2.46	1

Description:

- 10 Years Warranty
- 360° Swivel Base
- Made Of SC37 Cast Carbon Steel
- Equipped With Anvil And Pipe Jaw
- Hardness Of Vise Jaw HRC 25~ 30
- Finished With Wrinkle Paint

1033M5

Measuring Tape



- Size: 5M

796150

Stainless Steel Vernier Caliper

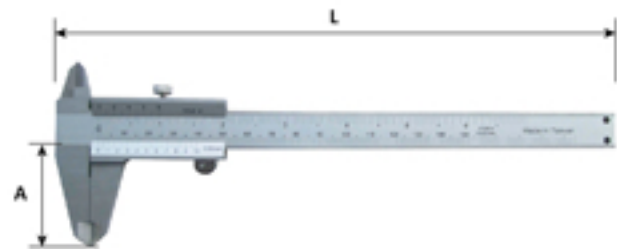

- Stainless Steel
- Plastic Case
- Polish Finished
- 0.05mm-0.001 in Or 0.02mm-01/128"
- Measuring Range: 0~150mm
- A: 40mm
- L: 235mm

1055B

Utility Knife



- Material: High Carbon Steel
- With 6 Blades Of

790...

Magnetic Trays



- 790150 Size: $\varnothing 150 \times H42\text{mm}$
- 790240 Size: $L240 \times W140 \times H42\text{mm}$
- 790360 Size: $L360 \times W160 \times H42\text{mm}$

790218

Brake Calliper Brush



- 2 Rows Of Rustproof Stainless Wire
- Bristle Length: 18mm
- Length: 215mm

790318

3 Row Stainless Steel Wire
Scratch Brush



- Fill Pattern: 3 Rows Of 14
- Bristle Length: 18mm
- Length: 235mm

70394B

394 Pcs Rubber O-Ring Assortment Kit



- Metric O-Ring Sizes: (I.D. x Thickness)

- 3 x 1 (36pcs), 4 x 1 (17pcs), 5 x 2 (9pcs), 6 x 2 (17pcs),
- 8 x 2 (17pcs), 10 x 2 (17pcs), 11 x 2 (17pcs), 12 x 2 (17pcs),
- 14 x 2 (17pcs), 17 x 2 (17pcs), 20 x 2 (17pcs), 10 x 3 (11pcs),
- 12 x 3 (11pcs), 16 x 3 (11pcs), 18 x 3 (11pcs), 22 x 3 (11pcs),
- 20 x 4 (9pcs), 22 x 4 (9pcs), 24 x 4 (9pcs), 25 x 4 (9pcs),
- 30 x 4 (9pcs), 34 x 4 (9pcs), 36 x 4 (9pcs), 40 x 4 (9pcs),
- 45 x 4 (9pcs), 47 x 4 (9pcs), 50 x 4 (9pcs), 16 x 5 (7pcs),
- 25 x 5 (14pcs), 30 x 5 (7pcs), 32 x 5 (7pcs), 35 x 5 (7pcs)

78811

Flashlight



- Specifications:

- Mode: R30
- LED: NICHIA-17A
- Lm: 60 LM (MAX)
- Ansi FL1 : 55 LM (30 Seconds Average/3pcs)
- Power : 0.5 Watt /Output +-10%
- Material: Aluminum Alloy Case
- Lite: PC Optical Lens Produces ,
- Beam Slide Focus Adjustable
- Runtime : Max ~ 5LM 17.5 Hours
- Ansi FL1 : 17.0 Hr (FL1 LM~10% LM Average/3pcs)
- Size: L89.0mm x Ø20.0mm x 20.0mm
- Battery: 1AA
- Switch: Cap Push Button > ON /OFF
- Weight: 36g (Without Batteries)
- Waterproof (IPX6) And Shockproof Design



99504

Safety Tool Lanyard - 10kgs



- Reflective Yarn
- Twist Locking Stainless Carabiner
- High Strength Nylon Webbing
- Standard 31.5"~55"(80cm~140cm)
- Maximum Tool Weight:22 LBS(10 kg)
- Adjustable Rope Lock For Tool Attachment
- Triple Stitching At Both Ends For Extra Security

99503

Safety Tool Lanyard - 3kgs



- 3kgs Maximum Tool Weight
- Fully Extended Length 64~200cm
- Double Swivel Zinc Alloy Hooks
- High Strength 1.2mm Stainless Steel Wire Core
- PU Outer Coating

99505
Safety Tool Lanyard - 5kgs

- 5kgs Maximum Tool Weight
- Fully Extended Length 80~140cm
- Double Swivel Zinc Alloy Hooks
- High Strength Webbing And Elastic Inner Core
- High Tenacity Nylon

99501
Safety Tool Lanyard Accessory

99502
Flexible Extension Bit Holder

- Length 300mm
- Connector: 1/4"

917010
External & Internal Restorer Files (Metric)

- Material: 6140
- Heat Treatment: HRC 42~46
- Surface: Yellow Zinc Plated
- Pitch Size:
Metric 0.80, 1.00, 1.25, 1.50, 1.75, 2.00, 2.50, 3.00
- Restore Tool For Renewing Damaged Thread On Any Diameter Bolt, Stud, Axle Or Shaft File Both Right And Left Hand Threads.
- Design Use In Hide & Narrow Area.

99601 & 99602
Tool Holster

99601
- Size: 210 x 125 x 55mm



99602
- Size: 270 x 265 x 155mm
- Metal Holster For Hammers And Tapes

99603
Belt For Heavy Duties

- Size: 340 x 865mm
- Specification:
1pc Multifunction Lumbar Belt 140 x 865mm
1pc Tool Holster 290 x 170 x 85mm
1pc Holster For Tools And Nails
1pc Hanger For Hammer
1pc Holster For Mobile
- Protect Your Back From Lumbar Overloads

9630...
Steel Types Kit

Kit Includes:

- Type Hoder-One PC
- Hexagon Wrenche-One PC
- Steel Types x 100 Pcs :
 - 52 Individual Pcs Of Type Letters A Thru Z)
 - 36 Individual Pcs Of Numbers 0 Thru 8
 - (Four Each 0~8, The 6 Is Used As 9)
 - One "&", Two Slash"/", Two dash"-", And Six Blank Spaces)
- Each Set Packed In A ABS Red Strong Plastic Case.
- HRC 58~60 Degrees.
- The Holder Can Accomodate 9 Pieces Of Steel Types.

Item no.	Size	PCS/CTN
963001	3mm(1/8")	12
963002	5mm(3/16")	12
963003	6mm(1/4")	12

9632...
27 Pcs German Letter Steel Stamps

Item no.	Size	PCS/CTN
963215	1.5mm(1/16")	50
963202	2mm(5/64")	50
963225	2.5mm(3/32")	50
963203	3mm(1/8")	50
963204S	4mm(5/32")	50
963204	4mm(5/32")	30
963205	5mm(3/16")	30

Item no.	Size	PCS/CTN
963206S	6mm(1/4")	30
963206	6mm(1/4")	20
963207	7mm(9/32")	10
963208S	8mm(5/16")	10
963208	8mm(5/16")	10
963210	10mm(3/8")	10
963212	12mm(1/2")	5

- 27 Pcs/ Set (A to Z, Plus Ampersand "&")
- Each Set Packed In A Red Plastic Case
- Front End HRC 58 - 62, Tail End Tempering HRC 38~46 Degrees.
- For Hand-Held, Hammer-Struck And/Or Machine Applications.
- Each Stamp Is Marked With The mm/ Inch Sizes On The Stamp's Body Side.
- Each Stamp Is Cut-Head Sided.
- Material:CRV(6150)
- Meet The Requirements Of German Standard DIN 1451 DIN 7353

963...
9 Pcs German Number Steel Stamps

Item no.	Size	PCS/CTN
963015	1.5mm(1/16")	120
963020	2mm(5/64")	120
963025	2.5mm(3/32")	120
963030	3mm(1/8")	120
963040S	4mm(5/32")	120
963040	4mm(5/32")	80
963050	5mm(3/16")	80

Item no.	Size	PCS/CTN
963060S	6mm(1/4")	80
963060	6mm(1/4")	60
963070	7mm(9/32")	30
963080S	8mm(5/16")	30
963080	8mm(5/16")	30
963100	10mm(3/8")	30
963120	12mm(1/2")	15

- 9 Pcs/ Set (0~8 (The 6 Is Used As 9))
- Each Set Packed In A Red Plastic Case
- Front End HRC 58 - 62, Tail End Tempering HRC 38~46 Degrees.
- For Hand-Held, Hammer-Struck And/Or Machine Applications.
- Each Stamp Is Marked With The mm/ Inch Sizes On The Stamp's Body Side.
- Each Stamp Is Cut-Head Sided.
- Material:CRV(6150)
- Meet The Requirements Of German Standard DIN 1451 DIN 7353

GARDEN & CONSTRUCTION

SELTA

63301
Heavy-Duty Hack Saw

- Blade Tension Up To 40,000 PSI
- Bi-Metal Saw Blade
- Blade Length:12"
- Blade Can Be Position For A 45° Or 90° Cut



63301P - 12" Bi-metal High Speed Steel
24 Teeth Saw Blade

63302
Professional Mini Hack Saw

- Delivered With 1 Blade(24T)
- Overall Length:270mm
- Blade Length:150mm
- Max Cutting Height:67mm

823115
Extension Clamp

- A Unique Feature That Jaws Can Be Easily Slided Outward And Extend It's Clamping Capacity Up To 150mm/6"
- Patent Design Locking Mechanism Allows Jaws To Lock By Itself Without Any Trigger
- Maximum Clamping Force:30kgs/66lbs

824...
Bar/Spread Clamp

Specification:

- Type:F-Clamp

Key Features:

- Strengthen Carbon Steel Bar. Nylon Main Body With TPR Handles And Grip Pads
- Jaw Depth Of 85mm. Maximum Clamping Force Up To 150kgs / 330lbs
- Options Of Non-TPR Handle For Economical Choice. Please Refer To The Demonstration Picture
- Patented In U.S.A., Germany And Taiwan

Item no.	Weight(g)	Lenght(mm)	Jaw(mm)	C(mm)	Size(mm)	QTY	Carton(cm)	N.W.	G.W.	Cuft
824006	586	320	85	150	165-350	20	38 x 23 x 36	21.1	12.8	1.13
824012	700	520	85	300	165-500	12	53 x 23 x 22	8.4	9.0	0.94
824018	790	675	85	450	165-650	12	68 x 23 x 22	6.5	10.1	1.21

GT2233 26"~34"(L) Telescopic Wavy Blade Hedge



- 10"(L), S50C Non-Stick Coated Upper Blade
- 10"(L), S50C Satin Finish Lower Blade
- Oval Tubular Telescopic Steel Handles (375C Enameled Finish)
- Non-Slip Cushion Soft Grips
- L-Type Absorb(Black Color)
- 5 Star Type Adjust Tuner(Orange Color)
- Precision Ground Blade

GT2304 9"(L) Heavy Duty Wood Handle Hedge Shears



- Blade: S50C Carbon Steel 9"(L) x 4mm(T)
- Upper Blade W/Teeth, Semicircle & Hardened Chrome Plated
- Lower Blade W/Teflon Coated w/o Stick
- Star Type Adjust Tuner
- L-Type Absorb
- American Rubber Wooden Handle W/PVC

GT2358 19-1/2"(L) Straight Blade Hedge Shears



- Blade Size: 8"(L) x 3.2mm(T)
- Material: S50C
- Finish: Polish w/Black Electronic Plated
- Heat Treated Finish
- W/200mm(L) Rubber Wood Grip

GT2739 8-1/2"(L) Heavy Duty Bypass Pruning Shears



- Aluminum Alloy Steel Handle w/PVC Dipping Grip
- Specifications:
 - Upper Blade: High Carbon SK-5 Steel, Non-Stick PTFE Coated Blade
 - Lower Blade: Middle Carbon S50C Steel, Serrated Blade W/Hard Chrome Plated
- Heat Treated Blade

GT0729 8"(L) Hi-Deluxe Bypass Pruning Shears



- Aluminum Alloy Steel Handle w/PVC Dipping Grip
- Specifications:
 - Upper & Lower Blade: Middle Carbon S50C Steel, Polished Finish
- Heat Treated Blade

GT2031 18"(L) Straight Blade Hedge Shears



- Blade: S50C Carbon Steel 8"(L) x 4mm(T)
- Hard Chrome Plated Blade
- 5 star Type Adjust Tuner (Black Order)
- L-Type Absorb (Black Color)

GT0720
3 Position One Hand Grass Shears

- 13-1/2"(L) Grass Shear
- Upper & Lower Blade: Middle Carbon S50C Steel, Black Finished
- Metal Handle With PVC Coating

GT0820
8-1/4"(L) Hi-Deluxe Bypass Secateur

- Upper Blade: High Carbon SK-5 Steel, w/o Stick PTFE Coated Blade
- Lower Blade: High Carbon 50C Steel w/Hard Chrome Plated

GT7021
8" Ratchet Pruning Shears

- Aluminum Alloy Steel Handle w/Soft TPR Grip
- Upper Blade: High Carbon SK-5 Steel, w/Stick Teflon Coated Blade
- Aluminum Alloy Anvil
- Heat Treated Blade
- Protective Arch In The Lower Handle Safeguards Fingers From Harm When Pruning
- 3 Short Cuts To Easy Pruning
- Effort Saving Ratchet System

GT1168
6 Pattern Water Spray

- Rotating Header 6 Dial Water Pattern Selection Between: Shower, Jet, Cone, Flat, Mist And Soaker.
- On/Off Trigger Can Be Locked To On-Position If Needed.
- Fitted With Quick-Connector Adaptor.

GT9108
6 Pattern Heavy Duty Water Spray Gun

- Rotating Header 6 Dial Water Pattern Selection Between: Shower, Jet, Cone, Flat, Mist And Soaker
- Zinc Body With A Chrome Plated Finish
- On/Off Trigger Can Be Locked To On-Position If Needed
- Fitted With Male Quick-Fit Adaptor For Easy Attachment To Hoses

GT5510 Adjustable Single Nozzle Hose Spray End



- Material: ABS + PP
- Length: 5"
- Handy Nozzle Jet Attachment For Any Hosepipe Simply By Twisting The Nozzle
- Fitted With Male Quick-Fit Adaptor For Easy Attachment To Hoses

GT5870 1/2" & 3/4" Dr. Screw-On Hosepipe Tap Connector



- Material: ABS
- 3/4" Female Tap Adaptor + 1/2" Female x 3/4" Male Reducer

GT5590 3/4" Dr. Male Screw In Adapter



- Material: ABS
- Individual Male Screw-on Hosepipe Connector
- 3/4" BSP Screw Fitting

GT5560 1/2" Dr. Double Female Hosepipe Mender & Joiner



- Material: ABS + PP
- Easily Join Two Hoses Together With This Female Adaptor
- Hose Is Secured Inside Adaptor With Outer Ring Clamps In Place
- Creates A Good Water-Tight Seal In Hose-Pipes
- No Additional Fittings Are Required

GT5520 1/2" Dr. Female Quick Fit Hosepipe Connector



- Material: ABS & PP
- Fitted With Hose Protector To Protect Hose If Being Pulled At An Angle.

GT5521 1/2" Dr. Female Quick Fit Hosepipe Connector (W/Stop)



- Material: ABS & PP
- Fitted With Hose Protector To Protect Hose If Being Pulled At An Angle.
- w/Water-Stop Connector Suitable For Use On Outlet-End Of Hose To Stop Water When Accessories Are Detached From Hose

GT3240
One Way Double Male Hose Connector

- Material: ABS
- Easily Join Two Hoses Together With This Male Adaptor.
- Slots Inside Each Piece Of Hose.
- Fitted With Rubber Seals To Make A Watertight Seal.

GT3335
Mixer Tap Hosepipe Connector

- Material: ABS
- Compcat Washer
- Hose Clamp

GT3370
3/4" Dr. Jubilee Type Tap Connector

- Material: ABS / PP / TPR & Metal Hose Clamp
- Suitable For Use On 3/4" Dr. Round Taps
- The Connector Which Creates A Watertight Seal Around The Hose When Turned Clockwise.
- Connects All 1/2" Garden Hose Pipes
- Length: 86mm
- Diameter: 38mm

GT0040
HI-Deluxe 4-Way Distributor E/FLOW Control Function

- Material: ABS + PP
- Input Connector: 3/4"~1/2" & 1"~3/4"
- Output Connector: 4pcs Tape Adaptor
- Switch Can Be Control Flow Rate

GT5311
3/4" Dr. 2-Way Hose Connector W/Shut-Off Valve

- Material: ABS + POM
- Lets You Attach Two Hose Pipes To One Tap
- Handy Dual Tap Splitter For Screwing Into Taps
- With Two Quick-Fix Outlet Letting You To Easily Push-On Hose Attachments
- Each Outlet Has Shut-Off Valve
- Compatible With Other Quick-Fit Leading Brands

G2341A
8L Gardening Pressure Sprayer
BEST CHOICE

Description:

- Fill Liquid To The Desired Volume As Marked On The Bottle. Be Sure Not To Exceed The Maximum Level Of The Sprayer And Must Leave Sufficient Air Space In Bottle For Pressurization.
- Hold Carry Handle And Pump About 25 Times. Operate The On/Off Trigger By Depressing The Lever, So Water Will Be Sprayed From The Nozzle.
- Turn Nozzle To Adjust Spray Pattern
- Volume: 8L

G2342A
16L Manual Backpack Sprayer
BEST CHOICE

Feature:

- Plastic Water Tank That Pesticides Resistant.
- Pesticides Resistant Seal Cup That Long Life.
- Carry Comfortable Designed.
- Good Application For Insect Pest Control For Garden, Agriculture Industry, Disinfecting.

Specifications:

- Material Of Tank Body : PE / HDPE
- Spray Rod : Stainless Steel Pipe 680mm
- Pump Type : Single Piston Pump Manual Forced
- Capacity Of Water Tank : Single Piston Pump Manual Force
- Operation Pressure : 1 kgf/cm² ~ 5kgf/cm²
- Size :L400 x W150 x H580mm
- Capacity Of Water Tank : 16L
- Weight : 2.9 KGS

981070
Laser Distance Meter

 0.05m
~
80m

CE FC

**Extendable Pintail
For Corner Measuring**
Specification:

Measuring Range	0.05m~80m
Resolution	0.001m
Accuracy	±1.5mm
Measuring Speed	0.5s
Laser Type	650nm, Class 2, < 1mW
Beam Size	25mm @ 30m
Battery	2 x 1.5v Batteries
Battery Life	Up To 10,000 measures
Dimension	114mm x 47mm x 32mm
Operation Temperature	-5°C~40°C
Storage Temperature	-20°C~60°C
Automatic Power-Off	Laser: 30s Device: 180s



HYDRAULIC SERIES

772003
2 Ton Capacity Trolley Jack With 1 Pair Jack Stands

- N.W.: 11.9 KGS G.W.: 12.4 KGS



- Heavy-Duty Steel Construction Provides Stability And Endurance
- Built-In Safety Valve Protects Against Jack Over-Loading
- Swivel Saddle And Rear Casters Provide Smooth Maneuvering And Positioning
- Hydraulic Oil Bypass System Protect Arm From Being Over-Extended
- Carry Handle For Convenient Transportation

Item no.	Capacity	Min Height	Max Height	Product Size(mm)	Package Size(mm)
772003	2Ton	130mm	330mm	440 x 195 x 140	480 x 235 x 155
	2Ton	272mm	360mm	280 x 120 x 120	297 x 130 x 130

772001
2 Ton Capacity Trolley Jack (W BMC)

- N.W.: 8.5 KGS G.W.: 8.8 KGS to 9.5 KGS



- Heavy-Duty Steel Construction Provides Stability And Endurance
- Built-In Safety Valve Protects Against Jack Over-Loading
- Swivel Saddle And Rear Casters Provide Smooth Maneuvering And Positioning
- Hydraulic Oil Bypass System Protect Arm From Being Over-Extended
- Carry Handle For Convenient Transportation

Item no.	Capacity	Min Height	Max Height	Product Size(mm)	Package Size(mm)
772001	2Ton	130mm	330mm	440 x 195 x 140	480 x 235 x 155

772501
2.5 Ton Capacity Trolley Jack

- N.W.: 32.2 KGS G.W.: 34.2 KGS

Extra low profile design

- Heavy-Duty Steel Construction Provides Stability And Endurance
- Built-In Safety Valve Protects Against Jack Over-Loading
- Swivel Saddle And Rear Casters Provide Smooth Maneuvering And Positioning
- Hydraulic Oil Bypass System Protect Arm From Being Over-Extended

Item no.	Capacity	Min Height	Max Height	Product Size(mm)	Package Size(mm)
772501	2½Ton	72mm	505mm	740 x 360 x 150	780 x 385 x 165

 - Double Pump, Quick Lift Design
 Raises To The Top In 8 Pumps

773001
3 Ton Capacity Trolley Jack

- N.W.: 31 KGS G.W.: 33 KGS

High profile design

- Heavy-Duty Steel Construction Provides Stability And Endurance
- Built-In Safety Valve Protects Against Jack Over-Loading
- Swivel Saddle And Rear Casters Provide Smooth Maneuvering And Positioning
- Hydraulic Oil Bypass System Protect Arm From Being Over-Extended



- Double Pump, Quick Lift Design Raises To The Top In 8 Pumps

Item no.	Capacity	Min Height	Max Height	Product Size(mm)	Package Size(mm)
773001	3Ton	150mm	465mm	680 x 344 x 155	720 x 370 x 185

773501
3.5 Ton Capacity Trolley Jack

- N.W.: 45.3 KGS G.W.: 47.2 KGS

Extra low profile design

- Heavy-Duty Steel Construction Provides Stability And Endurance
- Built-In Safety Valve Protects Against Jack Over-Loading
- Swivel Saddle And Rear Casters Provide Smooth Maneuvering And Positioning
- Hydraulic Oil Bypass System Protect Arm From Being Over-Extended

Item no.	Capacity	Min Height	Max Height	Product Size(mm)	Package Size(mm)
773501	3.5Ton	95mm	552mm	790 x 355 x 180	835 x 380 x 210

772002
2 Ton Portable Jack Stands - Pair

- N.W.: 3.4 KGS G.W.: 3.6 KGS



- The Jack Stands Have Sliding Action Legs For Easy Storage
- Folding Axle Stands
- 3 Foot Rest With Braces Screwed Together Ensures Stability When In Use

Item no.	Capacity	Min Height	Max Height	Product Size(mm)	Package Size(mm)
772002	2Ton	272mm	360mm	280 x 120 x 120	297 x 130 x 130

68106
70L Venturi System Oil Extractor

- Waste Oil Mobile Reservoirs To Be Used For Motor And Gear Oil Collection
- Drainers Can Be Used Under Vehicle Lifts Of Inside Lubrication Pit.
- Large Handle For Easy Maneuverability.
- Two Brake Wheels (Ø3") And Two Casters (Ø3").
- Extra Large drain Bowl / Adjustable Collecting Bowl / For The Convenient And Safe Collection.
- Venturi Design

Item no.	Dimension	Capacity	Weight	Power	Oil Draining
68106	600 x 600 x 1390mm	Chamber: 10L Tank: 60L	28.84kgs	Air	Air Pressure

68105
9.5L Transmission Filling System

- 1 SETS/CTN N.W.: 3.5KGS G.W.: 4.11KGS CUFT: 1.22'



- Transmission Filling System
- AT-101-Size:1/8" x 27N For: FORD
- AT-102-Size:UNIVERSAL For:BMW, HONDA, NISAN, ETC
- AT-103-For: VW/AUDI
- AT-104-For:VW/AUDI, PORSCHE
- AT-105-Size:M10x1.0P For:VW/AUDI, MINI COOPER
- AT-106-Size:M12x1.5P For: MERCEDES 722.9
- AT-107-Size:M24x1.5P For: DSG (ex:VW/AUDI)/CVT
- AT-108-Size:M22x1.5P For:VW/AUDI CVT



GIFTS & ACCESSORIES

- Retailer Promotion -

- Retailer Promotion -

PM-000 Cap



PM-001 T-shirt



Item no.	size
PM-001L	L
PM-001XL	XL
PM-0012XL	2XL

PM-002 Gloves



PM-003 Shopping Bag



PM-004 Tattoo Sticker



PM-005 Note



PM-006 Ball Pen



PM-007 Ashtray



PM-008 Key Chain



RS... Rail Steel For Socket



HG-001 Plastic Hanger For Socket

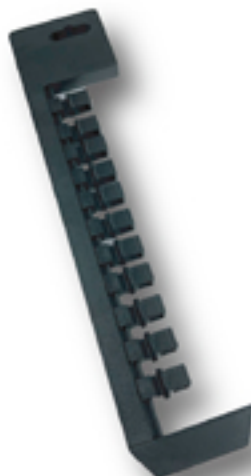

Item no.	size	pcs	L(mm)
RS-46160	1/2	6	160
RS-211170	1/4	11	170
RS-46193	1/2	6	193
RS-47193	1/2	7	193
RS-212200	1/4	12	200
RS-48200	1/2	8	200
RS-47210	1/2	7	210
RS-48230	1/2	8	230
RS-49240	1/2	9	240
RS-310260	3/8	10	260
RS-311260	3/8	11	260

Item no.	size	pcs	L(mm)
RS-49260	1/2	9	263
RS-313280	3/8	13	283
RS-410280	1/2	10	280
RS-234545290 (3 in 1)	1/4	5	290
	3/8	4	290
	1/2	5	290
RS-412340	1/2	12	340
RS-216430	1/4	16	430
RS-316430	3/8	16	430

Medium Duty Pegboard

※ Different Styles Can Be Applied Upon Requests

10800
Medium Duty Pegboard



- Size(W) x (D) x (H):
945 x 450 x 2100mm

10801

Slot-In Logo Panel



- Size(W) x (H): 915 x 300mm



10802

Poster Logo Panel



- Size(W) x (H): 915 x 300mm



10803

Arc Sytle Logo Panel



- Size(W) x (D) x (H):
945 x 220 x 210mm



10804

Logo Light Box

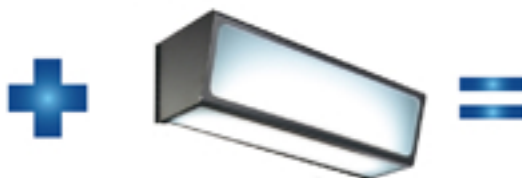

- Size(W) x (D) x (H):
900 x 270 x 250mm



10805

Medium Duty Pegboard



- Size(W) x (D) x (H):
1200 x 460 x 2200mm

H108...

Pegboard Double Hook



- Size:
H10805: L 50mm
H10806: L 100mm
H10807: L 150mm
H10808: L 200mm

H108...

Pegboard Single Hook



- Size:
H10809: L 50mm
H10810: L 100mm
H10811: L 150mm
H10812: L 200mm

H10813

Pegboard Single Hook With Price Tag



- Size:
L:150mm

Flexible / Removable

H10814 & H10815

Acrylic Front Stopper & Medium Duty Shelf

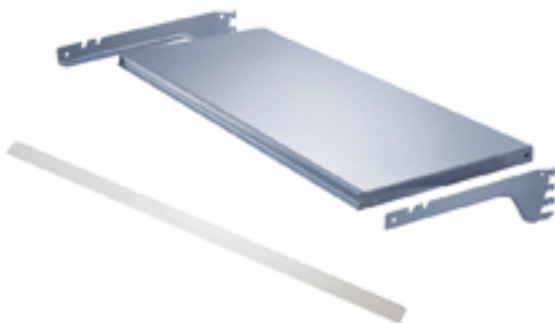

- Acrylic Front Stopper Size(W) x (H):945 x 28mm
- Medium Duty Shelf Size(W) x (D) x (H):945 x 450 x 30mm

HG-00... & HG-007

Socket Tag & Long Tag

HG-002~006

- Socket Tag Size:

Item no.	Size
HG-002	1/4"
HG-003	3/8"
HG-004	1/2"
HG-005	3/4"
HG-006	1"

HG-007



0039



SELTA International Co., Ltd.

-  NO.1-2, Bade Ln., Minsheng Rd., Wufong Dist., Taichung City 41347, Taiwan (R.O.C)
-  seltataiwan@gmail.com
-  +886-4-2332 7566
-  +886-4-2332 7588